

## Chapter 1 - Section A - Mathcad Solutions

1.4 The equation that relates deg F to deg C is:  $t(F) = 1.8 t(C) + 32$ . Solve this equation by setting  $t(F) = t(C)$ .

Guess solution:  $t := 0$

Given  $t = 1.8t + 32$  Find(t) = -40 Ans.

1.5 By definition:  $P = \frac{F}{A}$   $F = \text{mass} \cdot g$  Note: Pressures are in gauge pressure.

$P := 3000\text{bar}$   $D := 4\text{mm}$   $A := \frac{\pi}{4} \cdot D^2$   $A = 12.566\text{mm}^2$

$F := P \cdot A$   $g = 9.807 \frac{\text{m}}{\text{s}^2}$   $\text{mass} := \frac{F}{g}$   $\text{mass} = 384.4\text{kg}$  Ans.

1.6 By definition:  $P = \frac{F}{A}$   $F = \text{mass} \cdot g$

$P := 3000\text{atm}$   $D := 0.17\text{in}$   $A := \frac{\pi}{4} \cdot D^2$   $A = 0.023\text{in}^2$

$F := P \cdot A$   $g = 32.174 \frac{\text{ft}}{\text{sec}^2}$   $\text{mass} := \frac{F}{g}$   $\text{mass} = 1000.7\text{lb}_m$  Ans.

1.7  $P_{\text{abs}} = \rho \cdot g \cdot h + P_{\text{atm}}$

$\rho := 13.535 \cdot \frac{\text{gm}}{\text{cm}^3}$   $g := 9.832 \cdot \frac{\text{m}}{\text{s}^2}$   $h := 56.38\text{cm}$

$P_{\text{atm}} := 101.78\text{kPa}$   $P_{\text{abs}} := \rho \cdot g \cdot h + P_{\text{atm}}$   $P_{\text{abs}} = 176.808\text{kPa}$  Ans.

1.8  $\rho := 13.535 \cdot \frac{\text{gm}}{\text{cm}^3}$   $g := 32.243 \cdot \frac{\text{ft}}{\text{s}^2}$   $h := 25.62\text{in}$

$P_{\text{atm}} := 29.86\text{in}_\text{Hg}$   $P_{\text{abs}} := \rho \cdot g \cdot h + P_{\text{atm}}$   $P_{\text{abs}} = 27.22\text{psia}$  Ans.

1.10 Assume the following:  $\rho := 13.5 \frac{\text{gm}}{\text{cm}^3}$   $g := 9.8 \frac{\text{m}}{\text{s}^2}$

$P := 400\text{bar}$   $h := \frac{P}{\rho \cdot g}$   $h = 302.3 \text{ m}$  Ans.

1.11 The force on a spring is described by:  $F = K_s x$  where  $K_s$  is the spring constant. First calculate  $K$  based on the earth measurement then  $g_{\text{Mars}}$  based on spring measurement on Mars.  
On Earth:

$F = \text{mass} \cdot g = K \cdot x$   $\text{mass} := 0.40\text{kg}$   $g := 9.81 \frac{\text{m}}{\text{s}^2}$   $x := 1.08\text{cm}$

$F := \text{mass} \cdot g$   $F = 3.924\text{N}$   $K_s := \frac{F}{x}$   $K_s = 363.333 \frac{\text{N}}{\text{m}}$

On Mars:

$x := 0.40\text{cm}$   $F_{\text{Mars}} := K \cdot x$   $F_{\text{Mars}} = 4 \times 10^{-3} \text{ mK}$

$g_{\text{Mars}} := \frac{F_{\text{Mars}}}{\text{mass}}$   $g_{\text{Mars}} = 0.01 \frac{\text{mK}}{\text{kg}}$  Ans.

1.12 Given:  $\frac{d}{dz} P = -\rho \cdot g$  and:  $\rho = \frac{M \cdot P}{R \cdot T}$  Substituting:  $\frac{d}{dz} P = -\frac{M \cdot P}{R \cdot T} \cdot g$

Separating variables and integrating:  $\int_{P_{\text{sea}}}^{P_{\text{Denver}}} \frac{1}{P} dP = \int_0^{z_{\text{Denver}}} -\left(\frac{M \cdot g}{R \cdot T}\right) dz$

After integrating:  $\ln\left(\frac{P_{\text{Denver}}}{P_{\text{sea}}}\right) = \frac{-M \cdot g}{R \cdot T} \cdot z_{\text{Denver}}$

Taking the exponential of both sides and rearranging:  $P_{\text{Denver}} = P_{\text{sea}} \cdot e^{\left(\frac{-M \cdot g}{R \cdot T} \cdot z_{\text{Denver}}\right)}$

$P_{\text{sea}} := 1\text{atm}$   $M := 29 \frac{\text{gm}}{\text{mol}}$   $g := 9.8 \frac{\text{m}}{\text{s}^2}$

$$R := 82.06 \frac{\text{cm}^3 \cdot \text{atm}}{\text{mol} \cdot \text{K}}$$

$$T := (10 + 273.15)\text{K}$$

$$z_{\text{Denver}} := 1 \cdot \text{mi}$$

$$\frac{M \cdot g}{R \cdot T} \cdot z_{\text{Denver}} = 0.194$$

$$P_{\text{Denver}} := P_{\text{sea}} \cdot e^{\left( \frac{-M \cdot g}{R \cdot T} \cdot z_{\text{Denver}} \right)}$$

$$P_{\text{Denver}} = 0.823 \text{ atm} \quad \text{Ans.}$$

$$P_{\text{Denver}} = 0.834 \text{ bar} \quad \text{Ans.}$$

**1.13 The same proportionality applies as in Pb. 1.11.**

$$g_{\text{earth}} := 32.186 \cdot \frac{\text{ft}}{\text{s}^2}$$

$$g_{\text{moon}} := 5.32 \cdot \frac{\text{ft}}{\text{s}^2}$$

$$\Delta l_{\text{moon}} := 18.76$$

$$\Delta l_{\text{earth}} := \Delta l_{\text{moon}} \cdot \frac{g_{\text{earth}}}{g_{\text{moon}}}$$

$$\Delta l_{\text{earth}} = 113.498$$

$$M := \Delta l_{\text{earth}} \cdot \text{lb}_m$$

$$M = 113.498 \text{ lb}_m \quad \text{Ans.}$$

$$w_{\text{moon}} := M \cdot g_{\text{moon}}$$

$$w_{\text{moon}} = 18.767 \text{ lbf} \quad \text{Ans.}$$

**1.14**  $\text{cost}_{\text{bulb}} := \frac{5.00 \text{ dollars}}{1000 \text{ hr}} \cdot 10 \frac{\text{hr}}{\text{day}}$

$$\text{cost}_{\text{elec}} := \frac{0.1 \text{ dollars}}{\text{kW} \cdot \text{hr}} \cdot 10 \frac{\text{hr}}{\text{day}} \cdot 70 \text{ W}$$

$$\text{cost}_{\text{bulb}} = 18.262 \frac{\text{dollars}}{\text{yr}}$$

$$\text{cost}_{\text{elec}} = 25.567 \frac{\text{dollars}}{\text{yr}}$$

$$\text{cost}_{\text{total}} := \text{cost}_{\text{bulb}} + \text{cost}_{\text{elec}}$$

$$\text{cost}_{\text{total}} = 43.829 \frac{\text{dollars}}{\text{yr}} \quad \text{Ans.}$$

**1.15**  $D := 1.25 \text{ ft}$

$$\text{mass} := 250 \text{ lb}_m$$

$$g := 32.169 \frac{\text{ft}}{\text{s}^2}$$

$$P_{\text{atm}} := 30.12 \text{ in}_\text{Hg}$$

$$A := \frac{\pi}{4} \cdot D^2$$

$$A = 1.227 \text{ ft}^2$$

(a)  $F := P_{\text{atm}} \cdot A + \text{mass} \cdot g$

$$F = 2.8642 \times 10^3 \text{ lbf}$$

**Ans.**

(b)  $P_{\text{abs}} := \frac{F}{A}$

$$P_{\text{abs}} = 16.208 \text{ psia}$$

**Ans.**

(c)  $\Delta l := 1.7 \text{ ft}$

$$\text{Work} := F \cdot \Delta l$$

$$\text{Work} = 4.8691 \times 10^3 \text{ ft} \cdot \text{lbf}$$

**Ans.**

$$\Delta P_E := \text{mass} \cdot g \cdot l$$

$$\Delta P_E = 424.9 \text{ ft} \cdot \text{lbf}$$

**Ans.**

1.16

$$D := 0.47 \text{ m}$$

$$\text{mass} := 150 \text{ kg}$$

$$g := 9.813 \frac{\text{m}}{\text{s}^2}$$

$$P_{\text{atm}} := 101.57 \text{ kPa}$$

$$A := \frac{\pi}{4} \cdot D^2$$

$$A = 0.173 \text{ m}^2$$

(a)  $F := P_{\text{atm}} \cdot A + \text{mass} \cdot g$

$$F = 1.909 \times 10^4 \text{ N}$$

**Ans.**

(b)  $P_{\text{abs}} := \frac{F}{A}$

$$P_{\text{abs}} = 110.054 \text{ kPa}$$

**Ans.**

(c)  $\Delta l := 0.83 \text{ m}$

$$\text{Work} := F \cdot \Delta l$$

$$\text{Work} = 15.848 \text{ kJ}$$

**Ans.**

$$\Delta E_P := \text{mass} \cdot g \cdot l$$

$$\Delta E_P = 1.222 \text{ kJ}$$

**Ans.**

1.18

$$\text{mass} := 1250 \text{ kg}$$

$$u := 40 \frac{\text{m}}{\text{s}}$$

$$E_K := \frac{1}{2} \text{mass} \cdot u^2$$

$$E_K = 1000 \text{ kJ}$$

**Ans.**

$$\text{Work} := E_K$$

$$\text{Work} = 1000 \text{ kJ}$$

**Ans.**

1.19

$$\text{Wdot} = \frac{\text{mass} \cdot g \cdot h}{\text{time}} \cdot 0.91 \cdot 0.92$$

$$\text{Wdot} := 200 \text{ W}$$

$$g := 9.8 \frac{\text{m}}{\text{s}^2}$$

$$\Delta h := 50 \text{ m}$$

$$\dot{m} := \frac{W_{\text{dot}}}{g \cdot \Delta h \cdot 0.91 \cdot 0.92}$$

$$\dot{m} = 0.488 \frac{\text{kg}}{\text{s}}$$

Ans.

1.22

$$\text{a) } \text{cost\_coal} := \frac{\frac{25.00}{\text{ton}}}{29 \cdot \frac{\text{MJ}}{\text{kg}}}$$

$$\text{cost\_coal} = 0.95 \text{ GJ}^{-1}$$

$$\text{cost\_gasoline} := \frac{\frac{2.00}{\text{gal}}}{37 \cdot \frac{\text{GJ}}{\text{m}^3}}$$

$$\text{cost\_gasoline} = 14.28 \text{ GJ}^{-1}$$

$$\text{cost\_electricity} := \frac{0.1000}{\text{kW} \cdot \text{hr}}$$

$$\text{cost\_electricity} = 27.778 \text{ GJ}^{-1}$$

- b) **The electrical energy can directly be converted to other forms of energy whereas the coal and gasoline would typically need to be converted to heat and then into some other form of energy before being useful.**

**The obvious advantage of coal is that it is cheap if it is used as a heat source. Otherwise it is messy to handle and bulky for transport and storage.**

**Gasoline is an important transportation fuel. It is more convenient to transport and store than coal. It can be used to generate electricity by burning it but the efficiency is limited. However, fuel cells are currently being developed which will allow for the conversion of gasoline to electricity by chemical means, a more efficient process.**

**Electricity has the most uses though it is expensive. It is easy to transport but expensive to store. As a transportation fuel it is clean but batteries to store it on-board have limited capacity and are heavy.**

**1.24 Use the Matcad genfit function to fit the data to Antoine's equation.**

**The genfit function requires the first derivatives of the function with respect to the parameters being fitted.**

**Function being fit:**  $f(T, A, B, C) := e^{\left(A - \frac{B}{T+C}\right)}$

**First derivative of the function with respect to parameter A**

$$\frac{d}{dA} f(T, A, B, C) \rightarrow \exp\left(A - \frac{B}{T+C}\right)$$

**First derivative of the function with respect to parameter B**

$$\frac{d}{dB} f(T, A, B, C) \rightarrow \frac{-1}{T+C} \cdot \exp\left(A - \frac{B}{T+C}\right)$$

**First derivative of the function with respect to parameter C**

$$\frac{d}{dC} f(T, A, B, C) \rightarrow \frac{B}{(T+C)^2} \cdot \exp\left(A - \frac{B}{T+C}\right)$$

$$t := \begin{pmatrix} -18.5 \\ -9.5 \\ 0.2 \\ 11.8 \\ 23.1 \\ 32.7 \\ 44.4 \\ 52.1 \\ 63.3 \\ 75.5 \end{pmatrix} \quad P_{\text{sat}} := \begin{pmatrix} 3.18 \\ 5.48 \\ 9.45 \\ 16.9 \\ 28.2 \\ 41.9 \\ 66.6 \\ 89.5 \\ 129 \\ 187 \end{pmatrix}$$

$$T := t + 273.15 \quad \ln P_{\text{sat}} := \ln(P_{\text{sat}})$$

**Array of functions used by Mathcad. In this case,  $a_0 = A$ ,  $a_1 = B$  and  $a_2 = C$ .**

$$F(T, a) := \begin{bmatrix} \exp\left(a_0 - \frac{a_1}{T + a_2}\right) \\ \exp\left(a_0 - \frac{a_1}{T + a_2}\right) \\ \frac{-1}{T + a_2} \cdot \exp\left(a_0 - \frac{a_1}{T + a_2}\right) \\ \frac{a_1}{(T + a_2)^2} \cdot \exp\left(a_0 - \frac{a_1}{T + a_2}\right) \end{bmatrix}$$

**Guess values of parameters**

$$\text{guess} := \begin{pmatrix} 15 \\ 3000 \\ -50 \end{pmatrix}$$

**Apply the genfit function**

$$\begin{pmatrix} A \\ B \\ C \end{pmatrix} := \text{genfit}(T, P_{\text{sat}}, \text{guess}, F)$$

$$\begin{pmatrix} A \\ B \\ C \end{pmatrix} = \begin{pmatrix} 13.421 \\ 2.29 \times 10^3 \\ -69.053 \end{pmatrix}$$

**Ans.**

**Compare fit with data.**

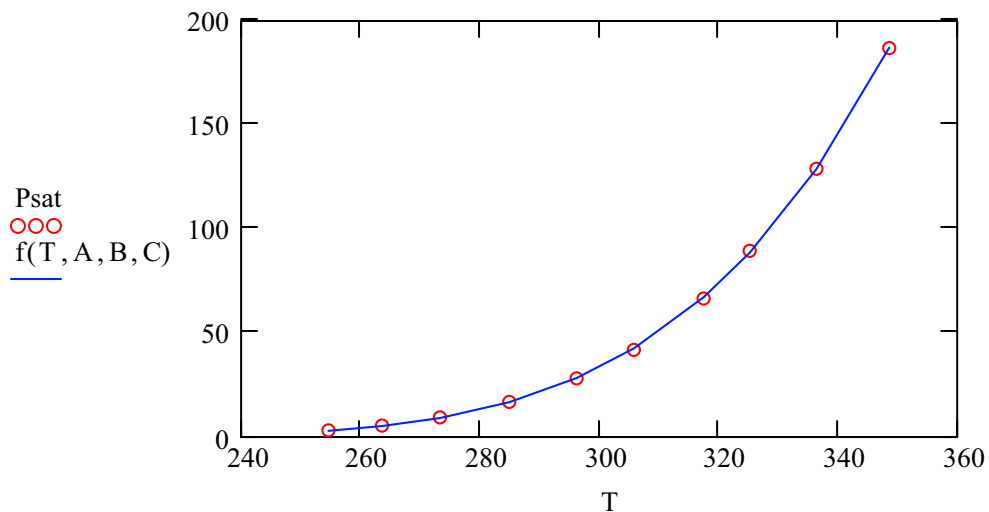

**To find the normal boiling point, find the value of T for which  $P_{\text{sat}} = 1$  atm.**

$$P_{\text{sat}} := 1 \text{ atm} \quad T_{\text{nb}} := \left( \frac{B}{A - \ln\left(\frac{P_{\text{sat}}}{\text{kPa}}\right)} - C \right) \cdot \text{K} \quad T_{\text{nb}} = 329.154 \text{ K}$$

$$T_{\text{nb}} - 273.15 \text{ K} = 56.004 \text{ degC} \quad \text{Ans.}$$

1.25

$$\text{a) } t_1 := 1970 \quad t_2 := 2000 \quad C_1 := 0.35 \frac{\text{dollars}}{\text{gal}} \quad i := 5\%$$

$$C_2 := C_1 \cdot (1 + i)^{t_2 - t_1} \quad C_2 = 1.513 \frac{\text{dollars}}{\text{gal}}$$

The increase in price of gasoline over this period kept pace with the rate of inflation.

$$\text{b) } t_1 := 1970 \quad t_2 := 2000 \quad C_1 := 16000 \frac{\text{dollars}}{\text{yr}} \quad C_2 := 80000 \frac{\text{dollars}}{\text{yr}}$$

$$\text{Given } \frac{C_2}{C_1} = (1 + i)^{t_2 - t_1} \quad i := \text{Find}(i) \quad i = 5.511\%$$

The salary of a Ph. D. engineer over this period increased at a rate of 5.5%, slightly higher than the rate of inflation.

c) This is an open-ended problem. The strategy depends on age of the child, and on such unpredictable items as possible financial aid, monies earned by the child, and length of time spent in earning a degree.



## Chapter 2 - Section A - Mathcad Solutions

2.1 (a)  $M_{wt} := 35 \cdot \text{kg}$        $g := 9.8 \cdot \frac{\text{m}}{\text{s}^2}$        $\Delta z := 5 \cdot \text{m}$

$\text{Work} := M_{wt} \cdot g \cdot z$        $\text{Work} = 1.715 \text{ kJ}$       **Ans.**

(b)  $\Delta U_{\text{total}} := \text{Work}$        $\Delta U_{\text{total}} = 1.715 \text{ kJ}$       **Ans.**

(c) **By Eqs. (2.14) and (2.21):**       $dU + d(PV) = C_p \cdot dT$

**Since P is constant, this can be written:**

$$M_{\text{H}_2\text{O}} \cdot C_p \cdot dT = M_{\text{H}_2\text{O}} \cdot dU + M_{\text{H}_2\text{O}} \cdot P \cdot dV$$

**Take  $C_p$  and  $V$  constant and integrate:**  $M_{\text{H}_2\text{O}} \cdot C_p \cdot (T_2 - T_1) = U_{\text{total}}$

$T_1 := 20 \cdot \text{degC}$        $C_p := 4.18 \cdot \frac{\text{kJ}}{\text{kg} \cdot \text{degC}}$        $M_{\text{H}_2\text{O}} := 30 \cdot \text{kg}$

$T_2 := T_1 + \frac{\Delta U_{\text{total}}}{M_{\text{H}_2\text{O}} \cdot C_p}$        $T_2 = 20.014 \text{ degC}$       **Ans.**

(d) **For the restoration process, the change in internal energy is equal but of opposite sign to that of the initial process. Thus**

$Q := -\Delta U_{\text{total}}$        $Q = -1.715 \text{ kJ}$       **Ans.**

(e) **In all cases the total internal energy change of the universe is zero.**

2.2 **Similar to Pb. 2.1 with mass of water = 30 kg.**

**Answers are:**

(a)  $W = 1.715 \text{ kJ}$

(b) **Internal energy change of the water = 1.429 kJ**

(c) **Final temp. = 20.014 deg C**

(d)  $Q = -1.715 \text{ kJ}$

2.4 The electric power supplied to the motor must equal the work done by the motor plus the heat generated by the motor.

$$i := 9.7 \text{ amp}$$

$$E := 110 \text{ V}$$

$$\dot{W}_{\text{mech}} := 1.25 \text{ hp}$$

$$\dot{W}_{\text{elect}} := i \cdot E$$

$$\dot{W}_{\text{elect}} = 1.067 \times 10^3 \text{ W}$$

$$\dot{Q} := \dot{W}_{\text{elect}} - \dot{W}_{\text{mech}}$$

$$\dot{Q} = 134.875 \text{ W}$$

Ans.

2.5 Eq. (2.3):  $\Delta U^t = Q + W$

Step 1 to 2:  $\Delta U_{12} := -200 \text{ J}$

$$W_{12} := -6000 \text{ J}$$

$$Q_{12} := \Delta U_{12} - W_{12}$$

$$Q_{12} = 5.8 \times 10^3 \text{ J}$$

Ans.

Step 3 to 4:  $Q_{34} := -800 \text{ J}$

$$W_{34} := 300 \text{ J}$$

$$\Delta U_{34} := Q_{34} + W_{34}$$

$$\Delta U_{34} = -500 \text{ J}$$

Ans.

Step 1 to 2 to 3 to 4 to 1: Since  $\Delta U^t$  is a state function,  $\Delta U^t$  for a series of steps that leads back to the initial state must be zero. Therefore, the sum of the  $\Delta U^t$  values for all of the steps must sum to zero.

$$\Delta U_{41} := 4700 \text{ J}$$

$$\Delta U_{23} := -\Delta U_{12} - \Delta U_{34} - \Delta U_{41}$$

$$\Delta U_{23} = -4000 \text{ J}$$

Ans.

Step 2 to 3:  $\Delta U_{23} = -4 \times 10^3 \text{ J}$

$$Q_{23} := -3800 \text{ J}$$

$$W_{23} := \Delta U_{23} - Q_{23}$$

$$W_{23} = -200 \text{ J}$$

Ans.

For a series of steps, the total work done is the sum of the work done for each step.

$$W_{12341} := -1400 \text{ J}$$

$$W_{41} := W_{12341} - W_{12} - W_{23} - W_{34} \quad W_{41} = 4.5 \times 10^3 \text{ J} \quad \text{Ans.}$$

Step 4 to 1:  $\Delta U_{t41} := 4700 \text{ J}$   $W_{41} = 4.5 \times 10^3 \text{ J}$

$$Q_{41} := \Delta U_{t41} - W_{41} \quad Q_{41} = 200 \text{ J} \quad \text{Ans.}$$

Note:  $Q_{12341} = -W_{12341}$

**2.11 The enthalpy change of the water = work done.**

$$M := 20 \cdot \text{kg} \quad C_p := 4.18 \cdot \frac{\text{kJ}}{\text{kg} \cdot \text{degC}} \quad \Delta t := 10 \cdot \text{degC}$$

$$\dot{W} := 0.25 \cdot \text{kW} \quad \Delta \tau := \frac{M \cdot C_p \cdot t}{\dot{W}} \quad \Delta \tau = 0.929 \text{ hr} \quad \text{Ans.}$$

2.12  $Q := 7.5 \cdot \text{kJ}$   $\Delta U := -12 \cdot \text{kJ}$   $W := \Delta U - Q$

$$W = -19.5 \text{ kJ} \quad \text{Ans.}$$

$$\Delta U := -12 \cdot \text{kJ} \quad Q := \Delta U \quad Q = -12 \text{ kJ} \quad \text{Ans.}$$

**2.13 Subscripts: c, casting; w, water; t, tank. Then**

$$m_c \cdot \Delta U_c + m_w \cdot \Delta U_w + m_t \cdot \Delta U_t = 0$$

Let C represent specific heat,  $C = C_p = C_v$

Then by Eq. (2.18)

$$m_c \cdot C_c \cdot (t_c - t_2) + m_w \cdot C_w \cdot (t_w - t_2) + m_t \cdot C_t \cdot (t_t - t_2) = 0$$

$$m_c := 2 \cdot \text{kg} \quad m_w := 40 \cdot \text{kg} \quad m_t := 5 \cdot \text{kg}$$

$$C_c := 0.50 \cdot \frac{\text{kJ}}{\text{kg} \cdot \text{degC}} \quad C_t := 0.5 \cdot \frac{\text{kJ}}{\text{kg} \cdot \text{degC}} \quad C_w := 4.18 \cdot \frac{\text{kJ}}{\text{kg} \cdot \text{degC}}$$

$$t_c := 500 \cdot \text{degC} \quad t_1 := 25 \cdot \text{degC} \quad t_2 := 30 \cdot \text{degC} \quad (\text{guess})$$

Given  $-m_c \cdot C_c \cdot (t_2 - t_c) = (m_w \cdot C_w + m_t \cdot C_t) \cdot (t_2 - t_1)$

$$t_2 := \text{Find}(t_2) \quad t_2 = 27.78 \text{ degC} \quad \text{Ans.}$$

2.15  $\text{mass} := 1 \cdot \text{kg}$   $C_V := 4.18 \frac{\text{kJ}}{\text{kg} \cdot \text{K}}$

(a)  $\Delta T := 1 \text{K}$   $\Delta U_t := \text{mass} \cdot C_V \cdot T$   $\Delta U_t = 4.18 \text{kJ}$  **Ans.**

(b)  $g := 9.8 \frac{\text{m}}{\text{s}^2}$   $\Delta E_p := \Delta U_t$

$\Delta z := \frac{\Delta E_p}{\text{mass} \cdot g}$   $\Delta z = 426.531 \text{m}$  **Ans.**

(c)  $\Delta E_K := \Delta U_t$   $u := \sqrt{\frac{\Delta E_K}{\frac{1}{2} \cdot \text{mass}}}$   $u = 91.433 \frac{\text{m}}{\text{s}}$  **Ans.**

2.17  $\Delta z := 50 \text{m}$   $\rho := 1000 \frac{\text{kg}}{\text{m}^3}$   $u := 5 \frac{\text{m}}{\text{s}}$

$D := 2 \text{m}$   $A := \frac{\pi}{4} D^2$   $A = 3.142 \text{m}^2$

$\dot{m} := \rho \cdot u \cdot A$   $\dot{m} = 1.571 \times 10^4 \frac{\text{kg}}{\text{s}}$

$\dot{W} := \dot{m} \cdot g \cdot z$   $\dot{W} = 7.697 \times 10^3 \text{kW}$  **Ans.**

2.18 (a)  $U_1 := 762.0 \cdot \frac{\text{kJ}}{\text{kg}}$   $P_1 := 1002.7 \cdot \text{kPa}$   $V_1 := 1.128 \cdot \frac{\text{cm}^3}{\text{gm}}$

$H_1 := U_1 + P_1 \cdot V_1$   $H_1 = 763.131 \frac{\text{kJ}}{\text{kg}}$  **Ans.**

(b)  $U_2 := 2784.4 \cdot \frac{\text{kJ}}{\text{kg}}$   $P_2 := 1500 \cdot \text{kPa}$   $V_2 := 169.7 \cdot \frac{\text{cm}^3}{\text{gm}}$

$H_2 := U_2 + P_2 \cdot V_2$   $\Delta U := U_2 - U_1$   $\Delta H := H_2 - H_1$

$\Delta U = 2022.4 \frac{\text{kJ}}{\text{kg}}$  **Ans.**  $\Delta H = 2275.8 \frac{\text{kJ}}{\text{kg}}$  **Ans.**

2.22

$$D_1 := 2.5 \text{ cm}$$

$$u_1 := 2 \frac{\text{m}}{\text{s}}$$

$$D_2 := 5 \text{ cm}$$

- (a) For an incompressible fluid,  $\rho = \text{constant}$ . By a mass balance,  
 $\dot{m} = \text{constant} = u_1 A_1 \rho = u_2 A_2 \rho$ .

$$u_2 := u_1 \cdot \left( \frac{D_1}{D_2} \right)^2 \quad u_2 = 0.5 \frac{\text{m}}{\text{s}} \quad \text{Ans.}$$

(b)  $\Delta E_K := \frac{1}{2} u_2^2 - \frac{1}{2} u_1^2 \quad \Delta E_K = -1.875 \frac{\text{J}}{\text{kg}} \quad \text{Ans.}$

2.23 Energy balance:  $\dot{m}_3 \cdot H_3 - (\dot{m}_1 \cdot H_1 + \dot{m}_2 \cdot H_2) = \dot{Q}$

Mass balance:  $\dot{m}_3 - \dot{m}_1 - \dot{m}_2 = 0$

Therefore:  $\dot{m}_1 \cdot (H_3 - H_1) + \dot{m}_2 \cdot (H_3 - H_2) = \dot{Q}$

or  $\dot{m} \cdot C_p \cdot (T_3 - T_1) + \dot{m}_2 \cdot C_p \cdot (T_3 - T_2) = \dot{Q}$

$$T_3 \cdot C_p \cdot (\dot{m}_1 + \dot{m}_2) = \dot{Q} + \dot{m}_1 \cdot C_p \cdot T_1 + \dot{m}_2 \cdot C_p \cdot T_2$$

$$\dot{m}_1 := 1.0 \frac{\text{kg}}{\text{s}}$$

$$T_1 := 25 \text{ degC}$$

$$\dot{m}_2 := 0.8 \frac{\text{kg}}{\text{s}}$$

$$T_2 := 75 \text{ degC}$$

$$\dot{Q} := -30 \frac{\text{kJ}}{\text{s}}$$

$$C_p := 4.18 \frac{\text{kJ}}{\text{kg} \cdot \text{K}}$$

$$T_3 := \frac{\dot{Q} + \dot{m}_1 \cdot C_p \cdot T_1 + \dot{m}_2 \cdot C_p \cdot T_2}{(\dot{m}_1 + \dot{m}_2) \cdot C_p} \quad T_3 = 43.235 \text{ degC} \quad \text{Ans.}$$

2.25 By Eq. (2.32a):  $\Delta H + \frac{\Delta u^2}{2} = 0 \quad \Delta H = C_p \cdot \Delta T$

By continuity,  
 incompressibility

$$u_2 = u_1 \cdot \frac{A_1}{A_2}$$

$$C_p := 4.18 \cdot \frac{\text{kJ}}{\text{kg} \cdot \text{degC}}$$

$$\Delta u^2 = u_1^2 \cdot \left[ \left( \frac{A_1}{A_2} \right)^2 - 1 \right] \quad \Delta u^2 = u_1^2 \cdot \left[ \left( \frac{D_1}{D_2} \right)^4 - 1 \right]$$

**SI units:**  $u_1 := 14 \cdot \frac{\text{m}}{\text{s}}$        $D_1 := 2.5 \cdot \text{cm}$        $D_2 := 3.8 \cdot \text{cm}$

$$\Delta T := \frac{u_1^2}{2 \cdot C_P} \cdot \left[ 1 - \left( \frac{D_1}{D_2} \right)^4 \right] \quad \Delta T = 0.019 \text{ degC} \quad \text{Ans.}$$

$D_2 := 7.5 \text{ cm}$

$$\Delta T := \frac{u_1^2}{2 \cdot C_P} \cdot \left[ 1 - \left( \frac{D_1}{D_2} \right)^4 \right] \quad \Delta T = 0.023 \text{ degC} \quad \text{Ans.}$$

**Maximum T change occurs for infinite D2:**

$D_2 := \infty \cdot \text{cm}$

$$\Delta T := \frac{u_1^2}{2 \cdot C_P} \cdot \left[ 1 - \left( \frac{D_1}{D_2} \right)^4 \right] \quad \Delta T = 0.023 \text{ degC} \quad \text{Ans.}$$

**2.26**  $T_1 := 300 \text{ K}$        $T_2 := 520 \text{ K}$        $u_1 := 10 \frac{\text{m}}{\text{s}}$        $u_2 := 3.5 \frac{\text{m}}{\text{s}}$        $\text{molwt} := 29 \frac{\text{kg}}{\text{kmol}}$

$\dot{W} := 98.8 \text{ kW}$        $\dot{n} := 50 \frac{\text{kmol}}{\text{hr}}$        $C_P := \frac{7}{2} \cdot R$

$$\Delta H := C_P \cdot (T_2 - T_1) \quad \Delta H = 6.402 \times 10^3 \frac{\text{kJ}}{\text{kmol}}$$

**By Eq. (2.30):**

$$\dot{Q} := \left[ \Delta H + \left( \frac{u_2^2}{2} - \frac{u_1^2}{2} \right) \cdot \text{molwt} \right] \cdot \dot{n} - \dot{W} \quad \dot{Q} = -9.904 \text{ kW} \quad \text{Ans.}$$

**2.27 By Eq. (2.32b):**       $\Delta H = -\frac{\Delta u^2}{2 \cdot g_c}$       **also**       $\frac{V_2}{V_1} = \frac{T_2}{T_1} \cdot \frac{P_1}{P_2}$

**By continuity, constant area**       $u_2 = u_1 \cdot \frac{V_2}{V_1}$        $u_2 = u_1 \cdot \frac{T_2}{T_1} \cdot \frac{P_1}{P_2}$        $\Delta u^2 = u_2^2 - u_1^2$

$$\Delta u^2 = u_1^2 \cdot \left[ \left( \frac{T_2 \cdot P_1}{T_1 \cdot P_2} \right)^2 - 1 \right] \quad \Delta H = C_p \cdot \Delta T = \frac{7}{2} \cdot R \cdot (T_2 - T_1)$$

$$P_1 := 100 \cdot \text{psi} \quad P_2 := 20 \cdot \text{psi} \quad u_1 := 20 \cdot \frac{\text{ft}}{\text{s}} \quad T_1 := 579.67 \cdot \text{rankine}$$

$$R = 3.407 \frac{\text{ft} \cdot \text{lb}_f}{\text{mol} \cdot \text{rankine}} \quad \text{molwt} := 28 \frac{\text{gm}}{\text{mol}}$$

$$T_2 := 578 \cdot \text{rankine} \quad (\text{guess})$$

$$\text{Given} \quad \frac{7}{2} \cdot R \cdot (T_2 - T_1) = -\frac{u_1^2}{2} \cdot \left[ \left( \frac{T_2 \cdot P_1}{T_1 \cdot P_2} \right)^2 - 1 \right] \cdot \text{molwt}$$

$$T_2 := \text{Find}(T_2) \quad T_2 = 578.9 \text{ rankine} \quad \text{Ans.}$$

(119.15 · degF)

$$2.28 \quad u_1 := 3 \cdot \frac{\text{m}}{\text{s}} \quad u_2 := 200 \cdot \frac{\text{m}}{\text{s}} \quad H_1 := 334.9 \cdot \frac{\text{kJ}}{\text{kg}} \quad H_2 := 2726.5 \cdot \frac{\text{kJ}}{\text{kg}}$$

$$\text{By Eq. (2.32a):} \quad Q := H_2 - H_1 + \frac{u_2^2 - u_1^2}{2} \quad Q = 2411.6 \frac{\text{kJ}}{\text{kg}} \quad \text{Ans.}$$

$$2.29 \quad u_1 := 30 \cdot \frac{\text{m}}{\text{s}} \quad H_1 := 3112.5 \cdot \frac{\text{kJ}}{\text{kg}} \quad H_2 := 2945.7 \cdot \frac{\text{kJ}}{\text{kg}}$$

$$u_2 := 500 \cdot \frac{\text{m}}{\text{s}} \quad (\text{guess})$$

$$\text{By Eq. (2.32a):} \quad \text{Given} \quad H_2 - H_1 = \frac{u_1^2 - u_2^2}{2} \quad u_2 := \text{Find}(u_2)$$

$$u_2 = 578.36 \frac{\text{m}}{\text{s}} \quad \text{Ans.}$$

$$D_1 := 5 \cdot \text{cm} \quad V_1 := 388.61 \cdot \frac{\text{cm}^3}{\text{gm}} \quad V_2 := 667.75 \cdot \frac{\text{cm}^3}{\text{gm}}$$

**Continuity:**  $D_2 := D_1 \cdot \sqrt{\frac{u_1 \cdot V_2}{u_2 \cdot V_1}}$   $D_2 = 1.493 \text{ cm}$  **Ans.**

2.30 (a)  $t_1 := 30 \cdot \text{degC}$   $t_2 := 250 \cdot \text{degC}$   $n := 3 \cdot \text{mol}$

$$C_V := 20.8 \cdot \frac{\text{J}}{\text{mol} \cdot \text{degC}}$$

By Eq. (2.19):  $Q := n \cdot C_V \cdot (t_2 - t_1)$   $Q = 13.728 \text{ kJ}$  **Ans.**

Take into account the heat capacity of the vessel; then

$$m_v := 100 \cdot \text{kg} \quad c_v := 0.5 \cdot \frac{\text{kJ}}{\text{kg} \cdot \text{degC}}$$

$Q := (m_v \cdot c_v + n \cdot C_V) \cdot (t_2 - t_1)$   $Q = 11014 \text{ kJ}$  **Ans.**

(b)  $t_1 := 200 \cdot \text{degC}$   $t_2 := 40 \cdot \text{degC}$   $n := 4 \cdot \text{mol}$

$$C_P := 29.1 \cdot \frac{\text{joule}}{\text{mol} \cdot \text{degC}}$$

By Eq. (2.23):  $Q := n \cdot C_P \cdot (t_2 - t_1)$   $Q = -18.62 \text{ kJ}$  **Ans.**

2.31 (a)  $t_1 := 70 \cdot \text{degF}$   $t_2 := 350 \cdot \text{degF}$   $n := 3 \cdot \text{mol}$

$$C_V := 5 \cdot \frac{\text{BTU}}{\text{mol} \cdot \text{degF}}$$

By Eq. (2.19):

$Q := n \cdot C_V \cdot (t_2 - t_1)$   $Q = 4200 \text{ BTU}$  **Ans.**

Take account of the heat capacity of the vessel:

$$m_v := 200 \cdot \text{lb}_m \quad c_v := 0.12 \cdot \frac{\text{BTU}}{\text{lb}_m \cdot \text{degF}}$$

$Q := (m_v \cdot c_v + n \cdot C_V) \cdot (t_2 - t_1)$   $Q = 10920 \text{ BTU}$  **Ans.**

(b)  $t_1 := 400 \cdot \text{degF}$   $t_2 := 150 \cdot \text{degF}$   $n := 4 \cdot \text{mol}$



$$C_p := 7 \cdot \frac{\text{BTU}}{\text{mol} \cdot \text{degF}}$$

By Eq. (2.23):

$$Q := n \cdot C_p \cdot (t_2 - t_1)$$

$$Q = -7000 \text{ BTU}$$

Ans.

2.33

$$H_1 := 1322.6 \cdot \frac{\text{BTU}}{\text{lb}_m}$$

$$H_2 := 1148.6 \cdot \frac{\text{BTU}}{\text{lb}_m}$$

$$u_1 := 10 \cdot \frac{\text{ft}}{\text{s}}$$

$$V_1 := 3.058 \cdot \frac{\text{ft}^3}{\text{lb}_m}$$

$$V_2 := 78.14 \cdot \frac{\text{ft}^3}{\text{lb}_m}$$

$$D_1 := 3 \cdot \text{in}$$

$$D_2 := 10 \cdot \text{in}$$

$$\dot{m} := \frac{\frac{\pi}{4} \cdot D_1^2 \cdot u_1}{V_1}$$

$$\dot{m} = 3.463 \times 10^4 \frac{\text{lb}}{\text{sec}}$$

$$u_2 := \dot{m} \cdot \frac{V_2}{\frac{\pi}{4} \cdot D_2^2}$$

$$u_2 = 22.997 \frac{\text{ft}}{\text{sec}}$$

$$\text{Eq. (2.32a): } W_s := H_2 - H_1 + \frac{u_2^2 - u_1^2}{2}$$

$$W_s = -173.99 \frac{\text{BTU}}{\text{lb}}$$

$$\dot{W} := -W_s \cdot \dot{m}$$

$$\dot{W} = 39.52 \text{ hp}$$

Ans.

2.34

$$H_1 := 307 \cdot \frac{\text{BTU}}{\text{lb}_m}$$

$$H_2 := 330 \cdot \frac{\text{BTU}}{\text{lb}_m}$$

$$u_1 := 20 \cdot \frac{\text{ft}}{\text{s}}$$

$$\text{molwt} := 44 \cdot \frac{\text{gm}}{\text{mol}}$$

$$V_1 := 9.25 \cdot \frac{\text{ft}^3}{\text{lb}_m}$$

$$V_2 := 0.28 \cdot \frac{\text{ft}^3}{\text{lb}_m}$$

$$D_1 := 4 \cdot \text{in}$$

$$D_2 := 1 \cdot \text{in}$$

$$\dot{m} := \frac{\frac{\pi}{4} \cdot D_1^2 \cdot u_1}{V_1}$$

$$\dot{m} = 679.263 \frac{\text{lb}}{\text{hr}}$$

$$u_2 := \dot{m} \cdot \frac{V_2}{\frac{\pi}{4} \cdot D_2^2}$$

$$u_2 = 9.686 \frac{\text{ft}}{\text{sec}}$$

$$W_s := 5360 \cdot \frac{\text{BTU}}{\text{lbmol}}$$

$$\text{Eq. (2.32a): } Q := H_2 - H_1 + \frac{u_2^2 - u_1^2}{2} - \frac{W_s}{\text{molwt}}$$

$$Q = -98.82 \frac{\text{BTU}}{\text{lb}_m}$$

$$\dot{Q} := \dot{m} \cdot Q \quad \dot{Q} = -67128 \frac{\text{BTU}}{\text{hr}} \quad \text{Ans.}$$

**2.36**  $T_1 := 300 \cdot \text{K}$       $P := 1 \cdot \text{bar}$       $n := \frac{1 \cdot \text{kg}}{28.9 \cdot \frac{\text{gm}}{\text{mol}}}$       $n = 34.602 \text{ mol}$

$$V_1 := 83.14 \cdot \frac{\text{bar} \cdot \text{cm}^3}{\text{mol} \cdot \text{K}} \cdot \frac{T_1}{P} \quad V_1 = 24942 \frac{\text{cm}^3}{\text{mol}}$$

$$W = -n \cdot \int_{V_1}^{V_2} P \, dV = n \cdot P \cdot (V_1 - V_2) = n \cdot P \cdot (V_1 - 3 \cdot V_1)$$

**Whence**      $W := -n \cdot P \cdot 2 \cdot V_1$       $W = -172.61 \text{ kJ}$      **Ans.**

**Given:**      $T_2 = T_1 \cdot \frac{V_2}{V_1} = T_1 \cdot 3$      **Whence**      $T_2 := 3 \cdot T_1$

$$C_P := 29 \cdot \frac{\text{joule}}{\text{mol} \cdot \text{K}} \quad \Delta H := C_P \cdot (T_2 - T_1) \quad \Delta H = 17.4 \frac{\text{kJ}}{\text{mol}} \quad \text{Ans.}$$

$Q := n \cdot \Delta H$       $Q = 602.08 \text{ kJ}$      **Ans.**

$$\Delta U := \frac{Q + W}{n} \quad \Delta U = 12.41 \frac{\text{kJ}}{\text{mol}} \quad \text{Ans.}$$

**2.37 Work exactly like Ex. 2.10: 2 steps, (a) & (b). A value is required for PV/T, namely R.**

$$R = 8.314 \frac{\text{J}}{\text{mol} \cdot \text{K}}$$

$$T_1 := 293.15 \cdot \text{K}$$

$$T_2 := 333.15 \cdot \text{K}$$

$$P_1 := 1000 \cdot \text{kPa}$$

$$P_2 := 100 \cdot \text{kPa}$$

**(a) Cool at const V1 to P2**

$$C_P := \frac{7}{2} \cdot R$$

$$C_V := \frac{5}{2} \cdot R$$

**(b) Heat at const P2 to T2**

$$T_{a2} := T_1 \cdot \frac{P_2}{P_1} \quad T_{a2} = 29.315 \text{ K}$$

$$\Delta T_b := T_2 - T_{a2} \quad \Delta T_b = 303.835 \text{ K} \quad \Delta T_a := T_{a2} - T_1 \quad \Delta T_a = -263.835 \text{ K}$$

$$\Delta H_b := C_p \cdot \Delta T_b \quad \Delta H_b = 8.841 \times 10^3 \frac{\text{J}}{\text{mol}}$$

$$\Delta U_a := C_v \cdot \Delta T_a \quad \Delta U_a = -5.484 \times 10^3 \frac{\text{J}}{\text{mol}}$$

$$V_1 := \frac{R \cdot T_1}{P_1} \quad V_1 = 2.437 \times 10^{-3} \frac{\text{m}^3}{\text{mol}} \quad V_2 := \frac{R \cdot T_2}{P_2} \quad V_2 = 0.028 \frac{\text{m}^3}{\text{mol}}$$

$$\Delta H_a := \Delta U_a + V_1 \cdot (P_2 - P_1) \quad \Delta H_a = -7.677 \times 10^3 \frac{\text{J}}{\text{mol}}$$

$$\Delta U_b := \Delta H_b - P_2 \cdot (V_2 - V_1) \quad \Delta U_b = 6.315 \times 10^3 \frac{\text{J}}{\text{mol}}$$

$$\Delta U := \Delta U_a + \Delta U_b \quad \Delta U = 0.831 \frac{\text{kJ}}{\text{mol}} \quad \text{Ans.}$$

$$\Delta H := \Delta H_a + \Delta H_b \quad \Delta H = 1.164 \frac{\text{kJ}}{\text{mol}} \quad \text{Ans.}$$

2.39  $\rho := 996 \frac{\text{kg}}{\text{m}^3}$

$$\mu := 9.0 \cdot 10^{-4} \frac{\text{kg}}{\text{m} \cdot \text{s}}$$

$$\varepsilon_D := 0.0001 \quad \text{Note: } \varepsilon_D = \varepsilon/D \text{ in this solution}$$

$$D := \begin{pmatrix} 2 \\ 5 \\ 2 \\ 5 \end{pmatrix} \text{ cm}$$

$$u := \begin{pmatrix} 1 \\ 1 \\ 5 \\ 5 \end{pmatrix} \frac{\text{m}}{\text{s}}$$

$$\text{Re} := \frac{D \cdot \rho \cdot u}{\mu}$$

$$\text{Re} = \begin{pmatrix} 22133 \\ 55333 \\ 110667 \\ 276667 \end{pmatrix}$$

$$f_F := \overline{\left[ 0.3305 \cdot \ln \left[ 0.27 \cdot \varepsilon D + \left( \frac{7}{\text{Re}} \right)^{0.9} \right] \right]^{-2}}$$

$$f_F = \begin{pmatrix} 0.00635 \\ 0.00517 \\ 0.00452 \\ 0.0039 \end{pmatrix}$$

$$\dot{m} := \left( \rho \cdot u \cdot \frac{\pi}{4} D^2 \right)$$

$$\dot{m} = \begin{pmatrix} 0.313 \\ 1.956 \frac{\text{kg}}{\text{s}} \\ 1.565 \\ 9.778 \end{pmatrix}$$

**Ans.**

$$\Delta P_{\Delta L} := \left( \frac{-2}{D} \cdot f_F \cdot \rho \cdot u^2 \right)$$

$$\Delta P_{\Delta L} = \begin{pmatrix} -0.632 \\ -0.206 \frac{\text{kPa}}{\text{m}} \\ -11.254 \\ -3.88 \end{pmatrix}$$

**Ans.**

2.42  $\dot{m} := 4.5 \frac{\text{kg}}{\text{s}}$

$$H_1 := 761.1 \frac{\text{kJ}}{\text{kg}}$$

$$H_2 := 536.9 \frac{\text{kJ}}{\text{kg}}$$

**Assume that the compressor is adiabatic ( $\dot{Q} = 0$ ). Neglect changes in KE and PE.**

$$\dot{W} := \dot{m} \cdot (H_2 - H_1)$$

$$\dot{W} = -1.009 \times 10^3 \text{ kW}$$

$$\text{Cost} := 15200 \cdot \left( \frac{|\dot{W}|}{\text{kW}} \right)^{0.573}$$

$$\text{Cost} = 799924 \text{ dollars } \mathbf{Ans.}$$

## Chapter 3 - Section A - Mathcad Solutions

$$3.1 \quad \beta = \frac{-1}{\rho} \cdot \left( \frac{d}{dT} \rho \right)_P \quad \kappa = \frac{1}{\rho} \cdot \left( \frac{d}{dP} \rho \right)_T$$

At constant T, the 2nd equation can be written:

$$\frac{d\rho}{\rho} = \kappa \cdot dP \quad \ln\left(\frac{\rho_2}{\rho_1}\right) = \kappa \Delta P \quad \kappa := 44.18 \cdot 10^{-6} \cdot \text{bar}^{-1} \quad \rho_2 = 1.01 \cdot \rho_1$$

$$\Delta P := \frac{\ln(1.01)}{\kappa} \quad \Delta P = 225.2 \text{ bar} \quad P_2 = 226.2 \cdot \text{bar} \quad \text{Ans.}$$

$$3.4 \quad b := 2700 \cdot \text{bar} \quad c := 0.125 \cdot \frac{\text{cm}^3}{\text{gm}} \quad P_1 := 1 \cdot \text{bar} \quad P_2 := 500 \cdot \text{bar}$$

Since  $\text{Work} = - \int_{V_1}^{V_2} P \, dV$  a bit of algebra leads to

$$\text{Work} := c \cdot \int_{P_1}^{P_2} \frac{P}{P+b} \, dP \quad \text{Work} = 0.516 \frac{\text{J}}{\text{gm}} \quad \text{Ans.}$$

Alternatively, formal integration leads to

$$\text{Work} := c \cdot \left( P_2 - P_1 - b \cdot \ln\left(\frac{P_2+b}{P_1+b}\right) \right) \quad \text{Work} = 0.516 \frac{\text{J}}{\text{gm}} \quad \text{Ans.}$$

$$3.5 \quad \kappa = a + b \cdot P \quad a := 3.9 \cdot 10^{-6} \cdot \text{atm}^{-1} \quad b := -0.1 \cdot 10^{-9} \cdot \text{atm}^{-2}$$

$$P_1 := 1 \cdot \text{atm} \quad P_2 := 3000 \cdot \text{atm} \quad V := 1 \cdot \text{ft}^3 \quad (\text{assume const.})$$

Combine Eqs. (1.3) and (3.3) for const. T:

$$\text{Work} := V \cdot \int_{P_1}^{P_2} (a + b \cdot P) \cdot P \, dP \quad \text{Work} = 16.65 \text{ atm} \cdot \text{ft}^3 \quad \text{Ans.}$$

$$3.6 \quad \beta := 1.2 \cdot 10^{-3} \cdot \text{degC}^{-1} \quad C_P := 0.84 \cdot \frac{\text{kJ}}{\text{kg} \cdot \text{degC}} \quad M := 5 \cdot \text{kg}$$

$$V_1 := \frac{1}{1590} \cdot \frac{\text{m}^3}{\text{kg}} \quad P := 1 \cdot \text{bar} \quad t_1 := 0 \cdot \text{degC} \quad t_2 := 20 \cdot \text{degC}$$

With beta independent of T and with P=constant,

$$\frac{dV}{V} = \beta \cdot dT \quad V_2 := V_1 \cdot \exp[\beta \cdot (t_2 - t_1)] \quad \Delta V := V_2 - V_1$$

$$\Delta V_{\text{total}} := M \cdot \Delta V \quad \Delta V_{\text{total}} = 7.638 \times 10^{-5} \text{ m}^3 \quad \text{Ans.}$$

$$\text{Work} := -P \cdot V_{\text{total}} \quad (\text{Const. P}) \quad \text{Work} = -7.638 \text{ joule} \quad \text{Ans.}$$

$$Q := M \cdot C_P \cdot (t_2 - t_1) \quad Q = 84 \text{ kJ} \quad \text{Ans.}$$

$$\Delta H_{\text{total}} := Q \quad \Delta H_{\text{total}} = 84 \text{ kJ} \quad \text{Ans.}$$

$$\Delta U_{\text{total}} := Q + \text{Work} \quad \Delta U_{\text{total}} = 83.99 \text{ kJ} \quad \text{Ans.}$$

$$3.8 \quad P_1 := 8 \cdot \text{bar} \quad P_2 := 1 \cdot \text{bar} \quad T_1 := 600 \cdot \text{K} \quad C_P := \frac{7}{2} \cdot R \quad C_V := \frac{5}{2} \cdot R$$

$$(a) \text{ Constant V:} \quad W = 0 \quad \text{and} \quad \Delta U = Q = C_V \cdot \Delta T$$

$$T_2 := T_1 \cdot \frac{P_2}{P_1} \quad \Delta T := T_2 - T_1 \quad \Delta T = -525 \text{ K}$$

$$\Delta U := C_V \cdot \Delta T \quad Q \text{ and} \quad \Delta U = -10.91 \frac{\text{kJ}}{\text{mol}} \quad \text{Ans.}$$

$$\Delta H := C_P \cdot \Delta T \quad \Delta H = -15.28 \frac{\text{kJ}}{\text{mol}} \quad \text{Ans.}$$

$$(b) \text{ Constant T:} \quad \Delta U = \Delta H = 0 \quad \text{and} \quad Q = W$$

$$\text{Work} := R \cdot T_1 \cdot \ln\left(\frac{P_2}{P_1}\right) \quad Q \text{ and} \quad \text{Work} = -10.37 \frac{\text{kJ}}{\text{mol}} \quad \text{Ans.}$$

$$(c) \text{ Adiabatic:} \quad Q = 0 \quad \text{and} \quad \Delta U = W = C_V \cdot \Delta T$$

$$\gamma := \frac{C_P}{C_V} \quad T_2 := T_1 \cdot \left( \frac{P_2}{P_1} \right)^{\frac{\gamma-1}{\gamma}} \quad T_2 = 331.227\text{K} \quad \Delta T := T_2 - T_1$$

$$\Delta U := C_V \cdot \Delta T$$

$$\Delta H := C_P \cdot \Delta T$$

W and  $\Delta U = -5.586 \frac{\text{kJ}}{\text{mol}}$  Ans.  $\Delta H = -7.821 \frac{\text{kJ}}{\text{mol}}$  Ans.

3.9  $P_4 := 2\text{bar}$   $C_P := \frac{7}{2}R$   $C_V := \frac{5}{2}R$

$P_1 := 10\text{bar}$   $T_1 := 600\text{K}$   $V_1 := \frac{R \cdot T_1}{P_1}$   $V_1 = 4.988 \times 10^{-3} \frac{\text{m}^3}{\text{mol}}$

Step 41: Adiabatic  $T_4 := T_1 \cdot \left( \frac{P_4}{P_1} \right)^{\frac{R}{C_P}}$   $T_4 = 378.831\text{K}$

$$\Delta U_{41} := C_V \cdot (T_1 - T_4) \quad \Delta U_{41} = 4.597 \times 10^3 \frac{\text{J}}{\text{mol}}$$

$$\Delta H_{41} := C_P \cdot (T_1 - T_4) \quad \Delta H_{41} = 6.436 \times 10^3 \frac{\text{J}}{\text{mol}}$$

$$Q_{41} := 0 \frac{\text{J}}{\text{mol}} \quad Q_{41} = 0 \frac{\text{J}}{\text{mol}}$$

$$W_{41} := \Delta U_{41} \quad W_{41} = 4.597 \times 10^3 \frac{\text{J}}{\text{mol}}$$

$P_2 := 3\text{bar}$   $T_2 := 600\text{K}$   $V_2 := \frac{R \cdot T_2}{P_2}$   $V_2 = 0.017 \frac{\text{m}^3}{\text{mol}}$

Step 12: Isothermal  $\Delta U_{12} := 0 \frac{\text{J}}{\text{mol}}$   $\Delta U_{12} = 0 \frac{\text{J}}{\text{mol}}$

$$\Delta H_{12} := 0 \frac{\text{J}}{\text{mol}} \quad \Delta H_{12} = 0 \frac{\text{J}}{\text{mol}}$$

$$Q_{12} := -R \cdot T_1 \cdot \ln\left(\frac{P_2}{P_1}\right) \quad Q_{12} = 6.006 \times 10^3 \frac{\text{J}}{\text{mol}}$$

$$W_{12} := -Q_{12} \quad W_{12} = -6.006 \times 10^3 \frac{\text{J}}{\text{mol}}$$

$$P_3 := 2 \text{ bar}$$

$$V_3 := V_2$$

$$T_3 := \frac{P_3 \cdot V_3}{R}$$

$$T_3 = 400 \text{ K}$$

**Step 23: Isochoric**

$$\Delta U_{23} := C_V \cdot (T_3 - T_2) \quad \Delta U_{23} = -4.157 \times 10^3 \frac{\text{J}}{\text{mol}}$$

$$\Delta H_{23} := C_P \cdot (T_3 - T_2) \quad \Delta H_{23} = -5.82 \times 10^3 \frac{\text{J}}{\text{mol}}$$

$$Q_{23} := C_V \cdot (T_3 - T_2) \quad Q_{23} = -4.157 \times 10^3 \frac{\text{J}}{\text{mol}}$$

$$W_{23} := 0 \frac{\text{J}}{\text{mol}} \quad W_{23} = 0 \frac{\text{J}}{\text{mol}}$$

$$P_4 = 2 \text{ bar} \quad T_4 = 378.831 \text{ K} \quad V_4 := \frac{R \cdot T_4}{P_4} \quad V_4 = 0.016 \frac{\text{m}^3}{\text{mol}}$$

**Step 34: Isobaric**

$$\Delta U_{34} := C_V \cdot (T_4 - T_3) \quad \Delta U_{34} = -439.997 \frac{\text{J}}{\text{mol}}$$

$$\Delta H_{34} := C_P \cdot (T_4 - T_3) \quad \Delta H_{34} = -615.996 \frac{\text{J}}{\text{mol}}$$

$$Q_{34} := C_P \cdot (T_4 - T_3) \quad Q_{34} = -615.996 \frac{\text{J}}{\text{mol}}$$

$$W_{34} := -R \cdot (T_4 - T_3) \quad W_{34} = 175.999 \frac{\text{J}}{\text{mol}}$$

**3.10 For all parts of this problem:  $T_2 = T_1$  and**

**$\Delta U = \Delta H = 0$  Also  $Q = -\text{Work}$  and all that remains is to calculate Work. Symbol  $V$  is used for total volume in this problem.**

$$P_1 := 1 \cdot \text{bar}$$

$$P_2 := 12 \cdot \text{bar}$$

$$V_1 := 12 \cdot \text{m}^3$$

$$V_2 := 1 \cdot \text{m}^3$$



$$(a) \quad \text{Work} = n \cdot R \cdot T \cdot \ln\left(\frac{P_2}{P_1}\right) \quad \text{Work} := P_1 \cdot V_1 \cdot \ln\left(\frac{P_2}{P_1}\right)$$

$$\text{Work} = 2982 \text{ kJ} \quad \text{Ans.}$$

(b) Step 1: adiabatic compression to  $P_2$

$$\gamma := \frac{5}{3} \quad V_i := V_1 \cdot \left(\frac{P_1}{P_2}\right)^{\frac{1}{\gamma}} \quad (\text{intermediate } V) \quad V_i = 2.702 \text{ m}^3$$

$$W_1 := \frac{P_2 \cdot V_i - P_1 \cdot V_1}{\gamma - 1} \quad W_1 = 3063 \text{ kJ}$$

Step 2: cool at const  $P_2$  to  $V_2$

$$W_2 := -P_2 \cdot (V_2 - V_i) \quad W_2 = 2042 \text{ kJ}$$

$$\text{Work} := W_1 + W_2 \quad \text{Work} = 5106 \text{ kJ} \quad \text{Ans.}$$

(c) Step 1: adiabatic compression to  $V_2$

$$P_i := P_1 \cdot \left(\frac{V_1}{V_2}\right)^{\gamma} \quad (\text{intermediate } P) \quad P_i = 62.898 \text{ bar}$$

$$W_1 := \frac{P_i \cdot V_2 - P_1 \cdot V_1}{\gamma - 1} \quad W_1 = 7635 \text{ kJ}$$

Step 2: No work.

$$\text{Work} := W_1 \quad \text{Work} = 7635 \text{ kJ} \quad \text{Ans.}$$

(d) Step 1: heat at const  $V_1$  to  $P_2$   $W_1 = 0$

Step 2: cool at const  $P_2$  to  $V_2$

$$W_2 := -P_2 \cdot (V_2 - V_1) \quad \text{Work} := W_2 \quad \text{Work} = 13200 \text{ kJ} \quad \text{Ans.}$$

(e) Step 1: cool at const  $P_1$  to  $V_2$

$$W_1 := -P_1 \cdot (V_2 - V_1) \quad W_1 = 1100 \text{ kJ}$$

Step 2: heat at const  $V_2$  to  $P_2$        $W_2 = 0$

$$\text{Work} := W_1$$

$$\text{Work} = 1100 \text{ kJ}$$

Ans.

3.17 (a) No work is done; no heat is transferred.

$$\Delta U^t = \Delta T = 0 \quad T_2 = T_1 = 100 \cdot \text{degC} \quad \text{Not reversible}$$

(b) The gas is returned to its initial state by isothermal compression.

$$\text{Work} = n \cdot R \cdot T \cdot \ln\left(\frac{V_1}{V_2}\right) \quad \text{but} \quad n \cdot R \cdot T = P_2 \cdot V_2$$

$$V_1 := 4 \cdot \text{m}^3$$

$$V_2 := \frac{4}{3} \cdot \text{m}^3$$

$$P_2 := 6 \cdot \text{bar}$$

$$\text{Work} := P_2 \cdot V_2 \cdot \ln\left(\frac{V_1}{V_2}\right)$$

$$\text{Work} = 878.9 \text{ kJ} \quad \text{Ans.}$$

3.18 (a)  $P_1 := 100 \cdot \text{kPa}$

$P_2 := 500 \cdot \text{kPa}$

$T_1 := 303.15 \cdot \text{K}$

$$C_P := \frac{7}{2} \cdot R$$

$$C_V := \frac{5}{2} \cdot R$$

$$\gamma := \frac{C_P}{C_V}$$

Adiabatic compression from point 1 to point 2:

$$Q_{12} := 0 \cdot \frac{\text{kJ}}{\text{mol}} \quad \Delta U_{12} = W_{12} = C_V \cdot \Delta T_{12} \quad T_2 := T_1 \cdot \left(\frac{P_2}{P_1}\right)^{\frac{\gamma-1}{\gamma}}$$

$$\Delta U_{12} := C_V \cdot (T_2 - T_1) \quad \Delta H_{12} := C_P \cdot (T_2 - T_1) \quad W_{12} := \Delta U_{12}$$

$$\Delta U_{12} = 3.679 \frac{\text{kJ}}{\text{mol}}$$

$$\Delta H_{12} = 5.15 \frac{\text{kJ}}{\text{mol}}$$

$$W_{12} = 3.679 \frac{\text{kJ}}{\text{mol}}$$

Ans.

Cool at  $P_2$  from point 2 to point 3:

$$T_3 := T_1 \quad \Delta H_{23} := C_P \cdot (T_3 - T_2) \quad Q_{23} := \Delta H_{23}$$

$$\Delta U_{23} := C_V \cdot (T_3 - T_2) \quad W_{23} := \Delta U_{23} - Q_{23}$$

$$\Delta H_{23} = -5.15 \frac{\text{kJ}}{\text{mol}}$$

$$\Delta U_{23} = -3.679 \frac{\text{kJ}}{\text{mol}} \quad \text{Ans.}$$

$$Q_{23} = -5.15 \frac{\text{kJ}}{\text{mol}}$$

$$W_{23} = 1.471 \frac{\text{kJ}}{\text{mol}} \quad \text{Ans.}$$

**Isothermal expansion from point 3 to point 1:**

$$\Delta U_{31} = \Delta H_{31} = 0 \quad P_3 := P_2 \quad W_{31} := R \cdot T_3 \cdot \ln\left(\frac{P_1}{P_3}\right)$$

$$Q_{31} := -W_{31}$$

$$W_{31} = -4.056 \frac{\text{kJ}}{\text{mol}}$$

$$Q_{31} = 4.056 \frac{\text{kJ}}{\text{mol}} \quad \text{Ans.}$$

**FOR THE CYCLE:**  $\Delta U = \Delta H = 0$

$$Q := Q_{12} + Q_{23} + Q_{31}$$

$$\text{Work} := W_{12} + W_{23} + W_{31}$$

$$Q = -1.094 \frac{\text{kJ}}{\text{mol}}$$

$$\text{Work} = 1.094 \frac{\text{kJ}}{\text{mol}}$$

**(b) If each step that is 80% efficient accomplishes the same change of state, all property values are unchanged, and the delta H and delta U values are the same as in part (a). However, the Q and W values change.**

$$\text{Step 12: } W_{12} := \frac{W_{12}}{0.8}$$

$$W_{12} = 4.598 \frac{\text{kJ}}{\text{mol}}$$

$$Q_{12} := \Delta U_{12} - W_{12}$$

$$Q_{12} = -0.92 \frac{\text{kJ}}{\text{mol}}$$

$$\text{Step 23: } W_{23} := \frac{W_{23}}{0.8}$$

$$W_{23} = 1.839 \frac{\text{kJ}}{\text{mol}}$$

$$Q_{23} := \Delta U_{23} - W_{23}$$

$$Q_{23} = -5.518 \frac{\text{kJ}}{\text{mol}}$$

$$\text{Step 31: } W_{31} := W_{31} \cdot 0.8$$

$$W_{31} = -3.245 \frac{\text{kJ}}{\text{mol}}$$

$$Q_{31} := -W_{31}$$

$$Q_{31} = 3.245 \frac{\text{kJ}}{\text{mol}}$$

**FOR THE CYCLE:**

$$Q := Q_{12} + Q_{23} + Q_{31}$$

$$Q = -3.192 \frac{\text{kJ}}{\text{mol}}$$

$$\text{Work} := W_{12} + W_{23} + W_{31}$$

$$\text{Work} = 3.192 \frac{\text{kJ}}{\text{mol}}$$

**3.19 Here, V represents total volume.**

$$P_1 := 1000 \cdot \text{kPa}$$

$$V_1 := 1 \cdot \text{m}^3$$

$$V_2 := 5 \cdot V_1$$

$$T_1 := 600 \cdot \text{K}$$

$$C_P := 21 \cdot \frac{\text{joule}}{\text{mol} \cdot \text{K}}$$

$$C_V := C_P - R$$

$$\gamma := \frac{C_P}{C_V}$$

**(a) Isothermal:**

$$\text{Work} = n \cdot R \cdot T_1 \cdot \ln\left(\frac{V_1}{V_2}\right) \quad P_2 := P_1 \cdot \frac{V_1}{V_2}$$

$$T_2 := T_1$$

$$T_2 = 600 \text{ K}$$

$$P_2 = 200 \text{ kPa}$$

**Ans.**

$$\text{Work} := P_1 \cdot V_1 \cdot \ln\left(\frac{V_1}{V_2}\right)$$

$$\text{Work} = -1609 \text{ kJ} \quad \text{Ans.}$$

**(b) Adiabatic:**

$$P_2 := P_1 \cdot \left(\frac{V_1}{V_2}\right)^\gamma$$

$$T_2 := T_1 \cdot \frac{P_2}{P_1} \cdot \frac{V_2}{V_1}$$

$$T_2 = 208.96 \text{ K}$$

$$P_2 = 69.65 \text{ kPa}$$

**Ans.**

$$\text{Work} := \frac{P_2 \cdot V_2 - P_1 \cdot V_1}{\gamma - 1}$$

$$\text{Work} = -994.4 \text{ kJ} \quad \text{Ans.}$$

**(c) Restrained adiabatic:**

$$\text{Work} = \Delta U = -P_{\text{ext}} \cdot V$$

$$P_{\text{ext}} := 100 \cdot \text{kPa}$$

$$\text{Work} := -P_{\text{ext}} \cdot (V_2 - V_1)$$

$$\text{Work} = -400 \text{ kJ} \quad \text{Ans.}$$

$$n := \frac{P_1 \cdot V_1}{R \cdot T_1}$$

$$\Delta U = n \cdot C_V \cdot T$$

$$T_2 := \frac{\text{Work}}{n \cdot C_V} + T_1$$

$$T_2 = 442.71 \text{ K}$$

**Ans.**

$$P_2 := P_1 \cdot \frac{V_1}{V_2} \cdot \frac{T_2}{T_1}$$

$$P_2 = 147.57 \text{ kPa}$$

**Ans.**

3.20

$$T_1 := 423.15 \cdot \text{K}$$

$$P_1 := 8 \cdot \text{bar}$$

$$P_3 := 3 \cdot \text{bar}$$

$$C_p := \frac{7}{2} \cdot R$$

$$C_v := \frac{5}{2} \cdot R$$

$$T_2 := T_1$$

$$T_3 := 323.15 \cdot \text{K}$$

Step 12:

$$\Delta H_{12} := 0 \cdot \frac{\text{kJ}}{\text{mol}}$$

$$\Delta U_{12} := 0 \cdot \frac{\text{kJ}}{\text{mol}}$$

If  $r = \frac{V_1}{V_2} = \frac{V_1}{V_3}$

Then  $r := \frac{T_1}{T_3} \cdot \frac{P_3}{P_1}$

$$W_{12} := R \cdot T_1 \cdot \ln(r)$$

$$W_{12} = -2.502 \frac{\text{kJ}}{\text{mol}}$$

$$Q_{12} := -W_{12}$$

$$Q_{12} = 2.502 \frac{\text{kJ}}{\text{mol}}$$

Step 23:

$$W_{23} := 0 \cdot \frac{\text{kJ}}{\text{mol}}$$

$$\Delta U_{23} := C_v \cdot (T_3 - T_2)$$

$$Q_{23} := \Delta U_{23}$$

$$\Delta H_{23} := C_p \cdot (T_3 - T_2)$$

$$Q_{23} = -2.079 \frac{\text{kJ}}{\text{mol}}$$

$$\Delta U_{23} = -2.079 \frac{\text{kJ}}{\text{mol}}$$

$$\Delta H_{23} = -2.91 \frac{\text{kJ}}{\text{mol}}$$

Process:

$$\text{Work} := W_{12} + W_{23}$$

$$\text{Work} = -2.502 \frac{\text{kJ}}{\text{mol}} \quad \text{Ans.}$$

$$Q := Q_{12} + Q_{23}$$

$$Q = 0.424 \frac{\text{kJ}}{\text{mol}} \quad \text{Ans.}$$

$$\Delta H := \Delta H_{12} + \Delta H_{23}$$

$$\Delta H = -2.91 \frac{\text{kJ}}{\text{mol}} \quad \text{Ans.}$$

$$\Delta U := \Delta U_{12} + \Delta U_{23}$$

$$\Delta U = -2.079 \frac{\text{kJ}}{\text{mol}} \quad \text{Ans.}$$

3.21 By Eq. (2.32a), unit-mass basis:  $\text{molwt} := 28 \frac{\text{gm}}{\text{mol}}$   $\Delta H + \frac{1}{2} \cdot \Delta u^2 = 0$

But  $\Delta H = C_p \cdot \Delta T$  Whence  $\Delta T = \frac{-(u_2^2 - u_1^2)}{2 \cdot C_p}$

$C_p := \frac{7}{2} \cdot \frac{R}{\text{molwt}}$   $u_1 := 2.5 \cdot \frac{\text{m}}{\text{s}}$   $u_2 := 50 \cdot \frac{\text{m}}{\text{s}}$   $t_1 := 150 \cdot \text{degC}$

$t_2 := t_1 - \frac{u_2^2 - u_1^2}{2 \cdot C_p}$   $t_2 = 148.8 \text{ degC}$  **Ans.**

3.22  $C_p := \frac{7}{2} \cdot R$   $C_v := \frac{5}{2} \cdot R$   $T_1 := 303.15 \cdot \text{K}$   $T_3 := 403.15 \cdot \text{K}$   
 $P_1 := 1 \cdot \text{bar}$   $P_3 := 10 \cdot \text{bar}$

$\Delta U := C_v \cdot (T_3 - T_1)$   $\Delta H := C_p \cdot (T_3 - T_1)$

$\Delta U = 2.079 \frac{\text{kJ}}{\text{mol}}$  **Ans.**  $\Delta H = 2.91 \frac{\text{kJ}}{\text{mol}}$  **Ans.**

Each part consists of two steps, 12 & 23.

(a)  $T_2 := T_3$   $P_2 := P_1 \cdot \frac{T_2}{T_1}$

$W_{23} := R \cdot T_2 \cdot \ln\left(\frac{P_3}{P_2}\right)$   $\text{Work} := W_{23}$   
 $\text{Work} = 6.762 \frac{\text{kJ}}{\text{mol}}$  **Ans.**

$Q := \Delta U - \text{Work}$

$Q = -4.684 \frac{\text{kJ}}{\text{mol}}$  **Ans.**

(b)  $P_2 := P_1$        $T_2 := T_3$

$$\Delta U_{12} := C_V \cdot (T_2 - T_1)$$

$$\Delta H_{12} := C_P \cdot (T_2 - T_1)$$

$$Q_{12} := \Delta H_{12}$$

$$W_{12} := \Delta U_{12} - Q_{12}$$

$$W_{12} = -0.831 \frac{\text{kJ}}{\text{mol}}$$

$$W_{23} := R \cdot T_2 \cdot \ln\left(\frac{P_3}{P_2}\right)$$

$$W_{23} = 7.718 \frac{\text{kJ}}{\text{mol}}$$

$$\text{Work} := W_{12} + W_{23}$$

$$\text{Work} = 6.886 \frac{\text{kJ}}{\text{mol}} \quad \text{Ans.}$$

$$Q := \Delta U - \text{Work}$$

$$Q = -4.808 \frac{\text{kJ}}{\text{mol}} \quad \text{Ans.}$$

(c)  $T_2 := T_1$        $P_2 := P_3$

$$W_{12} := R \cdot T_1 \cdot \ln\left(\frac{P_2}{P_1}\right)$$

$$\Delta H_{23} := C_P \cdot (T_3 - T_2)$$

$$Q_{23} := \Delta H_{23}$$

$$\Delta U_{23} := C_V \cdot (T_3 - T_2)$$

$$W_{23} := \Delta U_{23} - Q_{23}$$

$$\text{Work} := W_{12} + W_{23}$$

$$\text{Work} = 4.972 \frac{\text{kJ}}{\text{mol}} \quad \text{Ans.}$$

$$Q := \Delta U - \text{Work}$$

$$Q = -2.894 \frac{\text{kJ}}{\text{mol}} \quad \text{Ans.}$$

**For the second set of heat-capacity values, answers are (kJ/mol):**

$$\Delta U = 1.247 \quad \Delta U = 2.079$$

(a)       $\text{Work} = 6.762$        $Q = -5.515$

(b)       $\text{Work} = 6.886$        $Q = -5.639$

(c)       $\text{Work} = 4.972$        $Q = -3.725$

3.23

$T_1 := 303.15 \cdot \text{K}$

$T_2 := T_1$

$T_3 := 393.15 \cdot \text{K}$

$P_1 := 1 \cdot \text{bar}$

$P_3 := 12 \cdot \text{bar}$

$C_P := \frac{7}{2} \cdot R$

$C_V := \frac{5}{2} \cdot R$

**For the process:**

$\Delta U := C_V \cdot (T_3 - T_1)$

$\Delta H := C_P \cdot (T_3 - T_1)$

$\Delta U = 1.871 \frac{\text{kJ}}{\text{mol}}$

$\Delta H = 2.619 \frac{\text{kJ}}{\text{mol}}$  **Ans.**

**Step 12:**

$P_2 := P_3 \cdot \frac{T_1}{T_3}$

$W_{12} := R \cdot T_1 \cdot \ln\left(\frac{P_2}{P_1}\right)$

$W_{12} = 5.608 \frac{\text{kJ}}{\text{mol}}$

$Q_{12} := -W_{12}$

$Q_{12} = -5.608 \frac{\text{kJ}}{\text{mol}}$

**Step 23:**

$W_{23} := 0 \cdot \frac{\text{kJ}}{\text{mol}}$

$Q_{23} := \Delta U$

**For the process:**

$\text{Work} := W_{12} + W_{23}$

$Q := Q_{12} + Q_{23}$

$\text{Work} = 5.608 \frac{\text{kJ}}{\text{mol}}$

$Q = -3.737 \frac{\text{kJ}}{\text{mol}}$  **Ans.**

3.24  $W_{12} = 0$   $\text{Work} = W_{23} = -P_2(V_3 - V_2) = -R \cdot (T_3 - T_2)$

**But**  $T_3 = T_1$  **So...**  $\text{Work} = R \cdot (T_2 - T_1)$

**Also**  $W = R \cdot T_1 \cdot \ln\left(\frac{P}{P_1}\right)$  **Therefore**

$\ln\left(\frac{P}{P_1}\right) = \frac{T_2 - T_1}{T_1}$

$T_2 := 350 \cdot \text{K}$

$T_1 := 800 \cdot \text{K}$

$P_1 := 4 \cdot \text{bar}$

$P := P_1 \cdot \exp\left(\frac{T_2 - T_1}{T_1}\right)$

$P = 2.279 \text{ bar}$

**Ans.**



3.25  $V_A := 256 \cdot \text{cm}^3$       Define:  $\frac{\Delta P}{P_1} = r$        $r := -0.0639$

Assume ideal gas; let  $V$  represent total volume:

$P_1 \cdot V_B = P_2 \cdot (V_A + V_B)$       From this one finds:

$\frac{\Delta P}{P_1} = \frac{-V_A}{V_A + V_B}$        $V_B := \frac{-V_A \cdot (r + 1)}{r}$        $V_B = 3750.3 \text{ cm}^3$       Ans.

3.26  $T_1 := 300 \cdot \text{K}$        $P_1 := 1 \cdot \text{atm}$        $C_P := \frac{7}{2} \cdot R$        $C_V := C_P - R$        $\gamma := \frac{C_P}{C_V}$

The process occurring in section B is a reversible, adiabatic compression. Let

$P(\text{final}) = P_2$        $T_A(\text{final}) = T_A$        $T_B(\text{final}) = T_B$

$n_A = n_B$       Since the total volume is constant,

$\frac{2 \cdot n_A \cdot R \cdot T_1}{P_1} = \frac{n_A \cdot R \cdot (T_A + T_B)}{P_2}$       or       $\frac{2 \cdot T_1}{P_1} = \frac{T_A + T_B}{P_2}$       (1)

(a)  $P_2 := 1.25 \cdot \text{atm}$        $T_B := T_1 \cdot \left( \frac{P_2}{P_1} \right)^{\frac{\gamma-1}{\gamma}}$       (2)

$T_A := 2 \cdot T_1 \cdot \frac{P_2}{P_1} - T_B$        $Q = n_A \cdot (\Delta U_A + \Delta U_B)$

Define  $q = \frac{Q}{n_A}$        $q := C_V \cdot (T_A + T_B - 2 \cdot T_1)$       (3)

$T_B = 319.75 \text{ K}$        $T_A = 430.25 \text{ K}$        $q = 3.118 \frac{\text{kJ}}{\text{mol}}$       Ans.

(b) **Combine Eqs. (1) & (2) to eliminate the ratio of pressures:**

$$T_A := 425 \cdot \text{K}$$

(guess)  $T_B := 300 \cdot \text{K}$

Given 
$$T_B = T_1 \cdot \left( \frac{T_A + T_B}{2 \cdot T_1} \right)^{\frac{\gamma-1}{\gamma}}$$
  $T_B := \text{Find}(T_B)$

$T_B = 319.02 \text{ K}$  **Ans.**

$$P_2 := P_1 \cdot \left( \frac{T_A + T_B}{2 \cdot T_1} \right)^{\frac{\gamma}{\gamma-1}} \quad (1)$$
  $P_2 = 1.24 \text{ atm}$  **Ans.**

$$q := C_V \cdot (T_A + T_B - 2 \cdot T_1)$$
  $q = 2.993 \frac{\text{kJ}}{\text{mol}}$  **Ans.**

(c)  $T_B := 325 \cdot \text{K}$  **By Eq. (2),**

$$P_2 := P_1 \cdot \left( \frac{T_B}{T_1} \right)^{\frac{\gamma}{\gamma-1}}$$
  $P_2 = 1.323 \text{ atm}$  **Ans.**

$$T_A := 2 \cdot T_1 \cdot \frac{P_2}{P_1} - T_B \quad (1)$$
  $T_A = 469 \text{ K}$  **Ans.**

$$q := C_V \cdot (T_A + T_B - 2 \cdot T_1)$$
  $q = 4.032 \frac{\text{kJ}}{\text{mol}}$  **Ans.**

(d) **Eliminate  $T_A + T_B$  from Eqs. (1) & (3):**

$$q := 3 \cdot \frac{\text{kJ}}{\text{mol}} \quad P_2 := \frac{q \cdot P_1}{2 \cdot T_1 \cdot C_V} + P_1$$
  $P_2 = 1.241 \text{ atm}$  **Ans.**

$$T_B := T_1 \cdot \left( \frac{P_2}{P_1} \right)^{\frac{\gamma-1}{\gamma}} \quad (2)$$
  $T_B = 319.06 \text{ K}$  **Ans.**

$$T_A := 2 \cdot T_1 \cdot \frac{P_2}{P_1} - T_B \quad (1)$$
  $T_A = 425.28 \text{ K}$  **Ans.**

$$3.30 \quad B := -242.5 \cdot \frac{\text{cm}^3}{\text{mol}} \quad C := 25200 \cdot \frac{\text{cm}^6}{\text{mol}^2} \quad T := 373.15 \cdot \text{K}$$

$$P_1 := 1 \cdot \text{bar}$$

$$P_2 := 55 \cdot \text{bar}$$

$$B' := \frac{B}{R \cdot T}$$

$$B' = -7.817 \times 10^{-3} \frac{1}{\text{bar}}$$

$$C' := \frac{C - B^2}{R^2 \cdot T^2}$$

$$C' = -3.492 \times 10^{-5} \frac{1}{\text{bar}^2}$$

(a) Solve virial eqn. for initial V.

$$\text{Guess:} \quad V_1 := \frac{R \cdot T}{P_1}$$

$$\text{Given} \quad \frac{P_1 \cdot V_1}{R \cdot T} = 1 + \frac{B}{V_1} + \frac{C}{V_1^2} \quad V_1 := \text{Find}(V_1) \quad V_1 = 30780 \frac{\text{cm}^3}{\text{mol}}$$

Solve virial eqn. for final V.

$$\text{Guess:} \quad V_2 := \frac{R \cdot T}{P_2}$$

$$\text{Given} \quad \frac{P_2 \cdot V_2}{R \cdot T} = 1 + \frac{B}{V_2} + \frac{C}{V_2^2} \quad V_2 := \text{Find}(V_2) \quad V_2 = 241.33 \frac{\text{cm}^3}{\text{mol}}$$

Eliminate P from Eq. (1.3) by the virial equation:

$$\text{Work} := -R \cdot T \cdot \int_{V_1}^{V_2} \left( 1 + \frac{B}{V} + \frac{C}{V^2} \right) \cdot \frac{1}{V} dV \quad \text{Work} = 12.62 \frac{\text{kJ}}{\text{mol}} \quad \text{Ans.}$$

(b) Eliminate dV from Eq. (1.3) by the virial equation in P:

$$dV = R \cdot T \cdot \left( \frac{-1}{P^2} + C' \right) \cdot dP \quad W := -R \cdot T \cdot \int_{P_1}^{P_2} \left( \frac{-1}{P} + C' \cdot P \right) dP$$

$$W = 12.596 \frac{\text{kJ}}{\text{mol}} \quad \text{Ans.}$$

**Note: The answers to (a) & (b) differ because the relations between the two sets of parameters are exact only for infinite series.**

3.32  $T_c := 282.3 \cdot K$        $T := 298.15 \cdot K$        $T_r := \frac{T}{T_c}$        $T_r = 1.056$

$P_c := 50.4 \cdot \text{bar}$        $P := 12 \cdot \text{bar}$        $P_r := \frac{P}{P_c}$        $P_r = 0.238$

$\omega := 0.087$       (guess)

(a)  $B := -140 \cdot \frac{\text{cm}^3}{\text{mol}}$        $C := 7200 \cdot \frac{\text{cm}^6}{\text{mol}^2}$        $V := \frac{R \cdot T}{P}$        $V = 2066 \frac{\text{cm}^3}{\text{mol}}$

Given  $\frac{P \cdot V}{R \cdot T} = 1 + \frac{B}{V} + \frac{C}{V^2}$

$V := \text{Find}(V)$        $V = 1919 \frac{\text{cm}^3}{\text{mol}}$        $Z := \frac{P \cdot V}{R \cdot T}$        $Z = 0.929$       **Ans.**

(b)  $B_0 := 0.083 - \frac{0.422}{T_r^{1.6}}$        $B_0 = -0.304$

$B_1 := 0.139 - \frac{0.172}{T_r^{4.2}}$        $B_1 = 2.262 \times 10^{-3}$

$Z := 1 + (B_0 + \omega \cdot B_1) \cdot \frac{P_r}{T_r}$        $Z = 0.932$        $V := \frac{Z \cdot R \cdot T}{P}$        $V = 1924 \frac{\text{cm}^3}{\text{mol}}$       **Ans.**

(c) For Redlich/Kwong EOS:

$\sigma := 1$        $\varepsilon := 0$        $\Omega := 0.08664$        $\Psi := 0.42748$       **Table 3.1**

$\alpha(T_r) := T_r^{-0.5}$       **Table 3.1**       $q(T_r) := \frac{\Psi \alpha(T_r)}{\Omega \cdot T_r}$       **Eq. (3.54)**

$\beta(T_r, P_r) := \frac{\Omega \cdot P_r}{T_r}$       **Eq. (3.53)**

**Calculate Z**                      **Guess:**                       $Z := 0.9$

Given                      **Eq. (3.52)**

$$Z = 1 + \beta(T_r, P_r) - q(T_r) \cdot \beta(T_r, P_r) \cdot \frac{Z - \beta(T_r, P_r)}{(Z + \varepsilon \beta(T_r, P_r)) \cdot (Z + \sigma \beta(T_r, P_r))}$$

$$Z := \text{Find}(Z) \quad Z = 0.928 \quad V := \frac{Z \cdot R \cdot T}{P} \quad V = 1916.5 \frac{\text{cm}^3}{\text{mol}} \quad \text{Ans.}$$

**(d) For SRK EOS:**

$$\sigma := 1 \quad \varepsilon := 0 \quad \Omega := 0.08664 \quad \Psi := 0.42748 \quad \text{Table 3.1}$$

$$\alpha(T_r, \omega) := \left[ 1 + (0.480 + 1.574\omega - 0.176\omega^2) \cdot \left( 1 - T_r^{\frac{1}{2}} \right) \right]^2 \quad \text{Table 3.1}$$

$$q(T_r) := \frac{\Psi \alpha(T_r, \omega)}{\Omega \cdot T_r} \quad \text{Eq. (3.54)} \quad \beta(T_r, P_r) := \frac{\Omega \cdot P_r}{T_r} \quad \text{Eq. (3.53)}$$

**Calculate Z**                      **Guess:**                       $Z := 0.9$

Given                      **Eq. (3.52)**

$$Z = 1 + \beta(T_r, P_r) - q(T_r) \cdot \beta(T_r, P_r) \cdot \frac{Z - \beta(T_r, P_r)}{(Z + \varepsilon \beta(T_r, P_r)) \cdot (Z + \sigma \beta(T_r, P_r))}$$

$$Z := \text{Find}(Z) \quad Z = 0.928 \quad V := \frac{Z \cdot R \cdot T}{P} \quad V = 1918 \frac{\text{cm}^3}{\text{mol}} \quad \text{Ans.}$$

**(e) For Peng/Robinson EOS:**

$$\sigma := 1 + \sqrt{2} \quad \varepsilon := 1 - \sqrt{2} \quad \Omega := 0.07779 \quad \Psi := 0.45724 \quad \text{Table 3.1}$$

$$\alpha(T_r, \omega) := \left[ 1 + (0.37464 + 1.54226\omega - 0.26992\omega^2) \cdot \left( 1 - T_r^{\frac{1}{2}} \right) \right]^2 \quad \text{Table 3.1}$$

$$q(T_r) := \frac{\Psi \alpha(T_r, \omega)}{\Omega \cdot T_r} \quad \text{Eq. (3.54)} \quad \beta(T_r, P_r) := \frac{\Omega \cdot P_r}{T_r} \quad \text{Eq. (3.53)}$$

**Calculate Z**      **Guess:**       $Z := 0.9$

Given      **Eq. (3.52)**

$$Z = 1 + \beta(T_r, P_r) - q(T_r) \cdot \beta(T_r, P_r) \cdot \frac{Z - \beta(T_r, P_r)}{(Z + \varepsilon \beta(T_r, P_r)) \cdot (Z + \sigma \beta(T_r, P_r))}$$

$Z := \text{Find}(Z)$        $Z = 0.92$        $V := \frac{Z \cdot R \cdot T}{P}$        $V = 1900.6 \frac{\text{cm}^3}{\text{mol}}$       **Ans.**

**3.33**       $T_c := 305.3 \cdot \text{K}$        $T := 323.15 \cdot \text{K}$        $T_r := \frac{T}{T_c}$        $T_r = 1.058$

$P_c := 48.72 \cdot \text{bar}$        $P := 15 \cdot \text{bar}$        $P_r := \frac{P}{P_c}$        $P_r = 0.308$

$\omega := 0.100$       **(guess)**

(a)       $B := -156.7 \cdot \frac{\text{cm}^3}{\text{mol}}$        $C := 9650 \cdot \frac{\text{cm}^6}{\text{mol}^2}$        $V := \frac{R \cdot T}{P}$        $V = 1791 \frac{\text{cm}^3}{\text{mol}}$

Given       $\frac{P \cdot V}{R \cdot T} = 1 + \frac{B}{V} + \frac{C}{V^2}$

$V := \text{Find}(V)$        $V = 1625 \frac{\text{cm}^3}{\text{mol}}$        $Z := \frac{P \cdot V}{R \cdot T}$        $Z = 0.907$       **Ans.**

(b)       $B_0 := 0.083 - \frac{0.422}{T_r^{1.6}}$        $B_0 = -0.302$

$B_1 := 0.139 - \frac{0.172}{T_r^{4.2}}$        $B_1 = 3.517 \times 10^{-3}$

$Z := 1 + (B_0 + \omega \cdot B_1) \cdot \frac{P_r}{T_r}$        $Z = 0.912$        $V := \frac{Z \cdot R \cdot T}{P}$        $V = 1634 \frac{\text{cm}^3}{\text{mol}}$       **Ans.**

(c)      **For Redlich/Kwong EOS:**

$\sigma := 1$        $\varepsilon := 0$        $\Omega := 0.08664$        $\Psi := 0.42748$       **Table 3.1**

$$\alpha(T_r) := T_r^{-0.5} \quad \text{Table 3.1} \quad q(T_r) := \frac{\Psi \alpha(T_r)}{\Omega \cdot T_r} \quad \text{Eq. (3.54)}$$

$$\beta(T_r, P_r) := \frac{\Omega \cdot P_r}{T_r} \quad \text{Eq. (3.53)}$$

**Calculate Z**      **Guess:**       $Z := 0.9$

Given      **Eq. (3.52)**

$$Z = 1 + \beta(T_r, P_r) - q(T_r) \cdot \beta(T_r, P_r) \cdot \frac{Z - \beta(T_r, P_r)}{(Z + \varepsilon \beta(T_r, P_r)) \cdot (Z + \sigma \beta(T_r, P_r))}$$

$$Z := \text{Find}(Z) \quad Z = 0.906 \quad V := \frac{Z \cdot R \cdot T}{P} \quad V = 1622.7 \frac{\text{cm}^3}{\text{mol}} \quad \text{Ans.}$$

**(d) For SRK EOS:**

$$\sigma := 1 \quad \varepsilon := 0 \quad \Omega := 0.08664 \quad \Psi := 0.42748 \quad \text{Table 3.1}$$

$$\alpha(T_r, \omega) := \left[ 1 + (0.480 + 1.574\omega - 0.176\omega^2) \cdot \left( 1 - T_r^{\frac{1}{2}} \right) \right]^2 \quad \text{Table 3.1}$$

$$q(T_r) := \frac{\Psi \alpha(T_r, \omega)}{\Omega \cdot T_r} \quad \text{Eq. (3.54)} \quad \beta(T_r, P_r) := \frac{\Omega \cdot P_r}{T_r} \quad \text{Eq. (3.53)}$$

**Calculate Z**      **Guess:**       $Z := 0.9$

Given      **Eq. (3.52)**

$$Z = 1 + \beta(T_r, P_r) - q(T_r) \cdot \beta(T_r, P_r) \cdot \frac{Z - \beta(T_r, P_r)}{(Z + \varepsilon \beta(T_r, P_r)) \cdot (Z + \sigma \beta(T_r, P_r))}$$

$$Z := \text{Find}(Z) \quad Z = 0.907 \quad V := \frac{Z \cdot R \cdot T}{P} \quad V = 1624.8 \frac{\text{cm}^3}{\text{mol}} \quad \text{Ans.}$$

**(e) For Peng/Robinson EOS:**

$$\sigma := 1 + \sqrt{2} \quad \varepsilon := 1 - \sqrt{2} \quad \Omega := 0.07779 \quad \Psi := 0.45724 \quad \text{Table 3.1}$$

$$\alpha(T_r, \omega) := \left[ 1 + (0.37464 + 1.54226\omega - 0.26992\omega^2) \cdot \left( 1 - T_r^{\frac{1}{2}} \right) \right]^2 \quad \text{Table 3.1}$$

$$q(T_r) := \frac{\Psi \alpha(T_r, \omega)}{\Omega \cdot T_r} \quad \text{Eq. (3.54)} \quad \beta(T_r, P_r) := \frac{\Omega \cdot P_r}{T_r} \quad \text{Eq. (3.53)}$$

Calculate Z      Guess:      Z := 0.9

Given      Eq. (3.52)

$$Z = 1 + \beta(T_r, P_r) - q(T_r) \cdot \beta(T_r, P_r) \cdot \frac{Z - \beta(T_r, P_r)}{(Z + \varepsilon \beta(T_r, P_r)) \cdot (Z + \sigma \beta(T_r, P_r))}$$

$$Z := \text{Find}(Z) \quad Z = 0.896 \quad V := \frac{Z \cdot R \cdot T}{P} \quad V = 1605.5 \frac{\text{cm}^3}{\text{mol}} \quad \text{Ans.}$$

$$3.34 \quad T_c := 318.7 \cdot \text{K} \quad T := 348.15 \cdot \text{K} \quad T_r := \frac{T}{T_c} \quad T_r = 1.092$$

$$P_c := 37.6 \cdot \text{bar} \quad P := 15 \cdot \text{bar} \quad P_r := \frac{P}{P_c} \quad P_r = 0.399$$

$$\omega := 0.286$$

(guess)

$$(a) \quad B := -194 \cdot \frac{\text{cm}^3}{\text{mol}} \quad C := 15300 \cdot \frac{\text{cm}^6}{\text{mol}^2} \quad V := \frac{R \cdot T}{P} \quad V = 1930 \frac{\text{cm}^3}{\text{mol}}$$

$$\text{Given} \quad \frac{P \cdot V}{R \cdot T} = 1 + \frac{B}{V} + \frac{C}{V^2}$$

$$V := \text{Find}(V) \quad V = 1722 \frac{\text{cm}^3}{\text{mol}} \quad Z := \frac{P \cdot V}{R \cdot T} \quad Z = 0.893 \quad \text{Ans.}$$

$$(b) \quad B_0 := 0.083 - \frac{0.422}{T_r^{1.6}} \quad B_0 = -0.283$$



$$B_1 := 0.139 - \frac{0.172}{T_r^{4.2}} \quad B_1 = 0.02$$

$$Z := 1 + (B_0 + \omega \cdot B_1) \cdot \frac{P_r}{T_r} \quad Z = 0.899 \quad V := \frac{Z \cdot R \cdot T}{P} \quad V = 1734 \frac{\text{cm}^3}{\text{mol}} \text{ Ans.}$$

(c) For Redlich/Kwong EOS:

$$\sigma := 1 \quad \varepsilon := 0 \quad \Omega := 0.08664 \quad \Psi := 0.42748 \quad \text{Table 3.1}$$

$$\alpha(T_r) := T_r^{-0.5} \quad \text{Table 3.1} \quad q(T_r) := \frac{\Psi \alpha(T_r)}{\Omega \cdot T_r} \quad \text{Eq. (3.54)}$$

$$\beta(T_r, P_r) := \frac{\Omega \cdot P_r}{T_r} \quad \text{Eq. (3.53)}$$

Calculate Z      Guess:      Z := 0.9

Given      Eq. (3.52)

$$Z = 1 + \beta(T_r, P_r) - q(T_r) \cdot \beta(T_r, P_r) \cdot \frac{Z - \beta(T_r, P_r)}{(Z + \varepsilon \beta(T_r, P_r)) \cdot (Z + \sigma \beta(T_r, P_r))}$$

$$Z := \text{Find}(Z) \quad Z = 0.888 \quad V := \frac{Z \cdot R \cdot T}{P} \quad V = 1714.1 \frac{\text{cm}^3}{\text{mol}} \text{ Ans.}$$

(d) For SRK EOS:

$$\sigma := 1 \quad \varepsilon := 0 \quad \Omega := 0.08664 \quad \Psi := 0.42748 \quad \text{Table 3.1}$$

$$\alpha(T_r, \omega) := \left[ 1 + (0.480 + 1.574\omega - 0.176\omega^2) \cdot \left( 1 - T_r^{\frac{1}{2}} \right) \right]^2 \quad \text{Table 3.1}$$

$$q(T_r) := \frac{\Psi \alpha(T_r, \omega)}{\Omega \cdot T_r} \quad \text{Eq. (3.54)} \quad \beta(T_r, P_r) := \frac{\Omega \cdot P_r}{T_r} \quad \text{Eq. (3.53)}$$

**Calculate Z**      **Guess:**       $Z := 0.9$

Given      **Eq. (3.52)**

$$Z = 1 + \beta(T_r, P_r) - q(T_r) \cdot \beta(T_r, P_r) \cdot \frac{Z - \beta(T_r, P_r)}{(Z + \varepsilon \beta(T_r, P_r)) \cdot (Z + \sigma \beta(T_r, P_r))}$$

$Z := \text{Find}(Z)$        $Z = 0.895$        $V := \frac{Z \cdot R \cdot T}{P}$        $V = 1726.9 \frac{\text{cm}^3}{\text{mol}}$       **Ans.**

**(e) For Peng/Robinson EOS:**

$\sigma := 1 + \sqrt{2}$        $\varepsilon := 1 - \sqrt{2}$        $\Omega := 0.07779$        $\Psi := 0.45724$       **Table 3.1**

$\alpha(T_r, \omega) := \left[ 1 + (0.37464 + 1.54226\omega - 0.26992\omega^2) \cdot \left( 1 - T_r^{\frac{1}{2}} \right) \right]^2$       **Table 3.1**

$q(T_r) := \frac{\Psi \alpha(T_r, \omega)}{\Omega \cdot T_r}$       **Eq. (3.54)**       $\beta(T_r, P_r) := \frac{\Omega \cdot P_r}{T_r}$       **Eq. (3.53)**

**Calculate Z**      **Guess:**       $Z := 0.9$

Given      **Eq. (3.52)**

$$Z = 1 + \beta(T_r, P_r) - q(T_r) \cdot \beta(T_r, P_r) \cdot \frac{Z - \beta(T_r, P_r)}{(Z + \varepsilon \beta(T_r, P_r)) \cdot (Z + \sigma \beta(T_r, P_r))}$$

$Z := \text{Find}(Z)$        $Z = 0.882$        $V := \frac{Z \cdot R \cdot T}{P}$        $V = 1701.5 \frac{\text{cm}^3}{\text{mol}}$       **Ans.**

**3.35**       $T := 523.15 \cdot \text{K}$        $P := 1800 \cdot \text{kPa}$

**(a)**       $B := -152.5 \cdot \frac{\text{cm}^3}{\text{mol}}$        $C := -5800 \cdot \frac{\text{cm}^6}{\text{mol}^2}$        $V := \frac{R \cdot T}{P}$       **(guess)**

Given       $\frac{P \cdot V}{R \cdot T} = 1 + \frac{B}{V} + \frac{C}{V^2}$        $V := \text{Find}(V)$

$Z := \frac{P \cdot V}{R \cdot T}$        $V = 2250 \frac{\text{cm}^3}{\text{mol}}$        $Z = 0.931$       **Ans.**

(b)  $T_c := 647.1 \cdot K$        $P_c := 220.55 \cdot \text{bar}$        $\omega := 0.345$

$$T_r := \frac{T}{T_c} \qquad P_r := \frac{P}{P_c} \qquad B_0 := 0.083 - \frac{0.422}{T_r^{1.6}}$$

$T_r = 0.808$        $P_r = 0.082$        $B_0 = -0.51$

$$B_1 := 0.139 - \frac{0.172}{T_r^{4.2}} \qquad B_1 = -0.281 \qquad Z := 1 + (B_0 + \omega \cdot B_1) \cdot \frac{P_r}{T_r}$$

$$V := \frac{Z \cdot R \cdot T}{P} \qquad Z = 0.939 \qquad V = 2268 \frac{\text{cm}^3}{\text{mol}} \quad \text{Ans.}$$

(c) **Table F.2:**       $\text{molwt} := 18.015 \cdot \frac{\text{gm}}{\text{mol}}$        $V := 124.99 \cdot \frac{\text{cm}^3}{\text{gm}} \cdot \text{molwt}$

or

$$V = 2252 \frac{\text{cm}^3}{\text{mol}} \quad \text{Ans.}$$

3.37       $B := -53.4 \cdot \frac{\text{cm}^3}{\text{mol}}$        $C := 2620 \cdot \frac{\text{cm}^6}{\text{mol}^2}$        $D := 5000 \cdot \frac{\text{cm}^9}{\text{mol}^3}$        $n := \text{mol}$   
 $T := 273.15 \cdot K$

Given       $\frac{P \cdot V}{R \cdot T} = 1 + \frac{B}{V} + \frac{C}{V^2} + \frac{D}{V^3}$        $f(P, V) := \text{Find}(V)$

$i := 0..10$        $P_i := (10^{-10} + 20 \cdot i) \cdot \text{bar}$        $V_i := \frac{R \cdot T}{P_i}$       (guess)

$$Z_i := \frac{f(P_i, V_i) \cdot P_i}{R \cdot T} \quad \text{Eq. (3.12)}$$

$$Z1_i := 1 + \frac{B \cdot P_i}{R \cdot T} \quad \text{Eq. (3.38)} \qquad Z2_i := \frac{1}{2} + \sqrt{\frac{1}{4} + \frac{B \cdot P_i}{R \cdot T}} \quad \text{Eq. (3.39)}$$

$P_i =$	$1 \cdot 10^{-10}$	$Z_i =$	$Z1_i =$	$Z2_i =$
	20	1	1	1
	40	0.953	0.953	0.951
	60	0.906	0.906	0.895
	80	0.861	0.859	0.83
	100	0.819	0.812	0.749
	120	0.784	0.765	0.622
	140	0.757	0.718	$0.5+0.179i$
	160	0.74	0.671	$0.5+0.281i$
	180	0.733	0.624	$0.5+0.355i$
	200	0.735	0.577	$0.5+0.416i$
		0.743	0.53	$0.5+0.469i$

**Note that values of Z from Eq. (3.39) are not physically meaningful for pressures above 100 bar.**

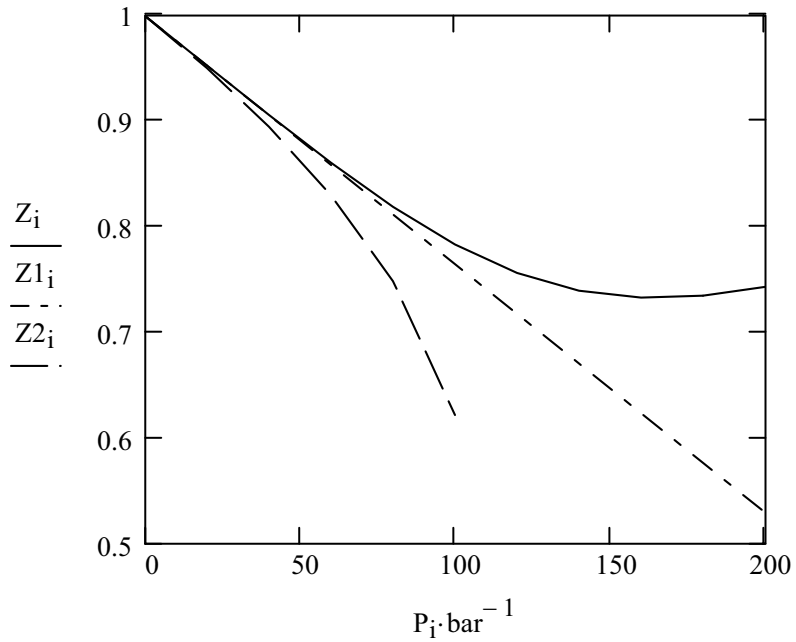

3.38 (a) Propane:  $T_c := 369.8 \cdot K$   $P_c := 42.48 \cdot \text{bar}$   $\omega := 0.152$

$T := 313.15 \cdot K$   $P := 13.71 \cdot \text{bar}$

$T_r := \frac{T}{T_c}$   $T_r = 0.847$   $P_r := \frac{P}{P_c}$   $P_r = 0.323$

For Redlich/Kwong EOS:

$\sigma := 1$   $\varepsilon := 0$   $\Omega := 0.08664$   $\Psi := 0.42748$  **Table 3.1**

$\alpha(T_r) := T_r^{-0.5}$  **Table 3.1**  $q(T_r) := \frac{\Psi \alpha(T_r)}{\Omega \cdot T_r}$  **Eq. (3.54)**

$\beta(T_r, P_r) := \frac{\Omega \cdot P_r}{T_r}$  **Eq. (3.53)**

Calculate Z for liquid by Eq. (3.56) **Guess:**  $Z := 0.01$

Given

$$Z = \beta(T_r, P_r) + (Z + \varepsilon \beta(T_r, P_r)) \cdot (Z + \sigma \beta(T_r, P_r)) \cdot \left( \frac{1 + \beta(T_r, P_r) - Z}{q(T_r) \cdot \beta(T_r, P_r)} \right)$$

$Z := \text{Find}(Z)$   $Z = 0.057$   $V := \frac{Z \cdot R \cdot T}{P}$   $V = 108.1 \frac{\text{cm}^3}{\text{mol}}$  **Ans.**

Calculate Z for vapor by Eq. (3.52) **Guess:**  $Z := 0.9$

Given

$$Z = 1 + \beta(T_r, P_r) - q(T_r) \cdot \beta(T_r, P_r) \cdot \frac{Z - \beta(T_r, P_r)}{Z \cdot (Z + \beta(T_r, P_r))}$$

$Z := \text{Find}(Z)$   $Z = 0.789$   $V := \frac{Z \cdot R \cdot T}{P}$   $V = 1499.2 \frac{\text{cm}^3}{\text{mol}}$  **Ans.**

**Rackett equation for saturated liquid:**

$$T_r := \frac{T}{T_c}$$

$$T_r = 0.847$$

$$V_c := 200.0 \frac{\text{cm}^3}{\text{mol}}$$

$$Z_c := 0.276$$

$$V := V_c \cdot Z_c \left[ (1 - T_r)^{0.2857} \right]$$

$$V = 94.17 \frac{\text{cm}^3}{\text{mol}}$$

**Ans.**

**For saturated vapor, use Pitzer correlation:**

$$B_0 := 0.083 - \frac{0.422}{T_r^{1.6}}$$

$$B_0 = -0.468$$

$$B_1 := 0.139 - \frac{0.172}{T_r^{4.2}}$$

$$B_1 = -0.207$$

$$V := \frac{R \cdot T}{P} + R \cdot \left( B_0 + \omega \cdot B_1 \right) \cdot \frac{T_c}{P_c}$$

$$V = 1.538 \times 10^3 \frac{\text{cm}^3}{\text{mol}}$$

**Ans.**

**Parts (b) through (t) are worked exactly the same way. All results are summarized as follows. Volume units are cu.cm./mole.**

	<b>R/K, Liq.</b>	<b>R/K, Vap.</b>	<b>Rackett</b>	<b>Pitzer</b>
<b>(a)</b>	<b>108.1</b>	<b>1499.2</b>	<b>94.2</b>	<b>1537.8</b>
<b>(b)</b>	<b>114.5</b>	<b>1174.7</b>	<b>98.1</b>	<b>1228.7</b>
<b>(c)</b>	<b>122.7</b>	<b>920.3</b>	<b>102.8</b>	<b>990.4</b>
<b>(d)</b>	<b>133.6</b>	<b>717.0</b>	<b>109.0</b>	<b>805.0</b>
<b>(e)</b>	<b>148.9</b>	<b>1516.2</b>	<b>125.4</b>	<b>1577.0</b>
<b>(f)</b>	<b>158.3</b>	<b>1216.1</b>	<b>130.7</b>	<b>1296.8</b>
<b>(g)</b>	<b>170.4</b>	<b>971.1</b>	<b>137.4</b>	<b>1074.0</b>
<b>(h)</b>	<b>187.1</b>	<b>768.8</b>	<b>146.4</b>	<b>896.0</b>
<b>(i)</b>	<b>153.2</b>	<b>1330.3</b>	<b>133.9</b>	<b>1405.7</b>
<b>(j)</b>	<b>164.2</b>	<b>1057.9</b>	<b>140.3</b>	<b>1154.3</b>
<b>(k)</b>	<b>179.1</b>	<b>835.3</b>	<b>148.6</b>	<b>955.4</b>
<b>(l)</b>	<b>201.4</b>	<b>645.8</b>	<b>160.6</b>	<b>795.8</b>
<b>(m)</b>	<b>61.7</b>	<b>1252.5</b>	<b>53.5</b>	<b>1276.9</b>
<b>(n)</b>	<b>64.1</b>	<b>1006.9</b>	<b>55.1</b>	<b>1038.5</b>
<b>(o)</b>	<b>66.9</b>	<b>814.5</b>	<b>57.0</b>	<b>853.4</b>
<b>(p)</b>	<b>70.3</b>	<b>661.2</b>	<b>59.1</b>	<b>707.8</b>
<b>(q)</b>	<b>64.4</b>	<b>1318.7</b>	<b>54.6</b>	<b>1319.0</b>
<b>(r)</b>	<b>67.4</b>	<b>1046.6</b>	<b>56.3</b>	<b>1057.2</b>
<b>(s)</b>	<b>70.8</b>	<b>835.6</b>	<b>58.3</b>	<b>856.4</b>
<b>(t)</b>	<b>74.8</b>	<b>669.5</b>	<b>60.6</b>	<b>700.5</b>

**3.39 (a) Propane**     $T_c := 369.8 \cdot K$      $P_c := 42.48 \cdot \text{bar}$      $\omega := 0.152$

$T := (40 + 273.15) \cdot K$      $T = 313.15 K$      $P := 13.71 \cdot \text{bar}$

$T_r := \frac{T}{T_c}$      $T_r = 0.847$      $P_r := \frac{P}{P_c}$      $P_r = 0.323$

**From Table 3.1 for SRK:**

$\sigma := 1$      $\varepsilon := 0$      $\Omega := 0.08664$      $\Psi := 0.42748$

$$\alpha(T_r, \omega) := \left[ 1 + (0.480 + 1.574\omega - 0.176\omega^2) \cdot \left( 1 - T_r^{\frac{1}{2}} \right) \right]^2$$

$$q(T_r) := \frac{\Psi \alpha(T_r, \omega)}{\Omega \cdot T_r} \quad \text{Eq. (3.54)} \quad \beta(T_r, P_r) := \frac{\Omega \cdot P_r}{T_r} \quad \text{Eq. (3.53)}$$

**Calculate Z for liquid by Eq. (3.56) Guess:**     $Z := 0.01$

Given

$$Z = \beta(T_r, P_r) + (Z + \varepsilon \beta(T_r, P_r)) \cdot (Z + \sigma \beta(T_r, P_r)) \cdot \left( \frac{1 + \beta(T_r, P_r) - Z}{q(T_r) \cdot \beta(T_r, P_r)} \right)$$

$Z := \text{Find}(Z)$      $Z = 0.055$      $V := \frac{Z \cdot R \cdot T}{P}$      $V = 104.7 \frac{\text{cm}^3}{\text{mol}}$     **Ans.**

**Calculate Z for vapor by Eq. (3.52) Guess:**     $Z := 0.9$

Given

$$Z = 1 + \beta(T_r, P_r) - q(T_r) \cdot \beta(T_r, P_r) \cdot \frac{Z - \beta(T_r, P_r)}{(Z + \varepsilon \beta(T_r, P_r)) \cdot (Z + \sigma \beta(T_r, P_r))}$$

$Z := \text{Find}(Z)$      $Z = 0.78$      $V := \frac{Z \cdot R \cdot T}{P}$      $V = 1480.7 \frac{\text{cm}^3}{\text{mol}}$     **Ans.**



**Parts (b) through (t) are worked exactly the same way. All results are summarized as follows. Volume units are cu.cm./mole.**

	<b>SRK, Liq.</b>	<b>SRK, Vap.</b>	<b>Rackett</b>	<b>Pitzer</b>
<b>(a)</b>	<b>104.7</b>	<b>1480.7</b>	<b>94.2</b>	<b>1537.8</b>
<b>(b)</b>	<b>110.6</b>	<b>1157.8</b>	<b>98.1</b>	<b>1228.7</b>
<b>(c)</b>	<b>118.2</b>	<b>904.9</b>	<b>102.8</b>	<b>990.4</b>
<b>(d)</b>	<b>128.5</b>	<b>703.3</b>	<b>109.0</b>	<b>805.0</b>
<b>(e)</b>	<b>142.1</b>	<b>1487.1</b>	<b>125.4</b>	<b>1577.0</b>
<b>(f)</b>	<b>150.7</b>	<b>1189.9</b>	<b>130.7</b>	<b>1296.8</b>
<b>(g)</b>	<b>161.8</b>	<b>947.8</b>	<b>137.4</b>	<b>1074.0</b>
<b>(h)</b>	<b>177.1</b>	<b>747.8</b>	<b>146.4</b>	<b>896.0</b>
<b>(i)</b>	<b>146.7</b>	<b>1305.3</b>	<b>133.9</b>	<b>1405.7</b>
<b>(j)</b>	<b>156.9</b>	<b>1035.2</b>	<b>140.3</b>	<b>1154.3</b>
<b>(k)</b>	<b>170.7</b>	<b>815.1</b>	<b>148.6</b>	<b>955.4</b>
<b>(l)</b>	<b>191.3</b>	<b>628.5</b>	<b>160.6</b>	<b>795.8</b>
<b>(m)</b>	<b>61.2</b>	<b>1248.9</b>	<b>53.5</b>	<b>1276.9</b>
<b>(n)</b>	<b>63.5</b>	<b>1003.2</b>	<b>55.1</b>	<b>1038.5</b>
<b>(o)</b>	<b>66.3</b>	<b>810.7</b>	<b>57.0</b>	<b>853.4</b>
<b>(p)</b>	<b>69.5</b>	<b>657.4</b>	<b>59.1</b>	<b>707.8</b>
<b>(q)</b>	<b>61.4</b>	<b>1296.8</b>	<b>54.6</b>	<b>1319.0</b>
<b>(r)</b>	<b>63.9</b>	<b>1026.3</b>	<b>56.3</b>	<b>1057.2</b>
<b>(s)</b>	<b>66.9</b>	<b>817.0</b>	<b>58.3</b>	<b>856.4</b>
<b>(t)</b>	<b>70.5</b>	<b>652.5</b>	<b>60.6</b>	<b>700.5</b>

**3.40 (a) Propane**

$$T_c := 369.8 \cdot \text{K}$$

$$P_c := 42.48 \cdot \text{bar}$$

$$\omega := 0.152$$

$$T := (40 + 273.15) \cdot \text{K}$$

$$T = 313.15 \text{ K}$$

$$P := 13.71 \cdot \text{bar}$$

$$T_r := \frac{T}{T_c}$$

$$T_r = 0.847$$

$$P_r := \frac{P}{P_c}$$

$$P_r = 0.323$$

**From Table 3.1 for PR:**

$$\alpha(T_r, \omega) := \left[ 1 + \left( 0.37464 + 1.54226\omega - 0.26992\omega^2 \right) \cdot \left( 1 - T_r^2 \right)^{\frac{1}{2}} \right]^2$$

$$\sigma := 1 + \sqrt{2} \quad \varepsilon := 1 - \sqrt{2} \quad \Omega := 0.07779 \quad \Psi := 0.45724$$

$$q(T_r) := \frac{\Psi \alpha(T_r, \omega)}{\Omega \cdot T_r} \quad \text{Eq. (3.54)} \quad \beta(T_r, P_r) := \frac{\Omega \cdot P_r}{T_r} \quad \text{Eq. (3.53)}$$

**Calculate Z for liquid by Eq. (3.56) Guess:**  $Z := 0.01$

Given

$$Z = \beta(T_r, P_r) + (Z + \varepsilon \beta(T_r, P_r)) \cdot (Z + \sigma \beta(T_r, P_r)) \cdot \left( \frac{1 + \beta(T_r, P_r) - Z}{q(T_r) \cdot \beta(T_r, P_r)} \right)$$

$$Z := \text{Find}(Z) \quad Z = 0.049 \quad V := \frac{Z \cdot R \cdot T}{P} \quad V = 92.2 \frac{\text{cm}^3}{\text{mol}} \quad \text{Ans.}$$

**Calculate Z for vapor by Eq. (3.52) Guess:**  $Z := 0.6$

Given

$$Z = 1 + \beta(T_r, P_r) - q(T_r) \cdot \beta(T_r, P_r) \cdot \frac{Z - \beta(T_r, P_r)}{(Z + \varepsilon \beta(T_r, P_r)) \cdot (Z + \sigma \beta(T_r, P_r))}$$

$$Z := \text{Find}(Z) \quad Z = 0.766 \quad V := \frac{Z \cdot R \cdot T}{P} \quad V = 1454.5 \frac{\text{cm}^3}{\text{mol}} \quad \text{Ans.}$$

**Parts (b) through (t) are worked exactly the same way. All results are summarized as follows. Volume units are cu.cm./mole.**

	<b>PR, Liq.</b>	<b>PR, Vap.</b>	<b>Rackett</b>	<b>Pitzer</b>
<b>(a)</b>	<b>92.2</b>	<b>1454.5</b>	<b>94.2</b>	<b>1537.8</b>
<b>(b)</b>	<b>97.6</b>	<b>1131.8</b>	<b>98.1</b>	<b>1228.7</b>
<b>(c)</b>	<b>104.4</b>	<b>879.2</b>	<b>102.8</b>	<b>990.4</b>
<b>(d)</b>	<b>113.7</b>	<b>678.1</b>	<b>109.0</b>	<b>805.0</b>
<b>(e)</b>	<b>125.2</b>	<b>1453.5</b>	<b>125.4</b>	<b>1577.0</b>
<b>(f)</b>	<b>132.9</b>	<b>1156.3</b>	<b>130.7</b>	<b>1296.8</b>
<b>(g)</b>	<b>143.0</b>	<b>915.0</b>	<b>137.4</b>	<b>1074.0</b>
<b>(h)</b>	<b>157.1</b>	<b>715.8</b>	<b>146.4</b>	<b>896.0</b>
<b>(i)</b>	<b>129.4</b>	<b>1271.9</b>	<b>133.9</b>	<b>1405.7</b>
<b>(j)</b>	<b>138.6</b>	<b>1002.3</b>	<b>140.3</b>	<b>1154.3</b>
<b>(k)</b>	<b>151.2</b>	<b>782.8</b>	<b>148.6</b>	<b>955.4</b>
<b>(l)</b>	<b>170.2</b>	<b>597.3</b>	<b>160.6</b>	<b>795.8</b>
<b>(m)</b>	<b>54.0</b>	<b>1233.0</b>	<b>53.5</b>	<b>1276.9</b>
<b>(n)</b>	<b>56.0</b>	<b>987.3</b>	<b>55.1</b>	<b>1038.5</b>
<b>(o)</b>	<b>58.4</b>	<b>794.8</b>	<b>57.0</b>	<b>853.4</b>
<b>(p)</b>	<b>61.4</b>	<b>641.6</b>	<b>59.1</b>	<b>707.8</b>
<b>(q)</b>	<b>54.1</b>	<b>1280.2</b>	<b>54.6</b>	<b>1319.0</b>
<b>(r)</b>	<b>56.3</b>	<b>1009.7</b>	<b>56.3</b>	<b>1057.2</b>
<b>(s)</b>	<b>58.9</b>	<b>800.5</b>	<b>58.3</b>	<b>856.4</b>
<b>(t)</b>	<b>62.2</b>	<b>636.1</b>	<b>60.6</b>	<b>700.5</b>

3.41 (a) For ethylene,

$$\text{molwt} := 28.054 \frac{\text{gm}}{\text{mol}}$$

$$T_c := 282.3 \cdot \text{K}$$

$$P_c := 50.40 \cdot \text{bar}$$

$$\omega := 0.087$$

$$T := 328.15 \cdot \text{K}$$

$$P := 35 \cdot \text{bar}$$

$$T_r := \frac{T}{T_c}$$

$$P_r := \frac{P}{P_c}$$

$$T_r = 1.162$$

$$P_r = 0.694$$

From Tables E.1 & E.2:

$$Z_0 := 0.838$$

$$Z_1 := 0.033$$

$$Z := Z_0 + \omega \cdot Z_1$$

$$Z = 0.841$$

$$n := \frac{18 \cdot \text{kg}}{\text{molwt}}$$

$$V_{\text{total}} := \frac{Z \cdot n \cdot R \cdot T}{P}$$

$$V_{\text{total}} = 0.421 \text{ m}^3$$

Ans.

(b)  $T := 323.15 \cdot \text{K}$

$$P := 115 \cdot \text{bar}$$

$$V_{\text{total}} := 0.25 \cdot \text{m}^3$$

$$T_r := \frac{T}{T_c}$$

$$T_r = 1.145$$

$$P_r := \frac{P}{P_c}$$

$$P_r = 2.282$$

From Tables E.3 & E.4:  $Z_0 := 0.482$

$$Z_1 := 0.126$$

$$Z := Z_0 + \omega \cdot Z_1$$

$$Z = 0.493$$

$$n := \frac{P \cdot V_{\text{total}}}{Z \cdot R \cdot T}$$

$$n = 2171 \text{ mol}$$

$$\text{mass} := n \cdot \text{molwt}$$

$$\text{mass} = 60.898 \text{ kg}$$

Ans.

3.42 Assume validity of Eq. (3.38).

$$P_1 := 1 \text{ bar}$$

$$T_1 := 300 \text{ K}$$

$$V_1 := 23000 \frac{\text{cm}^3}{\text{mol}}$$

$$Z_1 := \frac{P_1 \cdot V_1}{R \cdot T_1}$$

$$Z_1 = 0.922$$

$$B := \frac{R \cdot T_1}{P_1} \cdot (Z_1 - 1)$$

$$B = -1.942 \times 10^3 \frac{\text{cm}^3}{\text{mol}}$$

With this B, recalculate at  $P_2$

$$P_2 := 5 \text{ bar}$$

$$Z_2 := 1 + \frac{B \cdot P_2}{R \cdot T_1}$$

$$Z_2 = 0.611$$

$$V_2 := \frac{R \cdot T_1 \cdot Z_2}{P_2}$$

$$V_2 = 3.046 \times 10^3 \frac{\text{cm}^3}{\text{mol}}$$

Ans.

3.43  $T := 753.15 \cdot K$        $T_c := 513.9 \cdot K$        $T_r := \frac{T}{T_c}$        $T_r = 1.466$

$P := 6000 \cdot kPa$        $P_c := 61.48 \cdot bar$        $P_r := \frac{P}{P_c}$        $P_r = 0.976$

$\omega := 0.645$        $B_0 := 0.083 - \frac{0.422}{T_r^{1.6}}$        $B_0 = -0.146$

$B_1 := 0.139 - \frac{0.172}{T_r^{4.2}}$        $B_1 = 0.104$

$V := \frac{R \cdot T}{P} + (B_0 + \omega \cdot B_1) \cdot R \cdot \frac{T_c}{P_c}$        $V = 989 \frac{cm^3}{mol}$       **Ans.**

**For an ideal gas:**       $V := \frac{R \cdot T}{P}$        $V = 1044 \frac{cm^3}{mol}$

3.44  $T := 320 \cdot K$        $P := 16 \cdot bar$        $T_c := 369.8 \cdot K$        $P_c := 42.48 \cdot bar$

$\omega := 0.152$        $V_c := 200 \cdot \frac{cm^3}{mol}$        $Z_c := 0.276$        $molwt := 44.097 \frac{gm}{mol}$

$T_r := \frac{T}{T_c}$        $T_r = 0.865$        $P_r := \frac{P}{P_c}$        $P_r = 0.377$

$V_{liq} := V_c \cdot Z_c \left[ (0 - T_r)^{0.2857} \right]$        $V_{liq} = 96.769 \frac{cm^3}{mol}$

$V_{tank} := 0.35 \cdot m^3$        $m_{liq} := \frac{0.8 \cdot V_{tank}}{\frac{V_{liq}}{molwt}}$        $m_{liq} = 127.594 kg$       **Ans.**

$B_0 := 0.083 - \frac{0.422}{T_r^{1.6}}$        $B_0 = -0.449$

$B_1 := 0.139 - \frac{0.172}{T_r^{4.2}}$        $B_1 = -0.177$

$$V_{\text{vap}} := \frac{R \cdot T}{P} + (B_0 + \omega \cdot B_1) \cdot R \cdot \frac{T_c}{P_c}$$

$$V_{\text{vap}} = 1.318 \times 10^3 \frac{\text{cm}^3}{\text{mol}}$$

$$m_{\text{vap}} := \frac{0.2 \cdot V_{\text{tank}}}{\frac{V_{\text{vap}}}{\text{molwt}}}$$

$$m_{\text{vap}} = 2.341 \text{ kg} \quad \text{Ans.}$$

$$3.45 \quad T := 298.15 \cdot \text{K}$$

$$T_c := 425.1 \cdot \text{K}$$

$$T_r := \frac{T}{T_c}$$

$$T_r = 0.701$$

$$P := 2.43 \cdot \text{bar}$$

$$P_c := 37.96 \cdot \text{bar}$$

$$P_r := \frac{P}{P_c}$$

$$P_r = 0.064$$

$$\omega := 0.200$$

$$V_{\text{vap}} := 16 \cdot \text{m}^3$$

$$\text{molwt} := 58.123 \cdot \frac{\text{gm}}{\text{mol}}$$

$$B_0 := 0.083 - \frac{0.422}{T_r^{1.6}}$$

$$B_0 = -0.661$$

$$B_1 := 0.139 - \frac{0.172}{T_r^{4.2}}$$

$$B_1 = -0.624$$

$$V := \frac{R \cdot T}{P} + (B_0 + \omega \cdot B_1) \cdot R \cdot \frac{T_c}{P_c}$$

$$V = 9.469 \times 10^3 \frac{\text{cm}^3}{\text{mol}}$$

$$m_{\text{vap}} := \frac{V_{\text{vap}}}{\frac{V}{\text{molwt}}}$$

$$m_{\text{vap}} = 98.213 \text{ kg} \quad \text{Ans.}$$

$$3.46 \quad (\text{a}) \quad T := 333.15 \cdot \text{K}$$

$$T_c := 305.3 \cdot \text{K}$$

$$T_r := \frac{T}{T_c}$$

$$T_r = 1.091$$

$$P := 14000 \cdot \text{kPa}$$

$$P_c := 48.72 \cdot \text{bar}$$

$$P_r := \frac{P}{P_c}$$

$$P_r = 2.874$$

$$\omega := 0.100$$

$$V_{\text{total}} := 0.15 \cdot \text{m}^3$$

$$\text{molwt} := 30.07 \frac{\text{gm}}{\text{mol}}$$

$$\text{From tables E.3 \& E.4: } Z_0 := 0.463$$

$$Z_1 := -0.037$$

$$Z := Z_0 + \omega \cdot Z_1 \quad Z = 0.459 \quad V := \frac{Z \cdot R \cdot T}{P} \quad V = 90.87 \frac{\text{cm}^3}{\text{mol}}$$

$$m_{\text{methane}} := \frac{V_{\text{total}}}{\frac{V}{\text{molwt}}} \quad m_{\text{methane}} = 49.64 \text{ kg} \quad \text{Ans.}$$

(b)  $V := \frac{V_{\text{total}}}{40 \cdot \text{kg}} \quad P := 20000 \cdot \text{kPa} \quad P \cdot V = Z \cdot R \cdot T = Z \cdot R \cdot T_r \cdot T_c$

or  $T_r = \frac{\alpha}{Z} \quad \text{where} \quad \alpha := \frac{P \cdot V}{R \cdot T_c} \quad \alpha = 29.548 \frac{\text{mol}}{\text{kg}}$

Whence  $T_r = \frac{0.889}{Z} \quad \text{at} \quad P_r := \frac{P}{P_c} \quad P_r = 4.105$

This equation giving  $T_r$  as a function of  $Z$  and Eq. (3.57) in conjunction with Tables E.3 & E.4 are two relations in the same variables which must be satisfied at the given reduced pressure. The intersection of these two relations can be found by one means or another to occur at about:

$$T_r := 1.283 \quad \text{and} \quad Z := 0.693$$

Whence  $T := T_r \cdot T_c$

$$T = 391.7 \text{ K} \quad \text{or} \quad 118.5 \cdot \text{degC} \quad \text{Ans.}$$

3.47  $V_{\text{total}} := 0.15 \cdot \text{m}^3 \quad T := 298.15 \cdot \text{K}$   
 $T_c := 282.3 \cdot \text{K} \quad P_c := 50.40 \cdot \text{bar} \quad \omega := 0.087 \quad \text{molwt} := 28.054 \frac{\text{gm}}{\text{mol}}$

$$V := \frac{V_{\text{total}}}{\left(\frac{40 \cdot \text{kg}}{\text{molwt}}\right)} \quad P \cdot V = P_r \cdot P_c \cdot V = Z \cdot R \cdot T$$

or  $P_r = \alpha \cdot Z \quad \text{where} \quad \alpha := \frac{R \cdot T}{P_c \cdot V} \quad \alpha = 4.675$

Whence  $P_r = 4.675 \cdot Z \quad \text{at} \quad T_r := \frac{T}{T_c} \quad T_r = 1.056$

This equation giving  $P_r$  as a function of  $Z$  and Eq. (3.57) in conjunction with Tables E.3 & E.4 are two relations in the same variables which must be satisfied at the given reduced temperature. The intersection of these two relations can be found by one means or another to occur at about:

$$P_r := 1.582 \quad \text{and} \quad Z := 0.338 \quad P := P_c \cdot P_r \quad P = 79.73 \text{ bar} \quad \text{Ans.}$$

$$3.48 \quad m_{\text{water}} := 15 \cdot \text{kg} \quad V_{\text{total}} := 0.4 \cdot \text{m}^3 \quad V := \frac{V_{\text{total}}}{m_{\text{water}}} \quad V = 26.667 \frac{\text{cm}^3}{\text{gm}}$$

Interpolate in Table F.2 at 400 degC to find:  $P = 9920 \cdot \text{kPa}$  Ans.

$$3.49 \quad T_1 := 298.15 \cdot \text{K} \quad T_c := 305.3 \cdot \text{K} \quad T_{r1} := \frac{T_1}{T_c} \quad T_{r1} = 0.977$$

$$P_1 := 2200 \cdot \text{kPa} \quad P_c := 48.72 \cdot \text{bar} \quad P_{r1} := \frac{P_1}{P_c} \quad P_{r1} = 0.452$$

$$V_{\text{total}} := 0.35 \cdot \text{m}^3 \quad \omega := 0.100$$

From Tables E.1 & E.2:  $Z_0 := .8105$   $Z_1 := -0.0479$

$$Z := Z_0 + \omega \cdot Z_1 \quad Z = 0.806 \quad V_1 := \frac{Z \cdot R \cdot T_1}{P_1} \quad V_1 = 908 \frac{\text{cm}^3}{\text{mol}}$$

$$T_2 := 493.15 \cdot \text{K} \quad T_{r2} := \frac{T_2}{T_c} \quad T_{r2} = 1.615$$

Assume Eq. (3.38) applies at the final state.

$$B_0 := 0.083 - \frac{0.422}{T_{r2}^{1.6}} \quad B_0 = -0.113$$

$$B_1 := 0.139 - \frac{0.172}{T_{r2}^{4.2}} \quad B_1 = 0.116$$

$$P_2 := \frac{R \cdot T_2}{V_1 - \left( B_0 + \omega \cdot B_1 \cdot R \cdot \frac{T_c}{P_c} \right)} \quad P_2 = 42.68 \text{ bar} \quad \text{Ans.}$$



3.50  $T := 303.15 \cdot K$        $T_c := 304.2 \cdot K$        $T_r := \frac{T}{T_c}$        $T_r = 0.997$

$V_{\text{total}} := 0.5 \cdot m^3$        $P_c := 73.83 \cdot \text{bar}$        $\omega := 0.224$        $\text{molwt} := 44.01 \cdot \frac{\text{gm}}{\text{mol}}$

$B_0 := 0.083 - \frac{0.422}{T_r^{1.6}}$        $B_0 = -0.341$

$B_1 := 0.139 - \frac{0.172}{T_r^{4.2}}$        $B_1 = -0.036$

$V := \frac{V_{\text{total}}}{\left(\frac{10 \cdot \text{kg}}{\text{molwt}}\right)}$        $V = 2.2 \times 10^3 \frac{\text{cm}^3}{\text{mol}}$

$P := \frac{R \cdot T}{V - \left(B_0 + \omega \cdot B_1 \cdot R \cdot \frac{T_c}{P_c}\right)}$        $P = 10.863 \text{ bar}$       **Ans.**

**3.51 Basis: 1 mole of LIQUID nitrogen**

$T_n := 77.3 \cdot K$        $T_c := 126.2 \cdot K$        $T_r := \frac{T_n}{T_c}$        $T_r = 0.613$

$P := 1 \cdot \text{atm}$        $P_c := 34.0 \cdot \text{bar}$        $P_r := \frac{P}{P_c}$        $P_r = 0.03$

$\omega := 0.038$        $\text{molwt} := 28.014 \cdot \frac{\text{gm}}{\text{mol}}$        $V_{\text{liq}} := 34.7 \cdot \text{cm}^3$

$B_0 := 0.083 - \frac{0.422}{T_r^{1.6}}$        $B_0 = -0.842$

$B_1 := 0.139 - \frac{0.172}{T_r^{4.2}}$        $B_1 = -1.209$

$Z := 1 + \left(B_0 + \omega \cdot B_1 \cdot \frac{P_r}{T_r}\right)$        $Z = 0.957$

$$n_{\text{vapor}} := \frac{P \cdot V_{\text{liq}}}{Z \cdot R \cdot T_n}$$

$$n_{\text{vapor}} = 5.718 \times 10^{-3} \text{ mol}$$

**Final conditions:**

$$n_{\text{total}} := 1 \cdot \text{mol} + n_{\text{vapor}}$$

$$V := \frac{2 \cdot V_{\text{liq}}}{n_{\text{total}}}$$

$$V = 69.005 \frac{\text{cm}^3}{\text{mol}}$$

$$T := 298.15 \cdot \text{K}$$

$$T_r := \frac{T}{T_c}$$

$$T_r = 2.363$$

$$P_{\text{ig}} := \frac{R \cdot T}{V}$$

$$P_{\text{ig}} = 359.2 \text{ bar}$$

**Use Redlich/Kwong at so high a P.**

$$\Omega := 0.08664$$

$$\Psi := 0.42748$$

$$\alpha(T_r) := T_r^{-.5}$$

$$\alpha(T_r) = 0.651$$

$$a := \frac{\Psi \alpha(T_r) \cdot R^2 \cdot T_c^2}{P_c} \quad \text{Eq. (3.42)}$$

$$b := \frac{\Omega \cdot R \cdot T_c}{P_c} \quad \text{Eq. (3.43)}$$

$$a = 0.901 \text{ m}^3 \frac{\text{bar} \cdot \text{cm}^3}{\text{mol}^2}$$

$$b = 26.737 \frac{\text{cm}^3}{\text{mol}}$$

$$P := \frac{R \cdot T}{V - b} - \frac{a}{V \cdot (V + b)} \quad \text{Eq. (3.44)}$$

$$P = 450.1 \text{ bar}$$

**Ans.**

**3.52 For isobutane:**

$$T_c := 408.1 \cdot \text{K}$$

$$P_c := 36.48 \cdot \text{bar}$$

$$V_1 := 1.824 \cdot \frac{\text{cm}^3}{\text{gm}}$$

$$T_1 := 300 \cdot \text{K}$$

$$P_1 := 4 \cdot \text{bar}$$

$$T_2 := 415 \cdot \text{K}$$

$$P_2 := 75 \cdot \text{bar}$$

$$T_{r1} := \frac{T_1}{T_c}$$

$$P_{r1} := \frac{P_1}{P_c}$$

$$T_{r2} := \frac{T_2}{T_c}$$

$$P_{r2} := \frac{P_2}{P_c}$$

$$T_{r1} = 0.735$$

$$P_{r1} = 0.11$$

$$T_{r2} = 1.017$$

$$P_{r2} = 2.056$$

From Fig. (3.17):

$$\rho_{r1} := 2.45$$

The final  $T > T_c$ , and Fig. 3.16 probably should not be used. One can easily show that

$$\rho_r = \frac{P \cdot V_c}{Z \cdot R \cdot T}$$

with  $Z$  from Eq. (3.57) and Tables E.3 and E.4. Thus

$$V_c := 262.7 \cdot \frac{\text{cm}^3}{\text{mol}}$$

$$\omega := 0.181$$

$$Z_0 := 0.3356$$

$$Z_1 := -0.0756$$

$$Z := Z_0 + \omega \cdot Z_1$$

$$Z = 0.322$$

$$\rho_{r2} := \frac{P_2 \cdot V_c}{Z \cdot R \cdot T_2}$$

$$\rho_{r2} = 1.774$$

Eq. (3.75):

$$V_2 := V_1 \cdot \frac{\rho_{r1}}{\rho_{r2}}$$

$$V_2 = 2.519 \cdot \frac{\text{cm}^3}{\text{gm}}$$

Ans.

3.53 For n-pentane:

$$T_c := 469.7 \cdot \text{K}$$

$$P_c := 33.7 \cdot \text{bar}$$

$$\rho_1 := 0.63 \cdot \frac{\text{gm}}{\text{cm}^3}$$

$$T_1 := 291.15 \cdot \text{K}$$

$$P_1 := 1 \cdot \text{bar}$$

$$T_2 := 413.15 \cdot \text{K}$$

$$P_2 := 120 \cdot \text{bar}$$

$$T_{r1} := \frac{T_1}{T_c}$$

$$P_{r1} := \frac{P_1}{P_c}$$

$$T_{r2} := \frac{T_2}{T_c}$$

$$P_{r2} := \frac{P_2}{P_c}$$

$$T_{r1} = 0.62$$

$$P_{r1} = 0.03$$

$$T_{r2} = 0.88$$

$$P_{r2} = 3.561$$

From Fig. (3.16):

$$\rho_{r1} := 2.69$$

$$\rho_{r2} := 2.27$$

By Eq. (3.75),

$$\rho_2 := \rho_1 \cdot \frac{\rho_{r2}}{\rho_{r1}}$$

$$\rho_2 = 0.532 \cdot \frac{\text{gm}}{\text{cm}^3}$$

Ans.

3.54 For ethanol:

$$T_c := 513.9 \cdot \text{K}$$

$$T := 453.15 \cdot \text{K}$$

$$T_r := \frac{T}{T_c}$$

$$T_r = 0.882$$

$$P_c := 61.48 \cdot \text{bar}$$

$$P := 200 \cdot \text{bar}$$

$$P_r := \frac{P}{P_c}$$

$$P_r = 3.253$$

$$V_c := 167 \cdot \frac{\text{cm}^3}{\text{mol}}$$

$$\text{molwt} := 46.069 \cdot \frac{\text{gm}}{\text{mol}}$$

From Fig. 3.16:

$$\rho_r := 2.28$$

$$\rho = \rho_r \cdot \rho_c = \frac{\rho_r}{V_c}$$

$$\rho := \frac{\rho_r}{\frac{V_c}{\text{molwt}}}$$

$$\rho = 0.629 \frac{\text{gm}}{\text{cm}^3}$$

Ans.

3.55 For ammonia:

$$T_c := 405.7 \cdot \text{K}$$

$$T := 293.15 \cdot \text{K}$$

$$T_r := \frac{T}{T_c}$$

$$T_r = 0.723$$

$$P_c := 112.8 \cdot \text{bar}$$

$$P := 857 \cdot \text{kPa}$$

$$P_r := \frac{P}{P_c}$$

$$P_r = 0.076$$

$$V_c := 72.5 \cdot \frac{\text{cm}^3}{\text{mol}}$$

$$Z_c := 0.242$$

$$\omega := 0.253$$

$$\text{Eq. (3.72): } V_{\text{liquid}} := V_c \cdot Z_c \left[ 1 - T_r^{0.2857} \right]$$

$$V_{\text{liquid}} = 27.11 \frac{\text{cm}^3}{\text{mol}}$$

$$B_0 := 0.083 - \frac{0.422}{T_r^{1.6}}$$

$$B_0 = -0.627$$

$$B_1 := 0.139 - \frac{0.172}{T_r^{4.2}}$$

$$B_1 = -0.534$$

$$V_{\text{vapor}} := \frac{R \cdot T}{P} + \left( B_0 + \omega \cdot B_1 \right) \cdot R \cdot \frac{T_c}{P_c}$$

$$V_{\text{vapor}} = 2616 \frac{\text{cm}^3}{\text{mol}}$$

$$\Delta V := V_{\text{vapor}} - V_{\text{liquid}}$$

$$\Delta V = 2589 \frac{\text{cm}^3}{\text{mol}}$$

Ans.

Alternatively, use Tables E.1 & E.2 to get the vapor volume:

$$Z_0 := 0.929$$

$$Z_1 := -0.071$$

$$Z := Z_0 + \omega \cdot Z_1$$

$$Z = 0.911$$

$$V_{\text{vapor}} := \frac{Z \cdot R \cdot T}{P}$$

$$V_{\text{vapor}} = 2591 \frac{\text{cm}^3}{\text{mol}}$$

$$\Delta V := V_{\text{vapor}} - V_{\text{liquid}}$$

$$\Delta V = 2564 \frac{\text{cm}^3}{\text{mol}}$$

Ans.

3.58 10 gal. of gasoline is equivalent to 1400 cu ft. of methane at 60 degF and 1 atm. Assume at these conditions that methane is an ideal gas:

$$R = 0.7302 \frac{\text{ft}^3 \cdot \text{atm}}{\text{lbmol} \cdot \text{rankine}}$$

$$T := 519.67 \cdot \text{rankine}$$

$$P := 1 \cdot \text{atm}$$

$$V := 1400 \cdot \text{ft}^3$$

$$n := \frac{P \cdot V}{R \cdot T}$$

$$n = 3.689 \text{ lbmol}$$

For methane at 3000 psi and 60 degF:

$$T_c := 190.6 \cdot 1.8 \cdot \text{rankine}$$

$$T := 519.67 \cdot \text{rankine}$$

$$T_r := \frac{T}{T_c}$$

$$T_r = 1.515$$

$$P_c := 45.99 \cdot \text{bar}$$

$$P := 3000 \cdot \text{psi}$$

$$P_r := \frac{P}{P_c}$$

$$P_r = 4.498$$

$$\omega := 0.012$$

From Tables E.3 & E.4:

$$Z_0 := 0.819$$

$$Z_1 := 0.234$$

$$Z := Z_0 + \omega \cdot Z_1$$

$$Z = 0.822$$

$$V_{\text{tank}} := \frac{Z \cdot n \cdot R \cdot T}{P}$$

$$V_{\text{tank}} = 5.636 \text{ ft}^3$$

Ans.

3.59  $T := 25\text{K}$

$P := 3.213\text{bar}$

Calculate the effective critical parameters for hydrogen by equations (3.58) and (3.56)

$$T_c := \frac{43.6}{1 + \frac{21.8\text{K}}{2.016T}} \cdot \text{K} \quad T_c = 30.435\text{K}$$

$$P_c := \frac{20.5}{1 + \frac{44.2\text{K}}{2.016T}} \cdot \text{bar} \quad P_c = 10.922\text{bar}$$

$\omega := 0$

$$P_r := \frac{P}{P_c} \quad P_r = 0.294 \quad T_r := \frac{T}{T_c} \quad T_r = 0.821$$

Initial guess of volume:  $V := \frac{R \cdot T}{P} \quad V = 646.903 \frac{\text{cm}^3}{\text{mol}}$

Use the generalized Pitzer correlation

$$B_0 := 0.083 - \frac{0.422}{T_r^{1.6}} \quad B_0 = -0.495 \quad B_1 := 0.139 - \frac{0.172}{T_r^{4.2}} \quad B_1 = -0.254$$

$$Z := 1 + (B_0 + \omega \cdot B_1) \cdot \frac{P_r}{T_r} \quad Z = 0.823 \quad \text{Ans. Experimental: } Z = 0.7757$$

For Redlich/Kwong EOS:

$\sigma := 1 \quad \varepsilon := 0 \quad \Omega := 0.08664 \quad \Psi := 0.42748 \quad \text{Table 3.1}$

$$\alpha(T_r) := T_r^{-0.5} \quad \text{Table 3.1} \quad q(T_r) := \frac{\Psi \alpha(T_r)}{\Omega \cdot T_r} \quad \text{Eq. (3.54)}$$

$$\beta(T_r, P_r) := \frac{\Omega \cdot P_r}{T_r} \quad \text{Eq. (3.53)}$$

Calculate Z      Guess:      Z := 0.9

Given      Eq. (3.52)

$$Z = 1 + \beta(T_r, P_r) - q(T_r) \cdot \beta(T_r, P_r) \cdot \frac{Z - \beta(T_r, P_r)}{Z \cdot (Z + \beta(T_r, P_r))}$$

Z := Find(Z)      Z = 0.791      Ans.      Experimental: Z = 0.7757

3.61 For methane:       $\omega := 0.012$        $T_c := 190.6\text{K}$        $P_c := 45.99\text{bar}$

At standard condition:       $T := \left[ (60 - 32) \cdot \frac{5}{9} + 273.15 \right] \text{K}$       T = 288.706K

Pitzer correlations:      P := 1atm

$$T_r := \frac{T}{T_c} \quad T_r = 1.515 \quad P_r := \frac{P}{P_c} \quad P_r = 0.022$$

$$B_0 := 0.083 - \frac{0.422}{T_r^{1.6}} \quad B_0 = -0.134 \quad B_1 := 0.139 - \frac{0.172}{T_r^{4.2}} \quad B_1 = 0.109$$

$$Z_0 := 1 + B_0 \cdot \frac{P_r}{T_r} \quad Z_0 = 0.998 \quad Z_1 := B_1 \cdot \frac{P_r}{T_r} \quad Z_1 = 0.00158$$

$$Z := Z_0 + \omega \cdot Z_1 \quad Z = 0.998 \quad V_1 := \frac{Z \cdot R \cdot T}{P} \quad V_1 = 0.024 \frac{\text{m}^3}{\text{mol}}$$

(a) At actual condition:       $T := \left[ (50 - 32) \cdot \frac{5}{9} + 273.15 \right] \text{K}$       P := 300psi

Pitzer correlations:      T = 283.15K

$$T_r := \frac{T}{T_c} \quad T_r = 1.486 \quad P_r := \frac{P}{P_c} \quad P_r = 0.45$$

$$B_0 := 0.083 - \frac{0.422}{T_r^{1.6}} \quad B_0 = -0.141$$

$$B_1 := 0.139 - \frac{0.172}{T_r^{4.2}} \quad B_1 = 0.106$$

$$Z_0 := 1 + B_0 \cdot \frac{P_r}{T_r}$$

$$Z_0 = 0.957$$

$$Z_1 := B_1 \cdot \frac{P_r}{T_r}$$

$$Z_1 = 0.0322$$

$$Z := Z_0 + \omega \cdot Z_1$$

$$Z = 0.958$$

$$V_2 := \frac{Z \cdot R \cdot T}{P}$$

$$V_2 = 0.00109 \frac{\text{m}^3}{\text{mol}}$$

$$q_1 := 150 \cdot 10^6 \frac{\text{ft}^3}{\text{day}}$$

$$q_2 := q_1 \cdot \frac{V_2}{V_1}$$

$$q_2 = 6.915 \times 10^6 \frac{\text{ft}^3}{\text{day}}$$

**Ans.**

(b)  $n_1 := \frac{q_1}{V_1}$

$$n_1 = 7.485 \times 10^3 \frac{\text{kmol}}{\text{hr}}$$

**Ans.**

(c)  $D := 22.624 \text{in}$

$$A := \frac{\pi}{4} D^2$$

$$A = 0.259 \text{m}^2$$

$$u := \frac{q_2}{A}$$

$$u = 8.738 \frac{\text{m}}{\text{s}}$$

**Ans.**



3.62

$\omega :=$	(0.012)	$Z_C :=$	(0.286)
	0.087		0.281
	0.1		0.279
	0.140		0.289
	0.152		0.276
	0.181		0.282
	0.187		0.271
	0.19		0.267
	0.191		0.277
	0.194		0.275
	0.196		0.273
	0.2		0.274
	0.205		0.273
	0.21		0.273
	0.21		0.271
	0.212		0.272
	0.218		0.275
	0.23		0.272
	0.235		0.269
	0.252		0.27
	0.262		0.264
	0.28		0.265
	0.297		0.256
	0.301		0.266
	0.302		0.266
	0.303		0.263
	0.31		0.263
	0.322		0.26
	(0.326)		(0.261)

Use the first 29 components in Table B.1 sorted so that  $\omega$  values are in ascending order. This is required for the Mathcad slope and intercept functions.

$m := \text{slope}(\omega, Z_C) = (-0.091)$

$b := \text{intercept}(\omega, Z_C) = (0.291)$

$r := \text{corr}(\omega, Z_C) = (-0.878) \quad r^2 = 0.771$

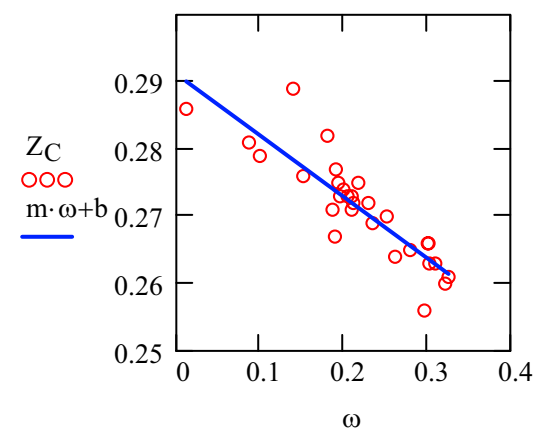

The equation of the line is:  
 $Z_C = 0.291 - 0.091\omega$

Ans.

$$3.65 \quad C_p := \frac{7}{2}R$$

$$T_1 := 298.15K$$

$$T_3 := T_1$$

$$C_v := \frac{5}{2}R$$

$$P_1 := 1\text{bar}$$

$$P_2 := 5\text{bar}$$

$$P_3 := 5\text{bar}$$

$$\gamma := \frac{C_p}{C_v}$$

$$\gamma = 1.4$$

### Step 1->2 Adiabatic compression

$$T_2 := T_1 \cdot \left( \frac{P_2}{P_1} \right)^{\frac{\gamma-1}{\gamma}}$$

$$T_2 = 472.216K$$

$$\Delta U_{12} := C_v \cdot (T_2 - T_1)$$

$$\Delta U_{12} = 3.618 \frac{\text{kJ}}{\text{mol}} \quad \text{Ans.}$$

$$\Delta H_{12} := C_p \cdot (T_2 - T_1)$$

$$\Delta H_{12} = 5.065 \frac{\text{kJ}}{\text{mol}} \quad \text{Ans.}$$

$$Q_{12} := 0 \frac{\text{kJ}}{\text{mol}}$$

$$Q_{12} = 0 \frac{\text{kJ}}{\text{mol}} \quad \text{Ans.}$$

$$W_{12} := \Delta U_{12}$$

$$W_{12} = 3.618 \frac{\text{kJ}}{\text{mol}} \quad \text{Ans.}$$

### Step 2->3 Isobaric cooling

$$\Delta U_{23} := C_v \cdot (T_3 - T_2)$$

$$\Delta U_{23} = -3.618 \frac{\text{kJ}}{\text{mol}} \quad \text{Ans.}$$

$$\Delta H_{23} := C_p \cdot (T_3 - T_2)$$

$$\Delta H_{23} = -5.065 \frac{\text{kJ}}{\text{mol}} \quad \text{Ans.}$$

$$Q_{23} := \Delta H_{23}$$

$$Q_{23} = -5.065 \frac{\text{kJ}}{\text{mol}} \quad \text{Ans.}$$

$$W_{23} := -R \cdot (T_3 - T_2)$$

$$W_{23} = 1.447 \frac{\text{kJ}}{\text{mol}} \quad \text{Ans.}$$

### Step 3->1 Isothermal expansion

$$\Delta U_{31} := C_v \cdot (T_1 - T_3)$$

$$\Delta U_{31} = 0 \frac{\text{kJ}}{\text{mol}} \quad \text{Ans.}$$

$$\Delta H_{31} := C_p \cdot (T_1 - T_3)$$

$$\Delta H_{31} = 0 \frac{\text{kJ}}{\text{mol}} \quad \text{Ans.}$$

$$Q_{31} := -R \cdot T_3 \cdot \ln\left(\frac{P_1}{P_3}\right)$$

$$Q_{31} = 3.99 \frac{\text{kJ}}{\text{mol}} \quad \text{Ans.}$$

$$W_{31} := -Q_{31}$$

$$W_{31} = -3.99 \frac{\text{kJ}}{\text{mol}} \quad \text{Ans.}$$

**For the cycle**

$$Q_{\text{cycle}} := Q_{12} + Q_{23} + Q_{31}$$

$$Q_{\text{cycle}} = -1.076 \frac{\text{kJ}}{\text{mol}} \quad \text{Ans.}$$

$$W_{\text{cycle}} := W_{12} + W_{23} + W_{31}$$

$$W_{\text{cycle}} = 1.076 \frac{\text{kJ}}{\text{mol}} \quad \text{Ans.}$$

**Now assume that each step is irreversible with efficiency:**  $\eta := 80\%$

**Step 1->2 Adiabatic compression**

$$W_{12} := \frac{W_{12}}{\eta}$$

$$W_{12} = 4.522 \frac{\text{kJ}}{\text{mol}} \quad \text{Ans.}$$

$$Q_{12} := \Delta U_{12} - W_{12}$$

$$Q_{12} = -0.904 \frac{\text{kJ}}{\text{mol}} \quad \text{Ans.}$$

**Step 2->3 Isobaric cooling**

$$W_{23} := \frac{W_{23}}{\eta}$$

$$W_{23} = 1.809 \frac{\text{kJ}}{\text{mol}} \quad \text{Ans.}$$

$$Q_{23} := \Delta U_{23} - W_{23}$$

$$Q_{23} = -5.427 \frac{\text{kJ}}{\text{mol}} \quad \text{Ans.}$$

**Step 3->1 Isothermal expansion**

$$W_{31} := \eta \cdot W_{31}$$

$$W_{31} = -3.192 \frac{\text{kJ}}{\text{mol}} \quad \text{Ans.}$$

$$Q_{31} := \Delta U_{31} - W_{31}$$

$$Q_{31} = 3.192 \frac{\text{kJ}}{\text{mol}} \quad \text{Ans.}$$

**For the cycle**

$$Q_{\text{cycle}} := Q_{12} + Q_{23} + Q_{31}$$

$$Q_{\text{cycle}} = -3.14 \frac{\text{kJ}}{\text{mol}} \quad \text{Ans.}$$

$$W_{\text{cycle}} := W_{12} + W_{23} + W_{31}$$

$$W_{\text{cycle}} = 3.14 \frac{\text{kJ}}{\text{mol}} \quad \text{Ans.}$$

3.67 a) PV data are taken from Table F.2 at pressures above 1atm.

$$\begin{array}{l}
 P := \begin{pmatrix} 125 \\ 150 \\ 175 \\ 200 \\ 225 \\ 250 \\ 275 \\ 300 \end{pmatrix} \text{ kPa} \\
 V := \begin{pmatrix} 2109.7 \\ 1757.0 \\ 1505.1 \\ 1316.2 \\ 1169.2 \\ 1051.6 \\ 955.45 \\ 875.29 \end{pmatrix} \cdot \frac{\text{cm}^3}{\text{gm}} \\
 T := (300 + 273.15)\text{K} \\
 M := 18.01 \frac{\text{gm}}{\text{mol}} \\
 Z := \frac{P \cdot V \cdot M}{R \cdot T} \\
 \rho := \frac{1}{V \cdot M} \quad i := 0..7
 \end{array}$$

If a linear equation is fit to the points then the value of B is the y-intercept. Use the Mathcad intercept function to find the y-intercept and hence, the value of B

$$Y_i := \frac{Z_i - 1}{\rho_i} \quad X_i := \rho_i \quad B := \text{intercept}(X, Y) \quad B = -128.42 \frac{\text{cm}^3}{\text{mol}} \quad \text{Ans.}$$

$$A := \text{slope}(X, Y) \quad A = 1.567 \times 10^5 \frac{\text{cm}^6}{\text{mol}^2}$$

$$X := 0 \frac{\text{mol}}{\text{cm}^3}, 10^{-5} \cdot \frac{\text{mol}}{\text{cm}^3} .. 8 \cdot 10^{-5} \cdot \frac{\text{mol}}{\text{cm}^3}$$

Below is a plot of the data along with the linear fit and the extrapolation to the y-intercept.

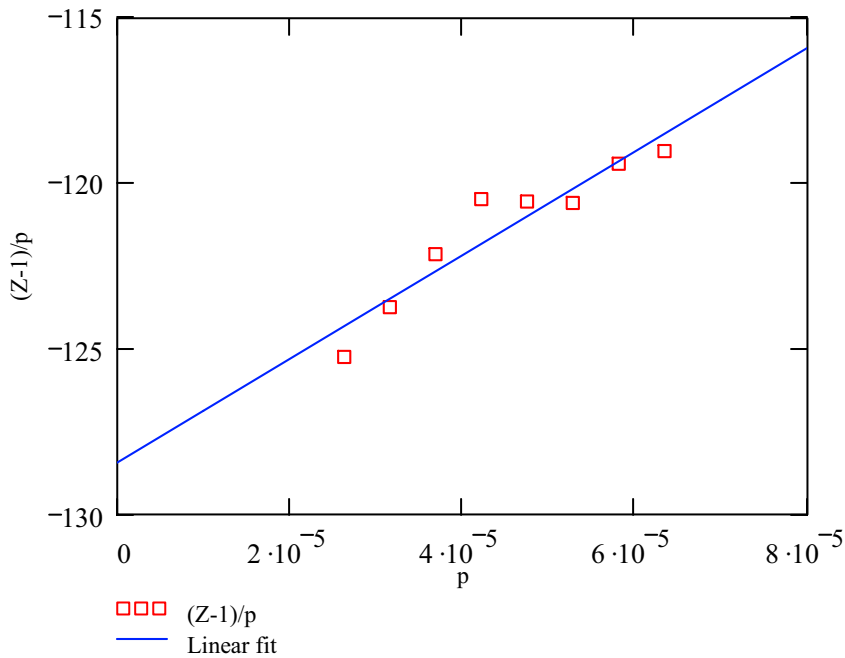

**b) Repeat part a) for T = 350 C**

**PV data are taken from Table F.2 at pressures above 1atm.**

$P := \begin{pmatrix} 125 \\ 150 \\ 175 \\ 200 \\ 225 \\ 250 \\ 275 \\ 300 \end{pmatrix} \text{ kPa}$	$V := \begin{pmatrix} 2295.6 \\ 1912.2 \\ 1638.3 \\ 1432.8 \\ 1273.1 \\ 1145.2 \\ 1040.7 \\ 953.52 \end{pmatrix} \cdot \frac{\text{cm}^3}{\text{gm}}$	$T := (350 + 273.15)\text{K}$
$Z := \frac{P \cdot V \cdot M}{R \cdot T}$	$\rho := \frac{1}{V \cdot M}$	$M := 18.01 \frac{\text{gm}}{\text{mol}}$
	$i := 0..7$	

**If a linear equation is fit to the points then the value of B is the y-intercept. Use the Mathcad intercept function to find the y-intercept and hence, the value of B**

$$Y_i := \frac{Z_i - 1}{\rho_i} \quad X_i := \rho_i \quad B := \text{intercept}(X, Y) \quad B = -105.899 \frac{\text{cm}^3}{\text{mol}} \text{ Ans.}$$

A := slope(X, Y)  $A = 1.784 \times 10^5 \frac{\text{cm}^6}{\text{mol}^2}$

$X := 0 \frac{\text{mol}}{\text{cm}^3}, 10^{-5} \cdot \frac{\text{mol}}{\text{cm}^3} .. 8 \cdot 10^{-5} \cdot \frac{\text{mol}}{\text{cm}^3}$

Below is a plot of the data along with the linear fit and the extrapolation to the y-intercept.

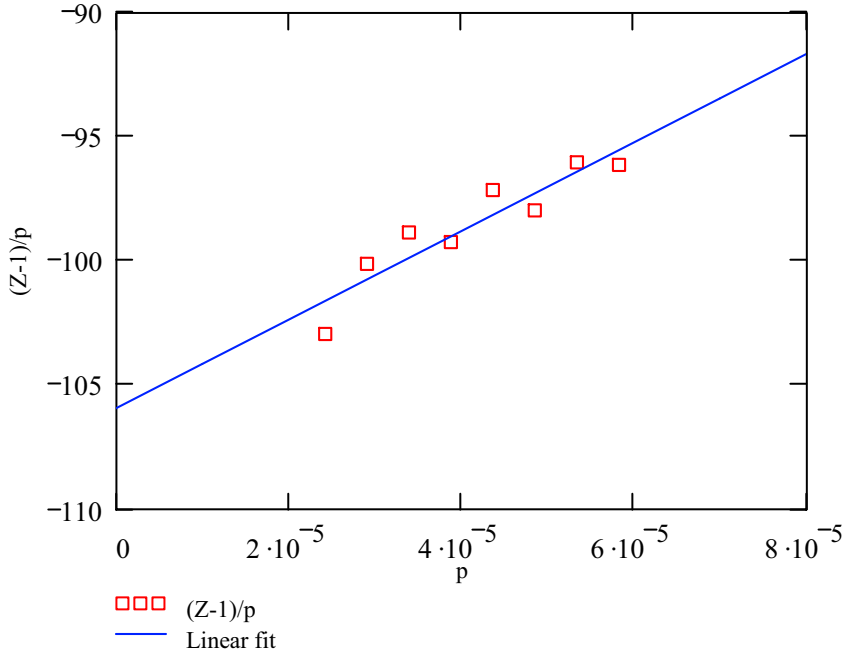

c) Repeat part a) for T = 400 C

PV data are taken from Table F.2 at pressures above 1atm.

$P := \begin{pmatrix} 125 \\ 150 \\ 175 \\ 200 \\ 225 \\ 250 \\ 275 \\ 300 \end{pmatrix} \text{ kPa}$

$V := \begin{pmatrix} 2481.2 \\ 2066.9 \\ 1771.1 \\ 1549.2 \\ 1376.6 \\ 1238.5 \\ 1125.5 \\ 1031.4 \end{pmatrix} \cdot \frac{\text{cm}^3}{\text{gm}}$

$T := (400 + 273.15)\text{K}$

$M := 18.01 \frac{\text{gm}}{\text{mol}}$

$$Z := \frac{\overrightarrow{P \cdot V \cdot M}}{R \cdot T} \quad \rho := \frac{\overrightarrow{1}}{V \cdot M} \quad i := 0..7$$

If a linear equation is fit to the points then the value of B is the y-intercept.

Use the Mathcad intercept function to find the y-intercept and hence, the value of B

$$Y_i := \frac{Z_i - 1}{\rho_i} \quad X_i := \rho_i \quad B := \text{intercept}(X, Y) \quad B = -89.902 \frac{\text{cm}^3}{\text{mol}} \quad \text{Ans.}$$

$$A := \text{slope}(X, Y) \quad A = 2.044 \times 10^5 \frac{\text{cm}^6}{\text{mol}^2}$$

$$X := 0 \frac{\text{mol}}{\text{cm}^3}, 10^{-5} \cdot \frac{\text{mol}}{\text{cm}^3} .. 8 \cdot 10^{-5} \cdot \frac{\text{mol}}{\text{cm}^3}$$

Below is a plot of the data along with the linear fit and the extrapolation to the y-intercept.

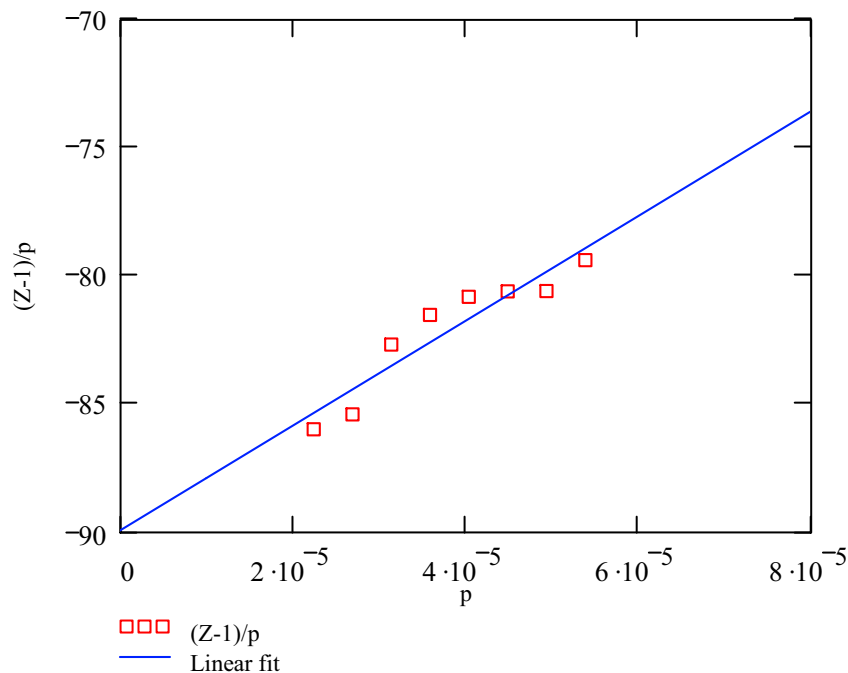

3.70 Create a plot of  $\frac{(Z-1) \cdot Z \cdot T_r}{P_r}$  vs  $\frac{P_r}{Z \cdot T_r}$

Data from Appendix E at  $T_r = 1$

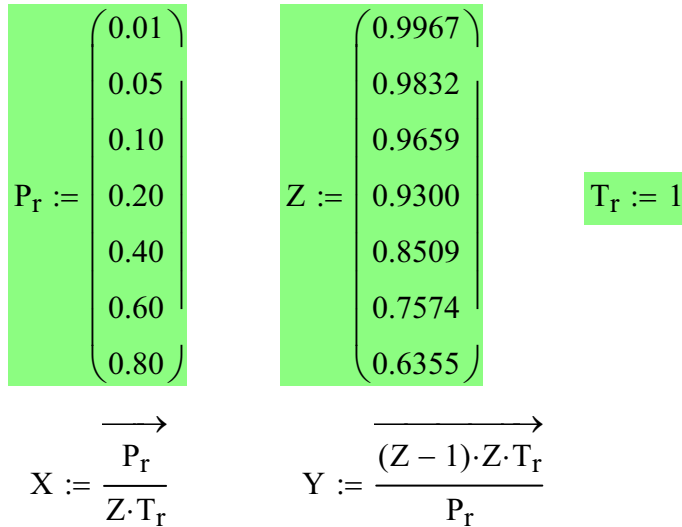

Create a linear fit of Y vs X

Slope := slope(X, Y)

Slope = 0.033

Intercept := intercept(X, Y)

Intercept = -0.332

Rsquare := corr(X, Y)

Rsquare = 0.9965

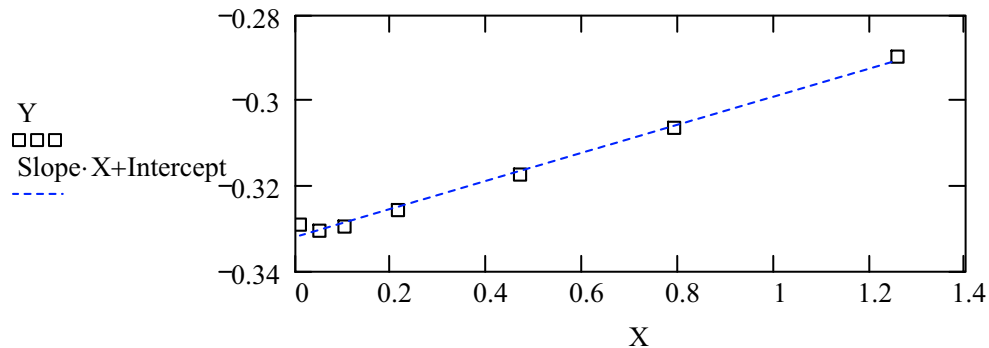

The second virial coefficient (Bhat) is the value when  $X \rightarrow 0$

Bhat := Intercept

Bhat = -0.332

Ans.

By Eqns. (3.65) and (3.66)  $B_0 := 0.083 - \frac{0.422}{T_r^{1.6}}$

$B_0 = -0.339$

Ans.

These values differ by 2%.



### 3.71 Use the SRK equation to calculate Z

$$T_c := 150.9 \cdot K \quad T := (30 + 273.15) \quad T_r := \frac{T}{T_c} \quad T_r = 2.009$$

$$P_c := 48.98 \cdot \text{bar} \quad P := 300 \cdot \text{bar} \quad P_r := \frac{P}{P_c} \quad P_r = 6.125$$

$$\omega := 0.0$$

$$\sigma := 1 \quad \varepsilon := 0 \quad \Omega := 0.08664 \quad \Psi := 0.42748 \quad \text{Table 3.1}$$

$$\alpha(T_r, \omega) := \left[ 1 + \left( 0.480 + 1.574\omega - 0.176\omega^2 \right) \cdot \left( 1 - T_r^{\frac{1}{2}} \right) \right]^2 \quad \text{Table 3.1}$$

$$q(T_r) := \frac{\Psi \alpha(T_r, \omega)}{\Omega \cdot T_r} \quad \text{Eq. (3.54)} \quad \beta(T_r, P_r) := \frac{\Omega \cdot P_r}{T_r} \quad \text{Eq. (3.53)}$$

Calculate Z                      Guess:                      Z := 0.9

Given                      Eq. (3.52)

$$Z = 1 + \beta(T_r, P_r) - q(T_r) \cdot \beta(T_r, P_r) \cdot \frac{Z - \beta(T_r, P_r)}{(Z + \varepsilon \beta(T_r, P_r)) \cdot (Z + \sigma \beta(T_r, P_r))}$$

$$Z := \text{Find}(Z) \quad Z = 1.025 \quad V := \frac{Z \cdot R \cdot T}{P} \quad V = 86.1 \frac{\text{cm}^3}{\text{mol}} \quad \text{Ans.}$$

This volume is within 2.5% of the ideal gas value.

### 3.72 After the reaction is complete, there will be 5 moles of C<sub>2</sub>H<sub>2</sub> and 5 moles of Ca(OH)<sub>2</sub>.

First calculate the volume available for the gas.

$$n := 5 \text{ mol} \quad V_t := 0.4 \cdot 1800 \cdot \text{cm}^3 - 5 \cdot \text{mol} \cdot 33.0 \cdot \frac{\text{cm}^3}{\text{mol}} \quad V_t = 555 \text{ cm}^3$$

$$V := \frac{V_t}{n} \quad V = 111 \frac{\text{cm}^3}{\text{mol}}$$

Use SRK equation to calculate pressure.

$$T_c := 308.3 \cdot \text{K} \quad T := (125 + 273.15) \cdot \text{K} \quad T_r := \frac{T}{T_c} \quad T_r = 1.291$$

$$P_c := 61.39 \cdot \text{bar} \quad \omega := 0.0$$

$$\sigma := 1 \quad \varepsilon := 0 \quad \Omega := 0.08664 \quad \Psi := 0.42748 \quad \text{Table 3.1}$$

$$\alpha(T_r, \omega) := \left[ 1 + \left( 0.480 + 1.574\omega - 0.176\omega^2 \right) \cdot \left( 1 - T_r^{\frac{1}{2}} \right) \right]^2 \quad \text{Table 3.1}$$

$$q(T_r) := \frac{\Psi \alpha(T_r, \omega)}{\Omega \cdot T_r} \quad \text{Eq. (3.54)}$$

$$a := \Psi \cdot \frac{\alpha(T_r, \omega) \cdot R^2 \cdot T_c^2}{P_c} \quad \text{Eq. (3.45)}$$

$$b := \Omega \cdot \frac{R \cdot T_c}{P_c} \quad \text{Eq. (3.46)}$$

$$a = 3.995 \frac{\text{m}^3 \cdot \text{bar} \cdot \text{cm}^3}{\text{mol}^2}$$

$$b = 36.175 \frac{\text{cm}^3}{\text{mol}}$$

$$P := \frac{R \cdot T}{V - b} - \frac{a}{V \cdot (V + b)} \quad P = 197.8 \text{ bar} \quad \text{Ans.}$$

3.73 mass := 35000kg      T := (10 + 273.15)K

$$\omega := 0.152 \quad T_c := 369.8 \text{K} \quad P_c := 42.48 \text{bar} \quad M := 44.097 \frac{\text{gm}}{\text{mol}}$$

$$Z_c := 0.276 \quad V_c := 200.0 \frac{\text{cm}^3}{\text{mol}} \quad n := \frac{\text{mass}}{M} \quad n = 7.937 \times 10^5 \text{ mol}$$

a) Estimate the volume of gas using the truncated virial equation

$$T_r := \frac{T}{T_c} \quad T_r = 0.766 \quad P := 1 \text{ atm} \quad P_r := \frac{P}{P_c}$$

$$B_0 := 0.083 - \frac{0.422}{T_r^{1.6}} \quad \text{Eq. (3-65)} \quad B_1 := 0.139 - \frac{0.172}{T_r^{4.2}} \quad \text{Eq. (3-66)}$$

$$B_0 = -0.564$$

$$B_1 = -0.389$$

$$Z := 1 + (B_0 + \omega \cdot B_1) \cdot \frac{P_r}{T_r}$$

$$Z = 0.981$$

$$V_t := \frac{Z \cdot n \cdot R \cdot T}{P}$$

$$V_t = -2.379 \times 10^7 \text{ m}^3$$

This would require a very large tank. If the tank were spherical the diameter would be:

$$D := \sqrt[3]{\frac{6}{\pi} \cdot V_t}$$

$$D = 32.565 \text{ m}$$

b) Calculate the molar volume of the liquid with the Rackett equation(3.72)

$$V_{\text{liq}} := V_c \cdot Z_c \left(1 - T_r\right)^{0.2857}$$

$$V_{\text{liq}} = 85.444 \frac{\text{cm}^3}{\text{mol}}$$

$$P := 6.294 \text{ atm}$$

$$P_r := \frac{P}{P_c}$$

$$P_r = 0.15$$

$$Z := 1 + (B_0 + \omega \cdot B_1) \cdot \frac{P_r}{T_r}$$

$$Z = 0.878$$

$$V_{\text{vap}} := \frac{Z \cdot R \cdot T}{P}$$

$$V_{\text{vap}} = 3.24 \times 10^3 \frac{\text{cm}^3}{\text{mol}}$$

**Guess:**  $V_{\text{tank}} := 90\% \cdot V_{\text{liq}} \cdot n$

Given  $90\% \cdot \frac{V_{\text{tank}}}{V_{\text{liq}}} + 10\% \cdot \frac{V_{\text{tank}}}{V_{\text{vap}}} = n$

$$V_{\text{tank}} := \text{Find}(V_{\text{tank}})$$

$$V_{\text{tank}} = 75.133 \text{ m}^3$$

This would require a small tank. If the tank were spherical, the diameter would be:

$$D := \sqrt[3]{\frac{6}{\pi} \cdot V_{\text{tank}}}$$

$$D = 5.235 \text{ m}$$

Although the tank is smaller, it would need to accommodate a pressure of 6.294 atm (92.5 psi). Also, refrigeration would be required to liquify the gaseous propane stream.

## Chapter 4 - Section A - Mathcad Solutions

4.1 (a)  $T_0 := 473.15 \cdot \text{K}$        $T := 1373.15 \cdot \text{K}$        $n := 10 \cdot \text{mol}$

For SO<sub>2</sub>:  $A := 5.699$      $B := 0.801 \cdot 10^{-3}$      $C := 0.0$      $D := -1.015 \cdot 10^5$

$$\Delta H := R \cdot \text{ICPH}(T_0, T, A, B, C, D)$$

$$\Delta H = 47.007 \frac{\text{kJ}}{\text{mol}} \qquad Q := n \cdot \Delta H$$

$$Q = 470.073 \text{ kJ} \quad \text{Ans.}$$

(b)  $T_0 := 523.15 \cdot \text{K}$        $T := 1473.15 \cdot \text{K}$        $n := 12 \cdot \text{mol}$

For propane  $A := 1.213$      $B := 28.785 \cdot 10^{-3}$      $C := -8.824 \cdot 10^{-6}$      $D := 0$

$$\Delta H := R \cdot \text{ICPH}(T_0, T, A, B, C, 0.0)$$

$$\Delta H = 161.834 \frac{\text{kJ}}{\text{mol}} \qquad Q := n \cdot \Delta H$$

$$Q = 1.942 \times 10^3 \text{ kJ} \quad \text{Ans.}$$

4.2 (a)  $T_0 := 473.15 \cdot \text{K}$        $n := 10 \cdot \text{mol}$        $Q := 800 \cdot \text{kJ}$

For ethylene:  $A := 1.424$      $B := \frac{14.394 \cdot 10^{-3}}{\text{K}}$      $C := \frac{-4.392 \cdot 10^{-6}}{\text{K}^2}$

$\tau := 2$  (guess)      Given

$$Q = n \cdot R \cdot \left[ \left[ A \cdot \tau_0 \cdot () - 1 + \frac{B}{2} \cdot \tau_0^2 \cdot ()^2 - 1 \right] + \frac{C}{3} \cdot \tau_0^3 \cdot ()^3 - 1 \right]$$

$\tau := \text{Find}(\tau)$        $\tau = 2.905$        $T := \tau \cdot T_0$        $T = 1374.5 \text{ K}$       **Ans.**

(b)  $T_0 := 533.15 \cdot \text{K}$        $n := 15 \cdot \text{mol}$        $Q := 2500 \cdot \text{kJ}$

For 1-butene:  $A := 1.967$      $B := \frac{31.630 \cdot 10^{-3}}{\text{K}}$      $C := \frac{-9.873 \cdot 10^{-6}}{\text{K}^2}$

$$\tau := 3 \quad \text{(guess)} \quad \text{Given}$$

$$Q = n \cdot R \cdot \left[ \left[ A \cdot T_0 \cdot () - 1 + \frac{B}{2} \cdot T_0^2 \cdot ()^2 - 1 \right] + \frac{C}{3} \cdot T_0^3 \cdot ()^3 - 1 \right]$$

$$\tau := \text{Find}(\tau) \quad \tau = 2.652 \quad T := \tau \cdot T_0 \quad T = 1413.8 \text{ K} \quad \text{Ans.}$$

(c)  $T_0 := 500 \cdot \text{degF}$        $n := 40 \cdot \text{lbmol}$        $Q := 10^6 \cdot \text{BTU}$

Values converted to SI units

$$T_0 := 533.15 \text{ K} \quad n = 1.814 \times 10^4 \text{ mol} \quad Q = 1.055 \times 10^6 \text{ kJ}$$

For ethylene:  $A := 1.424$        $B := \frac{14.394 \cdot 10^{-3}}{\text{K}}$        $C := \frac{-4.392 \cdot 10^{-6}}{\text{K}^2}$

$$\tau := 2 \quad \text{(guess)} \quad \text{Given}$$

$$Q = n \cdot R \cdot \left[ \left[ A \cdot T_0 \cdot () - 1 + \frac{B}{2} \cdot T_0^2 \cdot ()^2 - 1 \right] + \frac{C}{3} \cdot T_0^3 \cdot ()^3 - 1 \right]$$

$$\tau := \text{Find}(\tau) \quad \tau = 2.256 \quad T := \tau \cdot T_0 \quad T = 1202.8 \text{ K} \quad \text{Ans.}$$

$$T = 1705.4 \text{ degF}$$

4.3 Assume air at the given conditions an ideal gas. Basis of calculation is 1 second.

$$P := 1 \cdot \text{atm} \quad T_0 := 122 \cdot \text{degF} \quad V := 250 \cdot \text{ft}^3 \quad T := 932 \cdot \text{degF}$$

Convert given values to SI units       $V = 7.079 \text{ m}^3$

$$T := (T - 32 \text{ degF}) + 273.15 \text{ K} \quad T_0 := (T_0 - 32 \text{ degF}) + 273.15 \text{ K}$$

$$T = 773.15 \text{ K} \quad T_0 = 323.15 \text{ K}$$

$$n := \frac{P \cdot V}{R \cdot T_0} \quad n = 266.985 \text{ mol}$$

For air:  $A := 3.355$        $B := 0.575 \cdot 10^{-3}$        $C := 0.0$        $D := -0.016 \cdot 10^5$

$$\Delta H := R \cdot \text{ICPH}(T_0, T, A, B, C, D)$$

$$\Delta H = 13.707 \frac{\text{kJ}}{\text{mol}}$$

$$Q := n \cdot \Delta H$$

$$Q = 3.469 \times 10^3 \text{ BTU} \quad \text{Ans.}$$

$$4.4 \quad \text{molwt} := 100.1 \frac{\text{gm}}{\text{mol}}$$

$$T_0 := 323.15 \cdot \text{K}$$

$$T := 1153.15 \cdot \text{K}$$

$$n := \frac{10000 \cdot \text{kg}}{\text{molwt}}$$

$$n = 9.99 \times 10^4 \text{ mol}$$

$$\text{For CaCO}_3: \quad A := 12.572 \quad B := 2.637 \cdot 10^{-3} \quad C := 0.0 \quad D := -3.120 \cdot 10^5$$

$$\Delta H := R \cdot \text{ICPH}(T_0, T, A, B, C, D)$$

$$\Delta H = 9.441 \times 10^4 \frac{\text{J}}{\text{mol}}$$

$$Q := n \cdot \Delta H$$

$$Q = 9.4315 \times 10^6 \text{ kJ} \quad \text{Ans.}$$

4.7 Let step 12 represent the initial reversible adiabatic expansion, and step 23 the final constant-volume heating.

$$T_1 := 298.15 \cdot \text{K}$$

$$T_3 := 298.15 \cdot \text{K}$$

$$P_1 := 121.3 \cdot \text{kPa}$$

$$P_2 := 101.3 \cdot \text{kPa}$$

$$P_3 := 104.0 \cdot \text{kPa}$$

$$T_2 := T_3 \cdot \frac{P_2}{P_3}$$

$$C_P := 30 \cdot \frac{\text{J}}{\text{mol} \cdot \text{K}}$$

(guess)

$$T_2 = 290.41 \text{ K}$$

$$\text{Given} \quad T_2 = T_1 \cdot \left( \frac{P_2}{P_1} \right)^{\frac{R}{C_P}}$$

$$C_P := \text{Find}(C_P)$$

$$C_P = 56.95 \frac{\text{J}}{\text{mol} \cdot \text{K}} \quad \text{Ans.}$$

$$4.9 \text{ a) Acetone:} \quad T_c := 508.2 \text{ K} \quad P_c := 47.01 \text{ bar} \quad T_n := 329.4 \text{ K}$$

$$\Delta H_n := 29.10 \frac{\text{kJ}}{\text{mol}}$$

$$T_m := \frac{T_n}{T_c}$$

$$T_m = 0.648$$

Use Eq. (4.12) to calculate  $\Delta H$  at  $T_n$  ( $\Delta H_{\text{ncalc}}$ )

$$\Delta H_{\text{ncalc}} := R \cdot T_n \cdot \frac{1.092 \cdot \left( \ln \left( \frac{P_c}{\text{bar}} \right) - 1.013 \right)}{0.930 - T_m}$$

$$\Delta H_{\text{ncalc}} = 30.108 \frac{\text{kJ}}{\text{mol}} \quad \text{Ans.}$$

To compare with the value listed in Table B.2, calculate the % error.

$$\%error := \frac{\Delta H_{n\text{calc}} - \Delta H_n}{\Delta H_n} \quad \%error = 3.464\%$$

Values for other components in Table B.2 are given below. Except for acetic acid, acetonitrile, methanol and nitromethane, agreement is within 5% of the reported value.

	$\Delta H_n$ (kJ/mol)	% error
Acetone	30.1	3.4%
Acetic Acid	40.1	69.4%
Acetonitrile	33.0	9.3%
Benzene	30.6	-0.5%
iso-Butane	21.1	-0.7%
n-Butane	22.5	0.3%
1-Butanol	41.7	-3.6%
Carbon tetrachloride	29.6	-0.8%
Chlorobenzene	35.5	0.8%
Chloroform	29.6	1.1%
Cyclohexane	29.7	-0.9%
Cyclopentane	27.2	-0.2%
n-Decane	40.1	3.6%
Dichloromethane	27.8	-1.0%
Diethyl ether	26.6	0.3%
Ethanol	40.2	4.3%
Ethylbenzene	35.8	0.7%
Ethylene glycol	51.5	1.5%
n-Heptane	32.0	0.7%
n-Hexane	29.0	0.5%
Methanol	38.3	8.7%
Methyl acetate	30.6	1.1%
Methyl ethyl ketone	32.0	2.3%
Nitromethane	36.3	6.7%
n-Nonane	37.2	0.8%
iso-Octane	30.7	-0.2%
n-Octane	34.8	1.2%
n-Pentane	25.9	0.3%
Phenol	46.6	1.0%
1-Propanol	41.1	-0.9%
2-Propanol	39.8	-0.1%
Toluene	33.4	0.8%
Water	42.0	3.3%
o-Xylene	36.9	1.9%
m-Xylene	36.5	2.3%
p-Xylene	36.3	1.6%

b)

$$T_c := \begin{pmatrix} 469.7 \\ 507.6 \\ 562.2 \\ 560.4 \end{pmatrix} \text{K}$$

$$P_c := \begin{pmatrix} 33.70 \\ 30.25 \\ 48.98 \\ 43.50 \end{pmatrix} \text{bar}$$

$$\Delta H_n := \begin{pmatrix} 25.79 \\ 28.85 \\ 30.72 \\ 29.97 \end{pmatrix} \frac{\text{kJ}}{\text{mol}}$$

$$T_n := \begin{pmatrix} 36.0 \\ 68.7 \\ 80.0 \\ 80.7 \end{pmatrix} + 273.15 \text{K}$$

$$\Delta H_{25} := \begin{pmatrix} 366.3 \\ 366.1 \\ 433.3 \\ 392.5 \end{pmatrix} \frac{\text{J}}{\text{gm}}$$

$$M := \begin{pmatrix} 72.150 \\ 86.177 \\ 78.114 \\ 82.145 \end{pmatrix} \frac{\text{gm}}{\text{mol}}$$

$$T_{r1} := \frac{T_n}{T_c} \quad T_{r2} := \frac{(25 + 273.15)\text{K}}{T_c} \quad \Delta H_2 := \overrightarrow{(\Delta H_{25} \cdot M)} \quad \Delta H_1 := \Delta H_n$$

$$T_{r1} = \begin{pmatrix} 0.658 \\ 0.673 \\ 0.628 \\ 0.631 \end{pmatrix} \quad \Delta H_2 = \begin{pmatrix} 26.429 \\ 31.549 \\ 33.847 \\ 32.242 \end{pmatrix} \frac{\text{kJ}}{\text{mol}}$$

$$\Delta H_{2\text{calc}} := \overrightarrow{\left[ \Delta H_1 \cdot \left( \frac{1 - T_{r2}}{1 - T_{r1}} \right)^{0.38} \right]}$$

Eq. (4.13) %error :=  $\frac{\Delta H_{2\text{calc}} - \Delta H_2}{\Delta H_2}$

$$\Delta H_{2\text{calc}} = \begin{pmatrix} 26.448 \\ 31.533 \\ 33.571 \\ 32.816 \end{pmatrix} \frac{\text{kJ}}{\text{mol}} \text{ Ans.}$$

$$\Delta H_2 = \begin{pmatrix} 26.429 \\ 31.549 \\ 33.847 \\ 32.242 \end{pmatrix} \frac{\text{kJ}}{\text{mol}}$$

$$\%error = \begin{pmatrix} 0.072 \\ -0.052 \\ -0.814 \\ 1.781 \end{pmatrix} \%$$

The values calculated with Eq. (4.13) are within 2% of the handbook values.

**4.10** The  $\ln P$  vs.  $1/T$  relation over a short range is very nearly linear. Our procedure is therefore to take 5 points, including the point at the temperature of interest and two points on either side, and to do a linear least-squares fit, from which the required derivative in Eq. (4.11) can be found. Temperatures are in rankines, pressures in psia, volumes in cu ft/lbm, and enthalpies in Btu/lbm. The molar mass  $M$  of tetrafluoroethane is 102.04. The factor 5.4039 converts energy units from (psia)(cu ft) to Btu.



$$(a) \quad T := 459.67 + 5 \quad \Delta V := 1.934 - 0.012 \quad i := 1..5$$

$$\text{Data: } P := \begin{pmatrix} 18.787 \\ 21.162 \\ 23.767 \\ 26.617 \\ 29.726 \end{pmatrix} \quad t := \begin{pmatrix} -5 \\ 0 \\ 5 \\ 10 \\ 15 \end{pmatrix} \quad x_i := \frac{1}{t_i + 459.67} \quad y_i := \ln(P_i)$$

$$\text{slope} := \text{slope}(x, y) \quad \text{slope} = -4952$$

$$dPdT := \frac{(-P)_3}{T^2} \cdot \text{slope} \quad dPdT = 0.545$$

$$\Delta H := \frac{T \cdot \Delta V \cdot dPdT}{5.4039} \quad \Delta H = 90.078 \quad \text{Ans.}$$

The remaining parts of the problem are worked in exactly the same way. All answers are as follows, with the Table 9.1 value in ( ):

$$(a) \quad \Delta H = 90.078 \quad (90.111)$$

$$(b) \quad \Delta H = 85.817 \quad (85.834)$$

$$(c) \quad \Delta H = 81.034 \quad (81.136)$$

$$(d) \quad \Delta H = 76.007 \quad (75.902)$$

$$(e) \quad \Delta H = 69.863 \quad (69.969)$$

$$4.11 \quad M := \begin{pmatrix} 119.377 \\ 32.042 \\ 153.822 \end{pmatrix} \cdot \frac{\text{gm}}{\text{mol}} \quad T_c := \begin{pmatrix} 536.4 \\ 512.6 \\ 556.4 \end{pmatrix} \cdot \text{K} \quad P_c := \begin{pmatrix} 54.72 \\ 80.97 \\ 45.60 \end{pmatrix} \cdot \text{bar} \quad T_n := \begin{pmatrix} 334.3 \\ 337.9 \\ 349.8 \end{pmatrix} \cdot \text{K}$$

$\Delta H$  is the value at 0 degC.

$\Delta H_{\text{exp}}$  is the given value at the normal boiling point.

$$T_{r1} := \frac{273.15\text{K}}{T_c}$$

$$T_{r2} := \frac{T_n}{T_c}$$

$$\Delta H := \begin{pmatrix} 270.9 \\ 1189.5 \\ 217.8 \end{pmatrix} \cdot \frac{\text{J}}{\text{gm}} \quad \Delta H_{\text{exp}} := \begin{pmatrix} 246.9 \\ 1099.5 \\ 194.2 \end{pmatrix} \cdot \frac{\text{J}}{\text{gm}} \quad T_{r1} = \begin{pmatrix} 0.509 \\ 0.533 \\ 0.491 \end{pmatrix} \quad T_{r2} = \begin{pmatrix} 0.623 \\ 0.659 \\ 0.629 \end{pmatrix}$$

(a) By Eq. (4.13) 
$$\Delta H_n := \left[ \Delta H \cdot \left( \frac{1 - T_{r2}}{1 - T_{r1}} \right)^{0.38} \right]$$

PCE := 
$$\left( \frac{\Delta H_n - \Delta H_{\text{exp}}}{\Delta H_{\text{exp}}} \cdot 100\% \right)$$
 **This is the % error**

$$\Delta H_n = \begin{pmatrix} 245 \\ 1055.2 \\ 193.2 \end{pmatrix} \frac{\text{J}}{\text{gm}} \quad \text{PCE} = \begin{pmatrix} -0.77 \\ -4.03 \\ -0.52 \end{pmatrix} \%$$

(b) By Eq. (4.12): 
$$\Delta H_n := \left[ \frac{R \cdot T_n}{M} \cdot \frac{1.092 \cdot \left( \ln \left( \frac{P_c}{\text{bar}} \right) - 1.013 \right)}{0.930 - T_{r2}} \right]$$

PCE := 
$$\left( \frac{\Delta H_n - \Delta H_{\text{exp}}}{\Delta H_{\text{exp}}} \cdot 100\% \right)$$

$$\Delta H_n = \begin{pmatrix} 247.7 \\ 1195.3 \\ 192.3 \end{pmatrix} \frac{\text{J}}{\text{gm}} \quad \text{PCE} = \begin{pmatrix} 0.34 \\ 8.72 \\ -0.96 \end{pmatrix} \%$$

#### 4.12 Acetone

$$\omega := 0.307$$

$$T_c := 508.2\text{K}$$

$$P_c := 47.01\text{bar}$$

$$Z_c := 0.233$$

$$V_c := 209 \cdot \frac{\text{cm}^3}{\text{mol}}$$

$$T_n := 329.4\text{K}$$

$$P := 1\text{atm}$$

$$\Delta H_n := 29.1 \frac{\text{kJ}}{\text{mol}}$$

$$T_r := \frac{T_n}{T_c}$$

$$T_r = 0.648$$

$$P_r := \frac{P}{P_c}$$

$$P_r = 0.022$$

## Generalized Correlations to estimate volumes

### Vapor Volume

$$B_0 := 0.083 - \frac{0.422}{T_r^{1.6}} \quad B_0 = -0.762 \quad \text{Eq. (3.65)}$$

$$B_1 := 0.139 - \frac{0.172}{T_r^{4.2}} \quad B_1 = -0.924 \quad \text{Eq. (3.66)}$$

$$Z := 1 + B_0 \cdot \frac{P_r}{T_r} + B_1 \cdot \frac{P_r}{T_r} \quad Z = 0.965 \quad (\text{Pg. 102})$$

$$V := \frac{Z \cdot R \cdot T_n}{P} \quad V = 2.609 \times 10^4 \frac{\text{cm}^3}{\text{mol}}$$

### Liquid Volume

$$V_{\text{sat}} := V_c \cdot Z_c \left(1 - T_r\right)^{\frac{2}{7}} \quad \text{Eq. (3.72)} \quad V_{\text{sat}} = 70.917 \frac{\text{cm}^3}{\text{mol}}$$

Combining the Clapyeron equation (4.11)  $\Delta H = T \cdot \Delta V \cdot \frac{d}{dT} P_{\text{sat}}$

with Antoine's Equation  $P_{\text{sat}} = e^{A - \frac{B}{T+C}}$

gives 
$$\Delta H = T \cdot \Delta V \cdot \frac{B}{(T+C)^2} \cdot e^{\left[A - \frac{B}{(T+C)}\right]}$$

$$\Delta V := V - V_{\text{sat}} \quad \Delta V = 2.602 \times 10^4 \frac{\text{cm}^3}{\text{mol}}$$

$$A := 14.3145$$

$$B := 2756.22$$

$$C := 228.060$$

$$\Delta H_{\text{calc}} := T_n \cdot \Delta V \cdot \left[ \frac{B}{\left( \frac{T_n - 273.15\text{K}}{K} + C \right)^2} \cdot e^{-\left[ A \cdot \frac{B}{\left( \frac{T_n - 273.15\text{K}}{K} + C \right)} \right]} \right] \frac{\text{kPa}}{K}$$

$$\Delta H_{\text{calc}} = 29.662 \frac{\text{kJ}}{\text{mol}} \quad \text{Ans.} \quad \% \text{error} := \frac{\Delta H_{\text{calc}} - \Delta H_n}{\Delta H_n} \quad \% \text{error} = 1.9\%$$

The table below shows the values for other components in Table B.2. Values agree within 5% except for acetic acid.

	$\Delta H_n$ (kJ/mol)	% error
Acetone	29.7	1.9%
Acetic Acid	37.6	58.7%
Acetonitrile	31.3	3.5%
Benzene	30.8	0.2%
iso-Butane	21.2	-0.7%
n-Butane	22.4	0.0%
1-Butanol	43.5	0.6%
Carbon tetrachloride	29.9	0.3%
Chlorobenzene	35.3	0.3%
Chloroform	29.3	0.1%
Cyclohexane	29.9	-0.1%
Cyclopentane	27.4	0.4%
n-Decane	39.6	2.2%
Dichloromethane	28.1	0.2%
Diethyl ether	26.8	0.9%
Ethanol	39.6	2.8%
Ethylbenzene	35.7	0.5%
Ethylene glycol	53.2	4.9%
n-Heptane	31.9	0.4%
n-Hexane	29.0	0.4%
Methanol	36.5	3.6%
Methyl acetate	30.4	0.2%
Methyl ethyl ketone	31.7	1.3%
Nitromethane	34.9	2.6%
n-Nonane	37.2	0.7%
iso-Octane	30.8	-0.1%
n-Octane	34.6	0.6%
n-Pentane	25.9	0.2%
Phenol	45.9	-0.6%
1-Propanol	41.9	1.1%

<b>2-Propanol</b>	<b>40.5</b>	<b>1.7%</b>
<b>Toluene</b>	<b>33.3</b>	<b>0.5%</b>
<b>Water</b>	<b>41.5</b>	<b>2.0%</b>
<b>o-Xylene</b>	<b>36.7</b>	<b>1.2%</b>
<b>m-Xylene</b>	<b>36.2</b>	<b>1.4%</b>
<b>p-Xylene</b>	<b>35.9</b>	<b>0.8%</b>

**4.13 Let P represent the vapor pressure.**

$$T := 348.15 \cdot K \quad P := 100 \cdot \text{kPa} \quad (\text{guess})$$

$$\text{Given} \quad \ln\left(\frac{P}{\text{kPa}}\right) = 48.157543 - \frac{5622.7 \cdot K}{T} - 4.70504 \cdot \ln\left(\frac{T}{K}\right)$$

$$P := \text{Find}(P) \quad dPdT := P \cdot \left( \frac{5622.7 \cdot K}{T^2} - \frac{4.70504}{T} \right) \quad dPdT = 0.029 \frac{\text{bar}}{K}$$

$$P = 87.396 \text{ kPa} \quad \Delta H := 31600 \cdot \frac{\text{joule}}{\text{mol}} \quad V_{\text{liq}} := 96.49 \cdot \frac{\text{cm}^3}{\text{mol}}$$

$$\text{Clapeyron equation:} \quad dPdT = \frac{\Delta H}{T \cdot (V - V_{\text{liq}})}$$

$$V = \text{vapor molar volume.} \quad V := V_{\text{liq}} + \frac{\Delta H}{T \cdot dPdT}$$

$$\text{Eq. (3.39)} \quad B := V \cdot \left( \frac{P \cdot V}{R \cdot T} - 1 \right) \quad B = -1369.5 \frac{\text{cm}^3}{\text{mol}} \quad \text{Ans.}$$

$$\text{4.14 (a) Methanol:} \quad T_c := 512.6K \quad P_c := 80.97\text{bar} \quad T_n := 337.9K$$

$$A_L := 13.431 \quad B_L := -51.28 \cdot 10^{-3} \quad C_L := 131.13 \cdot 10^{-6}$$

$$C_{PL}(T) := \left( A_L + \frac{B_L}{K} \cdot T + \frac{C_L}{K^2} \cdot T^2 \right) \cdot R$$

$$A_V := 2.211 \quad B_V := 12.216 \cdot 10^{-3} \quad C_V := -3.450 \cdot 10^{-6}$$

$$C_{PV}(T) := \left( A_V + \frac{B_V}{K} \cdot T + \frac{C_V}{K^2} \cdot T^2 \right) \cdot R$$

$$P := 3\text{bar}$$

$$T_{\text{sat}} := 368.0\text{K}$$

$$T_1 := 300\text{K}$$

$$T_2 := 500\text{K}$$

Estimate  $\Delta H_v$  using Riedel equation (4.12) and Watson correction (4.13)

$$T_{rn} := \frac{T_n}{T_c}$$

$$T_{rn} = 0.659$$

$$T_{rsat} := \frac{T_{\text{sat}}}{T_c}$$

$$T_{rsat} = 0.718$$

$$\Delta H_n := \frac{1.092 \cdot \left( \ln\left(\frac{P_c}{\text{bar}}\right) - 1.013 \right)}{0.930 - T_{rn}} \cdot R \cdot T_n$$

$$\Delta H_n = 38.301 \frac{\text{kJ}}{\text{mol}}$$

$$\Delta H_v := \Delta H_n \cdot \left( \frac{1 - T_{rsat}}{1 - T_{rn}} \right)^{0.38}$$

$$\Delta H_v = 35.645 \frac{\text{kJ}}{\text{mol}}$$

$$\Delta H := \int_{T_1}^{T_{\text{sat}}} C_{PL}(T) dT + \Delta H_v + \int_{T_{\text{sat}}}^{T_2} C_{PV}(T) dT$$

$$\Delta H = 49.38 \frac{\text{kJ}}{\text{mol}}$$

$$n := 100 \frac{\text{kmol}}{\text{hr}}$$

$$Q := n \cdot \Delta H$$

$$Q = 1.372 \times 10^3 \text{ kW}$$

Ans.

(b) Benzene:

$$\Delta H_v = 28.273 \frac{\text{kJ}}{\text{mol}}$$

$$\Delta H = 55.296 \frac{\text{kJ}}{\text{mol}}$$

$$Q = 1.536 \cdot 10^3 \text{ kW}$$

(c) Toluene

$$\Delta H_v = 30.625 \frac{\text{kJ}}{\text{mol}}$$

$$\Delta H = 65.586 \frac{\text{kJ}}{\text{mol}}$$

$$Q = 1.822 \cdot 10^3 \text{ kW}$$

4.15 Benzene

$$T_c := 562.2\text{K}$$

$$P_c := 48.98\text{bar}$$

$$T_n := 353.2\text{K}$$

$$T_{1\text{sat}} := 451.7\text{K}$$

$$T_{2\text{sat}} := 358.7\text{K}$$

$$C_p := 162 \cdot \frac{\text{J}}{\text{mol} \cdot \text{K}}$$

Estimate  $\Delta H_v$  using Riedel equation (4.12) and Watson correction (4.13)

$$T_{rn} := \frac{T_n}{T_c} \quad T_{rn} = 0.628 \quad T_{r2sat} := \frac{T_{2sat}}{T_c} \quad T_{r2sat} = 0.638$$

$$\Delta H_n := \frac{1.092 \cdot \left( \ln \left( \frac{P_c}{\text{bar}} \right) - 1.013 \right)}{0.930 - T_{rn}} \cdot R \cdot T_n \quad \Delta H_n = 30.588 \frac{\text{kJ}}{\text{mol}}$$

$$\Delta H_v := \Delta H_n \cdot \left( \frac{1 - T_{r2sat}}{1 - T_{rn}} \right)^{0.38} \quad \Delta H_v = 30.28 \frac{\text{kJ}}{\text{mol}}$$

Assume the throttling process is adiabatic and isenthalpic.

Guess vapor fraction (x):  $x := 0.5$

$$\text{Given } C_p \cdot (T_{1sat} - T_{2sat}) = x \cdot \Delta H_v \quad x := \text{Find}(x) \quad x = 0.498 \quad \text{Ans.}$$

4.16 (a) For acetylene:  $T_c := 308.3 \cdot \text{K}$   $P_c := 61.39 \cdot \text{bar}$   $T_n := 189.4 \cdot \text{K}$   
 $T := 298.15 \cdot \text{K}$

$$T_{rn} := \frac{T_n}{T_c} \quad T_{rn} = 0.614 \quad T_r := \frac{T}{T_c} \quad T_r = 0.967$$

$$\Delta H_n := R \cdot T_n \cdot 1.092 \cdot \frac{\ln \left( \frac{P_c}{\text{bar}} \right) - 1.013}{0.930 - T_{rn}} \quad \Delta H_n = 16.91 \frac{\text{kJ}}{\text{mol}}$$

$$\Delta H_v := \Delta H_n \cdot \left( \frac{1 - T_r}{1 - T_{rn}} \right)^{0.38} \quad \Delta H_v = 6.638 \frac{\text{kJ}}{\text{mol}}$$

$$\Delta H_f := 227480 \cdot \frac{\text{J}}{\text{mol}} \quad \Delta H_{298} := \Delta H_f - \Delta H_v \quad \Delta H_{298} = 220.8 \frac{\text{kJ}}{\text{mol}} \quad \text{Ans.}$$

(b) For 1,3-butadiene:  $\Delta H_{298} = 88.5 \frac{\text{kJ}}{\text{mol}}$

(c) For ethylbenzene:  $\Delta H_{298} = -12.3 \cdot \frac{\text{kJ}}{\text{mol}}$

(d) For n-hexane:  $\Delta H_{298} = -198.6 \cdot \frac{\text{kJ}}{\text{mol}}$

(e) For styrene:  $\Delta H_{298} = 103.9 \cdot \frac{\text{kJ}}{\text{mol}}$

4.17 1st law:  $dQ = dU - dW = C_V \cdot dT + P \cdot dV$  (A)

Ideal gas:  $P \cdot V = R \cdot T$  and  $P \cdot dV + V \cdot dP = R \cdot dT$

Whence  $V \cdot dP = R \cdot dT - P \cdot dV$  (B)

Since  $P \cdot V^\delta = \text{const}$  then  $P \cdot \delta \cdot V^{\delta-1} \cdot dV = -V^\delta \cdot dP$

from which  $V \cdot dP = -\frac{\delta}{V} \cdot dV$

Combines with (B) to yield:  $P \cdot dV = \frac{R \cdot dT}{1 - \delta}$

Combines with (A) to give:  $dQ = C_V \cdot dT + \frac{R \cdot dT}{1 - \delta}$

or  $dQ = C_P \cdot dT - R \cdot dT + \frac{R \cdot dT}{1 - \delta}$

which reduces to  $dQ = C_P \cdot dT + \frac{\delta}{1 - \delta} \cdot R \cdot dT$

or  $dQ = \left( \frac{C_P}{R} + \frac{\delta}{1 - \delta} \right) \cdot R \cdot dT$  (C)

Since  $C_P$  is linear in  $T$ , the mean heat capacity is the value of  $C_P$  at the arithmetic mean temperature. Thus

$T_{\text{am}} := 675$



$$C_{Pm} := R \cdot \left( 3.85 + 0.57 \cdot 10^{-3} \cdot T_{am} \right)$$

**Integrate (C):**

$$T_2 := 950 \cdot K$$

$$T_1 := 400 \cdot K$$

$$\delta := 1.55$$

$$Q := \left( \frac{C_{Pm}}{R} + \frac{\delta}{1 - \delta} \right) \cdot R \cdot (T_2 - T_1)$$

$$Q = 6477.5 \frac{J}{mol} \quad \text{Ans.}$$

$$P_1 := 1 \cdot \text{bar} \quad P_2 := P_1 \cdot \left( \frac{T_2}{T_1} \right)^{\frac{\delta}{\delta - 1}}$$

$$P_2 = 11.45 \text{ bar} \quad \text{Ans.}$$

**4.18 For the combustion of methanol:**

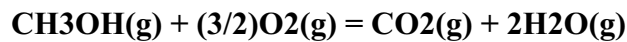

$$\Delta H_{298} := -393509 + 2 \cdot (-241818) - (-200660)$$

$$\Delta H_{298} = -676485$$

**For 6 MeOH:**

$$\Delta H_{298} = -4,058,910 \cdot J \quad \text{Ans.}$$

**For the combustion of 1-hexene:**

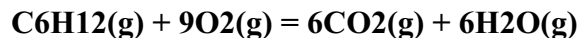

$$\Delta H_{298} := 6 \cdot (-393509) + 6 \cdot (-241818) - (-41950)$$

$$\Delta H_{298} = -3770012$$

$$\Delta H_{298} = -3,770,012 \cdot J \quad \text{Ans.}$$

**Comparison is on the basis of equal numbers of C atoms.**

**4.19 C<sub>2</sub>H<sub>4</sub> + 3O<sub>2</sub> = 2CO<sub>2</sub> + 2H<sub>2</sub>O(g)**

$$\Delta H_{298} := [2 \cdot (-241818) + 2 \cdot (-393509) - 52510] \cdot \frac{J}{mol}$$

**Parts (a) - (d) can be worked exactly as Example 4.7. However, with Mathcad capable of doing the iteration, it is simpler to proceed differently.**

Index the product species with the numbers:

- 1 = oxygen
- 2 = carbon dioxide
- 3 = water (g)
- 4 = nitrogen

(a) For the product species, no excess air:

$$n := \begin{pmatrix} 0 \\ 2 \\ 2 \\ 11.286 \end{pmatrix} \quad A := \begin{pmatrix} 3.639 \\ 5.457 \\ 3.470 \\ 3.280 \end{pmatrix} \quad B := \begin{pmatrix} 0.506 \\ 1.045 \\ 1.450 \\ 0.593 \end{pmatrix} \cdot \frac{10^{-3}}{\text{K}} \quad D := \begin{pmatrix} -0.227 \\ -1.157 \\ 0.121 \\ 0.040 \end{pmatrix} \cdot 10^5 \text{K}^2$$

$$i := 1..4 \quad A := \sum_i (n_i \cdot A_i) \quad B := \sum_i (n_i \cdot B_i) \quad D := \sum_i (n_i \cdot D_i)$$

$$A = 54.872 \quad B = 0.012 \frac{1}{\text{K}} \quad D = -1.621 \times 10^5 \text{K}^2$$

For the products,  $\Delta H_P = R \cdot \int_{T_0}^T \frac{C_P}{R} dT$   $T_0 := 298.15 \text{K}$

The integral is given by Eq. (4.7). Moreover, by an energy balance,

$$\Delta H_{298} + \Delta H_P = 0$$

$$\tau := 2 \quad (\text{guess})$$

$$\text{Given} \quad -\Delta H_{298} = R \cdot \left[ A \cdot T_0 \cdot \left( \frac{\tau}{T_0} \right) - 1 + \frac{B}{2} \cdot T_0^2 \cdot \left( \frac{\tau}{T_0} \right)^2 - 1 + \frac{D}{T_0} \cdot \left( \frac{\tau - 1}{\tau} \right) \right]$$

$$\tau := \text{Find}(\tau) \quad \tau = 8.497 \quad T := T_0 \cdot \tau \quad T = 2533.5 \text{K} \quad \text{Ans.}$$

Parts (b), (c), and (d) are worked the same way, the only change being in the numbers of moles of products.

(b)  $n_{\text{O}_2} = 0.75$      $n_{\text{N}_2} = 14.107$      $T = 2198.6 \text{K}$     **Ans.**

(c)  $n_{\text{O}_2} = 1.5$      $n_{\text{N}_2} = 16.929$      $T = 1950.9 \text{K}$     **Ans.**

(d)  $n_{\text{O}_2} = 3.0$      $n_{\text{N}_2} = 22.571$      $T = 1609.2 \text{K}$     **Ans.**

(e) 50% xs air preheated to 500 degC. For this process,

$$\Delta H_{\text{air}} + \Delta H_{298} + H_P = 0$$

$$\Delta H_{\text{air}} = \text{MCPH} \cdot (298.15 - 773.15)$$

For one mole of air:

$$\text{MCPH}(773.15, 298.15, 3.355, 0.575 \cdot 10^{-3}, 0.0, -0.016 \cdot 10^5) = 3.65606$$

For  $4.5/0.21 = 21.429$  moles of air:

$$\Delta H_{\text{air}} = n \cdot R \cdot \text{MCPH} \cdot T$$

$$\Delta H_{\text{air}} := 21.429 \cdot 8.314 \cdot 3.65606 \cdot (298.15 - 773.15) \cdot \frac{\text{J}}{\text{mol}}$$

$$\Delta H_{\text{air}} = -309399 \frac{\text{J}}{\text{mol}}$$

The energy balance here gives:  $\Delta H_{298} + \Delta H_{\text{air}} + H_P = 0$

$$n := \begin{pmatrix} 1.5 \\ 2 \\ 2 \\ 16.929 \end{pmatrix}$$

$$A := \begin{pmatrix} 3.639 \\ 5.457 \\ 3.470 \\ 3.280 \end{pmatrix}$$

$$B := \begin{pmatrix} 0.506 \\ 1.045 \\ 1.450 \\ 0.593 \end{pmatrix} \cdot \frac{10^{-3}}{\text{K}}$$

$$D := \begin{pmatrix} -0.227 \\ -1.157 \\ 0.121 \\ 0.040 \end{pmatrix} \cdot 10^5 \cdot \text{K}^2$$

$$A := \sum_i (n_i \cdot A_i)$$

$$B := \sum_i (n_i \cdot B_i)$$

$$D := \sum_i (n_i \cdot D_i)$$

$$A = 78.84$$

$$B = 0.016 \frac{1}{\text{K}}$$

$$D = -1.735 \times 10^5 \text{K}^2$$

$\tau := 2$  (guess)

$$\text{Given} \quad -\Delta H_{298} - H_{\text{air}} = R \cdot \left[ A \cdot T_0 \cdot \left( \frac{\tau - 1}{\tau} \right) - 1 + \frac{B}{2} \cdot T_0^2 \cdot \left( \frac{\tau - 1}{\tau} \right)^2 - 1 \dots \right. \\ \left. + \frac{D}{T_0} \cdot \left( \frac{\tau - 1}{\tau} \right) \right]$$

$\tau := \text{Find}(\tau)$

$$\tau = 7.656$$

$$T := T_0 \cdot \text{K}$$

$$T = 2282.5 \text{K K}$$

Ans.



By Eq. (4.15) with data from Table C.4:

$$\Delta H_{298} := 5 \cdot (-393509) + 6 \cdot (-285830) - (-146760)$$

$$\Delta H_{298} = -3,535,765 \cdot \text{J} \quad \text{Ans.}$$

4.21 The following answers are found by application of Eq. (4.15) with data from Table C.4.

- |                  |                  |
|------------------|------------------|
| (a) -92,220 J    | (n) 180,500 J    |
| (b) -905,468 J   | (o) 178,321 J    |
| (c) -71,660 J    | (p) -132,439 J   |
| (d) -61,980 J    | (q) -44,370 J    |
| (e) -367,582 J   | (r) -68,910 J    |
| (f) -2,732,016 J | (s) -492,640 J   |
| (g) -105,140 J   | (t) 109,780 J    |
| (h) -38,292 J    | (u) 235,030 J    |
| (i) 164,647 J    | (v) -132,038 J   |
| (j) -48,969 J    | (w) -1,807,968 J |
| (k) -149,728 J   | (x) 42,720 J     |
| (l) -1,036,036 J | (y) 117,440 J    |
| (m) 207,436 J    | (z) 175,305 J    |

**4.22** The solution to each of these problems is exactly like that shown in **Example 4.6**. In each case the value of  $\Delta H^{\circ}_{298}$  is calculated in **Problem 4.21**. Results are given in the following table. In the first column the letter in ( ) indicates the part of problem 4.21 appropriate to the  $\Delta H^{\circ}_{298}$  value.

	T/K	$\Delta A$	$10^3 \Delta B$	$10^6 \Delta C$	$10^{-5} \Delta D$	IDCPH/J	$\Delta H^{\circ}_T/J$
(a)	873.15	-5.871	4.181	0.000	-0.661	-17,575	-109,795
(b)	773.15	1.861	-3.394	0.000	2.661	4,729	-900,739
(f)	923.15	6.048	-9.779	0.000	7.972	15,635	-2,716,381
(i)	973.15	9.811	-9.248	2.106	-1.067	25,229	189,876
(j)	583.15	-9.523	11.355	-3.450	1.029	-10,949	-59,918
(l)	683.15	-0.441	0.004	0.000	-0.643	-2,416	-1,038,452
(m)	850.00	4.575	-2.323	0.000	-0.776	13,467	220,903
(n)	1350.00	-0.145	0.159	0.000	0.215	345	180,845
(o)	1073.15	-1.011	-1.149	0.000	0.916	-9,743	168,578
(r)	723.15	-1.424	1.601	0.156	-0.083	-2,127	-71,037
(t)	733.15	4.016	-4.422	0.991	0.083	7,424	117,204
(u)	750.00	7.297	-9.285	2.520	0.166	12,172	247,202
(v)	900.00	2.418	-3.647	0.991	0.235	3,534	-128,504
(w)	673.15	2.586	-4.189	0.000	1.586	4,184	-1,803,784
(x)	648.15	0.060	0.173	0.000	-0.191	125	42,845
(y)	1083.15	4.175	-4.766	1.814	0.083	12,188	129,628

**4.23** This is a simple application of a combination of Eqs. (4.18) & (4.19) with evaluated parameters. In each case the value of  $\Delta H^{\circ}_{298}$  is calculated in **Pb. 4.21**. The values of  $\Delta A$ ,  $\Delta B$ ,  $\Delta C$  and  $\Delta D$  are given for all cases except for **Parts (e), (g), (h), (k), and (z)** in the preceding table. Those missing are as follows:

Part No.	$\Delta A$	$10^3 \Delta B$	$10^6 \Delta C$	$10^{-5} \Delta D$
(e)	-7.425	20.778	0.000	3.737
(g)	-3.629	8.816	-4.904	0.114
(h)	-9.987	20.061	-9.296	1.178
(k)	1.704	-3.997	1.573	0.234
(z)	-3.858	-1.042	0.180	0.919

$$4.24 \quad q := 150 \cdot 10^6 \frac{\text{ft}^3}{\text{day}} \quad T := (60 - 32) \cdot \frac{5}{9} \text{K} + 273.15 \text{K} \quad T = 288.71 \text{K} \quad P := 1 \text{atm}$$

The higher heating value is the negative of the heat of combustion with water as liquid product.

Calculate methane standard heat of combustion with water as liquid product:

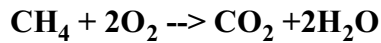

Standard Heats of Formation:

$$\Delta H_{f\text{CH}_4} := -74520 \frac{\text{J}}{\text{mol}}$$

$$\Delta H_{f\text{O}_2} := 0 \frac{\text{J}}{\text{mol}}$$

$$\Delta H_{f\text{CO}_2} := -393509 \frac{\text{J}}{\text{mol}}$$

$$\Delta H_{f\text{H}_2\text{Oliq}} := -285830 \frac{\text{J}}{\text{mol}}$$

$$\Delta H_c := \Delta H_{f\text{CO}_2} + 2 \cdot \Delta H_{f\text{H}_2\text{Oliq}} - H_{f\text{CH}_4} - 2 \cdot \Delta H_{f\text{O}_2}$$

$$\text{HigherHeatingValue} := -\Delta H_c$$

$$\Delta H_c = -8.906 \times 10^5 \frac{\text{J}}{\text{mol}}$$

Assuming methane is an ideal gas at standard conditions:

$$n := q \cdot \frac{P}{R \cdot T}$$

$$n = 1.793 \times 10^8 \frac{\text{mol}}{\text{day}}$$

$$n \cdot \text{HigherHeatingValue} \cdot \frac{5 \text{dollar}}{\text{GJ}} = 7.985 \times 10^5 \frac{\text{dollar}}{\text{day}} \quad \text{Ans.}$$

4.25 Calculate methane standard heat of combustion with water as liquid product

Standard Heats of Formation:  $\text{CH}_4 + 2\text{O}_2 \rightarrow \text{CO}_2 + 2\text{H}_2\text{O}$

$$\Delta H_{f\text{CH}_4} := -74520 \frac{\text{J}}{\text{mol}}$$

$$\Delta H_{f\text{O}_2} := 0 \frac{\text{J}}{\text{mol}}$$

$$\Delta H_{f\text{CO}_2} := -393509 \frac{\text{J}}{\text{mol}}$$

$$\Delta H_{f\text{H}_2\text{Oliq}} := -285830 \frac{\text{J}}{\text{mol}}$$

$$\Delta H_{c\text{CH}_4} := \Delta H_{f\text{CO}_2} + 2 \cdot \Delta H_{f\text{H}_2\text{Oliq}} - H_{f\text{CH}_4} - 2 \cdot \Delta H_{f\text{O}_2}$$

$$\Delta H_{c\text{CH}_4} = -890649 \frac{\text{J}}{\text{mol}}$$

Calculate ethane standard heat of combustion with water as liquid product:

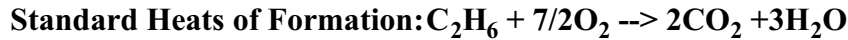

$$\Delta H_{fC_2H_6} := -83820 \frac{J}{mol}$$

$$\Delta H_{cC_2H_6} := 2\Delta H_{fCO_2} + 3\Delta H_{fH_2O(liq)} - H_{fC_2H_6} - \frac{7}{2}\Delta H_{fO_2}$$

$$\Delta H_{cC_2H_6} = -1560688 \frac{J}{mol}$$

Calculate propane standard heat of combustion with water as liquid product



$$\Delta H_{fC_3H_8} := -104680 \frac{J}{mol}$$

$$\Delta H_{cC_3H_8} := 3\Delta H_{fCO_2} + 4\Delta H_{fH_2O(liq)} - H_{fC_3H_8} - 5\Delta H_{fO_2}$$

$$\Delta H_{cC_3H_8} = -2219.167 \frac{kJ}{mol}$$

Calculate the standard heat of combustion for the mixtures

$$a) 0.95 \cdot \Delta H_{cCH_4} + 0.02 \cdot \Delta H_{cC_2H_6} + 0.02 \cdot \Delta H_{cC_3H_8} = -921.714 \frac{kJ}{mol}$$

$$b) 0.90 \cdot \Delta H_{cCH_4} + 0.05 \cdot \Delta H_{cC_2H_6} + 0.03 \cdot \Delta H_{cC_3H_8} = -946.194 \frac{kJ}{mol}$$

$$c) 0.85 \cdot \Delta H_{cCH_4} + 0.07 \cdot \Delta H_{cC_2H_6} + 0.03 \cdot \Delta H_{cC_3H_8} = -932.875 \frac{kJ}{mol}$$

Gas b) has the highest standard heat of combustion. Ans.

4.26  $2H_2 + O_2 = 2H_2O(l)$   $\Delta H_{f1} := 2 \cdot (-285830) \cdot J$

$C + O_2 = CO_2(g)$   $\Delta H_{f2} := -393509 \cdot J$

$N_2(g) + 2H_2O(l) + CO_2(g) = (NH_2)_2CO(s) + 3/2O_2$   $\Delta H := 631660 \cdot J$

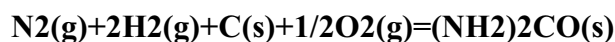

$\Delta H_{298} := \Delta H_{f1} + \Delta H_{f2} + H$   $\Delta H_{298} = -333509 J$  Ans.

4.28 On the basis of 1 mole of C<sub>10</sub>H<sub>18</sub>  
(molar mass = 162.27)

$$Q := -43960 \cdot 162.27 \cdot J$$

$$Q = -7.133 \times 10^6 J$$

This value is for the constant-volume reaction:

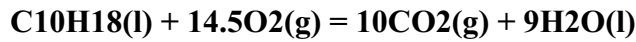

Assuming ideal gases and with symbols representing total properties,

$$Q = \Delta U = \Delta H - \Delta(PV) = \Delta H - R \cdot T \cdot n_{gas}$$

$$T := 298.15 \cdot K$$

$$\Delta n_{gas} := (10 - 14.5) \cdot mol$$

$$\Delta H := Q + R \cdot T \cdot n_{gas}$$

$$\Delta H = -7.145 \times 10^6 J$$

This value is for the constant-V reaction, whereas the STANDARD reaction is at const. P. However, for ideal gases  $H = f(T)$ , and for liquids  $H$  is a very weak function of  $P$ . We therefore take the above value as the standard value, and for the specified reaction:

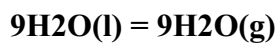

$$\Delta H_{vap} := 9 \cdot 44012 \cdot J$$

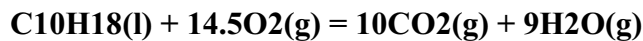

$$\Delta H_{298} := \Delta H + \Delta H_{vap}$$

$$\Delta H_{298} = -6748436 J$$

Ans.

4.29 FURNACE: Basis is 1 mole of methane burned with 30% excess air.



Entering: Moles methane

$$n_1 := 1$$

Moles oxygen

$$n_2 := 2 \cdot 1.3$$

$$n_2 = 2.6$$

Moles nitrogen

$$n_3 := 2.6 \cdot \frac{79}{21}$$

$$n_3 = 9.781$$



**Total moles of dry gases entering**      $n := n_1 + n_2 + n_3$       $n = 13.381$

**At 30 degC the vapor pressure of water is 4.241 kPa. Moles of water vapor entering:**

$$n_4 := \frac{4.241}{101.325 - 4.241} \cdot 13.381 \quad n_4 = 0.585$$

- Leaving:**
- CO2 -- 1 mol** (1)
  - H2O -- 2.585 mol** (2)
  - O2 -- 2.6 - 2 = 0.6 mol** (3)
  - N2 -- 9.781 mol** (4)

**By an energy balance on the furnace:**

$$Q = \Delta H = \Delta H_{298} + \Delta H_P$$

**For evaluation of  $\Delta H_P$  we number species as above.**

$$n := \begin{pmatrix} 1 \\ 2.585 \\ 0.6 \\ 9.781 \end{pmatrix}$$

$$A := \begin{pmatrix} 5.457 \\ 3.470 \\ 3.639 \\ 3.280 \end{pmatrix}$$

$$B := \begin{pmatrix} 1.045 \\ 1.450 \\ 0.506 \\ 0.593 \end{pmatrix} \cdot 10^{-3}$$

$$D := \begin{pmatrix} -1.157 \\ 0.121 \\ -0.227 \\ 0.040 \end{pmatrix} \cdot 10^5$$

$$i := 1..4$$

$$R = 8.314 \frac{\text{J}}{\text{mol} \cdot \text{K}}$$

$$A := \sum_i (n_i \cdot A_i) \quad B := \sum_i (n_i \cdot B_i)$$

$$D := \sum_i (n_i \cdot D_i)$$

$$A = 48.692 \quad B = 10.896983 \cdot 10^{-3} \quad C := 0 \quad D = -5.892 \times 10^4$$

**The TOTAL value for MCPH of the product stream:**

$$\Delta H_P := R \cdot \text{MCPH}(303.15\text{K}, 1773.15\text{K}, A, B, C, D) \cdot (1773.15 - 303.15)\text{K}$$

$$\Delta H_P = 732.013 \frac{\text{kJ}}{\text{mol}}$$

**From Example 4.7:**

$$\Delta H_{298} := -802625 \frac{\text{J}}{\text{mol}}$$

$$Q := \Delta H_P + \Delta H_{298}$$

$$Q = -70,612 \cdot \text{J} \quad \text{Ans.}$$

**HEAT EXCHANGER: Flue gases cool from 1500 degC to 50 degC. The partial pressure of the water in the flue gases leaving the furnace (in kPa) is**

$$pp := \frac{n_2}{n_1 + n_2 + n_3 + n_4} \cdot 101.325 \quad pp = 18.754$$

**The vapor pressure of water at 50 degC (exit of heat exchanger) is 12.34 kPa, and water must condense to lower its partial pressure to this value.**

**Moles of dry flue gases:**  $n := n_1 + n_3 + n_4 \quad n = 11.381$

**Moles of water vapor leaving the heat exchanger:**

$$n_2 := \frac{12.34}{101.325 - 12.34} \cdot n \quad n_2 = 1.578$$

**Moles water condensing:**  $\Delta n := 2.585 - 1.578$

**Latent heat of water at 50 degC in J/mol:**

$$\Delta H_{50} := 2382.9 \cdot 18.015 \frac{\text{J}}{\text{mol}}$$

**Sensible heat of cooling the flue gases to 50 degC with all the water as vapor (we assumed condensation at 50 degC):**

$$Q := R \cdot M \cdot C_{PH}(323.15 \cdot K, 1773.15 \cdot K, A, B, C, D) \cdot (323.15 - 1773.15)K - n \cdot \Delta H_{50} \quad Q = -766,677 \cdot J \quad \text{Ans.}$$

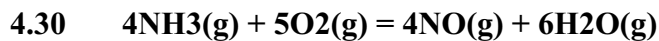

**BASIS: 4 moles ammonia entering reactor**

**Moles O<sub>2</sub> entering = (5)(1.3) = 6.5**

**Moles N<sub>2</sub> entering = (6.5)(79/21) = 24.45**

**Moles NH<sub>3</sub> reacting = moles NO formed = (4)(0.8) = 3.2**

**Moles O<sub>2</sub> reacting = (5)(0.8) = 4.0**

**Moles water formed = (6)(0.8) = 4.8**

**ENERGY BALANCE:**

$$\Delta H = \Delta H_R + \Delta H_{298} + H_P = 0$$

**REACTANTS: 1=NH3; 2=O2; 3=N2**

$$n := \begin{pmatrix} 4 \\ 6.5 \\ 24.45 \end{pmatrix} \quad A := \begin{pmatrix} 3.578 \\ 3.639 \\ 3.280 \end{pmatrix} \quad B := \begin{pmatrix} 3.020 \\ 0.506 \\ 0.593 \end{pmatrix} \cdot 10^{-3} \quad D := \begin{pmatrix} -0.186 \\ -0.227 \\ 0.040 \end{pmatrix} \cdot 10^5$$

$$i := 1..3 \quad A := \sum_i (n_i \cdot A_i) \quad B := \sum_i (n_i \cdot B_i) \quad D := \sum_i (n_i \cdot D_i)$$

$$A = 118.161 \quad B = 0.02987 \quad C := 0.0 \quad D = -1.242 \times 10^5$$

**TOTAL mean heat capacity of reactant stream:**

$$\Delta H_R := R \cdot \text{MCPH}(348.15\text{K}, 298.15\text{K}, A, B, C, D) \cdot (298.15\text{K} - 348.15\text{K})$$

$$\Delta H_R = -52.635 \frac{\text{kJ}}{\text{mol}}$$

**The result of Pb. 4.21(b) is used to get**

$$\Delta H_{298} := 0.8 \cdot (-905468) \frac{\text{J}}{\text{mol}}$$

**PRODUCTS 1=NH3; 2=O2; 3=NO; 4=H2O; 5=N2**

$$n := \begin{pmatrix} 0.8 \\ 2.5 \\ 3.2 \\ 4.8 \\ 24.45 \end{pmatrix} \quad A := \begin{pmatrix} 3.578 \\ 3.639 \\ 3.387 \\ 3.470 \\ 3.280 \end{pmatrix} \quad B := \begin{pmatrix} 3.020 \\ 0.506 \\ 0.629 \\ 1.450 \\ 0.593 \end{pmatrix} \cdot \frac{10^{-3}}{\text{K}} \quad D := \begin{pmatrix} -0.186 \\ -0.227 \\ 0.014 \\ 0.121 \\ 0.040 \end{pmatrix} \cdot 10^5 \cdot \text{K}^2$$

$$i := 1..5 \quad A := \sum_i (n_i \cdot A_i) \quad B := \sum_i (n_i \cdot B_i) \quad D := \sum_i (n_i \cdot D_i)$$

$$A = 119.65 \quad B = 0.027 \frac{1}{\text{K}} \quad D = 8.873 \times 10^4 \text{K}^2$$

**By the energy balance and Eq. (4.7), we can write:**

$$T_0 := 298.15\text{K} \quad \tau := 2 \quad (\text{guess})$$

$$\text{Given} \quad -\Delta H_{298} - H_R = R \cdot \left[ A \cdot T_0 \cdot () - 1 + \frac{B}{2} \cdot T_0^2 \cdot ()^2 - 1 \dots \right] \\ + \frac{D}{T_0} \cdot \left( \frac{\tau - 1}{\tau} \right)$$

$$\tau := \text{Find}(\tau) \quad \tau = 3.283 \quad T := T_0 \cdot \tau \quad T = 978.9 \text{ K} \quad \text{Ans.}$$

4.31  $\text{C}_2\text{H}_4(\text{g}) + \text{H}_2\text{O}(\text{g}) = \text{C}_2\text{H}_5\text{OH}(\text{l})$

**BASIS:** 1 mole ethanol produced  $n := 1 \text{ mol}$

**Energy balance:**  $\Delta H = Q = \Delta H_R + \Delta H_{298}$

$$\Delta H_{298} := [-277690 - (52510 - 241818)] \cdot \frac{\text{J}}{\text{mol}} \quad \Delta H_{298} = -8.838 \times 10^4 \frac{\text{J}}{\text{mol}}$$

**Reactant stream consists of 1 mole each of  $\text{C}_2\text{H}_4$  and  $\text{H}_2\text{O}$ .**

$$i := 1..2 \quad n := \begin{pmatrix} 1 \\ 1 \end{pmatrix}$$

$$A := \begin{pmatrix} 1.424 \\ 3.470 \end{pmatrix} \quad B := \begin{pmatrix} 14.394 \\ 1.450 \end{pmatrix} \cdot 10^{-3} \quad C := \begin{pmatrix} -4.392 \\ 0.0 \end{pmatrix} \cdot 10^{-6} \quad D := \begin{pmatrix} 0.0 \\ 0.121 \end{pmatrix} \cdot 10^5$$

$$A := \sum_i (h_i \cdot A_i) \quad B := \sum_i (h_i \cdot B_i) \quad C := \sum_i (h_i \cdot C_i) \quad D := \sum_i (h_i \cdot D_i)$$

$$A = 4.894 \quad B = 0.01584 \quad C = -4.392 \times 10^{-6} \quad D = 1.21 \times 10^4$$

$$\Delta H_R := R \cdot \text{MCPH}(298.15 \text{ K}, 593.15 \text{ K}, A, B, C, D) \cdot (298.15 \text{ K} - 593.15 \text{ K})$$

$$\Delta H_R = -2.727 \times 10^4 \frac{\text{J}}{\text{mol}}$$

$$Q := (\Delta H_R + \Delta H_{298}) \cdot 1 \text{ mol} \quad Q = -115653 \text{ J} \quad \text{Ans.}$$

4.32 One way to proceed is as in Example 4.8 with the alternative pair of reactions:



**BASIS:** 1 mole of product gases containing 0.0275 mol CO<sub>2</sub>; 0.1725 mol CO;  
& H<sub>2</sub>O 0.6275 mol H<sub>2</sub>

Entering gas, by carbon & oxygen balances:

$$0.0275 + 0.1725 = 0.2000 \text{ mol CH}_4$$

$$0.1725 + 0.1725 + 2(0.0275) = 0.4000 \text{ mol H}_2\text{O}$$

$$\Delta H_{298} := (0.1725 \cdot \Delta H_{298a} + 0.0275 \cdot \Delta H_{298b}) \cdot \frac{\text{J}}{\text{mol}} \quad \Delta H_{298} = 4.003 \times 10^4 \frac{\text{J}}{\text{mol}}$$

The energy balance is written

$$Q = \Delta H_R + \Delta H_{298} + H_P$$

**REACTANTS:** 1=CH<sub>4</sub>; 2=H<sub>2</sub>O  $i := 1..2$   $n := \begin{pmatrix} 0.2 \\ 0.4 \end{pmatrix}$

$$A := \begin{pmatrix} 1.702 \\ 3.470 \end{pmatrix} \quad B := \begin{pmatrix} 9.081 \\ 1.450 \end{pmatrix} \cdot 10^{-3} \quad C := \begin{pmatrix} -2.164 \\ 0.0 \end{pmatrix} \cdot 10^{-6} \quad D := \begin{pmatrix} 0.0 \\ 0.121 \end{pmatrix} \cdot 10^5$$

$$A := \sum_i (h_i \cdot A_i) \quad B := \sum_i (h_i \cdot B_i) \quad C := \sum_i (h_i \cdot C_i) \quad D := \sum_i (h_i \cdot D_i)$$

$$A = 1.728 \quad B = 2.396 \times 10^{-3} \quad C = -4.328 \times 10^{-7} \quad D = 4.84 \times 10^3$$

$$\Delta H_R := R \cdot \text{ICPH}(773.15\text{K}, 298.15\text{K}, A, B, C, D)$$

$$\Delta H_R = -1.145 \times 10^4 \frac{\text{J}}{\text{mol}}$$

**PRODUCTS:** 1=CO<sub>2</sub>; 2=CO; 3=H<sub>2</sub>O; 4=H<sub>2</sub>

$$n := \begin{pmatrix} 0.0275 \\ 0.1725 \\ 0.1725 \\ 0.6275 \end{pmatrix} \quad A := \begin{pmatrix} 5.457 \\ 3.376 \\ 3.470 \\ 3.249 \end{pmatrix} \quad B := \begin{pmatrix} 1.045 \\ 0.557 \\ 1.450 \\ 0.422 \end{pmatrix} \cdot 10^{-3} \quad D := \begin{pmatrix} -1.157 \\ -0.031 \\ 0.121 \\ 0.083 \end{pmatrix} \cdot 10^5$$

$$i := 1..4 \quad A := \sum_i (h_i \cdot A_i) \quad B := \sum_i (h_i \cdot B_i) \quad D := \sum_i (h_i \cdot D_i)$$

$$A = 3.37 \quad B = 6.397 \times 10^{-4} \quad C := 0.0 \quad D = 3.579 \times 10^3$$

$$\Delta H_P := R \cdot \text{ICPH}(298.15\text{K}, 1123.15\text{K}, A, B, C, D)$$

$$\Delta H_P = 2.63 \times 10^4 \frac{\text{J}}{\text{mol}}$$

$$Q := (\Delta H_R + \Delta H_{298} + H_P) \cdot \text{mol}$$

$$Q = 54881 \text{ J} \quad \text{Ans.}$$

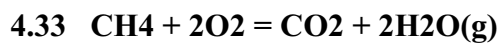

$$\Delta H_{298a} := -802625$$

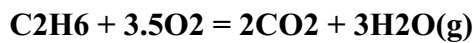

$$\Delta H_{298b} := -1428652$$

**BASIS: 1 mole fuel (0.75 mol CH<sub>4</sub>; 0.25 mol C<sub>2</sub>H<sub>6</sub>) burned completely with 80% xs. air.**

$$\text{O}_2 \text{ in} = 1.8[(0.75)(2) + (0.25)(3.5)] = 4.275 \text{ mol}$$

$$\text{N}_2 \text{ in} = 4.275(79/21) = 16.082 \text{ mol}$$

$$\text{Product gases: CO}_2 = 0.75 + 2(0.25) = 1.25 \text{ mol}$$

$$\text{H}_2\text{O} = 2(0.75) + 3(0.25) = 2.25 \text{ mol}$$

$$\text{O}_2 = (0.8/1.8)(4.275) = 1.9 \text{ mol}$$

$$\text{N}_2 = 16.082 \text{ mol}$$

$$\Delta H_{298} := (0.75 \cdot \Delta H_{298a} + 0.25 \cdot \Delta H_{298b}) \cdot \frac{\text{J}}{\text{mol}}$$

$$Q := -8 \cdot 10^5 \cdot \frac{\text{J}}{\text{mol}}$$

$$\text{Energy balance: } Q = \Delta H = \Delta H_{298} + \Delta H_P$$

$$\Delta H_P = Q - \Delta H_{298}$$

**PRODUCTS: 1=CO<sub>2</sub>; 2=H<sub>2</sub>O; 3=O<sub>2</sub>; 4=N<sub>2</sub>**

$$n := \begin{pmatrix} 1.25 \\ 2.25 \\ 1.9 \\ 16.082 \end{pmatrix} \quad A := \begin{pmatrix} 5.457 \\ 3.470 \\ 3.639 \\ 3.280 \end{pmatrix} \quad B := \begin{pmatrix} 1.045 \\ 1.450 \\ 0.506 \\ 0.593 \end{pmatrix} \cdot \frac{10^{-3}}{\text{K}} \quad D := \begin{pmatrix} -1.157 \\ 0.121 \\ -0.227 \\ 0.040 \end{pmatrix} \cdot 10^5 \cdot \text{K}^2$$

$$i := 1..4 \quad A := \sum_i (h_i \cdot A_i) \quad B := \sum_i (h_i \cdot B_i) \quad D := \sum_i (h_i \cdot D_i)$$

$$A = 74.292 \quad B = 0.015 \frac{1}{\text{K}} \quad C := 0.0 \quad D = -9.62 \times 10^4 \text{ K}^2$$

By the energy balance and Eq. (4.7), we can write:

$$T_0 := 303.15\text{K} \quad \tau := 2 \quad (\text{guess})$$

$$\text{Given } Q - \Delta H_{298} = R \cdot \left[ A \cdot T_0 \cdot (\tau) - 1 + \frac{B}{2} \cdot T_0^2 \cdot (\tau)^2 - 1 \dots \right. \\ \left. + \frac{D}{T_0} \cdot \left( \frac{\tau - 1}{\tau} \right) \right] \quad \tau := \text{Find}(\tau)$$

$$\tau = 1.788$$

$$T := T_0 \cdot \tau$$

$$T = 542.2\text{K}$$

Ans.

4.34 **BASIS: 1 mole of entering gases containing 0.15 mol SO<sub>2</sub>; 0.20 mol O<sub>2</sub>; 0.65 mol N<sub>2</sub>**



$$\text{SO}_2 \text{ reacted} = \text{SO}_3 \text{ formed} = (0.15)(0.86) = 0.129 \text{ mol}$$

$$\text{O}_2 \text{ reacted} = (0.5)(0.129) = 0.0645 \text{ mol}$$

$$\text{Energy balance: } \Delta H_{773} = \Delta H_R + \Delta H_{298} + H_P$$

Since  $\Delta H_R$  and  $\Delta H_P$  cancel for the gas that passes through the converter unreacted, we need consider only those species that react or are formed. Moreover, the reactants and products experience the same temperature change, and can therefore be considered together. We simply take the number of moles of reactants as being negative. The energy balance is then written:  $\Delta H_{773} = \Delta H_{298} + \Delta H_{\text{net}}$

$$\Delta H_{298} := [-395720 - (-296830)] \cdot 0.129 \cdot \frac{\text{J}}{\text{mol}}$$

1: SO<sub>2</sub>; 2: O<sub>2</sub>; 3: SO<sub>3</sub>

$$n := \begin{pmatrix} -0.129 \\ -0.0645 \\ 0.129 \end{pmatrix}$$

$$A := \begin{pmatrix} 5.699 \\ 3.639 \\ 8.060 \end{pmatrix}$$

$$B := \begin{pmatrix} 0.801 \\ 0.506 \\ 1.056 \end{pmatrix} \cdot 10^{-3}$$

$$D := \begin{pmatrix} -1.015 \\ -0.227 \\ -2.028 \end{pmatrix} \cdot 10^5$$

$$i := 1..3 \quad A := \sum_i (h_i \cdot A_i) \quad B := \sum_i (h_i \cdot B_i) \quad D := \sum_i (h_i \cdot D_i)$$

$$A = 0.06985$$

$$B = 2.58 \times 10^{-7}$$

$$C := 0$$

$$D = -1.16 \times 10^4$$

$$\Delta H_{\text{net}} := R \cdot \text{MCPH}(298.15\text{K}, 773.15\text{K}, A, B, C, D) \cdot (773.15\text{K} - 298.15\text{K})$$

$$\Delta H_{\text{net}} = 77.617 \frac{\text{J}}{\text{mol}}$$

$$\Delta H_{773} := (\Delta H_{298} + \Delta H_{\text{net}})$$

$$\Delta H_{773} = -12679 \frac{\text{J}}{\text{mol}} \quad \text{Ans.}$$

#### 4.35 $\text{CO}(\text{g}) + \text{H}_2\text{O}(\text{g}) = \text{CO}_2(\text{g}) + \text{H}_2(\text{g})$

**BASIS: 1 mole of feed consisting of 0.5 mol CO and 0.5 mol H<sub>2</sub>O.**

**Moles CO reacted = moles H<sub>2</sub>O reacted = moles CO<sub>2</sub> formed = moles H<sub>2</sub> formed = (0.6)(0.5) = 0.3**

**Product stream:                      moles CO = moles H<sub>2</sub>O = 0.2**  
**moles CO<sub>2</sub> = moles H<sub>2</sub> = 0.3**

**Energy balance:                      Q = ΔH = ΔH<sub>R</sub> + ΔH<sub>298</sub> + H<sub>P</sub>**

$$\Delta H_{298} := 0.3 \cdot [-393509 - (-110525 - 214818)] \frac{\text{J}}{\text{mol}} \quad \Delta H_{298} = -2.045 \times 10^4 \frac{\text{J}}{\text{mol}}$$

**Reactants: 1: CO 2: H<sub>2</sub>O**

$$n := \begin{pmatrix} 0.5 \\ 0.5 \end{pmatrix} \quad A := \begin{pmatrix} 3.376 \\ 3.470 \end{pmatrix} \quad B := \begin{pmatrix} 0.557 \\ 1.450 \end{pmatrix} \cdot 10^{-3} \quad D := \begin{pmatrix} -0.031 \\ 0.121 \end{pmatrix} \cdot 10^5$$

$$i := 1..2 \quad A := \sum_i (n_i \cdot A_i) \quad B := \sum_i (n_i \cdot B_i) \quad D := \sum_i (n_i \cdot D_i)$$

$$A = 3.423 \quad B = 1.004 \times 10^{-3} \quad C := 0 \quad D = 4.5 \times 10^3$$

$$\Delta H_R := R \cdot \text{MCPH}(298.15\text{K}, 398.15\text{K}, A, B, C, D) \cdot (298.15\text{K} - 398.15\text{K})$$

$$\Delta H_R = -3.168 \times 10^3 \frac{\text{J}}{\text{mol}}$$

**Products:                      1: CO 2: H<sub>2</sub>O 3: CO<sub>2</sub> 4: H<sub>2</sub>**

$$n := \begin{pmatrix} 0.2 \\ 0.2 \\ 0.3 \\ 0.3 \end{pmatrix} \quad A := \begin{pmatrix} 3.376 \\ 3.470 \\ 5.457 \\ 3.249 \end{pmatrix} \quad B := \begin{pmatrix} 0.557 \\ 1.450 \\ 1.045 \\ 0.422 \end{pmatrix} \cdot 10^{-3} \quad D := \begin{pmatrix} -0.031 \\ 0.121 \\ -1.157 \\ 0.083 \end{pmatrix} \cdot 10^5$$



$$i := 1..4 \quad A := \sum_i (h_i \cdot A_i) \quad B := \sum_i (h_i \cdot B_i) \quad D := \sum_i (h_i \cdot D_i)$$

$$A = 3.981 \quad B = 8.415 \times 10^{-4} \quad C := 0 \quad D = -3.042 \times 10^4$$

$$\Delta H_P := R \cdot M_{CPH}(298.15K, 698.15K, A, B, C, D) \cdot (698.15K - 298.15K)$$

$$\Delta H_P = 1.415 \times 10^4 \frac{J}{mol}$$

$$Q := (\Delta H_R + \Delta H_{298} + H_P) \cdot mol \quad Q = -9470J \quad \text{Ans.}$$

**4.36 BASIS: 100 lbmol DRY flue gases containing 3.00 lbmol CO<sub>2</sub> and 11.80 lbmol CO x lbmol O<sub>2</sub> and 100-(14.8-x)= 85.2-x lbmol N<sub>2</sub>. The oil therefore contains 14.80 lbmol carbon;a carbon balance gives the mass of oil burned:**

$$14.8 \cdot \frac{12.011}{0.85} \cdot lb_m = 209.133 lb_m$$

**The oil also contains H<sub>2</sub>O:**

$$\frac{209.133 \cdot 0.01}{18.015} \cdot lbmol = 0.116 lbmol$$

**Also H<sub>2</sub>O is formed by combustion of H<sub>2</sub> in the oil in the amount**

$$\frac{209.133 \cdot 0.12}{2.016} \cdot lbmol = 12.448 lbmol$$

**Find amount of air entering by N<sub>2</sub> & O<sub>2</sub> balances.**

**N<sub>2</sub> entering in oil:**

$$\frac{209.133 \cdot 0.02}{28.013} \cdot lbmol = 0.149 lbmol$$

**lbmol N<sub>2</sub> entering in the air=(85.2-x)-0.149 =85.051-x**

**lbmol O<sub>2</sub> in flue gas entering with dry air =**

$$3.00 + 11.8/2 + x + 12.448/2 = 15.124 + x lbmol$$

**(CO<sub>2</sub>) (CO) (O<sub>2</sub>) (H<sub>2</sub>O from combustion)**

**Total dry air = N<sub>2</sub> in air + O<sub>2</sub> in air = 85.051 - x + 15.124 + x = 100.175 lbmol**

Since air is 21 mol % O<sub>2</sub>,

$$0.21 = \frac{15.124 + x}{100.175} \quad x := (0.21 \cdot 100.175 - 15.124) \cdot \text{lbmol} \quad x = 5.913 \text{ lbmol}$$

O<sub>2</sub> in air = 15.124 + x = 21.037 lbmols

N<sub>2</sub> in air = 85.051 - x = 79.138 lbmoles

N<sub>2</sub> in flue gas = 79.138 + 0.149 = 79.287 lbmols

[CHECK: Total dry flue gas  
= 3.00 + 11.80 + 5.913 + 79.287  
= 100.00 lbmol]

Humidity of entering air, sat. at 77 degF in lbmol H<sub>2</sub>O/lbmol dry air,  
P(sat)=0.4594(psia)

$$\frac{0.4594}{14.696 - 0.4594} = 0.03227$$

lbmol H<sub>2</sub>O entering in air:

$$0.03227 \cdot 100.175 \cdot \text{lbmol} = 3.233 \text{ lbmol}$$

If y = lbmol H<sub>2</sub>O evaporated in the drier, then  
lbmol H<sub>2</sub>O in flue gas = 0.116+12.448+3.233+y  
= 15.797 + y

Entering the process are oil, moist air, and the wet material to be dried, all at 77 degF. The "products" at 400 degF consist of:

3.00 lbmol CO<sub>2</sub>  
11.80 lbmol CO  
5.913 lbmol O<sub>2</sub>  
79.287 lbmol N<sub>2</sub>  
(15.797 + y) lbmol H<sub>2</sub>O(g)

Energy balance:  $Q = \Delta H = \Delta H_{298} + \Delta H_P$

where Q = 30% of net heating value of the oil:

$$Q := -0.3 \cdot 19000 \cdot \frac{\text{BTU}}{\text{lb}_m} \cdot 209.13 \cdot \text{lb}_m$$

$$Q = -1.192 \times 10^6 \text{ BTU}$$

Reaction upon which net heating value is based:

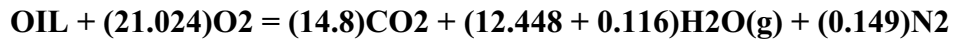

$$\Delta H_{298a} := -19000 \cdot 209.13 \cdot \text{BTU}$$

$$\Delta H_{298a} = -3.973 \times 10^6 \text{ BTU}$$

To get the "reaction" in the drier, we add to this the following:

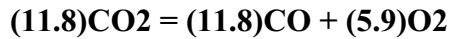

$$\Delta H_{298b} := 11.8 \cdot (-110525 + 393509) \cdot 0.42993 \cdot \text{BTU}$$

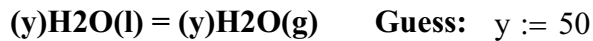

$$\Delta H_{298c}(y) := 44012 \cdot 0.42993 \cdot y \cdot \text{BTU}$$

[The factor 0.42993 converts from joules on the basis of moles to Btu on the basis of lbmol.]

Addition of these three reactions gives the "reaction" in the drier, except for some O<sub>2</sub>, N<sub>2</sub>, and H<sub>2</sub>O that pass through unchanged. Addition of the corresponding delta H values gives the standard heat of reaction at 298 K:

$$\Delta H_{298}(y) := \Delta H_{298a} + \Delta H_{298b} + \Delta H_{298c}(y)$$

For the product stream we need MCPH:

1: CO<sub>2</sub> 2: CO 3: O<sub>2</sub> 4: N<sub>2</sub> 5: H<sub>2</sub>O

$$T_0 := 298.15$$

$$r := 1.986$$

$$T := \frac{400 + 459.67}{1.8}$$

$$T = 477.594$$

$$n(y) := \begin{pmatrix} 3 \\ 11.8 \\ 5.913 \\ 79.278 \\ 15.797 + y \end{pmatrix}$$

$$A := \begin{pmatrix} 5.457 \\ 3.376 \\ 3.639 \\ 3.280 \\ 3.470 \end{pmatrix}$$

$$B := \begin{pmatrix} 1.045 \\ 0.557 \\ 0.506 \\ 0.593 \\ 1.450 \end{pmatrix} \cdot 10^{-3}$$

$$D := \begin{pmatrix} -1.157 \\ -0.031 \\ -0.227 \\ 0.040 \\ 0.121 \end{pmatrix} \cdot 10^5$$

$$i := 1..5 \quad A(y) := \sum_i (h(y)_i \cdot A_i) \quad B(y) := \sum_i (h(y)_i \cdot B_i) \quad D(y) := \sum_i (h(y)_i \cdot D_i)$$

$$\tau := \frac{T}{T_0} \quad \tau = 1.602 \quad C_P(y) := r \cdot \left[ A(y) + \frac{B(y)}{2} \cdot T_0 \cdot \left( \frac{T}{T_0} \right) + 1 + \frac{D(y)}{\tau \cdot T_0^2} \right]$$

Given  $C_p(y) \cdot (400 - 77) \cdot \text{BTU} = Q - \Delta H_{298}(y)$   $y := \text{Find}(y)$

$y = 49.782$  (lbmol H<sub>2</sub>O evaporated)

Whence  $\frac{y \cdot 18.015}{209.13} = 4.288$  (lb H<sub>2</sub>O evap. per lb oil burned)  
**Ans.**

**4.37 BASIS: One mole of product gas containing 0.242 mol HCN, and (1-0.242)/2 = 0.379 mol each of N<sub>2</sub> and C<sub>2</sub>H<sub>2</sub>. The energy balance is**

$Q = \Delta H = \Delta H_{298} + \Delta H_p$

$\Delta H_{298} := (2 \cdot 135100 - 227480) \cdot \frac{0.242}{2} \cdot \text{J}$

$\Delta H_{298} = 5.169 \times 10^3 \text{ J}$

**Products:**

$n := \begin{pmatrix} 0.242 \\ 0.379 \\ 0.379 \end{pmatrix}$

$A := \begin{pmatrix} 4.736 \\ 3.280 \\ 6.132 \end{pmatrix}$

$B := \begin{pmatrix} 1.359 \\ 0.593 \\ 1.952 \end{pmatrix} \cdot 10^{-3}$

$D := \begin{pmatrix} -0.725 \\ 0.040 \\ -1.299 \end{pmatrix} \cdot 10^5$

$i := 1..3 \quad A := \sum_i (h_i \cdot A_i) \quad B := \sum_i (h_i \cdot B_i) \quad D := \sum_i (h_i \cdot D_i)$

$A = 4.7133 \quad B = 1.2934 \times 10^{-3} \quad C := 0 \quad D = -6.526 \times 10^4$

$\Delta H_p := R \cdot \text{MCPH}(298.15\text{K}, 873.15\text{K}, A, B, C, D) \cdot (873.15\text{K} - 298.15\text{K}) \cdot \text{mol}$

$\Delta H_p = 2.495 \times 10^4 \text{ J}$

$\Delta H_p = 2.495 \times 10^4 \text{ J}$

$Q := \Delta H_{298} + \Delta H_p$

**Q = 30124 J Ans.**

**4.38 BASIS: 1 mole gas entering reactor, containing 0.6 mol HCl, 0.36 mol O<sub>2</sub>, and 0.04 mol N<sub>2</sub>.**

HCl reacted = (0.6)(0.75) = 0.45 mol

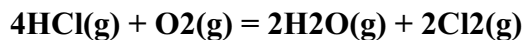

For this reaction,

$$\Delta H_{298} := [2 \cdot (-241818) - 4 \cdot (-92307)] \cdot \frac{\text{J}}{\text{mol}}$$

$$\Delta H_{298} = -1.144 \times 10^5 \frac{\text{J}}{\text{mol}}$$

Evaluate  $\Delta H_{823}$  by Eq. (4.21) with

$$T_0 := 298.15\text{K}$$

$$T := 823.15\text{K}$$

1: H<sub>2</sub>O 2: Cl<sub>2</sub> 3: HCl 4=O<sub>2</sub>

$$n := \begin{pmatrix} 2 \\ 2 \\ -4 \\ -1 \end{pmatrix}$$

$$A := \begin{pmatrix} 3.470 \\ 4.442 \\ 3.156 \\ 3.639 \end{pmatrix}$$

$$B := \begin{pmatrix} 1.45 \\ 0.089 \\ 0.623 \\ 0.506 \end{pmatrix} \cdot 10^{-3}$$

$$D := \begin{pmatrix} 0.121 \\ -0.344 \\ 0.151 \\ -0.227 \end{pmatrix} \cdot 10^5$$

$$i := 1..4 \quad \Delta A := \sum_i (h_i \cdot A_i) \quad \Delta B := \sum_i (h_i \cdot B_i) \quad \Delta D := \sum_i (h_i \cdot D_i)$$

$$\Delta A = -0.439 \quad \Delta B = 8 \times 10^{-5} \quad \Delta C := 0 \quad \Delta D = -8.23 \times 10^4$$

$$\Delta H_{823} := \Delta H_{298} + \text{MCPH}(T_0, T, \Delta A, \Delta B, \Delta C, D) \cdot R \cdot (T - T_0)$$

$$\Delta H_{823} = -117592 \frac{\text{J}}{\text{mol}}$$

Heat transferred per mol of entering gas mixture:

$$Q := \frac{\Delta H_{823}}{4} \cdot 0.45 \cdot \text{mol}$$

$$Q = -13229\text{J} \quad \text{Ans.}$$

4.39 CO<sub>2</sub> + C = 2CO

$$\Delta H_{298a} := 172459 \frac{\text{J}}{\text{mol}} \quad (\text{a})$$

2C + O<sub>2</sub> = 2CO

$$\Delta H_{298b} := -221050 \frac{\text{J}}{\text{mol}} \quad (\text{b})$$

Eq. (4.21) applies to each reaction:

For (a):

$$n := \begin{pmatrix} 2 \\ -1 \\ -1 \end{pmatrix}$$

$$A := \begin{pmatrix} 3.376 \\ 1.771 \\ 5.457 \end{pmatrix}$$

$$B := \begin{pmatrix} 0.557 \\ 0.771 \\ 1.045 \end{pmatrix} \cdot 10^{-3}$$

$$D := \begin{pmatrix} -0.031 \\ -0.867 \\ -1.157 \end{pmatrix} \cdot 10^5$$

$$i := 1..3 \quad \Delta A := \sum_i (h_i \cdot A_i) \quad \Delta B := \sum_i (h_i \cdot B_i) \quad \Delta D := \sum_i (h_i \cdot D_i)$$

$$\Delta A = -0.476 \quad \Delta B = -7.02 \times 10^{-4} \quad \Delta C := 0 \quad \Delta D = 1.962 \times 10^5$$

$$\Delta H_{1148a} := \Delta H_{298a} \dots \\ + R \cdot \text{MCPH}(298.15\text{K}, 1148.15\text{K}, \Delta A, \Delta B, \Delta C, \Delta D) \cdot (1148.15\text{K} - 298.15\text{K})$$

$$\Delta H_{1148a} = 1.696 \times 10^5 \frac{\text{J}}{\text{mol}}$$

**For (b):**

$$n := \begin{pmatrix} 2 \\ -1 \\ -2 \end{pmatrix} \quad A := \begin{pmatrix} 3.376 \\ 3.639 \\ 1.771 \end{pmatrix} \quad B := \begin{pmatrix} 0.557 \\ 0.506 \\ 0.771 \end{pmatrix} \cdot 10^{-3} \quad D := \begin{pmatrix} -0.031 \\ -0.227 \\ -0.867 \end{pmatrix} \cdot 10^5$$

$$i := 1..3 \quad \Delta A := \sum_i (h_i \cdot A_i) \quad \Delta B := \sum_i (h_i \cdot B_i) \quad \Delta D := \sum_i (h_i \cdot D_i)$$

$$\Delta A = -0.429 \quad \Delta B = -9.34 \times 10^{-4} \quad \Delta C := 0 \quad \Delta D = 1.899 \times 10^5$$

$$\Delta H_{1148b} := \Delta H_{298b} \dots \\ + R \cdot \text{MCPH}(298.15\text{K}, 1148.15\text{K}, \Delta A, \Delta B, \Delta C, \Delta D) \cdot (1148.15\text{K} - 298.15\text{K})$$

$$\Delta H_{1148b} = -2.249 \times 10^5 \frac{\text{J}}{\text{mol}}$$

**The combined heats of reaction must be zero:**

$$n_{\text{CO}_2} \cdot \Delta H_{1148a} + n_{\text{O}_2} \cdot \Delta H_{1148b} = 0$$

**Define:**  $r = \frac{n_{\text{CO}_2}}{n_{\text{O}_2}} \quad r := \frac{-\Delta H_{1148b}}{\Delta H_{1148a}} \quad r = 1.327$

For 100 mol flue gas and x mol air, moles are:

	Flue gas	Air	Feed mix
CO <sub>2</sub>	12.8	0	12.8
CO	3.7	0	3.7
O <sub>2</sub>	5.4	0.21x	5.4 + 0.21x
N <sub>2</sub>	78.1	0.79x	78.1 + 0.79x

Whence in the feed mix:  $r = \frac{12.8}{5.4 + 0.21 \cdot x}$

$$x := \frac{\frac{12.8}{r} - 5.4}{0.21} \cdot \text{mol}$$

$$x = 19.155 \text{ mol}$$

Flue gas to air ratio =

$$\frac{100}{19.155} = 5.221$$

Ans.

Product composition:

$$n_{\text{CO}} := 3.7 + 2 \cdot (12.8 + 5.4 + 0.21 \cdot 19.155)$$

$$n_{\text{CO}} = 48.145$$

$$n_{\text{N}_2} := 78.1 + 0.79 \cdot 19.155$$

$$n_{\text{N}_2} = 93.232$$

$$\text{Mole \% CO} = \frac{n_{\text{CO}}}{n_{\text{CO}} + n_{\text{N}_2}} \cdot 100 = 34.054$$

Ans.

$$\text{Mole \% N}_2 = 100 - 34.054 = 65.946$$

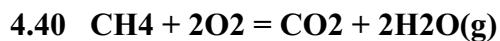

$$\Delta H_{298a} := -802625 \frac{\text{J}}{\text{mol}}$$

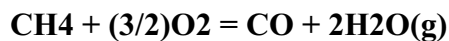

$$\Delta H_{298b} := -519641 \frac{\text{J}}{\text{mol}}$$

BASIS: 1 mole of fuel gas consisting of 0.94 mol CH<sub>4</sub> and 0.06 mol N<sub>2</sub>

Air entering contains:

$$1.35 \cdot 2 \cdot 0.94 = 2.538 \quad \text{mol O}_2$$

$$2.538 \cdot \frac{79}{21} = 9.548 \quad \text{mol N}_2$$

$$\text{Moles CO}_2 \text{ formed by reaction} = 0.94 \cdot 0.7 = 0.658$$

$$\text{Moles CO formed by reaction} = 0.94 \cdot 0.3 = 0.282$$

$$\Delta H_{298} := (0.658 \cdot \Delta H_{298a} + 0.282 \cdot \Delta H_{298b}) \quad \Delta H_{298} = -6.747 \times 10^5 \frac{\text{J}}{\text{mol}}$$

$$\text{Moles H}_2\text{O formed by reaction} = 0.94 \cdot 2.0 = 1.88$$

$$\text{Moles O}_2 \text{ consumed by reaction} = 2 \cdot 0.658 + \frac{3}{2} \cdot 0.282 = 1.739$$

Product gases contain the following numbers of moles:

- (1) CO<sub>2</sub>: 0.658
- (2) CO: 0.282
- (3) H<sub>2</sub>O: 1.880
- (4) O<sub>2</sub>: 2.538 - 1.739 = 0.799
- (5) N<sub>2</sub>: 9.548 + 0.060 = 9.608

$$n := \begin{pmatrix} 0.658 \\ 0.282 \\ 1.880 \\ 0.799 \\ 9.608 \end{pmatrix} \quad A := \begin{pmatrix} 5.457 \\ 3.376 \\ 3.470 \\ 3.639 \\ 3.280 \end{pmatrix} \quad B := \begin{pmatrix} 1.045 \\ 0.557 \\ 1.450 \\ 0.506 \\ 0.593 \end{pmatrix} \cdot 10^{-3} \quad D := \begin{pmatrix} -1.157 \\ -0.031 \\ 0.121 \\ -0.227 \\ 0.040 \end{pmatrix} \cdot 10^5$$

$$i := 1..5 \quad A := \sum_i (n_i \cdot A_i) \quad B := \sum_i (n_i \cdot B_i) \quad D := \sum_i (n_i \cdot D_i)$$

$$A = 45.4881 \quad B = 9.6725 \times 10^{-3} \quad C := 0 \quad D = -3.396 \times 10^4$$

$$\Delta H_p := R \cdot \text{MCPH}(298.15\text{K}, 483.15\text{K}, A, B, C, D) \cdot (483.15\text{K} - 298.15\text{K})$$

$$\Delta H_p = 7.541 \times 10^4 \frac{\text{J}}{\text{mol}}$$

$$\text{Energy balance:} \quad \Delta H_{rx} := \Delta H_{298} + \Delta H_p \quad \Delta H_{rx} = -599.252 \frac{\text{kJ}}{\text{mol}}$$

$$\Delta H_{\text{H}_2\text{O}} \cdot \dot{m}_{\text{H}_2\text{O}} + H_{rx} \cdot \dot{m}_{\text{fuel}} = 0 \quad \dot{m}_{\text{H}_2\text{O}} := 34.0 \frac{\text{kg}}{\text{sec}}$$



From Table C.1:

$$\Delta H_{\text{H}_2\text{O}} := (398.0 - 104.8) \cdot \frac{\text{kJ}}{\text{kg}}$$

$$\dot{n}_{\text{fuel}} := \frac{-\Delta H_{\text{H}_2\text{O}} \cdot \dot{m}_{\text{H}_2\text{O}}}{\Delta H_{\text{rx}}}$$

$$\dot{n}_{\text{fuel}} = 16.635 \frac{\text{mol}}{\text{sec}}$$

Volumetric flow rate of fuel, assuming ideal gas:

$$V := \frac{\dot{n}_{\text{fuel}} \cdot R \cdot 298.15 \cdot \text{K}}{101325 \cdot \text{Pa}}$$

$$V = 0.407 \frac{\text{m}^3}{\text{sec}}$$

Ans.

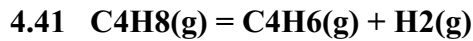

$$\Delta H_{298} := 109780 \cdot \frac{\text{J}}{\text{mol}}$$

BASIS: 1 mole  $\text{C}_4\text{H}_8$  entering, of which 33% reacts.

The unreacted  $\text{C}_4\text{H}_8$  and the diluent  $\text{H}_2\text{O}$  pass through the reactor unchanged, and need not be included in the energy balance. Thus

$$n := \begin{pmatrix} 1 \\ 1 \\ -1 \end{pmatrix}$$

$$T_0 := 298.15 \cdot \text{K}$$

$$T := 798.15 \cdot \text{K}$$

Evaluate  $\Delta H_{798}$  by Eq. (4.21):

1:  $\text{C}_4\text{H}_6$  2:  $\text{H}_2$  3:  $\text{C}_4\text{H}_8$

$$A := \begin{pmatrix} 2.734 \\ 3.249 \\ 1.967 \end{pmatrix}$$

$$B := \begin{pmatrix} 26.786 \\ 0.422 \\ 31.630 \end{pmatrix} \cdot 10^{-3}$$

$$C := \begin{pmatrix} -8.882 \\ 0.0 \\ -9.873 \end{pmatrix} \cdot 10^{-6}$$

$$D := \begin{pmatrix} 0.0 \\ 0.083 \\ 0.0 \end{pmatrix} \cdot 10^5$$

$$i := 1..3$$

$$\Delta A := \sum_i (h_i) \cdot \Delta B := \sum_i (h_i) \cdot B_i$$

$$\Delta C := \sum_i (h_i) \cdot C_i$$

$$\Delta D := \sum_i (h_i) \cdot D_i$$

$$\Delta A = 4.016$$

$$\Delta B = -4.422 \times 10^{-3}$$

$$\Delta C = 9.91 \times 10^{-7}$$

$$\Delta D = 8.3 \times 10^3$$

$$\Delta H_{798} := \Delta H_{298} + \text{MCPH}(298.15 \text{K}, 798.15 \text{K}, \Delta A, \Delta B, \Delta C, D \cdot R) \cdot (T - T_0)$$

$$\Delta H_{798} = 1.179 \times 10^5 \frac{\text{J}}{\text{mol}}$$

$$Q := 0.33 \cdot \dot{n}_{\text{fuel}} \cdot \Delta H_{798}$$

$$Q = 38896 \text{ J} \quad \text{Ans.}$$

**4.42 Assume Ideal Gas and P = 1 atm**

$$P := 1 \text{ atm} \quad R = 7.88 \times 10^{-3} \frac{\text{BTU}}{\text{mol} \cdot \text{K}}$$

a)  $T_0 := (70 + 459.67) \text{ rankine}$        $T := T_0 + 20 \text{ rankine}$        $Q := 12 \frac{\text{BTU}}{\text{sec}}$

$$T_0 = 294.261 \text{ K} \quad T = 305.372 \text{ K}$$

$$\text{ICPH}(T_0, T, 3.355, 0.575 \cdot 10^{-3}, 0, -0.016 \cdot 10^5) = 38.995 \text{ K}$$

$$\dot{n} := \frac{Q}{R \cdot \text{ICPH}(T_0, T, 3.355, 0.575 \cdot 10^{-3}, 0, -0.016 \cdot 10^5)} \quad \dot{n} = 39.051 \frac{\text{mol}}{\text{s}}$$

$$\dot{V} := \frac{\dot{n} \cdot R \cdot T_0}{P} \quad \dot{V} = 0.943 \frac{\text{m}^3}{\text{s}} \quad \dot{V} = 33.298 \frac{\text{ft}^3}{\text{sec}} \quad \text{Ans.}$$

b)  $T_0 := (24 + 273.15) \text{ K}$        $T := T_0 + 13 \text{ K}$        $Q := 12 \frac{\text{kJ}}{\text{s}}$

$$R = 8.314 \times 10^{-3} \frac{\text{kJ}}{\text{mol} \cdot \text{K}}$$

$$\text{ICPH}(T_0, T, 3.355, 0.575 \cdot 10^{-3}, 0, -0.016 \cdot 10^5) = 45.659 \text{ K}$$

$$\dot{n} := \frac{Q}{R \cdot \text{ICPH}(T_0, T, 3.355, 0.575 \cdot 10^{-3}, 0, -0.016 \cdot 10^5)} \quad \dot{n} = 31.611 \frac{\text{mol}}{\text{s}}$$

$$\dot{V} := \frac{\dot{n} \cdot R \cdot T_0}{P} \quad \dot{V} = 0.7707 \frac{\text{m}^3}{\text{s}} \quad \text{Ans.}$$

**4.43 Assume Ideal Gas and P = 1 atm**       $P := 1 \text{ atm}$

a)  $T_0 := (94 + 459.67) \text{ rankine}$        $T := (68 + 459.67) \text{ rankine}$

$$R = 1.61 \times 10^{-3} \frac{\text{atm} \cdot \text{ft}^3}{\text{mol} \cdot \text{rankine}}$$

$$\dot{V} := 50 \frac{\text{ft}^3}{\text{sec}} \quad \dot{n} := \frac{P \cdot \dot{V}}{R \cdot T_0} \quad \dot{n} = 56.097 \frac{\text{mol}}{\text{s}}$$

$$T_0 = 307.594 \text{ K}$$

$$T = 293.15 \text{ K}$$

$$\text{ICPH}(T_0, T, 3.355, 0.575 \cdot 10^{-3}, 0, -0.016 \cdot 10^5) = -50.7 \text{ K}$$

$$R = 7.88 \times 10^{-3} \frac{\text{BTU}}{\text{mol} \cdot \text{K}}$$

$$Q := R \cdot \text{ICPH}(T_0, T, 3.355, 0.575 \cdot 10^{-3}, 0, -0.016 \cdot 10^5) \cdot \dot{n}$$

$$Q = -22.4121 \frac{\text{BTU}}{\text{sec}} \quad \text{Ans.}$$

b)  $T_0 := (35 + 273.15) \text{ K}$

$$T := (25 + 273.15) \text{ K}$$

$$R = 8.205 \times 10^{-5} \frac{\text{atm} \cdot \text{m}^3}{\text{mol} \cdot \text{K}}$$

$$\dot{V} := 1.5 \cdot \frac{\text{m}^3}{\text{sec}}$$

$$\dot{n} := \frac{P \cdot \dot{V}}{R \cdot T_0}$$

$$\dot{n} = 59.325 \frac{\text{mol}}{\text{s}}$$

$$\text{ICPH}(T_0, T, 3.355, 0.575 \cdot 10^{-3}, 0, -0.016 \cdot 10^5) = -35.119 \text{ K}$$

$$R = 8.314 \times 10^{-3} \frac{\text{kJ}}{\text{mol} \cdot \text{K}}$$

$$Q := R \cdot \text{ICPH}(T_0, T, 3.355, 0.575 \cdot 10^{-3}, 0, -0.016 \cdot 10^5) \cdot \dot{n}$$

$$Q = -17.3216 \frac{\text{kJ}}{\text{s}} \quad \text{Ans.}$$

#### 4.44 First calculate the standard heat of combustion of propane



$$\Delta H_{298} := 3 \cdot \left( -393509 \cdot \frac{\text{J}}{\text{mol}} \right) + 4 \cdot \left( -241818 \cdot \frac{\text{J}}{\text{mol}} \right) - \left( -104680 \cdot \frac{\text{J}}{\text{mol}} \right)$$

$$\Delta H_{298} = -2.043 \times 10^6 \frac{\text{J}}{\text{mol}}$$

$$\text{Cost} := 2.20 \frac{\text{dollars}}{\text{gal}}$$

$$\eta := 80\%$$

Estimate the density of propane using the Rackett equation

$$T_c := 369.8\text{K} \quad Z_c := 0.276 \quad V_c := 200.0 \frac{\text{cm}^3}{\text{mol}}$$

$$T := (25 + 273.15)\text{K} \quad T_r := \frac{T}{T_c} \quad T_r = 0.806$$

$$V_{\text{sat}} := V_c \cdot Z_c^{0.2857} \quad V_{\text{sat}} = 89.373 \frac{\text{cm}^3}{\text{mol}}$$

$$\text{Heating\_cost} := \frac{V_{\text{sat}} \cdot \text{Cost}}{\eta \Delta |H_{298}|} \quad \text{Heating\_cost} = 0.032 \frac{\text{dollars}}{\text{MJ}} \quad \text{Ans.}$$

$$\text{Heating\_cost} = 33.528 \frac{\text{dollars}}{10^6 \text{BTU}}$$

4.45  $T_0 := (25 + 273.15)\text{K}$   $T := (500 + 273.15)\text{K}$

a) Acetylene  $Q := R \cdot \text{ICPH}(T_0, T, 6.132, 1.952 \cdot 10^{-3}, 0, -1.299 \cdot 10^5)$

$$Q = 2.612 \times 10^4 \frac{\text{J}}{\text{mol}}$$

The calculations are repeated and the answers are in the following table:

	J/mol
a) Acetylene	26,120
b) Ammonia	20,200
c) n-butane	71,964
d) Carbon dioxide	21,779
e) Carbon monoxide	14,457
f) Ethane	38,420
g) Hydrogen	13,866
h) Hydrogen chloride	14,040
i) Methane	23,318
j) Nitric oxide	14,730
k) Nitrogen	14,276
l) Nitrogen dioxide	20,846
m) Nitrous oxide	22,019
n) Oxygen	15,052
o) Propylene	46,147

4.46  $T_0 := (25 + 273.15)\text{K}$        $T := (500 + 273.15)\text{K}$

$$Q := 30000 \frac{\text{J}}{\text{mol}}$$

a) Acetylene      Given  $Q = R \cdot \text{ICPH}(T_0, T, 6.132, 1.952 \cdot 10^{-3}, 0, -1.299 \cdot 10^5)$

$T := \text{Find}(T)$        $T = 835.369\text{K}$        $T - 273.15\text{K} = 562.2\text{degC}$

The calculations are repeated and the answers are in the following table:

		T (K)	T (C)
a)	Acetylene	835.4	562.3
b)	Ammonia	964.0	690.9
c)	n-butane	534.4	261.3
d)	Carbon dioxide	932.9	659.8
e)	Carbon monoxide	1248.0	974.9
f)	Ethane	690.2	417.1
g)	Hydrogen	1298.4	1025.3
h)	Hydrogen chloride	1277.0	1003.9
i)	Methane	877.3	604.2
j)	Nitric oxide	1230.2	957.1
k)	Nitrogen	1259.7	986.6
l)	Nitrogen dioxide	959.4	686.3
m)	Nitrous oxide	927.2	654.1
n)	Oxygen	1209.9	936.8
o)	Propylene	636.3	363.2

4.47  $T_0 := (25 + 273.15)\text{K}$        $T := (250 + 273.15)\text{K}$        $Q := 11500 \frac{\text{J}}{\text{mol}}$

a) Guess mole fraction of methane:  $y := 0.5$

Given

$$y \cdot \text{ICPH}(T_0, T, 1.702, 9.081 \cdot 10^{-3}, -2.164 \cdot 10^{-6}, 0) \cdot R \dots = Q$$

$$+ (1 - y) \cdot \text{ICPH}(T_0, T, 1.131, 19.225 \cdot 10^{-3}, -5.561 \cdot 10^{-6}, 0) \cdot R$$

$y := \text{Find}(y)$        $y = 0.637$       Ans.

b)  $T_0 := (100 + 273.15)K$        $T := (400 + 273.15) \cdot K$        $Q := 54000 \frac{J}{mol}$

Guess mole fraction of benzene       $y := 0.5$

Given

$$y \cdot \text{ICPH}(T_0, T, -0.206, 39.064 \cdot 10^{-3}, -13.301 \cdot 10^{-6}, 0 \cdot R \dots) = Q$$

$$+ (1 - y) \cdot \text{ICPH}(T_0, T, -3.876, 63.249 \cdot 10^{-3}, -20.928 \cdot 10^{-6}, 0 \cdot R$$

$y := \text{Find}(y)$        $y = 0.245$       **Ans.**

c)  $T_0 := (150 + 273.15)K$        $T := (250 + 273.15) \cdot K$        $Q := 17500 \frac{J}{mol}$

Guess mole fraction of toluene       $y := 0.5$

Given

$$y \cdot \text{ICPH}(T_0, T, 0.290, 47.052 \cdot 10^{-3}, -15.716 \cdot 10^{-6}, 0 \cdot R \dots) = Q$$

$$+ (1 - y) \cdot \text{ICPH}(T_0, T, 1.124, 55.380 \cdot 10^{-3}, -18.476 \cdot 10^{-6}, 0 \cdot R$$

$y := \text{Find}(y)$        $y = 0.512$       **Ans.**

**4.48** Temperature profiles for the air and water are shown in the figures below. There are two possible situations. In the first case the minimum temperature difference, or "pinch" point occurs at an intermediate location in the exchanger. In the second case, the pinch occurs at one end of the exchanger. There is no way to know a priori which case applies.

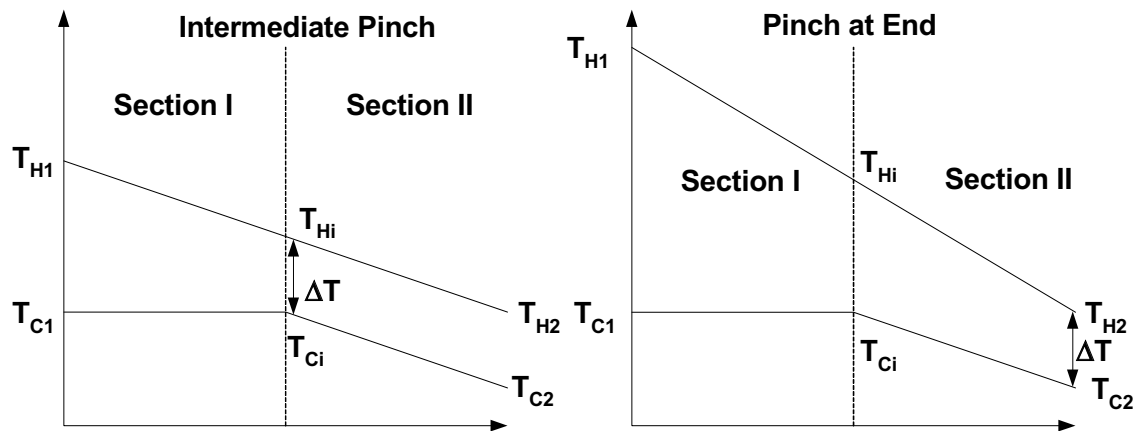

To solve the problem, apply an energy balance around each section of the exchanger.

Section I balance:  $\dot{m}_C \cdot (H_{C1} - H_{Ci}) = \dot{m}_H \cdot \int_{T_{Hi}}^{T_{H1}} C_P dT$

Section II balance:  $\dot{m}_C \cdot (H_{Ci} - H_{C2}) = \dot{m}_H \cdot \int_{T_{H2}}^{T_{Hi}} C_P dT$

If the pinch is intermediate, then  $T_{Hi} = T_{Ci} + \Delta T$ . If the pinch is at the end, then  $T_{H2} = T_{C2} + \Delta T$ .

a)  $T_{H1} := 1000 \text{ degC}$      $T_{C1} := 100 \text{ degC}$      $T_{Ci} := 100 \text{ degC}$      $T_{C2} := 25 \text{ degC}$   
 $\Delta T := 10 \text{ degC}$      $H_{C1} := 2676.0 \frac{\text{kJ}}{\text{kg}}$      $H_{Ci} := 419.1 \frac{\text{kJ}}{\text{kg}}$      $H_{C2} := 104.8 \frac{\text{kJ}}{\text{kg}}$   
 For air from Table C.1  $A := 3.355$      $B := 0.575 \cdot 10^{-3}$      $C := 0$      $D := -0.016 \cdot 10^5$

Assume as a basis  $\dot{m}_H = 1 \text{ mol/s}$ .     $\dot{m}_H := 1 \frac{\text{kmol}}{\text{s}}$

Assume pinch at end:     $T_{H2} := T_{C2} + \Delta T$

Guess:     $\dot{m}_C := 1 \frac{\text{kg}}{\text{s}}$      $T_{Hi} := 110 \text{ degC}$

Given

$\dot{m}_C \cdot (H_{C1} - H_{Ci}) = \dot{m}_H \cdot R \cdot \text{ICPH}(T_{Hi}, T_{H1}, A, B, C, D)$  **Energy balances on Section I and**

$\dot{m}_C \cdot (H_{Ci} - H_{C2}) = \dot{m}_H \cdot R \cdot \text{ICPH}(T_{H2}, T_{Hi}, A, B, C, D)$  **II**

$\begin{pmatrix} \dot{m}_C \\ T_{Hi} \end{pmatrix} := \text{Find}(\dot{m}_C, T_{Hi})$      $T_{Hi} = 170.261 \text{ degC}$      $\dot{m}_C = 11.255 \frac{\text{kg}}{\text{s}}$

$\frac{\dot{m}_C}{\dot{m}_H} = 0.011 \frac{\text{kg}}{\text{mol}}$     **Ans.**

$T_{Hi} - T_{Ci} = 70.261 \text{ degC}$

$T_{H2} - T_{C2} = 10 \text{ degC}$

Since the intermediate temperature difference,  $T_{Hi} - T_{Ci}$  is greater than the temperature difference at the end point,  $T_{H2} - T_{C2}$ , the assumption of a pinch at the end is correct.

b)  $T_{H1} := 500\text{degC}$        $T_{C1} := 100\text{degC}$        $T_{Ci} := 100\text{degC}$        $T_{C2} := 25\text{degC}$   
 $\Delta T := 10\text{degC}$        $H_{C1} := 2676.0 \frac{\text{kJ}}{\text{kg}}$        $H_{Ci} := 419.1 \frac{\text{kJ}}{\text{kg}}$        $H_{C2} := 104.8 \frac{\text{kJ}}{\text{kg}}$

Assume as a basis  $\dot{n} = 1 \text{ mol/s}$ .       $\dot{n}_{H} := 1 \frac{\text{kmol}}{\text{s}}$

Assume pinch is intermediate:       $T_{Hi} := T_{Ci} + \Delta T$

Guess:       $\dot{m}_{C} := 1 \frac{\text{kg}}{\text{s}}$        $T_{H2} := 110\text{degC}$

Given

$\dot{m}_{C} \cdot (H_{C1} - H_{Ci}) = \dot{n}_{H} \cdot R \cdot \text{ICPH}(T_{Hi}, T_{H1}, A, B, C, D)$  **Energy balances on Section I and**

$\dot{m}_{C} \cdot (H_{Ci} - H_{C2}) = \dot{n}_{H} \cdot R \cdot \text{ICPH}(T_{H2}, T_{Hi}, A, B, C, D)$  **II**

$\left( \begin{matrix} \dot{m}_{C} \\ T_{H2} \end{matrix} \right) := \text{Find}(\dot{m}_{C}, T_{H2})$        $T_{H2} = 48.695 \text{degC}$        $\dot{m}_{C} = 5.03 \frac{\text{kg}}{\text{s}}$

$\frac{\dot{m}_{C}}{\dot{n}_{H}} = 5.03 \times 10^{-3} \frac{\text{kg}}{\text{mol}}$       **Ans.**

$T_{Hi} - T_{Ci} = 10 \text{degC}$

$T_{H2} - T_{C2} = 23.695 \text{degC}$

Since the intermediate temperature difference,  $T_{Hi} - T_{Ci}$  is less than the temperature difference at the end point,  $T_{H2} - T_{C2}$ , the assumption of an intermediate pinch is correct.

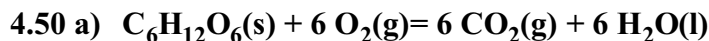

1 =  $\text{C}_6\text{H}_{12}\text{O}_6$ , 2 =  $\text{O}_2$ , 3 =  $\text{CO}_2$ , 4 =  $\text{H}_2\text{O}$

$\Delta H_{0f1} := -1274.4 \frac{\text{kJ}}{\text{mol}}$

$\Delta H_{0f2} := 0 \frac{\text{kJ}}{\text{mol}}$

$M_1 := 180 \frac{\text{gm}}{\text{mol}}$



$$\Delta H_{0f3} := -393.509 \frac{\text{kJ}}{\text{mol}}$$

$$\Delta H_{0f4} := -285.830 \frac{\text{kJ}}{\text{mol}}$$

$$M_3 := 44 \frac{\text{gm}}{\text{mol}}$$

$$\Delta H_{0r} := 6 \cdot \Delta H_{0f3} + 6 \cdot \Delta H_{0f4} - H_{0f1} - 6 \cdot \Delta H_{0f2} \quad \Delta H_{0r} = -2801.634 \frac{\text{kJ}}{\text{mol}} \quad \text{Ans.}$$

b)  $\text{energy\_per\_kg} := 150 \frac{\text{kJ}}{\text{kg}} \quad \text{mass\_person} := 57\text{kg}$

$$\text{mass\_glucose} := \frac{\text{mass\_person} \cdot \text{energy\_per\_kg}}{-\Delta H_{0r}} \cdot M_1 \quad \text{mass\_glucose} = 0.549 \text{kg} \quad \text{Ans.}$$

c) **6 moles of CO<sub>2</sub> are produced for every mole of glucose consumed. Use molecular mass to get ratio of mass CO<sub>2</sub> produced per mass of glucose.**

$$275 \cdot 10^6 \cdot \text{mass\_glucose} \cdot \frac{6 \cdot M_3}{M_1} = 2.216 \times 10^8 \text{kg} \quad \text{Ans.}$$

**4.51 Assume as a basis, 1 mole of fuel.**

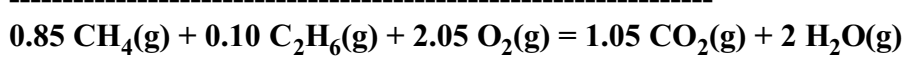
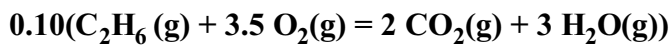
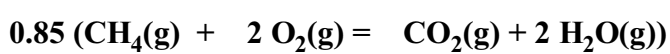

1 = CH<sub>4</sub>, 2 = C<sub>2</sub>H<sub>6</sub>, 3 = O<sub>2</sub>, 4 = CO<sub>2</sub>, 5 = H<sub>2</sub>O 6 = N<sub>2</sub>

$$\Delta H_{0f1} := -74.520 \frac{\text{kJ}}{\text{mol}}$$

$$\Delta H_{0f2} := -83.820 \frac{\text{kJ}}{\text{mol}}$$

$$\Delta H_{0f3} := 0 \frac{\text{kJ}}{\text{mol}}$$

$$\Delta H_{0f4} := -393.509 \frac{\text{kJ}}{\text{mol}}$$

$$\Delta H_{0f5} := -241.818 \frac{\text{kJ}}{\text{mol}}$$

a)  $\Delta H_{0c} := 1.05 \cdot \Delta H_{0f4} + 2 \cdot \Delta H_{0f5} - 0.85 \cdot \Delta H_{0f1} - 0.10 \cdot \Delta H_{0f2} - 1.05 \cdot \Delta H_{0f3}$

$$\Delta H_{0c} = -825.096 \frac{\text{kJ}}{\text{mol}} \quad \text{Ans.}$$

b) **For complete combustion of 1 mole of fuel and 50% excess air, the exit gas will contain the following numbers of moles:**

$n_3 := 0.5 \cdot 2.05 \text{mol} \quad n_3 = 1.025 \text{mol} \quad \text{Excess O}_2$

$$n_4 := 1.05 \text{ mol}$$

$$n_5 := 2 \text{ mol}$$

$$n_6 := 0.05 \text{ mol} + \frac{79}{21} \cdot 1.5 \cdot 2.05 \text{ mol} \quad n_6 = 11.618 \text{ mol} \quad \text{Total } N_2$$

**Air and fuel enter at 25 C and combustion products leave at 600 C.**

$$T_1 := (25 + 273.15) \text{ K}$$

$$T_2 := (600 + 273.15) \text{ K}$$

$$A := \frac{(n_3 \cdot 3.639 + n_4 \cdot 6.311 + n_5 \cdot 3.470 + n_6 \cdot 3.280)}{\text{mol}}$$

$$B := \frac{(n_3 \cdot 0.506 + n_4 \cdot 0.805 + n_5 \cdot 1.450 + n_6 \cdot 0.593) \cdot 10^{-3}}{\text{mol}}$$

$$C := \frac{(n_3 \cdot 0 + n_4 \cdot 0 + n_5 \cdot 0 + n_6 \cdot 0) \cdot 10^{-6}}{\text{mol}}$$

$$D := \frac{[n_3 \cdot (-0.227) + n_4 \cdot (-0.906) + n_5 \cdot 0.121 + n_6 \cdot 0.040] \cdot 10^5}{\text{mol}}$$

$$Q := \Delta H_0_c + \text{ICPH}(T_1, T_2, A, B, C, D) \cdot R$$

$$Q = -529.889 \frac{\text{kJ}}{\text{mol}} \quad \text{Ans.}$$

## Chapter 5 - Section A - Mathcad Solutions

5.2 Let the symbols Q and Work represent rates in kJ/s. Then by Eq. (5.8)

$$\eta = \frac{|Work|}{|Q_H|} = 1 - \frac{T_C}{T_H}$$

$$T_C := 323.15 \cdot K$$

$$T_H := 798.15 \cdot K$$

$$Q_H := 250 \cdot \frac{kJ}{s}$$

$$Work := \left| Q_H \cdot \left( 1 - \frac{T_C}{T_H} \right) \right|$$

$$|Work| = 148.78 \frac{kJ}{s}$$

or  $|Work| = 148.78 \text{ kW}$  which is the power. Ans.

By Eq. (5.1),

$$Q_C := |Q_H| - |Work|$$

$$Q_C = 101.22 \frac{kJ}{s} \quad \text{Ans.}$$

5.3 (a) Let symbols Q and Work represent rates in kJ/s

$$T_H := 750 \cdot K$$

$$T_C := 300 \cdot K$$

$$Work := -95000 \cdot kW$$

By Eq. (5.8):

$$\eta := 1 - \frac{T_C}{T_H}$$

$$\eta = 0.6$$

But

$$\eta = \frac{|Work|}{|Q_H|}$$

Whence

$$Q_H := \frac{|Work|}{\eta}$$

$$Q_H = 1.583 \times 10^5 \text{ kW} \quad \text{Ans.}$$

$$Q_C := |Q_H| - |Work|$$

$$Q_C = 6.333 \times 10^4 \text{ kW} \quad \text{Ans.}$$

(b)  $\eta := 0.35$

$$Q_H := \frac{|Work|}{\eta}$$

$$Q_H = 2.714 \times 10^5 \text{ kW} \quad \text{Ans.}$$

$$Q_C := |Q_H| - |Work|$$

$$Q_C = 1.764 \times 10^5 \text{ kW} \quad \text{Ans.}$$

5.4 (a)  $T_C := 303.15 \cdot K$

$$T_H := 623.15 \cdot K$$

$$\eta_{\text{Carnot}} := 1 - \frac{T_C}{T_H}$$

$$\eta := 0.55 \cdot \eta_{\text{Carnot}}$$

$$\eta = 0.282$$

Ans.

(b)  $\eta := 0.35$

$$\eta_{\text{Carnot}} := \frac{\eta}{0.55}$$

$$\eta_{\text{Carnot}} = 0.636$$

By Eq. (5.8),

$$T_{\text{H}} := \frac{T_{\text{C}}}{1 - \eta_{\text{Carnot}}}$$

$$T_{\text{H}} = 833.66 \text{ K} \quad \text{Ans.}$$

5.7 Let the symbols represent rates where appropriate. Calculate mass rate of LNG evaporation:

$$V := 9000 \cdot \frac{\text{m}^3}{\text{s}}$$

$$P := 1.0133 \cdot \text{bar}$$

$$T := 298.15 \cdot \text{K}$$

$$\text{molwt} := 17 \frac{\text{gm}}{\text{mol}}$$

$$m_{\text{LNG}} := \frac{P \cdot V}{R \cdot T} \cdot \text{molwt}$$

$$m_{\text{LNG}} = 6254 \frac{\text{kg}}{\text{s}}$$

Maximum power is generated by a Carnot engine, for which

$$\frac{|\text{Work}|}{|Q_{\text{C}}|} = \frac{|Q_{\text{H}}| - |Q_{\text{C}}|}{|Q_{\text{C}}|} = \frac{|Q_{\text{H}}|}{|Q_{\text{C}}|} - 1 = \frac{T_{\text{H}}}{T_{\text{C}}} - 1$$

$$T_{\text{H}} := 303.15 \cdot \text{K}$$

$$T_{\text{C}} := 113.7 \cdot \text{K}$$

$$Q_{\text{C}} := 512 \cdot \frac{\text{kJ}}{\text{kg}} \cdot m_{\text{LNG}}$$

$$Q_{\text{C}} = 3.202 \times 10^6 \text{ kW}$$

$$\text{Work} := Q_{\text{C}} \cdot \left( \frac{T_{\text{H}}}{T_{\text{C}}} - 1 \right)$$

$$\text{Work} = 5.336 \times 10^6 \text{ kW} \quad \text{Ans.}$$

$$Q_{\text{H}} := Q_{\text{C}} + \text{Work}$$

$$Q_{\text{H}} = 8.538 \times 10^6 \text{ kW} \quad \text{Ans.}$$

5.8 Take the heat capacity of water to be constant at the value  $C_{\text{P}} := 4.184 \cdot \frac{\text{kJ}}{\text{kg} \cdot \text{K}}$

(a)  $T_1 := 273.15 \cdot \text{K}$     $T_2 := 373.15 \cdot \text{K}$     $Q := C_{\text{P}} \cdot (T_2 - T_1)$     $Q = 418.4 \frac{\text{kJ}}{\text{kg}}$

$$\Delta S_{\text{H}_2\text{O}} := C_{\text{P}} \cdot \ln \left( \frac{T_2}{T_1} \right)$$

$$\Delta S_{\text{H}_2\text{O}} = 1.305 \frac{\text{kJ}}{\text{kg} \cdot \text{K}}$$

$$\Delta S_{\text{res}} := \frac{-Q}{T_2}$$

$$\Delta S_{\text{res}} = -1.121 \frac{\text{kJ}}{\text{kg} \cdot \text{K}} \quad \text{Ans.}$$

$$\Delta S_{\text{total}} := \Delta S_{\text{H}_2\text{O}} + \Delta S_{\text{res}} \quad \Delta S_{\text{total}} = 0.184 \frac{\text{kJ}}{\text{kg}\cdot\text{K}} \quad \text{Ans.}$$

(b) The entropy change of the water is the same as in (a), and the total heat transfer is the same, but divided into two halves.

$$\Delta S_{\text{res}} := \frac{-Q}{2} \cdot \left( \frac{1}{323.15 \cdot \text{K}} + \frac{1}{373.15 \cdot \text{K}} \right) \quad \Delta S_{\text{res}} = -1.208 \frac{\text{kJ}}{\text{kg}\cdot\text{K}}$$

$$\Delta S_{\text{total}} := \Delta S_{\text{res}} + \Delta S_{\text{H}_2\text{O}} \quad \Delta S_{\text{total}} = 0.097 \frac{\text{kJ}}{\text{kg}\cdot\text{K}} \quad \text{Ans.}$$

(c) The reversible heating of the water requires an infinite number of heat reservoirs covering the range of temperatures from 273.15 to 373.15 K, each one exchanging an infinitesimal quantity of heat with the water and raising its temperature by a differential increment.

5.9

$$P_1 := 1 \cdot \text{bar}$$

$$T_1 := 500 \cdot \text{K}$$

$$V := 0.06 \cdot \text{m}^3$$

$$n := \frac{P_1 \cdot V}{R \cdot T_1}$$

$$n = 1.443 \text{ mol}$$

$$C_V := \frac{5}{2} \cdot R$$

$$Q := 15000 \cdot \text{J}$$

(a) Const.-V heating;  $\Delta U = Q + W = Q = n \cdot C_V \cdot (T_2 - T_1)$

$$T_2 := T_1 + \frac{Q}{n \cdot C_V} \quad T_2 = 1 \times 10^3 \text{ K}$$

By Eq. (5.18), 
$$\Delta S = n \cdot \left( C_P \cdot \ln \left( \frac{T_2}{T_1} \right) - R \cdot \ln \left( \frac{P_2}{P_1} \right) \right)$$

But  $\frac{P_2}{P_1} = \frac{T_2}{T_1}$  Whence 
$$\Delta S := n \cdot C_V \cdot \ln \left( \frac{T_2}{T_1} \right) \quad \Delta S = 20.794 \frac{\text{J}}{\text{K}} \quad \text{Ans.}$$

(b) The entropy change of the gas is the same as in (a). The entropy change of the surroundings is zero. Whence

$$\Delta S_{\text{total}} = 10.794 \cdot \frac{\text{J}}{\text{K}} \quad \text{Ans.}$$

The stirring process is irreversible.

**5.10 (a) The temperature drop of the second stream (B) in either case is the same as the temperature rise of the first stream (A), i.e., 120 degC. The exit temperature of the second stream is therefore 200 degC. In both cases we therefore have:**

$$C_p := \frac{7}{2}R$$

$$\Delta S_A := C_p \cdot \ln\left(\frac{463.15}{343.15}\right)$$

$$\Delta S_B := C_p \cdot \ln\left(\frac{473.15}{593.15}\right)$$

$$\Delta S_A = 8.726 \frac{\text{J}}{\text{mol} \cdot \text{K}}$$

$$\Delta S_B = -6.577 \frac{\text{J}}{\text{mol} \cdot \text{K}}$$

**Ans.**

**(b) For both cases:**

$$\Delta S_{\text{total}} := \Delta S_A + \Delta S_B$$

$$\Delta S_{\text{total}} = 2.149 \frac{\text{J}}{\text{mol} \cdot \text{K}}$$

**Ans.**

**(c) In this case the final temperature of steam B is 80 degC, i.e., there is a 10-degC driving force for heat transfer throughout the exchanger. Now**

$$\Delta S_A := C_p \cdot \ln\left(\frac{463.15}{343.15}\right)$$

$$\Delta S_B := C_p \cdot \ln\left(\frac{353.15}{473.15}\right)$$

$$\Delta S_A = 8.726 \frac{\text{J}}{\text{mol} \cdot \text{K}}$$

$$\Delta S_B = -8.512 \frac{\text{J}}{\text{mol} \cdot \text{K}}$$

**Ans.**

$$\Delta S_{\text{total}} := \Delta S_A + \Delta S_B$$

$$\Delta S_{\text{total}} = 0.214 \frac{\text{J}}{\text{mol} \cdot \text{K}}$$

**Ans.**

**5.16** By Eq. (5.8),  $\frac{dW}{dQ} = 1 - \frac{T_\sigma}{T}$   $dW = dQ - T_\sigma \cdot \frac{dQ}{T}$

Since  $dQ/T = dS$ ,  $dW = dQ - T_\sigma \cdot dS$

**Integration gives the required result.**

$$T_1 := 600 \cdot \text{K}$$

$$T_2 := 400 \cdot \text{K}$$

$$T_\sigma := 300 \cdot \text{K}$$

$$Q := C_p \cdot (T_2 - T_1)$$

$$Q = -5.82 \times 10^3 \frac{\text{J}}{\text{mol}}$$

$$\Delta S := C_p \cdot \ln\left(\frac{T_2}{T_1}\right) \quad \Delta S = -11.799 \frac{\text{J}}{\text{mol} \cdot \text{K}}$$

$$\text{Work} := Q - T_\sigma \cdot \Delta S \quad \text{Work} = -2280 \frac{\text{J}}{\text{mol}} \quad \text{Ans.}$$

$$Q_\sigma := |Q| - |\text{Work}| \quad Q_\sigma = 3540 \frac{\text{J}}{\text{mol}} \quad \text{Ans.}$$

$$\Delta S_{\text{reservoir}} := \frac{Q_\sigma}{T_\sigma} \quad \Delta S_{\text{reservoir}} = 11.8 \frac{\text{J}}{\text{mol} \cdot \text{K}} \quad \text{Ans.}$$

$$\Delta S + \Delta S_{\text{reservoir}} = 0 \frac{\text{J}}{\text{mol} \cdot \text{K}} \quad \text{Process is reversible.}$$

5.17  $T_{H1} := 600 \cdot \text{K}$      $T_{C1} := 300 \cdot \text{K}$      $T_{H2} := 300 \cdot \text{K}$      $T_{C2} := 250 \cdot \text{K}$

For the Carnot engine, use Eq. (5.8):  $\frac{|W|}{|Q_{H1}|} = \frac{T_{H1} - T_{C1}}{T_{H1}}$

The Carnot refrigerator is a reverse Carnot engine.  $\frac{|W|}{|Q_{C2}|} = \frac{T_{H2} - T_{C2}}{T_{C2}}$   
 Combine Eqs. (5.8) & (5.7) to get:

Equate the two work quantities and solve for the required ratio of the heat quantities:

$$r := \frac{T_{C2}}{T_{H1}} \cdot \left( \frac{T_{H1} - T_{C1}}{T_{H2} - T_{C2}} \right) \quad r = 2.5 \quad \text{Ans.}$$

5.18 (a)  $T_1 := 300 \text{K}$      $P_1 := 1.2 \text{bar}$      $T_2 := 450 \text{K}$      $P_2 := 6 \text{bar}$      $C_p := \frac{7}{2} R$

$$\Delta H := C_p \cdot (T_2 - T_1) \quad \Delta H = 4.365 \times 10^3 \frac{\text{J}}{\text{mol}} \quad \text{Ans.}$$

$$\Delta S := C_p \cdot \ln\left(\frac{T_2}{T_1}\right) - R \cdot \ln\left(\frac{P_2}{P_1}\right) \quad \Delta S = -1.582 \frac{\text{J}}{\text{mol} \cdot \text{K}} \quad \text{Ans.}$$

(b)  $\Delta H = 5.82 \cdot 10^3 \frac{\text{J}}{\text{mol}}$      $\Delta S = 1.484 \frac{\text{J}}{\text{mol} \cdot \text{K}}$

$$\begin{aligned}
 \text{(c)} \quad \Delta H &= -3.118 \cdot 10^3 \frac{\text{J}}{\text{mol}} & \Delta S &= 4.953 \frac{\text{J}}{\text{mol} \cdot \text{K}} \\
 \text{(d)} \quad \Delta H &= -3.741 \cdot 10^3 \frac{\text{J}}{\text{mol}} & \Delta S &= 2.618 \frac{\text{J}}{\text{mol} \cdot \text{K}} \\
 \text{(e)} \quad \Delta H &= -6.651 \cdot 10^3 \frac{\text{J}}{\text{mol}} & \Delta S &= -3.607 \frac{\text{J}}{\text{mol} \cdot \text{K}}
 \end{aligned}$$

**5.19** This cycle is the same as is shown in Fig. 8.10 on p. 305. The equivalent states are A=3, B=4, C=1, and D=2. The efficiency is given by Eq. (A) on p. 305.

Temperature  $T_4$  is not given and must be calculated. The following equations are used to derive an expression for  $T_4$ .

For adiabatic steps 1 to 2 and 3 to 4:

$$T_1 \cdot V_1^{\gamma-1} = T_2 \cdot V_2^{\gamma-1} \qquad T_3 \cdot V_3^{\gamma-1} = T_4 \cdot V_4^{\gamma-1}$$

For constant-volume step 4 to 1:

$$V_1 = V_4$$

For isobaric step 2 to 3:

$$\frac{P_2}{T_2} = \frac{P_3}{T_3}$$

Solving these 4 equations for  $T_4$  yields:  $T_4 = T_1 \cdot \left( \frac{T_2}{T_3} \right)^{-\gamma}$

$$C_p := \frac{7}{2}R$$

$$C_v := \frac{5}{2}R$$

$$\gamma := \frac{C_p}{C_v}$$

$$\gamma = 1.4$$

$$T_1 := (200 + 273.15)\text{K}$$

$$T_2 := (1000 + 273.15)\text{K}$$

$$T_3 := (1700 + 273.15)\text{K}$$

$$T_4 := T_1 \cdot \left( \frac{T_2}{T_3} \right)^{-\gamma}$$

$$T_4 = 873.759\text{K}$$

Eq. (A) p. 306

$$\eta := 1 - \frac{1}{\gamma} \cdot \left( \frac{T_4 - T_1}{T_3 - T_2} \right)$$

$$\eta = 0.591$$

Ans.



5.21  $C_V := C_P - R$        $P_1 := 2 \cdot \text{bar}$        $P_2 := 7 \cdot \text{bar}$        $T_1 := 298.15 \cdot \text{K}$

$$\gamma := \frac{C_P}{C_V} \qquad \gamma = 1.4$$

With the reversible work given by Eq. (3.34), we get for the actual W:

$$\text{Work} := 1.35 \cdot \frac{R \cdot T_1}{\gamma - 1} \cdot \left[ \left( \frac{P_2}{P_1} \right)^{\frac{\gamma-1}{\gamma}} - 1 \right] \qquad \text{Work} = 3.6 \times 10^3 \frac{\text{J}}{\text{mol}}$$

But  $Q = 0$ , and  $W = \Delta U = C_V \cdot (T_2 - T_1)$       Whence  $T_2 := T_1 + \frac{\text{Work}}{C_V}$

$$T_2 = 471.374 \text{ K}$$

$$\Delta S := C_P \cdot \ln \left( \frac{T_2}{T_1} \right) - R \cdot \ln \left( \frac{P_2}{P_1} \right) \qquad \Delta S = 2.914 \frac{\text{J}}{\text{mol} \cdot \text{K}} \qquad \text{Ans.}$$

5.25  $P := 4$        $T := 800$

**Step 1-2: Volume decreases at constant P.**

**Heat flows out of the system. Work is done on the system.**

$$W_{12} = -[P \cdot (V_2 - V_1)] = -[R \cdot (T_2 - T_1)]$$

**Step 2-3: Isothermal compression. Work is done on the system. Heat flows out of the system.**

$$W_{23} = R \cdot T_2 \cdot \ln \left( \frac{P_3}{P_2} \right) = R \cdot T_2 \cdot \ln \left( \frac{P_3}{P_1} \right)$$

**Step 3-1: Expansion process that produces work. Heat flows into the system. Since the PT product is constant,**

$$P \cdot dT + T \cdot dP = 0 \qquad T \cdot \frac{dP}{P} = -dT \qquad \text{(A)}$$

$$P \cdot V = R \cdot T \qquad P \cdot dV + V \cdot dP = R \cdot dT$$

$$P \cdot dV = R \cdot dT - V \cdot dP = R \cdot dT - R \cdot T \cdot \frac{dP}{P}$$

In combination with (A) this becomes

$$P \cdot dV = R \cdot dT + R \cdot dT = 2 \cdot R \cdot dT$$

Moreover, 
$$P_3 = P_1 \cdot \frac{T_1}{T_3} = P_1 \cdot \frac{T_1}{T_2}$$

$$W_{31} = - \int_{V_3}^{V_1} P dV = -2 \cdot R \cdot (T_1 - T_3) = -2 \cdot R \cdot (T_1 - T_2)$$

$$Q_{31} = \Delta U_{31} - W_{31} = C_V \cdot (T_1 - T_3) + 2 \cdot R \cdot (T_1 - T_3)$$

$$Q_{31} = (C_V + 2 \cdot R) \cdot (T_1 - T_3) = (C_P + R) \cdot (T_1 - T_2)$$

$$\eta = \frac{|W_{\text{net}}|}{Q_{\text{in}}} = \frac{|W_{12} + W_{23} + W_{31}|}{Q_{31}}$$

$$C_P := \frac{7}{2} \cdot R$$

$$T_1 := 700 \cdot \text{K}$$

$$T_2 := 350 \cdot \text{K}$$

$$P_1 := 1.5 \cdot \text{bar}$$

$$P_3 := P_1 \cdot \frac{T_1}{T_2}$$

$$W_{12} := -[R \cdot (T_2 - T_1)]$$

$$W_{12} = 2.91 \times 10^3 \frac{\text{J}}{\text{mol}}$$

$$W_{23} := R \cdot T_2 \cdot \ln\left(\frac{P_3}{P_1}\right)$$

$$W_{23} = 2.017 \times 10^3 \frac{\text{J}}{\text{mol}}$$

$$W_{31} := -2 \cdot R \cdot (T_1 - T_2)$$

$$W_{31} = -5.82 \times 10^3 \frac{\text{J}}{\text{mol}}$$

$$Q_{31} := (C_P + R) \cdot (T_1 - T_2)$$

$$Q_{31} = 1.309 \times 10^4 \frac{\text{J}}{\text{mol}}$$

$$\eta := \frac{|W_{12} + W_{23} + W_{31}|}{Q_{31}}$$

$$\eta = 0.068 \quad \text{Ans.}$$

5.26  $T := 403.15 \cdot \text{K}$        $P_1 := 2.5 \cdot \text{bar}$        $P_2 := 6.5 \cdot \text{bar}$        $T_{\text{res}} := 298.15 \cdot \text{K}$

By Eq. (5.18),  $\Delta S := -R \cdot \ln\left(\frac{P_2}{P_1}\right)$        $\Delta S = -7.944 \frac{\text{J}}{\text{mol} \cdot \text{K}}$       Ans.

With the reversible work given by Eq. (3.27), we get for the actual W:

Work :=  $1.3 \cdot R \cdot T \cdot \ln\left(\frac{P_2}{P_1}\right)$  (Isothermal compression)      Work =  $4.163 \times 10^3 \frac{\text{J}}{\text{mol}}$

$Q := -\text{Work}$       Q here is with respect to the system.

So for the heat reservoir, we have

$\Delta S_{\text{res}} := \frac{-Q}{T_{\text{res}}}$        $\Delta S_{\text{res}} = 13.96 \frac{\text{J}}{\text{mol} \cdot \text{K}}$       Ans.

$\Delta S_{\text{total}} := \Delta S + \Delta S_{\text{res}}$        $\Delta S_{\text{total}} = 6.02 \frac{\text{J}}{\text{mol} \cdot \text{K}}$       Ans.

5.27 (a) By Eq. (5.14) with  $P = \text{const.}$  and Eq. (5.15), we get for the entropy change of 10 moles

$n := 10 \cdot \text{mol}$

$\Delta S := n \cdot R \cdot \text{ICPS}\left(473.15 \text{K}, 1373.15 \text{K}, 5.699, 0.640 \cdot 10^{-3}, 0.0, -1.015 \cdot 10^5\right)$

$\Delta S = 536.1 \frac{\text{J}}{\text{K}}$       Ans.

(b) By Eq. (5.14) with  $P = \text{const.}$  and Eq. (5.15), we get for the entropy change of 12 moles

$n := 12 \cdot \text{mol}$

$\Delta S := n \cdot R \cdot \text{ICPS}\left(523.15 \text{K}, 1473.15 \text{K}, 1.213, 28.785 \cdot 10^{-3}, -8.824 \cdot 10^{-6}, 0.0\right)$

$\Delta S = 2018.7 \frac{\text{J}}{\text{K}}$       Ans.

**5.28 (a) The final temperature for this process was found in Pb. 4.2a to be 1374.5 K. The entropy change for 10 moles is then found as follows**

$$n := 10 \cdot \text{mol}$$

$$\Delta S := n \cdot R \cdot \text{ICPS} \left( 473.15 \text{K}, 1374.5 \text{K}, 1.424, 14.394 \cdot 10^{-3}, -4.392 \cdot 10^{-6}, 0.0 \right)$$

$$\Delta S = 900.86 \frac{\text{J}}{\text{K}} \quad \text{Ans.}$$

**(b) The final temperature for this process was found in Pb. 4.2b to be 1413.8 K. The entropy change for 15 moles is then found as follows:**

$$n := 15 \cdot \text{mol}$$

$$\Delta S := n \cdot R \cdot \text{ICPS} \left( 533.15 \text{K}, 1413.8 \text{K}, 1.967, 31.630 \cdot 10^{-3}, -9.873 \cdot 10^{-6}, 0.0 \right)$$

$$\Delta S = 2657.5 \frac{\text{J}}{\text{K}} \quad \text{Ans.}$$

**(c) The final temperature for this process was found in Pb. 4.2c to be 1202.9 K. The entropy change for 18.14 kg moles is then found as follows**

$$n := 18140 \cdot \text{mol}$$

$$\Delta S := n \cdot R \cdot \text{ICPS} \left( 533.15 \text{K}, 1202.9 \text{K}, 1.424, 14.394 \cdot 10^{-3}, -4.392 \cdot 10^{-6}, 0.0 \right)$$

$$\Delta S = 1.2436 \times 10^6 \frac{\text{J}}{\text{K}} \quad \text{Ans.}$$

**5.29 The relative amounts of the two streams are determined by an energy balance. Since  $Q = W = 0$ , the enthalpy changes of the two streams must cancel. Take a basis of 1 mole of air entering, and let  $x =$  moles of chilled air. Then  $1 - x =$  the moles of warm air.**

$$T_0 := 298.15 \cdot \text{K} \quad \text{Temperature of entering air}$$

$$T_1 := 248.15 \cdot \text{K} \quad \text{Temperature of chilled air}$$

$$T_2 := 348.15 \cdot \text{K} \quad \text{Temperature of warm air}$$

$$x \cdot C_P \cdot (T_1 - T_0) + (1 - x) \cdot C_P \cdot (T_2 - T_0) = 0$$

$$x := 0.3 \quad \text{(guess)}$$

$$\text{Given } \frac{x}{1-x} = -\left(\frac{T_2 - T_0}{T_1 - T_0}\right) \quad x := \text{Find}(x) \quad x = 0.5$$

Thus  $x = 0.5$ , and the process produces equal amounts of chilled and warmed air. The only remaining question is whether the process violates the second law. On the basis of 1 mole of entering air, the total entropy change is as follows.

$$C_P := \frac{7}{2} \cdot R \quad P_0 := 5 \cdot \text{bar} \quad P := 1 \cdot \text{bar}$$

$$\Delta S_{\text{total}} := x \cdot C_P \cdot \ln\left(\frac{T_1}{T_0}\right) + (1-x) \cdot C_P \cdot \ln\left(\frac{T_2}{T_0}\right) - R \cdot \ln\left(\frac{P}{P_0}\right)$$

$$\Delta S_{\text{total}} = 12.97 \frac{\text{J}}{\text{mol} \cdot \text{K}} \quad \text{Ans.}$$

Since this is positive, there is no violation of the second law.

5.30

$$T_1 := 523.15 \cdot \text{K} \quad T_2 := 353.15 \cdot \text{K} \quad P_1 := 3 \cdot \text{bar} \quad P_2 := 1 \cdot \text{bar}$$

$$T_{\text{res}} := 303.15 \cdot \text{K} \quad \text{Work} := -1800 \cdot \frac{\text{J}}{\text{mol}} \quad C_P := \frac{7}{2} \cdot R$$

$$C_V := C_P - R \quad Q = \Delta U - \text{Work} \quad Q := C_V \cdot (T_2 - T_1) - \text{Work}$$

$$\Delta S_{\text{res}} := \frac{-Q}{T_{\text{res}}} \quad \Delta S_{\text{res}} = 5.718 \frac{\text{J}}{\text{mol} \cdot \text{K}} \quad Q = -1.733 \times 10^3 \frac{\text{J}}{\text{mol}}$$

$$\Delta S := C_P \cdot \ln\left(\frac{T_2}{T_1}\right) - R \cdot \ln\left(\frac{P_2}{P_1}\right) \quad \Delta S = -2.301 \frac{\text{J}}{\text{mol} \cdot \text{K}}$$

$$\Delta S_{\text{total}} := \Delta S + \Delta S_{\text{res}} \quad \Delta S_{\text{total}} = 3.42 \frac{\text{J}}{\text{mol} \cdot \text{K}} \quad \text{PROCESS IS POSSIBLE.}$$

**5.33 For the process of cooling the brine:**

$$C_p := 3.5 \cdot \frac{\text{kJ}}{\text{kg} \cdot \text{K}}$$

$$\Delta T := -40 \cdot \text{K}$$

$$\dot{m} := 20 \cdot \frac{\text{kg}}{\text{sec}}$$

$$\eta_t := 0.27$$

$$T_1 := (273.15 + 25) \cdot \text{K}$$

$$T_1 = 298.15 \text{ K}$$

$$T_2 := (273.15 - 15) \cdot \text{K}$$

$$T_2 = 258.15 \text{ K}$$

$$T_\sigma := (273.15 + 30) \cdot \text{K}$$

$$T_\sigma = 303.15 \text{ K}$$

$$\Delta H := C_p \cdot \Delta T$$

$$\Delta H = -140 \frac{\text{kJ}}{\text{kg}}$$

$$\Delta S := C_p \cdot \ln\left(\frac{T_2}{T_1}\right)$$

$$\Delta S = -0.504 \frac{\text{kJ}}{\text{kg} \cdot \text{K}}$$

**Eq. (5.26):**  $\dot{W}_{\text{ideal}} := \dot{m} \cdot (\Delta H - T_\sigma \cdot \Delta S)$   $\dot{W}_{\text{ideal}} = 256.938 \text{ kW}$

**By Eq. (5.28):**  $\dot{W} := \frac{\dot{W}_{\text{ideal}}}{\eta_t}$   $\dot{W} = 951.6 \text{ kW}$  **Ans.**

**5.34**  $E := 110 \cdot \text{volt}$

$$i := 9.7 \cdot \text{amp}$$

$$T_\sigma := 300 \cdot \text{K}$$

$$\dot{W}_{\text{mech}} := -1.25 \cdot \text{hp}$$

$$\dot{W}_{\text{elect}} := i \cdot E$$

$$\dot{W}_{\text{elect}} = 1.067 \times 10^3 \text{ W}$$

**At steady state:**  $\dot{Q} + \dot{W}_{\text{elect}} + \dot{W}_{\text{mech}} = \frac{d}{dt} U^t = 0$

$$\frac{\dot{Q}}{T_\sigma} + \dot{S}_{\text{G}} = \frac{d}{dt} S^t = 0$$

$$\dot{Q} := -\dot{W}_{\text{elect}} - \dot{W}_{\text{mech}}$$

$$\dot{Q} = -134.875 \text{ W}$$

$$\dot{S}_{\text{G}} := \frac{-\dot{Q}}{T_\sigma}$$

$$\dot{S}_{\text{G}} = 0.45 \frac{\text{W}}{\text{K}}$$

**Ans.**

5.35  $\Omega := 25 \cdot \text{ohm}$   $i := 10 \cdot \text{amp}$   $T_\sigma := 300 \cdot \text{K}$

$\dot{W}_{\text{elect}} := i^2 \cdot \Omega$   $\dot{W}_{\text{elect}} = 2.5 \times 10^3 \text{ W}$

At steady state:  $\dot{Q} + \dot{W}_{\text{elect}} = \frac{d}{dt} U^t = 0$   $\dot{Q} := -\dot{W}_{\text{elect}}$

$\frac{\dot{Q}}{T_\sigma} + \dot{S}_{\text{G}} = \frac{d}{dt} S^t = 0$   $\dot{S}_{\text{G}} := \frac{-\dot{Q}}{T_\sigma}$

$\dot{Q} = -2.5 \times 10^3 \text{ watt}$   $\dot{S}_{\text{G}} = 8.333 \frac{\text{watt}}{\text{K}}$  **Ans.**

5.38  $\dot{m} := 10 \frac{\text{kmol}}{\text{hr}}$   $T_1 := (25 + 273.15) \text{K}$   $P_1 := 10 \text{bar}$   $P_2 := 1.2 \text{bar}$

$C_p := \frac{7}{2} R$   $C_v := C_p - R$   $\gamma := \frac{C_p}{C_v}$   $\gamma = \frac{7}{5}$

(a) Assuming an isenthalpic process:  $T_2 := T_1$   $T_2 = 298.15 \text{ K}$  **Ans.**

(b)  $\frac{\Delta S}{R} = \int_{T_1}^{T_2} \frac{C_p}{R} \frac{1}{T} dT - \ln \left( \frac{P_2}{P_1} \right)$  **Eq. (5.14)**

$\Delta S := \frac{7}{2} R \cdot \ln \left( \frac{T_2}{T_1} \right) - R \cdot \ln \left( \frac{P_2}{P_1} \right)$   $\Delta S = 17.628 \frac{\text{J}}{\text{mol} \cdot \text{K}}$  **Ans.**

(c)  $\dot{S}_{\text{G}} := \dot{m} \cdot \Delta S$   $\dot{S}_{\text{G}} = 48.966 \frac{\text{W}}{\text{K}}$  **Ans.**

(d)  $T_\sigma := (20 + 273.15) \text{K}$   $W_{\text{lost}} := T_\sigma \cdot \Delta S$   $W_{\text{lost}} = 5.168 \times 10^3 \frac{\text{J}}{\text{mol}}$  **Ans.**

5.39 (a)  $T_1 := 500 \text{K}$   $P_1 := 6 \text{bar}$   $T_2 := 371 \text{K}$   $P_2 := 1.2 \text{bar}$   $C_p := \frac{7}{2} R$

$T_\sigma := 300 \text{K}$  **Basis: 1 mol**  $n := 1 \text{mol}$

$\Delta H := n \cdot C_p \cdot (T_2 - T_1)$   $W_s := \Delta H$   $W_s = -3753.8 \text{ J}$  **Ans.**

$$\Delta S := n \cdot \left( C_p \cdot \ln\left(\frac{T_2}{T_1}\right) - R \cdot \ln\left(\frac{P_2}{P_1}\right) \right) \quad \Delta S = 4.698 \frac{\text{J}}{\text{K}}$$

**Eq. (5.27)**  $W_{\text{ideal}} := (\Delta H - T_{\sigma} \cdot \Delta S) \quad W_{\text{ideal}} = -5163 \text{ J} \quad \text{Ans.}$

**Eq. (5.30)**  $W_{\text{lost}} := |W_{\text{ideal}} - W_s| \quad W_{\text{lost}} = 1409.3 \text{ J} \quad \text{Ans.}$

**Eq. (5.39)**  $S_G := \frac{W_{\text{lost}}}{T_{\sigma}} \quad S_G = 4.698 \frac{\text{J}}{\text{K}} \quad \text{Ans.}$

	$W_s$	$W_{\text{ideal}}$	$W_{\text{lost}}$	$S_G$
(a)	-3753.8J	-5163J	1409.3J	$4.698 \frac{\text{J}}{\text{K}}$
(b)	-2460.9J	-2953.9J	493J	$1.643 \frac{\text{J}}{\text{K}}$
(c)	-3063.7J	-4193.7J	1130J	$3.767 \frac{\text{J}}{\text{K}}$
(d)	-3853.5J	-4952.4J	1098.8J	$3.663 \frac{\text{J}}{\text{K}}$
(e)	-3055.4J	-4119.2J	1063.8J	$3.546 \frac{\text{J}}{\text{K}}$

**5.41**  $P_1 := 2500 \text{ kPa} \quad P_2 := 150 \text{ kPa} \quad T_{\sigma} := 300 \text{ K} \quad \dot{m} := 20 \frac{\text{mol}}{\text{sec}}$

$$\Delta S := -R \cdot \ln\left(\frac{P_2}{P_1}\right) \quad \Delta S = 0.023 \frac{\text{kJ}}{\text{mol} \cdot \text{K}}$$

$$S_{\text{dot}G} := \dot{m} \cdot \Delta S \quad S_{\text{dot}G} = 0.468 \frac{\text{kJ}}{\text{sec} \cdot \text{K}} \quad \text{Ans.}$$

$$W_{\text{dot}lost} := T_{\sigma} \cdot S_{\text{dot}G} \quad W_{\text{dot}lost} = 140.344 \text{ kW} \quad \text{Ans.}$$

**5.42**  $Q_H := 1 \text{ kJ} \quad W := 0.45 \text{ kJ} \quad T_H := (250 + 273.15) \text{ K} \quad T_H = 523.15 \text{ K}$   
 $T_C := (25 + 273.15) \text{ K} \quad T_C = 298.15 \text{ K}$

$$\eta_{\text{actual}} := \frac{|W|}{|Q_H|} \quad \eta_{\text{actual}} = 0.45$$



$$\eta_{\max} := 1 - \frac{T_C}{T_H} \quad \eta_{\max} = 0.43$$

Since  $\eta_{\text{actual}} > \eta_{\max}$ , the process is impossible.

5.43  $Q_H := -150 \cdot \text{kJ}$      $Q_1 := 50 \cdot \text{kJ}$      $Q_2 := 100 \cdot \text{kJ}$   
 $T_H := 550 \cdot \text{K}$      $T_1 := 350 \cdot \text{K}$      $T_2 := 250 \cdot \text{K}$      $T_\sigma := 300 \cdot \text{K}$

(a)  $S_G := \frac{Q_H}{T_H} + \frac{Q_1}{T_1} + \frac{Q_2}{T_2}$      $S_G = 0.27 \frac{\text{kJ}}{\text{K}}$     **Ans.**

(b)  $W_{\text{lost}} := T_\sigma \cdot S_G$      $W_{\text{lost}} = 81.039 \text{ kJ}$     **Ans.**

5.44  $\dot{W} := -750 \cdot \text{MW}$      $T_H := (315 + 273.15) \cdot \text{K}$      $T_C := (20 + 273.15) \cdot \text{K}$   
 $T_H = 588.15 \text{ K}$      $T_C = 293.15 \text{ K}$

(a)  $\eta_{\max} := 1 - \frac{T_C}{T_H}$      $\eta_{\max} = 0.502$     **Ans.**

$\dot{Q}_{\text{dot}H} := \frac{|\dot{W}|}{\eta_{\max}}$      $\dot{Q}_{\text{dot}C} := \dot{Q}_{\text{dot}H} - |\dot{W}|$

$\dot{Q}_{\text{dot}C} = 745.297 \text{ MW}$     **(minimum value)**

(b)  $\eta := 0.6 \cdot \eta_{\max}$      $\dot{Q}_{\text{dot}H} := \frac{|\dot{W}|}{\eta}$      $\dot{Q}_{\text{dot}H} = 2.492 \times 10^9 \text{ W}$

$\dot{Q}_{\text{dot}C} := \dot{Q}_{\text{dot}H} - |\dot{W}|$      $\dot{Q}_{\text{dot}C} = 1.742 \times 10^3 \text{ MW}$     **(actual value)**

**River temperature rise:**  $\dot{V} := 165 \cdot \frac{\text{m}^3}{\text{s}}$      $\rho := 1 \cdot \frac{\text{gm}}{\text{cm}^3}$

$C_p := 1 \cdot \frac{\text{cal}}{\text{gm} \cdot \text{K}}$      $\Delta T := \frac{\dot{Q}_{\text{dot}C}}{\dot{V} \cdot \rho \cdot C_p}$      $\Delta T = 2.522 \text{ K}$     **Ans.**

$$5.46 \quad T_1 := (20 + 273.15)\text{K} \quad T_2 := (27 + 273.15)\cdot\text{K} \quad T_3 := (-22 + 273.15)\text{K}$$

$$P_1 := 5\text{bar} \quad P_2 := 1\text{atm}$$

First check the First Law using Eqn. (2.33) neglect changes in kinetic and potential energy.

$$\Delta H := \frac{6}{7} \cdot R \cdot \text{ICPH}(T_1, T_2, 3.355, 0.575 \cdot 10^{-3}, 0, -0.016 \cdot 10^5) \dots$$

$$+ \frac{1}{7} \cdot \text{ICPH}(T_1, T_3, 3.355, 0.575 \cdot 10^{-3}, 0, -0.016 \cdot 10^5) \cdot R$$

$$\Delta H = 8.797 \times 10^{-4} \frac{\text{kJ}}{\text{mol}} \quad \Delta H \text{ is essentially zero so the first law is satisfied.}$$

Calculate the rate of entropy generation using Eqn. (5.23)

$$S_G := \frac{6}{7} \cdot R \cdot \text{ICPS}(T_1, T_2, 3.355, 0.575 \cdot 10^{-3}, 0, -0.016 \cdot 10^5) \dots$$

$$+ \frac{1}{7} \cdot R \cdot \text{ICPS}(T_1, T_3, 3.355, 0.575 \cdot 10^{-3}, 0, -0.016 \cdot 10^5) - R \cdot \ln\left(\frac{P_2}{P_1}\right)$$

$$S_G = 0.013 \frac{\text{kJ}}{\text{mol} \cdot \text{K}} \quad \text{Since } S_G \geq 0, \text{ this process is possible.}$$

$$5.47 \quad \text{a) } \dot{V} := 100000 \frac{\text{ft}^3}{\text{hr}} \quad T_1 := (70 + 459.67)\text{rankine} \quad T_2 := (20 + 459.67)\text{rankine}$$

$$P := 1\text{atm} \quad T_\sigma := (70 + 459.67)\text{rankine}$$

Assume air is an Ideal Gas

$$\dot{n} := \frac{P \cdot \dot{V}}{R \cdot T_1} \quad \dot{n} = 258.555 \frac{\text{lbmol}}{\text{hr}}$$

Calculate ideal work using Eqn. (5.26)

$$W_{\text{ideal}} := \dot{n} \cdot \left[ R \cdot \text{ICPH}(T_1, T_2, 3.355, 0.575 \cdot 10^{-3}, 0, -0.016 \cdot 10^5) \dots \right. \\ \left. + -T_\sigma \cdot \left( R \cdot \text{ICPS}(T_1, T_2, 3.355, 0.575 \cdot 10^{-3}, 0, -0.016 \cdot 10^5) \right) \right]$$

$$W_{\text{ideal}} = 1.776 \text{hp}$$

$$\text{b) } \dot{V} := 3000 \frac{\text{m}^3}{\text{hr}} \quad T_1 := (25 + 273.15)\text{K} \quad T_2 := (-8 + 273.15)\text{K}$$

$$P := 1\text{atm} \quad T_\sigma := (25 + 273.15)\text{K}$$

Assume air is an Ideal Gas

$$\dot{n} := \frac{P \cdot \dot{V}}{R \cdot T_1} \quad \dot{n} = 34.064 \frac{\text{mol}}{\text{s}}$$

Calculate ideal work using Eqn. (5.26)

$$W_{\text{ideal}} := \dot{n} \cdot \left[ R \cdot \text{ICPH}(T_1, T_2, 3.355, 0.575 \cdot 10^{-3}, 0, -0.016 \cdot 10^5) \dots \right. \\ \left. + -T_\sigma \cdot (R \cdot \text{ICPS}(T_1, T_2, 3.355, 0.575 \cdot 10^{-3}, 0, -0.016 \cdot 10^5)) \right]$$

$$W_{\text{ideal}} = 1.952 \text{ kW}$$

$$5.48 \quad T_1 := (2000 + 459.67)\text{rankine}$$

$$T_2 := (300 + 459.67)\text{rankine}$$

$$C_p(T) := \left( 3.83 + 0.000306 \cdot \frac{T}{\text{rankine}} \right) \cdot R$$

$$\Delta H_v := 970 \frac{\text{BTU}}{\text{lb}_m}$$

$$M := 29 \frac{\text{gm}}{\text{mol}}$$

$$T_\sigma := (70 + 459.67)\text{rankine}$$

$$T_{\text{steam}} := (212 + 459.67)\text{rankine}$$

a) First apply an energy balance on the boiler to get the ratio of steam flow rate to gas flow rate.:

$$\dot{n}_{\text{gas}} \cdot \int_{T_1}^{T_2} C_p(T) dT + \dot{m}_{\text{steam}} \cdot \Delta H_v = 0$$

$$\dot{m}_{\text{steam}} := \frac{- \int_{T_1}^{T_2} C_p(T) dT}{\Delta H_v}$$

$$\dot{m}_{\text{steam}} = 15.043 \frac{\text{lb}}{\text{lbmol}}$$

Calculate the rate of entropy generation in the boiler. This is the sum of the entropy generation of the steam and the gas.

$$S_{\text{dotG}} = S_{\text{dotGsteam}} + S_{\text{dotGgas}}$$

**Calculate entropy generation per lbmol of gas:**

$$\frac{S_{\text{dotG}}}{n_{\text{dotgas}}} = \frac{m_{\text{dotsteam}}}{n_{\text{dotgas}}} \cdot \Delta S_{\text{steam}} + S_{\text{gas}}$$

$$\Delta S_{\text{steam}} := \frac{\Delta H_v}{T_{\text{steam}}}$$

$$\Delta S_{\text{steam}} = 1.444 \frac{\text{BTU}}{\text{lb} \cdot \text{rankine}}$$

$$\Delta S_{\text{gas}} := \int_{T_1}^{T_2} \frac{C_p(T)}{T} dT$$

$$\Delta S_{\text{gas}} = -9.969 \times 10^{-3} \frac{\text{kg}}{\text{mol}} \frac{\text{BTU}}{\text{lb} \cdot \text{rankine}}$$

$$S_{\text{dotG}} := m_{\text{dotn}} \cdot \Delta S_{\text{steam}} + S_{\text{gas}}$$

$$S_{\text{dotG}} = 11.756 \frac{\text{BTU}}{\text{lbmol} \cdot \text{rankine}}$$

**Calculate lost work by Eq. (5.34)**

$$W_{\text{lost}} := S_{\text{dotG}} \cdot T_{\sigma}$$

$$W_{\text{lost}} = 6227 \frac{\text{BTU}}{\text{lbmol}} \quad \text{Ans.}$$

b)  $\Delta H_{\text{steam}} := -\Delta H_v \quad \Delta S_{\text{steam}} := \frac{-\Delta H_v}{T_{\text{steam}}}$

$$\Delta S_{\text{steam}} = -1.444 \frac{\text{BTU}}{\text{lb} \cdot \text{rankine}}$$

$$W_{\text{ideal}} := (\Delta H_{\text{steam}} - T_{\sigma} \cdot \Delta S_{\text{steam}})$$

$$W_{\text{ideal}} = -205.071 \frac{\text{BTU}}{\text{lb}}$$

**Calculate lbs of steam generated per lbmol of gas cooled.**

$$mn := \frac{\int_{T_1}^{T_2} C_p(T) dT}{-\Delta H_v}$$

$$mn = 15.043 \frac{\text{lb}}{\text{lbmol}}$$

**Use ratio to calculate ideal work of steam per lbmol of gas**

$$W_{\text{ideal}} \cdot mn = -3.085 \times 10^3 \frac{\text{BTU}}{\text{lbmol}} \quad \text{Ans.}$$

c)  $\Delta H_{\text{gas}} := \int_{T_1}^{T_2} C_p(T) dT$

$$W_{\text{ideal}} := \Delta H_{\text{gas}} - T_{\sigma} \cdot \Delta S_{\text{gas}}$$

$$W_{\text{ideal}} = -9.312 \times 10^3 \frac{\text{BTU}}{\text{lbmol}} \quad \text{Ans.}$$

$$5.49 \quad T_1 := (1100 + 273.15)\text{K}$$

$$T_2 := (150 + 273.15)\text{K}$$

$$C_p(T) := \left( 3.83 + 0.000551 \cdot \frac{T}{\text{K}} \right) \cdot R$$

$$\Delta H_v := 2256.9 \frac{\text{kJ}}{\text{kg}}$$

$$M := 29 \frac{\text{gm}}{\text{mol}}$$

$$T_\sigma := (25 + 273.15)\text{K}$$

$$T_{\text{steam}} := (100 + 273.15)\text{K}$$

a) First apply an energy balance on the boiler to get the ratio of steam flow rate to gas flow rate.:

$$\dot{m}_{\text{gas}} \cdot \int_{T_1}^{T_2} C_p(T) dT + \dot{m}_{\text{steam}} \cdot \Delta H_v = 0$$

$$\dot{m}_{\text{steam}} := \frac{- \int_{T_1}^{T_2} C_p(T) dT}{\Delta H_v}$$

$$\dot{m}_{\text{steam}} = 15.135 \frac{\text{gm}}{\text{mol}}$$

Calculate the rate of entropy generation in the boiler. This is the sum of the entropy generation of the steam and the gas.

$$\dot{S}_{\text{G}} = \dot{S}_{\text{Gsteam}} + \dot{S}_{\text{Ggas}}$$

Calculate entropy generation per lbmol of gas:

$$\frac{\dot{S}_{\text{G}}}{\dot{m}_{\text{gas}}} = \frac{\dot{m}_{\text{steam}}}{\dot{m}_{\text{gas}}} \cdot \Delta S_{\text{steam}} + S_{\text{gas}}$$

$$\Delta S_{\text{steam}} := \frac{\Delta H_v}{T_{\text{steam}}}$$

$$\Delta S_{\text{steam}} = 6.048 \times 10^3 \frac{\text{J}}{\text{kg} \cdot \text{K}}$$

$$\Delta S_{\text{gas}} := \int_{T_1}^{T_2} \frac{C_p(T)}{T} dT$$

$$\Delta S_{\text{gas}} = -41.835 \frac{\text{J}}{\text{mol} \cdot \text{K}}$$

$$\dot{S}_{\text{G}} := \dot{m}_{\text{steam}} \cdot \Delta S_{\text{steam}} + \dot{m}_{\text{gas}} \cdot \Delta S_{\text{gas}}$$

$$\dot{S}_{\text{G}} = 49.708 \frac{\text{J}}{\text{mol} \cdot \text{K}}$$

Calculate lost work by Eq. (5.34)

$$W_{\text{lost}} := \dot{S}_{\text{G}} \cdot T_\sigma$$

$$W_{\text{lost}} = 14.8 \frac{\text{kJ}}{\text{mol}} \quad \text{Ans.}$$

$$\text{b) } \Delta H_{\text{steam}} := -\Delta H_v \quad \Delta S_{\text{steam}} := \frac{-\Delta H_v}{T_{\text{steam}}} \quad \Delta S_{\text{steam}} = -6.048 \times 10^3 \frac{\text{J}}{\text{kg} \cdot \text{K}}$$

$$W_{\text{ideal}} := \left( \Delta H_{\text{steam}} - T_{\sigma} \cdot \Delta S_{\text{steam}} \right) \quad W_{\text{ideal}} = -453.618 \frac{\text{kJ}}{\text{kg}}$$

Calculate lbs of steam generated per lbmol of gas cooled.

$$mn := \frac{\int_{T_1}^{T_2} C_p(T) dT}{-\Delta H_v} \quad mn = 15.135 \frac{\text{gm}}{\text{mol}}$$

Use ratio to calculate ideal work of steam per lbmol of gas

$$W_{\text{ideal}} \cdot mn = -6.866 \frac{\text{kJ}}{\text{mol}} \quad \text{Ans.}$$

$$\text{c) } \Delta H_{\text{gas}} := \int_{T_1}^{T_2} C_p(T) dT$$

$$W_{\text{ideal}} := \Delta H_{\text{gas}} - T_{\sigma} \cdot \Delta S_{\text{gas}} \quad W_{\text{ideal}} = -21.686 \frac{\text{kJ}}{\text{mol}} \quad \text{Ans.}$$

$$\text{5.50 } T_1 := (830 + 273.15)\text{K} \quad T_2 := (35 + 273.15)\text{K} \quad T_{\sigma} := (25 + 273.15)\text{K}$$

$$\text{a) } \Delta S_{\text{ethylene}} := R \cdot \text{ICPS} \left( T_1, T_2, 1.424, 14.394 \cdot 10^{-3}, -4.392 \cdot 10^{-6}, 0 \right)$$

$$\Delta S_{\text{ethylene}} = -0.09 \frac{\text{kJ}}{\text{mol} \cdot \text{K}}$$

$$Q_{\text{ethylene}} := R \cdot \text{ICPH} \left( T_1, T_2, 1.424, 14.394 \cdot 10^{-3}, -4.392 \cdot 10^{-6}, 0 \right)$$

$$Q_{\text{ethylene}} = -60.563 \frac{\text{kJ}}{\text{mol}}$$

$$W_{\text{lost}} := T_{\sigma} \cdot \Delta S_{\text{ethylene}} - Q_{\text{ethylene}} \quad W_{\text{lost}} = 33.803 \frac{\text{kJ}}{\text{mol}}$$

Now place a heat engine between the ethylene and the surroundings. This would constitute a reversible process, therefore, the total entropy generated must be zero. calculate the heat released to the surroundings for  $\Delta S_{\text{total}} = 0$ .

$$\Delta S_{\text{ethylene}} - \frac{Q_C}{T_\sigma} = 0$$

Solving for  $Q_C$  gives:  $Q_C := T_\sigma \cdot \Delta S_{\text{ethylene}}$

$$Q_C = -26.76 \frac{\text{kJ}}{\text{mol}}$$

**Now apply an energy balance around the heat engine to find the work produced. Note that the heat gained by the heat engine is the heat lost by the ethylene.**

$$Q_H := -Q_{\text{ethylene}}$$

$$W_{\text{HE}} := Q_H + Q_C$$

$$W_{\text{HE}} = 33.803 \frac{\text{kJ}}{\text{mol}}$$

**The lost work is exactly equal to the work that could be produced by the heat engine**

## Chapter 6 - Section A - Mathcad Solutions

6.7 At constant temperature Eqs. (6.25) and (6.26) can be written:

$$dS = -\beta \cdot V \cdot dP \quad \text{and} \quad dH = (1 - \beta \cdot T) \cdot V \cdot dP$$

For an estimate, assume properties independent of pressure.

$$T := 270 \cdot \text{K} \quad P_1 := 381 \cdot \text{kPa} \quad P_2 := 1200 \cdot \text{kPa}$$

$$V := 1.551 \cdot 10^{-3} \cdot \frac{\text{m}^3}{\text{kg}} \quad \beta := 2.095 \cdot 10^{-3} \cdot \text{K}^{-1}$$

$$\Delta S := -\beta \cdot V \cdot (P_2 - P_1) \quad \Delta H := (1 - \beta \cdot T) \cdot V \cdot (P_2 - P_1)$$

$$\Delta S = -2.661 \frac{\text{J}}{\text{kg} \cdot \text{K}} \quad \text{Ans.}$$

$$\Delta H = 551.7 \frac{\text{J}}{\text{kg}} \quad \text{Ans.}$$

6.8 Isobutane:

$$T_c := 408.1 \cdot \text{K} \quad Z_c := 0.282$$

$$C_p := 2.78 \cdot \frac{\text{J}}{\text{gm} \cdot \text{K}}$$

$$P_1 := 4000 \cdot \text{kPa}$$

$$P_2 := 2000 \cdot \text{kPa}$$

$$\text{molwt} := 58.123 \cdot \frac{\text{gm}}{\text{mol}}$$

$$V_c := 262.7 \cdot \frac{\text{cm}^3}{\text{mol}}$$

Eq. (3.63) for volume of a saturated liquid may be used for the volume of a compressed liquid if the effect of pressure on liquid volume is neglected.

$$T := \begin{pmatrix} 359 \\ 360 \\ 361 \end{pmatrix} \cdot \text{K}$$

$$T_r := \frac{T}{T_c}$$

$$T_r = \begin{pmatrix} 0.88 \\ 0.882 \\ 0.885 \end{pmatrix}$$

(The elements are denoted by subscripts 1, 2, & 3

$$V := \left[ V_c \cdot Z_c \left( 1 - T_r \right)^{\frac{2}{7}} \right]$$

$$V = \begin{pmatrix} 131.604 \\ 132.138 \\ 132.683 \end{pmatrix} \frac{\text{cm}^3}{\text{mol}}$$

Assume that changes in T and V are negligible during throttling. Then Eq. (6.8) is integrated to yield:



$$\Delta H = T \cdot \Delta S + V \cdot \Delta P \quad \text{but} \quad \Delta H = 0 \quad \text{Then at 360 K,}$$

$$\Delta S := \frac{-V_1 \cdot (P_2 - P_1)}{T_1} \quad \Delta S = 0.733 \frac{\text{J}}{\text{mol} \cdot \text{K}} \quad \text{Ans.}$$

We use the additional values of T and V to estimate the volume expansivity:

$$\Delta V := V_3 - V_1 \quad \Delta V = 1.079 \frac{\text{cm}^3}{\text{mol}} \quad \Delta T := T_3 - T_1 \quad \Delta T = 2 \text{ K}$$

$$\beta := \frac{1}{V_1} \cdot \frac{\Delta V}{\Delta T} \quad \beta = 4.098835 \times 10^{-3} \text{ K}^{-1}$$

Assuming properties independent of pressure, Eq. (6.29) may be integrated to give

$$\Delta S = C_p \cdot \beta \frac{\Delta T}{T} - \beta \cdot \Delta P \quad \Delta P := P_2 - P_1 \quad \Delta P = -2 \times 10^3 \text{ kPa}$$

$$\text{Whence } \Delta T := \frac{T_1}{C_p} \cdot \frac{(\Delta S + \beta \cdot \Delta P)}{\text{molwt}} \quad \Delta T = -0.768 \text{ K} \quad \text{Ans.}$$

6.9  $T := 298.15 \cdot \text{K}$   $P_1 := 1 \cdot \text{bar}$   $P_2 := 1500 \cdot \text{bar}$

$$\beta := 250 \cdot 10^{-6} \cdot \text{K}^{-1} \quad \kappa := 45 \cdot 10^{-6} \cdot \text{bar}^{-1} \quad V_1 := 1003 \cdot \frac{\text{cm}^3}{\text{kg}}$$

$$\text{By Eq. (3.5),} \quad V_2 := V_1 \cdot \exp[-\kappa \cdot (P_2 - P_1)] \quad V_2 = 937.574 \frac{\text{cm}^3}{\text{kg}}$$

$$V_{\text{ave}} := \frac{V_1 + V_2}{2} \quad V_{\text{ave}} = 970.287 \frac{\text{cm}^3}{\text{kg}} \quad \text{By Eqs. (6.28) \& (6.29),}$$

$$\Delta H := V_{\text{ave}} \cdot (P_2 - P_1) - \beta \cdot T \cdot (P_2 - P_1) \quad \Delta U := \Delta H - (P_2 \cdot V_2 - P_1 \cdot V_1)$$

$$\Delta H = 134.6 \frac{\text{kJ}}{\text{kg}} \quad \text{Ans.} \quad \Delta U = -5.93 \frac{\text{kJ}}{\text{kg}} \quad \text{Ans.}$$

$$\Delta S := -\beta \cdot V_{\text{ave}} \cdot (P_2 - P_1) \quad Q := T \cdot \Delta S \quad \text{Work} := \Delta U - Q$$

$$\Delta S = -0.03636 \frac{\text{kJ}}{\text{kg} \cdot \text{K}} \quad \text{Ans.} \quad Q = -10.84 \frac{\text{kJ}}{\text{kg}} \quad \text{Ans.} \quad \text{Work} = 4.91 \frac{\text{kJ}}{\text{kg}} \quad \text{Ans.}$$

6.10 For a constant-volume change, by Eq. (3.5),

$$\beta \cdot (T_2 - T_1) - \kappa \cdot (P_2 - P_1) = 0 \quad T_1 := 298.15 \cdot \text{K} \quad T_2 := 323.15 \cdot \text{K}$$

$$\beta := 36.2 \cdot 10^{-5} \cdot \text{K}^{-1} \quad \kappa := 4.42 \cdot 10^{-5} \cdot \text{bar}^{-1} \quad P_1 := 1 \cdot \text{bar}$$

$$P_2 := \frac{\beta \cdot (T_2 - T_1)}{\kappa} + P_1 \quad P_2 = 205.75 \text{ bar} \quad \text{Ans.}$$

6.14 --- 6.16 Vectors containing T, P, Tc, Pc, and  $\omega$  for Parts (a) through (n):

T :=	(300)	P :=	(40)	Tc :=	(308.3)	Pc :=	(61.39)	$\omega$ :=	(.187)
	175		75		150.9		48.98		.000
	575		30		562.2		48.98		.210
	500		50		425.1		37.96		.200
	325		60		304.2		73.83		.224
	175		60		132.9		34.99		.048
	575		35		556.4		45.60		.193
	650		50		553.6		40.73		.210
	300		35		282.3		50.40		.087
	400		70		373.5		89.63		.094
	150		50		126.2		34.00		.038
	575		15		568.7		24.90		.400
	375		25		369.8		42.48		.152
	(475)		(75)		(365.6)		(46.65)		(.140)

$$\text{Tr} := \frac{\vec{T}}{T_c}$$

$$\text{Pr} := \frac{\vec{P}}{P_c}$$

6.14 Redlich/Kwong equation:  $\Omega := 0.08664$   $\Psi := 0.42748$

$$\beta\Omega = \left( \frac{Pr}{Tr} \right) \quad \text{Eq. (3.53)} \quad q := \left( \frac{\Psi}{\Omega \cdot Tr^{1.5}} \right) \quad \text{Eq. (3.54)}$$

Guess:  $z := 1$

$$\text{Given } z = 1 + \beta - q \cdot \beta \cdot \frac{z - \beta}{z \cdot (z + \beta)} \quad \text{Eq. (3.52)}$$

$$Z(\beta, q) := \text{Find}(z)$$

$$i := 1..14 \quad I_i := \ln \left( \frac{Z(\beta_i, q_i + \beta_i)}{Z(\beta_i, q_i)} \right) \quad \text{Eq. (6.65b)}$$

$$HR_i := R \cdot T_i \cdot [Z(\beta_i, q_i) - 1 - 1.5 \cdot q_i \cdot I_i] \quad \text{Eq. (6.67) The derivative in these}$$

$$SR_i := R \cdot \ln(Z(\beta_i, q_i) - \beta_i - 0.5 \cdot q_i \cdot I_i) \quad \text{Eq. (6.68) equations equals -0.5}$$

$Z(\beta_i, q_i) =$	$HR_i =$	$SR_i =$
0.695	$-2.302 \cdot 10^3$	-5.461
0.605	$-2.068 \cdot 10^3$	-8.767
0.772	$-3.319 \cdot 10^3$	-4.026
0.685	$-4.503 \cdot 10^3$	-6.542
0.729	$-2.3 \cdot 10^3$	-5.024
0.75	$-1.362 \cdot 10^3$	-5.648
0.709	$-4.316 \cdot 10^3$	-5.346
0.706	$-5.381 \cdot 10^3$	-5.978
0.771	$-1.764 \cdot 10^3$	-4.12
0.744	$-2.659 \cdot 10^3$	-4.698
0.663	$-1.488 \cdot 10^3$	-7.257
0.766	$-3.39 \cdot 10^3$	-4.115
0.775	$-2.122 \cdot 10^3$	-3.939
0.75	$-3.623 \cdot 10^3$	-5.523

Ans.

**6.15 Soave/Redlich/Kwong equation:**

$$\Omega := 0.08664 \quad \Psi := 0.42748 \quad c := \overline{(0.480 + 1.574 \cdot \omega - 0.176 \cdot \omega^2)}$$

$$\alpha := \overline{\left[ 1 + c \cdot \left( 1 - \text{Tr}^{0.5} \right) \right]^2} \quad \beta \Omega = \overline{\left( \frac{\text{Pr}}{\text{Tr}} \right)} \quad \text{Eq. (3.53)} \quad q := \overline{\left( \frac{\Psi \alpha}{\Omega \cdot \text{Tr}} \right)} \quad \text{Eq. (3.54)}$$

**Guess:**  $z := 1$

Given  $z = 1 + \beta - q \cdot \beta \cdot \frac{z - \beta}{z \cdot (z + \beta)}$  **Eq. (3.52)**  $Z(\beta, q) := \text{Find}(z)$

**The derivative in the following equations equals:**  $-c_i \cdot \left( \frac{\text{Tr}_i}{\alpha_i} \right)^{0.5}$

$$i := 1..14 \quad I_i := \ln \left( \frac{Z(\beta_i, q_i) + \beta_i}{Z(\beta_i, q_i)} \right) \quad \text{Eq. (6.65b)}$$

$$\text{HR}_i := R \cdot \text{Tr}_i \cdot \left[ Z(\beta_i, q_i) - 1 - \left[ c_i \cdot \left( \frac{\text{Tr}_i}{\alpha_i} \right)^{0.5} + 1 \right] \cdot q_i \cdot I_i \right] \quad \text{Eq. (6.67)}$$

$$\text{SR}_i := R \cdot \left[ \ln \left( Z(\beta_i, q_i) - \beta_i - c_i \cdot \left( \frac{\text{Tr}_i}{\alpha_i} \right)^{0.5} \right) \cdot q_i \cdot I_i \right] \quad \text{Eq. (6.68)}$$

$Z(\beta_i, q_i) =$

0.691
0.606
0.774
0.722
0.741
0.768
0.715
0.741
0.774
0.749
0.673
0.769
0.776
0.787

$\text{HR}_i =$

	$\frac{\text{J}}{\text{mol}}$
-2.595·10 <sup>3</sup>	
-2.099·10 <sup>3</sup>	
-3.751·10 <sup>3</sup>	
-4.821·10 <sup>3</sup>	
-2.585·10 <sup>3</sup>	
-1.406·10 <sup>3</sup>	
-4.816·10 <sup>3</sup>	
-5.806·10 <sup>3</sup>	
-1.857·10 <sup>3</sup>	
-2.807·10 <sup>3</sup>	
-1.527·10 <sup>3</sup>	
-4.244·10 <sup>3</sup>	
-2.323·10 <sup>3</sup>	
-3.776·10 <sup>3</sup>	

$\text{SR}_i =$

	$\frac{\text{J}}{\text{mol} \cdot \text{K}}$
-6.412	
-8.947	
-4.795	
-7.408	
-5.974	
-6.02	
-6.246	
-6.849	
-4.451	
-5.098	
-7.581	
-5.618	
-4.482	
-6.103	

**Ans.**

**6.16 Peng/Robinson equation:**  $\sigma := 1 + \sqrt{2}$        $\varepsilon := 1 - \sqrt{2}$

$$\Omega := 0.07779 \quad \Psi := 0.45724 \quad c := \left( 0.37464 + 1.54226 \cdot \omega - 0.26992 \cdot \omega^2 \right)$$

$$\alpha := \left[ 1 + c \cdot \left( 1 - \text{Tr}^{0.5} \right) \right]^2 \quad \beta \Omega = \left( \frac{\text{Pr}}{\text{Tr}} \right) \quad \text{Eq. (3.53)} \quad q := \left( \frac{\Psi \alpha}{\Omega \cdot \text{Tr}} \right) \quad \text{Eq. (3.54)}$$

**Guess:**       $z := 1$

Given  $z = 1 + \beta - q \cdot \beta \cdot \frac{z - \beta}{(z + \varepsilon \beta) \cdot (z + \sigma \beta)}$       **Eq. (3.52)**       $Z(\beta, q) := \text{Find}(z)$

**The derivative in the following equations equals:**  $-c_i \cdot \left( \frac{\text{Tr}_i}{\alpha_i} \right)^{0.5}$

$$i := 1..14 \quad I_i := \frac{1}{2 \cdot \sqrt{2}} \cdot \ln \left( \frac{Z(\beta_i, q_i + \sigma \beta_i)}{Z(\beta_i, q_i + \varepsilon \beta_i)} \right) \quad \text{Eq. (6.65b)}$$

$$\text{HR}_i := R \cdot \text{Tr}_i \cdot \left[ Z(\beta_i, q_i) - 1 - \left[ c_i \cdot \left( \frac{\text{Tr}_i}{\alpha_i} \right)^{0.5} + 1 \right] \cdot q_i \cdot I_i \right] \quad \text{Eq. (6.67)}$$

$$\text{SR}_i := R \cdot \left[ \ln(Z(\beta_i, q_i) - \beta_i - c_i \cdot \left( \frac{\text{Tr}_i}{\alpha_i} \right)^{0.5} \cdot q_i \cdot I_i) \right] \quad \text{Eq. (6.68)}$$

$Z(\beta_i, q_i) =$	$\text{HR}_i =$	$\frac{\text{J}}{\text{mol}}$	$\text{SR}_i =$	$\frac{\text{J}}{\text{mol} \cdot \text{K}}$
0.667	$-2.655 \cdot 10^3$		-6.41	
0.572	$-2.146 \cdot 10^3$		-8.846	
0.754	$-3.861 \cdot 10^3$		-4.804	
0.691	$-4.985 \cdot 10^3$		-7.422	
0.716	$-2.665 \cdot 10^3$		-5.993	
0.732	$-1.468 \cdot 10^3$		-6.016	
0.69	$-4.95 \cdot 10^3$		-6.256	
0.71	$-6.014 \cdot 10^3$		-6.872	
0.752	$-1.917 \cdot 10^3$		-4.452	
0.725	$-2.896 \cdot 10^3$		-5.099	
0.64	$-1.573 \cdot 10^3$		-7.539	
0.748	$-4.357 \cdot 10^3$		-5.631	
0.756	$-2.39 \cdot 10^3$		-4.484	
0.753	$-3.947 \cdot 10^3$		-6.126	

**Ans.**

**Lee/Kesler Correlation --- By linear interpolation in Tables E.1--E.12:**

$$\begin{aligned} h_0 & \text{ equals } \frac{(HR)^0}{RT_c} & h_1 & \text{ equals } \frac{(HR)^1}{RT_c} & h & \text{ equals } \frac{HR}{RT_c} \\ s_0 & \text{ equals } \frac{(SR)^0}{R} & s_1 & \text{ equals } \frac{(SR)^1}{R} & s & \text{ equals } \frac{SR}{R} \end{aligned}$$

$Z_0 :=$	$\begin{pmatrix} .686 \\ .590 \\ .774 \\ .675 \\ .725 \\ .744 \\ .705 \\ .699 \\ .770 \\ .742 \\ .651 \\ .767 \\ .776 \\ .746 \end{pmatrix}$	$Z_1 :=$	$\begin{pmatrix} -.093 \\ .155 \\ -.024 \\ .118 \\ .008 \\ .165 \\ -.019 \\ .102 \\ -.001 \\ .007 \\ .144 \\ -.034 \\ -.032 \\ .154 \end{pmatrix}$	$h_0 :=$	$\begin{pmatrix} -.950 \\ -1.709 \\ -.705 \\ -1.319 \\ -.993 \\ -1.265 \\ -.962 \\ -1.200 \\ -.770 \\ -.875 \\ -1.466 \\ -.723 \\ -.701 \\ -1.216 \end{pmatrix}$	$h_1 :=$	$\begin{pmatrix} -1.003 \\ -.471 \\ -.591 \\ -.437 \\ -.635 \\ -.184 \\ -.751 \\ -.444 \\ -.550 \\ -.598 \\ -.405 \\ -.631 \\ -.604 \\ -.211 \end{pmatrix}$
----------	--	----------	--	----------	--	----------	---

$$Z := \overrightarrow{(Z_0 + \omega \cdot Z_1)} \quad \text{Eq. (3.57)} \quad h := \overrightarrow{(h_0 + \omega \cdot h_1)} \quad \text{(6.85)} \quad HR := \overrightarrow{(h \cdot T_c \cdot R)}$$

$$\begin{array}{l}
 s_0 := \begin{pmatrix} -0.711 \\ -1.110 \\ -0.497 \\ -0.829 \\ -0.631 \\ -0.710 \\ -0.674 \\ -0.750 \\ -0.517 \\ -0.587 \\ -0.917 \\ -0.511 \\ -0.491 \\ -0.688 \end{pmatrix} \\
 s_1 := \begin{pmatrix} -0.961 \\ -0.492 \\ -0.549 \\ -0.443 \\ -0.590 \\ -0.276 \\ -0.700 \\ -0.441 \\ -0.509 \\ -0.555 \\ -0.429 \\ -0.589 \\ -0.563 \\ -0.287 \end{pmatrix}
 \end{array}
 \xrightarrow{s := (s_0 + \omega \cdot s_1)}
 \xrightarrow{SR := (s \cdot R)}
 \text{Eq. (6.86)}$$

$Z_i =$	$h_i =$	$s_i =$	$HR_i =$	$\frac{J}{mol}$	$SR_i =$	$\frac{J}{mol \cdot K}$
0.669	-1.138	-0.891	$-2.916 \cdot 10^3$		-7.405	
0.59	-1.709	-1.11	$-2.144 \cdot 10^3$		-9.229	
0.769	-0.829	-0.612	$-3.875 \cdot 10^3$		-5.091	
0.699	-1.406	-0.918	$-4.971 \cdot 10^3$		-7.629	
0.727	-1.135	-0.763	$-2.871 \cdot 10^3$		-6.345	
0.752	-1.274	-0.723	$-1.407 \cdot 10^3$		-6.013	
0.701	-1.107	-0.809	$-5.121 \cdot 10^3$		-6.727	
0.72	-1.293	-0.843	$-5.952 \cdot 10^3$		-7.005	
0.77	-0.818	-0.561	$-1.92 \cdot 10^3$		-4.667	
0.743	-0.931	-0.639	$-2.892 \cdot 10^3$		-5.314	
0.656	-1.481	-0.933	$-1.554 \cdot 10^3$		-7.759	
0.753	-0.975	-0.747	$-4.612 \cdot 10^3$		-6.207	
0.771	-0.793	-0.577	$-2.438 \cdot 10^3$		-4.794	
0.768	-1.246	-0.728	$-3.786 \cdot 10^3$		-6.054	

**Ans.**

$$6.17 \quad T := 323.15 \cdot \text{K} \quad t := \frac{T}{\text{K}} - 273.15 \quad t = 50$$

The pressure is the vapor pressure given by the Antoine equation:

$$P(t) := \exp\left(13.8858 - \frac{2788.51}{t + 220.79}\right) \quad P(50) = 36.166$$

$$\frac{d}{dt}P(t) = 1.375$$

$$P := 36.166 \cdot \text{kPa}$$

$$dPdt := 1.375 \cdot \frac{\text{kPa}}{\text{K}}$$

(a) The entropy change of vaporization is equal to the latent heat divided by the temperature. For the Clapeyron equation, Eq. (6.69), we need the volume change of vaporization. For this we estimate the liquid volume by Eq. (3.63) and the vapor volume by the generalized virial correlation. For benzene:

$$\omega := 0.210$$

$$T_c := 562.2 \cdot \text{K}$$

$$P_c := 48.98 \cdot \text{bar}$$

$$Z_c := 0.271$$

$$V_c := 259 \cdot \frac{\text{cm}^3}{\text{mol}}$$

$$T_r := \frac{T}{T_c}$$

$$T_r = 0.575$$

$$P_r := \frac{P}{P_c}$$

$$P_r = 0.007$$

By Eqs. (3.65), (3.66), (3.61), & (3.63)

$$B_0 := 0.083 - \frac{0.422}{T_r^{1.6}} \quad B_0 = -0.941 \quad B_1 := 0.139 - \frac{0.172}{T_r^{4.2}} \quad B_1 = -1.621$$

$$V_{\text{vap}} := \frac{R \cdot T}{P} \cdot \left[ 1 + \left( B_0 + \omega \cdot B_1 \cdot \frac{P_r}{T_r} \right) \right] \quad V_{\text{vap}} = 7.306 \times 10^4 \frac{\text{cm}^3}{\text{mol}}$$

$$\text{By Eq. (3.72),} \quad V_{\text{liq}} := V_c \cdot Z_c \left[ (1 - T_r)^{2/7} \right] \quad V_{\text{liq}} = 93.151 \frac{\text{cm}^3}{\text{mol}}$$

Solve Eq. (6.72) for the latent heat and divide by T to get the entropy change of vaporization:

$$\Delta S := dPdt \cdot (V_{\text{vap}} - V_{\text{liq}}) \quad \Delta S = 100.34 \frac{\text{J}}{\text{mol} \cdot \text{K}} \quad \text{Ans.}$$

(b) Here for the entropy change of vaporization:

$$\Delta S := \frac{R \cdot T}{P} \cdot dPdt \quad \Delta S = 102.14 \frac{\text{J}}{\text{mol} \cdot \text{K}} \quad \text{Ans.}$$



**6.20** The process may be assumed to occur adiabatically and at constant pressure. It is therefore isenthalpic, and may for calculational purposes be considered to occur in two steps:

(1) Heating of the water from -6 degC to the final equilibrium temperature of 0 degC.

(2) Freezing of a fraction x of the water at the equilibrium T.

Enthalpy changes for these two steps sum to zero:

$$C_P \cdot \Delta t + x \cdot \Delta H_{\text{fusion}} = 0 \quad C_P := 4.226 \cdot \frac{\text{J}}{\text{gm} \cdot \text{K}} \quad \Delta t := 6 \cdot \text{K}$$

$$\Delta H_{\text{fusion}} := -333.4 \cdot \frac{\text{joule}}{\text{gm}} \quad x := \frac{-\Delta P \cdot t}{\Delta H_{\text{fusion}}} \quad x = 0.076 \quad \text{Ans.}$$

The entropy change for the two steps is:

$$T_2 := 273.15 \cdot \text{K} \quad T_1 := (273.15 - 6) \cdot \text{K}$$

$$\Delta S := C_P \cdot \ln\left(\frac{T_2}{T_1}\right) + \frac{x \cdot \Delta H_{\text{fusion}}}{T_2} \quad \Delta S = 1.034709 \times 10^{-3} \frac{\text{J}}{\text{gm} \cdot \text{K}} \quad \text{Ans.}$$

The freezing process itself is irreversible, because it does not occur at the equilibrium temperature of 0 degC.

**6.21** Data, Table F.4:

$$H_1 := 1156.3 \cdot \frac{\text{BTU}}{\text{lb}_m}$$

$$H_2 := 1533.4 \cdot \frac{\text{BTU}}{\text{lb}_m}$$

$$S_1 := 1.7320 \cdot \frac{\text{BTU}}{\text{lb}_m \cdot \text{rankine}}$$

$$S_2 := 1.9977 \cdot \frac{\text{BTU}}{\text{lb}_m \cdot \text{rankine}}$$

$$\Delta H := H_2 - H_1$$

$$\Delta S := S_2 - S_1$$

$$\Delta H = 377.1 \frac{\text{BTU}}{\text{lb}_m}$$

$$\Delta S = 0.266 \frac{\text{BTU}}{\text{lb}_m \cdot \text{rankine}} \quad \text{Ans.}$$

For steam as an ideal gas, apply Eqs. (4.9) and (5.18). [t in degF]

$$T_1 := (227.96 + 459.67) \text{rankine}$$

$$T_2 := (1000 + 459.67) \text{rankine}$$

$$P_1 := 20 \cdot \text{psi}$$

$$P_2 := 50 \cdot \text{psi}$$

$$T_1 = 382.017 \text{K}$$

$$T_2 = 810.928 \text{K}$$

$$\text{molwt} := 18 \frac{\text{lb}}{\text{lbmol}}$$

$$\Delta H := \frac{R \cdot \text{MCPH}(T_1, T_2, 3.470, 1.450 \cdot 10^{-3}, 0.0, 0.121 \cdot 10^5) \cdot (T_2 - T_1)}{\text{molwt}}$$

$$\Delta H = 372.536 \frac{\text{BTU}}{\text{lb}_m} \quad \text{Ans.}$$

$$\Delta S := \frac{R \cdot \left( \text{MCPS}(T_1, T_2, 3.470, 1.450 \cdot 10^{-3}, 0.0, 0.121 \cdot 10^5) \cdot \ln\left(\frac{T_2}{T_1}\right) - \ln\left(\frac{P_2}{P_1}\right) \right)}{\text{molwt}}$$

$$\Delta S = 0.259 \frac{\text{BTU}}{\text{lb}_m \cdot \text{rankine}} \quad \text{Ans.}$$

### 6.22 Data, Table F.2 at 8000 kPa:

$$V_{\text{liq}} := 1.384 \cdot \frac{\text{cm}^3}{\text{gm}}$$

$$H_{\text{liq}} := 1317.1 \cdot \frac{\text{J}}{\text{gm}}$$

$$S_{\text{liq}} := 3.2076 \cdot \frac{\text{J}}{\text{gm} \cdot \text{K}}$$

$$V_{\text{vap}} := 23.525 \cdot \frac{\text{cm}^3}{\text{gm}}$$

$$H_{\text{vap}} := 2759.9 \cdot \frac{\text{J}}{\text{gm}}$$

$$S_{\text{vap}} := 5.7471 \cdot \frac{\text{J}}{\text{gm} \cdot \text{K}}$$

$$m_{\text{liq}} := \frac{0.15 \cdot 10^6}{2} \cdot \frac{\text{cm}^3}{V_{\text{liq}}}$$

$$m_{\text{vap}} := \frac{0.15 \cdot 10^6}{2} \cdot \frac{\text{cm}^3}{V_{\text{vap}}}$$

$$m_{\text{liq}} = 54.191 \text{ kg}$$

$$m_{\text{vap}} = 3.188 \text{ kg}$$

$$H_{\text{total}} := m_{\text{liq}} \cdot H_{\text{liq}} + m_{\text{vap}} \cdot H_{\text{vap}}$$

$$H_{\text{total}} = 80173.5 \text{ kJ} \quad \text{Ans.}$$

$$S_{\text{total}} := m_{\text{liq}} \cdot S_{\text{liq}} + m_{\text{vap}} \cdot S_{\text{vap}}$$

$$S_{\text{total}} = 192.145 \frac{\text{kJ}}{\text{K}} \quad \text{Ans.}$$

**6.23 Data, Table F.2 at 1000 kPa:**

$$V_{\text{liq}} := 1.127 \cdot \frac{\text{cm}^3}{\text{gm}}$$

$$H_{\text{liq}} := 762.605 \cdot \frac{\text{J}}{\text{gm}}$$

$$S_{\text{liq}} := 2.1382 \cdot \frac{\text{J}}{\text{gm} \cdot \text{K}}$$

$$V_{\text{vap}} := 194.29 \cdot \frac{\text{cm}^3}{\text{gm}}$$

$$H_{\text{vap}} := 2776.2 \cdot \frac{\text{J}}{\text{gm}}$$

$$S_{\text{vap}} := 6.5828 \cdot \frac{\text{J}}{\text{gm} \cdot \text{K}}$$

Let  $x$  = fraction of mass that is vapor (quality)       $x := 0.5$  (Guess)

Given 
$$\frac{x \cdot V_{\text{vap}}}{(1 - x) \cdot V_{\text{liq}}} = \frac{70}{30}$$

$$x := \text{Find}(x)$$

$$x = 0.013$$

$$H := (1 - x) \cdot H_{\text{liq}} + x \cdot H_{\text{vap}}$$

$$S := (1 - x) \cdot S_{\text{liq}} + x \cdot S_{\text{vap}}$$

$$H = 789.495 \frac{\text{J}}{\text{gm}}$$

$$S = 2.198 \frac{\text{J}}{\text{gm} \cdot \text{K}} \quad \text{Ans.}$$

**6.24 Data, Table F.3 at 350 degF:**

$$V_{\text{liq}} := 0.01799 \cdot \frac{\text{ft}^3}{\text{lb}_m}$$

$$V_{\text{vap}} := 3.342 \cdot \frac{\text{ft}^3}{\text{lb}_m}$$

$$H_{\text{liq}} := 321.76 \cdot \frac{\text{BTU}}{\text{lb}_m}$$

$$H_{\text{vap}} := 1192.3 \cdot \frac{\text{BTU}}{\text{lb}_m}$$

$$m_{\text{liq}} + m_{\text{vap}} = 3 \cdot \text{lb}_m \quad m_{\text{vap}} \cdot V_{\text{vap}} = 50 \cdot m_{\text{liq}} \cdot V_{\text{liq}} \quad m_{\text{liq}} + \frac{50 \cdot m_{\text{liq}} \cdot V_{\text{liq}}}{V_{\text{vap}}} = 3 \cdot \text{lb}_m$$

$$m_{\text{liq}} := \frac{3 \cdot \text{lb}_m}{1 + \frac{50 \cdot V_{\text{liq}}}{V_{\text{vap}}}}$$

$$m_{\text{liq}} = 2.364 \text{ lb}$$

$$m_{\text{vap}} := 3 \cdot \text{lb}_m - m_{\text{liq}}$$

$$m_{\text{vap}} = 0.636 \text{ lb}$$

$$H_{\text{total}} := m_{\text{liq}} \cdot H_{\text{liq}} + m_{\text{vap}} \cdot H_{\text{vap}}$$

$$H_{\text{total}} = 1519.1 \text{ BTU} \quad \text{Ans.}$$

6.25  $V := \frac{1}{0.025} \cdot \frac{\text{cm}^3}{\text{gm}}$

Data, Table F.1 at 230 degC:

$$V_{\text{liq}} := 1.209 \cdot \frac{\text{cm}^3}{\text{gm}}$$

$$H_{\text{liq}} := 990.3 \cdot \frac{\text{J}}{\text{gm}}$$

$$S_{\text{liq}} := 2.6102 \cdot \frac{\text{J}}{\text{gm} \cdot \text{K}}$$

$$V_{\text{vap}} := 71.45 \cdot \frac{\text{cm}^3}{\text{gm}}$$

$$H_{\text{vap}} := 2802.0 \cdot \frac{\text{J}}{\text{gm}}$$

$$S_{\text{vap}} := 6.2107 \cdot \frac{\text{J}}{\text{gm} \cdot \text{K}}$$

$$V = (1 - x) \cdot V_{\text{liq}} + x \cdot V_{\text{vap}}$$

$$x := \frac{V - V_{\text{liq}}}{V_{\text{vap}} - V_{\text{liq}}}$$

$$H := (1 - x) \cdot H_{\text{liq}} + x \cdot H_{\text{vap}}$$

$$S := (1 - x) \cdot S_{\text{liq}} + x \cdot S_{\text{vap}}$$

$$x = 0.552$$

$$H = 1991 \frac{\text{J}}{\text{gm}}$$

$$S = 4.599 \frac{\text{J}}{\text{gm} \cdot \text{K}}$$

Ans.

6.26  $V_{\text{total}} = m_{\text{total}} \cdot V_{\text{liq}} + m_{\text{vap}} \cdot \Delta V_{\text{lv}}$

$$V_{\text{total}} := 0.15 \cdot \text{m}^3$$

Table F.1,  
150 degC:

$$V_{\text{vap}} := 392.4 \cdot \frac{\text{cm}^3}{\text{gm}}$$

Table F.1,  
30 degC:

$$V_{\text{liq}} := 1.004 \cdot \frac{\text{cm}^3}{\text{gm}}$$

$$\Delta V_{\text{lv}} := 32930 \cdot \frac{\text{cm}^3}{\text{gm}}$$

$$m_{\text{total}} := \frac{V_{\text{total}}}{V_{\text{vap}}}$$

$$m_{\text{vap}} := \frac{V_{\text{total}} - m_{\text{total}} \cdot V_{\text{liq}}}{\Delta V_{\text{lv}}}$$

$$m_{\text{total}} = 0.382 \text{ kg}$$

$$m_{\text{vap}} = 4.543 \times 10^{-3} \text{ kg}$$

$$m_{\text{liq}} := m_{\text{total}} - m_{\text{vap}}$$

$$V_{\text{tot.liq}} := m_{\text{liq}} \cdot V_{\text{liq}}$$

$$m_{\text{liq}} = 377.72 \text{ gm}$$

$$V_{\text{tot.liq}} = 379.23 \text{ cm}^3$$

Ans.

6.27 Table F.2, 1100 kPa:  $H_{liq} := 781.124 \cdot \frac{J}{gm}$   $H_{vap} := 2779.7 \cdot \frac{J}{gm}$

Interpolate @101.325 kPa & 105 degC:  $H_2 := 2686.1 \cdot \frac{J}{gm}$

Const.-H throttling:  $H_2 = H_{liq} + x \cdot (H_{vap} - H_{liq})$

$$x := \frac{H_2 - H_{liq}}{H_{vap} - H_{liq}} \quad x = 0.953 \quad \text{Ans.}$$

6.28 Data, Table F.2 at 2100 kPa and 260 degC, by interpolation:

$$H_1 := 2923.5 \cdot \frac{J}{gm}$$

$$S_1 := 6.5640 \cdot \frac{J}{gm \cdot K}$$

$$\text{molwt} := 18.015 \frac{gm}{mol}$$

$$H_2 := 2923.5 \cdot \frac{J}{gm}$$

Final state is at this enthalpy and a pressure of 125 kPa.

By interpolation at these conditions, the final temperature is 224.80 degC and

$$S_2 := 7.8316 \cdot \frac{J}{gm \cdot K}$$

$$\Delta S := S_2 - S_1$$

$$\Delta S = 1.268 \frac{J}{gm \cdot K} \quad \text{Ans.}$$

For steam as an ideal gas, there would be no temperature change and the entropy change would be given by:

$$P_1 := 2100 \cdot \text{kPa}$$

$$P_2 := 125 \cdot \text{kPa}$$

$$\Delta S := \frac{-R}{\text{molwt}} \cdot \ln\left(\frac{P_2}{P_1}\right)$$

$$\Delta S = 1.302 \frac{J}{gm \cdot K} \quad \text{Ans.}$$

6.29 Data, Table F.4 at 300(psia) and 500 degF:

$$H_1 := 1257.7 \cdot \frac{BTU}{lb_m}$$

$$S_1 := 1.5703 \cdot \frac{BTU}{lb_m \cdot \text{rankine}}$$

$$H_2 := 1257.7 \cdot \frac{BTU}{lb_m}$$

Final state is at this enthalpy and a pressure of 20(psia).

By interpolation at these conditions, the final temperature is 438.87 degF and

$$S_2 := 1.8606 \cdot \frac{BTU}{lb_m \cdot \text{rankine}}$$

$$\Delta S := S_2 - S_1$$

$$\Delta S = 0.29 \frac{BTU}{lb_m \cdot \text{rankine}}$$

For steam as an ideal gas, there would be no temperature change and the entropy change would be given by:

$$P_1 := 300 \cdot \text{psi}$$

$$P_2 := 20 \cdot \text{psi}$$

$$\text{molwt} := 18 \frac{\text{lb}}{\text{lbmol}}$$

$$\Delta S := \frac{-R \cdot \ln\left(\frac{P_2}{P_1}\right)}{\text{molwt}}$$

$$\Delta S = 0.299 \frac{\text{BTU}}{\text{lb}_m \cdot \text{rankine}}$$

Ans.

### 6.30 Data, Table F.2 at 500 kPa and 300 degC

$$S_1 := 7.4614 \cdot \frac{\text{J}}{\text{gm} \cdot \text{K}}$$

The final state is at this entropy and a pressure of 50 kPa. This is a state of wet steam, for which

$$S_{\text{liq}} := 1.0912 \cdot \frac{\text{J}}{\text{gm} \cdot \text{K}}$$

$$S_{\text{vap}} := 7.5947 \cdot \frac{\text{J}}{\text{gm} \cdot \text{K}}$$

$$H_{\text{liq}} := 340.564 \cdot \frac{\text{J}}{\text{gm}}$$

$$H_{\text{vap}} := 2646.9 \cdot \frac{\text{J}}{\text{gm}}$$

$$S_2 = S_1 = S_{\text{liq}} + x \cdot (S_{\text{vap}} - S_{\text{liq}})$$

$$x := \frac{S_1 - S_{\text{liq}}}{S_{\text{vap}} - S_{\text{liq}}}$$

$$x = 0.98$$

$$H_2 := H_{\text{liq}} + x \cdot (H_{\text{vap}} - H_{\text{liq}})$$

$$H_2 = 2599.6 \frac{\text{J}}{\text{gm}}$$

Ans.

### 6.31 Vapor pressures of water from Table F.1:

At 25 degC:

$$P_{\text{sat}} := 3.166 \cdot \text{kPa}$$

$$P := 101.33 \cdot \text{kPa}$$

$$x_{\text{water}} := \frac{P_{\text{sat}}}{P}$$

$$x_{\text{water}} = 0.031$$

Ans.

At 50 degC:

$$P_{\text{sat}} := 12.34 \cdot \text{kPa}$$

$$x_{\text{water}} := \frac{P_{\text{sat}}}{P}$$

$$x_{\text{water}} = 0.122$$

Ans.

**6.32 Process occurs at constant total volume:**

$$V_{\text{total}} := (0.014 + 0.021) \cdot \text{m}^3$$

**Data, Table F.1 at 100 degC:**

$$U_{\text{liq}} := 419.0 \cdot \frac{\text{J}}{\text{gm}}$$

$$U_{\text{vap}} := 2506.5 \cdot \frac{\text{J}}{\text{gm}}$$

$$V_{\text{liq}} := 1.044 \cdot \frac{\text{cm}^3}{\text{gm}}$$

$$V_{\text{vap}} := 1673.0 \cdot \frac{\text{cm}^3}{\text{gm}}$$

$$m_{\text{liq}} := \frac{0.021 \cdot \text{m}^3}{V_{\text{liq}}}$$

$$m_{\text{vap}} := \frac{0.014 \cdot \text{m}^3}{V_{\text{vap}}}$$

$$\text{mass} := m_{\text{liq}} + m_{\text{vap}}$$

$$x := \frac{m_{\text{vap}}}{\text{mass}}$$

$$x = 4.158 \times 10^{-4}$$

**(initial quality)**

$$V_2 := \frac{V_{\text{total}}}{\text{mass}}$$

$$V_2 = 1.739 \cdot \frac{\text{cm}^3}{\text{gm}}$$

**This state is first reached as saturated liquid at 349.83 degC**

**For this state, P = 16,500.1 kPa, and**

$$U_2 := 1641.7 \cdot \frac{\text{J}}{\text{gm}}$$

$$U_1 := U_{\text{liq}} + x \cdot (U_{\text{vap}} - U_{\text{liq}})$$

$$U_1 = 419.868 \cdot \frac{\text{J}}{\text{gm}}$$

$$Q := U_2 - U_1$$

$$Q = 1221.8 \cdot \frac{\text{J}}{\text{gm}}$$

**Ans.**

**6.33**  $V_{\text{total}} := 0.25 \cdot \text{m}^3$

**Data, Table F.2, sat. vapor at 1500 kPa:**

$$V_1 := 131.66 \cdot \frac{\text{cm}^3}{\text{gm}}$$

$$U_1 := 2592.4 \cdot \frac{\text{J}}{\text{gm}}$$

$$\text{mass} := \frac{V_{\text{total}}}{V_1}$$

**Of this total mass, 25% condenses making the quality 0.75**  $x := 0.75$

**Since the total volume and mass don't change, we have for the final state:**

$$V_2 = V_1 = V_{\text{liq}} + x \cdot (V_{\text{vap}} - V_{\text{liq}}) \quad \text{Whence}$$

$$x = \frac{V_1 - V_{\text{liq}}}{V_{\text{vap}} - V_{\text{liq}}} \quad \text{(A)}$$

**Find P for which (A) yields the value  $x = 0.75$  for wet steam**

Since the liquid volume is much smaller than the vapor volume, we make a preliminary calculation to estimate:

$$V_{\text{vap}} := \frac{V_1}{x}$$

$$V_{\text{vap}} = 175.547 \frac{\text{cm}^3}{\text{gm}}$$

This value occurs at a pressure a bit above 1100 kPa. Evaluate x at 1100 and 1150 kPa by (A). Interpolate on x to find P = 1114.5 kPa and

$$U_{\text{liq}} := 782.41 \cdot \frac{\text{J}}{\text{gm}}$$

$$U_{\text{vap}} := 2584.9 \cdot \frac{\text{J}}{\text{gm}}$$

$$U_2 := U_{\text{liq}} + x \cdot (U_{\text{vap}} - U_{\text{liq}})$$

$$U_2 = 2134.3 \frac{\text{J}}{\text{gm}}$$

$$Q := \text{mass} \cdot (U_2 - U_1)$$

$$Q = -869.9 \text{ kJ} \quad \text{Ans.}$$

6.34 Table F.2, 101.325 kPa:

$$V_{\text{liq}} := 1.044 \cdot \frac{\text{cm}^3}{\text{gm}}$$

$$V_{\text{vap}} := 1673.0 \cdot \frac{\text{cm}^3}{\text{gm}}$$

$$U_{\text{liq}} := 418.959 \cdot \frac{\text{J}}{\text{gm}}$$

$$U_{\text{vap}} := 2506.5 \cdot \frac{\text{J}}{\text{gm}}$$

$$m_{\text{liq}} := \frac{0.02 \cdot \text{m}^3}{V_{\text{liq}}}$$

$$m_{\text{vap}} := \frac{1.98 \cdot \text{m}^3}{V_{\text{vap}}}$$

$$m_{\text{total}} := m_{\text{liq}} + m_{\text{vap}}$$

$$x := \frac{m_{\text{vap}}}{m_{\text{total}}}$$

$$V_1 := V_{\text{liq}} + x \cdot (V_{\text{vap}} - V_{\text{liq}})$$

$$V_1 = 98.326 \frac{\text{cm}^3}{\text{gm}}$$

$$x = 0.058$$

$$U_1 := U_{\text{liq}} + x \cdot (U_{\text{vap}} - U_{\text{liq}})$$

$$U_1 = 540.421 \frac{\text{J}}{\text{gm}}$$

Since the total volume and the total mass do not change during the process, the initial and final specific volumes are the same. The final state is therefore the state for which the specific volume of saturated vapor is 98.326 cu cm/gm. By interpolation in Table F.1, we find t = 213.0 degC and

$$U_2 := 2598.4 \cdot \frac{\text{J}}{\text{gm}}$$

$$Q := m_{\text{total}} \cdot (U_2 - U_1)$$

$$Q = 41860.5 \text{ kJ} \quad \text{Ans.}$$



**6.35 Data, Table F.2 at 800 kPa and 350 degC:**

$$V_1 := 354.34 \cdot \frac{\text{cm}^3}{\text{gm}}$$

$$U_1 := 2878.9 \cdot \frac{\text{J}}{\text{gm}}$$

$$V_{\text{total}} := 0.4 \cdot \text{m}^3$$

The final state at 200 degC has the same specific volume as the initial state, and this occurs for superheated steam at a pressure between 575 and 600 kPa. By interpolation, we find  $P = 596.4$  kPa and

$$U_2 := 2638.7 \cdot \frac{\text{J}}{\text{gm}}$$

$$Q := \frac{V_{\text{total}}}{V_1} \cdot (U_2 - U_1)$$

$$Q = -271.15 \text{ kJ} \quad \text{Ans.}$$

**6.36 Data, Table F.2 at 800 kPa and 200 degC:**

$$U_1 := 2629.9 \cdot \frac{\text{J}}{\text{gm}}$$

$$S_1 := 6.8148 \cdot \frac{\text{J}}{\text{gm} \cdot \text{K}}$$

$$\text{mass} := 1 \cdot \text{kg}$$

**(a) Isothermal expansion to 150 kPa and 200 degC**

$$U_2 := 2656.3 \cdot \frac{\text{J}}{\text{gm}}$$

$$S_2 := 7.6439 \cdot \frac{\text{J}}{\text{gm} \cdot \text{K}}$$

$$T := 473.15 \cdot \text{K}$$

$$Q := \text{mass} \cdot T \cdot (S_2 - S_1)$$

$$Q = 392.29 \text{ kJ}$$

**Ans.**

**Also:**  $\text{Work} := \text{mass} \cdot (U_2 - U_1) - Q$

$$\text{Work} = -365.89 \text{ kJ}$$

**(b) Constant-entropy expansion to 150 kPa. The final state is wet steam:**

$$S_{\text{liq}} := 1.4336 \cdot \frac{\text{J}}{\text{gm} \cdot \text{K}}$$

$$S_{\text{vap}} := 7.2234 \cdot \frac{\text{J}}{\text{gm} \cdot \text{K}}$$

$$U_{\text{liq}} := 444.224 \cdot \frac{\text{J}}{\text{gm}}$$

$$U_{\text{vap}} := 2513.4 \cdot \frac{\text{J}}{\text{gm}}$$

$$x := \frac{S_1 - S_{\text{liq}}}{S_{\text{vap}} - S_{\text{liq}}}$$

$$x = 0.929$$

$$U_2 := U_{\text{liq}} + x \cdot (U_{\text{vap}} - U_{\text{liq}})$$

$$U_2 = 2.367 \times 10^3 \frac{\text{J}}{\text{gm}}$$

$$W := \text{mass} \cdot (U_2 - U_1)$$

$$W = -262.527 \text{ kJ}$$

**Ans.**

**6.37 Data, Table F.2 at 2000 kPa:**

$$x := 0.94$$

$$H_{\text{vap}} := 2797.2 \cdot \frac{\text{J}}{\text{gm}}$$

$$H_{\text{liq}} := 908.589 \cdot \frac{\text{J}}{\text{gm}}$$

$$H_1 := H_{\text{liq}} + x \cdot (H_{\text{vap}} - H_{\text{liq}})$$

$$H_1 = 2.684 \times 10^3 \frac{\text{J}}{\text{gm}}$$

$$\text{mass} := 1 \cdot \text{kg}$$

**For superheated vapor at 2000 kPa and 575 degC, by interpolation:**

$$H_2 := 3633.4 \cdot \frac{\text{J}}{\text{gm}}$$

$$Q := \text{mass} \cdot (H_2 - H_1)$$

$$Q = 949.52 \text{ kJ} \quad \text{Ans.}$$

**6.38 First step:**

$$Q_{12} = 0$$

$$W_{12} = U_2 - U_1$$

**Second step:**

$$W_{23} = 0$$

$$Q_{23} = U_3 - U_2$$

**For process:**

$$Q = U_3 - U_1$$

$$W = U_2 - U_1$$

**Table F.2,  
2700 kPa:**

$$U_{\text{liq}} := 977.968 \cdot \frac{\text{J}}{\text{gm}}$$

$$U_{\text{vap}} := 2601.8 \cdot \frac{\text{J}}{\text{gm}}$$

$$S_{\text{liq}} := 2.5924 \cdot \frac{\text{J}}{\text{gm} \cdot \text{K}}$$

$$S_{\text{vap}} := 6.2244 \cdot \frac{\text{J}}{\text{gm} \cdot \text{K}}$$

$$x_1 := 0.9$$

$$U_1 := U_{\text{liq}} + x_1 \cdot (U_{\text{vap}} - U_{\text{liq}})$$

$$U_1 = 2.439 \times 10^3 \frac{\text{J}}{\text{gm}}$$

$$S_1 := S_{\text{liq}} + x_1 \cdot (S_{\text{vap}} - S_{\text{liq}})$$

$$S_1 = 5.861 \times 10^3 \frac{\text{m}^2}{\text{s}^2 \text{K}}$$

**Table F.2, 400 kPa:**

$$S_{\text{liq}} := 1.7764 \cdot \frac{\text{J}}{\text{gm} \cdot \text{K}}$$

$$S_{\text{vap}} := 6.8943 \cdot \frac{\text{J}}{\text{gm} \cdot \text{K}}$$

$$U_{\text{liq}} := 604.237 \cdot \frac{\text{J}}{\text{gm}}$$

$$U_{\text{vap}} := 2552.7 \cdot \frac{\text{J}}{\text{gm}}$$

$$V_{\text{liq}} := 1.084 \cdot \frac{\text{cm}^3}{\text{gm}}$$

$$V_{\text{vap}} := 462.22 \cdot \frac{\text{cm}^3}{\text{gm}}$$

Since step 1 is isentropic,

$$S_2 = S_1 = S_{\text{liq}} + x_2 \cdot (S_{\text{vap}} - S_{\text{liq}}) \quad x_2 := \frac{S_1 - S_{\text{liq}}}{S_{\text{vap}} - S_{\text{liq}}} \quad x_2 = 0.798$$

$$U_2 := U_{\text{liq}} + x_2 \cdot (U_{\text{vap}} - U_{\text{liq}}) \quad U_2 = 2.159 \times 10^3 \frac{\text{J}}{\text{gm}}$$

$$V_2 := V_{\text{liq}} + x_2 \cdot (V_{\text{vap}} - V_{\text{liq}}) \quad V_2 = 369.135 \frac{\text{cm}^3}{\text{gm}}$$

$V_3 = V_2$  and the final state is sat. vapor with this specific volume.  
Interpolate to find that this V occurs at  $T = 509.23 \text{ degC}$  and

$$U_3 := 2560.7 \frac{\text{J}}{\text{gm}} \quad \text{Whence} \quad Q := U_3 - U_2 \quad \text{Work} := U_2 - U_1$$

$$Q = 401.317 \frac{\text{J}}{\text{gm}} \quad \text{Ans.} \quad \text{Work} = -280.034 \frac{\text{J}}{\text{gm}} \quad \text{Ans.}$$

6.39 Table F.2, 400 kPa & 175 degC:

$$U_1 := 2605.8 \frac{\text{J}}{\text{gm}}$$

$$S_1 := 7.0548 \frac{\text{J}}{\text{gm} \cdot \text{K}}$$

Table F.1, sat. vapor, 175 degC

$$U_2 := 2578.8 \frac{\text{J}}{\text{gm}}$$

$$S_2 := 6.6221 \frac{\text{J}}{\text{gm} \cdot \text{K}}$$

$$\text{mass} := 4 \cdot \text{kg}$$

$$T := (175 + 273.15) \cdot \text{K}$$

$$Q := \text{mass} \cdot T \cdot (S_2 - S_1) \quad W := \text{mass} \cdot (U_2 - U_1) - Q$$

$$Q = -775.66 \text{ kJ} \quad \text{Ans.} \quad W = 667.66 \text{ kJ} \quad \text{Ans.}$$

6.40 (a) Table F.2, 3000 kPa and 450 degC:

$$H_1 := 3344.6 \frac{\text{J}}{\text{gm}}$$

$$S_1 := 7.0854 \frac{\text{J}}{\text{gm} \cdot \text{K}}$$

Table F.2, interpolate 235 kPa and 140 degC:

$$H_2 := 2744.5 \frac{\text{J}}{\text{gm}}$$

$$S_2 := 7.2003 \frac{\text{J}}{\text{gm} \cdot \text{K}}$$

$$\Delta H := H_2 - H_1 \quad \Delta H = -600.1 \frac{\text{J}}{\text{gm}} \quad \text{Ans.}$$

$$\Delta S := S_2 - S_1 \quad \Delta S = 0.115 \frac{\text{J}}{\text{gm}\cdot\text{K}} \quad \text{Ans.}$$

(b)  $T_1 := (450 + 273.15)\cdot\text{K}$        $T_2 := (140 + 273.15)\cdot\text{K}$   
 $T_1 = 723.15\text{K}$        $T_2 = 413.15\text{K}$   
 $P_1 := 3000\cdot\text{kPa}$        $P_2 := 235\cdot\text{kPa}$

Eqs. (6.95) & (6.96) for an ideal gas:  $\text{molwt} := 18 \frac{\text{gm}}{\text{mol}}$

$$\Delta H_{\text{ig}} := \frac{R \cdot \text{ICPH}(T_1, T_2, 3.470, 1.450 \cdot 10^{-3}, 0.0, 0.121 \cdot 10^5)}{\text{molwt}}$$

$$\Delta S_{\text{ig}} := \frac{R \cdot \left( \text{ICPS}(T_1, T_2, 3.470, 1.450 \cdot 10^{-3}, 0.0, 0.121 \cdot 10^5) - \ln\left(\frac{P_2}{P_1}\right) \right)}{\text{molwt}}$$

$$\Delta H_{\text{ig}} = -620.6 \frac{\text{J}}{\text{gm}} \quad \Delta S_{\text{ig}} = 0.0605 \frac{\text{J}}{\text{gm}\cdot\text{K}} \quad \text{Ans.}$$

(c)  $T_c := 647.1\cdot\text{K}$        $P_c := 220.55\cdot\text{bar}$        $\omega := 0.345$

$$T_{r1} := \frac{T_1}{T_c} \quad P_{r1} := \frac{P_1}{P_c} \quad T_{r2} := \frac{T_2}{T_c} \quad P_{r2} := \frac{P_2}{P_c}$$

$$T_{r1} = 1.11752 \quad P_{r1} = 0.13602 \quad T_{r2} = 0.63846 \quad P_{r2} = 0.01066$$

The generalized virial-coefficient correlation is suitable here

$$\Delta H := \Delta H_{\text{ig}} + \frac{R \cdot T_c \cdot (\text{HRB}(T_{r2}, \mathcal{B}_{r2}) - \text{HRB}(T_{r1}, \mathcal{B}_{r1}))}{\text{molwt}}$$

$$\Delta H = -593.95 \frac{\text{J}}{\text{gm}} \quad \text{Ans.}$$

$$\Delta S := \Delta S_{\text{ig}} + \frac{R \cdot (\text{SRB}(T_{r2}, \mathcal{B}_{r2}) - \text{SRB}(T_{r1}, \mathcal{B}_{r1}))}{\text{molwt}}$$

$$\Delta S = 0.078 \frac{\text{J}}{\text{gm}\cdot\text{K}} \quad \text{Ans.}$$

6.41 Data, Table F.2 superheated steam at 550 kPa and 200 degC:

$$V_1 := 385.19 \cdot \frac{\text{cm}^3}{\text{gm}}$$

$$U_1 := 2640.6 \cdot \frac{\text{J}}{\text{gm}}$$

$$S_1 := 7.0108 \cdot \frac{\text{J}}{\text{gm} \cdot \text{K}}$$

Step 1--2: Const.-V heating to 800 kPa. At the initial specific volume and this P, interpolation gives  $t = 401.74$  degC, and

$$U_2 := 2963.1 \cdot \frac{\text{J}}{\text{gm}}$$

$$S_2 := 7.5782 \cdot \frac{\text{J}}{\text{gm} \cdot \text{K}}$$

$$Q_{12} := U_2 - U_1$$

$$Q_{12} = 322.5 \frac{\text{J}}{\text{gm}}$$

Step 2--3: Isentropic expansion to initial T.

$$Q_{23} = 0$$

$$S_3 = S_2$$

$$S_3 := 7.5782 \cdot \frac{\text{J}}{\text{gm} \cdot \text{K}}$$

Step 3--1: Constant-T compression to initial P.

$$T := 473.15 \cdot \text{K}$$

$$Q_{31} := T \cdot (S_1 - S_3)$$

$$Q_{31} = -268.465 \frac{\text{J}}{\text{gm}}$$

For the cycle, the internal energy change = 0.

$$W_{\text{cycle}} = -Q_{\text{cycle}} = -Q_{12} - Q_{31} \quad \eta = \frac{-W_{\text{cycle}}}{Q_{12}}$$

$$\eta := 1 + \frac{Q_{31}}{Q_{12}} \quad \eta = 0.1675 \quad \text{Ans.}$$

6.42 Table F.4, sat.vapor, 300(psi):

$$T_1 := (417.35 + 459.67) \cdot \text{rankine} \quad H_1 := 1202.9 \cdot \frac{\text{BTU}}{\text{lb}_m}$$

$$T_1 = 877.02 \text{ rankine}$$

$$S_1 := 1.5105 \cdot \frac{\text{BTU}}{\text{lb}_m \cdot \text{rankine}}$$

Superheated steam at 300(psi) & 900 degF

$$H_2 := 1473.6 \cdot \frac{\text{BTU}}{\text{lb}_m}$$

$$S_2 := 1.7591 \cdot \frac{\text{BTU}}{\text{lb}_m \cdot \text{rankine}}$$

$$S_3 := S_2$$

$$Q_{12} := H_2 - H_1$$

$$Q_{31} := T_1 \cdot (S_1 - S_3)$$

$$Q_{31} = -218.027 \frac{\text{BTU}}{\text{lb}_m}$$

For the cycle, the internal energy change = 0.

$$W_{\text{cycle}} = -Q_{\text{cycle}} = -Q_{12} - Q_{31} \quad \eta = \frac{-W_{\text{cycle}}}{Q_{12}} \quad \text{Whence}$$

$$\eta := 1 + \frac{Q_{31}}{Q_{12}} \quad \eta = 0.1946 \quad \text{Ans.}$$

6.43 Data, Table F.2, superheated steam at 4000 kPa and 400 degC:

$$S_1 := 6.7733 \cdot \frac{\text{J}}{\text{gm} \cdot \text{K}} \quad \text{For both parts of the problem:} \quad S_2 := S_1$$

(a) So we are looking for the pressure at which saturated vapor has the given entropy. This occurs at a pressure just below 575 kPa. By interpolation,

$$P_2 = 572.83 \cdot \text{kPa} \quad \text{Ans.}$$

(b) For the wet vapor the entropy is given by

$$x := 0.95 \quad S_2 = S_{\text{liq}} + x \cdot (S_{\text{vap}} - S_{\text{liq}})$$

So we must find the pressure for which this equation is satisfied. This occurs at a pressure just above 250 kPa. At 250 kPa:

$$S_{\text{liq}} := 1.6071 \cdot \frac{\text{J}}{\text{gm} \cdot \text{K}}$$

$$S_{\text{vap}} := 7.0520 \cdot \frac{\text{J}}{\text{gm} \cdot \text{K}}$$

$$S_2 := S_{\text{liq}} + x \cdot (S_{\text{vap}} - S_{\text{liq}})$$

$$S_2 = 6.7798 \cdot \frac{\text{J}}{\text{gm} \cdot \text{K}}$$

Slightly > 6.7733

$$\text{By interpolation} \quad P_2 = 250.16 \cdot \text{kPa} \quad \text{Ans.}$$

6.44 (a) Table F.2 at the final conditions of saturated vapor at 50 kPa:

$$S_2 := 7.5947 \cdot \frac{\text{kJ}}{\text{kg} \cdot \text{K}}$$

$$H_2 := 2646.0 \cdot \frac{\text{kJ}}{\text{kg}}$$

$$S_1 := S_2$$

Find the temperature of superheated vapor at 2000 kPa with this entropy. It occurs between 550 and 600 degC. By interpolation

$$t_1 := 559.16 \quad (\text{degC}) \quad H_1 := 3598.0 \cdot \frac{\text{kJ}}{\text{kg}}$$

$$\text{Superheat: } \Delta t := (559.16 - 212.37) \cdot \text{K} \quad \Delta t = 346.79 \text{ K} \quad \text{Ans.}$$

$$(b) \quad \dot{m} := 5 \cdot \frac{\text{kg}}{\text{sec}} \quad \dot{W} := \left| \dot{m} \cdot (H_2 - H_1) \right| \quad \dot{W} = 4760 \text{ kW} \quad \text{Ans.}$$

6.45 Table F.2 for superheated vapor at the initial conditions, 1350 kPa and 375 degC, and for the final condition of sat. vapor at 10 kPa:

$$H_1 := 3205.4 \cdot \frac{\text{kJ}}{\text{kg}} \quad S_1 := 7.2410 \cdot \frac{\text{kJ}}{\text{kg} \cdot \text{K}} \quad H_2 := 2584.8 \cdot \frac{\text{kJ}}{\text{kg}}$$

If the turbine were to operate isentropically, the final entropy would be

$$S_2 := S_1$$

Table F.2 for sat. liquid and vapor at 10 kPa:

$$S_{\text{liq}} := 0.6493 \cdot \frac{\text{kJ}}{\text{kg} \cdot \text{K}} \quad S_{\text{vap}} := 8.1511 \cdot \frac{\text{kJ}}{\text{kg} \cdot \text{K}}$$

$$H_{\text{liq}} := 191.832 \cdot \frac{\text{kJ}}{\text{kg}} \quad H_{\text{vap}} := 2584.8 \cdot \frac{\text{kJ}}{\text{kg}}$$

$$x_2 := \frac{S_2 - S_{\text{liq}}}{S_{\text{vap}} - S_{\text{liq}}} \quad x_2 = 0.879 \quad H' := H_{\text{liq}} + x_2 \cdot (H_{\text{vap}} - H_{\text{liq}})$$

$$\eta := \frac{H_2 - H_1}{H' - H_1} \quad \eta = 0.681 \quad \text{Ans.} \quad H' = 2.294 \times 10^3 \frac{\text{kJ}}{\text{kg}}$$

6.46 Table F.2 for superheated vapor at the initial conditions, 1300 kPa and 400 degC, and for the final condition of 40 kPa and 100 degC:

$$H_1 := 3259.7 \cdot \frac{\text{kJ}}{\text{kg}} \quad S_1 := 7.3404 \cdot \frac{\text{kJ}}{\text{kg} \cdot \text{K}} \quad H_2 := 2683.8 \cdot \frac{\text{kJ}}{\text{kg}}$$

If the turbine were to operate isentropically, the final entropy would be

$$S_2 := S_1$$

Table F.2 for sat. liquid and vapor at 40 kPa:

$$S_{\text{liq}} := 1.0261 \cdot \frac{\text{kJ}}{\text{kg} \cdot \text{K}}$$

$$S_{\text{vap}} := 7.6709 \cdot \frac{\text{kJ}}{\text{kg} \cdot \text{K}}$$

$$H_{\text{liq}} := 317.16 \cdot \frac{\text{kJ}}{\text{kg}}$$

$$H_{\text{vap}} := 2636.9 \cdot \frac{\text{kJ}}{\text{kg}}$$

$$x_2 := \frac{S_2 - S_{\text{liq}}}{S_{\text{vap}} - S_{\text{liq}}}$$

$$x_2 = 0.95$$

$$H' := H_{\text{liq}} + x_2 \cdot (H_{\text{vap}} - H_{\text{liq}})$$

$$H' = 2.522 \times 10^3 \frac{\text{kJ}}{\text{kg}}$$

$$\eta := \frac{H_2 - H_1}{H' - H_1}$$

$$\eta = 0.78 \quad \text{Ans.}$$

6.47 Table F.2 at 1600 kPa and 225 degC:

$$P := 1600 \cdot \text{kPa}$$

$$V := 132.85 \cdot \frac{\text{cm}^3}{\text{gm}}$$

$$H := 2856.3 \cdot \frac{\text{J}}{\text{gm}}$$

$$S := 6.5503 \cdot \frac{\text{J}}{\text{gm} \cdot \text{K}}$$

Table F.2 (ideal-gas values, 1 kPa and 225 degC)

$$H_{\text{ig}} := 2928.7 \cdot \frac{\text{J}}{\text{gm}}$$

$$S_{\text{ig}} := 10.0681 \cdot \frac{\text{J}}{\text{gm} \cdot \text{K}}$$

$$P_0 := 1 \cdot \text{kPa}$$

$$T := (225 + 273.15) \cdot \text{K}$$

$$T = 498.15 \text{ K}$$

$$V_R := V - \frac{R}{\text{molwt}} \cdot \frac{T}{P}$$

The enthalpy of an ideal gas is independent of pressure, but the entropy DOES depend on P:

$$H_R := H - H_{\text{ig}}$$

$$\Delta S_{\text{ig}} := \frac{-R}{\text{molwt}} \cdot \ln\left(\frac{P}{P_0}\right)$$

$$S_R := S - (S_{\text{ig}} + \Delta S_{\text{ig}})$$

$$V_R = -10.96 \frac{\text{cm}^3}{\text{gm}}$$

$$H_R = -72.4 \frac{\text{J}}{\text{gm}}$$

$$S_R = -0.11 \frac{\text{J}}{\text{gm} \cdot \text{K}} \quad \text{Ans.}$$

Reduced conditions:

$$\omega := 0.345$$

$$T_c := 647.1 \cdot \text{K}$$

$$P_c := 220.55 \cdot \text{bar}$$

$$T_r := \frac{T}{T_c}$$

$$T_r = 0.76982$$

$$P_r := \frac{P}{P_c}$$

$$P_r = 0.072546$$

The generalized virial-coefficient correlation is suitable here

$$B_0 := 0.083 - \frac{0.422}{T_r^{1.6}}$$

$$B_0 = -0.558$$

$$B_1 := 0.139 - \frac{0.172}{T_r^{4.2}}$$

$$B_1 = -0.377$$



By Eqs. (3.61) + (3.62) & (3.63) along with Eq. (6.40)

$$Z := 1 + \left( B_0 + \omega \cdot B_1 \right) \cdot \frac{P_r}{T_r} \quad Z = 0.935 \quad V_R := \frac{R \cdot T}{P \cdot \text{molwt}} \cdot (Z - 1)$$

$$H_R := \frac{R \cdot T_c}{\text{molwt}} \cdot \text{HRB}(T_r, \phi_r), \quad S_R := \frac{R}{\text{molwt}} \cdot \text{SRB}(T_r, \phi_r),$$

$$V_R = -9.33 \frac{\text{cm}^3}{\text{gm}}$$

$$H_R = -53.4 \frac{\text{J}}{\text{gm}}$$

$$S_R = -0.077 \frac{\text{J}}{\text{gm} \cdot \text{K}} \quad \text{Ans.}$$

6.48  $P := 1000 \cdot \text{kPa}$

$$T := (179.88 + 273.15) \cdot \text{K} \quad T = 453.03 \text{ K}$$

(Table F.2)

$$\text{molwt} := 18.015 \frac{\text{gm}}{\text{mol}}$$

$$V_1 := 1.127 \cdot \frac{\text{cm}^3}{\text{gm}}$$

$$V_v := 194.29 \cdot \frac{\text{cm}^3}{\text{gm}}$$

$$\Delta V_{lv} := V_v - V_1$$

$$H_1 := 762.605 \cdot \frac{\text{J}}{\text{gm}}$$

$$H_v := 2776.2 \cdot \frac{\text{J}}{\text{gm}}$$

$$\Delta H_{lv} := H_v - H_1$$

$$S_1 := 2.1382 \cdot \frac{\text{J}}{\text{gm} \cdot \text{K}}$$

$$S_v := 6.5828 \cdot \frac{\text{J}}{\text{gm} \cdot \text{K}}$$

$$\Delta S_{lv} := S_v - S_1$$

$$\Delta V_{lv} = 193.163 \frac{\text{cm}^3}{\text{gm}}$$

$$\Delta H_{lv} = 2.014 \times 10^3 \frac{\text{J}}{\text{gm}}$$

$$\Delta S_{lv} = 4.445 \frac{\text{J}}{\text{gm} \cdot \text{K}}$$

(a)  $G_1 := H_1 - T \cdot S_1 \quad G_1 = -206.06 \frac{\text{J}}{\text{gm}} \quad G_v := H_v - T \cdot S_v \quad G_v = -206.01 \frac{\text{J}}{\text{gm}}$

(b)  $\Delta S_{lv} = 4.445 \frac{\text{J}}{\text{gm} \cdot \text{K}} \quad r := \frac{\Delta H_{lv}}{T} \quad r = 4.445 \frac{\text{J}}{\text{gm} \cdot \text{K}}$

(c)  $V_R := V_v - \frac{R}{\text{molwt}} \cdot \frac{T}{P} \quad V_R = -14.785 \frac{\text{cm}^3}{\text{gm}} \quad \text{Ans.}$

For enthalpy and entropy, assume that steam at 179.88 degC and 1 kPa is an ideal gas. By interpolation in Table F.2 at 1 kPa:

$$H_{ig} := 2841.1 \cdot \frac{\text{J}}{\text{gm}}$$

$$S_{ig} := 9.8834 \cdot \frac{\text{J}}{\text{gm} \cdot \text{K}}$$

$$P_0 := 1 \cdot \text{kPa}$$

The enthalpy of an ideal gas is independent of pressure; the entropy DOES depend on P:

$$H_R := H_v - H_{ig} \quad \Delta S_{ig} := \frac{-R}{\text{molwt}} \cdot \ln\left(\frac{P}{P_0}\right) \quad \Delta S_{ig} = -3.188 \frac{\text{J}}{\text{gm} \cdot \text{K}}$$

$$S_R := S_v - (S_{ig} + \Delta S_{ig}) \quad H_R = -64.9 \frac{\text{J}}{\text{gm}} \text{ Ans.} \quad S_R = -0.1126 \frac{\text{J}}{\text{gm} \cdot \text{K}} \text{ Ans.}$$

(d) Assume  $\ln P$  vs.  $1/T$  linear and fit three data pts @ 975, 1000, & 1050 kPa.

Data:  $pp := \begin{pmatrix} 975 \\ 1000 \\ 1050 \end{pmatrix} \cdot \text{kPa}$   $t := \begin{pmatrix} 178.79 \\ 179.88 \\ 182.02 \end{pmatrix} \text{ (degC)}$   $i := 1..3$

$$x_i := \frac{1}{t_i + 273.15} \quad y_i := \ln\left(\frac{pp_i}{\text{kPa}}\right) \quad \text{Slope} := \text{slope}(x, y) \quad \text{Slope} = -4717$$

$$dPdT := \frac{-P}{T^2} \cdot \text{Slope} \cdot \text{K} \quad dPdT = 22.984 \frac{\text{kPa}}{\text{K}}$$

$$\Delta S_{lv} := \Delta V_{lv} \cdot dPdT \quad \Delta S_{lv} = 4.44 \frac{\text{J}}{\text{gm} \cdot \text{K}} \text{ Ans.}$$

Reduced conditions:  $\omega := 0.345$   $T_c := 647.1 \cdot \text{K}$   $P_c := 220.55 \cdot \text{bar}$

$$T_r := \frac{T}{T_c} \quad T_r = 0.7001 \quad P_r := \frac{P}{P_c} \quad P_r = 0.0453$$

The generalized virial-coefficient correlation is suitable here

$$B_0 := 0.083 - \frac{0.422}{T_r^{1.6}} \quad B_0 = -0.664 \quad B_1 := 0.139 - \frac{0.172}{T_r^{4.2}} \quad B_1 = -0.63$$

By Eqs. (3.61) + (3.62) & (3.63) along with Eq. (6.40)

$$Z := 1 + \left( B_0 + \omega \cdot B_1 \right) \cdot \frac{P_r}{T_r} \quad Z = 0.943 \quad V_R := \frac{R \cdot T}{P \cdot \text{molwt}} \cdot (Z - 1)$$

$$H_R := \frac{R \cdot T_c}{\text{molwt}} \cdot \text{HRB}(T_r, \phi_r), \quad S_R := \frac{R}{\text{molwt}} \cdot \text{SRB}(T_r, \phi_r),$$

$$V_R = -11.93 \frac{\text{cm}^3}{\text{gm}}$$

$$H_R = -43.18 \frac{\text{J}}{\text{gm}}$$

$$S_R = -0.069 \frac{\text{J}}{\text{gm} \cdot \text{K}}$$

Ans.

6.49  $T := (358.43 + 459.67) \cdot \text{rankine}$

$T = 818.1 \text{ rankine}$

$P := 150 \cdot \text{psi}$

(Table F.4)

$\text{molwt} := 18.015 \frac{\text{gm}}{\text{mol}}$

$$V_1 := 0.0181 \cdot \frac{\text{ft}^3}{\text{lb}_m}$$

$$V_v := 3.014 \cdot \frac{\text{ft}^3}{\text{lb}_m}$$

$$\Delta V_{lv} := V_v - V_1$$

$$H_1 := 330.65 \cdot \frac{\text{BTU}}{\text{lb}_m}$$

$$H_v := 1194.1 \cdot \frac{\text{BTU}}{\text{lb}_m}$$

$$\Delta H_{lv} := H_v - H_1$$

$$S_1 := 0.5141 \cdot \frac{\text{BTU}}{\text{lb}_m \cdot \text{rankine}}$$

$$S_v := 1.5695 \cdot \frac{\text{BTU}}{\text{lb}_m \cdot \text{rankine}}$$

$$\Delta S_{lv} := S_v - S_1$$

$$\Delta V_{lv} = 2.996 \frac{\text{ft}^3}{\text{lb}_m}$$

$$\Delta H_{lv} = 863.45 \frac{\text{BTU}}{\text{lb}_m}$$

(a)  $G_1 := H_1 - T \cdot S_1$

$G_v := H_v - T \cdot S_v$

$$G_1 = -89.94 \frac{\text{BTU}}{\text{lb}_m}$$

$$G_v = -89.91 \frac{\text{BTU}}{\text{lb}_m}$$

(b)  $\Delta S_{lv} = 1.055 \frac{\text{BTU}}{\text{lb}_m \cdot \text{rankine}}$

$$r := \frac{\Delta H_{lv}}{T}$$

$$r = 1.055 \frac{\text{BTU}}{\text{lb}_m \cdot \text{rankine}}$$

(c)  $V_R := V_v - \frac{R}{\text{molwt}} \cdot \frac{T}{P}$

$$V_R = -0.235 \frac{\text{ft}^3}{\text{lb}_m}$$

Ans.

For enthalpy and entropy, assume that steam at 358.43 degF and 1 psi is an ideal gas. By interpolation in Table F.4 at 1 psi:

$$H_{ig} := 1222.6 \cdot \frac{\text{BTU}}{\text{lb}_m}$$

$$S_{ig} := 2.1492 \cdot \frac{\text{BTU}}{\text{lb}_m \cdot \text{rankine}}$$

$$P_0 := 1 \cdot \text{psi}$$

**The enthalpy of an ideal gas is independent of pressure; the entropy DOES depend on P:**

$$H_R := H_v - H_{ig} \quad H_R = -28.5 \frac{\text{BTU}}{\text{lb}_m} \quad \text{Ans.}$$

$$\Delta S_{ig} := \frac{-R}{\text{molwt}} \cdot \ln\left(\frac{P}{P_0}\right) \quad \Delta S_{ig} = -0.552 \frac{\text{BTU}}{\text{lb}_m \cdot \text{rankine}}$$

$$S_R := S_v - (S_{ig} + \Delta S_{ig}) \quad S_R = -0.0274 \frac{\text{BTU}}{\text{lb}_m \cdot \text{rankine}} \quad \text{Ans.}$$

**(d) Assume ln P vs. 1/T linear and fit threedata points (@ 145, 150, & 155 psia)**

**Data:**  $pp := \begin{pmatrix} 145 \\ 150 \\ 155 \end{pmatrix} \cdot \text{psi}$      $t := \begin{pmatrix} 355.77 \\ 358.43 \\ 361.02 \end{pmatrix} \quad (\text{degF}) \quad i := 1..3$

$$x_i := \frac{1}{t_i + 459.67} \quad y_i := \ln\left(\frac{pp_i}{\text{psi}}\right) \quad \text{Slope} := \text{slope}(x, y)$$

$$\text{Slope} = -8.501 \times 10^3$$

$$dPdT := \frac{-P}{T^2} \cdot \text{Slope} \cdot \text{rankine}$$

$$dPdT = 1.905 \frac{\text{psi}}{\text{rankine}}$$

$$\Delta S_{lv} := \Delta V_{lv} \cdot dPdT$$

$$\Delta S_{lv} = 1.056 \frac{\text{BTU}}{\text{lb}_m \cdot \text{rankine}} \quad \text{Ans.}$$

**Reduced conditions:**  $\omega := 0.345$      $T_c := 647.1 \cdot \text{K}$      $P_c := 220.55 \cdot \text{bar}$

$$T_r := \frac{T}{T_c} \quad T_r = 0.7024 \quad P_r := \frac{P}{P_c} \quad P_r = 0.0469$$

**The generalized virial-coefficient correlation is suitable here**

$$B_0 := 0.083 - \frac{0.422}{T_r^{1.6}} \quad B_0 = -0.66 \quad B_1 := 0.139 - \frac{0.172}{T_r^{4.2}} \quad B_1 = -0.62$$

By Eqs. (3.61) + (3.62) & (3.63) along with Eq. (6.40)

$$Z := 1 + (B_0 + \omega \cdot B_1) \cdot \frac{P_r}{T_r} \quad Z = 0.942 \quad V_R := \frac{R \cdot T}{P \cdot \text{molwt}} \cdot (Z - 1)$$

$$H_R := R \cdot \frac{T_c}{\text{molwt}} \cdot \text{HRB}(T_r, \phi_r), \quad S_R := \frac{R}{\text{molwt}} \cdot \text{SRB}(T_r, \phi_r),$$

$$V_R = -0.1894 \frac{\text{ft}^3}{\text{lb}_m} \quad H_R = -19.024 \frac{\text{BTU}}{\text{lb}_m} \quad S_R = -0.0168 \frac{\text{BTU}}{\text{lb}_m \cdot \text{rankine}} \quad \text{Ans.}$$

6.50 For propane:

$$T_c := 369.8 \cdot \text{K}$$

$$P_c := 42.48 \cdot \text{bar}$$

$$\omega := 0.152$$

$$T := (195 + 273.15) \cdot \text{K}$$

$$T = 468.15 \text{ K}$$

$$P := 135 \cdot \text{bar}$$

$$P_0 := 1 \cdot \text{bar}$$

$$T_r := \frac{T}{T_c}$$

$$T_r = 1.266$$

$$P_r := \frac{P}{P_c}$$

$$P_r = 3.178$$

Use the Lee/Kesler correlation; by interpolation,

$$Z_0 := 0.6141$$

$$Z_1 := 0.1636$$

$$Z := Z_0 + \omega \cdot Z_1$$

$$Z = 0.639$$

$$V := \frac{Z \cdot R \cdot T}{P}$$

$$V = 184.2 \frac{\text{cm}^3}{\text{mol}}$$

Ans.

$$H_{R0} := -2.496 \cdot R \cdot T_c$$

$$H_{R1} := -0.586 \cdot R \cdot T_c$$

$$H_{R0} = -7.674 \times 10^3 \frac{\text{J}}{\text{mol}}$$

$$H_{R1} = -1.802 \times 10^3 \frac{\text{J}}{\text{mol}}$$

$$S_{R0} := -1.463 \cdot R$$

$$S_{R1} := -0.717 \cdot R$$

$$S_{R0} = -12.163 \frac{\text{J}}{\text{mol} \cdot \text{K}}$$

$$S_{R1} = -5.961 \frac{\text{J}}{\text{mol} \cdot \text{K}}$$

$$H_R := H_{R0} + \omega \cdot H_{R1}$$

$$S_R := S_{R0} + \omega \cdot S_{R1}$$

$$H_R = -7.948 \times 10^3 \frac{\text{J}}{\text{mol}}$$

$$S_R = -13.069 \frac{\text{J}}{\text{mol} \cdot \text{K}}$$

$$\Delta H := R \cdot \text{ICPH}(0.8, 15 \text{ K}, T, 1.213, 28.785 \cdot 10^{-3}, -8.824 \cdot 10^{-6}, 0.0) + H_R$$

$$\Delta S := R \cdot \left( \text{ICPS} \left( 308.15 \text{ K}, T, 1.213, 28.785 \cdot 10^{-3}, -8.824 \cdot 10^{-6}, 0.0 \right) - \ln \left( \frac{P}{P_0} \right) \right) + S_R$$

$$\Delta H = 6734.9 \frac{\text{J}}{\text{mol}}$$

Ans.

$$\Delta S = -15.9 \frac{\text{J}}{\text{mol} \cdot \text{K}}$$

Ans.

6.51 For propane:

$$T_c := 369.8 \cdot \text{K}$$

$$P_c := 42.48 \cdot \text{bar}$$

$$\omega := 0.152$$

$$T := (70 + 273.15) \cdot \text{K}$$

$$T = 343.15 \text{ K}$$

$$P_0 := 101.33 \cdot \text{kPa}$$

$$P := 1500 \cdot \text{kPa}$$

$$T_r := \frac{T}{T_c}$$

$$T_r = 0.92793$$

$$P_r := \frac{P}{P_c}$$

$$P_r = 0.35311$$

Assume propane an ideal gas at the initial conditions. Use generalized virial correlation at final conditions.

$$\Delta H := R \cdot T_c \cdot \text{HRB} \left( T_r, \omega_r \right)$$

$$\Delta H = -1431.3 \frac{\text{J}}{\text{mol}}$$

Ans.

$$\Delta S := R \cdot \left( \text{SRB} \left( T_r, \omega_r \right) - \ln \left( \frac{P}{P_0} \right) \right)$$

$$\Delta S = -25.287 \frac{\text{J}}{\text{mol} \cdot \text{K}}$$

Ans.

6.52 For propane:

$$\omega := 0.152$$

$$T_c := 369.8 \cdot \text{K}$$

$$P_c := 42.48 \cdot \text{bar}$$

$$Z_c := 0.276$$

$$V_c := 200.0 \frac{\text{cm}^3}{\text{mol}}$$

If the final state is a two-phase mixture, it must exist at its saturation temperature at 1 bar. This temperature is found from the vapor pressure equation:

$$P := 1 \cdot \text{bar}$$

$$A := -6.72219$$

$$B := 1.33236$$

$$C := -2.13868$$

$$D := -1.38551$$

$$\tau(T) := 1 - \frac{T}{T_c}$$

Guess:

$$T := 200 \cdot \text{K}$$

Given

$$P = P_c \cdot \exp \left[ \frac{A \cdot \tau(T) + B \cdot (\tau(T))^{1.5} + C \cdot (\tau(T))^3 + D \cdot (\tau(T))^6}{1 - \tau(T)} \right]$$

$$T := \text{Find}(T)$$

$$T = 230.703 \text{ K}$$

The latent heat of vaporization at the final conditions will be needed for an energy balance. It is found by the Clapeyron equation. We proceed exactly as in Pb. 6.17.

$$P(T) := P_c \cdot \exp \left[ \frac{A \cdot \tau(T) + B \cdot (\tau(T))^{1.5} + C \cdot (\tau(T))^3 + D \cdot (\tau(T))^6}{1 - \tau(T)} \right]$$

$$T := 230.703 \cdot K \quad \frac{d}{dT} P(T) = 4.428 \frac{\text{kPa}}{K} \quad dPdT := 4.428124 \cdot \frac{\text{kPa}}{K}$$

$$P := 1 \cdot \text{bar} \quad P_r := \frac{P}{P_c} \quad P_r = 0.024 \quad T_r := \frac{T}{T_c} \quad T_r = 0.624$$

$$B_0 := 0.083 - \frac{0.422}{T_r^{1.6}} \quad B_0 = -0.815 \quad B_1 := 0.139 - \frac{0.172}{T_r^{4.2}} \quad B_1 = -1.109$$

$$V_{\text{vap}} := \frac{R \cdot T}{P} \cdot \left[ 1 + (B_0 + \omega \cdot B_1) \cdot \frac{P_r}{T_r} \right] \quad V_{\text{liq}} := V_c \cdot Z_c \left[ (T_r)^{-\frac{2}{7}} \right]$$

$$V_{\text{vap}} = 1.847 \times 10^4 \frac{\text{cm}^3}{\text{mol}}$$

$$V_{\text{liq}} = 75.546 \frac{\text{cm}^3}{\text{mol}}$$

$$\Delta H_{\text{lv}} := T \cdot (V_{\text{vap}} - V_{\text{liq}}) \cdot dPdT \quad \Delta H_{\text{lv}} = 1.879 \times 10^4 \frac{\text{J}}{\text{mol}}$$

**ENERGY BALANCE:** For the throttling process there is no enthalpy change. The calculational path from the initial state to the final is made up of the following steps:

- (1) Transform the initial gas into an ideal gas at the initial T & P.
- (2) Carry out the temperature and pressure changes to the final T & P in the ideal-gas state.
- (3) Transform the ideal gas into a real gas at the final T & P.
- (4) Partially condense the gas at the final T & P.

The sum of the enthalpy changes for these steps is set equal to zero, and the resulting equation is solved for the fraction of the stream that is liquid.

For Step (1), use the generalized correlation of Tables E.7 & E.8, and let

$$r_0 = \left( \frac{H^R}{R \cdot T_c} \right)^0 \quad \text{and} \quad r_1 = \left( \frac{H^R}{R \cdot T_c} \right)^1$$

$$T_1 := 370 \cdot \text{K}$$

$$P_1 := 200 \cdot \text{bar}$$

$$T_r := \frac{T_1}{T_c}$$

$$T_r = 1.001$$

$$P_r := \frac{P_1}{P_c}$$

$$P_r = 4.708$$

By interpolation, find:

$$r_0 := -3.773$$

$$r_1 := -3.568$$

By Eq. (6.85)

$$\Delta H_1 := -R \cdot T_c \cdot (r_0 + r_1 \cdot \omega)$$

$$\Delta H_1 = 1.327 \times 10^4 \frac{\text{J}}{\text{mol}}$$

For Step (2) the enthalpy change is given by Eq. (6.95), for which

$$\Delta H_2 := R \cdot \left( \int_{T_1, T} \text{CPH}(T_1, T, 1.213, 28.785 \cdot 10^{-3}, -8.824 \cdot 10^{-6}, 0.0) \right)$$

$$\Delta H_2 = -1.048 \times 10^4 \frac{\text{J}}{\text{mol}}$$

For Step (3) the enthalpy change is given by Eq. (6.87), for which

$$T_r := \frac{230.703 \cdot \text{K}}{T_c}$$

$$T_r = 0.6239$$

$$P_r := \frac{1 \cdot \text{bar}}{P_c}$$

$$P_r = 0.0235$$

$$\Delta H_3 := R \cdot T_c \cdot \text{HRB}(T_r, P_r)$$

For Step (4),

$$\Delta H_4 = -x \cdot H_{lv}$$

$$\Delta H_3 = -232.729 \frac{\text{J}}{\text{mol}}$$

For the process,

$$\Delta H_1 + \Delta H_2 + \Delta H_3 - x \cdot \Delta H_{lv} = 0$$

$$x := \frac{\Delta H_1 + \Delta H_2 + \Delta H_3}{\Delta H_{lv}}$$

$$x = 0.136$$

Ans.

6.53 For 1,3-butadiene:  $\omega := 0.190$

$$T_c := 425.2 \cdot \text{K}$$

$$P_c := 42.77 \cdot \text{bar}$$

$$Z_c := 0.267$$

$$V_c := 220.4 \cdot \frac{\text{cm}^3}{\text{mol}}$$

$$T_n := 268.7 \cdot \text{K}$$

$$T := 380 \cdot \text{K}$$

$$P := 1919.4 \cdot \text{kPa}$$

$$T_0 := 273.15 \cdot \text{K}$$

$$P_0 := 101.33 \cdot \text{kPa}$$

$$T_r := \frac{T}{T_c}$$

$$T_r = 0.894$$

$$P_r := \frac{P}{P_c}$$

$$P_r = 0.449$$



Use Lee/Kesler correlation. **HOWEVER**, the values for a saturated vapor lie on the very edge of the vapor region, and some adjacent numbers are for the liquid phase. These must **NOT** be used for interpolation. Rather, **EXTRAPOLATIONS** must be made from the vapor side. There may be some choice in how this is done, but the following values are as good as any:

$$Z_0 := 0.7442 \quad Z_1 := -0.1366 \quad Z := Z_0 + \omega \cdot Z_1 \quad Z = 0.718$$

$$V_{\text{vap}} := \frac{Z \cdot R \cdot T}{P} \quad V_{\text{vap}} = 1182.2 \frac{\text{cm}^3}{\text{mol}} \quad \text{Ans.}$$

$$H_{R0} := -0.689 \cdot R \cdot T_c \quad H_{R1} := -0.892 \cdot R \cdot T_c$$

$$H_{R0} = -2.436 \times 10^3 \frac{\text{J}}{\text{mol}} \quad H_{R1} = -3.153 \times 10^3 \frac{\text{J}}{\text{mol}}$$

$$S_{R0} := -0.540 \cdot R \quad S_{R1} := -0.888 \cdot R$$

$$S_{R0} = -4.49 \frac{\text{J}}{\text{mol} \cdot \text{K}} \quad S_{R1} = -7.383 \frac{\text{J}}{\text{mol} \cdot \text{K}}$$

$$H_R := H_{R0} + \omega \cdot H_{R1} \quad S_R := S_{R0} + \omega \cdot S_{R1}$$

$$H_R = -3.035 \times 10^3 \frac{\text{J}}{\text{mol}} \quad S_R = -5.892 \frac{\text{J}}{\text{mol} \cdot \text{K}}$$

$$H_{\text{vap}} := R \cdot \text{ICPH}(T_0, T, 2.734, 26.786 \cdot 10^{-3}, -8.882 \cdot 10^{-6}, 0.0) + H_R$$

$$S_{\text{vap}} := R \cdot \left( \text{ICPS}(T_0, T, 2.734, 26.786 \cdot 10^{-3}, -8.882 \cdot 10^{-6}, 0.0) - \ln\left(\frac{P}{P_0}\right) \right) + S_R$$

$$H_{\text{vap}} = 6315.9 \frac{\text{J}}{\text{mol}} \quad \text{Ans.} \quad S_{\text{vap}} = -1.624 \frac{\text{J}}{\text{mol} \cdot \text{K}} \quad \text{Ans.}$$

For saturated vapor, by Eqs. (3.63) & (4.12)

$$V_{\text{liq}} := V_c \cdot Z_c \left[ \left( 1 - T_r \right)^{\frac{2}{7}} \right] \quad V_{\text{liq}} = 109.89 \frac{\text{cm}^3}{\text{mol}} \quad \text{Ans.}$$

$$\Delta H_n := R \cdot T_n \cdot \left[ \frac{1.092 \cdot \left( \ln \left( \frac{P_c}{\text{bar}} \right) - 1.013 \right)}{0.930 - \frac{T_n}{T_c}} \right] \quad \Delta H_n = 22449 \frac{\text{J}}{\text{mol}}$$

By Eq. (4.13) 
$$\Delta H := \Delta H_n \cdot \left( \frac{1 - T_r}{1 - \frac{T_n}{T_c}} \right)^{0.38} \quad \Delta H = 14003 \frac{\text{J}}{\text{mol}}$$

$$H_{\text{liq}} := H_{\text{vap}} - \Delta H \quad H_{\text{liq}} = -7687.4 \frac{\text{J}}{\text{mol}} \quad \text{Ans.}$$

$$S_{\text{liq}} := S_{\text{vap}} - \frac{\Delta H}{T} \quad S_{\text{liq}} = -38.475 \frac{\text{J}}{\text{mol} \cdot \text{K}} \quad \text{Ans.}$$

6.54 For n-butane:

$$\omega := 0.200$$

$$T_c := 425.1 \cdot \text{K}$$

$$P_c := 37.96 \cdot \text{bar}$$

$$Z_c := 0.274$$

$$V_c := 255 \cdot \frac{\text{cm}^3}{\text{mol}}$$

$$T_n := 272.7 \cdot \text{K}$$

$$T := 370 \cdot \text{K}$$

$$P := 1435 \cdot \text{kPa}$$

$$T_0 := 273.15 \cdot \text{K}$$

$$P_0 := 101.33 \cdot \text{kPa}$$

$$T_r := \frac{T}{T_c}$$

$$T_r = 0.87$$

$$P_r := \frac{P}{P_c}$$

$$P_r = 0.378$$

Use Lee/Kesler correlation. **HOWEVER**, the values for a saturated vapor lie on the very edge of the vapor region, and some adjacent numbers are for the liquid phase. These must NOT be used for interpolation. Rather, **EXTRAPOLATIONS** must be made from the vapor side. There may be some choice in how this is done, but the following values are as good as any:

$$Z_0 := 0.7692$$

$$Z_1 := -0.1372$$

$$Z := Z_0 + \omega \cdot Z_1$$

$$Z = 0.742$$

$$V := \frac{Z \cdot R \cdot T}{P}$$

$$V = 1590.1 \frac{\text{cm}^3}{\text{mol}}$$

Ans.

$$H_{R0} := -0.607 \cdot R \cdot T_c$$

$$H_{R1} := -0.831 \cdot R \cdot T_c$$

$$H_{R0} = -2.145 \times 10^3 \frac{\text{J}}{\text{mol}}$$

$$H_{R1} = -2.937 \times 10^3 \frac{\text{J}}{\text{mol}}$$

$$S_{R0} := -0.485 \cdot R$$

$$S_{R0} = -4.032 \frac{\text{J}}{\text{mol} \cdot \text{K}}$$

$$S_{R1} := -0.835 \cdot R$$

$$S_{R1} = -6.942 \frac{\text{J}}{\text{mol} \cdot \text{K}}$$

$$H_R := H_{R0} + \omega \cdot H_{R1}$$

$$H_R = -2.733 \times 10^3 \frac{\text{J}}{\text{mol}}$$

$$S_R := S_{R0} + \omega \cdot S_{R1}$$

$$S_R = -5.421 \frac{\text{J}}{\text{mol} \cdot \text{K}}$$

$$H_{\text{vap}} := R \cdot \text{ICPH}(T_0, T, 1.935, 36.915 \cdot 10^{-3}, -11.402 \cdot 10^{-6}, 0.0) + H_R$$

$$S_{\text{vap}} := R \cdot \left( \text{ICPS}(T_0, T, 1.935, 36.915 \cdot 10^{-3}, -11.402 \cdot 10^{-6}, 0.0) - \ln\left(\frac{P}{P_0}\right) \right) + S_R$$

$$H_{\text{vap}} = 7427.4 \frac{\text{J}}{\text{mol}} \quad \text{Ans.}$$

$$S_{\text{vap}} = 4.197 \frac{\text{J}}{\text{mol} \cdot \text{K}} \quad \text{Ans.}$$

For saturated vapor, by Eqs. (3.72) & (4.12)

$$V_{\text{liq}} := V_c \cdot Z_c \left[ (1 - T_r)^{2/7} \right]$$

$$V_{\text{liq}} = 123.86 \frac{\text{cm}^3}{\text{mol}} \quad \text{Ans.}$$

$$\Delta H_n := R \cdot T_n \cdot \left[ \frac{1.092 \cdot \left( \ln\left(\frac{P_c}{\text{bar}}\right) - 1.013 \right)}{0.930 - \frac{T_n}{T_c}} \right]$$

$$\Delta H_n = 22514 \frac{\text{J}}{\text{mol}}$$

By Eq. (4.13)

$$\Delta H := \Delta H_n \cdot \left( \frac{1 - T_r}{1 - \frac{T_n}{T_c}} \right)^{0.38}$$

$$\Delta H = 15295.2 \frac{\text{J}}{\text{mol}}$$

$$H_{\text{liq}} := H_{\text{vap}} - \Delta H$$

$$H_{\text{liq}} = -7867.8 \frac{\text{J}}{\text{mol}} \quad \text{Ans.}$$

$$S_{\text{liq}} := S_{\text{vap}} - \frac{\Delta H}{T}$$

$$S_{\text{liq}} = -37.141 \frac{\text{J}}{\text{mol} \cdot \text{K}} \quad \text{Ans.}$$

**6.55 Under the stated conditions the worst possible cycling of demand can be represented as follows:**

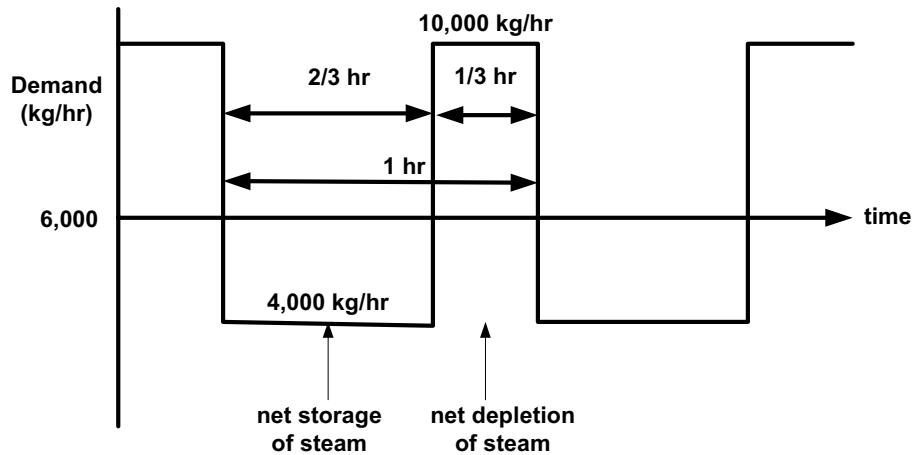

**This situation is also represented by the equation:**

$$4000\theta + 10000 \cdot (1 - \theta) = 6000$$

where  $\theta$  = time of storage liquid

Solution gives  $\theta := \frac{2}{3}$  hr

The steam stored during this leg is:  $m_{\text{prime}} := \left( 6000 \frac{\text{kg}}{\text{hr}} - 4000 \frac{\text{kg}}{\text{hr}} \right) \cdot \theta$

$$m_{\text{prime}} = 1333.3 \text{ kg}$$

**We consider this storage leg, and for this process of steam addition to a tank the equation developed in Problem 6-74 is applicable:**

$$m_2 = \frac{m_1 \cdot \left( H_{\text{prime}} - H_1 - V_{\text{tank}} \cdot \left( P_2 - P_1 - \frac{H_{\text{fg}2}}{V_{\text{fg}2}} \right) \right)}{H_{\text{prime}} - H_{\text{f}2} + V_{\text{f}2} \cdot \frac{H_{\text{fg}2}}{V_{\text{fg}2}}}$$

**We can replace  $V_{\text{tank}}$  by  $m_2 V_2$ , and rearrange to get**

$$\frac{m_2}{m_1} \cdot \left[ H_{\text{prime}} - H_{\text{f}2} + V_{\text{f}2} \cdot \frac{H_{\text{fg}2}}{V_{\text{fg}2}} + V_2 \cdot \left( P_2 - P_1 - \frac{H_{\text{fg}2}}{V_{\text{fg}2}} \right) \right] = H_{\text{prime}} - H_1$$

**However  $M_1 \cdot v_1 = m_2 \cdot V_2 = V_{\text{tank}}$  and therefore  $\frac{m_2}{m_1} = \frac{V_1}{V_2}$  Eq. (A)**

**Making this substitution and rearranging we get**

$$\frac{H_{\text{prime}} - H_{f2} + V_{f2} \cdot \frac{H_{fg2}}{V_{fg2}}}{V_2} + P_2 - P_1 - \frac{H_{fg2}}{V_{fg2}} = \frac{H_{\text{prime}} - H_1}{V_1}$$

**In this equation we can determine from the given information everything except  $H_{\text{prime}}$  and  $V_{\text{prime}}$ . These quantities are expressed by**

$$H_1 = H_{f1} + x_1 \cdot H_{fg1} \quad \text{and} \quad V_1 = V_{f1} + x_1 \cdot V_{fg1}$$

**Therefore our equation becomes (with  $H_{\text{prime}} = H_{g2}$ )**

$$\frac{(H_{g2} - H_{f2} + V_{f2} \cdot \left(\frac{H_{fg2}}{V_{fg2}}\right))}{V_2} + P_2 - P_1 - \frac{H_{fg2}}{V_{fg2}} = \frac{H_{g2} - H_{f1} - x_1 \cdot H_{fg1}}{V_{f1} + x_1 \cdot V_{fg1}} \quad \text{Eq. (B)}$$

**In this equation only  $x_1$  is unknown and we can solve for it as follows. First we need  $V_2$ :**

**From the given information we can write:**

$$0.95V_2 = (1 - x_2) \cdot V_{f2} \quad 0.05V_2 = x_2 \cdot V_{g2}$$

$$\text{therefore} \quad 19 = \frac{(1 - x_2) \cdot V_{f2}}{x_2 \cdot V_{g2}} \quad \text{or} \quad x_2 = \frac{V_{f2}}{19V_{g2} + V_{f2}}$$

$$\text{Then} \quad V_2 = \frac{V_{g2}}{0.05} \cdot \left( \frac{V_{f2}}{19V_{g2} + V_{f2}} \right) = \frac{20}{\frac{19}{V_{f2}} + \frac{1}{V_{g2}}} \quad \text{Eq. (C)}$$

**Now we need property values:**

**Initial state in accumulator is wet steam at 700 kPa.**

$$P_1 := 700 \text{ kPa}$$

**We find from the steam tables**

$$H_{f1} := 697.061 \frac{\text{kJ}}{\text{kg}} \quad H_{g1} := 2762.0 \frac{\text{kJ}}{\text{kg}} \quad H_{fg1} := H_{g1} - H_{f1} \quad H_{fg1} = 2064.939 \frac{\text{kJ}}{\text{kg}}$$

$$V_{f1} := 1.108 \frac{\text{cm}^3}{\text{gm}} \quad V_{g1} := 272.68 \frac{\text{cm}^3}{\text{gm}} \quad V_{fg1} := V_{g1} - V_{f1} \quad V_{fg1} = 271.572 \frac{\text{cm}^3}{\text{gm}}$$

Final state in accumulator is wet steam at 1000 kPa.  $P_2 := 1000 \text{ kPa}$

From the steam tables

$$H_{f2} := 762.605 \frac{\text{kJ}}{\text{kg}} \quad H_{g2} := 2776.2 \frac{\text{kJ}}{\text{kg}} \quad H_{fg2} := H_{g2} - H_{f2} \quad H_{fg2} = 2013.595 \frac{\text{kJ}}{\text{kg}}$$

$$V_{f2} := 1.127 \frac{\text{cm}^3}{\text{gm}} \quad V_{g2} := 194.29 \frac{\text{cm}^3}{\text{gm}} \quad V_{fg2} := V_{g2} - V_{f2} \quad V_{fg2} = 193.163 \frac{\text{cm}^3}{\text{gm}}$$

Solve Eq. (C) for  $V_2$

$$V_2 := \frac{V_{g2}}{0.05} \cdot \left( \frac{V_{f2}}{19V_{g2} + V_{f2}} \right) \quad V_2 = 1.18595 \times 10^{-3} \frac{\text{m}^3}{\text{kg}}$$

Next solve Eq. (B) for  $x_1$  **Guess:**  $x_1 := 0.1$

Given

$$\frac{(H_{g2} - H_{f2}) + V_{f2} \cdot \left( \frac{H_{fg2}}{V_{fg2}} \right)}{V_2} + P_2 - P_1 - \frac{H_{fg2}}{V_{fg2}} = \frac{H_{g2} - H_{f1} - x_1 \cdot H_{fg1}}{V_{f1} + x_1 \cdot V_{fg1}}$$

$$x_1 := \text{Find}(x_1) \quad x_1 = 4.279 \times 10^{-4}$$

Thus  $V_1 := V_{f1} + x_1 \cdot V_{fg1}$   $V_1 = 1.22419 \frac{\text{cm}^3}{\text{gm}}$

Eq. (A) gives  $\frac{m_2}{m_1} = \frac{V_1}{V_2}$  and  $m_{\text{prime}} = m_2 - m_1 = 2667 \text{ kg}$

Solve for  $m_1$  and  $m_2$  using a Mathcad Solve Block:

**Guess:**  $m_1 := \frac{m_{\text{prime}}}{2}$   $m_2 := m_1$

Given  $\frac{m_2}{m_1} = \frac{V_1}{V_2}$   $m_2 - m_1 = 2667 \text{ lb}$   $\begin{pmatrix} m_1 \\ m_2 \end{pmatrix} := \text{Find}(m_1, m_2)$

$$m_1 = 3.752 \times 10^4 \text{ kg}$$

$$m_2 = 3.873 \times 10^4 \text{ kg}$$

Finally, find the tank volume  $V_{\text{tank}} := m_2 \cdot V_2$   $V_{\text{tank}} = 45.9 \text{ m}^3$  Ans.

Note that just to store 1333.3 kg of saturated vapor at 1000 kPa would require a volume of:

$$1333.3 \text{ kg} \cdot V_{g2} = 259 \text{ m}^3$$

One can work this problem very simply and almost correctly by ignoring the vapor present. By first equation of problem 3-15

$$\frac{m_2}{m_1} = \frac{H_{\text{prime}} - U_1}{H_{\text{prime}} - U_2} = \frac{H_{\text{prime}} - U_{f1}}{H_{\text{prime}} - U_{f2}} = \frac{H_{\text{prime}} - H_{f1}}{H_{\text{prime}} - H_{f2}}$$

$$H_{\text{prime}} := H_{g2} \quad H_{\text{prime}} = 2.776 \times 10^3 \frac{\text{kJ}}{\text{kg}}$$

Given

$$\frac{m_2}{m_1} = \frac{H_{\text{prime}} - H_{f1}}{H_{\text{prime}} - H_{f2}} \quad m_2 - m_1 = 2667 \text{ lb} \quad \begin{pmatrix} m_1 \\ m_2 \end{pmatrix} := \text{Find}(m_1, m_2)$$

$$m_2 = 3.837 \times 10^4 \text{ kg}$$

$$V := \frac{m_2 \cdot V_{f2}}{0.95} \quad V = 45.5 \text{ m}^3 \quad \text{Ans.}$$

6.56 Propylene:  $\omega := 0.140$   $T_c := 365.6 \cdot \text{K}$   $P_c := 46.65 \cdot \text{bar}$   
 $T := 400.15 \cdot \text{K}$   $P := 38 \cdot \text{bar}$   $P_0 := 1 \cdot \text{bar}$

The throttling process, occurring at constant enthalpy, may be split into two steps:

(1) Transform into an ideal gas at the initial conditions, evaluating property changes from a generalized correlation.

(2) Change T and P in the ideal-gas state to the final conditions, evaluating property changes by equations for an ideal gas.

Property changes for the two steps sum to the property change for the process. For the initial conditions:

$$T_r := \frac{T}{T_c}$$

$$T_r = 1.095$$

$$P_r := \frac{P}{P_c}$$

$$P_r = 0.815$$

**Step (1): Use the Lee/Kesler correlation, interpolate.**

$$H_0 := -0.863 \cdot R \cdot T_c$$

$$H_1 := -0.534 \cdot R \cdot T_c$$

$$H_R := H_0 + \omega \cdot H_1$$

$$H_0 = -2.623 \times 10^3 \frac{\text{J}}{\text{mol}}$$

$$H_1 = -1.623 \times 10^3 \frac{\text{J}}{\text{mol}}$$

$$H_R = -2.85 \times 10^3 \frac{\text{J}}{\text{mol}}$$

$$S_0 := -0.565 \cdot R$$

$$S_1 := -0.496 \cdot R$$

$$S_R := S_0 + \omega \cdot S_1$$

$$S_0 = -4.697 \frac{\text{J}}{\text{mol} \cdot \text{K}}$$

$$S_1 = -4.124 \frac{\text{J}}{\text{mol} \cdot \text{K}}$$

$$S_R = -5.275 \frac{\text{J}}{\text{mol} \cdot \text{K}}$$

**Step (2): For the heat capacity of propylene,**

$$A := 1.637$$

$$B := \frac{22.706 \cdot 10^{-3}}{\text{K}}$$

$$C := \frac{-6.915 \cdot 10^{-6}}{\text{K}^2}$$

**Solve energy balance for final T. See Eq. (4.7).**

$$\tau := 1 \quad (\text{guess}) \quad \text{Given}$$

$$H_R = R \cdot \left[ \left[ A \cdot \tau \cdot () - 1 + \frac{B}{2} \cdot \tau^2 \cdot ()^2 - 1 \right] + \frac{C}{3} \cdot \tau^3 \cdot ()^3 - 1 \right]$$

$$\tau := \text{Find}(\tau) \quad \tau = 0.908 \quad T_f := \tau \cdot T \quad T_f = 363.27 \text{ K} \quad \text{Ans.}$$

$$\Delta S_{\text{ig}} := R \cdot \left( \text{ICPS} \left( T, T_f, 1.637, 22.706 \cdot 10^{-3}, -6.915 \cdot 10^{-6}, 0.0 \right) - \ln \left( \frac{P_0}{P} \right) \right)$$

$$\Delta S_{\text{ig}} = 22.774 \frac{\text{J}}{\text{mol} \cdot \text{K}}$$

$$\Delta S := -S_R + S_{\text{ig}}$$

$$\Delta S = 28.048 \frac{\text{J}}{\text{mol} \cdot \text{K}} \quad \text{Ans.}$$



6.57 Propane:  $\omega := 0.152$   $T_c := 369.8 \cdot K$   $P_c := 42.48 \cdot \text{bar}$   
 $T := 423 \cdot K$   $P := 22 \cdot \text{bar}$   $P_0 := 1 \cdot \text{bar}$

The throttling process, occurring at constant enthalpy, may be split into two steps:

(1) Transform into an ideal gas at the initial conditions, evaluating property changes from a generalized correlation.

(2) Change T and P in the ideal-gas state to the final conditions, evaluating property changes by equations for an ideal gas. Property changes for the two steps sum to the property change for the process. For the initial conditions:

$$T_r := \frac{T}{T_c} \quad T_r = 1.144 \quad P_r := \frac{P}{P_c} \quad P_r = 0.518$$

Step (1): Use the generalized virial correlation

$$H_R := R \cdot T_c \cdot \text{HRB}(T_r, \phi_r, \quad H_R = -1.366 \times 10^3 \frac{\text{J}}{\text{mol}}$$

$$S_R := R \cdot \text{SRB}(T_r, \phi_r, \quad S_R = -2.284 \frac{\text{J}}{\text{mol} \cdot \text{K}}$$

Step (2): For the heat capacity of propane,

$$A := 1.213 \quad B := \frac{28.785 \cdot 10^{-3}}{K} \quad C := \frac{-8.824 \cdot 10^{-6}}{K^2}$$

Solve energy balance for final T. See Eq. (4.7).

$$\tau := 1 \quad (\text{guess}) \quad \text{Given}$$

$$H_R = R \cdot \left[ \left[ A \cdot T \cdot () - 1 + \frac{B}{2} \cdot T^2 \cdot ()^2 - 1 \right] + \frac{C}{3} \cdot T^3 \cdot ()^3 - 1 \right]$$

$$\tau := \text{Find}(\tau) \quad \tau = 0.967 \quad T_f := \tau \cdot T \quad T_f = 408.91 \text{ K} \quad \text{Ans.}$$

$$\Delta S_{\text{ig}} := R \cdot \left( \text{ICPS}(T, T_f, 1.213, 28.785 \cdot 10^{-3}, -8.824 \cdot 10^{-6}, 0.0) - \ln\left(\frac{P_0}{P}\right) \right)$$

$$\Delta S_{\text{ig}} = 22.415 \frac{\text{J}}{\text{mol} \cdot \text{K}}$$

$$\Delta S := -\Delta S_R + S_{\text{ig}} \quad \Delta S = 24.699 \frac{\text{J}}{\text{mol} \cdot \text{K}} \quad \text{Ans.}$$

6.58 For propane:

$$T_c := 369.8 \cdot K$$

$$P_c := 42.48 \cdot \text{bar}$$

$$\omega := 0.152$$

$$T := (100 + 273.15) \cdot K$$

$$T = 373.15 \text{ K}$$

$$P_0 := 1 \cdot \text{bar}$$

$$P := 10 \cdot \text{bar}$$

$$T_r := \frac{T}{T_c}$$

$$T_r = 1.009$$

$$P_r := \frac{P}{P_c}$$

$$P_r = 0.235$$

Assume ideal gas at initial conditions. Use virial correlation at final conditions.

$$\Delta H := R \cdot T_c \cdot \text{HRB}(T_r, \mathcal{B}_r,$$

$$\Delta H = -801.9 \frac{\text{J}}{\text{mol}}$$

Ans.

$$\Delta S := R \cdot \left( \text{SRB}(T_r, \mathcal{B}_r, - \ln\left(\frac{P}{P_0}\right)) \right)$$

$$\Delta S = -20.639 \frac{\text{J}}{\text{mol} \cdot \text{K}}$$

Ans.

6.59 H<sub>2</sub>S:

$$\omega := 0.094$$

$$T_c := 373.5 \cdot K$$

$$P_c := 89.63 \cdot \text{bar}$$

$$T_1 := 400 \cdot K$$

$$P_1 := 5 \cdot \text{bar}$$

$$T_2 := 600 \cdot K$$

$$P_2 := 25 \cdot \text{bar}$$

$$T_{r1} := \frac{T_1}{T_c}$$

$$P_{r1} := \frac{P_1}{P_c}$$

$$T_{r2} := \frac{T_2}{T_c}$$

$$P_{r2} := \frac{P_2}{P_c}$$

$$T_{r1} = 1.071$$

$$P_{r1} = 0.056$$

$$T_{r2} = 1.606$$

$$P_{r2} = 0.279$$

Use generalized virial-coefficient correlation for both sets of conditions.

Eqs. (6.91) & (6.92) are written

$$\Delta H := R \cdot \text{ICPH}(T_1, T_2, 3.931, 1.490 \cdot 10^{-3}, 0.0, -0.232 \cdot 10^5) \dots$$

$$+ R \cdot T_c \cdot (\text{HRB}(T_{r2}, \mathcal{B}_{r2}, - \text{HRB}(T_{r1}, \mathcal{B}_{r1},$$

$$\Delta S := R \cdot \left( \text{ICPS}(T_1, T_2, 3.931, 1.490 \cdot 10^{-3}, 0.0, -0.232 \cdot 10^5) - \ln\left(\frac{P_2}{P_1}\right) \right) \dots$$

$$+ R \cdot (\text{SRB}(T_{r2}, \mathcal{B}_{r2}, - \text{SRB}(T_{r1}, \mathcal{B}_{r1},$$

$$\Delta H = 7407.3 \frac{\text{J}}{\text{mol}}$$

$$\Delta S = 1.828 \frac{\text{J}}{\text{mol} \cdot \text{K}}$$

Ans.

6.60 Carbon dioxide:  $\omega := 0.224$   $T_c := 304.2 \cdot \text{K}$   $P_c := 73.83 \cdot \text{bar}$   
 $T := 318.15 \cdot \text{K}$   $P := 1600 \cdot \text{kPa}$   $P_0 := 101.33 \cdot \text{kPa}$

Throttling process, constant enthalpy, may be split into two steps:

(1) Transform to ideal gas at initial conditions, generalized correlation for property changes.

(2) Change T and P of ideal gas to final T & P.

Property changes by equations for an ideal gas.

Assume ideal gas at final T & P. Sum property changes for the process.

For the initial T & P:

$$T_r := \frac{T}{T_c} \quad T_r = 1.046 \quad P_r := \frac{P}{P_c} \quad P_r = 0.217$$

Step (1): Use the generalized virial correlation

$$H_R := R \cdot T_c \cdot \text{HRB}(T_r, P_r, \omega), \quad H_R = -587.999 \frac{\text{J}}{\text{mol}}$$

$$S_R := R \cdot \text{SRB}(T_r, P_r, \omega), \quad S_R = -1.313 \frac{\text{J}}{\text{mol} \cdot \text{K}}$$

Step (2): For the heat capacity of carbon dioxide,

$$A := 5.457 \quad B := \frac{1.045 \cdot 10^{-3}}{\text{K}} \quad D := -1.157 \cdot 10^5 \cdot \text{K}^2$$

Solve energy balance for final T. See Eq. (4.7).

$$\tau := 1 \quad (\text{guess}) \quad \text{Given}$$

$$H_R = R \cdot \left[ A \cdot T \cdot \left( \frac{T}{T_c} \right)^{-1} + \frac{B}{2} \cdot T^2 \cdot \left( \frac{T}{T_c} \right)^{-2} - 1 + \frac{D}{T} \cdot \left( \frac{\tau - 1}{\tau} \right) \right]$$

$$\tau := \text{Find}(\tau) \quad \tau = 0.951 \quad T_f := \tau \cdot T \quad T_f = 302.71 \text{ K} \quad \text{Ans.}$$

$$\Delta S_{\text{ig}} := R \cdot \left( \text{ICPS}(T, T_f, 5.457, 1.045 \cdot 10^{-3}, 0.0, -1.157 \cdot 10^5) - \ln\left(\frac{P_0}{P}\right) \right)$$

$$\Delta S_{\text{ig}} = 21.047 \frac{\text{J}}{\text{mol} \cdot \text{K}}$$

$$\Delta S := -S_R + S_{\text{ig}} \quad \Delta S = 22.36 \frac{\text{J}}{\text{mol} \cdot \text{K}} \quad \text{Ans.}$$

6.61

$T_0 := 523.15 \cdot \text{K}$

$P_0 := 3800 \cdot \text{kPa}$

$P := 120 \cdot \text{kPa}$

$$\Delta S := 0 \cdot \frac{\text{J}}{\text{mol} \cdot \text{K}}$$

**For the heat capacity of ethylene:**

$A := 1.424$

$B := \frac{14.394 \cdot 10^{-3}}{\text{K}}$

$C := \frac{-4.392 \cdot 10^{-6}}{\text{K}^2}$

**(a) For the entropy change of an ideal gas, combine Eqs. (5.14) & (5.15) with  $D = 0$ :**

$\tau := 0.4 \quad (\text{guess}) \quad \text{Given}$

$$\Delta S = R \cdot \left[ A \cdot \ln(\tau) + \left[ B \cdot T_0 + C \cdot T_0^2 \cdot \left( \frac{\tau + 1}{2} \right) \right] \cdot (\tau - 1) - \ln\left( \frac{P}{P_0} \right) \right]$$

$\tau := \text{Find}(\tau) \quad \tau = 0.589 \quad T_f := \tau \cdot T_0 \quad T_f = 308.19 \text{ K} \quad \text{Ans.}$

$$\Delta H_{\text{ig}} := R \cdot \text{ICPH}(T_0, T_f, 1.424, 14.394 \cdot 10^{-3}, -4.392 \cdot 10^{-6}, 0.0)$$

$$\Delta H_{\text{ig}} = -1.185 \times 10^4 \frac{\text{J}}{\text{mol}}$$

$W_s := \Delta H_{\text{ig}} \quad W_s = -11852 \frac{\text{J}}{\text{mol}} \quad \text{Ans.}$

**(b) Ethylene:**

$\omega := 0.087$

$T_c := 282.3 \cdot \text{K}$

$P_c := 50.40 \cdot \text{bar}$

$T_{r0} := \frac{T_0}{T_c}$

$T_{r0} = 1.85317$

$P_{r0} := \frac{P_0}{P_c}$

$P_{r0} = 0.75397$

**At final conditions as calculated in (a)**

$T_r := \frac{T}{T_c}$

$T_r = 1.12699$

$P_r := \frac{P}{P_c}$

$P_r = 0.02381$

**Use virial-coefficient correlation.****The entropy change is now given by Eq. (6.92):**

$\tau := 0.5 \quad (\text{guess}) \quad \text{Given}$

$$\Delta S = R \cdot \left[ A \cdot \ln(\tau) + \left[ B \cdot T_0 + C \cdot T_0^2 \cdot \left( \frac{\tau + 1}{2} \right) \right] \cdot (\tau - 1) - \ln\left(\frac{P}{P_0}\right) \dots \right. \\ \left. + \text{SRB}\left(\frac{\tau \cdot T_0}{T_c}, \mathfrak{B}_r, \right) - \text{SRB}(T_{r0}, \mathfrak{B}_{r0}, \right) \right]$$

$$\tau := \text{Find}(\tau) \quad T := \tau \cdot T_0 \quad T = 303.11 \text{ K} \quad \text{Ans.}$$

$$T_r := \frac{T}{T_c} \quad T_r = 1.074$$

The work is given by Eq. (6.91):

$$\Delta H_{ig} := R \cdot \text{ICPH}(T_0, T, 1.424, 14.394 \cdot 10^{-3}, -4.392 \cdot 10^{-6}, 0.0)$$

$$\Delta H_{ig} = -1.208 \times 10^4 \frac{\text{J}}{\text{mol}}$$

$$W_s := \Delta H_{ig} + R \cdot T_c \cdot (\text{HRB}(T_r, \mathfrak{B}_r, \quad - \text{HRB}(T_{r0}, \mathfrak{B}_{r0},$$

$$W_s = -11567 \frac{\text{J}}{\text{mol}} \quad \text{Ans.}$$

6.62  $T_0 := 493.15 \text{ K}$

$P_0 := 30 \text{ bar}$

$P := 2.6 \text{ bar}$

$$\Delta S := 0 \cdot \frac{\text{J}}{\text{mol} \cdot \text{K}}$$

For the heat capacity of ethane:

$$A := 1.131 \quad B := \frac{19.225 \cdot 10^{-3}}{\text{K}} \quad C := \frac{-5.561 \cdot 10^{-6}}{\text{K}^2}$$

(a) For the entropy change of an ideal gas, combine Eqs. (5.14) & (5.15) with  $D = 0$ :

$$\tau := 0.4 \quad (\text{guess}) \quad \text{Given}$$

$$\Delta S = R \cdot \left[ A \cdot \ln(\tau) + \left[ B \cdot T_0 + C \cdot T_0^2 \cdot \left( \frac{\tau + 1}{2} \right) \right] \cdot (\tau - 1) - \ln\left(\frac{P}{P_0}\right) \right]$$

$$\tau := \text{Find}(\tau) \quad \tau = 0.745 \quad T := \tau \cdot T_0 \quad T = 367.59 \text{ K} \quad \text{Ans.}$$

$$\Delta H_{ig} := R \cdot \text{ICPH}(T_0, T, 1.131, 19.225 \cdot 10^{-3}, -5.561 \cdot 10^{-6}, 0.0)$$

$$\Delta H_{ig} = -8.735 \times 10^3 \frac{\text{J}}{\text{mol}}$$

$$W_s := \Delta H_{ig} \quad W_s = -8735 \frac{\text{J}}{\text{mol}} \quad \text{Ans.}$$

(b) Ethane:  $\omega := 0.100$   $T_c := 305.3 \cdot \text{K}$   $P_c := 48.72 \cdot \text{bar}$

$$T_{r0} := \frac{T_0}{T_c} \quad T_{r0} = 1.6153 \quad P_{r0} := \frac{P_0}{P_c} \quad P_{r0} = 0.61576$$

At final conditions as calculated in (a)

$$T_r(T) := \frac{T}{T_c} \quad T_r(T) = 1.20404 \quad P_r := \frac{P}{P_c} \quad P_r = 0.05337$$

Use virial-coefficient correlation.

The entropy change is now given by Eq. (6.83):

$$\tau := 0.5 \quad (\text{guess}) \quad \text{Given}$$

$$\Delta S = R \cdot \left[ A \cdot \ln(\tau) + \left[ B \cdot T_0 + C \cdot T_0^2 \cdot \left( \frac{\tau + 1}{2} \right) \right] \cdot (\tau - 1) - \ln\left(\frac{P}{P_0}\right) \dots \right]$$

$$\left[ + \text{SRB}\left(\frac{\tau \cdot T_0}{T_c}, \mathcal{B}_r, \right) - \text{SRB}(T_{r0}, \mathcal{B}_{r0}, \right) \right]$$

$$\tau := \text{Find}(\tau) \quad T := \tau \cdot T_0 \quad T = 362.73 \text{ K} \quad \text{Ans.}$$

$$T_r := \frac{T}{T_c} \quad T_r = 1.188$$

The work is given by Eq. (6.91):

$$\Delta H_{ig} := R \cdot \text{ICPH}(T_0, T, 1.131, 19.225 \cdot 10^{-3}, -5.561 \cdot 10^{-6}, 0.0)$$

$$\Delta H_{ig} = -9.034 \times 10^3 \frac{\text{J}}{\text{mol}}$$

$$W_s := \Delta H_{ig} + R \cdot T_c \cdot (\text{HRB}(T_r, \mathcal{B}_r, ) - \text{HRB}(T_{r0}, \mathcal{B}_{r0}, ))$$

$$W_s = -8476 \frac{\text{J}}{\text{mol}} \quad \text{Ans.}$$

6.63 n-Butane:  $\omega := 0.200$   $T_c := 425.1 \cdot K$   $P_c := 37.96 \cdot \text{bar}$   
 $T_0 := 323.15 \cdot K$   $P_0 := 1 \cdot \text{bar}$   $P := 7.8 \cdot \text{bar}$

$$\Delta S := 0 \cdot \frac{J}{\text{mol} \cdot K}$$

For the heat capacity of n-butane:

$$A := 1.935 \quad B := \frac{36.915 \cdot 10^{-3}}{K} \quad C := \frac{-11.402 \cdot 10^{-6}}{K^2}$$

$$T_{r0} := \frac{T_0}{T_c} \quad T_{r0} = 0.76017 \quad P_{r0} := \frac{P_0}{P_c} \quad P_{r0} = 0.02634$$

$$P_r := \frac{P}{P_c} \quad P_r = 0.205$$

$$\text{HRB}(T_{r0}, \mathcal{B}_{r0}) = -0.05679 \quad \text{HRB}_0 := -0.05679$$

The entropy change is given by Eq. (6.92) combined with Eq. (5.15) with  $D = 0$ :

(guess)  $\tau := 0.4$

$$\text{Given } \Delta S = R \cdot \left[ A \cdot \ln(\tau) + \left[ B \cdot T_0 + C \cdot T_0^2 \cdot \left( \frac{\tau + 1}{2} \right) \right] \cdot (\tau - 1) - \ln\left(\frac{P}{P_0}\right) \dots \right]$$

$$\left[ + \text{SRB}\left(\frac{T_0 \cdot \tau}{T_c}, \mathcal{B}_r\right) - \text{SRB}(T_{r0}, \mathcal{B}_{r0}) \right]$$

$$\tau := \text{Find}(\tau) \quad \tau = 1.18 \quad T := \tau \cdot T_0 \quad T = 381.43 K \quad \text{Ans.}$$

$$T_r := \frac{T}{T_c} \quad T_r = 0.89726$$

The work is given by Eq. (6.91):

$$\Delta H_{ig} := R \cdot \text{ICPH}(T_0, T, 1.935, 36.915 \cdot 10^{-3}, -11.402 \cdot 10^{-6}, 0.0)$$

$$\Delta H_{ig} = 6.551 \times 10^3 \frac{J}{\text{mol}}$$

$$W_s := \Delta H_{ig} + R \cdot T_c \cdot (\text{HRB}(T_r, \mathcal{B}_r) - \text{HRB}(T_{r0}, \mathcal{B}_{r0}))$$

$$W_s = 5680 \frac{J}{\text{mol}} \quad \text{Ans.}$$

- 6.64 The maximum work results when the 1 kg of steam is reduced in a completely reversible process to the conditions of the surroundings, where it is liquid at 300 K (26.85 degC). This is the ideal work.

From Table F.2 for the initial state of superheated steam:

$$H_1 := 3344.6 \cdot \frac{\text{kJ}}{\text{kg}}$$

$$S_1 := 7.0854 \cdot \frac{\text{kJ}}{\text{kg} \cdot \text{K}}$$

From Table F.1, the state of sat. liquid at 300 K is essentially correct:

$$H_2 := 112.5 \cdot \frac{\text{kJ}}{\text{kg}}$$

$$S_2 := 0.3928 \cdot \frac{\text{kJ}}{\text{kg} \cdot \text{K}}$$

$$T_\sigma := 300 \cdot \text{K}$$

By Eq. (5.27),

$$W_{\text{ideal}} := (H_2 - H_1 - T_\sigma \cdot (S_2 - S_1))$$

$$W_{\text{ideal}} = -1224.3 \frac{\text{kJ}}{\text{kg}} \quad \text{Ans.}$$

- 6.65 Sat. liquid at 325 K (51.85 degC), Table F.1:

$$H_{\text{liq}} := 217.0 \cdot \frac{\text{kJ}}{\text{kg}}$$

$$S_{\text{liq}} := 0.7274 \cdot \frac{\text{kJ}}{\text{kg} \cdot \text{K}}$$

$$V_{\text{liq}} := 1.013 \cdot \frac{\text{cm}^3}{\text{gm}}$$

$$P_{\text{sat}} := 12.87 \cdot \text{kPa}$$

$$P_1 := 8000 \cdot \text{kPa}$$

$$T := 325 \cdot \text{K}$$

For the compressed liquid at 325 K and 8000 kPa, apply Eqs. (6.28) and (6.29) with

$$\beta := 460 \cdot 10^{-6} \cdot \text{K}^{-1}$$

$$H_1 := H_{\text{liq}} + V_{\text{liq}} \cdot (P_1 - P_{\text{sat}}) - \beta \cdot T \cdot (P_1 - P_{\text{sat}})$$

$$H_1 = 223.881 \frac{\text{kJ}}{\text{kg}}$$

$$S_1 := S_{\text{liq}} - \beta \cdot V_{\text{liq}} \cdot (P_1 - P_{\text{sat}})$$

$$S_1 = 0.724 \frac{\text{kJ}}{\text{kg} \cdot \text{K}}$$

For sat. vapor at 8000 kPa, from Table F.2:

$$H_2 := 2759.9 \cdot \frac{\text{kJ}}{\text{kg}}$$

$$S_2 := 5.7471 \cdot \frac{\text{kJ}}{\text{kg} \cdot \text{K}}$$

$$T_\sigma := 300 \cdot \text{K}$$

Heat added in boiler:  $Q := H_2 - H_1$

$$Q = 2536 \frac{\text{kJ}}{\text{kg}}$$

Maximum work from steam, by Eq. (5.27):

$$W_{\text{ideal}} := (H_1 - H_2 - T_\sigma \cdot (S_1 - S_2))$$

$$W_{\text{ideal}} = -1029 \frac{\text{kJ}}{\text{kg}}$$



**Work as a fraction of heat added:**

$$\text{Frac} := \frac{|W_{\text{ideal}}|}{Q} \quad \text{Frac} = 0.4058 \quad \text{Ans.}$$

**The heat not converted to work ends up in the surroundings.**

$$\dot{S}_{\text{G,surr}} := \frac{Q + W_{\text{ideal}}}{T_{\sigma}} \cdot 10 \cdot \frac{\text{kg}}{\text{sec}} \quad \dot{S}_{\text{G,surr}} = 50.234 \frac{\text{kW}}{\text{K}}$$

$$\dot{S}_{\text{G,system}} := (S_1 - S_2) \cdot 10 \cdot \frac{\text{kg}}{\text{sec}} \quad \dot{S}_{\text{G,system}} = -50.234 \frac{\text{kW}}{\text{K}}$$

**Obviously the TOTAL rate of entropy generation is zero. This is because the ideal work is for a completely reversible process.**

**6.66 Treat the furnace as a heat reservoir, for which**

$$\dot{Q}_{\text{dot}} := -2536 \cdot \frac{\text{kJ}}{\text{kg}} \cdot 10 \cdot \frac{\text{kg}}{\text{sec}} \quad T := (600 + 273.15) \cdot \text{K} \quad T = 873.15 \text{ K}$$

$$\dot{S}_{\text{dotG}} := \frac{\dot{Q}_{\text{dot}}}{T} + 50.234 \cdot \frac{\text{kW}}{\text{K}} \quad \dot{S}_{\text{dotG}} = 21.19 \frac{\text{kW}}{\text{K}} \quad \text{Ans.}$$

**By Eq. (5.34)**

$$T_{\sigma} := 300 \cdot \text{K} \quad \dot{W}_{\text{dotlost}} := T_{\sigma} \cdot \dot{S}_{\text{dotG}} \quad \dot{W}_{\text{dotlost}} = 6356.9 \text{ kW} \quad \text{Ans.}$$

**6.67 For sat. liquid water at 20 degC, Table F.1:**

$$H_1 := 83.86 \cdot \frac{\text{kJ}}{\text{kg}} \quad S_1 := 0.2963 \cdot \frac{\text{kJ}}{\text{kg} \cdot \text{K}}$$

**For sat. liquid water at 0 degC, Table F.1:**

$$H_0 := -0.04 \cdot \frac{\text{kJ}}{\text{kg}} \quad S_0 := 0.0000 \cdot \frac{\text{kJ}}{\text{kg} \cdot \text{K}}$$

**For ice at at 0 degC:**

$$H_2 := H_0 - 333.4 \cdot \frac{\text{kJ}}{\text{kg}} \quad S_2 := S_0 - \frac{333.4}{273.15} \cdot \frac{\text{kJ}}{\text{kg} \cdot \text{K}}$$

$$H_2 = -333.44 \frac{\text{kJ}}{\text{kg}}$$

$$S_2 = -1.221 \frac{\text{kJ}}{\text{kg}\cdot\text{K}}$$

$$T_\sigma := 293.15\cdot\text{K}$$

$$\dot{m} := 0.5 \cdot \frac{\text{kg}}{\text{sec}}$$

$$\eta_t := 0.32$$

By Eqs. (5.26) and (5.28):

$$\dot{W}_{\text{ideal}} := \dot{m} \cdot \left[ H_2 - H_1 - T_\sigma \cdot (S_2 - S_1) \right] \quad \dot{W}_{\text{ideal}} = 13.686 \text{ kW}$$

$$\dot{W} := \frac{\dot{W}_{\text{ideal}}}{\eta_t} \quad \dot{W} = 42.77 \text{ kW} \quad \text{Ans.}$$

**6.68** This is a variation on Example 5.6., pp. 175-177, where all property values are given. We approach it here from the point of view that if the process is completely reversible then the ideal work is zero. We use the notation of Example 5.6:

$$H_1 := 2676.0 \cdot \frac{\text{kJ}}{\text{kg}}$$

$$S_1 := 7.3554 \cdot \frac{\text{kJ}}{\text{kg}\cdot\text{K}}$$

$$H_2 := 0.0 \cdot \frac{\text{kJ}}{\text{kg}}$$

$$S_2 := 0.0 \cdot \frac{\text{kJ}}{\text{kg}\cdot\text{K}}$$

$$Q' := -2000 \cdot \frac{\text{kJ}}{\text{kg}}$$

$$T_\sigma := 273.15\cdot\text{K}$$

The system consists of two parts: the apparatus and the heat reservoir at elevated temperature, and in the equation for ideal work, terms must be included for each part.

$$W_{\text{ideal}} = \Delta H_{\text{apparatus.reservoir}} - T_\sigma \cdot \Delta S_{\text{apparatus.reservoir}}$$

$$\Delta H_{\text{apparatus.reservoir}} = H_2 - H_1 - Q'$$

$$\Delta S_{\text{apparatus.reservoir}} = S_2 - S_1 - \frac{Q'}{T'}$$

$$W_{\text{ideal}} = 0.0 \cdot \frac{\text{kJ}}{\text{kg}}$$

$$T' := 450\cdot\text{K} \quad \text{(Guess)}$$

$$\text{Given} \quad 0 \cdot \frac{\text{kJ}}{\text{kg}} = H_2 - H_1 - Q' - T_\sigma \cdot \left( S_2 - S_1 - \frac{Q'}{T'} \right)$$

$$T' := \text{Find}(T')$$

$$T' = 409.79 \text{ K} \quad \text{Ans.}$$

$$(136.64 \text{ degC})$$

**6.69 From Table F.4 at 200(psi):**

$$H_1 := 1222.6 \cdot \frac{\text{BTU}}{\text{lb}_m}$$

$$S_1 := 1.5737 \cdot \frac{\text{BTU}}{\text{lb}_m \cdot \text{rankine}} \quad (\text{at } 420 \text{ degF})$$

$$H_{\text{liq}} := 355.51 \cdot \frac{\text{BTU}}{\text{lb}_m}$$

$$H_{\text{vap}} := 1198.3 \cdot \frac{\text{BTU}}{\text{lb}_m} \quad (\text{Sat. liq. and vapor})$$

$$S_{\text{liq}} := 0.5438 \cdot \frac{\text{BTU}}{\text{lb}_m \cdot \text{rankine}}$$

$$S_{\text{vap}} := 1.5454 \cdot \frac{\text{BTU}}{\text{lb}_m \cdot \text{rankine}} \quad x := 0.96$$

$$H_2 := H_{\text{liq}} + x \cdot (H_{\text{vap}} - H_{\text{liq}})$$

$$S_2 := S_{\text{liq}} + x \cdot (S_{\text{vap}} - S_{\text{liq}})$$

$$H_2 = 1.165 \times 10^3 \frac{\text{BTU}}{\text{lb}_m}$$

$$S_2 = 1.505 \frac{\text{BTU}}{\text{lb}_m \cdot \text{rankine}}$$

Neglecting kinetic- and potential-energy changes, on the basis of 1 pound mass of steam after mixing, Eq. (2.30) yields for the exit stream:

$$H := 0.5 \cdot H_1 + 0.5 \cdot H_2$$

$$H = 1193.6 \frac{\text{BTU}}{\text{lb}_m} \quad (\text{wet steam})$$

$$x := \frac{H - H_{\text{liq}}}{H_{\text{vap}} - H_{\text{liq}}}$$

$$x = 0.994 \quad \text{Ans.}$$

$$S := S_{\text{liq}} + x \cdot (S_{\text{vap}} - S_{\text{liq}})$$

$$S = 1.54 \frac{\text{BTU}}{\text{lb}_m \cdot \text{rankine}}$$

By Eq. (5.22) on the basis of 1 pound mass of exit steam,

$$S_G := S - 0.5 \cdot S_1 - 0.5 \cdot S_2$$

$$S_G = 2.895 \times 10^{-4} \frac{\text{BTU}}{\text{lb}_m \cdot \text{rankine}} \quad \text{Ans.}$$

**6.70 From Table F.3 at 430 degF (sat. liq. and vapor):**

$$V_{\text{liq}} := 0.01909 \cdot \frac{\text{ft}^3}{\text{lb}_m}$$

$$V_{\text{vap}} := 1.3496 \cdot \frac{\text{ft}^3}{\text{lb}_m}$$

$$V_{\text{tank}} := 80 \cdot \text{ft}^3$$

$$U_{\text{liq}} := 406.70 \cdot \frac{\text{BTU}}{\text{lb}_m}$$

$$U_{\text{vap}} := 1118.0 \cdot \frac{\text{BTU}}{\text{lb}_m}$$

$$m_{\text{liq}} := 4180 \cdot \text{lb}_m$$

$$\text{VOL}_{\text{liq}} := m_{\text{liq}} \cdot V_{\text{liq}}$$

$$\text{VOL}_{\text{liq}} = 79.796 \text{ ft}^3$$

$$VOL_{\text{vap}} := V_{\text{tank}} - VOL_{\text{liq}}$$

$$VOL_{\text{vap}} = 0.204 \text{ ft}^3$$

$$m_{\text{vap}} := \frac{VOL_{\text{vap}}}{V_{\text{vap}}}$$

$$m_{\text{vap}} = 0.151 \text{ lb}_m$$

$$U_1 := \frac{m_{\text{liq}} \cdot U_{\text{liq}} + m_{\text{vap}} \cdot U_{\text{vap}}}{m_{\text{liq}} + m_{\text{vap}}}$$

$$U_1 = 406.726 \frac{\text{BTU}}{\text{lb}_m}$$

By Eq. (2.29) multiplied through by dt, we can write,

$$d(m_t \cdot U_t + H \cdot dm) = 0 \quad \text{(Subscript t denotes the contents of the tank. H and m refer to the exit stream.)}$$

Integration gives:  $m_2 \cdot U_2 - m_1 \cdot U_1 + \int_0^m H \, dm = 0$

From Table F.3 we see that the enthalpy of saturated vapor changes from 1203.9 to 1203.1(Btu/lb) as the temperature drops from 430 to 420 degF. This change is so small that use of an average value for H of 1203.5(Btu/lb) is fully justified. Then

$$m_2 \cdot U_2 - m_1 \cdot U_1 + H_{\text{ave}} \cdot m = 0$$

$$H_{\text{ave}} := 1203.5 \cdot \frac{\text{BTU}}{\text{lb}_m}$$

$$m_1 := m_{\text{liq}} + m_{\text{vap}}$$

$$m_2(\text{mass}) := m_1 - \text{mass}$$

Property values below are for sat. liq. and vap. at 420 degF

$$V_{\text{liq}} := 0.01894 \cdot \frac{\text{ft}^3}{\text{lb}_m}$$

$$V_{\text{vap}} := 1.4997 \cdot \frac{\text{ft}^3}{\text{lb}_m}$$

$$U_{\text{liq}} := 395.81 \cdot \frac{\text{BTU}}{\text{lb}_m}$$

$$U_{\text{vap}} := 1117.4 \cdot \frac{\text{BTU}}{\text{lb}_m}$$

$$V_2(\text{mass}) := \frac{V_{\text{tank}}}{m_2(\text{mass})}$$

$$x(\text{mass}) := \frac{V_2(\text{mass}) - V_{\text{liq}}}{V_{\text{vap}} - V_{\text{liq}}}$$

$$U_2(\text{mass}) := U_{\text{liq}} + x(\text{mass}) \cdot (U_{\text{vap}} - U_{\text{liq}})$$

$$\text{mass} := 50 \cdot \text{lb}_m \quad \text{(Guess)}$$

$$\text{Given} \quad \text{mass} = \frac{m_1 \cdot (U_1 - U_2(\text{mass}))}{H_{\text{ave}} - U_2(\text{mass})}$$

$$\text{mass} := \text{Find}(\text{mass}) \quad \text{mass} = 55.36 \text{ lb}_m \quad \text{Ans.}$$

**6.71 The steam remaining in the tank is assumed to have expanded isentropically. Data from Table F.2 at 4500 kPa and 400 degC:**

$$S_1 := 6.7093 \cdot \frac{\text{J}}{\text{gm} \cdot \text{K}}$$

$$V_1 := 64.721 \cdot \frac{\text{cm}^3}{\text{gm}}$$

$$V_{\text{tank}} := 50 \cdot \text{m}^3$$

$$S_2 = S_1 = 6.7093 \cdot \frac{\text{J}}{\text{gm} \cdot \text{K}}$$

**By interpolation in Table F.2 at this entropy and 3500 kPa:**

$$V_2 := 78.726 \cdot \frac{\text{cm}^3}{\text{gm}}$$

$$t_2 = 362.46 \cdot \text{C} \quad \text{Ans.}$$

$$m_1 := \frac{V_{\text{tank}}}{V_1} \quad m_2 := \frac{V_{\text{tank}}}{V_2} \quad \Delta m := m_1 - m_2 \quad \Delta m = 137.43 \text{ kg} \quad \text{Ans.}$$

**6.72 This problem is similar to Example 6.8, where it is shown that**

$$Q = \Delta(m_t \cdot H_t - H \cdot \Delta m_t)$$

**Here, the symbols with subscript t refer to the contents of the tank, whereas H refers to the entering stream.**

**We illustrate here development of a simple expression for the first term on the right. The 1500 kg of liquid initially in the tank is unchanged during the process. Similarly, the vapor initially in the tank that does NOT condense is unchanged. The only two enthalpy changes within the tank result from:**

**1. Addition of 1000 kg of liquid water. This contributes an enthalpy change of**

$$H_{\text{liq}} \cdot \Delta m_t$$

**2. Condensation of y kg of sat. vapor to sat. liq.**

**This contributes an enthalpy change of**

$$y \cdot (H_{\text{liq}} - H_{\text{vap}}) = -y \cdot H_{\text{lv}}$$

$$\text{Thus} \quad \Delta(m_t \cdot H_t) = H_{\text{liq}} \cdot \Delta m_t - y \cdot \Delta H_{\text{lv}}$$

Similarly,  $\Delta(m_t \cdot V_t) = V_{liq} \cdot \Delta m_t - y \cdot \Delta V_{lv} = 0$

Whence  $Q = H_{liq} \cdot \Delta m_t - y \cdot \Delta H_{lv} - H \cdot \Delta m_t$

$\Delta m_t := 1000 \cdot \text{kg}$

Required data from Table F.1 are:

At 50 degC:

$H := 209.3 \cdot \frac{\text{kJ}}{\text{kg}}$

At 250 degC:

$H_{liq} := 1085.8 \cdot \frac{\text{kJ}}{\text{kg}}$

$V_{liq} := 1.251 \cdot \frac{\text{cm}^3}{\text{gm}}$

$\Delta H_{lv} := 1714.7 \cdot \frac{\text{kJ}}{\text{kg}}$

$\Delta V_{lv} := 48.79 \cdot \frac{\text{cm}^3}{\text{gm}}$

$y := \frac{V_{liq} \cdot \Delta m_t}{\Delta V_{lv}}$

$y = 25.641 \text{ kg}$

$Q := \Delta m_t \cdot (H_{liq} - H) - y \cdot \Delta H_{lv}$

$Q = 832534 \text{ kJ}$       **Ans.**

6.73 Given:

$V_{\text{tank}} := 0.5 \cdot \text{m}^3$

$H_{\text{in}} := -120.8 \cdot \frac{\text{kJ}}{\text{kg}}$

$C := 0.43 \cdot \frac{\text{kJ}}{\text{kg} \cdot \text{K}}$

$T_1 := 295 \cdot \text{K}$

$m_{\text{tank}} := 30 \cdot \text{kg}$

Data for saturated nitrogen vapor:

$T := \begin{pmatrix} 80 \\ 85 \\ 90 \\ 95 \\ 100 \\ 105 \\ 110 \end{pmatrix} \cdot \text{K}$

$P := \begin{pmatrix} 1.396 \\ 2.287 \\ 3.600 \\ 5.398 \\ 7.775 \\ 10.83 \\ 14.67 \end{pmatrix} \cdot \text{bar}$

$V := \begin{pmatrix} 0.1640 \\ 0.1017 \\ 0.06628 \\ 0.04487 \\ 0.03126 \\ 0.02223 \\ 0.01598 \end{pmatrix} \cdot \frac{\text{m}^3}{\text{kg}}$

$$H := \begin{pmatrix} 78.9 \\ 82.3 \\ 85.0 \\ 86.8 \\ 87.7 \\ 87.4 \\ 85.6 \end{pmatrix} \cdot \frac{\text{kJ}}{\text{kg}}$$

At the point when liquid nitrogen starts to accumulate in the tank, it is filled with saturated vapor nitrogen at the final temperature and having properties

$$m_{\text{vap}}, T_{\text{vap}}, V_{\text{vap}}, H_{\text{vap}}, U_{\text{vap}}$$

By Eq. (2.29) multiplied through by  $dt$ ,  $d(h_t \cdot U_t - H \cdot dm) = dQ$

Subscript  $t$  denotes the contents of the tank;  $H$  and  $m$  refer to the inlet stream. Since the tank is initially evacuated, integration gives

$$m_{\text{vap}} \cdot U_{\text{vap}} - H_{\text{in}} \cdot m_{\text{vap}} = Q = m_{\text{tank}} \cdot C \cdot (T_{\text{vap}} - T_1) \quad (\text{A})$$

Also,

$$m_{\text{vap}} = \frac{V_{\text{tank}}}{V_{\text{vap}}} \quad (\text{B})$$

Calculate internal-energy values for saturated vapor nitrogen at the given values of  $T$ :

$$U := \overrightarrow{(H - P \cdot V)}$$

$$U = \begin{pmatrix} 56.006 \\ 59.041 \\ 61.139 \\ 62.579 \\ 63.395 \\ 63.325 \\ 62.157 \end{pmatrix} \frac{\text{kJ}}{\text{kg}}$$

Fit tabulated data with cubic spline:

$$U_s := \text{lspline}(T, U)$$

$$V_s := \text{lspline}(T, V)$$

$$U_{\text{vap}}(t) := \text{interp}(U_s, T, U, t)$$

$$V_{\text{vap}}(t) := \text{interp}(V_s, T, V, t)$$

$$T_{\text{vap}} := 100 \cdot \text{K} \quad (\text{guess})$$

Combining Eqs. (A) & (B) gives:

Given

$$U_{\text{vap}}(T_{\text{vap}}) - H_{\text{in}} = \frac{m_{\text{tank}} \cdot C \cdot (T_1 - T_{\text{vap}}) \cdot V_{\text{vap}}(T_{\text{vap}})}{V_{\text{tank}}}$$

$$T_{\text{vap}} := \text{Find}(T_{\text{vap}})$$

$$T_{\text{vap}} = 97.924 \text{ K}$$

$$m_{\text{vap}} := \frac{V_{\text{tank}}}{V_{\text{vap}}(T_{\text{vap}})}$$

$$m_{\text{vap}} = 13.821 \text{ kg}$$

Ans.

**6.74 The result of Part (a) of Pb. 3.15 applies, with m replacing n:**

$$m_2 \cdot (U_2 - H) - m_1 \cdot (U_1 - H) = Q = 0$$

**Whence** 
$$m_2 \cdot (H - U_2) = m_1 \cdot (H - U_1)$$

**Also** 
$$U_2 = U_{\text{liq},2} + x_2 \cdot \Delta U_{\text{lv},2}$$

$$V_2 = V_{\text{liq},2} + x_2 \cdot \Delta V_{\text{lv},2}$$

$$V_2 = \frac{V_{\text{tank}}}{m_2}$$

**Eliminating  $x_2$  from these equations gives**

$$m_2 \cdot \left( H - U_{\text{liq},2} - \frac{\frac{V_{\text{tank}}}{m_2} - V_{\text{liq},2}}{\Delta V_{\text{lv},2}} \cdot \Delta U_{\text{lv},2} \right) = m_1 \cdot (H - U_1)$$

**which is later solved for  $m_2$**

$$V_{\text{tank}} := 50 \cdot \text{m}^3$$

$$m_1 := 16000 \cdot \text{kg}$$

$$V_1 := \frac{V_{\text{tank}}}{m_1}$$

$$V_1 = 3.125 \times 10^{-3} \frac{\text{m}^3}{\text{kg}}$$

**Data from Table F.1**

**@ 25 degC:**

$$V_{\text{liq},1} := 1.003 \cdot \frac{\text{cm}^3}{\text{gm}}$$

$$\Delta V_{\text{lv},1} := 43400 \cdot \frac{\text{cm}^3}{\text{gm}}$$

$$U_{\text{liq},1} := 104.8 \cdot \frac{\text{kJ}}{\text{kg}}$$

$$\Delta U_{\text{lv},1} := 2305.1 \cdot \frac{\text{kJ}}{\text{kg}}$$



$$x_1 := \frac{V_1 - V_{\text{liq},1}}{\Delta V_{\text{lv},1}}$$

$$U_1 := U_{\text{liq},1} + x_1 \cdot \Delta U_{\text{lv},1}$$

$$x_1 = 4.889 \times 10^{-5}$$

$$U_1 = 104.913 \frac{\text{kJ}}{\text{kg}}$$

**Data from Table F.2 @ 800 kPa:**

$$V_{\text{liq},2} := 1.115 \frac{\text{cm}^3}{\text{gm}}$$

$$U_{\text{liq},2} := 720.043 \frac{\text{kJ}}{\text{kg}}$$

$$\Delta V_{\text{lv},2} := (240.26 - 1.115) \frac{\text{cm}^3}{\text{gm}}$$

$$\Delta U_{\text{lv},2} := (2575.3 - 720.043) \frac{\text{kJ}}{\text{kg}}$$

$$\Delta V_{\text{lv},2} = 0.239 \frac{\text{m}^3}{\text{kg}}$$

$$\Delta U_{\text{lv},2} = 1.855 \times 10^3 \frac{\text{kJ}}{\text{kg}}$$

**Data from Table F.2 @ 1500 kPa:**

$$H := 2789.9 \frac{\text{kJ}}{\text{kg}}$$

$$m_2 := \frac{m_1 \cdot (H - U_1 + V_{\text{tank}} \cdot \left( \frac{\Delta U_{\text{lv},2}}{\Delta V_{\text{lv},2}} \right))}{H - U_{\text{liq},2} + V_{\text{liq},2} \cdot \left( \frac{\Delta U_{\text{lv},2}}{\Delta V_{\text{lv},2}} \right)}$$

$$m_2 = 2.086 \times 10^4 \text{ kg}$$

$$m_{\text{steam}} := m_2 - m_1$$

$$m_{\text{steam}} = 4.855 \times 10^3 \text{ kg}$$

**Ans.**

**6.75** The result of Part (a) of Pb. 3.15 applies, with  $n_1 = Q = 0$

Whence  $U_2 = H$

From Table F.2 at 400 kPa and 240 degC

$$H = 2943.9 \frac{\text{kJ}}{\text{kg}}$$

Interpolation in Table F.2 will produce values of  $t$  and  $V$  for a given  $P$  where  $U = 2943.9 \text{ kJ/kg}$ .

$$P_2 := \begin{pmatrix} 1 \\ 100 \\ 200 \\ 300 \\ 400 \end{pmatrix}$$

$$t_2 := \begin{pmatrix} 384.09 \\ 384.82 \\ 385.57 \\ 386.31 \\ 387.08 \end{pmatrix}$$

$$V_2 := \begin{pmatrix} 303316 \\ 3032.17 \\ 1515.61 \\ 1010.08 \\ 757.34 \end{pmatrix} \cdot \frac{\text{cm}^3}{\text{gm}}$$

$$i := 1..5$$

$$V_{\text{tank}} := 1.75 \cdot \text{m}^3$$

$$\text{mass}_i := \frac{V_{\text{tank}}}{V_{2_i}}$$

$$\text{mass} = \begin{pmatrix} 5.77 \times 10^{-3} \\ 0.577 \\ 1.155 \\ 1.733 \\ 2.311 \end{pmatrix} \text{ kg}$$

T rises very slowly as P increases

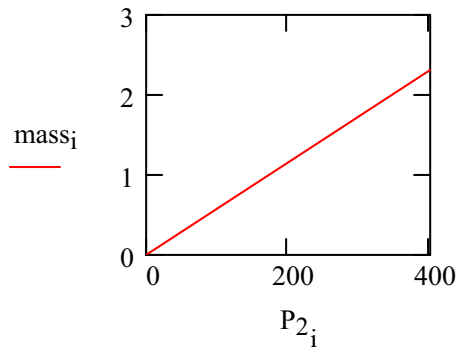

6.76

$$V_{\text{tank}} := 2 \cdot \text{m}^3$$

$$V_{\text{liq}} := 1.216 \cdot \frac{\text{cm}^3}{\text{gm}}$$

$$H_{\text{liq}} := 1008.4 \cdot \frac{\text{kJ}}{\text{kg}}$$

$$x_1 := 0.1$$

Data from Table F.2 @ 3000 kPa:

$$V_{\text{vap}} := 66.626 \cdot \frac{\text{cm}^3}{\text{gm}}$$

$$H_{\text{vap}} := 2802.3 \cdot \frac{\text{kJ}}{\text{kg}}$$

$$V_1 := V_{\text{liq}} + x_1 \cdot (V_{\text{vap}} - V_{\text{liq}}) \quad m_1 := \frac{V_{\text{tank}}}{V_1}$$

$$V_1 = 7.757 \times 10^{-3} \frac{\text{m}^3}{\text{kg}}$$

$$m_1 = 257.832 \text{ kg}$$

The process is the same as that of Example 6.8, except that the stream flows out rather than in. The energy balance is the same, except for a sign:

$$Q = \Delta(m_t \cdot H_t + H \cdot \Delta m_{\text{tank}})$$

where subscript t denotes conditions in the tank, and H is the enthalpy of the stream flowing out of the tank. The only changes affecting the enthalpy of the contents of the tank are:

1. Evaporation of y kg of sat. liq.:

$$y \cdot (H_{\text{vap}} - H_{\text{liq}})$$

2. Exit of  $0.6 \cdot m_1 \cdot \text{kg}$  of liquid from the tank:

$$-0.6 \cdot m_1 \cdot H_{\text{liq}}$$

Thus

$$\Delta(m_t \cdot H_t) = y \cdot (H_{\text{vap}} - H_{\text{liq}}) - 0.6 \cdot m_1 \cdot H_{\text{liq}}$$

Similarly, since the volume of the tank is constant, we can write,

$$\Delta(m_t \cdot V_t) = y \cdot (V_{\text{vap}} - V_{\text{liq}}) - 0.6 \cdot m_1 \cdot V_{\text{liq}} = 0$$

Whence  $y = \frac{0.6 \cdot m_1 \cdot V_{\text{liq}}}{V_{\text{vap}} - V_{\text{liq}}}$

$$Q = \frac{0.6 \cdot m_1 \cdot V_{\text{liq}}}{V_{\text{vap}} - V_{\text{liq}}} \cdot (H_{\text{vap}} - H_{\text{liq}}) - 0.6 \cdot m_1 \cdot H_{\text{liq}} + H \cdot \Delta m_{\text{tank}}$$

But  $H = H_{\text{liq}}$  and  $0.6 \cdot \Delta m_1 = \Delta m_{\text{tank}}$

and therefore the last two terms of the energy equation cancel:

$$Q := \frac{0.6 \cdot m_1 \cdot V_{\text{liq}}}{V_{\text{vap}} - V_{\text{liq}}} \cdot (H_{\text{vap}} - H_{\text{liq}}) \quad Q = 5159 \text{ kJ} \quad \text{Ans.}$$

6.77 Data from Table F.1 for sat. liq.:

$$H_1 := 100.6 \cdot \frac{\text{kJ}}{\text{kg}} \quad (24 \text{ degC})$$

$$H_3 := 355.9 \cdot \frac{\text{kJ}}{\text{kg}} \quad (85 \text{ degC})$$

Data from Table F.2 for sat. vapor @ 400 kPa:

$$H_2 := 2737.6 \cdot \frac{\text{kJ}}{\text{kg}}$$

By Eq. (2.30), neglecting kinetic and potential energies and setting the heat and work terms equal to zero:

$$H_3 \cdot \dot{m}_3 - H_1 \cdot \dot{m}_1 - H_2 \cdot \dot{m}_2 = 0$$

Also

$$\dot{m}_1 = \dot{m}_3 - \dot{m}_2$$

$$\dot{m}_3 := 5 \cdot \frac{\text{kg}}{\text{sec}}$$

Whence

$$\dot{m}_2 := \frac{\dot{m}_3 \cdot (H_1 - H_3)}{H_1 - H_2}$$

$$\dot{m}_1 := \dot{m}_3 - \dot{m}_2$$

$$\dot{m}_2 = 0.484 \frac{\text{kg}}{\text{sec}}$$

Ans.

$$\dot{m}_1 = 4.516 \frac{\text{kg}}{\text{sec}}$$

Ans.

### 6.78 Data from Table F.2 for sat. vapor @ 2900 kPa:

$$H_3 := 2802.2 \cdot \frac{\text{kJ}}{\text{kg}}$$

$$S_3 := 6.1969 \cdot \frac{\text{kJ}}{\text{kg} \cdot \text{K}}$$

$$\dot{m}_3 := 15 \cdot \frac{\text{kg}}{\text{sec}}$$

### Table F.2, superheated vap., 3000 kPa, 375 degC:

$$H_2 := 3175.6 \cdot \frac{\text{kJ}}{\text{kg}}$$

$$S_2 := 6.8385 \cdot \frac{\text{kJ}}{\text{kg} \cdot \text{K}}$$

### Table F.1, sat. liq. @ 50 degC:

$$V_{\text{liq}} := 1.012 \cdot \frac{\text{cm}^3}{\text{gm}}$$

$$H_{\text{liq}} := 209.3 \cdot \frac{\text{kJ}}{\text{kg}}$$

$$S_{\text{liq}} := 0.7035 \cdot \frac{\text{kJ}}{\text{kg} \cdot \text{K}}$$

$$P_{\text{sat}} := 12.34 \cdot \text{kPa}$$

$$T := 323.15 \cdot \text{K}$$

Find changes in H and S caused by pressure increase from 12.34 to 3100 kPa. First estimate the volume expansivity from sat. liq. data at 45 and 55 degC:

$$\Delta V := (1.015 - 1.010) \cdot \frac{\text{cm}^3}{\text{gm}}$$

$$\Delta T := 10 \cdot \text{K}$$

$$P := 3100 \cdot \text{kPa}$$

$$\Delta V = 5 \times 10^{-3} \frac{\text{cm}^3}{\text{gm}}$$

$$\beta := \frac{1}{V_{\text{liq}}} \cdot \frac{\Delta V}{\Delta T}$$

$$\beta = 4.941 \times 10^{-4} \text{K}^{-1}$$

Apply Eqs. (6.28) & (6.29) at constant T:

$$H_1 := H_{\text{liq}} + V_{\text{liq}} \cdot (P - P_{\text{sat}})$$

$$H_1 = 211.926 \frac{\text{kJ}}{\text{kg}}$$

$$S_1 := S_{\text{liq}} - \beta \cdot V_{\text{liq}} \cdot (P - P_{\text{sat}})$$

$$S_1 = 0.702 \frac{\text{kJ}}{\text{kg} \cdot \text{K}}$$

By Eq. (2.30), neglecting kinetic and potential energies and setting the heat and work terms equal to zero:

$$H_3 \cdot \dot{m}_3 - H_1 \cdot \dot{m}_1 - H_2 \cdot \dot{m}_2 = 0$$

Also  $\dot{m}_2 = \dot{m}_3 - \dot{m}_1$

Whence  $\dot{m}_1 := \frac{\dot{m}_3 \cdot (H_3 - H_2)}{H_1 - H_2}$   $\dot{m}_1 = 1.89 \frac{\text{kg}}{\text{sec}}$  **Ans.**

$\dot{m}_2 := \dot{m}_3 - \dot{m}_1$   $\dot{m}_2 = 13.11 \frac{\text{kg}}{\text{sec}}$

For adiabatic conditions, Eq. (5.22) becomes

$$\dot{S}_{\text{totG}} := S_3 \cdot \dot{m}_3 - S_1 \cdot \dot{m}_1 - S_2 \cdot \dot{m}_2$$

$\dot{S}_{\text{totG}} = 1.973 \frac{\text{kJ}}{\text{sec} \cdot \text{K}}$  **Ans.**

The mixing of two streams at different temperatures is irreversible.

6.79 Table F.2, superheated vap. @ 700 kPa, 200 degC:

$H_3 := 2844.2 \cdot \frac{\text{kJ}}{\text{kg}}$

$S_3 := 6.8859 \cdot \frac{\text{kJ}}{\text{kg} \cdot \text{K}}$

Table F.2, superheated vap. @ 700 kPa, 280 degC:

$H_1 := 3017.7 \cdot \frac{\text{kJ}}{\text{kg}}$

$S_1 := 7.2250 \cdot \frac{\text{kJ}}{\text{kg} \cdot \text{K}}$

$\dot{m}_1 := 50 \cdot \frac{\text{kg}}{\text{sec}}$

Table F.1, sat. liq. @ 40 degC:

$H_{\text{liq}} := 167.5 \cdot \frac{\text{kJ}}{\text{kg}}$

$S_{\text{liq}} := 0.5721 \cdot \frac{\text{kJ}}{\text{kg} \cdot \text{K}}$

By Eq. (2.30), neglecting kinetic and potential energies and setting the heat and work terms equal to zero:

$$H_2 := H_{\text{liq}} \quad H_3 \cdot \dot{m}_3 - H_1 \cdot \dot{m}_1 - H_2 \cdot \dot{m}_2 = 0$$

Also  $\dot{m}_3 = \dot{m}_2 + \dot{m}_1$

$\dot{m}_2 := \frac{\dot{m}_1 \cdot (H_1 - H_3)}{H_3 - H_2}$   $\dot{m}_2 = 3.241 \frac{\text{kg}}{\text{sec}}$  **Ans.**

For adiabatic conditions, Eq. (5.22) becomes

$$S_2 := S_{\text{liq}} \quad \dot{m}_3 := \dot{m}_2 + \dot{m}_1$$

$$\dot{S}_{\text{dot}_G} := S_3 \cdot \dot{m}_3 - S_1 \cdot \dot{m}_1 - S_2 \cdot \dot{m}_2$$

$$\dot{S}_{\text{dot}_G} = 3.508 \frac{\text{kJ}}{\text{sec} \cdot \text{K}} \quad \text{Ans.}$$

The mixing of two streams at different temperatures is irreversible.

6.80 Basis: 1 mol air at 12 bar and 900 K (1)

+ 2.5 mol air at 2 bar and 400 K (2)

= 3.5 mol air at T and P.

$$T_1 := 900 \cdot \text{K}$$

$$T_2 := 400 \cdot \text{K}$$

$$P_1 := 12 \cdot \text{bar}$$

$$P_2 := 2 \cdot \text{bar}$$

$$n_1 := 1 \cdot \text{mol}$$

$$n_2 := 2.5 \cdot \text{mol}$$

$$C_P := \frac{7}{2} R$$

$$C_P = 29.099 \frac{\text{J}}{\text{mol} \cdot \text{K}}$$

1st law:  $T := 600 \cdot \text{K}$  (guess)

$$\text{Given } n_1 \cdot C_P \cdot (T - T_1) + n_2 \cdot C_P \cdot (T - T_2) = 0 \cdot \text{J}$$

$$T := \text{Find}(T) \quad T = 542.857 \text{K} \quad \text{Ans.}$$

2nd law:  $P := 5 \cdot \text{bar}$  (guess)

$$\text{Given } \left[ \begin{array}{l} n_1 \cdot \left( C_P \cdot \ln\left(\frac{T}{T_1}\right) - R \cdot \ln\left(\frac{P}{P_1}\right) \right) \dots \\ + n_2 \cdot \left( C_P \cdot \ln\left(\frac{T}{T_2}\right) - R \cdot \ln\left(\frac{P}{P_2}\right) \right) \end{array} \right] = 0 \cdot \frac{\text{J}}{\text{K}}$$

$$P := \text{Find}(P) \quad P = 4.319 \text{bar} \quad \text{Ans.}$$

6.81

$$\text{molwt} := 28.014 \cdot \frac{\text{lb}}{\text{lbmol}}$$

$$C_P := \frac{7}{2} \cdot \frac{R}{\text{molwt}}$$

$$C_P = 0.248 \frac{\text{BTU}}{\text{lb}_m \cdot \text{rankine}}$$

$M_s$  = steam rate in lbm/sec

$M_n$  = nitrogen rate in lbm/sec

$$M_n := 40 \cdot \frac{\text{lb}_m}{\text{sec}}$$

(1) = sat. liq. water @ 212 degF entering

(2) = exit steam at 1 atm and 300 degF

(3) = nitrogen in at 750 degF

$$T_3 := 1209.67 \cdot \text{rankine}$$

(4) = nitrogen out at 325 degF

$$T_4 := 784.67 \cdot \text{rankine}$$

$$H_1 := 180.17 \cdot \frac{\text{BTU}}{\text{lb}_m}$$

$$S_1 := 0.3121 \cdot \frac{\text{BTU}}{\text{lb}_m \cdot \text{rankine}} \quad (\text{Table F.3})$$

$$H_2 := 1192.6 \cdot \frac{\text{BTU}}{\text{lb}_m}$$

$$S_2 := 1.8158 \cdot \frac{\text{BTU}}{\text{lb}_m \cdot \text{rankine}} \quad (\text{Table F.4})$$

Eq. (2.30) applies with negligible kinetic and potential energies and with the work term equal to zero and with the heat transfer rate given by

$$M_s := 3 \cdot \frac{\text{lb}_m}{\text{sec}} \quad (\text{guess}) \quad Q = -60 \cdot \frac{\text{BTU}}{\text{lb}_m} \cdot M_s$$

$$\text{Given} \quad M_s \cdot (H_2 - H_1) + M_n \cdot C_P \cdot (T_4 - T_3) = -60 \cdot \frac{\text{BTU}}{\text{lb}_m} \cdot M_s$$

$$M_s := \text{Find}(M_s) \quad M_s = 3.933 \frac{\text{lb}_m}{\text{sec}} \quad \text{Ans.}$$

Eq. (5.22) here becomes

$$\dot{S}_{\text{dot}_G} = M_s \cdot (S_2 - S_1) + M_n \cdot (S_4 - S_3) - \frac{Q}{T_\sigma}$$

$$S_4 - S_3 = C_P \cdot \ln\left(\frac{T_4}{T_3}\right) \quad Q := -60 \cdot \frac{\text{BTU}}{\text{lb}_m} \cdot M_s \quad Q = -235.967 \frac{\text{BTU}}{\text{sec}}$$

$$T_\sigma := 529.67 \cdot \text{rankine}$$

$$\dot{S}_{\text{dot}_G} := M_s \cdot (S_2 - S_1) + M_n \cdot \left( C_P \cdot \ln\left(\frac{T_4}{T_3}\right) \right) - \frac{Q}{T_\sigma}$$

$$\dot{S}_{\text{dot}_G} = 2.064 \frac{\text{BTU}}{\text{sec} \cdot \text{rankine}} \quad \text{Ans.}$$

$$6.82 \quad \text{molwt} := 28.014 \cdot \frac{\text{gm}}{\text{mol}}$$

$$C_P := \frac{7}{2} \cdot \frac{R}{\text{molwt}}$$

$$C_P = 1.039 \frac{\text{J}}{\text{gm} \cdot \text{K}}$$

$M_s$  = steam rate in kg/sec

$M_n$  = nitrogen rate in kg/sec

$$M_n := 20 \cdot \frac{\text{kg}}{\text{sec}}$$

(1) = sat. liq. water @ 101.33 kPa entering

(2) = exit steam at 101.33 kPa and 150 degC

(3) = nitrogen in @ 400 degC

$$T_3 := 673.15 \cdot \text{K}$$

(4) = nitrogen out at 170 degC

$$T_4 := 443.15 \cdot \text{K}$$

$$H_1 := 419.064 \cdot \frac{\text{kJ}}{\text{kg}}$$

$$S_1 := 1.3069 \cdot \frac{\text{kJ}}{\text{kg} \cdot \text{K}}$$

(Table F.2)

$$H_2 := 2776.2 \cdot \frac{\text{kJ}}{\text{kg}}$$

$$S_2 := 7.6075 \cdot \frac{\text{kJ}}{\text{kg} \cdot \text{K}}$$

(Table F.2)

By Eq. (2.30), neglecting kinetic and potential energies and setting the work term to zero and with the heat transfer rate given by

$$M_s := 1 \cdot \frac{\text{kg}}{\text{sec}} \quad (\text{guess}) \quad Q = -80 \cdot \frac{\text{kJ}}{\text{kg}} \cdot M_s$$

$$\text{Given} \quad M_s \cdot (H_2 - H_1) + M_n \cdot C_P \cdot (T_4 - T_3) = -80 \cdot \frac{\text{kJ}}{\text{kg}} \cdot M_s$$

$$M_s := \text{Find}(M_s) \quad M_s = 1.961 \frac{\text{kg}}{\text{sec}} \quad \text{Ans.}$$

Eq. (5.22) here becomes

$$\dot{S}_{\text{dotG}} = M_s \cdot (S_2 - S_1) + M_n \cdot (S_4 - S_3) - \frac{Q}{T_\sigma}$$

$$S_4 - S_3 = C_P \cdot \ln\left(\frac{T_4}{T_3}\right) \quad T_\sigma := 298.15 \cdot \text{K} \quad Q := -80 \cdot \frac{\text{kJ}}{\text{kg}} \cdot M_s$$

$$\dot{S}_{\text{dotG}} := M_s \cdot (S_2 - S_1) + M_n \cdot \left( C_P \cdot \ln\left(\frac{T_4}{T_3}\right) \right) - \frac{Q}{T_\sigma}$$

$$\dot{S}_{\text{dotG}} = 4.194 \frac{\text{kJ}}{\text{sec} \cdot \text{K}} \quad \text{Ans.}$$



**6.86 Methane = 1; propane = 2**

$$T := 363.15 \cdot K$$

$$P := 5500 \cdot \text{kPa}$$

$$y_1 := 0.5$$

$$y_2 := 1 - y_1$$

$$\omega_1 := 0.012$$

$$\omega_2 := 0.152$$

$$Z_{c1} := 0.286$$

$$Z_{c2} := 0.276$$

$$T_{c1} := 190.6 \cdot K$$

$$T_{c2} := 369.8 \cdot K$$

$$P_{c1} := 45.99 \cdot \text{bar}$$

$$P_{c2} := 42.48 \cdot \text{bar}$$

The elevated pressure here requires use of either an equation of state or the Lee/Kesler correlation with pseudocritical parameters. We choose the latter.

$$T_{pc} := y_1 \cdot T_{c1} + y_2 \cdot T_{c2}$$

$$P_{pc} := y_1 \cdot P_{c1} + y_2 \cdot P_{c2}$$

$$T_{pc} = 280.2 \text{ K}$$

$$P_{pc} = 44.235 \text{ bar}$$

$$T_{pr} := \frac{T}{T_{pc}}$$

$$T_{pr} = 1.296$$

$$P_{pr} := \frac{P}{P_{pc}}$$

$$P_{pr} = 1.243$$

By interpolation in Tables E.3 and E.4:

$$Z_0 := 0.8010$$

$$Z_1 := 0.1100$$

$$\omega := y_1 \cdot \omega_1 + y_2 \cdot \omega_2$$

$$\omega = 0.082$$

$$Z := Z_0 + \omega \cdot Z_1$$

$$Z = 0.81$$

For the molar mass of the mixture, we have:

$$\text{molwt} := (y_1 \cdot 16.043 + y_2 \cdot 44.097) \cdot \frac{\text{gm}}{\text{mol}}$$

$$\text{molwt} = 30.07 \frac{\text{gm}}{\text{mol}}$$

$$V := \frac{Z \cdot R \cdot T}{P \cdot \text{molwt}}$$

$$V = 14.788 \frac{\text{cm}^3}{\text{gm}}$$

$$\dot{m} := 1.4 \cdot \frac{\text{kg}}{\text{sec}}$$

$$u := 30 \cdot \frac{\text{m}}{\text{sec}}$$

$$\dot{V} := V \cdot \dot{m}$$

$$\dot{V} = 2.07 \times 10^4 \frac{\text{cm}^3}{\text{sec}}$$

$$A := \frac{\dot{V}}{u}$$

$$A = 6.901 \text{ cm}^2$$

$$D := \sqrt{\frac{4 \cdot A}{\pi}}$$

$$D = 2.964 \text{ cm}$$

Ans.

**6.87 Vectors containing T, P, Tc, and Pc for the calculation of Tr and Pr:**

$$\begin{array}{l}
 \vec{T} := \begin{pmatrix} 500 \\ 400 \\ 450 \\ 600 \\ 620 \\ 250 \\ 150 \\ 500 \\ 450 \\ 400 \end{pmatrix} \\
 \vec{T}_c := \begin{pmatrix} 425.2 \\ 304.2 \\ 552.0 \\ 617.7 \\ 617.2 \\ 190.6 \\ 154.6 \\ 469.7 \\ 430.8 \\ 374.2 \end{pmatrix} \\
 \vec{P} := \begin{pmatrix} 20 \\ 200 \\ 60 \\ 20 \\ 20 \\ 90 \\ 20 \\ 10 \\ 35 \\ 15 \end{pmatrix} \\
 \vec{P}_c := \begin{pmatrix} 42.77 \\ 73.83 \\ 79.00 \\ 21.10 \\ 36.06 \\ 45.99 \\ 50.43 \\ 33.70 \\ 78.84 \\ 40.60 \end{pmatrix}
 \end{array}$$

$$\vec{Tr} := \frac{\vec{T}}{\vec{T}_c}$$

$$\vec{Pr} := \frac{\vec{P}}{\vec{P}_c}$$

Tr =	1.176	Pr =	0.468
	1.315		2.709
	0.815		0.759
	0.971		0.948
	1.005		0.555
	1.312		1.957
	0.97		0.397
	1.065		0.297
	1.045		0.444
	1.069		0.369

**Parts (a), (g), (h), (i), and (j) --- By virial equation:**

$$\begin{array}{l}
 \vec{T} := \begin{pmatrix} 500 \\ 150 \\ 500 \\ 450 \\ 400 \end{pmatrix} \cdot \text{K} \\
 \vec{P} := \begin{pmatrix} 20 \\ 20 \\ 10 \\ 35 \\ 15 \end{pmatrix} \cdot \text{bar} \\
 \vec{T}_c := \begin{pmatrix} 425.2 \\ 154.6 \\ 469.7 \\ 430.8 \\ 374.2 \end{pmatrix} \cdot \text{K} \\
 \vec{P}_c := \begin{pmatrix} 42.77 \\ 50.43 \\ 33.70 \\ 78.84 \\ 40.6 \end{pmatrix} \cdot \text{bar} \\
 \vec{\omega} := \begin{pmatrix} .190 \\ .022 \\ .252 \\ .245 \\ .327 \end{pmatrix}
 \end{array}$$

$$\vec{Tr} := \frac{\vec{T}}{\vec{T}_c}$$

$$\vec{Pr} := \frac{\vec{P}}{\vec{P}_c}$$

$$\text{Tr} = \begin{pmatrix} 1.176 \\ 0.97 \\ 1.065 \\ 1.045 \\ 1.069 \end{pmatrix}$$

$$\text{Pr} = \begin{pmatrix} 0.468 \\ 0.397 \\ 0.297 \\ 0.444 \\ 0.369 \end{pmatrix}$$

$$\text{B0} := \overrightarrow{\left( 0.073 - \frac{0.422}{\text{Tr}^{1.6}} \right)} \quad \text{Eq. (3.65)} \quad \text{B1} := \overrightarrow{\left( 0.139 - \frac{0.172}{\text{Tr}^{4.2}} \right)} \quad \text{Eq. (3.66)}$$

$$\text{DB0} := \frac{0.675}{\text{Tr}^{2.6}} \quad \text{Eq. (6.89)}$$

$$\text{DB1} := \frac{0.722}{\text{Tr}^{5.2}} \quad \text{Eq. (6.90)}$$

$$\text{B0} = \begin{pmatrix} -0.253 \\ -0.37 \\ -0.309 \\ -0.321 \\ -0.306 \end{pmatrix}$$

$$\text{B1} = \begin{pmatrix} 0.052 \\ -0.056 \\ 6.718 \times 10^{-3} \\ -4.217 \times 10^{-3} \\ 9.009 \times 10^{-3} \end{pmatrix}$$

$$\text{DB0} = \begin{pmatrix} 0.443 \\ 0.73 \\ 0.574 \\ 0.603 \\ 0.568 \end{pmatrix}$$

$$\text{DB1} = \begin{pmatrix} 0.311 \\ 0.845 \\ 0.522 \\ 0.576 \\ 0.51 \end{pmatrix}$$

Combine Eqs. (3.61) + (3.62), (3.63), and (6.40) and the definitions of Tr and Pr to get:

$$\text{VR} := \overrightarrow{\left[ \text{R} \cdot \frac{\text{Tc}}{\text{Pc}} \cdot (\text{B0} + \omega \cdot \text{B1}) \right]}$$

$$\text{HR} := \overrightarrow{\left[ \text{R} \cdot \text{Tc} \cdot \text{Pr} \cdot \left[ \text{B0} - \alpha \text{Tr} \cdot \text{DB0} + \omega \cdot (\text{B1} - \text{Tr} \cdot \text{DB1}) \right] \right]} \quad \text{Eq. (6.87)}$$

$$\text{SR} := \overrightarrow{\left[ -\text{R} \cdot \text{Pr} \cdot (\text{DB0} + \omega \cdot \text{DB1}) \right]} \quad \text{Eq. (6.88)}$$

$$VR = \begin{pmatrix} -200.647 \\ -94.593 \\ -355.907 \\ -146.1 \\ -232.454 \end{pmatrix} \frac{\text{cm}^3}{\text{mol}}$$

$$HR = \begin{pmatrix} -1.377 \times 10^3 \\ -559.501 \\ -1.226 \times 10^3 \\ -1.746 \times 10^3 \\ -1.251 \times 10^3 \end{pmatrix} \frac{\text{J}}{\text{mol}}$$

$$SR = \begin{pmatrix} -1.952 \\ -2.469 \\ -1.74 \\ -2.745 \\ -2.256 \end{pmatrix} \frac{\text{J}}{\text{mol} \cdot \text{K}}$$

Parts (b), (c), (d), (e), and (f) --- By Lee/Kesler correlation:

By linear interpolation in Tables E.1--E.12:

$$\text{DEFINE: } h_0 \text{ equals } \frac{(HR)^0}{RT_c} \quad h_1 \text{ equals } \frac{(HR)^1}{RT_c} \quad h \text{ equals } \frac{HR}{RT_c}$$

$$s_0 \text{ equals } \frac{(SR)^0}{R} \quad s_1 \text{ equals } \frac{(SR)^1}{R} \quad s \text{ equals } \frac{SR}{R}$$

$$Z_0 := \begin{pmatrix} .663 \\ .124 \\ .278 \\ .783 \\ .707 \end{pmatrix}$$

$$Z_1 := \begin{pmatrix} 0.208 \\ -.050 \\ -.088 \\ -.036 \\ 0.138 \end{pmatrix}$$

$$h_0 := \begin{pmatrix} -2.008 \\ -4.445 \\ -3.049 \\ -0.671 \\ -1.486 \end{pmatrix}$$

$$h_1 := \begin{pmatrix} -0.233 \\ -5.121 \\ -2.970 \\ -0.596 \\ -0.169 \end{pmatrix}$$

$$s_0 := \begin{pmatrix} -1.137 \\ -4.381 \\ -2.675 \\ -0.473 \\ -0.824 \end{pmatrix}$$

$$s_1 := \begin{pmatrix} -0.405 \\ -5.274 \\ -2.910 \\ -0.557 \\ -0.289 \end{pmatrix}$$

$$T := \begin{pmatrix} 400 \\ 450 \\ 600 \\ 620 \\ 250 \end{pmatrix} \cdot \text{K}$$

$$P := \begin{pmatrix} 200 \\ 60 \\ 20 \\ 20 \\ 90 \end{pmatrix} \cdot \text{bar}$$

$$T_c := \begin{pmatrix} 304.2 \\ 552.0 \\ 617.7 \\ 617.2 \\ 190.6 \end{pmatrix} \cdot \text{K}$$

$$\omega := \begin{pmatrix} .224 \\ .111 \\ .492 \\ .303 \\ .012 \end{pmatrix}$$

$$Z := \overrightarrow{(Z_0 + \omega \cdot Z_1)} \quad \text{Eq. (3.57)} \quad h := \overrightarrow{(h_0 + \omega \cdot h_1)} \quad \text{Eq. (6.85)}$$

$$s := \overrightarrow{(s_0 + \omega \cdot s_1)} \quad (6.86)$$

$$HR := \overrightarrow{(h \cdot T_c \cdot R)} \quad SR := \overrightarrow{(s \cdot R)}$$

$$Z = \begin{pmatrix} 0.71 \\ 0.118 \\ 0.235 \\ 0.772 \\ 0.709 \end{pmatrix} \quad HR = \begin{pmatrix} -5.21 \times 10^3 \\ -2.301 \times 10^4 \\ -2.316 \times 10^4 \\ -4.37 \times 10^3 \\ -2.358 \times 10^3 \end{pmatrix} \frac{\text{J}}{\text{mol}} \quad SR = \begin{pmatrix} -10.207 \\ -41.291 \\ -34.143 \\ -5.336 \\ -6.88 \end{pmatrix} \frac{\text{J}}{\text{mol} \cdot \text{K}}$$

$$VR := \overrightarrow{\left[ R \cdot \frac{T}{P} \cdot (Z - 1) \right]} \quad VR = \begin{pmatrix} -48.289 \\ -549.691 \\ -1.909 \times 10^3 \\ -587.396 \\ -67.284 \end{pmatrix} \frac{\text{cm}^3}{\text{mol}} \quad \text{And.}$$

The Lee/Kesler tables indicate that the state in Part (c) is liquid.

### 6.88 Vectors containing T, P, Tc1, Tc2, Pc1, Pc2, ω1, and ω2 for Parts (a) through (h)

$$T := \begin{pmatrix} 650 \\ 300 \\ 600 \\ 350 \\ 400 \\ 200 \\ 450 \\ 250 \end{pmatrix} \cdot \text{K} \quad P := \begin{pmatrix} 60 \\ 100 \\ 100 \\ 75 \\ 150 \\ 75 \\ 80 \\ 100 \end{pmatrix} \cdot \text{bar} \quad T_{c1} := \begin{pmatrix} 562.2 \\ 304.2 \\ 304.2 \\ 305.3 \\ 373.5 \\ 190.6 \\ 190.6 \\ 126.2 \end{pmatrix} \cdot \text{K} \quad T_{c2} := \begin{pmatrix} 553.6 \\ 132.9 \\ 568.7 \\ 282.3 \\ 190.6 \\ 126.2 \\ 469.7 \\ 154.6 \end{pmatrix} \cdot \text{K}$$

$$\begin{array}{l}
 \text{Pc1} := \begin{pmatrix} 48.98 \\ 73.83 \\ 73.83 \\ 48.72 \\ 89.63 \\ 45.99 \\ 45.99 \\ 34.00 \end{pmatrix} \cdot \text{bar} \\
 \text{Pc2} := \begin{pmatrix} 40.73 \\ 34.99 \\ 24.90 \\ 50.40 \\ 45.99 \\ 34.00 \\ 33.70 \\ 50.43 \end{pmatrix} \cdot \text{bar} \\
 \omega_1 := \begin{pmatrix} .210 \\ .224 \\ .224 \\ .100 \\ .094 \\ .012 \\ .012 \\ .038 \end{pmatrix} \\
 \omega_2 := \begin{pmatrix} .210 \\ .048 \\ .400 \\ .087 \\ .012 \\ .038 \\ .252 \\ .022 \end{pmatrix}
 \end{array}$$

$$\begin{array}{l}
 \xrightarrow{\hspace{10em}} \\
 \text{Tpc} := (.5 \cdot \text{Tc1} + .5 \cdot \text{Tc2}) \quad \text{Ppc} := (.5 \cdot \text{Pc1} + .5 \cdot \text{Pc2}) \quad \omega := (.5 \cdot \omega_1 + .5 \cdot \omega_2)
 \end{array}$$

$$\begin{array}{l}
 \xrightarrow{\hspace{2em}} \quad \xrightarrow{\hspace{2em}} \\
 \text{Tpr} := \frac{\text{T}}{\text{Tpc}} \quad \text{Ppr} := \frac{\text{P}}{\text{Ppc}}
 \end{array}$$

$$\text{Tpc} = \begin{pmatrix} 557.9 \\ 218.55 \\ 436.45 \\ 293.8 \\ 282.05 \\ 158.4 \\ 330.15 \\ 140.4 \end{pmatrix} \text{K}$$

$$\text{Ppc} = \begin{pmatrix} 44.855 \\ 54.41 \\ 49.365 \\ 49.56 \\ 67.81 \\ 39.995 \\ 39.845 \\ 42.215 \end{pmatrix} \text{bar}$$

$$\omega = \begin{pmatrix} 0.21 \\ 0.136 \\ 0.312 \\ 0.094 \\ 0.053 \\ 0.025 \\ 0.132 \\ 0.03 \end{pmatrix}$$

$$\text{Tpr} = \begin{pmatrix} 1.165 \\ 1.373 \\ 1.375 \\ 1.191 \\ 1.418 \\ 1.263 \\ 1.363 \\ 1.781 \end{pmatrix}$$

$$\text{Ppr} = \begin{pmatrix} 1.338 \\ 1.838 \\ 2.026 \\ 1.513 \\ 2.212 \\ 1.875 \\ 2.008 \\ 2.369 \end{pmatrix}$$

**Lee/Kesler Correlation --- By linear interpolation in Tables E.1--E.12:**

$$Z_0 := \begin{pmatrix} .6543 \\ .7706 \\ .7527 \\ .6434 \\ .7744 \\ .6631 \\ .7436 \\ .9168 \end{pmatrix}$$

$$Z_1 := \begin{pmatrix} .1219 \\ .1749 \\ .1929 \\ .1501 \\ .1990 \\ .1853 \\ .1933 \\ .1839 \end{pmatrix}$$

$$h_0 := \begin{pmatrix} -1.395 \\ -1.217 \\ -1.346 \\ -1.510 \\ -1.340 \\ -1.623 \\ -1.372 \\ -0.820 \end{pmatrix}$$

$$h_1 := \begin{pmatrix} -.461 \\ -.116 \\ -.097 \\ -.400 \\ -.049 \\ -.254 \\ -.110 \\ 0.172 \end{pmatrix}$$

$$s_0 := \begin{pmatrix} -.890 \\ -.658 \\ -.729 \\ -.944 \\ -.704 \\ -.965 \\ -.750 \\ -.361 \end{pmatrix}$$

$$s_1 := \begin{pmatrix} -.466 \\ -.235 \\ -.242 \\ -.430 \\ -.224 \\ -.348 \\ -.250 \\ -.095 \end{pmatrix}$$

$$h_0 \text{ equals } \frac{(HR)^0}{RT_{pc}}$$

$$h_1 \text{ equals } \frac{(HR)^1}{RT_{pc}}$$

$$h \text{ equals } \frac{HR}{RT_{pc}}$$

$$s_0 \text{ equals } \frac{(SR)^0}{R}$$

$$s_1 \text{ equals } \frac{(SR)^1}{R}$$

$$s \text{ equals } \frac{SR}{R}$$

$$Z := \overrightarrow{(Z_0 + \omega \cdot Z_1)} \quad \text{Eq. (3.57)}$$

$$h := \overrightarrow{(h_0 + \omega \cdot h_1)} \quad \text{Eq. (6.85)}$$

$$s := \overrightarrow{(s_0 + \omega \cdot s_1)} \quad \text{Eq. (6.86)}$$

$$HR := \overrightarrow{(h \cdot T_{pc} \cdot R)}$$

$$SR := \overrightarrow{(s \cdot R)}$$

$$Z = \begin{pmatrix} 0.68 \\ 0.794 \\ 0.813 \\ 0.657 \\ 0.785 \\ 0.668 \\ 0.769 \\ 0.922 \end{pmatrix}$$

$$HR = \begin{pmatrix} -6919.583 \\ -2239.984 \\ -4993.974 \\ -3779.762 \\ -3148.341 \\ -2145.752 \\ -3805.813 \\ -951.151 \end{pmatrix} \frac{J}{mol}$$

$$SR = \begin{pmatrix} -8.213 \\ -5.736 \\ -6.689 \\ -8.183 \\ -5.952 \\ -8.095 \\ -6.51 \\ -3.025 \end{pmatrix} \frac{J}{mol \cdot K}$$

Ans.

6.95  $T_c := 647.1K$

$P_c := 220.55bar$

At  $Tr = 0.7$ :  $T := 0.7 \cdot T_c$

$T = 452.97K$

Find  $Psat$  in the Saturated Steam Tables at  $T = 452.97 K$

$T1 := 451.15K$

$P1 := 957.36kPa$

$T2 := 453.15K$

$P2 := 1002.7kPa$

$$Psat := \frac{P2 - P1}{T2 - T1} \cdot (T - T1) + P1$$

$Psat = 998.619 kPa$

$Psat = 9.986 bar$

$$Psat_r := \frac{Psat}{P_c}$$

$Psat_r = 0.045$

$$\omega := -1 - \log(Psat_r)$$

$\omega = 0.344$

Ans.

This is very close to the value reported in Table B.1 ( $\omega = 0.345$ ).

6.96  $T_c := 374.2K$

$P_c := 40.60bar$

At  $Tr = 0.7$ :  $T := 0.7 \cdot T_c$

$T = 471.492 rankine$

$T := T - 459.67 rankine$

$T = 11.822 degF$

Find  $Psat$  in Table 9.1 at  $T = 11.822 F$

$T1 := 10degF$

$P1 := 26.617psi$

$T2 := 15degF$

$P2 := 29.726psi$



$$P_{\text{sat}} := \frac{P_2 - P_1}{T_2 - T_1} \cdot (T - T_1) + P_1 \quad P_{\text{sat}} = 27.75 \text{ psi} \quad P_{\text{sat}} = 1.913 \text{ bar}$$

$$P_{\text{sat}_r} := \frac{P_{\text{sat}}}{P_c} \quad P_{\text{sat}_r} = 0.047 \quad \omega := -1 - \log(P_{\text{sat}_r}) \quad \omega = 0.327 \quad \text{Ans.}$$

This is exactly the same as the value reported in Table B.1.

### 6.101 For benzene

$$\text{a) } \omega := 0.210 \quad T_c := 562.2\text{K} \quad P_c := 48.98\text{bar} \quad Z_c := 0.271 \quad T_n := 353.2\text{K}$$

$$T_{\text{rn}} := \frac{T_n}{T_c} \quad T_{\text{rn}} = 0.628 \quad P_{\text{sat}_{\text{rn}}} := 1 \frac{\text{atm}}{P_c} \quad P_{\text{sat}_{\text{rn}}} = 0.021$$

$$\ln \text{Pr}0(T_r) := 5.92714 - \frac{6.09648}{T_r} - 1.28862 \cdot \ln(T_r) + 0.169347 \cdot T_r^6 \quad \text{Eqn. (6.79)}$$

$$\ln \text{Pr}1(T_r) := 15.2518 - \frac{15.6875}{T_r} - 13.4721 \cdot \ln(T_r) + 0.43577 \cdot T_r^6 \quad \text{Eqn. (6.80)}$$

$$\omega := \frac{\ln(P_{\text{sat}_{\text{rn}}} - \ln \text{Pr}0(T_{\text{rn}}))}{\ln \text{Pr}1(T_{\text{rn}})} \quad \text{Eqn. (6.81).} \quad \omega = 0.207$$

$$\ln P_{\text{sat}_r}(T_r) := \ln \text{Pr}0(T_r) + \omega \cdot \ln \text{Pr}1(T_r) \quad \text{Eqn. (6.78)}$$

$$Z_{\text{sat}_{\text{liq}}} := \frac{P_{\text{sat}_{\text{rn}}}}{T_{\text{rn}}} \cdot Z_c \left[ 1 + \left( 1 - T_{\text{rn}} \right)^{\frac{2}{7}} \right] \quad \text{Eqn. (3.73)} \quad Z_{\text{sat}_{\text{liq}}} = 0.00334$$

$$B_0 := 0.083 - \frac{0.422}{T_{\text{rn}}^{1.6}} \quad \text{Eqn. (3.65)} \quad Z_0 := 1 + B_0 \cdot \frac{P_{\text{sat}_{\text{rn}}}}{T_{\text{rn}}} \quad \text{Eqn. (3.64)}$$

$$B_0 = -0.805$$

$$Z_0 = 0.974$$

$$B_1 := 0.139 - \frac{0.172}{T_{\text{rn}}^{4.2}} \quad \text{Eqn. (3.66)} \quad Z_1 := B_1 \cdot \frac{P_{\text{sat}_{\text{rn}}}}{T_{\text{rn}}} \quad \text{Equation following Eqn. (3.64)}$$

$$B_1 = -1.073$$

$$Z_1 = -0.035$$

$$Z_{\text{sat,vap}} := Z_0 + \omega \cdot Z_1 \quad \text{Eqn. (3.57)} \quad Z_{\text{sat,vap}} = 0.966$$

$$\Delta Z_{\text{lv}} := Z_{\text{sat,vap}} - Z_{\text{sat,liq}} \quad \Delta Z_{\text{lv}} = 0.963$$

$$\Delta \hat{H}_{\text{lv}} := \frac{d}{dT_{\text{m}}} \ln P_{\text{satr}}(T_{\text{m}}) \cdot T_{\text{m}}^2 \cdot Z_{\text{lv}} \quad \Delta \hat{H}_{\text{lv}} = 6.59$$

$$\Delta H_{\text{lv}} := R \cdot T_{\text{c}} \cdot \hat{H}_{\text{lv}} \quad \Delta H_{\text{lv}} = 30.802 \frac{\text{kJ}}{\text{mol}} \quad \text{Ans.}$$

This compares well with the value in Table B.2 of 30.19 kJ/mol

The results for the other species are given in the table below.

	Estimated Value (kJ/mol)	Table B.2 (kJ/mol)
<b>Benzene</b>	30.80	30.72
<b>iso-Butane</b>	21.39	21.30
<b>Carbon tetrachloride</b>	29.81	29.82
<b>Cyclohexane</b>	30.03	29.97
<b>n-Decane</b>	39.97	38.75
<b>n-Hexane</b>	29.27	28.85
<b>n-Octane</b>	34.70	34.41
<b>Toluene</b>	33.72	33.18
<b>o-Xylene</b>	37.23	36.24

6.103 For CO<sub>2</sub>:  $\omega := 0.224$   $T_{\text{c}} := 304.2\text{K}$   $P_{\text{c}} := 73.83\text{bar}$

At the triple point:  $T_{\text{t}} := 216.55\text{K}$   $P_{\text{t}} := 5.170\text{bar}$

a) At  $T_{\text{r}} = 0.7$   $T := 0.7T_{\text{c}}$   $T = 212.94\text{K}$

$$T_{\text{tr}} := \frac{T_{\text{t}}}{T_{\text{c}}} \quad T_{\text{tr}} = 0.712 \quad P_{\text{tr}} := \frac{P_{\text{t}}}{P_{\text{c}}} \quad P_{\text{tr}} = 0.07$$

$$\ln \text{Pr0}(T_{\text{r}}) := 5.92714 - \frac{6.09648}{T_{\text{r}}} - 1.28862 \cdot \ln(T_{\text{r}}) + 0.169347 \cdot T_{\text{r}}^6 \quad \text{Eqn. (6.79)}$$

$$\ln \text{Pr1}(T_{\text{r}}) := 15.2518 - \frac{15.6875}{T_{\text{r}}} - 13.4721 \cdot \ln(T_{\text{r}}) + 0.43577 \cdot T_{\text{r}}^6 \quad \text{Eqn. (6.80)}$$

$$\omega := \frac{\ln(P_{\text{tr}}) - \ln \text{Pr0}(T_{\text{tr}})}{\ln \text{Pr1}(T_{\text{tr}})} \quad \text{Eqn. (6.81).} \quad \omega = 0.224 \quad \text{Ans.}$$

**This is exactly the same value as given in Table B.1**

b)  $P_{\text{sat}_r} := \frac{1 \text{ atm}}{P_c}$        $P_{\text{sat}_r} = 0.014$       **Guess:**  $T_{rn} := 0.7$

Given       $\ln(P_{\text{sat}_r}) = \ln Pr_0(T_{rn}) + \omega \cdot \ln Pr_1(T_{rn})$        $T_{rn} := \text{Find}(T_{rn})$

$T_{rn} = 0.609$        $T_n := T_{rn} \cdot T_c$        $T_n = 185.3 \text{ K}$       **Ans.**

**This seems reasonable; a  $T_{rn}$  of about 0.6 is common for triatomic species.**

## Chapter 7 - Section A - Mathcad Solutions

7.1  $u_2 := 325 \cdot \frac{\text{m}}{\text{sec}}$   $R := 8.314 \cdot \frac{\text{J}}{\text{mol} \cdot \text{K}}$   $\text{molwt} := 28.9 \cdot \frac{\text{gm}}{\text{mol}}$   $C_p := \frac{7}{2} \cdot \frac{R}{\text{molwt}}$

With the heat, work, and potential-energy terms set equal to zero and with the initial velocity equal to zero, Eq. (2.32a) reduces to

$$\Delta H + \frac{u_2^2}{2} = 0 \quad \text{But} \quad \Delta H = C_p \cdot \Delta T$$

Whence  $\Delta T := \frac{-u_2^2}{2 \cdot C_p}$   $\Delta T = -52.45 \text{ K}$  Ans.

7.4 From Table F.2 at 800 kPa and 280 degC:

$$H_1 := 3014.9 \cdot \frac{\text{kJ}}{\text{kg}} \quad S_1 := 7.1595 \cdot \frac{\text{kJ}}{\text{kg} \cdot \text{K}}$$

Interpolation in Table F.2 at  $P = 525 \text{ kPa}$  and  $S = 7.1595 \text{ kJ}/(\text{kg} \cdot \text{K})$  yields:

$$H_2 := 2855.2 \cdot \frac{\text{kJ}}{\text{kg}} \quad V_2 := 531.21 \cdot \frac{\text{cm}^3}{\text{gm}} \quad \dot{m} := 0.75 \cdot \frac{\text{kg}}{\text{sec}}$$

With the heat, work, and potential-energy terms set equal to zero and with the initial velocity equal to zero, Eq. (2.32a) reduces to:

$$\Delta H + \frac{u_2^2}{2} = 0 \quad \text{Whence} \quad u_2 := \sqrt{-2 \cdot (H_2 - H_1)}$$

$u_2 = 565.2 \frac{\text{m}}{\text{sec}}$  Ans.

By Eq. (2.27),  $A_2 := \frac{\dot{m} \cdot V_2}{u_2}$   $A_2 = 7.05 \text{ cm}^2$  Ans.

7.5 The calculations of the preceding problem may be carried out for a series of exit pressures until a minimum cross-sectional area is found. The corresponding pressure is the minimum obtainable in the converging nozzle. Initial property values are as in the preceding problem.

$$H_1 := 3014.9 \cdot \frac{\text{kJ}}{\text{kg}}$$

$$S_1 := 7.1595 \cdot \frac{\text{kJ}}{\text{kg} \cdot \text{K}}$$

$$S_2 = S_1$$

Interpolations in Table F.2 at several pressures and at the given entropy yield the following values:

$$P := \begin{pmatrix} 400 \\ 425 \\ 450 \\ 475 \\ 500 \end{pmatrix} \cdot \text{kPa}$$

$$H_2 := \begin{pmatrix} 2855.2 \\ 2868.2 \\ 2880.7 \\ 2892.5 \\ 2903.9 \end{pmatrix} \cdot \frac{\text{kJ}}{\text{kg}}$$

$$V_2 := \begin{pmatrix} 531.21 \\ 507.12 \\ 485.45 \\ 465.69 \\ 447.72 \end{pmatrix} \cdot \frac{\text{cm}^3}{\text{gm}}$$

$$\dot{m} := 0.75 \cdot \frac{\text{kg}}{\text{sec}}$$

$$u_2 := \sqrt{-2 \cdot (H_2 - H_1)}$$

$$A_2 := \frac{\dot{m} \cdot V_2}{u_2}$$

$$u_2 = \begin{pmatrix} 565.2 \\ 541.7 \\ 518.1 \\ 494.8 \\ 471.2 \end{pmatrix} \frac{\text{m}}{\text{sec}}$$

$$A_2 = \begin{pmatrix} 7.05 \\ 7.022 \\ 7.028 \\ 7.059 \\ 7.127 \end{pmatrix} \text{cm}^2$$

Fit the P vs. A<sub>2</sub> data with cubic spline and find the minimum P at the point where the first derivative of the spline is zero.

$$i := 1..5 \quad p_i := P_i \quad a_{2_i} := A_{2_i}$$

$$s := \text{cspline}(P, A_2) \quad A(P) := \text{interp}(s, p, a_2, P)$$

$$p_{\min} := 400 \cdot \text{kPa} \quad (\text{guess})$$

$$\text{Given} \quad \frac{d}{dp_{\min}} A(p_{\min}) = 0 \cdot \frac{\text{cm}^2}{\text{kPa}} \quad p_{\min} := \text{Find}(p_{\min})$$

$$p_{\min} = 431.78 \text{ kPa}$$

Ans.

$$A(p_{\min}) = 7.021 \text{ cm}^2$$

Ans.

Show spline fit graphically:  $p := 400 \cdot \text{kPa}, 401 \cdot \text{kPa} \dots 500 \cdot \text{kPa}$

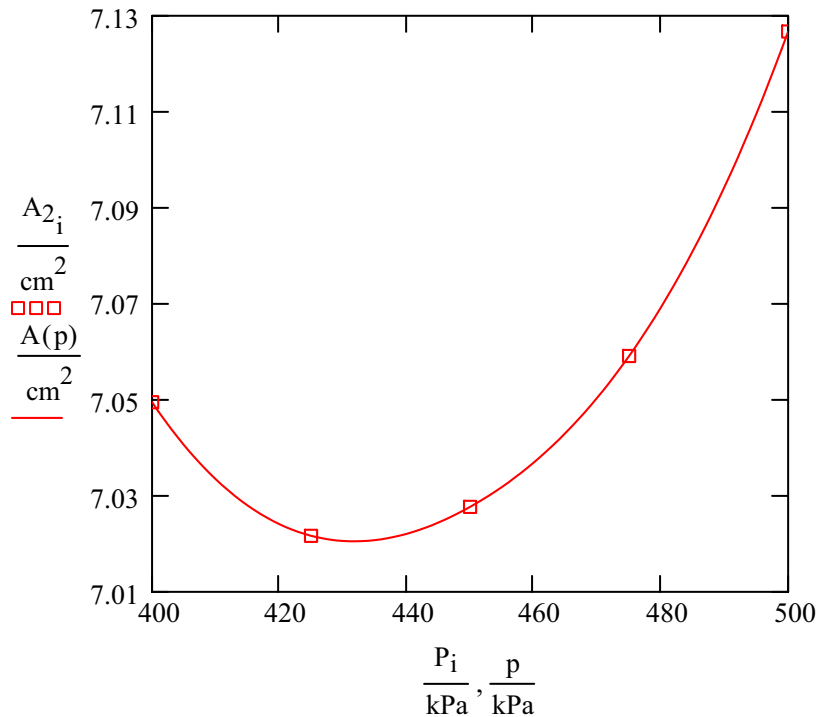

7.9 From Table F.2 at 1400 kPa and 325 degC:

$$H_1 := 3096.5 \cdot \frac{\text{kJ}}{\text{kg}}$$

$$S_1 := 7.0499 \cdot \frac{\text{kJ}}{\text{kg} \cdot \text{K}}$$

$$S_2 := S_1$$

Interpolate in Table F.2 at a series of downstream pressures and at  $S = 7.0499 \text{ kJ}/(\text{kg} \cdot \text{K})$  to find the minimum cross-sectional area.

$$P := \begin{pmatrix} 800 \\ 775 \\ 750 \\ 725 \\ 700 \end{pmatrix} \cdot \text{kPa}$$

$$H_2 := \begin{pmatrix} 2956.0 \\ 2948.5 \\ 2940.8 \\ 2932.8 \\ 2924.9 \end{pmatrix} \cdot \frac{\text{kJ}}{\text{kg}}$$

$$V_2 := \begin{pmatrix} 294.81 \\ 302.12 \\ 309.82 \\ 317.97 \\ 326.69 \end{pmatrix} \cdot \frac{\text{cm}^3}{\text{gm}}$$

$$u_2 := \sqrt{-2 \cdot (H_2 - H_1)}$$

$$A_2 = \left( \frac{V_2}{u_2} \right) \cdot \text{mdot}$$

Since  $\dot{m}$  is constant, the quotient  $V_2/u_2$  is a measure of the area. Its minimum value occurs very close to the value at vector index  $i = 3$ .

$$\begin{pmatrix} \vec{V}_2 \\ u_2 \end{pmatrix} = \begin{pmatrix} 5.561 \\ 5.553 \\ 5.552 \\ 5.557 \\ 5.577 \end{pmatrix} \frac{\text{cm}^2 \cdot \text{sec}}{\text{kg}}$$

At the throat,

$$A_2 := 6 \cdot \text{cm}^2$$

$$\dot{m} := \frac{A_2 \cdot u_{2_3}}{V_{2_3}}$$

$$\dot{m} = 1.081 \frac{\text{kg}}{\text{sec}}$$

Ans.

At the nozzle exit,  $P = 140 \text{ kPa}$  and  $S = S_1$ , the initial value. From Table F.2 we see that steam at these conditions is wet. By interpolation,

$$S_{\text{liq}} := 1.4098 \cdot \frac{\text{kJ}}{\text{kg} \cdot \text{K}}$$

$$S_{\text{vap}} := 7.2479 \cdot \frac{\text{kJ}}{\text{kg} \cdot \text{K}}$$

$$x := \frac{S_1 - S_{\text{liq}}}{S_{\text{vap}} - S_{\text{liq}}}$$

$$x = 0.966$$

7.10

$$u_1 := 230 \cdot \frac{\text{ft}}{\text{sec}}$$

$$u_2 := 2000 \cdot \frac{\text{ft}}{\text{sec}}$$

From Table F.4 at 130(psi) and 420 degF:

$$H_1 := 1233.6 \cdot \frac{\text{Btu}}{\text{lb}_m}$$

$$S_1 := 1.6310 \cdot \frac{\text{Btu}}{\text{lb}_m \cdot \text{rankine}}$$

By Eq. (2.32a),

$$\Delta H := \frac{u_1^2 - u_2^2}{2}$$

$$\Delta H = -78.8 \frac{\text{Btu}}{\text{lb}_m}$$

$$H_2 := H_1 + \Delta H$$

$$H_2 = 1154.8 \frac{\text{Btu}}{\text{lb}_m}$$

From Table F.4 at 35(psi), we see that the final state is wet steam:

$$H_{\text{liq}} := 228.03 \cdot \frac{\text{Btu}}{\text{lb}_m}$$

$$H_{\text{vap}} := 1167.1 \cdot \frac{\text{Btu}}{\text{lb}_m}$$

$$S_{\text{liq}} := 0.3809 \cdot \frac{\text{Btu}}{\text{lb}_m \cdot \text{rankine}}$$

$$S_{\text{vap}} := 1.6872 \cdot \frac{\text{Btu}}{\text{lb}_m \cdot \text{rankine}}$$

$$x := \frac{H_2 - H_{liq}}{H_{vap} - H_{liq}} \quad x = 0.987 \quad (\text{quality})$$

$$S_2 := S_{liq} + x \cdot (S_{vap} - S_{liq}) \quad S_2 = 1.67 \frac{\text{BTU}}{\text{lb}_m \cdot \text{rankine}}$$

$$S_{dot{G}} := S_2 - S_1 \quad S_{dot{G}} = 0.039 \frac{\text{Btu}}{\text{lb}_m \cdot \text{rankine}} \quad \text{Ans.}$$

7.11  $u_2 := 580 \cdot \frac{\text{m}}{\text{sec}} \quad T_2 := (273.15 + 15) \cdot \text{K} \quad \text{molwt} := 28.9 \frac{\text{gm}}{\text{mol}} \quad C_p := \frac{7}{2} \cdot \frac{\text{R}}{\text{molwt}}$

By Eq. (2.32a),  $\Delta H = \frac{u_1^2 - u_2^2}{2} = \frac{-u_2^2}{2}$

But  $\Delta H = C_p \cdot \Delta T$  Whence

$$\Delta T := \frac{-u_2^2}{2 \cdot C_p} \quad \Delta T = -167.05 \text{ K} \quad \text{Ans.}$$

Initial  $t = 15 + 167.05 = 182.05 \text{ degC}$  Ans.

7.12 Values from the steam tables for saturated-liquid water:

At 15 degC:  $V := 1.001 \cdot \frac{\text{cm}^3}{\text{gm}} \quad T := 288.15 \cdot \text{K}$

Enthalpy difference for saturated liquid for a temperature change from 14 to 15 degC:

$$\Delta H := (67.13 - 58.75) \cdot \frac{\text{J}}{\text{gm}} \quad \Delta t := 2 \cdot \text{K} \quad C_p := \frac{\Delta H}{\Delta t}$$

$$\beta := \frac{1.5 \cdot 10^{-4}}{\text{K}} \quad \Delta P := -4 \cdot \text{atm} \quad C_p = 4.19 \frac{\text{J}}{\text{gm} \cdot \text{K}}$$

Apply Eq. (7.25) to the constant-enthalpy throttling process. Assumes very small temperature change and property values independent of P.



$$\Delta T := \frac{-V \cdot \beta \cdot T \cdot P}{C_p} \cdot \left( \frac{1}{9.86923} \cdot \frac{\text{joule}}{\text{cm}^3 \cdot \text{atm}} \right) \quad \Delta T = 0.093 \text{ K}$$

The entropy change for this process is given by Eq. (7.26):

$$\Delta S := C_p \cdot \ln \left( \frac{T + \Delta T}{T} \right) - \beta \cdot V \cdot P \quad \Delta S = 1.408 \times 10^{-3} \frac{\text{J}}{\text{gm} \cdot \text{K}}$$

Apply Eq. (5.36) with Q=0:  $T_\sigma := 293.15 \cdot \text{K}$

$$W_{\text{lost}} := T_\sigma \Delta S \quad W_{\text{lost}} = 0.413 \frac{\text{J}}{\text{gm}} \quad \text{or} \quad W_{\text{lost}} = 0.413 \frac{\text{kJ}}{\text{kg}} \quad \text{Ans.}$$

7.13--7.15

$$P_2 := 1.2 \text{ bar}$$

$$T_1 := \begin{pmatrix} 350 \\ 350 \\ 250 \\ 400 \end{pmatrix} \text{ K}$$

$$P_1 := \begin{pmatrix} 80 \\ 60 \\ 60 \\ 20 \end{pmatrix} \text{ bar}$$

$$T_c := \begin{pmatrix} 304.2 \\ 282.3 \\ 126.2 \\ 369.8 \end{pmatrix} \text{ K}$$

$$P_c := \begin{pmatrix} 73.83 \\ 50.40 \\ 34.00 \\ 42.48 \end{pmatrix} \text{ bar}$$

$$\omega := \begin{pmatrix} .224 \\ .087 \\ .038 \\ .152 \end{pmatrix}$$

$$A := \begin{pmatrix} 5.457 \\ 1.424 \\ 3.280 \\ 1.213 \end{pmatrix}$$

$$B := \begin{pmatrix} 1.045 \\ 14.394 \\ .593 \\ 28.785 \end{pmatrix} \cdot \frac{10^{-3}}{\text{K}}$$

$$C := \begin{pmatrix} 0.0 \\ -4.392 \\ 0.0 \\ -8.824 \end{pmatrix} \cdot \frac{10^{-6}}{\text{K}^2}$$

$$D := \begin{pmatrix} -1.157 \\ 0.0 \\ 0.040 \\ 0.0 \end{pmatrix} \cdot 10^5 \cdot \text{K}^2$$

As in Example 7.4, Eq. (6.93) is applied to this constant-enthalpy process. If the final state at 1.2 bar is assumed an ideal gas, then Eq. (A) of Example 7.4 (pg. 265) applies. Its use requires expressions for HR and Cp at the initial conditions.

$$\overrightarrow{\text{Tr}} := \frac{\text{T1}}{\text{Tc}} \quad \overrightarrow{\text{Tr}} = \begin{pmatrix} 1.151 \\ 1.24 \\ 1.981 \\ 1.082 \end{pmatrix} \quad \overrightarrow{\text{Pr}} := \frac{\text{P1}}{\text{Pc}} \quad \overrightarrow{\text{Pr}} = \begin{pmatrix} 1.084 \\ 1.19 \\ 1.765 \\ 0.471 \end{pmatrix}$$

7.13 Redlich/Kwong equation:  $\Omega := 0.08664$   $\Psi := 0.42748$

$$\beta\Omega = \left( \frac{\text{Pr}}{\text{Tr}} \right) \quad \text{Eq. (3.53)} \quad q := \left( \frac{\Psi}{\Omega \cdot \text{Tr}^{1.5}} \right) \quad \text{Eq. (3.54)}$$

Guess:  $z := 1$

$$\text{Given} \quad z = 1 + \beta - q \cdot \beta \cdot \frac{z - \beta}{z \cdot (z + \beta)} \quad \text{Eq. (3.52)}$$

$Z(\beta, q) := \text{Find}(z)$

$$i := 1..4 \quad I_i := \ln \left( \frac{Z(\beta_i, q_i + \beta_i)}{Z(\beta_i, q_i)} \right) \quad \text{Eq. (6.65b)}$$

$$\text{HR}_i := R \cdot \text{T1}_i \cdot \left[ Z(\beta_i, q_i) - 1 - 1.5 \cdot q_i \cdot I_i \right] \quad \text{Eq. (6.67)} \quad \text{The derivative in these}$$

$$\text{SR}_i := R \cdot \ln \left( Z(\beta_i, q_i) - \beta_i - 0.5 \cdot q_i \cdot I_i \right) \quad \text{Eq. (6.68)} \quad \text{equations equals -0.5}$$

The simplest procedure here is to iterate by guessing T2, and then calculating it.

$$\text{Guesses} \quad \text{T2} := \begin{pmatrix} 280 \\ 302 \\ 232 \\ 385 \end{pmatrix} \text{K}$$

$$Z(\beta_i, q_i) = \begin{array}{|c|} \hline 0.721 \\ \hline 0.773 \\ \hline 0.956 \\ \hline 0.862 \\ \hline \end{array} \quad \text{HR} = \begin{pmatrix} -2.681 \\ -2.253 \\ -0.521 \\ -1.396 \end{pmatrix} \frac{\text{kJ}}{\text{mol}} \quad \text{SR} = \begin{pmatrix} -5.177 \\ -4.346 \\ -1.59 \\ -2.33 \end{pmatrix} \frac{\text{J}}{\text{mol}\cdot\text{K}}$$

$$\tau := \frac{T_2}{T_1} \quad C_p := \left[ R \cdot \left[ A + \frac{B}{2} \cdot \tau + 1 + \frac{C}{3} \cdot \tau^2 + \tau + 1 + \frac{D}{\tau \cdot T_1^2} \right] \right]$$

$$T_2 := \left( \frac{\text{HR}}{C_p} + T_1 \right) \quad \Delta S := \left( C_p \cdot \ln\left(\frac{T_2}{T_1}\right) - R \cdot \ln\left(\frac{P_2}{P_1}\right) - \text{SR} \right)$$

$$T_2 = \begin{pmatrix} 279.971 \\ 302.026 \\ 232.062 \\ 384.941 \end{pmatrix} \text{K} \quad \text{Ans.} \quad \Delta S = \begin{pmatrix} 31.545 \\ 29.947 \\ 31.953 \\ 22.163 \end{pmatrix} \frac{\text{J}}{\text{mol}\cdot\text{K}} \quad \text{Ans.}$$

7.14 Soave/Redlich/Kwong equation:  $\Omega := 0.08664$   $\Psi := 0.42748$

$$c := \left( 0.480 + 1.574 \cdot \omega - 0.176 \cdot \omega^2 \right) \quad \alpha := \left[ 1 + c \cdot \left( 1 - \text{Tr}^{0.5} \right) \right]^2$$

$$\beta\Omega = \left( \frac{Pr}{Tr} \right) \quad \text{Eq. (3.53)} \quad q := \left( \frac{\Psi\alpha}{\Omega \cdot Tr} \right) \quad \text{Eq. (3.54)}$$

Guess:  $z := 1$

$$\text{Given} \quad z = 1 + \beta - q \cdot \beta \cdot \frac{z - \beta}{z \cdot (z + \beta)} \quad \text{Eq. (3.52)} \quad Z(\beta, q) := \text{Find}(z)$$

$$i := 1..4 \quad I_i := \ln\left(\frac{Z(\beta_i, q_i) + \beta_i}{Z(\beta_i, q_i)}\right) \quad \text{Eq. (6.65b)}$$

$$\text{HR}_i := R \cdot T_{1i} \cdot \left[ Z(\beta_i, q_i) - 1 - \left[ c_i \cdot \left( \frac{Tr_i}{\alpha_i} \right)^{0.5} + 1 \right] \cdot q_i \cdot I_i \right] \quad \text{Eq. (6.67)}$$

$$SR_i := R \cdot \left[ \ln(Z(\beta_i, q_i) - \beta_i - c_i \cdot \left(\frac{Tr_i}{\alpha_i}\right)^{0.5} \cdot q_i \cdot I_i) \right] \quad \text{Eq. (6.68)}$$

The derivative in these equations equals:  $-c_i \cdot \left(\frac{Tr_i}{\alpha_i}\right)^{0.5}$

Now iterate for T2:

Guesses  $T2 := \begin{pmatrix} 273 \\ 300 \\ 232 \\ 384 \end{pmatrix} \text{K}$

$Z(\beta_i, q_i)$
0.75
0.79
0.975
0.866

$$= \begin{matrix} HR = \begin{pmatrix} -2.936 \\ -2.356 \\ -0.526 \\ -1.523 \end{pmatrix} \left| \frac{\text{kJ}}{\text{mol}} \right. \\ SR = \begin{pmatrix} -6.126 \\ -4.769 \\ -1.789 \\ -2.679 \end{pmatrix} \left| \frac{\text{J}}{\text{mol} \cdot \text{K}} \right. \end{matrix}$$

$$\tau := \frac{T2}{T1} \quad Cp := \left[ R \cdot \left[ A + \frac{B}{2} \cdot \tau + 1 + \frac{C}{3} \cdot \tau^2 + \tau + 1 + \frac{D}{\tau \cdot T1^2} \right] \right]$$

$$T2 := \left( \frac{HR}{Cp} + T1 \right)$$

$$T2 = \begin{pmatrix} 272.757 \\ 299.741 \\ 231.873 \\ 383.554 \end{pmatrix} \text{K} \quad \text{Ans.}$$

$$\Delta S := \left( Cp \cdot \ln\left(\frac{T2}{T1}\right) - R \cdot \ln\left(\frac{P2}{P1}\right) - SR \right)$$

$$\Delta S = \begin{pmatrix} 31.565 \\ 30.028 \\ 32.128 \\ 22.18 \end{pmatrix} \left| \frac{\text{J}}{\text{mol} \cdot \text{K}} \right. \quad \text{Ans.}$$

### 7.15 Peng/Robinson equation:

$$\sigma := 1 + \sqrt{2}$$

$$\varepsilon := 1 - \sqrt{2}$$

$$\Omega := 0.07779$$

$$\Psi := 0.45724$$

$$c := \left( 0.37464 + 1.54226 \cdot \omega - 0.26992 \cdot \omega^2 \right) \quad \alpha := \left[ 1 + c \cdot \left( 1 - \text{Tr}^{0.5} \right) \right]^2$$

$$\beta\Omega = \left( \frac{\text{Pr}}{\text{Tr}} \right) \quad \text{Eq. (3.53)} \quad q := \left( \frac{\Psi\alpha}{\Omega \cdot \text{Tr}} \right) \quad \text{Eq. (3.54)}$$

**Guess:**  $z := 1$

$$\text{Given } z = 1 + \beta - q \cdot \beta \cdot \frac{z - \beta}{(z + \varepsilon\beta) \cdot (z + \sigma\beta)} \quad \text{Eq. (3.52)}$$

$Z(\beta, q) := \text{Find}(z)$

$$i := 1..4 \quad I_i := \frac{1}{2 \cdot \sqrt{2}} \cdot \ln \left( \frac{Z(\beta_i, q_i + \sigma\beta_i)}{Z(\beta_i, q_i + \varepsilon\beta_i)} \right) \quad \text{Eq. (6.65b)}$$

$$\text{HR}_i := R \cdot T1_i \cdot \left[ Z(\beta_i, q_i) - 1 - \left[ c_i \cdot \left( \frac{\text{Tr}_i}{\alpha_i} \right)^{0.5} + 1 \right] \cdot q_i \cdot I_i \right] \quad \text{Eq. (6.67)}$$

$$\text{SR}_i := R \cdot \left[ \ln \left( Z(\beta_i, q_i) - \beta_i - c_i \cdot \left( \frac{\text{Tr}_i}{\alpha_i} \right)^{0.5} \cdot q_i \cdot I_i \right) \right] \quad \text{Eq. (6.68)}$$

**The derivative in these equations equals:**  $-c_i \cdot \left( \frac{\text{Tr}_i}{\alpha_i} \right)^{0.5}$

**Now iterate for T2:**

$$\text{Guesses } T2 := \begin{pmatrix} 270 \\ 297 \\ 229 \\ 383 \end{pmatrix} \text{K}$$

$$Z(\beta_i, q_i) = \begin{array}{|c|} \hline 0.722 \\ \hline 0.76 \\ \hline 0.95 \\ \hline 0.85 \\ \hline \end{array} \quad \text{HR} = \begin{pmatrix} -3.041 \\ -2.459 \\ -0.6 \\ -1.581 \end{pmatrix} \frac{\text{kJ}}{\text{mol}} \quad \text{SR} = \begin{pmatrix} -6.152 \\ -4.784 \\ -1.847 \\ -2.689 \end{pmatrix} \frac{\text{J}}{\text{mol}\cdot\text{K}}$$

$$\tau := \frac{T_2}{T_1} \quad C_p := \left[ R \cdot \left[ A + \frac{B}{2} \cdot T_1 \cdot () + 1 + \frac{C}{3} \cdot T_1^2 \cdot ()^2 + \tau + 1 + \frac{D}{\tau \cdot T_1^2} \right] \right]$$

$$T_2 := \left( \frac{\text{HR}}{C_p} + T_1 \right) \quad T_2 = \begin{pmatrix} 269.735 \\ 297.366 \\ 229.32 \\ 382.911 \end{pmatrix} \text{K} \quad \text{Ans.}$$

$$\Delta S := \left( C_p \cdot \ln \left( \frac{T_2}{T_1} \right) - R \cdot \ln \left( \frac{P_2}{P_1} \right) - \text{SR} \right) \quad \Delta S = \begin{pmatrix} 31.2 \\ 29.694 \\ 31.865 \\ 22.04 \end{pmatrix} \frac{\text{J}}{\text{mol}\cdot\text{K}} \quad \text{Ans.}$$

7.18  $\dot{W} := -3500 \cdot \text{kW}$

$$H_1 := 3462.9 \cdot \frac{\text{kJ}}{\text{kg}}$$

Data from Table F.2:

$$H_2 := 2609.9 \cdot \frac{\text{kJ}}{\text{kg}}$$

$$S_1 := 7.3439 \cdot \frac{\text{kJ}}{\text{kg}\cdot\text{K}}$$

By Eq. (7.13),

$$\dot{m} := \frac{\dot{W}}{H_2 - H_1}$$

$$\dot{m} = 4.103 \frac{\text{kg}}{\text{sec}} \quad \text{Ans.}$$

For isentropic expansion, exhaust is wet steam:

$$S_{\text{liq}} := 0.8321 \cdot \frac{\text{kJ}}{\text{kg}\cdot\text{K}}$$

$$S_{\text{vap}} := 7.9094 \cdot \frac{\text{kJ}}{\text{kg}\cdot\text{K}}$$

$$S_2 := S_1$$

$$x := \frac{S_2 - S_{\text{liq}}}{S_{\text{vap}} - S_{\text{liq}}}$$

$$x = 0.92 \quad \text{(quality)}$$

$$H_{\text{liq}} := 251.453 \cdot \frac{\text{kJ}}{\text{kg}}$$

$$H_{\text{vap}} := 2609.9 \cdot \frac{\text{kJ}}{\text{kg}}$$

$$H'_2 := H_{\text{liq}} + x \cdot (H_{\text{vap}} - H_{\text{liq}})$$

$$H'_2 = 2.421 \times 10^3 \frac{\text{kJ}}{\text{kg}}$$

$$\eta := \frac{H_2 - H_1}{H'_2 - H_1}$$

$$\eta = 0.819 \quad \text{Ans.}$$

7.19 The following vectors contain values for Parts (a) through (g). For intake conditions:

$$H_1 := \begin{pmatrix} 3274.3 \cdot \frac{\text{kJ}}{\text{kg}} \\ 3509.8 \cdot \frac{\text{kJ}}{\text{kg}} \\ 3634.5 \cdot \frac{\text{kJ}}{\text{kg}} \\ 3161.2 \cdot \frac{\text{kJ}}{\text{kg}} \\ 2801.4 \cdot \frac{\text{kJ}}{\text{kg}} \\ 1444.7 \cdot \frac{\text{Btu}}{\text{lb}_m} \\ 1389.6 \cdot \frac{\text{Btu}}{\text{lb}_m} \end{pmatrix}$$

$$S_1 := \begin{pmatrix} 6.5597 \cdot \frac{\text{kJ}}{\text{kg} \cdot \text{K}} \\ 6.8143 \cdot \frac{\text{kJ}}{\text{kg} \cdot \text{K}} \\ 6.9813 \cdot \frac{\text{kJ}}{\text{kg} \cdot \text{K}} \\ 6.4536 \cdot \frac{\text{kJ}}{\text{kg} \cdot \text{K}} \\ 6.4941 \cdot \frac{\text{kJ}}{\text{kg} \cdot \text{K}} \\ 1.6000 \cdot \frac{\text{Btu}}{\text{lb}_m \cdot \text{rankine}} \\ 1.5677 \cdot \frac{\text{Btu}}{\text{lb}_m \cdot \text{rankine}} \end{pmatrix}$$

$$\eta := \begin{pmatrix} 0.80 \\ 0.77 \\ 0.82 \\ 0.75 \\ 0.75 \\ 0.80 \\ 0.75 \end{pmatrix}$$

For discharge conditions:

$$S_{\text{liq}} := \begin{pmatrix} 0.9441 \cdot \frac{\text{kJ}}{\text{kg} \cdot \text{K}} \\ 0.8321 \cdot \frac{\text{kJ}}{\text{kg} \cdot \text{K}} \\ 0.6493 \cdot \frac{\text{kJ}}{\text{kg} \cdot \text{K}} \\ 1.0912 \cdot \frac{\text{kJ}}{\text{kg} \cdot \text{K}} \\ 1.5301 \cdot \frac{\text{kJ}}{\text{kg} \cdot \text{K}} \\ 0.1750 \cdot \frac{\text{Btu}}{\text{lb}_m \cdot \text{rankine}} \\ 0.2200 \cdot \frac{\text{Btu}}{\text{lb}_m \cdot \text{rankine}} \end{pmatrix}$$

$$S_{\text{vap}} := \begin{pmatrix} 7.7695 \cdot \frac{\text{kJ}}{\text{kg} \cdot \text{K}} \\ 7.9094 \cdot \frac{\text{kJ}}{\text{kg} \cdot \text{K}} \\ 8.1511 \cdot \frac{\text{kJ}}{\text{kg} \cdot \text{K}} \\ 7.5947 \cdot \frac{\text{kJ}}{\text{kg} \cdot \text{K}} \\ 7.1268 \cdot \frac{\text{kJ}}{\text{kg} \cdot \text{K}} \\ 1.9200 \cdot \frac{\text{Btu}}{\text{lb}_m \cdot \text{rankine}} \\ 1.8625 \cdot \frac{\text{Btu}}{\text{lb}_m \cdot \text{rankine}} \end{pmatrix}$$

$$S'_2 = S_1$$

$$H_{\text{liq}} := \begin{pmatrix} 289.302 \cdot \frac{\text{kJ}}{\text{kg}} \\ 251.453 \cdot \frac{\text{kJ}}{\text{kg}} \\ 191.832 \cdot \frac{\text{kJ}}{\text{kg}} \\ 340.564 \cdot \frac{\text{kJ}}{\text{kg}} \\ 504.701 \cdot \frac{\text{kJ}}{\text{kg}} \\ 94.03 \cdot \frac{\text{Btu}}{\text{lb}_m} \\ 120.99 \cdot \frac{\text{Btu}}{\text{lb}_m} \end{pmatrix}$$

$$H_{\text{vap}} := \begin{pmatrix} 2625.4 \cdot \frac{\text{kJ}}{\text{kg}} \\ 2609.9 \cdot \frac{\text{kJ}}{\text{kg}} \\ 2584.8 \cdot \frac{\text{kJ}}{\text{kg}} \\ 2646.0 \cdot \frac{\text{kJ}}{\text{kg}} \\ 2706.3 \cdot \frac{\text{kJ}}{\text{kg}} \\ 1116.1 \cdot \frac{\text{Btu}}{\text{lb}_m} \\ 1127.3 \cdot \frac{\text{Btu}}{\text{lb}_m} \end{pmatrix}$$

$$\text{mdot} := \begin{pmatrix} 80 \cdot \frac{\text{kg}}{\text{sec}} \\ 90 \cdot \frac{\text{kg}}{\text{sec}} \\ 70 \cdot \frac{\text{kg}}{\text{sec}} \\ 65 \cdot \frac{\text{kg}}{\text{sec}} \\ 50 \cdot \frac{\text{kg}}{\text{sec}} \\ 150 \cdot \frac{\text{lb}_m}{\text{sec}} \\ 100 \cdot \frac{\text{lb}_m}{\text{sec}} \end{pmatrix}$$



$$x'_2 := \frac{S_1 - S_{liq}}{S_{vap} - S_{liq}}$$

$$H'_2 := [H_{liq} + x'_2 \cdot (H_{vap} - H_{liq})]$$

$$\Delta H := [\eta \cdot (H'_2 - H_1)]$$

$$H_2 := H_1 + \Delta H \quad \dot{W} := (\Delta H \cdot \dot{m})$$

$$x_2 := \frac{H_2 - H_{liq}}{H_{vap} - H_{liq}}$$

$$S_2 := [S_{liq} + x_2 \cdot (S_{vap} - S_{liq})]$$

$$\begin{pmatrix} H_{2_1} \\ H_{2_2} \\ H_{2_3} \\ H_{2_4} \\ H_{2_5} \end{pmatrix} = \begin{pmatrix} 2423.9 \\ 2535.9 \\ 2467.8 \\ 2471.4 \\ 2543.4 \end{pmatrix} \frac{\text{kJ}}{\text{kg}}$$

$$\begin{pmatrix} S_{2_1} \\ S_{2_2} \\ S_{2_3} \\ S_{2_4} \\ S_{2_5} \end{pmatrix} = \begin{pmatrix} 7.1808 \\ 7.6873 \\ 7.7842 \\ 7.1022 \\ 6.7127 \end{pmatrix} \frac{\text{kJ}}{\text{kg} \cdot \text{K}}$$

**Ans.**

$$\begin{pmatrix} H_{2_6} \\ H_{2_7} \end{pmatrix} = \begin{pmatrix} 1031.9 \\ 1057.4 \end{pmatrix} \frac{\text{Btu}}{\text{lb}_m}$$

$$\begin{pmatrix} S_{2_6} \\ S_{2_7} \end{pmatrix} = \begin{pmatrix} 1.7762 \\ 1.7484 \end{pmatrix} \frac{\text{Btu}}{\text{lb}_m \cdot \text{rankine}}$$

$$\dot{W} = \begin{pmatrix} -68030 \\ -87653 \\ -81672 \\ -44836 \\ -12900 \\ -65333 \\ -35048 \end{pmatrix} \text{ kW}$$

$$\dot{W} = \begin{pmatrix} -91230 \\ -117544 \\ -109523 \\ -60126 \\ -17299 \\ -87613 \\ -46999 \end{pmatrix} \text{ hp}$$

**Ans.**

7.20  $T := 423.15 \cdot \text{K}$        $P_0 := 8.5 \cdot \text{bar}$        $P := 1 \cdot \text{bar}$

For isentropic expansion,

$$\Delta S := 0 \cdot \frac{\text{J}}{\text{mol} \cdot \text{K}}$$

For the heat capacity of nitrogen:

$$A := 3.280 \quad B := \frac{0.593 \cdot 10^{-3}}{\text{K}} \quad D := 0.040 \cdot 10^5 \cdot \text{K}^2$$

For the entropy change of an ideal gas, combine Eqs. (5.14) & (5.15) with  $C = 0$ . Substitute:

$$\tau := 0.5 \quad (\text{guess})$$

Given

$$\Delta S = R \cdot \left[ A \cdot \ln(\tau) + \left[ B \cdot \frac{T}{\tau} + \frac{D}{T^2} \cdot \left( \frac{\tau + 1}{2} \right) \right] \cdot (\tau - 1) - \ln\left(\frac{P}{P_0}\right) \right]$$

$$\tau := \text{Find}(\tau) \quad T_0 := \frac{T}{\tau} \quad T_0 = 762.42 \text{ K} \quad \text{Ans.}$$

Thus the initial temperature is 489.27 degC

7.21  $T_1 := 1223.15 \cdot \text{K}$        $P_1 := 10 \cdot \text{bar}$        $P_2 := 1.5 \cdot \text{bar}$

$$C_P := 32 \cdot \frac{\text{J}}{\text{mol} \cdot \text{K}} \quad \eta := 0.77$$

Eqs. (7.18) and (7.19) derived for isentropic compression apply equally well for isentropic expansion. They combine to give:

$$W'_s := C_P \cdot T_1 \cdot \left[ \left( \frac{P_2}{P_1} \right)^{\frac{R}{C_P}} - 1 \right] \quad W'_s = -15231 \frac{\text{J}}{\text{mol}}$$

$$W_s := \eta \cdot W'_s \quad \Delta H := W_s \quad W_s = -11728 \frac{\text{J}}{\text{mol}} \quad \text{Ans.}$$

Eq. (7.21) also applies to expansion:

$$T_2 := T_1 + \frac{\Delta H}{C_P} \quad T_2 = 856.64 \text{ K} \quad \text{Ans.}$$

7.22 Isobutane:  $T_c := 408.1 \cdot \text{K}$   $P_c := 36.48 \cdot \text{bar}$   $\omega := 0.181$   
 $T_0 := 523.15 \cdot \text{K}$   $P_0 := 5000 \cdot \text{kPa}$   $P := 500 \cdot \text{kPa}$

$$\Delta S := 0 \cdot \frac{\text{J}}{\text{mol} \cdot \text{K}}$$

For the heat capacity of isobutane:

$$A := 1.677 \quad B := \frac{37.853 \cdot 10^{-3}}{\text{K}} \quad C := \frac{-11.945 \cdot 10^{-6}}{\text{K}^2}$$

$$T_{r0} := \frac{T_0}{T_c} \quad T_{r0} = 1.282 \quad P_{r0} := \frac{P_0}{P_c} \quad P_{r0} = 1.3706$$

$$P_r := \frac{P}{P_c} \quad P_r = 0.137$$

The entropy change is given by Eq. (6.92) combined with Eq. (5.15) with  $D = 0$ :

$$\tau := 0.5 \quad (\text{guess})$$

Given

$$\Delta S = R \cdot \left[ A \cdot \ln(\tau) + \left[ B \cdot T_0 + C \cdot T_0^2 \cdot \left( \frac{\tau + 1}{2} \right) \right] \cdot (\tau - 1) - \ln \left( \frac{P}{P_0} \right) \dots \right]$$

$$\left[ + \text{SRB} \left( \frac{\tau \cdot T_0}{T_c}, \mathbf{B}_r \right) - \text{SRB} \left( T_{r0}, \mathbf{B}_{r0} \right) \right]$$

$$\tau := \text{Find}(\tau) \quad T := \tau \cdot T_0 \quad T = 445.71 \text{ K}$$

$$T_r := \frac{T}{T_c} \quad T_r = 1.092$$

The enthalpy change is given by Eq. (6.91):

$$\Delta H_{ig} := R \cdot \text{ICPH}(T_0, T, 1.677, 37.853 \cdot 10^{-3}, -11.945 \cdot 10^{-6}, 0.0)$$

$$\Delta H_{ig} = -11.078 \frac{\text{kJ}}{\text{mol}}$$

$$\Delta H' := \Delta H_{ig} + R \cdot T_c \cdot \left( \text{HRB}(T_r, \theta_r) - \text{HRB}(T_{r0}, \theta_{r0}) \right)$$

$$\Delta H' = -8331.4 \frac{\text{J}}{\text{mol}}$$

The actual enthalpy change from Eq. (7.16):

$$\eta := 0.8 \quad \dot{n} := 700 \frac{\text{mol}}{\text{sec}} \quad \Delta H := \eta \Delta H' \quad \Delta H = -6665.1 \frac{\text{J}}{\text{mol}}$$

$$\dot{W} := \dot{n} \cdot \Delta H \quad \dot{W} = -4665.6 \text{ kW} \quad \text{Ans.}$$

The actual final temperature is now found from Eq. (6.91) combined with Eq (4.7), written:

$$\tau := 0.7 \quad (\text{guess})$$

Given

$$\Delta H = R \cdot \left[ A \cdot T_0 \cdot (\tau) - 1 + \frac{B}{2} \cdot T_0^2 \cdot (\tau)^2 - 1 + \frac{C}{3} \cdot T_0^3 \cdot (\tau)^3 - 1 \dots \right] + T_c \cdot \left( \text{HRB}\left(\frac{\tau \cdot T_0}{T_c}, \theta_r\right) - \text{HRB}(T_{r0}, \theta_{r0}) \right)$$

$$\tau := \text{Find}(\tau) \quad \tau = 0.875 \quad T := \tau \cdot T_0 \quad T = 457.8 \text{ K} \quad \text{Ans.}$$

7.23 From Table F.2 @ 1700 kPa & 225 degC:

$$H_1 := 2851.0 \frac{\text{kJ}}{\text{kg}}$$

$$S_1 := 6.5138 \frac{\text{kJ}}{\text{kg} \cdot \text{K}}$$

At 10 kPa:

$$x_2 := 0.95$$

$$S_{\text{liq}} := 0.6493 \frac{\text{kJ}}{\text{kg} \cdot \text{K}}$$

$$H_{\text{liq}} := 191.832 \cdot \frac{\text{kJ}}{\text{kg}}$$

$$H_{\text{vap}} := 2584.8 \cdot \frac{\text{kJ}}{\text{kg}}$$

$$S_{\text{vap}} := 8.1511 \cdot \frac{\text{kJ}}{\text{kg} \cdot \text{K}}$$

$$\dot{m} := 0.5 \cdot \frac{\text{kg}}{\text{sec}}$$

$$\dot{W} := -180 \cdot \text{kW}$$

$$H_2 := H_{\text{liq}} + x_2 \cdot (H_{\text{vap}} - H_{\text{liq}})$$

$$\Delta H := H_2 - H_1$$

$$H_2 = 2.465 \times 10^3 \frac{\text{kJ}}{\text{kg}}$$

$$\Delta H = -385.848 \frac{\text{kJ}}{\text{kg}}$$

(a)  $\dot{Q} := \dot{m} \cdot \Delta H - \dot{W}$

$$\dot{Q} = -12.92 \frac{\text{kJ}}{\text{sec}}$$

Ans.

(b) For isentropic expansion to 10 kPa, producing wet steam:

$$x'_2 := \frac{S_1 - S_{\text{liq}}}{S_{\text{vap}} - S_{\text{liq}}}$$

$$H'_2 := H_{\text{liq}} + x'_2 \cdot (H_{\text{vap}} - H_{\text{liq}})$$

$$x'_2 = 0.782$$

$$H'_2 = 2.063 \times 10^3 \frac{\text{kJ}}{\text{kg}}$$

$$\dot{W}' := \dot{m} \cdot (H'_2 - H_1)$$

$$\dot{W}' = -394.2 \text{ kW}$$

Ans.

7.24  $T_0 := 673.15 \cdot \text{K}$

$$P_0 := 8 \cdot \text{bar}$$

$$P := 1 \cdot \text{bar}$$

For isentropic expansion,

For the heat capacity of carbon dioxide:

$$\Delta S := 0 \cdot \frac{\text{J}}{\text{mol} \cdot \text{K}}$$

$$A := 5.457$$

$$B := \frac{1.045 \cdot 10^{-3}}{\text{K}}$$

$$D := -1.157 \cdot 10^5 \cdot \text{K}^2$$

For the entropy change of an ideal gas, combine Eqs. (5.14) & (5.15) with  $C = 0$ :

$$\tau := 0.5 \quad (\text{guess})$$

Given

$$\Delta S = R \cdot \left[ A \cdot \ln(\tau) + \left[ B \cdot T_0 + \frac{D}{(T_0 \cdot \tau)^2} \cdot \left( \frac{\tau + 1}{2} \right) \right] \cdot (\tau - 1) - \ln\left(\frac{P}{P_0}\right) \right]$$

$$\tau := \text{Find}(\tau)$$

$$\tau = 0.693$$

$$T' := \tau \cdot T_0$$

$$T' = 466.46 \text{ K}$$

$$\Delta H' := R \cdot \text{ICPH}(T_0, T', 5.457, 1.045 \cdot 10^{-3}, 0.0, -1.157 \cdot 10^5)$$

$$\Delta H' = -9.768 \frac{\text{kJ}}{\text{mol}}$$

$$\eta := 0.75$$

$$\text{Work} := \eta \Delta H'$$

$$\text{Work} = -7.326 \frac{\text{kJ}}{\text{mol}} \quad \text{Ans.}$$

$$\Delta H := \text{Work}$$

$$\Delta H = -7.326 \frac{\text{kJ}}{\text{mol}}$$

For the enthalpy change of an ideal gas, combine Eqs. (4.2) and (4.7) with  $C = 0$ :

Given

$$\Delta H = R \cdot \left[ A \cdot T_0 \cdot (\tau - 1) + \frac{B}{2} \cdot T_0^2 \cdot (\tau^2 - 1) + \frac{D}{T_0} \cdot \left( \frac{\tau - 1}{\tau} \right) \right]$$

$$\tau := \text{Find}(\tau)$$

$$\tau = 0.772$$

$$T := \tau \cdot T_0$$

$$T = 519.9 \text{ K}$$

Ans.

Thus the final temperature is 246.75 degC

## 7.25 Vectors containing data for Parts (a) through (e):

$$T1 := \begin{pmatrix} 500 \\ 450 \\ 525 \\ 475 \\ 550 \end{pmatrix}$$

$$P1 := \begin{pmatrix} 6 \\ 5 \\ 10 \\ 7 \\ 4 \end{pmatrix}$$

$$T2 := \begin{pmatrix} 371 \\ 376 \\ 458 \\ 372 \\ 403 \end{pmatrix}$$

$$P2 := \begin{pmatrix} 1.2 \\ 2.0 \\ 3.0 \\ 1.5 \\ 1.2 \end{pmatrix}$$

$$Cp := \begin{pmatrix} 3.5 \\ 4.0 \\ 5.5 \\ 4.5 \\ 2.5 \end{pmatrix} \cdot R$$

$$\Delta H := \overrightarrow{[Cp \cdot (T2 - T1)]}$$

Ideal gases with constant heat capacities

$$\Delta H_S := \overrightarrow{\left[ Cp \cdot T1 \cdot \left[ \left( \frac{P2}{P1} \right)^{\frac{R}{Cp}} - 1 \right] \right]}$$

Eq. (7.22) Applies to expanders as well as to compressors

$$\eta := \frac{\Delta H}{\Delta H_S} \rightarrow \eta = \begin{pmatrix} 0.7 \\ 0.803 \\ 0.649 \\ 0.748 \\ 0.699 \end{pmatrix}$$

7.26  $C_p := \frac{7}{2} \cdot R$   $\dot{n} := 175 \frac{\text{mol}}{\text{sec}}$   $T_1 := 550\text{K}$   $P_1 := 6\text{bar}$   $P_2 := 1.2\text{bar}$

**Guesses:**  $\eta := 0.75$   $\dot{W} := 600\text{kW}$

Given

$$\dot{W} = - \left( 0.065 + 0.08 \cdot \ln \left( \frac{\dot{W}}{\text{kW}} \right) \right) \cdot \dot{n} \cdot C_p \cdot T_1 \cdot \left[ \left( \frac{P_2}{P_1} \right)^{\frac{R}{C_p}} - 1 \right]$$

$\dot{W} := \text{Find}(\dot{W})$   $\dot{W} = 594.716\text{kW}$  **Ans.**

$\eta := \left( 0.065 + 0.08 \cdot \ln \left( \frac{\dot{W}}{\text{kW}} \right) \right)$   $\eta = 0.576$  **Ans.**

**For an expander operating with an ideal gas with constant  $C_p$ , one can show that:**

$$T_2 := T_1 \cdot \left[ 1 + \eta \cdot \left[ \left( \frac{P_2}{P_1} \right)^{\frac{R}{C_p}} - 1 \right] \right]$$

$T_2 = 433.213\text{K}$

**By Eq. (5.14):**

$$\Delta S := R \cdot \left( \frac{C_p}{R} \cdot \ln \left( \frac{T_2}{T_1} \right) - \ln \left( \frac{P_2}{P_1} \right) \right)$$

$\Delta S = 6.435 \frac{\text{J}}{\text{mol} \cdot \text{K}}$

**By Eq. (5.37), for adiabatic operation :**

$\dot{S}_{\text{dotG}} := \dot{n} \cdot \Delta S$   $\dot{S}_{\text{dotG}} = 1.126 \times 10^3 \frac{\text{J}}{\text{K} \cdot \text{sec}}$  **Ans.**

7.27 Properties of superheated steam at 4500 kPa and 400 C from Table F.2, p. 742.

$$H1 := 3207.1$$

$$S1 := 6.7093$$

If the exhaust steam (Point 2, Fig. 7.4) is "dry," i.e., saturated vapor, then isentropic expansion to the same pressure (Point 2', Fig. 7.4) must produce "wet" steam, with entropy:

$$S2 = S1 = 6.7093 = (x)(S_{\text{vap}}) + (1-x)(S_{\text{liq}}) \quad [x \text{ is quality}]$$

A second relation follows from Eq. (7.16), written:

$$\Delta H = H_{\text{vap}} - 3207.1 = (\eta)(\Delta H_S) = (0.75)[(x)(H_{\text{vap}}) + (1-x)(H_{\text{liq}}) - 3207.1]$$

Each of these equations may be solved for  $x$ . Given a final temperature and the corresponding vapor pressure, values for  $S_{\text{vap}}$ ,  $S_{\text{liq}}$ ,  $H_{\text{vap}}$ , and  $H_{\text{liq}}$  are found from the table for saturated steam, and substitution into the equations for  $x$  produces two values. The required pressure is the one for which the two values of  $x$  agree. This is clearly a trial process. For a final trial temperature of 120 degC, the following values of  $H$  and  $S$  for saturated liquid and saturated vapor are found in the steam table:

$$Hl := 503.7$$

$$Hv := 2706.0$$

$$Sl := 1.5276$$

$$Sv := 7.1293$$

The two equations for  $x$  are:

$$x_H := \frac{Hv - 801.7 - .75 \cdot Hl}{.75 \cdot (Hv - Hl)} \quad x_S := \frac{6.7093 - S1}{Sv - S1}$$

The trial values given produce:  $x_H = 0.924$   $x_S = 0.925$

These are sufficiently close, and we conclude that:

$$t=120 \text{ degC}; \quad P=198.54 \text{ kPa}$$

If  $\eta$  were 0.8, the pressure would be higher, because a smaller pressure drop would be required to produce the same work and  $\Delta H$ .



7.29  $P1 := 5 \cdot \text{atm}$        $P2 := 1 \cdot \text{atm}$        $T1 := 15 \cdot \text{degC}$        $\eta := 0.55$

Data in Table F.1 for saturated liquid water at 15 degC give:

$$V := 1001 \cdot \frac{\text{cm}^3}{\text{kg}}$$

$$Cp := 4.190 \cdot \frac{\text{kJ}}{\text{kg} \cdot \text{degC}}$$

Eqs. (7.16) and (7.24) combine to give:  $\Delta H := \eta \cdot V \cdot (P2 - P1)$

$$W_s := \Delta H \quad (7.14) \quad W_s = -0.223 \frac{\text{kJ}}{\text{kg}}$$

Eq. (7.25) with  $\beta=0$  is solved for  $\Delta T$ :  $\Delta T := \frac{\Delta H - V \cdot (P2 - P1)}{Cp}$

$$\Delta T = 0.044 \text{ degC} \quad \text{Ans.}$$

7.30 Assume nitrogen an ideal gas. First find the temperature after isentropic expansion from a combination of Eqs. (5.14) & (5.15) with  $C = 0$ . Then find the work (enthalpy change) of isentropic expansion by a combination of Eqs. (4.2) and (4.7) with  $C = 0$ . The actual work (enthalpy change) is found from Eq. (7.20). From this value, the actual temperature is found by a second application of the preceding equation, this time solving it for the temperature. The following vectors contain values for Parts (a) through (e):

$$T_0 := \begin{pmatrix} 753.15 \\ 673.15 \\ 773.15 \\ 723.15 \\ 755.37 \end{pmatrix} \cdot \text{K}$$

$$P_0 := \begin{pmatrix} 6 \cdot \text{bar} \\ 5 \cdot \text{bar} \\ 7 \cdot \text{bar} \\ 8 \cdot \text{bar} \\ 95 \cdot \text{psi} \end{pmatrix}$$

$$P := \begin{pmatrix} 1 \cdot \text{bar} \\ 1 \cdot \text{bar} \\ 1 \cdot \text{bar} \\ 2 \cdot \text{bar} \\ 15 \cdot \text{psi} \end{pmatrix}$$

$$\text{ndot} := \begin{pmatrix} 200 \\ 150 \\ 175 \\ 100 \\ 0.5 \cdot 453.59 \end{pmatrix} \cdot \frac{\text{mol}}{\text{sec}}$$

$$\eta := \begin{pmatrix} 0.80 \\ 0.75 \\ 0.78 \\ 0.85 \\ 0.80 \end{pmatrix}$$

$$\Delta S := 0 \cdot \frac{\text{J}}{\text{mol} \cdot \text{K}}$$

$$i := 1..5$$

**For the heat capacity of nitrogen:**

$$A := 3.280 \quad B := \frac{0.593 \cdot 10^{-3}}{K} \quad D := 0.040 \cdot 10^5 \cdot K^2$$

$$\tau := 0.5 \quad (\text{guess})$$

Given

$$\Delta S = R \cdot \left[ A \cdot \ln(\tau) + \left[ B \cdot T_0 + \frac{D}{T_0^2 \cdot \tau^2} \cdot \left( \frac{\tau + 1}{2} \right) \right] \cdot (\tau - 1) - \ln\left(\frac{P}{P_0}\right) \right]$$

$$\text{Tau}(T_0, P_0, P) := \text{Find}(\tau) \quad \tau_i := \text{Tau}(T_{0_i}, P_{0_i}, P_i)$$

$$T_i := T_{0_i} \cdot \tau_i \quad T = \begin{pmatrix} 460.67 \\ 431.36 \\ 453.48 \\ 494.54 \\ 455.14 \end{pmatrix} K$$

$$\Delta H'_i := R \cdot \text{ICPH}(T_{0_i}, T_i, 3.280, 0.593 \cdot 10^{-3}, 0.0, 0.040 \cdot 10^5)$$

$$\Delta H' = \begin{pmatrix} -8879.2 \\ -7279.8 \\ -9714.4 \\ -6941.7 \\ -9112.1 \end{pmatrix} \frac{J}{\text{mol}} \quad \Delta H := \overrightarrow{(\Delta H' \cdot \eta)} \quad \Delta H = \begin{pmatrix} -7103.4 \\ -5459.8 \\ -7577.2 \\ -5900.5 \\ -7289.7 \end{pmatrix} \frac{J}{\text{mol}}$$

$$\tau := 0.5 \quad (\text{guess})$$

Given

$$\Delta H = R \cdot \left[ A \cdot \tau_0 \cdot (\tau - 1) + \frac{B}{2} \cdot \tau_0^2 \cdot (\tau^2 - 1) + \frac{D}{T_0} \cdot \left( \frac{\tau - 1}{\tau} \right) \right]$$

$$\text{Tau}(T_0, \Delta H) := \text{Find}(\tau) \quad \tau_i := \text{Tau}(T_{0_i}, \Delta H_i) \quad T_i := T_{0_i} \cdot \tau_i$$

$$T = \begin{pmatrix} 520.2 \\ 492.62 \\ 525.14 \\ 529.34 \\ 516.28 \end{pmatrix} \text{ K} \quad \text{Ans.} \quad \dot{W} := \dot{m} \cdot \Delta H \quad \dot{W} = \begin{pmatrix} -1421 \\ -819 \\ -1326 \\ -590 \\ -1653 \end{pmatrix} \text{ kW} \quad \text{Ans.}$$

**7.31 Property values and data from Example 7.6:**

$$H_1 := 3391.6 \cdot \frac{\text{kJ}}{\text{kg}}$$

$$S_1 := 6.6858 \cdot \frac{\text{kJ}}{\text{kg} \cdot \text{K}}$$

$$\dot{m} := 59.02 \cdot \frac{\text{kg}}{\text{sec}}$$

$$H_2 := 2436.0 \cdot \frac{\text{kJ}}{\text{kg}}$$

$$S_2 := 7.6846 \cdot \frac{\text{kJ}}{\text{kg} \cdot \text{K}}$$

$$\dot{W} := -56400 \cdot \text{kW}$$

$$T_\sigma := 300 \cdot \text{K}$$

By Eq. (5.26)

$$\dot{W}_{\text{ideal}} := \dot{m} \cdot \left[ H_2 - H_1 - T_\sigma \cdot (S_2 - S_1) \right] \quad \dot{W}_{\text{ideal}} = -74084 \text{ kW}$$

$$\eta_t := \frac{\dot{W}}{\dot{W}_{\text{ideal}}} \quad \eta_t = 0.761 \quad \text{Ans.}$$

The process is adiabatic; Eq. (5.33) becomes:

$$\dot{S}_{\text{G}} := \dot{m} \cdot (S_2 - S_1) \quad \dot{S}_{\text{G}} = 58.949 \frac{\text{kW}}{\text{K}} \quad \text{Ans.}$$

$$\dot{W}_{\text{lost}} := T_\sigma \cdot \dot{S}_{\text{G}} \quad \dot{W}_{\text{lost}} = 17685 \text{ kW} \quad \text{Ans.}$$

**7.32 For sat. vapor steam at 1200 kPa, Table F.2:**

$$H_2 := 2782.7 \cdot \frac{\text{kJ}}{\text{kg}}$$

$$S_2 := 6.5194 \cdot \frac{\text{kJ}}{\text{kg} \cdot \text{K}}$$

The saturation temperature is 187.96 degC.

The exit temperature of the exhaust gas is therefore 197.96 degC, and the temperature CHANGE of the exhaust gas is -202.04 K.

For the water at 20 degC from Table F.1,

$$H_1 := 83.86 \cdot \frac{\text{kJ}}{\text{kg}}$$

$$S_1 := 0.2963 \cdot \frac{\text{kJ}}{\text{kg} \cdot \text{K}}$$

The turbine exhaust will be wet vapor steam.

For sat. liquid and sat. vapor at the turbine exhaust pressure of 25 kPa, the best property values are found from Table F.1 by interpolation between 64 and 65 degC:

$$H_{\text{liq}} := 272.0 \cdot \frac{\text{kJ}}{\text{kg}}$$

$$H_{\text{lv}} := 2346.3 \cdot \frac{\text{kJ}}{\text{kg}}$$

$$S_{\text{liq}} := 0.8932 \cdot \frac{\text{kJ}}{\text{kg} \cdot \text{K}}$$

$$S_{\text{lv}} := 6.9391 \cdot \frac{\text{kJ}}{\text{kg} \cdot \text{K}}$$

$$\eta := 0.72$$

For isentropic expansion of steam in the turbine:

$$S'_3 := S_2$$

$$x'_3 := \frac{S'_3 - S_{\text{liq}}}{S_{\text{lv}}}$$

$$H'_3 := H_{\text{liq}} + x'_3 \cdot H_{\text{lv}}$$

$$S'_3 = 6.519 \cdot \frac{\text{kJ}}{\text{kg} \cdot \text{K}}$$

$$x'_3 = 0.811$$

$$H'_3 = 2.174 \times 10^3 \frac{\text{kJ}}{\text{kg}}$$

$$\Delta H_{23} := \eta \cdot (H'_3 - H_2)$$

$$H_3 := H_2 + \Delta H_{23}$$

$$\Delta H_{23} = -437.996 \frac{\text{kJ}}{\text{kg}}$$

$$H_3 = 2.345 \times 10^3 \frac{\text{kJ}}{\text{kg}}$$

$$x_3 := \frac{H_3 - H_{\text{liq}}}{H_{\text{lv}}}$$

$$S_3 := S_{\text{liq}} + x_3 \cdot S_{\text{lv}}$$

$$x_3 = 0.883$$

$$S_3 = 7.023 \frac{\text{kJ}}{\text{kg} \cdot \text{K}}$$

For the exhaust gases:

$$\dot{n} := 125 \cdot \frac{\text{mol}}{\text{sec}}$$

$$T_1 := (273.15 + 400) \cdot \text{K}$$

$$T_2 := (273.15 + 197.96) \cdot \text{K}$$

$$T_1 = 673.15 \text{ K}$$

$$T_2 = 471.11 \text{ K}$$

$$\text{molwt} := 18 \frac{\text{gm}}{\text{mol}}$$

$$\Delta H_{\text{gas}} := R \cdot \text{MCPH}(T_1, T_2, 3.34, 1.12 \cdot 10^{-3}, 0.0, 0.0) \cdot (T_2 - T_1)$$

$$\Delta S_{\text{gas}} := R \cdot \text{MCPS}(T_1, T_2, 3.34, 1.12 \cdot 10^{-3}, 0.0, 0.0) \cdot \ln\left(\frac{T_2}{T_1}\right)$$

$$\Delta H_{\text{gas}} = -6.687 \times 10^3 \frac{\text{kJ}}{\text{kmol}}$$

$$\Delta S_{\text{gas}} = -11.791 \frac{\text{kJ}}{\text{kmol} \cdot \text{K}}$$

**Energy balance on boiler:**

$$\dot{m} := \frac{-\dot{Q} \cdot H_{\text{gas}}}{H_2 - H_1}$$

$$\dot{m} = 0.30971 \frac{\text{kg}}{\text{sec}}$$

(a)  $\dot{W} := \dot{m} \cdot (H_3 - H_2)$

$$\dot{W} = -135.65 \text{ kW} \quad \text{Ans.}$$

(b) **By Eq. (5.25):**

$$T_{\sigma} := 293.15 \cdot \text{K}$$

$$\begin{aligned} \dot{W}_{\text{ideal}} := & \dot{n} \cdot \Delta H_{\text{gas}} + \dot{m} \cdot (H_3 - H_1) \dots \\ & + -T_{\sigma} \cdot [ \dot{n} \cdot \Delta S_{\text{gas}} + \dot{m} \cdot (S_3 - S_1) ] \end{aligned}$$

$$\dot{W}_{\text{ideal}} = -314.302 \text{ kW} \quad \eta_t := \frac{\dot{W}}{\dot{W}_{\text{ideal}}} \quad \eta_t = 0.4316 \quad \text{Ans.}$$

(c) **For both the boiler and the turbine, Eq. (5.33) applies with  $Q = 0$ .**  
**For the boiler:**

$$\dot{S}_{\text{G}} := \dot{n} \cdot \Delta S_{\text{gas}} + \dot{m} \cdot (S_2 - S_1)$$

**Boiler:**  $\dot{S}_{\text{G}} = 0.4534 \frac{\text{kW}}{\text{K}} \quad \text{Ans.}$

**For the turbine:**  $\dot{S}_{\text{G}} := \dot{m} \cdot (S_3 - S_2)$

**Turbine:**  $\dot{S}_{\text{G}} = 0.156 \frac{\text{kW}}{\text{K}} \quad \text{Ans.}$

(d)  $\dot{W}_{\text{lost.boiler}} := 0.4534 \cdot \frac{\text{kW}}{\text{K}} \cdot T_{\sigma} \quad \dot{W}_{\text{lost.boiler}} = 132.914 \text{ kW}$

$$\dot{W}_{\text{lost.turbine}} := 0.1560 \cdot \frac{\text{kW}}{\text{K}} \cdot T_{\sigma} \quad \dot{W}_{\text{lost.turbine}} = 45.731 \text{ kW}$$

$$\text{Fraction}_{\text{boiler}} := \frac{\dot{W}_{\text{lost.boiler}}}{|\dot{W}_{\text{ideal}}|} \quad \text{Fraction}_{\text{boiler}} = 0.4229 \quad \text{Ans.}$$

$$\text{Fraction}_{\text{turbine}} := \frac{\dot{W}_{\text{lost,turbine}}}{|\dot{W}_{\text{ideal}}|} \quad \text{Fraction}_{\text{turbine}} = 0.1455 \quad \text{Ans.}$$

**Note that:**  $\eta_t + \text{Fraction}_{\text{boiler}} + \text{Fraction}_{\text{turbine}} = 1$

**7.34 From Table F.2 for sat. vap. at 125 kPa:**

$$H_1 := 2685.2 \cdot \frac{\text{kJ}}{\text{kg}}$$

$$S_1 := 7.2847 \cdot \frac{\text{kJ}}{\text{kg} \cdot \text{K}}$$

For isentropic expansion,  $S'_2 = S_1 = 7.2847 \cdot \frac{\text{kJ}}{\text{kg} \cdot \text{K}}$

**Interpolation in Table F.2 at 700 kPa for the enthalpy of steam with this entropy gives**

$$H'_2 := 3051.3 \cdot \frac{\text{kJ}}{\text{kg}}$$

$$\eta := 0.78$$

$$\Delta H := \frac{H'_2 - H_1}{\eta}$$

$$\Delta H = 469.359 \cdot \frac{\text{kJ}}{\text{kg}}$$

$$H_2 := H_1 + \Delta H$$

$$H_2 = 3154.6 \cdot \frac{\text{kJ}}{\text{kg}}$$

**Ans.**

**Interpolation in Table F.2 at 700 kPa for the entropy of steam with this enthalpy gives**

$$S_2 := 7.4586 \cdot \frac{\text{kJ}}{\text{kg} \cdot \text{K}}$$

**Ans.**

$$\dot{m} := 2.5 \cdot \frac{\text{kg}}{\text{sec}}$$

$$\dot{W} := \dot{m} \cdot \Delta H$$

$$\dot{W} = 1173.4 \text{ kW}$$

**Ans.**

7.35 Assume air an ideal gas. First find the temperature after isentropic compression from a combination of Eqs. (5.14) & (5.15) with  $C = 0$ . Then find the work (enthalpy change) of isentropic compression by a combination of Eqs. (4.2) and (4.7) with  $C = 0$ . The actual work (enthalpy change) is found from Eq. (7.20). From this value, the actual temperature is found by a second application of the preceding equation, this time solving it for the temperature. The following vectors contain values for Parts (a) through (f):

$$T_0 := \begin{pmatrix} 298.15 \\ 353.15 \\ 303.15 \\ 373.15 \\ 299.82 \\ 338.71 \end{pmatrix} \cdot \text{K}$$

$$P_0 := \begin{pmatrix} 101.33 \cdot \text{kPa} \\ 375 \cdot \text{kPa} \\ 100 \cdot \text{kPa} \\ 500 \cdot \text{kPa} \\ 14.7 \cdot \text{psi} \\ 55 \cdot \text{psi} \end{pmatrix}$$

$$P := \begin{pmatrix} 375 \cdot \text{kPa} \\ 1000 \cdot \text{kPa} \\ 500 \cdot \text{kPa} \\ 1300 \cdot \text{kPa} \\ 55 \cdot \text{psi} \\ 135 \cdot \text{psi} \end{pmatrix}$$

$$\text{ndot} := \begin{pmatrix} 100 \\ 100 \\ 150 \\ 50 \\ 0.5 \cdot 453.59 \\ 0.5 \cdot 453.59 \end{pmatrix} \cdot \frac{\text{mol}}{\text{sec}}$$

$$\eta := \begin{pmatrix} 0.75 \\ 0.70 \\ 0.80 \\ 0.75 \\ 0.75 \\ 0.70 \end{pmatrix}$$

$$\Delta S := 0 \cdot \frac{\text{J}}{\text{mol} \cdot \text{K}}$$

$$i := 1..6$$

For the heat capacity of air:

$$A := 3.355$$

$$B := \frac{0.575 \cdot 10^{-3}}{\text{K}}$$

$$D := -0.016 \cdot 10^5 \cdot \text{K}^2$$

$$\tau := 0.5 \quad (\text{guess})$$

Given

$$\Delta S = R \cdot \left[ A \cdot \ln(\tau) + \left[ B \cdot T_0 + \frac{D}{T_0^2 \cdot \tau^2} \cdot \left( \frac{\tau + 1}{2} \right) \right] \cdot (\tau - 1) - \ln\left(\frac{P}{P_0}\right) \right]$$

$$\text{Tau}(T_0, P_0, P) := \text{Find}(\tau)$$

$$\tau_i := \text{Tau}(T_{0_i}, P_{0_i}, P_i)$$

$$T_i := T_{0_i} \cdot \tau_i$$

$$T = \begin{pmatrix} 431.06 \\ 464.5 \\ 476.19 \\ 486.87 \\ 434.74 \\ 435.71 \end{pmatrix} \text{ K}$$

$$\Delta H'_i := R \cdot \text{ICPH}(T_{0_i}, T_i, 3.355, 0.575 \cdot 10^{-3}, 0.0, -0.016 \cdot 10^5)$$

$$\Delta H' = \begin{pmatrix} 3925.2 \\ 3314.6 \\ 5133.2 \\ 3397.5 \\ 3986.4 \\ 2876.6 \end{pmatrix} \frac{\text{J}}{\text{mol}}$$

$$\Delta H := \left( \frac{\Delta H'}{\eta} \right) \rightarrow$$

$$\Delta H = \begin{pmatrix} 5233.6 \\ 4735.1 \\ 6416.5 \\ 4530 \\ 5315.2 \\ 4109.4 \end{pmatrix} \frac{\text{J}}{\text{mol}}$$

$$\tau := 1.5 \quad \text{(guess)}$$

$$\text{Given} \quad \Delta H = R \cdot \left[ A \cdot T_{0_i} \cdot () - 1 + \frac{B}{2} \cdot T_{0_i}^2 \cdot ()^2 - 1 + \frac{D}{T_{0_i}} \cdot \left( \frac{\tau - 1}{\tau} \right) \right]$$

$$\text{Tau}(T_{0_i}, \Delta H) := \text{Find}(\tau) \quad \tau_i := \text{Tau}(T_{0_i}, \Delta H_i) \quad T_i := T_{0_i} \cdot \tau_i$$

$$\text{Wdot} := \left( \text{hdot} \cdot \Delta H \right) \rightarrow$$



$T = \begin{pmatrix} 474.68 \\ 511.58 \\ 518.66 \\ 524.3 \\ 479.01 \\ 476.79 \end{pmatrix} \text{K}$	$\dot{W} = \begin{pmatrix} 702 \\ 635 \\ 1291 \\ 304 \\ 1617 \\ 1250 \end{pmatrix} \text{hp}$	$\dot{W} = \begin{pmatrix} 523 \\ 474 \\ 962 \\ 227 \\ 1205 \\ 932 \end{pmatrix} \text{kW}$	<b>Ans.</b>
--	---	---	-------------

**7.36 Ammonia:**

$T_c := 405.7 \cdot \text{K}$	$P_c := 112.8 \cdot \text{bar}$	$\omega := 0.253$
$T_0 := 294.15 \cdot \text{K}$	$P_0 := 200 \cdot \text{kPa}$	$P := 1000 \cdot \text{kPa}$

$$\Delta S := 0 \cdot \frac{\text{J}}{\text{mol} \cdot \text{K}}$$

**For the heat capacity of ammonia:**

$A := 3.578$	$B := \frac{3.020 \cdot 10^{-3}}{\text{K}}$	$D := -0.186 \cdot 10^5 \cdot \text{K}^2$
--------------	---	---

$T_{r0} := \frac{T_0}{T_c}$	$T_{r0} = 0.725$	$P_{r0} := \frac{P_0}{P_c}$	$P_{r0} = 0.0177$
		$P_r := \frac{P}{P_c}$	$P_r = 0.089$

**Use generalized second-virial correlation:**

**The entropy change is given by Eq. (6.92) combined with Eq. (5.15); C = 0:**

$$\tau := 1.4 \quad (\text{guess})$$

Given

$$\Delta S = R \cdot \left[ A \cdot \ln(\tau) + \left[ B \cdot T_0 + \frac{D}{(\tau \cdot T_0)^2} \cdot \left( \frac{\tau + 1}{2} \right) \right] \cdot (\tau - 1) - \ln\left(\frac{P}{P_0}\right) \dots \right]$$

$$\left[ + \text{SRB}\left(\frac{\tau \cdot T_0}{T_c}, \mathcal{B}_r\right) - \text{SRB}\left(\frac{T_0}{T_c}, \mathcal{B}_{r0}\right) \right]$$

$\tau := \text{Find}(\tau)$	$\tau = 1.437$	$T := \tau \cdot T_0$	$T = 422.818 \text{K}$
		$T_r := \frac{T}{T_c}$	$T_r = 1.042$

$$\Delta H_{ig} := R \cdot \text{ICPH}(T_0, T, 3.578, 3.020 \cdot 10^{-3}, 0.0, -0.186 \cdot 10^5)$$

$$\Delta H_{ig} = 4.826 \frac{\text{kJ}}{\text{mol}}$$

$$\Delta H' := \Delta H_{ig} + R \cdot T_c \cdot (\text{HRB}(T_r, \theta_r) - \text{HRB}(T_{r0}, \theta_{r0}))$$

$$\Delta H' = 4652 \frac{\text{J}}{\text{mol}}$$

The actual enthalpy change from Eq. (7.17):

$$\eta := 0.82 \quad \Delta H := \frac{\Delta H'}{\eta} \quad \Delta H = 5673.2 \frac{\text{J}}{\text{mol}}$$

The actual final temperature is now found from Eq. (6.91) combined with Eq (4.7), written:

$$\tau := 1.4 \quad (\text{guess})$$

Given

$$\Delta H = R \cdot \left[ A \cdot T_0 \cdot (\tau - 1) + \frac{B}{2} \cdot T_0^2 \cdot (\tau^2 - 1) + \frac{D}{T_0} \cdot \left( \frac{\tau - 1}{\tau} \right) \dots \right] + T_c \cdot \left( \text{HRB} \left( \frac{\tau \cdot T_0}{T_c}, \theta_r \right) - \text{HRB}(T_{r0}, \theta_{r0}) \right)$$

$$\tau := \text{Find}(\tau) \quad \tau = 1.521 \quad T := \tau \cdot T_0 \quad T = 447.47 \text{ K} \quad \text{Ans.}$$

$$T_r := \frac{T}{T_c} \quad T_r = 1.103$$

$$\Delta S := R \cdot \left[ A \cdot \ln(\tau) + \left[ B \cdot T_0 + \frac{D}{(\tau \cdot T_0)^2} \cdot \left( \frac{\tau + 1}{2} \right) \right] \cdot (\tau - 1) - \ln \left( \frac{P}{P_0} \right) \dots \right] + \text{SRB}(T_r, \theta_r) - \text{SRB}(T_{r0}, \theta_{r0})$$

$$\Delta S = 2.347 \frac{\text{J}}{\text{mol} \cdot \text{K}} \quad \text{Ans.}$$

7.37 Propylene:  $T_c := 365.6 \cdot \text{K}$   $P_c := 46.65 \cdot \text{bar}$   $\omega := 0.140$   
 $T_0 := 303.15 \cdot \text{K}$   $P_0 := 11.5 \cdot \text{bar}$   $P := 18 \cdot \text{bar}$

$$\Delta S := 0 \cdot \frac{\text{J}}{\text{mol} \cdot \text{K}}$$

$$A := 1.637$$

For the heat capacity of propylene:

$$B := \frac{22.706 \cdot 10^{-3}}{\text{K}}$$

$$C := \frac{-6.915 \cdot 10^{-6}}{\text{K}^2}$$

$$T_{r0} := \frac{T_0}{T_c}$$

$$T_{r0} = 0.8292$$

$$P_{r0} := \frac{P_0}{P_c}$$

$$P_{r0} = 0.2465$$

$$P_r := \frac{P}{P_c}$$

$$P_r = 0.386$$

Use generalized second-virial correlation:

The entropy change is given by Eq. (6.92) combined with Eq. (5.15) with  $D = 0$ :

$$\tau := 1.1 \quad (\text{guess})$$

Given

$$\Delta S = R \cdot \left[ A \cdot \ln(\tau) + \left[ B \cdot T_0 + C \cdot T_0^2 \cdot \left( \frac{\tau + 1}{2} \right) \right] \cdot (\tau - 1) - \ln\left(\frac{P}{P_0}\right) \dots \right]$$

$$\left[ + \text{SRB}\left(\frac{\tau \cdot T_0}{T_c}, \mathfrak{B}_r, \right) - \text{SRB}(T_{r0}, \mathfrak{B}_{r0}, \right)$$

$$\tau := \text{Find}(\tau)$$

$$\tau = 1.069$$

$$T := \tau \cdot T_0$$

$$T = 324.128 \text{ K}$$

$$T_r := \frac{T}{T_c}$$

$$T_r = 0.887$$

The enthalpy change for the final T is given by Eq. (6.91), with HRB for this T:

$$\Delta H_{ig} := R \cdot \text{ICPH}(T_0, T, 1.637, 22.706 \cdot 10^{-3}, -6.915 \cdot 10^{-6}, 0.0)$$

$$\Delta H_{ig} = 1.409 \times 10^3 \frac{\text{J}}{\text{mol}}$$

$$\Delta H' := \Delta H_{ig} + R \cdot T_c \cdot (\text{HRB}(T_r, \mathfrak{B}_r, ) - \text{HRB}(T_{r0}, \mathfrak{B}_{r0}, ))$$

$$\Delta H' = 964.1 \frac{\text{J}}{\text{mol}}$$

The actual enthalpy change from Eq. (7.17):

$$\eta := 0.80$$

$$\Delta H := \frac{\Delta H'}{\eta}$$

$$\Delta H = 1205.2 \frac{\text{J}}{\text{mol}}$$

$$\dot{n} := 1000 \cdot \frac{\text{mol}}{\text{sec}}$$

$$\dot{W} := \dot{n} \cdot \Delta H$$

$$\dot{W} = 1205.2 \text{ kW} \quad \text{Ans.}$$

The actual final temperature is now found from Eq. (6.91) combined with Eq (4.7), written:

$$\tau := 1.1 \quad (\text{guess})$$

Given

$$\Delta H = R \cdot \left[ A \cdot T_0 \cdot () - 1 + \frac{B}{2} \cdot T_0^2 \cdot ()^2 - 1 + \frac{C}{3} \cdot T_0^3 \cdot ()^3 - 1 \dots \right]$$

$$\left[ + T_c \cdot \left( \text{HRB} \left( \frac{\tau \cdot T_0}{T_c}, \mathfrak{B}_r, \right) \right) - \text{HRB} \left( T_{r0}, \mathfrak{B}_{r0}, \right) \right]$$

$$\tau := \text{Find}(\tau)$$

$$\tau = 1.079$$

$$T := \tau \cdot T_0$$

$$T = 327.15 \text{ K}$$

Ans.

7.38 Methane:

$$T_c := 190.6 \cdot \text{K}$$

$$P_c := 45.99 \cdot \text{bar}$$

$$\omega := 0.012$$

$$T_0 := 308.15 \cdot \text{K}$$

$$P_0 := 3500 \cdot \text{kPa}$$

$$P := 5500 \cdot \text{kPa}$$

$$\Delta S := 0 \cdot \frac{\text{J}}{\text{mol} \cdot \text{K}}$$

For the heat capacity of methane:

$$A := 1.702$$

$$B := \frac{9.081 \cdot 10^{-3}}{\text{K}}$$

$$C := \frac{-2.164 \cdot 10^{-6}}{\text{K}^2}$$

$$T_{r0} := \frac{T_0}{T_c}$$

$$T_{r0} = 1.6167$$

$$P_{r0} := \frac{P_0}{P_c}$$

$$P_{r0} = 0.761$$

$$P_r := \frac{P}{P_c}$$

$$P_r = 1.196$$

Use generalized second-virial correlation:

The entropy change is given by Eq. (6.92) combined with Eq. (5.15) with  $D = 0$ :

$$\tau := 1.1 \quad (\text{guess})$$

Given

$$\Delta S = R \cdot \left[ A \cdot \ln(\tau) + \left[ B \cdot T_0 + C \cdot T_0^2 \cdot \left( \frac{\tau + 1}{2} \right) \right] \cdot (\tau - 1) - \ln\left(\frac{P}{P_0}\right) \dots \right] + \text{SRB}\left(\frac{\tau \cdot T_0}{T_c}, \mathfrak{B}_r, \right) - \text{SRB}(T_{r0}, \mathfrak{B}_{r0}, )$$

$$\tau := \text{Find}(\tau) \quad \tau = 1.114 \quad T := \tau \cdot T_0 \quad T = 343.379 \text{ K}$$

$$T_r := \frac{T}{T_c} \quad T_r = 1.802$$

The enthalpy change for the final T is given by Eq. (6.91), with HRB for this T:

$$\Delta H_{ig} := R \cdot \text{ICPH}(T_0, T, 1.702, 9.081 \cdot 10^{-3}, -2.164 \cdot 10^{-6}, 0.0)$$

$$\Delta H_{ig} = 1.298 \times 10^3 \frac{\text{J}}{\text{mol}}$$

$$\Delta H' := \Delta H_{ig} + R \cdot T_c \cdot (\text{HRB}(T_r, \mathfrak{B}_r, ) - \text{HRB}(T_{r0}, \mathfrak{B}_{r0}, ))$$

$$\Delta H' = 1158.8 \frac{\text{J}}{\text{mol}}$$

The actual enthalpy change from Eq. (7.17):

$$\eta := 0.78 \quad \Delta H := \frac{\Delta H'}{\eta} \quad \Delta H = 1485.6 \frac{\text{J}}{\text{mol}}$$

$$\dot{n} := 1500 \cdot \frac{\text{mol}}{\text{sec}} \quad \dot{W} := \dot{n} \cdot \Delta H \quad \dot{W} = 2228.4 \text{ kW} \quad \text{Ans.}$$

The actual final temperature is now found from Eq. (6.91) combined with Eq (4.7), written:

$$\tau := 1.1 \quad (\text{guess})$$

Given

$$\Delta H = R \cdot \left[ A \cdot T_0 \cdot () - 1 + \frac{B}{2} \cdot T_0^2 \cdot ()^2 - 1 + \frac{C}{3} \cdot T_0^3 \cdot ()^3 - 1 \dots \right]$$

$$+ T_c \cdot \left( \text{HRB} \left( \frac{\tau \cdot T_0}{T_c}, \mathfrak{B}_r, \right) - \text{HRB} \left( T_{r0}, \mathfrak{B}_{r0}, \right) \right)$$

$$\tau := \text{Find}(\tau) \quad \tau = 1.14 \quad T := \tau \cdot T_0 \quad T = 351.18 \text{ K} \quad \text{Ans.}$$

7.39 From the data and results of Example 7.9,

$$T_1 := 293.15 \cdot \text{K} \quad T_2 := 428.65 \cdot \text{K} \quad P_1 := 140 \cdot \text{kPa} \quad P_2 := 560 \cdot \text{kPa}$$

$$\text{Work} := 5288.3 \cdot \frac{\text{J}}{\text{mol}} \quad T_\sigma := 293.15 \cdot \text{K}$$

$$\Delta H := R \cdot \text{ICPH} \left( T_1, T_2, 1.702, 9.081 \cdot 10^{-3}, -2.164 \cdot 10^{-6}, 0.0 \right)$$

$$\Delta H = 5288.2 \frac{\text{J}}{\text{mol}}$$

$$\Delta S := R \cdot \left( \text{ICPS} \left( T_1, T_2, 1.702, 9.081 \cdot 10^{-3}, -2.164 \cdot 10^{-6}, 0.0 \right) - \ln \left( \frac{P_2}{P_1} \right) \right)$$

$$\Delta S = 3.201 \frac{\text{J}}{\text{mol} \cdot \text{K}}$$

Since the process is adiabatic:  $S_G := \Delta S$   $S_G = 3.2012 \frac{\text{J}}{\text{mol} \cdot \text{K}}$  **Ans.**

$$W_{\text{ideal}} := \Delta H - T_\sigma \cdot \Delta S$$
 $W_{\text{ideal}} = 4349.8 \frac{\text{J}}{\text{mol}}$  **Ans.**

$$W_{\text{lost}} := T_\sigma \cdot \Delta S$$
 $W_{\text{lost}} = 938.4 \frac{\text{J}}{\text{mol}}$  **Ans.**

$$\eta_t := \frac{W_{\text{ideal}}}{\text{Work}}$$
 $\eta_t = 0.823$  **Ans.**

7.42

$P1 := 1\text{atm}$	$T1 := (35 + 273.15)\text{K}$	$T1 = 308.15\text{K}$
$P2 := 50\text{atm}$	$T2 := (200 + 273.15)\text{K}$	$T2 = 473.15\text{K}$
$\eta := 0.65$	$\dot{V} := 0.5 \frac{\text{m}^3}{\text{sec}}$	$Cp := 3.5 \cdot R$
$V := \frac{R \cdot T1}{P1}$	$\dot{n} := \frac{\dot{V}}{V}$	$\dot{n} = 19.775 \frac{\text{mol}}{\text{sec}}$

With compression from the same initial conditions ( $P1, T1$ ) to the same final conditions ( $P2, T2$ ) in each stage, the same efficiency in each stage, and the same power delivered to each stage, the applicable equations are:

$$r = \left( \frac{P2}{P1} \right)^{\frac{1}{N}} \quad (\text{where } r \text{ is the pressure ratio in each stage and } N \text{ is the number of stages.})$$

Eq. (7.23) may be solved for  $T2$ prime:  $T'2 := [(T2 - T1) \cdot \eta + T1]$

$$T'2 = 415.4\text{K}$$

Eq. (7.18) written for a single stage is:

$$T'2 = T1 \cdot \left( \frac{P2}{P1} \right)^{\frac{R}{N \cdot Cp}}$$

Put in logarithmic form and solve for N:

$$N := \frac{R}{Cp} \cdot \frac{\ln\left(\frac{P2}{P1}\right)}{\ln\left(\frac{T'2}{T1}\right)}$$

$$N = 3.743$$

(a) Although any number of stages greater than this would serve, design for 4 stages.

(b) Calculate r for 4 stages:  $N := 4$       $r := \left( \frac{P2}{P1} \right)^{\frac{1}{N}}$       $r = 2.659$

Power requirement per stage follows from Eq. (7.22). In kW/stage:

$$\dot{W}_{\text{dot}_r} := \frac{\dot{n} \cdot Cp \cdot T1 \cdot \left( r^{\frac{R}{Cp}} - 1 \right)}{\eta}$$

$$\dot{W}_{\text{dot}_r} = 87.944\text{kW} \quad \text{Ans.}$$

(c) Because the gas (ideal) leaving the intercooler and the gas entering the compressor are at the same temperature (308.15 K), there is no enthalpy change for the compressor/interchanger system, and the first law yields:

$$\dot{Q}_{\text{dot}_r} := -\dot{W}_{\text{dot}_r} \quad \dot{Q}_{\text{dot}_r} = -87.944 \text{ kW} \quad \text{Ans.}$$

Heat duty = 87.94 kW/interchanger

(d) Energy balance on each interchanger (subscript w denotes water):

With data for saturated liquid water from the steam tables:

$$\Delta H_w := (188.4 - 104.8) \frac{\text{kJ}}{\text{kg}} \quad \Delta H_w = 83.6 \frac{\text{kJ}}{\text{kg}}$$

$$\dot{m}_{\text{dot}_w} := \frac{|\dot{Q}_{\text{dot}_r}|}{\Delta H_w} \quad \dot{m}_{\text{dot}_w} = 1.052 \frac{\text{kg}}{\text{sec}} \quad \text{Ans. (in each interchanger)}$$

7.44

$$T1 := \begin{pmatrix} 300 \\ 290 \\ 295 \\ 300 \\ 305 \end{pmatrix} \text{ K}$$

$$P1 := \begin{pmatrix} 2.0 \\ 1.5 \\ 1.2 \\ 1.1 \\ 1.5 \end{pmatrix} \text{ bar}$$

$$T2 := \begin{pmatrix} 464 \\ 547 \\ 455 \\ 505 \\ 496 \end{pmatrix} \text{ K}$$

$$P2 := \begin{pmatrix} 6 \\ 5 \\ 6 \\ 8 \\ 7 \end{pmatrix} \text{ bar}$$

$$Cp := \begin{pmatrix} 3.5 \\ 2.5 \\ 4.5 \\ 5.5 \\ 4.0 \end{pmatrix} \cdot R$$

$$\Delta H := \overrightarrow{[Cp \cdot (T2 - T1)]}$$

Ideal gases with constant heat capacities

$$\Delta H_S := \overrightarrow{\left[ Cp \cdot T1 \cdot \left[ \left( \frac{P2}{P1} \right)^{\frac{R}{Cp}} - 1 \right] \right]} \quad (7.22)$$



$$\Delta H_S = \begin{pmatrix} 3.219 \\ 3.729 \\ 4.745 \\ 5.959 \\ 4.765 \end{pmatrix} \frac{\text{kJ}}{\text{mol}}$$

$$\eta := \frac{\Delta H_S}{\Delta H}$$

$$\eta = \begin{pmatrix} 0.675 \\ 0.698 \\ 0.793 \\ 0.636 \\ 0.75 \end{pmatrix}$$

Ans.

7.47 The following vectors contain values for Parts (a) through (e). Intake conditions first:

$$T_1 := \begin{pmatrix} 298.15 \\ 363.15 \\ 333.15 \\ 294.26 \\ 366.48 \end{pmatrix} \cdot \text{K}$$

$$P_1 := \begin{pmatrix} 100 \cdot \text{kPa} \\ 200 \cdot \text{kPa} \\ 20 \cdot \text{kPa} \\ 1 \cdot \text{atm} \\ 15 \cdot \text{psi} \end{pmatrix}$$

$$\dot{m} := \begin{pmatrix} 20 \cdot \text{kg} \\ 30 \cdot \text{kg} \\ 15 \cdot \text{kg} \\ 50 \cdot \text{lb} \\ 80 \cdot \text{lb} \end{pmatrix} \cdot \frac{1}{\text{sec}}$$

$$P_2 := \begin{pmatrix} 2000 \cdot \text{kPa} \\ 5000 \cdot \text{kPa} \\ 5000 \cdot \text{kPa} \\ 20 \cdot \text{atm} \\ 1500 \cdot \text{psi} \end{pmatrix}$$

$$\eta := \begin{pmatrix} 0.75 \\ 0.70 \\ 0.75 \\ 0.70 \\ 0.75 \end{pmatrix}$$

$$\beta := \begin{pmatrix} 257.2 \\ 696.2 \\ 523.1 \\ 217.3 \\ 714.3 \end{pmatrix} \cdot \frac{10^{-6}}{\text{K}}$$

From the steam tables for sat.liq. water at the initial temperature (heat capacity calculated from enthalpy values):

$$V := \begin{pmatrix} 1.003 \\ 1.036 \\ 1.017 \\ 1.002 \\ 1.038 \end{pmatrix} \cdot \frac{\text{cm}^3}{\text{gm}}$$

$$C_P := \begin{pmatrix} 4.15 \\ 4.20 \\ 4.20 \\ 4.185 \\ 4.20 \end{pmatrix} \cdot \frac{\text{kJ}}{\text{kg} \cdot \text{K}}$$

By Eq. (7.24)  $\Delta H_S := \overrightarrow{V \cdot (P_2 - P_1)}$   $\Delta H := \frac{\Delta H_S}{\eta}$

$$\Delta H_S = \begin{pmatrix} 1.906 \\ 4.973 \\ 5.065 \\ 1.929 \\ 10.628 \end{pmatrix} \frac{\text{kJ}}{\text{kg}}$$

$$\Delta H = \begin{pmatrix} 2.541 \\ 7.104 \\ 6.753 \\ 2.756 \\ 14.17 \end{pmatrix} \frac{\text{kJ}}{\text{kg}}$$

By Eq. (7.25)  $\Delta T := \frac{\Delta H - V \cdot (1 - \beta \cdot T_1) \cdot (P_2 - P_1)}{C_P} \rightarrow \Delta T = \begin{pmatrix} 0.188 \\ 0.807 \\ 0.612 \\ 0.227 \\ 1.506 \end{pmatrix} \text{K}$

$\dot{W} := (\Delta H \cdot \dot{m}) \rightarrow \dot{W} = \begin{pmatrix} 50.82 \\ 213.12 \\ 101.29 \\ 62.5 \\ 514.21 \end{pmatrix} \text{kW} \quad \dot{W} = \begin{pmatrix} 68.15 \\ 285.8 \\ 135.84 \\ 83.81 \\ 689.56 \end{pmatrix} \text{hp} \quad \text{Ans.}$

$T_2 := (T_1 + \Delta T) \rightarrow T_2 = \begin{pmatrix} 298.338 \\ 363.957 \\ 333.762 \\ 294.487 \\ 367.986 \end{pmatrix} \text{K}$

$t_2 := \left( \frac{T_2}{\text{K}} - 273.15 \right) \rightarrow \begin{pmatrix} t_{2_1} \\ t_{2_2} \\ t_{2_3} \end{pmatrix} = \begin{pmatrix} 25.19 \\ 90.81 \\ 60.61 \end{pmatrix} \text{degC}$

$t_2 := \left( \frac{T_2}{\text{K}} \cdot 1.8 - 459.67 \right) \rightarrow \begin{pmatrix} t_{2_4} \\ t_{2_5} \end{pmatrix} = \begin{pmatrix} 70.41 \\ 202.7 \end{pmatrix} \text{degF}$

7.48 Results from Example 7.10:

$$\Delta H := 11.57 \cdot \frac{\text{kJ}}{\text{kg}}$$

$$W := 11.57 \cdot \frac{\text{kJ}}{\text{kg}}$$

$$\Delta S := 0.0090 \cdot \frac{\text{kJ}}{\text{kg} \cdot \text{K}}$$

$$T_\sigma := 300 \cdot \text{K}$$

$$W_{\text{ideal}} := \Delta H - T_\sigma \cdot \Delta S$$

$$\eta_t := \frac{W_{\text{ideal}}}{W}$$

$$W_{\text{ideal}} = 8.87 \frac{\text{kJ}}{\text{kg}} \quad \text{Ans.}$$

$$\eta_t = 0.767 \quad \text{Ans.}$$

Since the process is adiabatic.

$$S_G := \Delta S$$

$$S_G = 9 \times 10^{-3} \frac{\text{kJ}}{\text{kg} \cdot \text{K}}$$

Ans.

$$W_{\text{lost}} := T_\sigma \cdot \Delta S$$

$$W_{\text{lost}} = 2.7 \frac{\text{kJ}}{\text{kg}}$$

Ans.

7.53  $T_1 := (25 + 273.15)\text{K}$

$P_1 := 1.2\text{bar}$

$P_2 := 5\text{bar}$

$T_3 := (200 + 273.15)\text{K}$

$P_3 := 5\text{bar}$

$$C_{\text{pv}} := 105 \frac{\text{J}}{\text{mol} \cdot \text{K}}$$

$$\Delta H_{\text{lv}} := 30.72 \frac{\text{kJ}}{\text{mol}}$$

$$\eta := 0.7$$

Estimate the specific molar volume of liquid benzene using the Rackett equation (3.72).

From Table B.1 for benzene:

$T_c := 562.2\text{K}$

$Z_c := 0.271$

$V_c := 259 \frac{\text{cm}^3}{\text{mol}}$

From Table B.2 for benzene:

$T_n := (80.0 + 273.15)\text{K}$

$T_m := \frac{T_n}{T_c}$

Assume  $V_{\text{liq}} = V_{\text{sat}}$ :  $V := V_c \cdot Z_c \left(1 - T_m\right)^{\frac{2}{7}}$  Eq. (3.72)

$V = 96.802 \frac{\text{cm}^3}{\text{mol}}$

Calculate pump power

$$W_s := \frac{V \cdot (P_2 - P_1)}{\eta}$$

$$W_s = 0.053 \frac{\text{kJ}}{\text{mol}}$$

Ans.

Assume that no temperature change occurs during the liquid compression.

Therefore:  $T_2 := T_1$

Estimate the saturation temperature at  $P = 5$  bar using the Antoine Equation and values from Table B.2

For benzene from Table B.2:  $A := 13.7819$        $B := 2726.81$        $C := 217.572$

$$T_{\text{sat}} := \left( \frac{B}{A - \ln\left(\frac{P_2}{\text{kPa}}\right)} - C \right) \text{degC} \quad T_{\text{sat}} = 142.77 \text{ degC}$$

$$T_{\text{sat}} := T_{\text{sat}} + 273.15 \text{K} \quad T_{\text{sat}} = 415.9 \text{K}$$

Estimate the heat of vaporization at  $T^{\text{sat}}$  using Watson's method

From Table B.2 At 80 C:  $\Delta H_{\text{lv}} := 30.72 \frac{\text{kJ}}{\text{mol}}$

$$T_{r1} := \frac{(80 + 273.15)\text{K}}{T_c} \quad T_{r1} = 0.628 \quad T_{r2} := \frac{T_{\text{sat}}}{T_c} \quad T_{r2} = 0.74$$

$$\Delta H_{\text{lv}2} := \Delta H_{\text{lv}} \cdot \left( \frac{1 - T_{r2}}{1 - T_{r1}} \right)^{0.38} \quad \text{Eq. (4.13)} \quad \Delta H_{\text{lv}2} = 26.822 \frac{\text{kJ}}{\text{mol}}$$

Calculate the heat exchanger heat duty.

$$Q := R \cdot \text{ICPH}(T_2, T_{\text{sat}}, -0.747, 67.96 \cdot 10^{-3}, -37.78 \cdot 10^{-6}, 0 \dots) + \Delta H_{\text{lv}2} + C_{\text{pv}} \cdot (T_3 - T_{\text{sat}})$$

$$Q = 51.1 \frac{\text{kJ}}{\text{mol}} \quad \text{Ans.}$$

7.54  $T_1 := (25 + 273.15)\text{K}$      $P_1 := 1.2\text{bar}$      $P_2 := 1.2\text{bar}$   
 $T_3 := (200 + 273.15)\text{K}$      $P_3 := 5\text{bar}$   
 $C_{pv} := 105 \frac{\text{J}}{\text{mol}\cdot\text{K}}$      $\eta := 0.75$

Calculate the compressor inlet temperature.

Combining equations (7.17), (7.21) and (7.22) yields:

$$T_2 := \frac{T_3}{1 + \frac{1}{\eta} \left[ \left( \frac{P_3}{P_2} \right)^{\frac{R}{C_{pv}}} - 1 \right]}$$

$T_2 = 408.06\text{K}$   
 $T_2 - 273.15\text{K} = 134.91\text{ degC}$

Calculate the compressor power

$$W_s := C_{pv} \cdot (T_3 - T_2)$$

$W_s = 6.834 \frac{\text{kJ}}{\text{mol}}$     Ans.

Calculate the heat exchanger duty. Note that the exchanger outlet temperature,  $T_2$ , is equal to the compressor inlet temperature. The benzene enters the exchanger as a subcooled liquid. In the exchanger the liquid is first heated to the saturation temperature at  $P_1$ , vaporized and finally the vapor is superheated to temperature  $T_2$ .

Estimate the saturation temperature at  $P = 1.2\text{ bar}$  using the Antoine Equation and values from Table B.2

For benzene from Table B.2:  $A := 13.7819$      $B := 2726.81$      $C := 217.572$

$$T_{\text{sat}} := \left( \frac{B}{A - \ln\left(\frac{P_1}{\text{kPa}}\right)} - C \right) \text{degC}$$

$T_{\text{sat}} = 85.595\text{ degC}$   
 $T_{\text{sat}} := T_{\text{sat}} + 273.15\text{K}$      $T_{\text{sat}} = 358.7\text{K}$

Estimate the heat of vaporization at  $T^{\text{sat}}$  using Watson's method

From Table B.2 At 25 C:  $\Delta H_{lv} := 30.72 \frac{\text{kJ}}{\text{mol}}$     From Table B.1 for benzene:  $T_c := 562.2\text{K}$

$$T_{r1} := \frac{(80 + 273.15)\text{K}}{T_c} \quad T_{r1} = 0.628 \quad T_{r2} := \frac{T_{\text{sat}}}{T_c} \quad T_{r2} = 0.638$$

$$\Delta H_{lv2} := \Delta H_{lv} \cdot \left( \frac{1 - T_{r2}}{1 - T_{r1}} \right)^{0.38} \quad \text{Eq. (4.13)} \quad \Delta H_{lv2} = 30.405 \frac{\text{kJ}}{\text{mol}}$$

$$Q := R \cdot \text{ICPH}(T_1, T_{\text{sat}}, -0.747, 67.96 \cdot 10^{-3}, -37.78 \cdot 10^{-6}, 0 \dots) \\ + \Delta H_{lv2} + C_{pv} \cdot (T_2 - T_{\text{sat}})$$

$$Q = 44.393 \frac{\text{kJ}}{\text{mol}} \quad \text{Ans.}$$

$$7.57 \quad \dot{n} := 100 \frac{\text{kmol}}{\text{hr}} \quad P_1 := 1.2 \text{bar} \quad T_1 := 300\text{K} \quad P_2 := 6 \text{bar}$$

$$C_p := 50.6 \frac{\text{J}}{\text{mol} \cdot \text{K}} \quad \eta := 0.70$$

Assume the compressor is adiabatic.

$$T_2 := \left( \frac{P_2}{P_1} \right)^{\frac{R}{C_p}} \cdot T_1 \quad (\text{Pg. 77}) \quad T_2 = 390.812 \text{K}$$

$$\dot{W}_{\text{dot}_s} := \dot{n} \cdot C_p \cdot (T_2 - T_1) \quad \dot{W}_{\text{dot}_s} = 127.641 \text{kW}$$

$$\dot{W}_{\text{dot}_e} := \frac{\dot{W}_{\text{dot}_s}}{\eta} \quad \dot{W}_{\text{dot}_e} = 182.345 \text{kW}$$

$$C_{\text{compressor}} := 3040 \text{dollars} \cdot \left( \frac{\dot{W}_{\text{dot}_s}}{\text{kW}} \right)^{0.952} \quad C_{\text{compressor}} = 307452 \text{dollars} \quad \text{Ans.}$$

$$C_{\text{motor}} := 380 \text{dollars} \cdot \left( \frac{\dot{W}_{\text{dot}_e}}{\text{kW}} \right)^{0.855} \quad C_{\text{motor}} = 32572 \text{dollars} \quad \text{Ans.}$$

7.59  $T_1 := 375\text{K}$        $P_1 := 18\text{bar}$        $P_2 := 1.2\text{bar}$   
**For ethylene:**       $\omega := 0.087$        $T_c := 282.3\text{K}$        $P_c := 50.40\text{bar}$

$$T_{r1} := \frac{T_1}{T_c} \quad T_{r1} = 1.328 \quad P_{r1} := \frac{P_1}{P_c} \quad P_{r1} = 0.357$$

$$P_{r2} := \frac{P_2}{P_c} \quad P_{r2} = 0.024$$

$$A := 1.424 \quad B := 14.394 \cdot 10^{-3} \quad C := -4.392 \cdot 10^{-6} \quad D := 0$$

a) For throttling process, assume the process is adiabatic. Find  $T_2$  such that  $\Delta H = 0$ .

$$\Delta H = C_{pmig} \cdot (T_2 - T_1) + HR_2 - HR_1 \quad \text{Eq. (6-93)}$$

Use the MCPH function to calculate the mean heat capacity and the HRB function for the residual enthalpy.

**Guess:**  $T_2 := T_1$

Given

$$0 \cdot \frac{\text{J}}{\text{mol}} = \text{MCPH}(T_1, T_2, A, B, C, D) \cdot R \cdot (T_2 - T_1) \dots$$

$$+ R \cdot T_c \cdot \text{HRB}\left(\frac{T_2}{T_c}, \mathfrak{B}_{r2}, \right) - R \cdot T_c \cdot \text{HRB}(T_{r1}, \mathfrak{B}_{r1},$$

$$T_2 := \text{Find}(T_2) \quad T_2 = 365.474\text{K} \quad \text{Ans.} \quad T_{r2} := \frac{T_2}{T_c} \quad T_{r2} = 1.295$$

Calculate change in entropy using Eq. (6-94) along with MCPS function for the mean heat capacity and SRB function for the residual entropy.

$$\Delta S := \left( R \cdot \text{MCPS}(T_1, T_2, A, B, C, D) \cdot \ln\left(\frac{T_2}{T_1}\right) - R \cdot \ln\left(\frac{P_2}{P_1}\right) \right) \dots \quad \text{Eq. (6-94)}$$

$$+ R \cdot \text{SRB}(T_{r2}, \mathfrak{B}_{r2}, \quad - R \cdot \text{SRB}(T_{r1}, \mathfrak{B}_{r1},$$

$$\Delta S = 22.128 \frac{\text{J}}{\text{mol} \cdot \text{K}} \quad \text{Ans.}$$

b) For expansion process.  $\eta := 70\%$

First find T2 for isentropic expansion. Solve Eq. (6-94) with  $\Delta S = 0$ .

Guess:  $T_2 := T_1$

Given

$$0 \frac{\text{J}}{\text{mol}\cdot\text{K}} = R \cdot \text{MCPS}(T_1, T_2, A, B, C, D) \cdot \ln\left(\frac{T_2}{T_1}\right) - R \cdot \ln\left(\frac{P_2}{P_1}\right) \dots \text{Eq. (6-94)}$$

$$+ \text{SRB}\left(\frac{T_2}{T_c}, \theta_{r2}, \dots\right) \cdot R - \text{SRB}(T_{r1}, \theta_{r1}, \dots) \cdot R$$

$$T_2 := \text{Find}(T_2) \quad T_2 = 219.793 \text{ K} \quad T_{r2} := \frac{T_2}{T_c} \quad T_{r2} = 0.779$$

Now calculate the isentropic enthalpy change,  $\Delta H_S$ .

$$HR_2 := \text{HRB}(T_{r2}, \theta_{r2}, \dots) \cdot R \cdot T_c$$

$$\Delta H_S := \left[ R \cdot \text{MCPH}(T_1, T_2, A, B, C, D) \cdot (T_2 - T_1) \right] \dots$$

$$+ \text{HRB}(T_{r2}, \theta_{r2}, \dots) \cdot R \cdot T_c - \text{HRB}(T_{r1}, \theta_{r1}, \dots) \cdot R \cdot T_c$$

$$\Delta H_S = -6.423 \times 10^3 \frac{\text{J}}{\text{mol}}$$

Calculate actual enthalpy change using the expander efficiency.

$$\Delta H := \eta \Delta H_S \quad \Delta H = -4.496 \times 10^3 \frac{\text{J}}{\text{mol}}$$

Find T2 such that  $\Delta H$  matches the value above.

Given

$$\eta \Delta H_S = \text{MCPH}(T_1, T_2, A, B, C, D) \cdot R \cdot (T_2 - T_1) \dots$$

$$+ R \cdot T_c \cdot \text{HRB}\left(\frac{T_2}{T_c}, \theta_{r2}, \dots\right) - R \cdot T_c \cdot \text{HRB}(T_{r1}, \theta_{r1}, \dots)$$

$$T_2 := \text{Find}(T_2) \quad T_2 = 268.536 \text{ K} \quad \text{Ans.}$$



Now recalculate  $\Delta S$  at calculated  $T_2$

$$\Delta S := \left( R \cdot \text{MCPS}(T_1, T_2, A, B, C, D) \cdot \ln\left(\frac{T_2}{T_1}\right) - R \cdot \ln\left(\frac{P_2}{P_1}\right) \right) \dots \quad \text{Eq. (6-94)}$$

$$+ R \cdot \text{SRB}(T_{r2}, B_{r2}) - R \cdot \text{SRB}(T_{r1}, B_{r1})$$

$$\Delta S = 7.77 \frac{\text{J}}{\text{mol} \cdot \text{K}} \quad \text{Ans.}$$

Calculate power produced by expander

$$P := \eta \Delta H \quad P = -3.147 \frac{\text{kJ}}{\text{mol}} \quad \text{Ans.}$$

The advantage of the expander is that power can be produced in the expander which can be used in the plant. The disadvantages are the extra capital and operating cost of the expander and the low temperature of the gas leaving the expander compared to the gas leaving the throttle valve.

7.60 Hydrocarbon gas:

$$T_1 := 500 \text{ degC}$$

$$C_{\text{pgas}} := 150 \frac{\text{J}}{\text{mol} \cdot \text{K}}$$

Light oil:

$$T_2 := 25 \text{ degC}$$

$$C_{\text{poil}} := 200 \frac{\text{J}}{\text{mol} \cdot \text{K}}$$

$$\Delta H_{\text{lv}} := 35000 \frac{\text{J}}{\text{mol}}$$

Exit stream:

$$T_3 := 200 \text{ degC}$$

- b) Assume that the oil vaporizes at 25 C. For an adiabatic column, the overall energy balance is as follows.

$$F \cdot C_{\text{pgas}} \cdot (T_3 - T_1) + D \cdot [\Delta H_{\text{lv}} + C_{\text{oilp}} \cdot (T_3 - T_2)] = 0$$

Solving for D/F gives:

$$DF := \frac{-[C_{\text{pgas}} \cdot (T_3 - T_1)]}{[\Delta H_{\text{lv}} + C_{\text{poil}} \cdot (T_3 - T_2)]} \quad DF = 0.643 \quad \text{Ans.}$$

- c) Using liquid oil to quench the gas stream requires a smaller oil flow rate. This is because a significant portion of the energy lost by the gas is used to vaporize the oil.

## Chapter 8 - Section A - Mathcad Solutions

8.1 With reference to Fig. 8.1, SI units,

At point 2: Table F.2,  $H_2 := 3531.5$   $S_2 := 6.9636$

At point 4: Table F.1,  $H_4 := 209.3$

At point 1:  $H_1 := H_4$

At point 3: Table F.1,  $H_{liq} := H_4$   $\Delta H_{lv} := 2382.9$

$x_3 := 0.96$   $H_3 := H_{liq} + x_3 \cdot \Delta H_{lv}$   $H_3 = 2496.9$

$S_{liq} := 0.7035$   $\Delta S_{lv} := 7.3241$

For isentropic expansion,  $S'_3 := S_2$

$x'_3 := \frac{S'_3 - S_{liq}}{\Delta S_{lv}}$   $x'_3 = 0.855$

$H'_3 := H_{liq} + x'_3 \cdot \Delta H_{lv}$   $H'_3 = 2246$

$\eta_{turbine} := \frac{H_3 - H_2}{H'_3 - H_2}$   $\eta_{turbine} = 0.805$  **Ans.**

$W_s := H_3 - H_2$   $Q_H := H_2 - H_1$

$W_s = -1.035 \times 10^3$   $Q_H = 3.322 \times 10^3$

$\eta_{cycle} := \frac{|W_s|}{Q_H}$   $\eta_{cycle} = 0.311$  **Ans.**

8.2  $\dot{m} := 1.0$  (kg/s)

The following property values are found by linear interpolation in Table F.1:

State 1, Sat. Liquid at TH:  $H1 := 860.7$        $S1 := 2.3482$        $P1 := 3.533$

State 2, Sat. Vapor at TH:  $H2 := 2792.0$        $S2 := 6.4139$        $P2 := 3.533$

State 3, Wet Vapor at TC:  $H_{liq} := 112.5$        $H_{vap} := 2550.6$        $P3 := 1616.0$

State 4, Wet Vapor at TC:  $S_{liq} := 0.3929$        $S_{vap} := 8.5200$        $P4 := 1616.0$

(a) The pressures in kPa appear above.

(b) Steps 2--3 and 4--1 (Fig. 8.2) are isentropic, for which  $S3=S2$  and  $S1=S4$ . Thus by Eq. 6.82):

$$x3 := \frac{S2 - S_{liq}}{S_{vap} - S_{liq}} \quad x3 = 0.741 \quad x4 := \frac{S1 - S_{liq}}{S_{vap} - S_{liq}} \quad x4 = 0.241$$

(c) The rate of heat addition, Step 1--2:

$$\dot{Q}_{12} := \dot{m} \cdot (H2 - H1) \quad \dot{Q}_{12} = 1.931 \times 10^3 \quad (\text{kJ/s})$$

(d) The rate of heat rejection, Step 3--4:

$$H3 := H_{liq} + x3 \cdot (H_{vap} - H_{liq}) \quad H4 := H_{liq} + x4 \cdot (H_{vap} - H_{liq})$$

$$H3 = 1.919 \times 10^3$$

$$H4 = 699.083$$

$$\dot{Q}_{34} := \dot{m} \cdot (H4 - H3) \quad \dot{Q}_{34} = -1.22 \times 10^3 \quad (\text{kJ/s})$$

(e)  $\dot{W}_{12} := 0$        $\dot{W}_{34} := 0$

$$\dot{W}_{23} := \dot{m} \cdot (H3 - H2) \quad \dot{W}_{23} = -873.222$$

$$\dot{W}_{41} := \dot{m} \cdot (H1 - H4) \quad \dot{W}_{41} = 161.617$$

(f)  $\eta := \left| \frac{\dot{W}_{23} + \dot{W}_{41}}{\dot{Q}_{12}} \right| \quad \eta = 0.368$

Note that the first law is satisfied:

$$\Sigma \dot{Q} := \dot{Q}_{12} + \dot{Q}_{34} \quad \Sigma \dot{W} := \dot{W}_{23} + \dot{W}_{41}$$

$$\Sigma \dot{Q} + \Sigma \dot{W} = 0$$

8.3 The following vectors contain values for Parts (a) through (f).

Enthalpies and entropies for superheated vapor, Tables F.2 and F.4 @ P2 and T2 (see Fig. 8.4):

$$H_2 := \begin{pmatrix} 3622.7 \cdot \frac{\text{kJ}}{\text{kg}} \\ 3529.6 \cdot \frac{\text{kJ}}{\text{kg}} \\ 3635.4 \cdot \frac{\text{kJ}}{\text{kg}} \\ 3475.6 \cdot \frac{\text{kJ}}{\text{kg}} \\ 1507.0 \cdot \frac{\text{BTU}}{\text{lb}_m} \\ 1558.8 \cdot \frac{\text{BTU}}{\text{lb}_m} \end{pmatrix}$$

$$S_2 := \begin{pmatrix} 6.9013 \cdot \frac{\text{kJ}}{\text{kg} \cdot \text{K}} \\ 6.9485 \cdot \frac{\text{kJ}}{\text{kg} \cdot \text{K}} \\ 6.9875 \cdot \frac{\text{kJ}}{\text{kg} \cdot \text{K}} \\ 6.9145 \cdot \frac{\text{kJ}}{\text{kg} \cdot \text{K}} \\ 1.6595 \cdot \frac{\text{BTU}}{\text{lb}_m \cdot \text{rankine}} \\ 1.6759 \cdot \frac{\text{BTU}}{\text{lb}_m \cdot \text{rankine}} \end{pmatrix}$$

Sat. liq. and sat. vap. values from Tables F.2 and F.4 @ P3 = P4:

$$H_{\text{liq}} := \begin{pmatrix} 191.832 \cdot \frac{\text{kJ}}{\text{kg}} \\ 251.453 \cdot \frac{\text{kJ}}{\text{kg}} \\ 191.832 \cdot \frac{\text{kJ}}{\text{kg}} \\ 419.064 \cdot \frac{\text{kJ}}{\text{kg}} \\ 180.17 \cdot \frac{\text{BTU}}{\text{lb}_m} \\ 69.73 \cdot \frac{\text{BTU}}{\text{lb}_m} \end{pmatrix}$$

$$H_{\text{vap}} := \begin{pmatrix} 2584.8 \cdot \frac{\text{kJ}}{\text{kg}} \\ 2609.9 \cdot \frac{\text{kJ}}{\text{kg}} \\ 2584.8 \cdot \frac{\text{kJ}}{\text{kg}} \\ 2676.0 \cdot \frac{\text{kJ}}{\text{kg}} \\ 1150.5 \cdot \frac{\text{BTU}}{\text{lb}_m} \\ 1105.8 \cdot \frac{\text{BTU}}{\text{lb}_m} \end{pmatrix}$$

$$S_{\text{liq}} := \begin{pmatrix} 0.6493 \cdot \frac{\text{kJ}}{\text{kg} \cdot \text{K}} \\ 0.8321 \cdot \frac{\text{kJ}}{\text{kg} \cdot \text{K}} \\ 0.6493 \cdot \frac{\text{kJ}}{\text{kg} \cdot \text{K}} \\ 1.3069 \cdot \frac{\text{kJ}}{\text{kg} \cdot \text{K}} \\ 0.3121 \cdot \frac{\text{BTU}}{\text{lb}_m \cdot \text{rankine}} \\ 0.1326 \cdot \frac{\text{BTU}}{\text{lb}_m \cdot \text{rankine}} \end{pmatrix}$$

$$S_{\text{vap}} := \begin{pmatrix} 8.1511 \cdot \frac{\text{kJ}}{\text{kg} \cdot \text{K}} \\ 7.9094 \cdot \frac{\text{kJ}}{\text{kg} \cdot \text{K}} \\ 8.1511 \cdot \frac{\text{kJ}}{\text{kg} \cdot \text{K}} \\ 7.3554 \cdot \frac{\text{kJ}}{\text{kg} \cdot \text{K}} \\ 1.7568 \cdot \frac{\text{BTU}}{\text{lb}_m \cdot \text{rankine}} \\ 1.9781 \cdot \frac{\text{BTU}}{\text{lb}_m \cdot \text{rankine}} \end{pmatrix}$$

$$V_{\text{liq}} := \begin{pmatrix} 1.010 \cdot \frac{\text{cm}^3}{\text{gm}} \\ 1.017 \cdot \frac{\text{cm}^3}{\text{gm}} \\ 1.010 \cdot \frac{\text{cm}^3}{\text{gm}} \\ 1.044 \cdot \frac{\text{cm}^3}{\text{gm}} \\ 0.0167 \cdot \frac{\text{ft}^3}{\text{lb}_m} \\ 0.0161 \cdot \frac{\text{ft}^3}{\text{lb}_m} \end{pmatrix}$$

$$\eta_{\text{turbine}} := \begin{pmatrix} 0.80 \\ 0.75 \\ 0.80 \\ 0.78 \\ 0.78 \\ 0.80 \end{pmatrix}$$

$$\eta_{\text{pump}} := \begin{pmatrix} 0.75 \\ 0.75 \\ 0.80 \\ 0.75 \\ 0.75 \\ 0.75 \end{pmatrix}$$

$$\dot{W} := - \begin{pmatrix} 80 \\ 100 \\ 70 \\ 50 \\ 50 \\ 80 \end{pmatrix} \cdot 10^3 \cdot \text{kW}$$

$$P_1 := \begin{pmatrix} 10000 \cdot \text{kPa} \\ 7000 \cdot \text{kPa} \\ 8500 \cdot \text{kPa} \\ 6500 \cdot \text{kPa} \\ 950 \cdot \text{psi} \\ 1125 \cdot \text{psi} \end{pmatrix}$$

$$P_4 := \begin{pmatrix} 10 \cdot \text{kPa} \\ 20 \cdot \text{kPa} \\ 10 \cdot \text{kPa} \\ 101.33 \cdot \text{kPa} \\ 14.7 \cdot \text{psi} \\ 1 \cdot \text{psi} \end{pmatrix}$$

$$W_{\text{pump}} := \frac{V_{\text{liq}} \cdot (P_1 - P_4)}{\eta_{\text{pump}}}$$

$$H_4 := H_{\text{liq}}$$

$$H_1 := H_4 + W_{\text{pump}}$$

$$S'_3 = S_2 \quad x'_3 := \frac{S_2 - S_{\text{liq}}}{S_{\text{vap}} - S_{\text{liq}}}$$

$$H'_3 := \left[ H_{\text{liq}} + x'_3 \cdot (H_{\text{vap}} - H_{\text{liq}}) \right]$$

$$H_3 := \left[ H_2 + \eta_{\text{turbine}} \cdot (H'_3 - H_2) \right]$$

$$W_{\text{turbine}} := H_3 - H_2$$

$$\dot{m} := \frac{\dot{W}}{W_{\text{turbine}} + W_{\text{pump}}}$$

$$\dot{Q}_{\text{H}} := (H_2 - H_1) \cdot \dot{m}$$

$$\dot{Q}_{\text{C}} := \dot{Q}_{\text{H}} + \dot{W}$$

**Answers follow:**

$$\begin{pmatrix} \dot{m}_{\text{dot}_1} \\ \dot{m}_{\text{dot}_2} \\ \dot{m}_{\text{dot}_3} \\ \dot{m}_{\text{dot}_4} \end{pmatrix} = \begin{pmatrix} 70.43 \\ 108.64 \\ 62.13 \\ 67.29 \end{pmatrix} \frac{\text{kg}}{\text{sec}}$$

$$\begin{pmatrix} \dot{Q}_{\text{H}_1} \\ \dot{Q}_{\text{H}_2} \\ \dot{Q}_{\text{H}_3} \\ \dot{Q}_{\text{H}_4} \end{pmatrix} = \begin{pmatrix} 240705 \\ 355111 \\ 213277 \\ 205061 \end{pmatrix} \frac{\text{kJ}}{\text{sec}}$$

$$\begin{pmatrix} \dot{m}_{\text{dot}_5} \\ \dot{m}_{\text{dot}_6} \end{pmatrix} = \begin{pmatrix} 145.733 \\ 153.598 \end{pmatrix} \frac{\text{lb}_m}{\text{sec}}$$

$$\begin{pmatrix} \dot{Q}_{\text{H}_5} \\ \dot{Q}_{\text{H}_6} \end{pmatrix} = \begin{pmatrix} 192801 \\ 228033 \end{pmatrix} \frac{\text{BTU}}{\text{sec}}$$

$$\begin{pmatrix} \dot{Q}_{C_1} \\ \dot{Q}_{C_2} \\ \dot{Q}_{C_3} \\ \dot{Q}_{C_4} \end{pmatrix} = \begin{pmatrix} 160705 \\ 255111 \\ 143277 \\ 155061 \end{pmatrix} \frac{\text{kJ}}{\text{sec}}$$

$$\eta := \frac{|\dot{W}|}{\dot{Q}_H}$$

$$\eta = \begin{pmatrix} 0.332 \\ 0.282 \\ 0.328 \\ 0.244 \\ 0.246 \\ 0.333 \end{pmatrix}$$

$$\begin{pmatrix} \dot{Q}_{C_5} \\ \dot{Q}_{C_6} \end{pmatrix} = \begin{pmatrix} 145410 \\ 152208 \end{pmatrix} \frac{\text{BTU}}{\text{sec}}$$

8.4 Subscripts refer to Fig. 8.3.

Saturated liquid at 50 kPa (point 4)

$$V_4 := 1.030 \cdot \frac{\text{cm}^3}{\text{gm}}$$

$$H_4 := 340.564 \cdot \frac{\text{kJ}}{\text{kg}}$$

$$P_4 := 3300 \cdot \text{kPa}$$

$$P_1 := 50 \cdot \text{kPa}$$

Saturated liquid and vapor at 50 kPa:

$$H_{\text{liq}} := H_4$$

$$H_{\text{vap}} := 2646.0 \cdot \frac{\text{kJ}}{\text{kg}}$$

$$S_{\text{liq}} := 1.0912 \cdot \frac{\text{kJ}}{\text{kg} \cdot \text{K}}$$

$$S_{\text{vap}} := 7.5947 \cdot \frac{\text{kJ}}{\text{kg} \cdot \text{K}}$$

By Eq. (7.24),

$$W_{\text{pump}} := V_4 \cdot (P_4 - P_1)$$

$$W_{\text{pump}} = 3.348 \frac{\text{kJ}}{\text{kg}}$$

$$H_1 := H_4 + W_{\text{pump}}$$

$$H_1 = 343.911 \frac{\text{kJ}}{\text{kg}}$$

The following vectors give values for temperatures of 450, 550, and 650 degC:

$$H_2 := \begin{pmatrix} 3340.6 \\ 3565.3 \\ 3792.9 \end{pmatrix} \cdot \frac{\text{kJ}}{\text{kg}}$$

$$S_2 := \begin{pmatrix} 7.0373 \\ 7.3282 \\ 7.5891 \end{pmatrix} \cdot \frac{\text{kJ}}{\text{kg} \cdot \text{K}}$$

$$S'_3 := S_2$$

$$x'_3 := \frac{S'_3 - S_{\text{liq}}}{S_{\text{vap}} - S_{\text{liq}}}$$

$$H'_3 := H_{\text{liq}} + x'_3 \cdot (H_{\text{vap}} - H_{\text{liq}})$$

$$W_{\text{turbine}} := H'_3 - H_2$$

$$Q_H := (H_2 - H_1)$$

$$\eta := \frac{|W_{\text{turbine}} + W_{\text{pump}}|}{Q_H}$$

$$x'_3 = \begin{pmatrix} 0.914 \\ 0.959 \\ 0.999 \end{pmatrix}$$

$$\eta = \begin{pmatrix} 0.297 \\ 0.314 \\ 0.332 \end{pmatrix}$$

Ans.

8.5 Subscripts refer to Fig. 8.3.

Saturated liquid at 30 kPa (point 4)

$$V_4 := 1.022 \cdot \frac{\text{cm}^3}{\text{gm}}$$

$$H_4 := 289.302 \cdot \frac{\text{kJ}}{\text{kg}}$$

$$P_1 := 30 \cdot \text{kPa}$$

Saturated liquid and vapor at 30 kPa:

$$H_{\text{liq}} := H_4$$

$$H_{\text{vap}} := 2625.4 \cdot \frac{\text{kJ}}{\text{kg}}$$

$$P_4 := \begin{pmatrix} 5000 \\ 7500 \\ 10000 \end{pmatrix} \cdot \text{kPa}$$

$$S_{\text{liq}} := 0.9441 \cdot \frac{\text{kJ}}{\text{kg} \cdot \text{K}}$$

$$S_{\text{vap}} := 7.7695 \cdot \frac{\text{kJ}}{\text{kg} \cdot \text{K}}$$

By Eq. (7.24),

$$W_{\text{pump}} := [V_4 \cdot (P_4 - P_1)]$$

$$H_1 := H_4 + W_{\text{pump}}$$

$$H_1 = \begin{pmatrix} 294.381 \\ 296.936 \\ 299.491 \end{pmatrix} \frac{\text{kJ}}{\text{kg}}$$

The following vectors give values for pressures of 5000, 7500, and 10000 kPa at 600 degC

$$H_2 := \begin{pmatrix} 3664.5 \\ 3643.7 \\ 3622.7 \end{pmatrix} \frac{\text{kJ}}{\text{kg}}$$

$$S_2 := \begin{pmatrix} 7.2578 \\ 7.0526 \\ 6.9013 \end{pmatrix} \frac{\text{kJ}}{\text{kg} \cdot \text{K}}$$



$$S'_3 := S_2$$

$$x'_3 := \frac{S'_3 - S_{\text{liq}}}{S_{\text{vap}} - S_{\text{liq}}}$$

$$H'_3 := H_{\text{liq}} + x'_3 \cdot (H_{\text{vap}} - H_{\text{liq}})$$

$$W_{\text{turbine}} := H'_3 - H_2$$

$$Q_H := (H_2 - H_1)$$

$$\eta := \frac{|W_{\text{turbine}} + W_{\text{pump}}|}{Q_H}$$

$$x'_3 = \begin{pmatrix} 0.925 \\ 0.895 \\ 0.873 \end{pmatrix}$$

$$\eta = \begin{pmatrix} 0.359 \\ 0.375 \\ 0.386 \end{pmatrix} \quad \text{Ans.}$$

### 8.6 From Table F.2 at 7000 kPa and 640 degC:

$$H_1 := 3766.4 \cdot \frac{\text{kJ}}{\text{kg}}$$

$$S_1 := 7.2200 \cdot \frac{\text{kJ}}{\text{kg} \cdot \text{K}}$$

$$S'_2 := S_1$$

For sat. liq. and sat. vap. at 20 kPa:

$$H_{\text{liq}} := 251.453 \cdot \frac{\text{kJ}}{\text{kg}}$$

$$H_{\text{vap}} := 2609.9 \cdot \frac{\text{kJ}}{\text{kg}}$$

$$S_{\text{liq}} := 0.8321 \cdot \frac{\text{kJ}}{\text{kg} \cdot \text{K}}$$

$$S_{\text{vap}} := 7.9094 \cdot \frac{\text{kJ}}{\text{kg} \cdot \text{K}}$$

The following enthalpies are interpolated in Table F.2 at four values for intermediate pressure P2:

$$P_2 := \begin{pmatrix} 725 \\ 750 \\ 775 \\ 800 \end{pmatrix} \cdot \text{kPa}$$

$$H'_2 := \begin{pmatrix} 3023.9 \\ 3032.5 \\ 3040.9 \\ 3049.0 \end{pmatrix} \cdot \frac{\text{kJ}}{\text{kg}}$$

$$\eta := 0.78$$

$$W_{12} := \eta \cdot (H'_2 - H_1)$$

$$H_2 := H_1 + W_{12}$$

$$W_{12} = \begin{pmatrix} -579.15 \\ -572.442 \\ -565.89 \\ -559.572 \end{pmatrix} \cdot \frac{\text{kJ}}{\text{kg}}$$

$$H_2 = \begin{pmatrix} 3187.3 \\ 3194 \\ 3200.5 \\ 3206.8 \end{pmatrix} \cdot \frac{\text{kJ}}{\text{kg}}$$

$$S_2 := \begin{pmatrix} 7.4939 \\ 7.4898 \\ 7.4851 \\ 7.4797 \end{pmatrix} \cdot \frac{\text{kJ}}{\text{kg} \cdot \text{K}}$$

where the entropy values are by interpolation in Table F.2 at P2.

$$x'_3 := \frac{S_2 - S_{\text{liq}}}{S_{\text{vap}} - S_{\text{liq}}} \quad H'_3 := H_{\text{liq}} + x'_3 \cdot (H_{\text{vap}} - H_{\text{liq}})$$

$$W_{23} := \eta \cdot (H'_3 - H_2)$$

$$\Delta W := W_{12} - W_{23}$$

$$\Delta W = \begin{pmatrix} -20.817 \\ -7.811 \\ 5.073 \\ 17.723 \end{pmatrix} \frac{\text{kJ}}{\text{kg}}$$

The work difference is essentially linear in P2, and we interpolate linearly to find the value of P2 for which the work difference is zero:

$$\text{linterp} \left[ \frac{\Delta W}{\left( \frac{\text{kJ}}{\text{kg}} \right)}, P_2, 0.0 \right] = 765.16 \text{ kPa} \quad (\text{P2})$$

Also needed are values of H2 and S2 at this pressure. Again we do linear interpolations:

$$\text{linterp}(P_2, H_2, 765.16 \cdot \text{kPa}) = 3197.9 \frac{\text{kJ}}{\text{kg}} \quad H_2 := 3197.9 \cdot \frac{\text{kJ}}{\text{kg}}$$

$$\text{linterp}(P_2, S_2, 765.16 \cdot \text{kPa}) = 7.4869 \frac{\text{kJ}}{\text{kg} \cdot \text{K}} \quad S_2 := 7.4869 \cdot \frac{\text{kJ}}{\text{kg} \cdot \text{K}}$$

We can now find the temperature at this state by interpolation in Table F.2. This gives an intermediate steam temperature t2 of 366.6 degC.

The work calculations must be repeated for THIS case:

$$W_{12} := H_2 - H_1 \quad x'_3 := \frac{S_2 - S_{\text{liq}}}{S_{\text{vap}} - S_{\text{liq}}}$$

$$W_{12} = -568.5 \frac{\text{kJ}}{\text{kg}}$$

$$x'_3 = 0.94$$

$$H'_3 := H_{\text{liq}} + x'_3 \cdot (H_{\text{vap}} - H_{\text{liq}})$$

$$W_{23} := \eta \cdot (H'_3 - H_2)$$

$$H'_3 = 2.469 \times 10^3 \frac{\text{kJ}}{\text{kg}}$$

$$W_{23} = -568.46 \frac{\text{kJ}}{\text{kg}}$$

$$\text{Work} := W_{12} + W_{23}$$

$$\text{Work} = -1137 \frac{\text{kJ}}{\text{kg}}$$

**For a single isentropic expansion from the initial pressure to the final pressure, which yields a wet exhaust:**

$$x'_3 := \frac{S_1 - S_{\text{liq}}}{S_{\text{vap}} - S_{\text{liq}}}$$

$$H'_3 := H_{\text{liq}} + x'_3 \cdot (H_{\text{vap}} - H_{\text{liq}})$$

$$x'_3 = 0.903$$

$$H'_3 = 2.38 \times 10^3 \frac{\text{kJ}}{\text{kg}}$$

$$W' := H'_3 - H_1$$

$$W' = -1386.2 \frac{\text{kJ}}{\text{kg}}$$

**Whence the overall efficiency is:**

$$\eta_{\text{overall}} := \frac{\text{Work}}{W'}$$

$$\eta_{\text{overall}} = 0.8202$$

**Ans.**

8.7

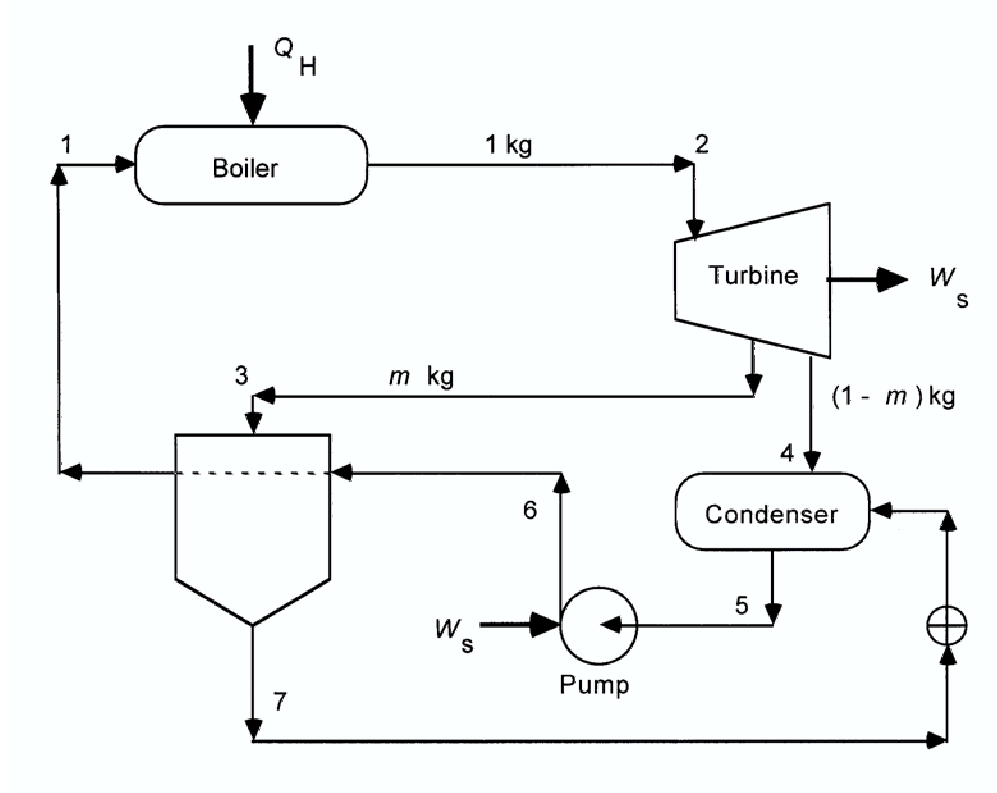

From Table F.2 for steam at 4500 kPa and 500 degC:

$$H_2 := 3439.3 \cdot \frac{\text{kJ}}{\text{kg}}$$

$$S_2 := 7.0311 \cdot \frac{\text{kJ}}{\text{kg} \cdot \text{K}}$$

$$S'_3 := S_2$$

By interpolation at 350 kPa and this entropy,

$$H'_3 := 2770.6 \cdot \frac{\text{kJ}}{\text{kg}}$$

$$\eta := 0.78$$

$$W_I := \eta \cdot (H'_3 - H_2)$$

$$H_3 := H_2 + W_I$$

$$H_3 = 2.918 \times 10^3 \frac{\text{kJ}}{\text{kg}}$$

$$W_I = -521.586 \frac{\text{kJ}}{\text{kg}}$$

Isentropic expansion to 20 kPa:

$$S'_4 := S_2$$

Exhaust is wet: for sat. liq. & vap.:

$$H_{\text{liq}} := 251.453 \cdot \frac{\text{kJ}}{\text{kg}}$$

$$H_{\text{vap}} := 2609.9 \cdot \frac{\text{kJ}}{\text{kg}}$$

$$S_{\text{liq}} := 0.8321 \cdot \frac{\text{kJ}}{\text{kg} \cdot \text{K}}$$

$$S_{\text{vap}} := 7.9094 \cdot \frac{\text{kJ}}{\text{kg} \cdot \text{K}}$$

$$x'_4 := \frac{S'_4 - S_{\text{liq}}}{S_{\text{vap}} - S_{\text{liq}}} \quad H'_4 := H_{\text{liq}} + x'_4 \cdot (H_{\text{vap}} - H_{\text{liq}})$$

$$x'_4 = 0.876$$

$$H'_4 = 2.317 \times 10^3 \frac{\text{kJ}}{\text{kg}}$$

$$H_4 := H_2 + \eta \cdot (H'_4 - H_2)$$

$$H_4 = 2.564 \times 10^3 \frac{\text{kJ}}{\text{kg}}$$

$$H_5 := H_{\text{liq}}$$

$$V_5 := 1.017 \cdot \frac{\text{cm}^3}{\text{gm}}$$

$$P_5 := 20 \cdot \text{kPa}$$

$$P_6 := 4500 \cdot \text{kPa}$$

$$W_{\text{pump}} := \frac{V_5 \cdot (P_6 - P_5)}{\eta}$$

$$H_6 := H_5 + W_{\text{pump}}$$

$$W_{\text{pump}} = 5.841 \frac{\text{kJ}}{\text{kg}}$$

$$H_6 = 257.294 \frac{\text{kJ}}{\text{kg}}$$

**For sat. liq. at 350 kPa (Table F.2):**

$$H_7 := 584.270 \cdot \frac{\text{kJ}}{\text{kg}}$$

$$t_7 := 138.87 \quad (\text{degC})$$

**We need the enthalpy of compressed liquid at point 1, where the pressure is 4500 kPa and the temperature is:**

$$t_1 := 138.87 - 6$$

$$T_1 := (t_1 + 273.15) \cdot \text{K}$$

$$t_1 = 132.87$$

**At this temperature, 132.87 degC, interpolation in Table F.1 gives:**

$$H_{\text{sat.liq}} := 558.5 \cdot \frac{\text{kJ}}{\text{kg}}$$

$$P_{\text{sat}} := 294.26 \cdot \text{kPa}$$

$$V_{\text{sat.liq}} := 1.073 \cdot \frac{\text{cm}^3}{\text{gm}}$$

**Also by approximation, the definition of the volume expansivity yields:**

$$\beta := \frac{1}{V_{\text{sat.liq}}} \cdot \left( \frac{1.083 - 1.063}{20} \right) \cdot \frac{\text{cm}^3}{\text{gm} \cdot \text{K}}$$

$$P_1 := P_6$$

$$\beta = 9.32 \times 10^{-4} \frac{1}{\text{K}}$$

By Eq. (7.25),

$$H_1 := H_{\text{sat.liq}} + v_{\text{sat.liq}} \cdot (P_1 - P_{\text{sat}}) - \beta \cdot T_1 \quad H_1 = 561.305 \frac{\text{kJ}}{\text{kg}}$$

By an energy balance on the feedwater heater:

$$\text{mass} := \frac{H_1 - H_6}{H_3 - H_7} \cdot \text{kg} \quad \text{mass} = 0.13028 \text{ kg} \quad \text{Ans.}$$

Work in 2nd section of turbine:

$$W_{\text{II}} := (1 \cdot \text{kg} - \text{mass}) \cdot (H_4 - H_3) \quad W_{\text{II}} = -307.567 \text{ kJ}$$

$$W_{\text{net}} := (W_{\text{I}} + W_{\text{pump}}) \cdot 1 \cdot \text{kg} + W_{\text{II}} \quad W_{\text{net}} = -823.3 \text{ kJ}$$

$$Q_{\text{H}} := (H_2 - H_1) \cdot 1 \cdot \text{kg}$$

$$Q_{\text{H}} = 2878 \text{ kJ}$$

$$\eta := \frac{|W_{\text{net}}|}{Q_{\text{H}}} \quad \eta = 0.2861 \quad \text{Ans.}$$

8.8 Refer to figure in preceding problem.

Although entropy values are not needed for most points in the process, they are recorded here for future use in Problem 15.8.

From Table F.4 for steam at 650(psia) & 900 degF:

$$H_2 := 1461.2 \cdot \frac{\text{BTU}}{\text{lb}_m} \quad S_2 := 1.6671 \cdot \frac{\text{BTU}}{\text{lb}_m \cdot \text{rankine}} \quad S'_3 := S_2$$

By interpolation at 50(psia) and this entropy,

$$H'_3 := 1180.4 \cdot \frac{\text{BTU}}{\text{lb}_m} \quad \eta := 0.78 \quad W_{\text{I}} := \eta \cdot (H'_3 - H_2)$$

$$H_3 := H_2 + W_{\text{I}} \quad H_3 = 1242.2 \cdot \frac{\text{BTU}}{\text{lb}_m} \quad W_{\text{I}} = -219.024 \cdot \frac{\text{BTU}}{\text{lb}_m}$$

$$S_3 := 1.7431 \cdot \frac{\text{BTU}}{\text{lb}_m \cdot \text{rankine}}$$

Isentropic expansion to 1(psia):

$$S'_4 := S_2$$

Exhaust is wet: for sat. liq. & vap.:

$$H_{\text{liq}} := 69.73 \cdot \frac{\text{BTU}}{\text{lb}_m}$$

$$H_{\text{vap}} := 1105.8 \cdot \frac{\text{BTU}}{\text{lb}_m}$$

$$S_{\text{liq}} := 0.1326 \cdot \frac{\text{BTU}}{\text{lb}_m \cdot \text{rankine}}$$

$$S_{\text{vap}} := 1.9781 \cdot \frac{\text{BTU}}{\text{lb}_m \cdot \text{rankine}}$$

$$x'_4 := \frac{S'_4 - S_{\text{liq}}}{S_{\text{vap}} - S_{\text{liq}}}$$

$$H'_4 := H_{\text{liq}} + x'_4 \cdot (H_{\text{vap}} - H_{\text{liq}})$$

$$x'_4 = 0.831$$

$$H'_4 = 931.204 \cdot \frac{\text{BTU}}{\text{lb}_m}$$

$$H_4 := H_2 + \eta \cdot (H'_4 - H_2)$$

$$H_4 = 1047.8 \cdot \frac{\text{BTU}}{\text{lb}_m}$$

$$x_4 := \frac{H_4 - H_{\text{liq}}}{H_{\text{vap}} - H_{\text{liq}}}$$

$$S_4 := S_{\text{liq}} + x_4 \cdot (S_{\text{vap}} - S_{\text{liq}})$$

$$x_4 = 0.944$$

$$S_4 = 1.8748 \cdot \frac{\text{BTU}}{\text{lb}_m \cdot \text{rankine}}$$

$$P_5 := 1 \cdot \text{psi}$$

$$H_5 := H_{\text{liq}}$$

$$V_5 := 0.0161 \cdot \frac{\text{ft}^3}{\text{lb}_m}$$

$$W_{\text{pump}} := \frac{V_5 \cdot (P_6 - P_5)}{\eta}$$

$$W_{\text{pump}} = 2.489 \cdot \frac{\text{BTU}}{\text{lb}_m}$$

$$P_6 := 650 \cdot \text{psi}$$

$$H_6 := H_5 + W_{\text{pump}}$$

$$H_6 = 72.219 \cdot \frac{\text{BTU}}{\text{lb}_m}$$

For sat. liq. at 50(psia) (Table F.4):

$$H_7 := 250.21 \cdot \frac{\text{BTU}}{\text{lb}_m}$$

$$t_7 := 281.01$$

$$S_7 := 0.4112 \cdot \frac{\text{BTU}}{\text{lb}_m \cdot \text{rankine}}$$

We need the enthalpy of compressed liquid at point 1, where the pressure is 650(psia) and the temperature is

$$t_1 := 281.01 - 11$$

$$T_1 := (t_1 + 459.67) \cdot \text{rankine}$$

$$t_1 = 270.01$$

At this temperature, 270.01 degF, interpolation in Table F.3 gives:

$$P_{\text{sat}} := 41.87 \cdot \text{psi}$$

$$V_{\text{sat.liq}} := 0.1717 \cdot \frac{\text{ft}^3}{\text{lb}_m}$$

$$H_{\text{sat.liq}} := 238.96 \cdot \frac{\text{BTU}}{\text{lb}_m}$$

$$S_{\text{sat.liq}} := 0.3960 \cdot \frac{\text{BTU}}{\text{lb}_m \cdot \text{rankine}}$$

The definition of the volume expansivity yields:

$$\beta := \frac{1}{V_{\text{sat.liq}}} \cdot \left( \frac{0.01726 - 0.01709}{20} \right) \cdot \frac{\text{ft}^3}{\text{lb}_m \cdot \text{rankine}} \quad P_1 := P_6$$

$$\beta = 4.95 \times 10^{-5} \frac{1}{\text{rankine}}$$

By Eq. (7.25) and (7.26),

$$H_1 := H_{\text{sat.liq}} + V_{\text{sat.liq}} \cdot (-\beta \cdot T_1) \cdot (P_1 - P_{\text{sat}})$$

$$H_1 = 257.6 \frac{\text{BTU}}{\text{lb}_m}$$

$$S_1 := S_{\text{sat.liq}} + V_{\text{sat.liq}} \cdot \beta \cdot (P_1 - P_{\text{sat}})$$

$$S_1 = 0.397 \frac{\text{BTU}}{\text{lb}_m \cdot \text{rankine}}$$

By an energy balance on the feedwater heater:

$$\text{mass} := \frac{H_1 - H_6}{H_3 - H_7} \cdot \text{lb}_m$$

$$\text{mass} = 0.18687 \text{ lb}_m \quad \text{Ans.}$$

Work in 2nd section of turbine:

$$W_{\text{II}} := (1) \cdot \text{lb}_m - \text{mass} \cdot (H_4 - H_3)$$

$$W_{\text{II}} = -158.051 \text{ BTU}$$

$$W_{\text{net}} := (1) W_{\text{I}} + W_{\text{pump}} \cdot 1 \cdot \text{lb}_m + W_{\text{II}}$$

$$W_{\text{net}} = -374.586 \text{ BTU}$$

$$Q_{\text{H}} := (H_2 - H_1) \cdot 1 \cdot \text{lb}_m$$

$$Q_{\text{H}} = 1.204 \times 10^3 \text{ BTU}$$

$$\eta := \frac{|W_{\text{net}}|}{Q_{\text{H}}} \quad \eta = 0.3112 \quad \text{Ans.}$$



8.9

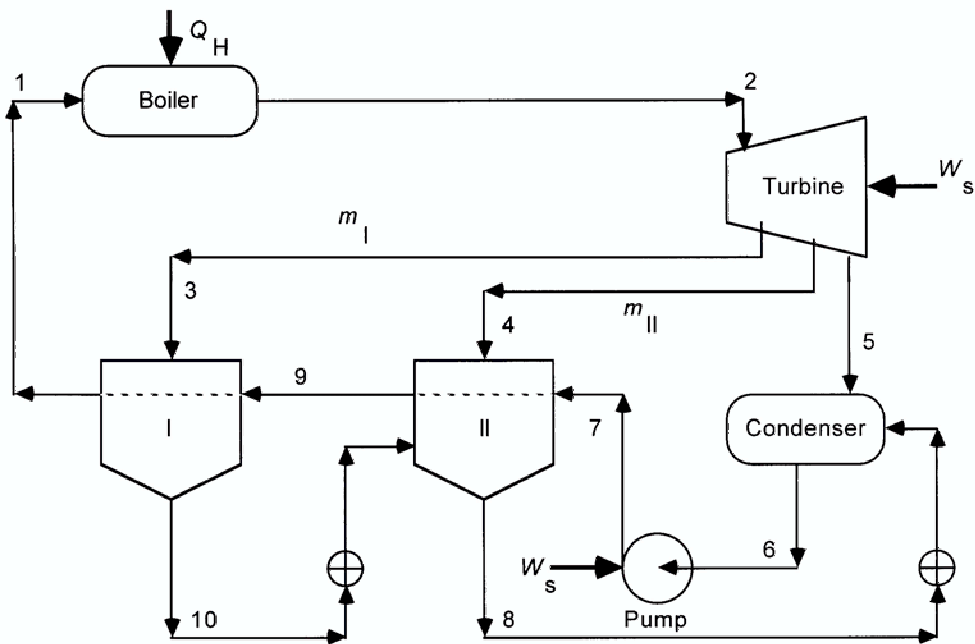

Steam at 6500 kPa & 600 degC (point 2) Table F.2:

$$H_2 := 3652.1 \cdot \frac{\text{kJ}}{\text{kg}}$$

$$S_2 := 7.1258 \cdot \frac{\text{kJ}}{\text{kg} \cdot \text{K}}$$

$$P_2 := 6500 \cdot \text{kPa}$$

At point 3 the pressure must be such that the steam has a condensation temperature in feedwater heater I of 195 degC, 5 deg higher than the temperature of the feed water to the boiler at point 1. Its saturation pressure, corresponding to 195 degC, from Table F.1, is 1399.0 kPa. The steam at point 3 is superheated vapor at this pressure, and if expansion from P2 to P3 is isentropic,

$$S'_3 := S_2$$

By double interpolation in Table F.2,

$$H'_3 := 3142.6 \cdot \frac{\text{kJ}}{\text{kg}}$$

$$\eta := 0.80$$

$$W_I := \eta \cdot (H'_3 - H_2)$$

$$H_3 := H_2 + W_I$$

$$H_3 = 3.244 \times 10^3 \frac{\text{kJ}}{\text{kg}}$$

$$W_I = -407.6 \frac{\text{kJ}}{\text{kg}}$$

From Table F.1:

$$H_{10} := 829.9 \cdot \frac{\text{kJ}}{\text{kg}}$$

Similar calculations are required for feedwater heater II.

At the exhaust conditions of 20 kPa, the properties of sat. liq. and sat. vap. are:

$$H_{\text{liq}} := 251.453 \cdot \frac{\text{kJ}}{\text{kg}} \quad H_{\text{vap}} := 2609.9 \cdot \frac{\text{kJ}}{\text{kg}} \quad V_{\text{liq}} := 1.017 \cdot \frac{\text{cm}^3}{\text{gm}}$$

$$S_{\text{liq}} := 0.8321 \cdot \frac{\text{kJ}}{\text{kg} \cdot \text{K}} \quad S_{\text{vap}} := 7.9094 \cdot \frac{\text{kJ}}{\text{kg} \cdot \text{K}}$$

If we find  $t_7$ , then  $t_8$  is the mid-temperature between  $t_7$  and  $t_1$  (190 degC), and that fixes the pressure of stream 4 so that its saturation temperature is 5 degC higher. At point 6, we have saturated liquid at 20 kPa, and its properties from Table F.2 are:

$$t_{\text{sat}} := 60.09 \quad T_{\text{sat}} := (t_{\text{sat}} + 273.15) \cdot \text{K}$$

$$H_6 := H_{\text{liq}} \quad V_6 := V_{\text{liq}} \quad P_6 := 20 \cdot \text{kPa}$$

$$W_{\text{pump}} := \frac{V_6 \cdot (P_2 - P_6)}{\eta} \quad [\text{Eq. (7.24)}]$$

$$W_{\text{pump}} = 8.238 \cdot \frac{\text{kJ}}{\text{kg}} \quad \Delta H_{67} := W_{\text{pump}}$$

We apply Eq. (7.25) for the calculation of the temperature change from point 6 to point 7. For this we need values of the heat capacity and volume expansivity of water at about 60 degC. They can be estimated from data in Table F.1:

$$\beta := \frac{1}{V_{\text{liq}}} \cdot \left( \frac{1.023 - 1.012}{20} \right) \cdot \frac{\text{cm}^3}{\text{gm} \cdot \text{K}} \quad C_P := \frac{272.0 - 230.2}{10} \cdot \frac{\text{kJ}}{\text{kg} \cdot \text{K}}$$

$$\beta = 5.408 \times 10^{-4} \frac{1}{\text{K}} \quad C_P = 4.18 \frac{\text{kJ}}{\text{kg} \cdot \text{K}}$$

Solving Eq. (7.25) for delta T gives:

$$\Delta T_{67} := \frac{\Delta H_{67} - V_{\text{liq}} \cdot (\beta - \beta \cdot T_{\text{sat}}) \cdot (P_2 - P_6)}{C_P} \quad \Delta T_{67} = 0.678 \text{ K}$$

$$t_7 := t_{\text{sat}} + \frac{\Delta T_{67}}{\text{K}} \quad t_9 := \frac{190 - t_7}{2} + t_7 \quad t_8 := t_9 + 5$$

$$t_7 = 60.768$$

$$t_8 = 130.38$$

From Table F.1:

$$H_8 := 547.9 \frac{\text{kJ}}{\text{kg}}$$

$$H_7 := H_{\text{liq}} + \Delta H_{67}$$

$$t_9 = 125.38$$

$$T_9 := (273.15 + t_9) \cdot \text{K}$$

$$H_7 = 259.691 \frac{\text{kJ}}{\text{kg}}$$

At points 9 and 1, the streams are compressed liquid ( $P=6500$  kPa), and we find the effect of pressure on the liquid by Eq. (7.25). Values by interpolation in Table F.1 at saturation temperatures  $t_9$  and  $t_1$ :

$$H_{\text{sat},9} := 526.6 \frac{\text{kJ}}{\text{kg}}$$

$$V_{\text{sat},9} := 1.065 \frac{\text{cm}^3}{\text{gm}}$$

$$P_{\text{sat},9} := 234.9 \cdot \text{kPa}$$

$$H_{\text{sat},1} := 807.5 \frac{\text{kJ}}{\text{kg}}$$

$$V_{\text{sat},1} := 1.142 \frac{\text{cm}^3}{\text{gm}}$$

$$P_{\text{sat},1} := 1255.1 \cdot \text{kPa}$$

$$\Delta V_9 := (1.075 - 1.056) \frac{\text{cm}^3}{\text{gm}}$$

$$\Delta V_1 := (1.156 - 1.128) \frac{\text{cm}^3}{\text{gm}}$$

$$\Delta T := 20 \cdot \text{K}$$

$$\beta_9 := \frac{1}{V_{\text{sat},9}} \cdot \frac{\Delta V_9}{\Delta T}$$

$$\beta_1 := \frac{1}{V_{\text{sat},1}} \cdot \frac{\Delta V_1}{\Delta T}$$

$$\beta_9 = 8.92 \times 10^{-4} \frac{1}{\text{K}}$$

$$\beta_1 = 1.226 \times 10^{-3} \frac{1}{\text{K}}$$

$$H_9 := H_{\text{sat},9} + V_{\text{sat},9} \cdot (P_2 - P_{\text{sat},9}) - \beta_9 \cdot T_9 \cdot (P_2 - P_{\text{sat},9})$$

$$H_9 = 530.9 \frac{\text{kJ}}{\text{kg}}$$

$$T_1 := (273.15 + 190) \cdot \text{K}$$

$$T_1 = 463.15 \text{ K}$$

$$H_1 := H_{\text{sat},1} + V_{\text{sat},1} \cdot (P_2 - P_{\text{sat},1}) - \beta_1 \cdot T_1 \cdot (P_2 - P_{\text{sat},1})$$

$$H_1 = 810.089 \frac{\text{kJ}}{\text{kg}}$$

Now we can make an energy balance on feedwater heater I to find the mass of steam condensed:

$$m_I := \frac{H_1 - H_9}{H_3 - H_{10}} \cdot \text{kg}$$

$$m_I = 0.11563 \text{ kg} \quad \text{Ans.}$$

The temperature at point 8,  $t_8 = 130.38$  (see above) is the saturation temperature in feedwater heater II. The saturation pressure by interpolation in Table F.1 is 273.28 kPa.

Isentropic expansion of steam from the initial conditions to this pressure results in a slightly superheated vapor, for which by double interpolation in Table F.2:

$$H'_4 := 2763.2 \cdot \frac{\text{kJ}}{\text{kg}}$$

Then  $H_4 := H_2 + \eta \cdot (H'_4 - H_2)$

$$H_4 = 2.941 \times 10^3 \frac{\text{kJ}}{\text{kg}}$$

We can now make an energy balance on feedwater heater II to find the mass of steam condensed:

$$m_{II} := \frac{(H_9 - H_7) \cdot 1 \cdot \text{kg} - m_I \cdot (H_{10} - H_8)}{H_4 - H_8} \quad m_{II} = 0.09971 \text{ kg} \quad \text{Ans.}$$

The final stage of expansion in the turbine is to 20 kPa, where the exhaust is wet. For isentropic expansion,

$$x'_5 := \frac{S_2 - S_{\text{liq}}}{S_{\text{vap}} - S_{\text{liq}}}$$

$$H'_5 := H_{\text{liq}} + x'_5 \cdot (H_{\text{vap}} - H_{\text{liq}})$$

$$x'_5 = 0.889$$

$$H'_5 = 2.349 \times 10^3 \frac{\text{kJ}}{\text{kg}}$$

Then  $H_5 := H_2 + \eta \cdot (H'_5 - H_2)$

$$H_5 = 2609.4 \frac{\text{kJ}}{\text{kg}}$$

The work of the turbine is:

$$W_{\text{turbine}} := W_I \cdot 1 \cdot \text{kg} + (1 \cdot \text{kg} - m_I) \cdot (H_4 - H_3) \dots \\ + (1 \cdot \text{kg} - m_I - m_{II}) \cdot (H_5 - H_4)$$

$$W_{\text{turbine}} = -936.2 \text{ kJ}$$

$$Q_H := (H_2 - H_1) \cdot 1 \cdot \text{kg}$$

$$Q_H = 2.842 \times 10^3 \text{ kJ}$$

$$\eta := \frac{|W_{\text{turbine}} + W_{\text{pump}} \cdot 1 \cdot \text{kg}|}{Q_H}$$

$$\eta = 0.3265 \quad \text{Ans.}$$

8.10 Isobutane:

$$T_c := 408.1 \cdot \text{K}$$

$$P_c := 36.48 \cdot \text{bar}$$

$$\omega := 0.181$$

For isentropic expansion in the turbine, let the initial state be represented by symbols with subscript zero and the final state by symbols with no subscript.

Then

$$T_0 := 533.15 \cdot \text{K}$$

$$P_0 := 4800 \cdot \text{kPa}$$

$$P := 450 \cdot \text{kPa}$$

$$\Delta S := 0 \cdot \frac{\text{J}}{\text{mol} \cdot \text{K}}$$

For the heat capacity of isobutane:

$$A := 1.677$$

$$B := \frac{37.853 \cdot 10^{-3}}{\text{K}}$$

$$C := \frac{-11.945 \cdot 10^{-6}}{\text{K}^2}$$

$$T_{r0} := \frac{T_0}{T_c}$$

$$T_{r0} = 1.3064$$

$$P_{r0} := \frac{P_0}{P_c}$$

$$P_{r0} = 1.3158$$

$$P_r := \frac{P}{P_c}$$

$$P_r = 0.123$$

Use generalized second-virial correlation:

The entropy change is given by Eq. (6.92) combined with Eq. (5.15) with  $D = 0$ :

$$\tau := 0.8 \quad (\text{guess})$$

Given

$$\Delta S = R \cdot \left[ A \cdot \ln(\tau) + \left[ B \cdot T_0 + C \cdot T_0^2 \cdot \left( \frac{\tau + 1}{2} \right) \right] \cdot (\tau - 1) - \ln \left( \frac{P}{P_0} \right) \dots \right] \\ + \text{SRB} \left( \frac{\tau \cdot T_0}{T_c}, \mathbf{B}_r, \right) - \text{SRB} (T_{r0}, \mathbf{B}_{r0}, )$$

$$\tau := \text{Find}(\tau)$$

$$\tau = 0.852$$

$$T := \tau \cdot T_0$$

$$T = 454.49 \text{ K}$$

$$T_r := \frac{T}{T_c}$$

$$T_r = 1.114$$

The enthalpy change for this final temperature is given by Eq. (6.91), with HRB at the above T:

$$\Delta H_{ig} := R \cdot \text{ICPH} (T_0, T, 1.677, 37.853 \cdot 10^{-3}, -11.945 \cdot 10^{-6}, 0.0)$$

$$\Delta H_{ig} = -1.141 \times 10^4 \frac{\text{J}}{\text{mol}}$$

$$\Delta H_{\text{turbine}} := \Delta H_{\text{ig}} + R \cdot T_c \cdot \left( \text{HRB}(T_r, \theta_r) - \text{HRB}(T_{r0}, \theta_{r0}) \right)$$

$$\Delta H_{\text{turbine}} = -8850.6 \frac{\text{J}}{\text{mol}}$$

$$W_{\text{turbine}} := \Delta H_{\text{turbine}}$$

The work of the pump is given by Eq. (7.24), and for this we need an estimate of the molar volume of isobutane as a saturated liquid at 450 kPa. This is given by Eq. (3.72). The saturation temperature at 450 kPa is given by the Antoine equation solved for  $t$  degC:

$$VP := 450 \cdot \text{kPa}$$

$$A_{vp} := 14.57100$$

$$B_{vp} := 2606.775$$

$$C_{vp} := 274.068$$

$$t_{\text{sat}} := \frac{B_{vp}}{A_{vp} - \ln\left(\frac{VP}{\text{kPa}}\right)} - C_{vp} \quad t_{\text{sat}} = 34$$

$$T_{\text{sat}} := (t_{\text{sat}} + 273.15) \cdot \text{K}$$

$$T_{\text{sat}} = 307.15 \text{ K}$$

$$V_c := 262.7 \cdot \frac{\text{cm}^3}{\text{mol}}$$

$$Z_c := 0.282$$

$$T_{\text{rsat}} := \frac{T_{\text{sat}}}{T_c}$$

$$T_{\text{rsat}} = 0.753$$

$$V_{\text{liq}} := V_c \cdot Z_c \left[ (1 - T_{\text{rsat}})^{\frac{2}{7}} \right]$$

$$V_{\text{liq}} = 112.362 \frac{\text{cm}^3}{\text{mol}}$$

$$W_{\text{pump}} := V_{\text{liq}} \cdot (P_0 - P)$$

$$W_{\text{pump}} = 488.8 \frac{\text{J}}{\text{mol}}$$

The flow rate of isobutane can now be found:

$$\dot{m} := \frac{1000 \cdot \text{kW}}{|W_{\text{turbine}} + W_{\text{pump}}|}$$

$$\dot{m} = 119.59 \frac{\text{mol}}{\text{sec}} \quad \text{Ans.}$$

The enthalpy change of the isobutane in the cooler/condenser is calculated in two steps:

a. Cooling of the vapor from 454.48 to 307.15 K

b. Condensation of the vapor at 307.15 K

Enthalpy change of cooling: HRB at the initial state has already been calculated.

For saturated vapor at 307.15 K:

$$\Delta H_{\text{ig}} := R \cdot \text{ICPH}(T, T_{\text{sat}}, 1.677, 37.853 \cdot 10^{-3}, -11.945 \cdot 10^{-6}, 0.0)$$

$$\Delta H_{ig} = -1.756 \times 10^4 \frac{\text{J}}{\text{mol}}$$

$$\Delta H_a := \Delta H_{ig} + R \cdot T_c \cdot \left( \text{HRB}(T_{rsat}, \theta_r) - \text{HRB}(T_r, \theta_r) \right)$$

$$\Delta H_a = -18082 \frac{\text{J}}{\text{mol}}$$

For the condensation process, we estimate the latent heat by Eqs. (4.12) and (4.13):

$$T_n := 261.4 \cdot \text{K}$$

$$T_m := \frac{T_n}{T_c}$$

$$T_m = 0.641$$

$$\Delta H_n := \frac{R \cdot T_n \cdot 1.092 \cdot \left( \ln \left( \frac{P_c}{\text{bar}} \right) - 1.013 \right)}{0.930 - T_m}$$

$$\Delta H_n = 2.118 \times 10^4 \frac{\text{J}}{\text{mol}}$$

$$\Delta H_b := -\Delta H_n \cdot \left( \frac{1 - T_{rsat}}{1 - T_m} \right)^{0.38}$$

$$\Delta H_b = -18378 \frac{\text{J}}{\text{mol}}$$

$$Q_{\dot{\text{out}}} := \dot{m} \cdot (\Delta H_a + \Delta H_b)$$

$$Q_{\dot{\text{in}}} := |W_{\text{turbine}} + W_{\text{pump}}| \cdot \dot{m} + |Q_{\dot{\text{out}}}| \quad \eta := \frac{1000 \cdot \text{kW}}{Q_{\dot{\text{in}}}}$$

$$Q_{\dot{\text{out}}} = -4360 \text{ kW}$$

$$Q_{\dot{\text{in}}} = 5360 \text{ kW}$$

$$\eta = 0.187$$

Ans.

8.11 Isobutane:  $T_c := 408.1 \cdot \text{K}$

$$P_c := 36.48 \cdot \text{bar}$$

$$\omega := 0.181$$

For isentropic expansion in the turbine, let the initial (inlet) state be represented by symbols with subscript zero and the final (exit) state by symbols with no subscript. Then

$$T_0 := 413.15 \cdot \text{K}$$

$$P_0 := 3400 \cdot \text{kPa}$$

$$P := 450 \cdot \text{kPa}$$

$$\text{molwt} := 58.123 \frac{\text{gm}}{\text{mol}}$$

$$\Delta S := 0 \cdot \frac{\text{J}}{\text{mol} \cdot \text{K}}$$

**For the heat capacity of isobutane:**

$$A := 1.677$$

$$B := \frac{37.853 \cdot 10^{-3}}{K}$$

$$C := \frac{-11.945 \cdot 10^{-6}}{K^2}$$

$$T_{r0} := \frac{T_0}{T_c}$$

$$T_{r0} = 1.0124$$

$$P_{r0} := \frac{P_0}{P_c}$$

$$P_{r0} = 0.932$$

$$P_r := \frac{P}{P_c}$$

$$P_r = 0.123$$

**Use Lee/Kesler correlation for turbine-inlet state, designating values by HRLK and SRLK:**

$$HRLK_0 := -1.530$$

$$SRLK_0 := -1.160$$

**The entropy change is given by Eq. (6.92) combined with Eq. (5.15) with D = 0:**

$$\tau := 0.8 \quad (\text{guess})$$

Given

$$\Delta S = R \cdot \left[ A \cdot \ln(\tau) + \left[ B \cdot T_0 + C \cdot T_0^2 \cdot \left( \frac{\tau + 1}{2} \right) \right] \cdot (\tau - 1) - \ln\left(\frac{P}{P_0}\right) \dots \right] \\ + \text{SRB}\left(\frac{T_0 \cdot \tau}{T_c}, \mathcal{B}_r, \right) - \text{SRLK}_0$$

$$\tau := \text{Find}(\tau)$$

$$\tau = 0.809$$

$$T := \tau \cdot T_0$$

$$T = 334.08 \text{ K}$$

$$T_r := \frac{T}{T_c}$$

$$T_r = 0.819$$

**The enthalpy change for this final temperature is given by Eq. (6.91), with HRB at the above T:**

$$\Delta H_{ig} := R \cdot \text{ICPH}\left(T_0, T, 1.677, 37.853 \cdot 10^{-3}, -11.945 \cdot 10^{-6}, 0.0\right)$$

$$\Delta H_{ig} = -9.3 \times 10^3 \frac{\text{J}}{\text{mol}}$$

$$\Delta H_{\text{turbine}} := \Delta H_{ig} + R \cdot T_c \cdot \left( \text{HRB}\left(T_r, \mathcal{B}_r, \right) - \text{HRLK}_0 \right)$$

$$\Delta H_{\text{turbine}} = -4852.6 \frac{\text{J}}{\text{mol}}$$

$$W_{\text{turbine}} := \Delta H_{\text{turbine}}$$



The work of the pump is given by Eq. (7.24), and the required value for the molar volume of saturated-liquid isobutane at 450 kPa (34 degC) is the value calculated in Problem 8.10:

$$V_{\text{liq}} := 112.36 \cdot \frac{\text{cm}^3}{\text{mol}} \quad W_{\text{pump}} := V_{\text{liq}} \cdot (P_0 - P) \quad W_{\text{pump}} = 331.462 \frac{\text{J}}{\text{mol}}$$

For the cycle the net power OUTPUT is:

$$\dot{m} := \frac{75}{\text{molwt}} \cdot \frac{\text{kg}}{\text{sec}} \quad \dot{W} := -\dot{m} \cdot (W_{\text{turbine}} + W_{\text{pump}})$$

$$\dot{W} = 5834 \text{ kW} \quad \text{Ans.}$$

The enthalpy change of the isobutane in the cooler/condenser is calculated in two steps:

- Cooling of the vapor from 334.07 to 307.15 K
- Condensation of the vapor at 307.15 K

Enthalpy change of cooling: HRB at the initial state has already been calculated. For saturated vapor at 307.15 K it was found in Problem 8.10 as:

$$T_{\text{sat}} := 307.15 \text{ K} \quad T_{\text{rsat}} := \frac{T_{\text{sat}}}{T_c} \quad T_{\text{rsat}} = 0.753$$

$$\Delta H_{\text{ig}} := R \cdot \text{ICPH}(T, T_{\text{sat}}, 1.677, 37.853 \cdot 10^{-3}, -11.945 \cdot 10^{-6}, 0.0)$$

$$\Delta H_{\text{ig}} = -2.817 \frac{\text{kJ}}{\text{mol}}$$

$$\Delta H_a := \Delta H_{\text{ig}} + R \cdot T_c \cdot (\text{HRB}(T_{\text{rsat}}, \theta_r) - \text{HRB}(T_r, \theta_r))$$

$$\Delta H_a = -2975 \frac{\text{J}}{\text{mol}}$$

For the condensation process, the enthalpy change was found in Problem 8.10:

$$\Delta H_b := -18378 \cdot \frac{\text{J}}{\text{mol}} \quad \dot{Q}_{\text{out}} := \dot{m} \cdot (\Delta H_a + \Delta H_b)$$

$$\dot{Q}_{\text{out}} = -27553 \text{ kW} \quad \text{Ans.}$$

**For the heater/boiler:**

$$\dot{Q}_{\text{in}} := \dot{W} + |\dot{Q}_{\text{out}}| \quad \dot{Q}_{\text{in}} = 33387 \text{ kW} \quad \text{Ans.}$$

$$\eta := \frac{\dot{W}}{\dot{Q}_{\text{in}}} \quad \eta = 0.175 \quad \text{Ans.}$$

**We now recalculate results for a cycle for which the turbine and pump each have an efficiency of 0.8. The work of the turbine is 80% of the value calculated above, i.e.,**

$$\dot{W}'_{\text{turbine}} := 0.8 \cdot \dot{W}_{\text{turbine}} \quad \dot{W}'_{\text{turbine}} = -3882 \frac{\text{J}}{\text{mol}}$$

**The work of the pump is:**

$$\dot{W}'_{\text{pump}} := \frac{\dot{W}_{\text{pump}}}{0.8} \quad \dot{W}'_{\text{pump}} = 414.3 \frac{\text{J}}{\text{mol}}$$

$$\dot{W} := -\dot{m} \cdot (\dot{W}'_{\text{turbine}} + \dot{W}'_{\text{pump}}) \quad \dot{W} = 4475 \text{ kW} \quad \text{Ans.}$$

**The decrease in the work output of the turbine shows up as an increase in the heat transferred out of the cooler condenser. Thus**

$$\dot{Q}_{\text{out}} := \dot{Q}_{\text{out}} + (\dot{W}_{\text{turbine}} - \dot{W}'_{\text{turbine}}) \cdot \dot{m}$$

$$\dot{Q}_{\text{out}} = -28805 \text{ kW} \quad \text{Ans.}$$

**The increase in pump work shows up as a decrease in the heat added in the heater/boiler. Thus**

$$\dot{Q}_{\text{in}} := \dot{Q}_{\text{in}} - (\dot{W}'_{\text{pump}} - \dot{W}_{\text{pump}}) \cdot \dot{m} \quad \dot{Q}_{\text{in}} = 33280 \text{ kW} \quad \text{Ans.}$$

$$\eta := \frac{\dot{W}}{\dot{Q}_{\text{in}}} \quad \eta = 0.134 \quad \text{Ans.}$$

8.13 Refer to Fig. 8.10.

$$C_P := \frac{7}{2} \cdot R$$

$$P_C := 1 \cdot \text{bar}$$

$$T_C := 293.15 \cdot \text{K}$$

$$P_D := 5 \cdot \text{bar}$$

$$\gamma := 1.4$$

By Eq. (3.30c):

$$P_C \cdot V_C^\gamma = P_D \cdot V_D^\gamma$$

$$\frac{V_C}{V_D} = \left( \frac{P_D}{P_C} \right)^{\frac{1}{\gamma}}$$

or 
$$r := \left( \frac{P_D}{P_C} \right)^{\frac{1}{\gamma}}$$

$$r = 3.157 \quad \text{Ans.}$$

Eq. (3.30b):

$$T_D := T_C \cdot \left( \frac{P_D}{P_C} \right)^{\frac{\gamma-1}{\gamma}}$$

$$Q_{DA} := 1500 \cdot \frac{\text{J}}{\text{mol}}$$

$$Q_{DA} = C_P \cdot (T_A - T_D)$$

$$T_A := \frac{Q_{DA}}{C_P} + T_D$$

$$T_A = 515.845 \text{ K}$$

$$r_e = \frac{V_B}{V_A} = \frac{V_C}{V_A} = \frac{\frac{R \cdot T_C}{P_C}}{\frac{R \cdot T_A}{P_A}}$$

$$P_A := P_D$$

$$r_e := \frac{T_C}{T_A} \cdot \frac{P_A}{P_C}$$

$$r_e = 2.841 \quad \text{Ans.}$$

8.14

$$\text{Ratio} := \begin{pmatrix} 3 \\ 5 \\ 7 \\ 9 \end{pmatrix}$$

$$\text{Ratio} = \frac{P_B}{P_A}$$

$$\gamma := 1.35$$

Eq. (8.12) now becomes:

$$\eta := \left[ 1 - \left( \frac{1}{\text{Ratio}} \right)^{\frac{\gamma-1}{\gamma}} \right]$$

$$\eta = \begin{pmatrix} 0.248 \\ 0.341 \\ 0.396 \\ 0.434 \end{pmatrix}$$

Ans.

8.16

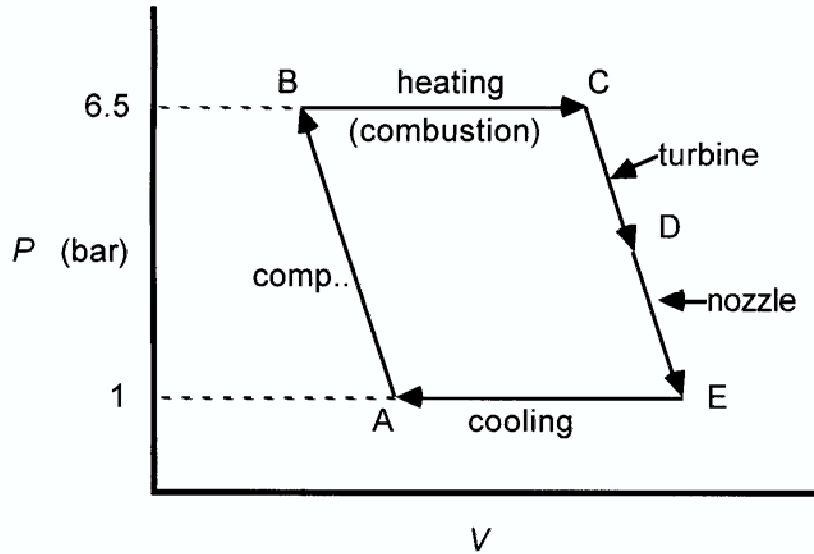

Figure shows the air-standard turbojet power plant on a PV diagram.

$$T_A := 303.15 \cdot \text{K}$$

$$T_C := 1373.15 \cdot \text{K}$$

$$C_P := \frac{7}{2} \cdot R$$

By Eq. (7.22)

$$W_{AB} = C_P \cdot T_A \cdot \left[ \left( \frac{P_B}{P_A} \right)^{\frac{R}{C_P}} - 1 \right] = C_P \cdot T_A \cdot \left( cr^{\frac{2}{7}} - 1 \right)$$

$$W_{CD} = C_P \cdot T_C \cdot \left[ \left( \frac{P_D}{P_C} \right)^{\frac{R}{C_P}} - 1 \right] = C_P \cdot T_C \cdot \left( er^{\frac{2}{7}} - 1 \right)$$

where  $cr$  is the compression ratio and  $er$  is the expansion ratio. Since the two work terms are equal but of opposite signs,

$$cr := 6.5 \qquad er := 0.5 \quad (\text{guess})$$

$$\text{Given} \quad T_C \cdot \left( er^{\frac{2}{7}} - 1 \right) = -T_A \cdot \left( cr^{\frac{2}{7}} - 1 \right)$$

$$er := \text{Find}(er)$$

$$er = 0.552$$

By Eq. (7.18): 
$$T_D = T_C \cdot \left( \frac{P_D}{P_C} \right)^{\frac{R}{C_P}}$$

This may be written: 
$$T_D := T_C \cdot \text{er}^{\frac{2}{7}}$$

By Eq. (7.11) 
$$u_E^2 - u_D^2 = \frac{2 \cdot \gamma \cdot P_D \cdot V_D}{\gamma - 1} \cdot \left[ 1 - \left( \frac{P_E}{P_D} \right)^{\frac{\gamma - 1}{\gamma}} \right] \quad (\text{A})$$

We note the following:

$$\text{er} = \frac{P_D}{P_C} \quad \text{cr} = \frac{P_B}{P_A} = \frac{P_C}{P_E} \quad \text{cr} \cdot \text{er} = \frac{P_D}{P_E}$$

The following substitutions are made in (A):

$$u_D = 0 \quad \frac{\gamma - 1}{\gamma} = \frac{R}{C_P} = \frac{2}{7} \quad P_D \cdot V_D = R \cdot T_D \quad \frac{P_E}{P_D} = \frac{1}{\text{cr} \cdot \text{er}}$$

Then

$$u_E := \sqrt{2 \cdot \frac{7}{2} \cdot \frac{R}{\text{molwt}} \cdot T_D \cdot \left[ 1 - \left( \frac{1}{\text{cr} \cdot \text{er}} \right)^{\frac{2}{7}} \right]}$$

$$\text{molwt} := 29 \frac{\text{gm}}{\text{mol}}$$

$$u_E = 843.4 \frac{\text{m}}{\text{sec}}$$

Ans.

$$P_E := 1 \cdot \text{bar}$$

$$P_D := \text{cr} \cdot \text{er} \cdot P_E$$

$$P_D = 3.589 \text{ bar}$$

Ans.

8.17  $T_A := 305 \cdot \text{K}$      $P_A := 1.05 \text{ bar}$      $P_B := 7.5 \text{ bar}$      $\eta := 0.8$

Assume air to be an ideal gas with mean heat capacity (final temperature by iteration):

$$C_{p\text{air}} := \text{MCPH}(298.15 \text{ K}, 582 \text{ K}, 3.355, 0.575 \cdot 10^{-3}, 0.0, -0.016 \cdot 10^5) \cdot R$$

$$C_{p\text{air}} = 29.921 \frac{\text{J}}{\text{mol} \cdot \text{K}}$$

**Compressor:**

$$W_{\text{Sair}} := \frac{C_{\text{pmair}} \cdot T_A}{\eta} \cdot \left[ \left( \frac{P_B}{P_A} \right)^{\frac{R}{C_{\text{pmair}}}} - 1 \right] \quad W_{\text{Sair}} = 8.292 \times 10^3 \frac{\text{J}}{\text{mol}}$$

$$T_B := T_A + \frac{W_{\text{Sair}}}{C_{\text{pmair}}} \quad T_B = 582.126 \text{ K}$$

**Combustion:**  $\text{CH}_4 + 2\text{O}_2 = \text{CO}_2 + 2\text{H}_2\text{O}$

**Basis:** Complete combustion of 1 mol CH<sub>4</sub>. Reactants are N mol of air and 1mol CH<sub>4</sub>.

Because the combustion is adiabatic, the basic equation is:

$$\Delta H_R + \Delta H_{298} + H_P = 0$$

For  $\Delta H_R$ , the mean heat capacities for air and methane are required. The value for air is given above. For methane the temperature change is very small; use the value given in Table C.1 for 298 K:  $4.217 \cdot R$ .

The solution process requires iteration for N. Assume a value for N until the above energy balance is satisfied.

(a)  $T_C := 1000\text{K}$      $N := 57.638$  (This is the final value after iteration)

$$\Delta H_R := C_{\text{pmair}} \cdot N \cdot (298.15 - 582.03) \cdot \text{K} + 4.217 \cdot R \cdot (298.15 - 300) \cdot \text{K}$$

$$\Delta H_R = -4.896 \times 10^5 \frac{\text{J}}{\text{mol}}$$

The product stream contains:

1 mol CO<sub>2</sub>, 2mol H<sub>2</sub>O, 0.79N mol N<sub>2</sub>, and (0.21N-2) mol O<sub>2</sub>

$$n := \begin{pmatrix} 1 \\ 2 \\ .79 \cdot N \\ .21 \cdot N - 2 \end{pmatrix}$$

$$A := \begin{pmatrix} 5.457 \\ 3.470 \\ 3.280 \\ 3.639 \end{pmatrix}$$

$$B := \begin{pmatrix} 1.045 \\ 1.450 \\ 0.593 \\ 0.506 \end{pmatrix} \cdot 10^{-3}$$

$$D := \begin{pmatrix} -1.157 \\ 0.121 \\ 0.040 \\ -0.227 \end{pmatrix} \cdot 10^5$$

i := 1..4

$$\sum_i n_i = 58.638 \quad A := \sum_i (n_i \cdot A_i) \quad B := \sum_i (n_i \cdot B_i) \quad D := \sum_i (n_i \cdot D_i)$$

$$A = 198.517$$

$$B = 0.036$$

$$D = -1.387 \times 10^5$$

$$C_{pmp} := \text{MCPH}(298.15\text{K}, 1000.\text{K}, 198.517, 0.0361, 0.0, -1.3872 \cdot 10^5) \cdot R$$

$$\Delta H_P := C_{pmp} \cdot (T_C - 298.15\text{K})$$

$$\Delta H_P = 1.292 \times 10^6 \frac{\text{J}}{\text{mol}}$$

From Ex. 4.7:

$$\Delta H_{298} := -802625 \frac{\text{J}}{\text{mol}}$$

$$\Delta H_R + \Delta H_{298} + \Delta H_P = 136.223 \frac{\text{J}}{\text{mol}} \quad (\text{This result is sufficiently close to zero.})$$

Thus,  $N = 57.638$  moles of air per mole of methane fuel. Ans.

Assume expansion of the combustion products in the turbine is to 1(atm), i.e., to 1.0133 bar:

$$P_D := 1.0133\text{bar}$$

$$P_C := 7.5\text{bar}$$

The pertinent equations are analogous to those for the compressor. The mean heat capacity is that of the combustion gases, and depends on the temperature of the exhaust gases from the turbine, which must therefore be found by iteration. For an initial calculation use the mean heat capacity already determined. This calculation yields an exhaust temperature of about 390 K. Thus iteration starts with this value. Parameters A, B, and D have the final values determined above.

$$C_{pm} := \text{MCPH}(1000\text{K}, 343.12\text{K}, 198.517, 0.0361, 0.0, -1.3872 \cdot 10^5) \cdot R$$

$$C_{pm} = 1.849 \times 10^3 \frac{\text{J}}{\text{mol} \cdot \text{K}} \quad \text{For } 58.638 \text{ moles of combustion product:}$$

$$W_s := \frac{58.638 \cdot C_{pm} \cdot T_C}{\eta} \cdot \left[ \left( \frac{P_D}{P_C} \right)^{\frac{R}{C_{pm}}} - 1 \right] \quad W_s = -1.214 \times 10^6 \frac{\text{J}}{\text{mol}}$$

$$T_D := T_C + \frac{W_s}{C_{pm}}$$

$$T_D = 343.123\text{K}$$

(Final result of iteration.) Ans.

$$W_{s_{\text{net}}} := W_s + W_{s_{\text{air}}} \cdot N \quad W_{s_{\text{net}}} = -7.364 \times 10^5 \frac{\text{J}}{\text{mol}} \quad \text{Ans.}$$

(J per mole of methane)

Parts (b) and (c) are solved in exactly the same way, with the following results:

$$(b) \quad T_C := 1200 \quad N := 37.48 \quad W_{s_{\text{net}}} := -7.365 \cdot 10^5 \quad T_D := 343.123$$

$$(c) \quad T_C := 1500 \quad N := 24.07 \quad W_{s_{\text{net}}} := -5.7519 \cdot 10^5 \quad T_D := 598.94$$

$$8.18 \quad \eta_{\text{tm}} := 0.35 \quad \eta_{\text{me}} := 0.95 \quad \text{line\_losses} := 20\% \quad \text{Cost\_fuel} := 4.00 \frac{\text{dollars}}{\text{GJ}}$$

$$\text{Cost\_electricity} := \frac{\text{Cost\_fuel}}{[\eta_{\text{tm}} \cdot \eta_{\text{me}} \cdot (1 - \text{line\_losses})]}$$

$$\text{Cost\_electricity} = 0.05 \frac{\text{cents}}{\text{kW} \cdot \text{hr}} \quad \text{Ans.}$$

This is about 1/2 to 1/3 of the typical cost charged to residential customers.

$$8.19 \quad T_C := 111.4\text{K} \quad T_H := 300\text{K} \quad \Delta H_{\text{n}_{\text{IV}}} := 8.206 \frac{\text{kJ}}{\text{mol}}$$

$$\eta_{\text{Carnot}} := 1 - \frac{T_C}{T_H} \quad \eta_{\text{Carnot}} = 0.629 \quad \eta_{\text{HE}} := 0.6 \cdot \eta_{\text{Carnot}} \quad \eta_{\text{HE}} = 0.377$$

Assume as a basis:  $W := 1\text{kJ}$

$$Q_H := \frac{W}{\eta_{\text{HE}}} \quad Q_H = 2.651 \text{kJ} \quad Q_C := Q_H \cdot (1 - \eta_{\text{HE}}) \quad Q_C = 1.651 \text{kJ}$$

$$\frac{Q_C}{\Delta H_{\text{n}_{\text{IV}}}} = 0.201 \frac{\text{mol}}{\text{kJ}} \quad \text{Ans.}$$



8.20  $T_H := (27 + 273.15)\text{K}$

$T_C := (6 + 273.15)\text{K}$

a)  $\eta_{\text{Carnot}} := 1 - \frac{T_C}{T_H}$

$\eta_{\text{Carnot}} = 0.07$

Ans.

b)  $\eta_{\text{actual}} := \eta_{\text{Carnot}} \cdot 0.6 \cdot \frac{2}{3}$

$\eta_{\text{actual}} = 0.028$

Ans.

c) **The thermal efficiency is low and high fluid rates are required to generate reasonable power. This argues for working fluids that are relatively inexpensive. Candidates that provide reasonable pressures at the required temperature levels include ammonia, n-butane, and propane.**

## Chapter 9 - Section A - Mathcad Solutions

9.2

$$T_H := (20 + 273.15)K \quad T_H = 293.15 K$$

$$T_C := (-20 + 273.15)K \quad T_C = 253.15 K$$

$$\dot{Q}_C := 125000 \cdot \frac{\text{kJ}}{\text{day}}$$

$$\omega_{\text{Carnot}} := \frac{T_C}{T_H - T_C} \quad (9.3) \quad \omega := 0.6 \cdot \omega_{\text{Carnot}} \quad \omega = 3.797$$

$$\dot{W} := \frac{\dot{Q}_C}{\omega} \quad (9.2) \quad \dot{W} = 0.381 \text{ kW}$$

$$\text{Cost} := \frac{0.08}{\text{kW} \cdot \text{hr}} \cdot \dot{W} \quad \text{Cost} = 267.183 \frac{\text{dollars}}{\text{yr}} \quad \text{Ans.}$$

9.4 **Basis: 1 lbm of tetrafluoroethane**

The following property values are found from Table 9.1:

State 1, Sat. Liquid at TH:  $H_1 := 44.943$      $S_1 := 0.09142$      $P_1 := 138.83$

State 2, Sat. Vapor at TH:  $H_2 := 116.166$      $S_2 := 0.21868$      $P_2 := 138.83$

State 3, Wet Vapor at TC:  $H_{\text{liq}} := 15.187$      $H_{\text{vap}} := 104.471$      $P_3 := 26.617$

State 4, Wet Vapor at TC:  $S_{\text{liq}} := 0.03408$      $S_{\text{vap}} := 0.22418$      $P_4 := 26.617$

(a) The pressures in (psia) appear above.

(b) Steps 3--2 and 1--4 (Fig. 8.2) are isentropic, for which  $S_3=S_2$  and  $S_1=S_4$ . Thus by Eq. 6.82):

$$x_3 := \frac{S_2 - S_{\text{liq}}}{S_{\text{vap}} - S_{\text{liq}}} \quad x_3 = 0.971 \quad x_4 := \frac{S_1 - S_{\text{liq}}}{S_{\text{vap}} - S_{\text{liq}}} \quad x_4 = 0.302$$

(c) **Heat addition, Step 4--3:**

$$H_3 := H_{\text{liq}} + x_3 \cdot (H_{\text{vap}} - H_{\text{liq}}) \quad H_4 := H_{\text{liq}} + x_4 \cdot (H_{\text{vap}} - H_{\text{liq}})$$

$$H_3 = 101.888$$

$$H_4 = 42.118$$

$$Q_{43} := (H_3 - H_4)$$

$$Q_{43} = 59.77 \quad (\text{Btu/lb}_m)$$

(d) Heat rejection, Step 2--1:

$$Q_{21} := (H_1 - H_2) \quad Q_{21} = -71.223 \quad (\text{Btu/lb}_m)$$

(e)  $W_{21} := 0$   $W_{43} := 0$

$$W_{32} := (H_2 - H_3) \quad W_{32} = 14.278$$

$$W_{14} := (H_4 - H_1) \quad W_{14} = -2.825$$

(f)  $\omega := \frac{Q_{43}}{W_{14} + W_{32}} \quad \omega = 5.219$

Note that the first law is satisfied:

$$\Sigma Q := Q_{21} + Q_{43} \quad \Sigma W := W_{32} + W_{14} \quad \Sigma Q + \Sigma W = 0$$

9.7  $T_C := 298.15 \cdot \text{K}$   $T_H := 523.15 \cdot \text{K}$  (Engine)

$T'_C := 273.15 \cdot \text{K}$   $T'_H := 298.15 \cdot \text{K}$  (Refrigerator)

By Eq. (5.8):  $\eta_{\text{Carnot}} := 1 - \frac{T_C}{T_H} \quad \eta_{\text{Carnot}} = 0.43$

By Eq. (9.3):  $\omega_{\text{Carnot}} := \frac{T'_C}{T'_H - T'_C} \quad \omega_{\text{Carnot}} = 10.926$

By definition:  $\eta = \frac{|W_{\text{engine}}|}{Q_H} \quad \omega = \frac{Q'_C}{W_{\text{refrig}}}$

But  $|W_{\text{engine}}| = W_{\text{refrig}} \quad Q'_C := 35 \cdot \frac{\text{kJ}}{\text{sec}}$

Whence  $Q_H := \frac{Q'_C}{\eta_{\text{Carnot}} \cdot \omega_{\text{Carnot}}} \quad Q_H = 7.448 \frac{\text{kJ}}{\text{sec}} \quad \text{Ans.}$

Given that:  $\eta := 0.6 \cdot \eta_{\text{Carnot}} \quad \omega := 0.6 \cdot \omega_{\text{Carnot}} \quad \omega = 6.556$

$Q_H := \frac{Q'_C}{\eta \omega} \quad Q_H = 20.689 \frac{\text{kJ}}{\text{sec}} \quad \text{Ans.}$

9.8 (a)  $Q_C := 4 \cdot \frac{\text{kJ}}{\text{sec}}$

$W := 1.5 \cdot \text{kW}$

$\omega := \frac{Q_C}{W}$

$\omega = 2.667$

Ans.

(b)  $Q_H := Q_C + W$

$Q_H = 5.5 \frac{\text{kJ}}{\text{sec}}$

Ans.

(c)  $\omega = \frac{T_C}{T_H - T_C}$

$T_H := (40 + 273.15) \cdot \text{K}$   $T_H = 313.15 \text{ K}$

$T_C := T_H \cdot \left( \frac{\omega}{\omega + 1} \right)$

$T_C = 227.75 \text{ K}$

Ans.

or  $-45.4 \text{ degC}$

9.9 The following vectors contain data for parts (a) through (e). Subscripts refer to Fig. 9.1. Values of H2 and S2 for saturated vapor come from Table 9.1.

$T_2 := \begin{pmatrix} 489.67 \\ 479.67 \\ 469.67 \\ 459.67 \\ 449.67 \end{pmatrix} \cdot \text{rankine}$

$\eta := \begin{pmatrix} 0.79 \\ 0.78 \\ 0.77 \\ 0.76 \\ 0.75 \end{pmatrix}$

$Q_{\dot{C}} := \begin{pmatrix} 600 \\ 500 \\ 400 \\ 300 \\ 200 \end{pmatrix} \cdot \frac{\text{Btu}}{\text{sec}}$

$H_2 := \begin{pmatrix} 107.320 \\ 105.907 \\ 104.471 \\ 103.015 \\ 101.542 \end{pmatrix} \cdot \frac{\text{Btu}}{\text{lb}_m}$

$S_2 := \begin{pmatrix} 0.22244 \\ 0.22325 \\ 0.22418 \\ 0.22525 \\ 0.22647 \end{pmatrix} \cdot \frac{\text{Btu}}{\text{lb}_m \cdot \text{rankine}}$

$T_4 := 539.67 \cdot \text{rankine}$

$H_4 := 37.978 \cdot \frac{\text{Btu}}{\text{lb}_m}$

From Table 9.1 for sat. liquid

$S'_3 = S_2$  (isentropic compression)

The saturation pressure at Point 4 from Table 9.1 is 101.37(psia). For isentropic compression, from Point 2 to Point 3', we must read values for the enthalpy at Point 3' from Fig. G.2 at this pressure and at the entropy values  $S_2$ . This cannot be done with much accuracy. The most satisfactory procedure is probably to read an enthalpy at  $S=0.22$  ( $H=114$ ) and at  $S=0.24$  ( $H=126$ ) and interpolate linearly for intermediate values of  $H$ . This leads to the following values (rounded to 1 decimal):

$$H'_3 := \begin{pmatrix} 115.5 \\ 116.0 \\ 116.5 \\ 117.2 \\ 117.9 \end{pmatrix} \cdot \frac{\text{Btu}}{\text{lb}_m}$$

$$H_1 = 88.337 \frac{\text{kJ}}{\text{kg}}$$

$$\Delta H_{23} := \frac{H'_3 - H_2}{\eta}$$

$$H_3 := H_2 + \Delta H_{23}$$

$$H_1 := H_4$$

$$\Delta H_{23} = \begin{pmatrix} 24.084 \\ 30.098 \\ 36.337 \\ 43.414 \\ 50.732 \end{pmatrix} \frac{\text{kJ}}{\text{kg}}$$

$$H_3 = \begin{pmatrix} 273.711 \\ 276.438 \\ 279.336 \\ 283.026 \\ 286.918 \end{pmatrix} \frac{\text{kJ}}{\text{kg}}$$

$$\dot{m} := \frac{\dot{Q}_{\text{dot}C}}{H_2 - H_1}$$

$$\dot{m} = \begin{pmatrix} 8.653 \\ 7.361 \\ 6.016 \\ 4.613 \\ 3.146 \end{pmatrix} \frac{\text{lb}_m}{\text{sec}}$$

Ans.

$$\dot{Q}_{\text{dot}H} := \left[ \dot{m} \cdot (H_4 - H_3) \right]$$

$$\dot{Q}_{\text{dot}H} = \begin{pmatrix} -689.6 \\ -595.2 \\ -494 \\ -386.1 \\ -268.6 \end{pmatrix} \frac{\text{Btu}}{\text{sec}}$$

Ans.

$$\dot{W}_{\text{dot}} := \left( \dot{m} \cdot \Delta H_{23} \right)$$

$$\dot{W}_{\text{dot}} = \begin{pmatrix} 94.5 \\ 100.5 \\ 99.2 \\ 90.8 \\ 72.4 \end{pmatrix} \text{kW}$$

Ans.

$$\omega := \frac{\overrightarrow{Qdot_C}}{Wdot}$$

$$\omega = \begin{pmatrix} 6.697 \\ 5.25 \\ 4.256 \\ 3.485 \\ 2.914 \end{pmatrix}$$

Ans.

$$T_C := T_2$$

$$T_H := T_4$$

$$\omega_{Carnot} := \frac{\overrightarrow{T_C}}{T_H - T_C}$$

$$\omega_{Carnot} = \begin{pmatrix} 9.793 \\ 7.995 \\ 6.71 \\ 5.746 \\ 4.996 \end{pmatrix}$$

Ans.

**9.10 Subscripts in the following refer to Fig. 9.1. All property values come from Tables F.1 and F.2.**

$$T_2 := (4 + 273.15) \cdot K$$

$$T_4 := (34 + 273.15) \cdot K$$

$$\eta := 0.76$$

$$Qdot_C := 1200 \cdot \frac{kJ}{sec}$$

$$H_2 := 2508.9 \cdot \frac{kJ}{kg}$$

$$S_2 := 9.0526 \cdot \frac{kJ}{kg \cdot K}$$

$$H_4 := 142.4 \cdot \frac{kJ}{kg}$$

$$S'_2 = S_2 \quad (\text{isentropic compression})$$

The saturation pressure at Point 4 from Table F.1 is 5.318 kPa. We must find in Table F.2 the enthalpy (Point 3') at this pressure and at the entropy  $S_2$ . This requires double interpolation. The pressure lies between entries for pressures of 1 and 10 kPa, and linear interpolation with P is unsatisfactory. Steam is here very nearly an ideal gas, for which the entropy is linear in the logarithm of P, and interpolation must be in accord with this relation. The enthalpy, on the other hand, changes very little with P and can be interpolated linearly. Linear interpolation with temperature is satisfactory in either case.

The result of interpolation is

$$H'_3 := 2814.7 \cdot \frac{kJ}{kg}$$

$$\Delta H_{23} := \frac{H'_3 - H_2}{\eta}$$

$$H_1 := H_4$$

$$\Delta H_{23} = 402.368 \frac{kJ}{kg}$$

$$H_3 := H_2 + \Delta H_{23} \quad H_3 = 2.911 \times 10^3 \frac{\text{kJ}}{\text{kg}}$$

$$\dot{m} := \frac{\dot{Q}_C}{H_2 - H_1} \quad \dot{m} = 0.507 \frac{\text{kg}}{\text{sec}} \quad \text{Ans.}$$

$$\dot{Q}_H := \dot{m} \cdot (H_4 - H_3) \quad \dot{Q}_H = -1404 \frac{\text{kJ}}{\text{sec}} \quad \text{Ans.}$$

$$\dot{W} := \dot{m} \cdot \Delta H_{23} \quad \dot{W} = 204 \text{ kW} \quad \text{Ans.}$$

$$\omega := \frac{\dot{Q}_C}{\dot{W}} \quad \omega = 5.881 \quad \text{Ans.}$$

$$\omega_{\text{Carnot}} := \frac{T_2}{T_4 - T_2} \quad \omega_{\text{Carnot}} = 9.238 \quad \text{Ans.}$$

9.11 Parts (a) & (b): subscripts refer to Fig. 9.1

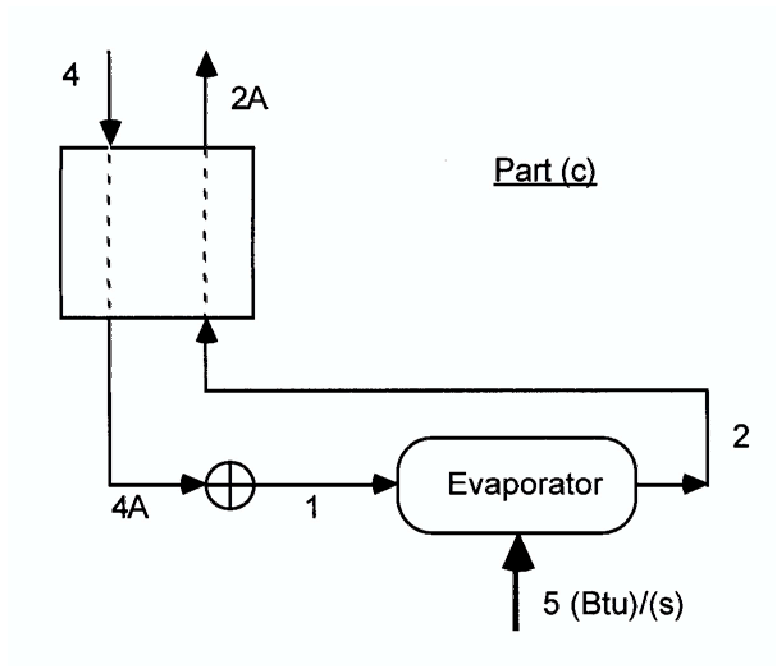

At the conditions of Point 2 [ $t = -15 \text{ degF}$  and  $P = 14.667 \text{ (psia)}$ ] for sat. liquid and sat. vapor from Table 9.1:

$$H_{\text{liq}} := 7.505 \cdot \frac{\text{Btu}}{\text{lb}_m}$$

$$H_{\text{vap}} := 100.799 \cdot \frac{\text{Btu}}{\text{lb}_m}$$

$$H_2 := H_{\text{vap}}$$

$$S_{\text{liq}} := 0.01733 \cdot \frac{\text{Btu}}{\text{lb}_m \cdot \text{rankine}}$$

$$S_{\text{vap}} := 0.22714 \cdot \frac{\text{Btu}}{\text{lb}_m \cdot \text{rankine}}$$

**For sat. liquid at Point 4 (80 degF):**

$$H_4 := 37.978 \cdot \frac{\text{Btu}}{\text{lb}_m}$$

$$S_4 := 0.07892 \cdot \frac{\text{Btu}}{\text{lb}_m \cdot \text{rankine}}$$

**(a) Isenthalpic expansion:**  $H_1 := H_4$

$$\dot{Q}_{\text{dotC}} := 5 \cdot \frac{\text{Btu}}{\text{sec}}$$

$$\dot{m} := \frac{\dot{Q}_{\text{dotC}}}{H_2 - H_1}$$

$$\dot{m} = 0.0796 \frac{\text{lb}_m}{\text{sec}}$$

**Ans.**

**(b) Isentropic expansion:**

$$S_1 := S_4$$

$$x_1 := \frac{S_1 - S_{\text{liq}}}{S_{\text{vap}} - S_{\text{liq}}}$$

$$H_1 := H_{\text{liq}} + x_1 \cdot (H_{\text{vap}} - H_{\text{liq}})$$

$$H_1 = 34.892 \frac{\text{BTU}}{\text{lb}_m}$$

$$\dot{m} := \frac{\dot{Q}_{\text{dotC}}}{H_2 - H_1}$$

$$\dot{m} = 0.0759 \frac{\text{lb}_m}{\text{sec}}$$

**Ans.**

**(c) The sat. vapor from the evaporator is superheated in the heat exchanger to 70 degF at a pressure of 14.667(psia). Property values for this state are read (with considerable uncertainty) from Fig. G.2:**

$$H_{2A} := 117.5 \cdot \frac{\text{Btu}}{\text{lb}_m}$$

$$S_{2A} := 0.262 \cdot \frac{\text{Btu}}{\text{lb}_m \cdot \text{rankine}}$$

$$\dot{m} := \frac{\dot{Q}_{\text{dotC}}}{H_{2A} - H_4}$$

$$\dot{m} = 0.0629 \frac{\text{lb}_m}{\text{sec}}$$

**Ans.**

**(d) For isentropic compression of the sat. vapor at Point 2,**

$$S_3 := S_{\text{vap}} \quad \text{and from Fig. G.2 at this entropy and } P=101.37(\text{psia})$$

$$H_3 := 118.3 \cdot \frac{\text{Btu}}{\text{lb}_m}$$

**Eq. (9.4) may now be applied to the two cases:**

**In the first case H1 has the value of H4:**

$$\omega_a := \frac{H_2 - H_4}{H_3 - H_2}$$

$$\omega_a = 3.5896$$

**Ans.**



In the second case H1 has its last calculated value [Part (b)]:

$$\omega_b := \frac{H_2 - H_1}{H_3 - H_2} \quad \omega_b = 3.7659 \quad \text{Ans.}$$

In Part (c), compression is at constant entropy of 0.262 to the final pressure. Again from Fig. G.2:

$$H_3 := 138 \cdot \frac{\text{Btu}}{\text{lb}_m} \quad \dot{W} := (H_3 - H_{2A}) \cdot \dot{m} \quad \text{(Last calculated value of } \dot{m} \text{)}$$

$$\dot{W} = 1.289 \frac{\text{BTU}}{\text{sec}}$$

$$\omega_c := \frac{|\dot{Q}_C|}{\dot{W}} \quad \omega_c = 3.8791 \quad \text{Ans.}$$

9.12 Subscripts: see figure of the preceding problem.

At the conditions of Point 2 [sat. vapor,  $t = 20 \text{ degF}$  and  $P = 33.110(\text{psia})$ ] from Table 9.1:

$$H_2 := 105.907 \cdot \frac{\text{Btu}}{\text{lb}_m}$$

$$S_2 := 0.22325 \cdot \frac{\text{Btu}}{\text{lb}_m \cdot \text{rankine}}$$

At Point 2A we have a superheated vapor at the same pressure and at 70 degF. From Fig. G.2:

$$H_{2A} := 116 \cdot \frac{\text{Btu}}{\text{lb}_m}$$

$$S_{2A} := 0.2435 \cdot \frac{\text{Btu}}{\text{lb}_m \cdot \text{rankine}}$$

For sat. liquid at Point 4 (80 degF):

$$H_4 := 37.978 \cdot \frac{\text{Btu}}{\text{lb}_m}$$

$$S_4 := 0.07892 \cdot \frac{\text{Btu}}{\text{lb}_m \cdot \text{R}}$$

Energy balance, heat exchanger:

$$H_1 := H_4 - H_{2A} + H_2 \quad H_1 = 27.885 \frac{\text{BTU}}{\text{lb}_m}$$

$$\dot{Q}_C := 2000 \cdot \frac{\text{Btu}}{\text{sec}}$$

$$\dot{m} := \frac{\dot{Q}_C}{H_2 - H_1}$$

$$\dot{m} = 25.634 \frac{\text{lb}_m}{\text{sec}}$$

For compression at constant entropy of 0.2435 to the final pressure of 101.37(psia), by Fig. G.2:

$$H'_3 := 127 \cdot \frac{\text{Btu}}{\text{lb}_m}$$

$$\eta := 0.75$$

$$\Delta H_{\text{comp}} := \frac{H'_3 - H_{2A}}{\eta}$$

$$\dot{W} := \dot{m} \cdot \Delta H_{\text{comp}}$$

$$\Delta H_{\text{comp}} = 14.667 \frac{\text{Btu}}{\text{lb}_m}$$

$$\dot{m} = 25.634 \frac{\text{lb}_m}{\text{sec}}$$

$$\dot{W} = 396.66 \text{ kW}$$

Ans.

If the heat exchanger is omitted, then H1 = H4.

Points 2A & 2 coincide, and compression is at a constant entropy of 0.22325 to P = 101.37(psia).

$$\dot{m} := \frac{\dot{Q}_{\text{dotC}}}{H_2 - H_4}$$

$$H'_3 := 116 \cdot \frac{\text{Btu}}{\text{lb}_m}$$

$$\Delta H_{\text{comp}} := \frac{H'_3 - H_2}{\eta}$$

$$\dot{W} := \dot{m} \cdot \Delta H_{\text{comp}}$$

$$\Delta H_{\text{comp}} = 13.457 \frac{\text{Btu}}{\text{lb}_m}$$

$$\dot{m} = 29.443 \frac{\text{lb}_m}{\text{sec}}$$

$$\dot{W} = 418.032 \text{ kW}$$

Ans.

### 9.13 Subscripts refer to Fig. 9.1.

At Point 2 [sat. vapor @ 10 degF] from Table 9.1:

$$H_2 := 104.471 \cdot \frac{\text{Btu}}{\text{lb}_m}$$

$$S_2 := 0.22418 \cdot \frac{\text{Btu}}{\text{lb}_m \cdot \text{R}}$$

$$S'_3 := S_2$$

H values for sat. liquid at Point 4 come from Table 9.1 and H values for Point 3' come from Fig. G.2. The vectors following give values for condensation temperatures of 60, 80, & 100 degF at pressures of 72.087, 101.37, & 138.83(psia) respectively.

$$H_4 := \begin{pmatrix} 31.239 \\ 37.978 \\ 44.943 \end{pmatrix} \cdot \frac{\text{Btu}}{\text{lb}_m}$$

$$H'_3 := \begin{pmatrix} 113.3 \\ 116.5 \\ 119.3 \end{pmatrix} \cdot \frac{\text{Btu}}{\text{lb}_m}$$

$$H_1 := H_4$$

(a) By Eq. (9.4):

$$\omega := \frac{H_2 - H_1}{H'_3 - H_2}$$

$$\omega = \begin{pmatrix} 8.294 \\ 5.528 \\ 4.014 \end{pmatrix}$$

Ans.

(b)  $\Delta H := \frac{H'_3 - H_2}{0.75}$

Since

$$\Delta H = H_3 - H_2$$

Eq. (9.4) now becomes

$$\omega := \frac{H_2 - H_1}{\Delta H}$$

$$\omega = \begin{pmatrix} 6.221 \\ 4.146 \\ 3.011 \end{pmatrix}$$

Ans.

### 9.14 WINTER

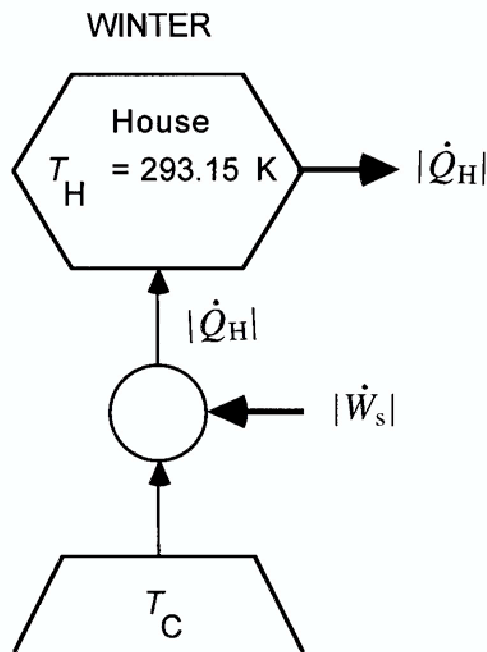

$$T_H := 293.15$$

$$\dot{W}_{dot} := 1.5$$

$$\dot{Q}_{dot_H} = -0.75 \cdot (T_H - T_C)$$

$$\frac{\dot{W}_{dot}}{|\dot{Q}_{dot_H}|} = \frac{T_H - T_C}{T_H}$$

$$T_C := 250 \quad (\text{Guess})$$

Given

$$\frac{\dot{W}_{dot}}{0.75 \cdot (T_H - T_C)} = \frac{T_H - T_C}{T_H}$$

$$T_C := \text{Find}(T_C)$$

$$T_C = 268.94 \text{ K} \quad \text{Ans.}$$

$$\text{Minimum } t = -4.21 \text{ degC}$$

SUMMER

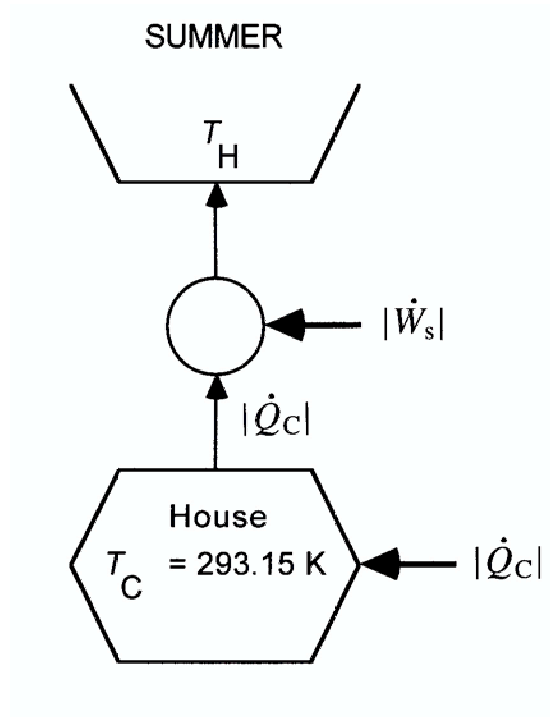

$$T_C := 298.15$$

$$Q_{\dot{C}} := 0.75 \cdot (T_H - T_C)$$

$$\frac{W_{\dot{C}}}{Q_{\dot{C}}} = \frac{T_H - T_C}{T_C}$$

$$T_H := 300 \quad (\text{Guess})$$

Given

$$\frac{W_{\dot{C}}}{0.75 \cdot (T_H - T_C)} = \frac{T_H - T_C}{T_C}$$

$$T_H := \text{Find}(T_H)$$

$$T_H = 322.57 \text{ K} \quad \text{Ans.}$$

$$\text{Maximum } t = 49.42 \text{ degC}$$

9.15 and 9.16 Data in the following vectors for Pbs. 9.15 and 9.16 come from Perry's Handbook, 7th ed.

$$H_4 := \begin{pmatrix} 1033.5 \\ 785.3 \end{pmatrix} \cdot \frac{\text{kJ}}{\text{kg}}$$

$$H_9 := 284.7 \cdot \frac{\text{kJ}}{\text{kg}}$$

$$H_{15} := \begin{pmatrix} 1186.7 \\ 1056.4 \end{pmatrix} \cdot \frac{\text{kJ}}{\text{kg}}$$

By Eq. (9.8):

$$z := \frac{\overrightarrow{H_4 - H_{15}}}{H_9 - H_{15}}$$

$$z = \begin{pmatrix} 0.17 \\ 0.351 \end{pmatrix} \quad \text{Ans.}$$

9.17 Advertized combination unit:

$$T_H := (150 + 459.67) \cdot \text{rankine}$$

$$T_C := (30 + 459.67) \cdot \text{rankine}$$

$$T_H = 609.67 \text{ rankine}$$

$$T_C = 489.67 \text{ rankine}$$

$$Q_C := 50000 \cdot \frac{\text{Btu}}{\text{hr}}$$

$$W_{\text{Carnot}} := Q_C \cdot \frac{T_H - T_C}{T_C}$$

$$W_{\text{Carnot}} = 12253 \frac{\text{Btu}}{\text{hr}}$$

$$W_I := 1.5 \cdot W_{\text{Carnot}} \quad W_I = 18380 \frac{\text{Btu}}{\text{hr}}$$

This is the TOTAL power requirement for the advertized combination unit. The amount of heat rejected at the higher temperature of 150 degF is

$$Q_H := W_I + Q_C \quad Q_H = 68380 \frac{\text{Btu}}{\text{hr}}$$

For the conventional water heater, this amount of energy must be supplied by resistance heating, which requires power in this amount. For the conventional cooling unit,

$$T_H := (120 + 459.67) \cdot \text{rankine}$$

$$W_{\text{Carnot}} := Q_C \cdot \frac{T_H - T_C}{T_C} \quad W_{\text{Carnot}} = 9190 \frac{\text{Btu}}{\text{hr}}$$

$$\text{Work} := 1.5 \cdot W_{\text{Carnot}} \quad \text{Work} = 13785 \frac{\text{Btu}}{\text{hr}}$$

The total power required is

$$W_{\text{II}} := Q_H + \text{Work} \quad W_{\text{II}} = 82165 \frac{\text{Btu}}{\text{hr}} \quad \text{NO CONTEST}$$

9.18  $T_C := 210$        $T_H := 260$        $T_C := 255$        $T_H := 305$

By Eq. (9.3):

$$\omega := \frac{T_C}{T_H - T_C} \quad \omega_I := 0.65 \cdot \frac{T_C}{T_H - T_C} \quad \omega_{\text{II}} := 0.65 \cdot \frac{T_C}{T_H - T_C}$$

$$W_{\text{Carnot}} = \frac{Q_C}{\omega} \quad W_I = \frac{Q_C}{\omega_I} \quad W_{\text{II}} = \frac{Q_C}{\omega_{\text{II}}}$$

Define r as the ratio of the actual work,  $W_I + W_{\text{II}}$ , to the Carnot work:

$$r := \omega \cdot \left( \frac{1}{\omega_I} + \frac{1}{\omega_{\text{II}}} \right) \quad r = 1.477 \quad \text{Ans.}$$

9.19 This problem is just a reworking of Example 9.3 with different values of x. It could be useful as a group project.

9.22  $T_H := 290\text{K}$        $T_C := 250\text{K}$        $W_s := 0.40\text{kW}$

$$\omega_{\text{Carnot}} := \frac{T_C}{T_H - T_C} \quad \omega_{\text{Carnot}} = 6.25 \quad \omega := 65\% \omega_{\text{Carnot}} \quad \omega = 4.063$$

**Ans.**

$$Q_C := W_s \cdot \omega \quad Q_C = 1.625 \times 10^3 \text{ kgm}^2 \text{ s} \quad Q_H := W_s + |Q_C| \quad Q_H = 2.025 \text{ kW}$$

9.23 Follow the notation from Fig. 9.1

With air at 20 C and the specification of a minimum approach  $\Delta T = 10 \text{ C}$ :

$$T_1 := (10 + 273.15)\text{K} \quad T_4 := (30 + 273.15)\text{K} \quad T_2 := T_1$$

Calculate the high and low operating pressures using the given vapor pressure equation

**Guess:**       $P_L := 1\text{bar}$        $P_H := 2\text{bar}$

$$\text{Given } \ln\left(\frac{P_L}{\text{bar}}\right) = 45.327 - \frac{4104.67}{\frac{T_1}{\text{K}}} - 5.146 \cdot \ln\left(\frac{T_1}{\text{K}}\right) + 615.0 \frac{\frac{P_L}{\text{bar}}}{\left(\frac{T_1}{\text{K}}\right)^2}$$

$$P_L := \text{Find}(P_L) \quad P_L = 6.196 \text{ bar}$$

$$\text{Given } \ln\left(\frac{P_H}{\text{bar}}\right) = 45.327 - \frac{4104.67}{\frac{T_4}{\text{K}}} - 5.146 \cdot \ln\left(\frac{T_4}{\text{K}}\right) + 615.0 \frac{\frac{P_H}{\text{bar}}}{\left(\frac{T_4}{\text{K}}\right)^2}$$

$$P_H := \text{Find}(P_H) \quad P_H = 11.703 \text{ bar}$$

Calculate the heat load

$$\dot{n}_{\text{toluene}} := 50 \frac{\text{kmol}}{\text{hr}} \quad T_1 := (100 + 273.15)\text{K} \quad T_2 := (20 + 273.15)\text{K}$$

Using values from Table C.3

$$Q_{\text{dot}C} := -\dot{n}_{\text{toluene}} \cdot R \cdot \text{ICPH}(T_1, T_2, 15.133, 6.79 \cdot 10^{-3}, 16.35 \cdot 10^{-6}, 0)$$

$$Q_{\text{dot}C} = 177.536 \text{ kW}$$

Since the throttling process is adiabatic:  $H_4 = H_1$

But:  $H_{liq4} = H_{liq1} + x_1 \cdot \Delta H_{lv1}$  so:  $H_{liq4} - H_{liq1} = x_1 \cdot \Delta H_{lv}$

and:  $H_{liq4} - H_{liq1} = V_{liq} \cdot (P_4 - P_1) + \int_{T_1}^{T_4} C_{pliq}(T) dT$

Estimate  $V_{liq}$  using the Rackett Eqn.

$$\omega := 0.253$$

$$T_c := 405.7K$$

$$P_c := 112.80bar$$

$$Z_c := 0.242$$

$$V_c := 72.5 \frac{cm^3}{mol}$$

$$T_n := 239.7K$$

$$\Delta H_{lvn} := 23.34 \frac{kJ}{mol}$$

$$T_r := \frac{(20 + 273.15)K}{T_c}$$

$$T_r = 0.723$$

$$V_{liq} := V_c \cdot Z_c \cdot \left(1 - T_r\right)^{\frac{2}{7}}$$

$$V_{liq} = 27.112 \frac{cm^3}{mol}$$

Estimate  $\Delta H_{lv}$  at 10C using Watson correlation

$$T_{rm} := \frac{T_n}{T_c}$$

$$T_{rm} = 0.591$$

$$T_{r1} := \frac{T_1}{T_c}$$

$$T_{r1} = 0.698$$

$$\Delta H_{lv} := \Delta H_{lvn} \cdot \left(\frac{1 - T_{r1}}{1 - T_{rm}}\right)^{0.38}$$

$$\Delta H_{lv} = 20.798 \frac{kJ}{mol}$$

$$\Delta H_{liq41} := V_{liq} \cdot (P_H - P_L) + R \cdot ICPH(T_1, T_4, 22.626, -100.75 \cdot 10^{-3}, 192.71 \cdot 10^{-6}, 0)$$

$$\Delta H_{liq41} = 1.621 \frac{kJ}{mol}$$

$$x_1 := \frac{\Delta H_{liq41}}{\Delta H_{lv}}$$

$$x_1 = 0.078$$

For the evaporator

$$\Delta H_{12} = H_2 - H_1 = H_{1vap} - (H_{1liq} + x_1 \cdot \Delta H_{lv}) = (1 - x_1) \cdot \Delta H_{lv}$$

$$\Delta H_{12} := (1 - x_1) \cdot \Delta H_{lv}$$

$$\Delta H_{12} = 19.177 \frac{kJ}{mol}$$

$$\dot{n} := \frac{Q_{dot}}{\Delta H_{12}}$$

$$\dot{n} = 9.258 \frac{mol}{sec}$$

Ans.

## Chapter 10 - Section A - Mathcad Solutions

10.1    **Benzene:**     $A_1 := 13.7819$      $B_1 := 2726.81$      $C_1 := 217.572$   
          **Toluene:**     $A_2 := 13.9320$      $B_2 := 3056.96$      $C_2 := 217.625$

$$P_{\text{sat}_1}(T) := e^{\frac{A_1 - \frac{B_1}{T}}{\text{degC}} + C_1} \cdot \text{kPa} \qquad P_{\text{sat}_2}(T) := e^{\frac{A_2 - \frac{B_2}{T}}{\text{degC}} + C_2} \cdot \text{kPa}$$

(a) **Given:**  $x_1 := 0.33$      $T := 100 \cdot \text{degC}$     **Guess:**  $y_1 := 0.5$      $P := 100 \cdot \text{kPa}$

Given     $x_1 \cdot P_{\text{sat}_1}(T) + (1 - x_1) \cdot P_{\text{sat}_2}(T) = P$

$$x_1 \cdot P_{\text{sat}_1}(T) = y_1 \cdot P$$

$$\begin{pmatrix} y_1 \\ P \end{pmatrix} := \text{Find}(y_1, P) \qquad y_1 = 0.545 \quad \text{Ans.} \qquad P = 109.303 \text{ kPa} \quad \text{Ans.}$$

(b) **Given:**  $y_1 := 0.33$      $T := 100 \cdot \text{degC}$     **Guess:**  $x_1 := 0.33$      $P := 100 \cdot \text{kPa}$

Given     $x_1 \cdot P_{\text{sat}_1}(T) + (1 - x_1) \cdot P_{\text{sat}_2}(T) = P$

$$x_1 \cdot P_{\text{sat}_1}(T) = y_1 \cdot P$$

$$\begin{pmatrix} x_1 \\ P \end{pmatrix} := \text{Find}(x_1, P) \qquad x_1 = 0.169 \quad \text{Ans.} \qquad P = 92.156 \text{ kPa} \quad \text{Ans.}$$

(c) **Given:**  $x_1 := 0.33$      $P := 120 \cdot \text{kPa}$     **Guess:**  $y_1 := 0.5$      $T := 100 \cdot \text{degC}$

Given     $x_1 \cdot P_{\text{sat}_1}(T) + (1 - x_1) \cdot P_{\text{sat}_2}(T) = P$

$$x_1 \cdot P_{\text{sat}_1}(T) = y_1 \cdot P$$

$$\begin{pmatrix} y_1 \\ T \end{pmatrix} := \text{Find}(y_1, T) \qquad y_1 = 0.542 \quad \text{Ans.} \qquad T = 103.307 \text{ degC} \quad \text{Ans.}$$



(d) Given:  $y_1 := 0.33$   $P := 120 \cdot \text{kPa}$  Guess:  $x_1 := 0.33$   $T := 100 \cdot \text{degC}$

$$\text{Given } x_1 \cdot \text{Psat}_1(T) + (1 - x_1) \cdot \text{Psat}_2(T) = P$$

$$x_1 \cdot \text{Psat}_1(T) = y_1 \cdot P$$

$$\begin{pmatrix} x_1 \\ T \end{pmatrix} := \text{Find}(x_1, T) \quad x_1 = 0.173 \quad \text{Ans.} \quad T = 109.131 \text{ degC} \quad \text{Ans.}$$

(e) Given:  $T := 105 \cdot \text{degC}$   $P := 120 \cdot \text{kPa}$  Guess:  $x_1 := 0.33$   $y_1 := 0.5$

$$\text{Given } x_1 \cdot \text{Psat}_1(T) + (1 - x_1) \cdot \text{Psat}_2(T) = P$$

$$x_1 \cdot \text{Psat}_1(T) = y_1 \cdot P$$

$$\begin{pmatrix} x_1 \\ y_1 \end{pmatrix} := \text{Find}(x_1, y_1) \quad x_1 = 0.282 \quad \text{Ans.} \quad y_1 = 0.484 \quad \text{Ans.}$$

(f)  $z_1 := 0.33$   $x_1 = 0.282$   $y_1 = 0.484$

Guess:  $L := 0.5$   $V := 0.5$

$$\text{Given } z_1 = L \cdot x_1 + V \cdot y_1$$

$$L + V = 1$$

$$\begin{pmatrix} L \\ V \end{pmatrix} := \text{Find}(L, V) \quad \text{Vapor Fraction: } V = 0.238 \quad \text{Ans.}$$
$$\text{Liquid Fraction: } L = 0.762 \quad \text{Ans.}$$

(g) Benzene and toluene are both non-polar and similar in shape and size. Therefore one would expect little chemical interaction between the components. The temperature is high enough and pressure low enough to expect ideal behavior.

## 10.2 Pressures in kPa; temperatures in degC

(a) Antoine coefficients: Benzene=1; Ethylbenzene=2

$$A_1 := 13.7819$$

$$B_1 := 2726.81$$

$$C_1 := 217.572$$

$$A_2 := 13.9726$$

$$B_2 := 3259.93$$

$$C_2 := 212.300$$

$$P_{\text{sat}1}(T) := \exp\left(A_1 - \frac{B_1}{T + C_1}\right)$$

$$P_{\text{sat}2}(T) := \exp\left(A_2 - \frac{B_2}{T + C_2}\right)$$

P-x-y diagram:  $T := 90$

$$P(x_1) := x_1 \cdot P_{\text{sat}1}(T) + (1 - x_1) \cdot P_{\text{sat}2}(T) \quad y_1(x_1) := \frac{x_1 \cdot P_{\text{sat}1}(T)}{P(x_1)}$$

T-x-y diagram:  $P' := 90$

Guess t for root function:  $t := 90$

$$T(x_1) := \text{root}\left[x_1 \cdot P_{\text{sat}1}(t) + (1 - x_1) \cdot P_{\text{sat}2}(t) - P', t\right]$$

$$y'_1(x_1) := \frac{x_1 \cdot P_{\text{sat}1}(T(x_1))}{x_1 \cdot P_{\text{sat}1}(T(x_1)) + (1 - x_1) \cdot P_{\text{sat}2}(T(x_1))}$$

$$x_1 := 0, 0.05 \dots 1.0$$

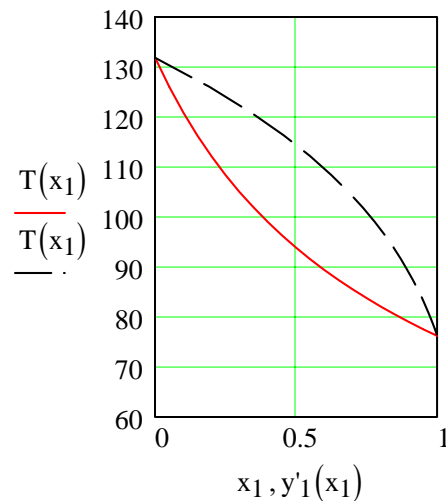
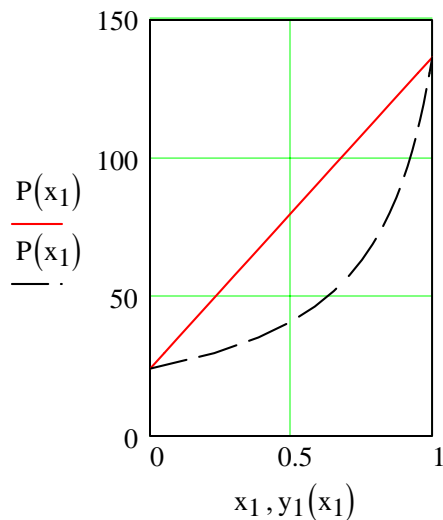

(b) Antoine coefficients: 1-Chlorobutane=1; Chlorobenzene=2

$$A_1 := 13.7965$$

$$B_1 := 2723.73$$

$$C_1 := 218.265$$

$$A_2 := 13.8635$$

$$B_2 := 3174.78$$

$$C_2 := 211.700$$

$$P_{\text{sat}1}(T) := \exp\left(A_1 - \frac{B_1}{T + C_1}\right)$$

$$P_{\text{sat}2}(T) := \exp\left(A_2 - \frac{B_2}{T + C_2}\right)$$

P-x-y diagram:  $T := 90$

$$P(x_1) := x_1 \cdot P_{\text{sat}1}(T) + (1 - x_1) \cdot P_{\text{sat}2}(T) \quad y_1(x_1) := \frac{x_1 \cdot P_{\text{sat}1}(T)}{P(x_1)}$$

T-x-y diagram:  $P' := 90$

Guess t for root function:  $t := 90$

$$T(x_1) := \text{root}\left[x_1 \cdot P_{\text{sat}1}(t) + (1 - x_1) \cdot P_{\text{sat}2}(t) - P', t\right]$$

$$y'_1(x_1) := \frac{x_1 \cdot P_{\text{sat}1}(T(x_1))}{x_1 \cdot P_{\text{sat}1}(T(x_1)) + (1 - x_1) \cdot P_{\text{sat}2}(T(x_1))}$$

$$x_1 := 0, 0.05 \dots 1.0$$

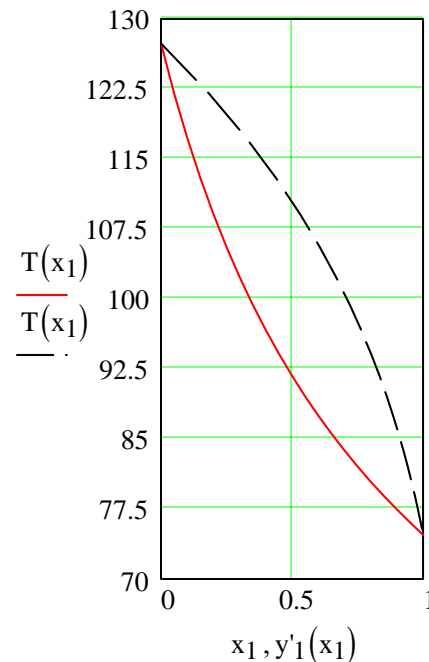
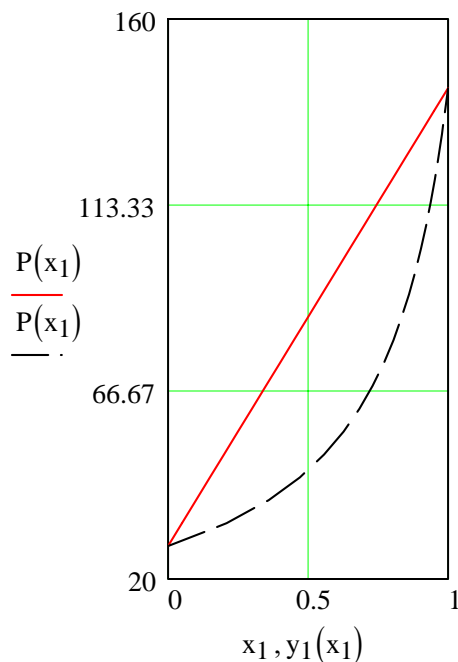

### 10.3 Pressures in kPa; temperatures in degC

(a) Antoine coefficients: n-Pentane=1; n-Heptane=2

$$A_1 := 13.7667 \quad B_1 := 2451.88 \quad C_1 := 232.014$$

$$A_2 := 13.8622 \quad B_2 := 2911.26 \quad C_2 := 216.432$$

$$P_{\text{sat}_1}(T) := \exp\left(A_1 - \frac{B_1}{T + C_1}\right) \quad P_{\text{sat}_2}(T) := \exp\left(A_2 - \frac{B_2}{T + C_2}\right)$$

$$T := 55 \quad P := \left(\frac{P_{\text{sat}_1}(T) + P_{\text{sat}_2}(T)}{2}\right) \quad P = 104.349$$

Since for Raoult's law P is linear in x, at the specified P, x1 must be 0.5:

$$x_1 := 0.5 \quad y_1 := \frac{x_1 \cdot P_{\text{sat}_1}(T)}{P} \quad y_1 = 0.89$$

For a given pressure, z1 ranges from the liquid composition at the bubble point to the vapor composition at the dew point. Material balance:

$$z_1 = x_1 \cdot (1 - V) + y_1 \cdot V$$

$$z_1 := x_1, x_1 + 0.01 \dots y_1 \quad V(z_1) := \frac{z_1 - x_1}{y_1 - x_1}$$

V is obviously linear in z1:

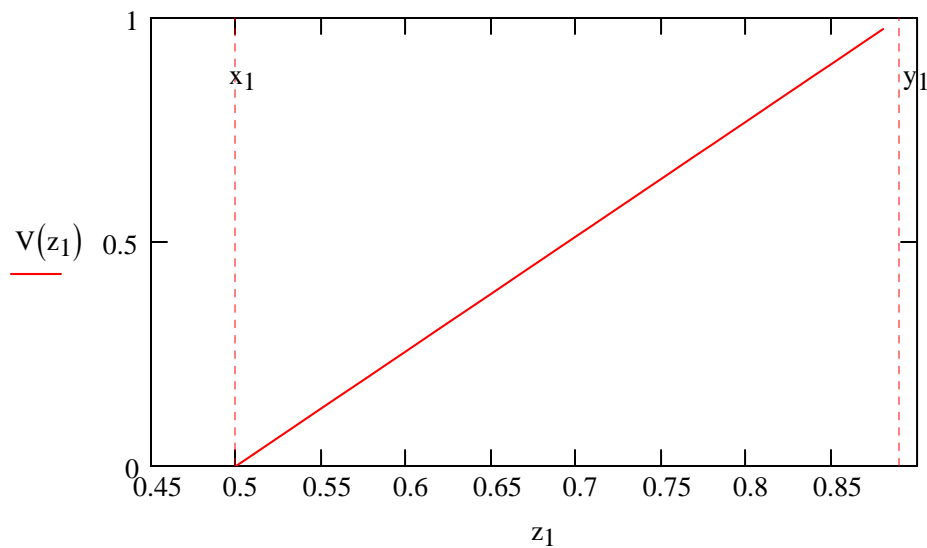

(b) At fixed T and z1, calculate x1, y1 and P as functions of fraction vapor (V).

$$z_1 := 0.5$$

$$\text{Guess: } x := 0.5 \quad y := 0.5 \quad p := \left( \frac{P_{\text{sat}1}(T) + P_{\text{sat}2}(T)}{2} \right)$$

Given Three equations relate x1, y1, & P for given V:

$$p = x \cdot P_{\text{sat}1}(T) + (1 - x) \cdot P_{\text{sat}2}(T)$$

$$y \cdot p = x \cdot P_{\text{sat}1}(T)$$

$$z_1 = (1 - V) \cdot x + V \cdot y$$

$$f(V) := \text{Find}(x, y, p)$$

$$x_1(V) := f(V)_1$$

$$y_1(V) := f(V)_2$$

$$P(V) := f(V)_3$$

Plot P, x1 and y1 vs. vapor fraction (V)

$$V := 0, 0.1 \dots 1.0$$

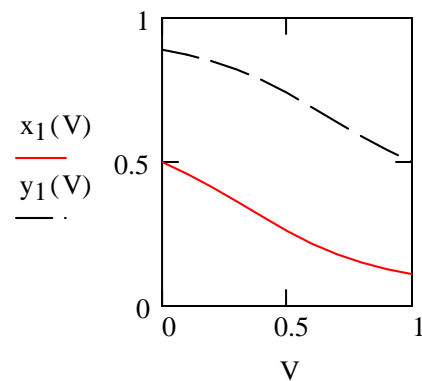
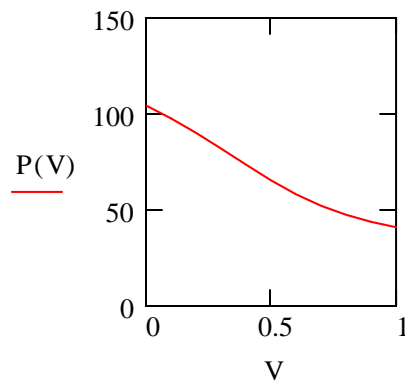

10.4 Each part of this problem is exactly like Problem 10.3, and is worked in exactly the same way. All that is involved is a change of numbers. In fact, the Mathcad solution for Problem 10.3 can be converted into the solution for any part of this problem simply by changing one number, the temperature.

10.7 Benzene:  $A_1 := 13.7819$   $B_1 := 2726.81$   $C_1 := 217.572$   
 Ethylbenzene  $A_2 := 13.9726$   $B_2 := 3259.93$   $C_2 := 212.300$

$$P_{\text{sat}1}(T) := e^{A_1 - \frac{B_1}{T}} \cdot \text{degC}^{C_1} \cdot \text{kPa} \quad P_{\text{sat}2}(T) := e^{A_2 - \frac{B_2}{T}} \cdot \text{degC}^{C_2} \cdot \text{kPa}$$

(a) Given:  $x_1 := 0.35$   $y_1 := 0.70$  Guess:  $T := 116 \cdot \text{degC}$   $P := 132 \cdot \text{kPa}$

$$\text{Given } x_1 \cdot \text{Psat}_1(T) + (1 - x_1) \cdot \text{Psat}_2(T) = P$$

$$x_1 \cdot \text{Psat}_1(T) = y_1 \cdot P$$

$$\begin{pmatrix} T \\ P \end{pmatrix} := \text{Find}(T, P) \quad T = 134.1 \text{ degC} \quad \text{Ans.} \quad P = 207.46 \text{ kPa} \quad \text{Ans.}$$

For parts (b), (c) and (d) use the same structure. Set the defined variables and change the variables in the Find statement at the end of the solve block.

(b)  $T = 111.88 \cdot \text{deg}_C$   $P = 118.72 \cdot \text{kPa}$

(c)  $T = 91.44 \cdot \text{deg}_C$   $P = 66.38 \cdot \text{kPa}$

(d)  $T = 72.43 \cdot \text{deg}_C$   $P = 36.02 \cdot \text{kPa}$

To calculate the relative amounts of liquid and vapor phases, one must know the composition of the feed.

10.8 To increase the relative amount of benzene in the vapor phase, the temperature and pressure of the process must be lowered. For parts (c) and (d), the process must be operated under vacuum conditions. The temperatures are well within the bounds of typical steam and cooling water temperatures.

10.9

(1) = benzene	A :=	$\begin{pmatrix} 13.7819 \\ 13.9320 \\ 13.9726 \end{pmatrix}$	B :=	$\begin{pmatrix} 2726.81 \\ 3056.96 \\ 3259.93 \end{pmatrix}$	C :=	$\begin{pmatrix} 217.572 \\ 217.625 \\ 212.300 \end{pmatrix}$
(2) = toluene						
(3) = ethylbenzene						

(a)  $n := \text{rows}(A)$   $i := 1..n$   $T := 110 \cdot \text{degC}$   $P := 90 \cdot \text{kPa}$   $z_i := \frac{1}{n}$

$$\text{Psat}(i, T) := e^{A_i \frac{B_i}{T} + C_i} \cdot \text{kPa} \quad k_i := \frac{\text{Psat}(i, T)}{P} \quad \text{Guess: } V := 0.5$$

$$\text{Given } \sum_{i=1}^n \frac{z_i \cdot k_i}{1 + V \cdot (k_i - 1)} = 1 \quad \text{Eq. (10.17)}$$

$$V := \text{Find}(V) \quad V = 0.836 \quad \text{Ans.}$$

$$y_i := \frac{z_i \cdot k_i}{1 + V \cdot (k_i - 1)} \quad \text{Eq. (10.16)}$$

$$y = \begin{pmatrix} 0.371 \\ 0.339 \\ 0.29 \end{pmatrix} \quad \text{Ans.}$$

$$x_i := \frac{y_i \cdot P}{P_{\text{sat}}(i, T)}$$

$$x = \begin{pmatrix} 0.142 \\ 0.306 \\ 0.552 \end{pmatrix} \quad \text{Ans.}$$

$$\text{(b) } T = 110 \cdot \text{deg\_C}$$

$$V = 0.575$$

$$x = \begin{pmatrix} 0.188 \\ 0.334 \\ 0.478 \end{pmatrix}$$

$$y = \begin{pmatrix} 0.441 \\ 0.333 \\ 0.226 \end{pmatrix}$$

$$P = 100 \cdot \text{kPa}$$

$$\text{(c) } T = 110 \cdot \text{deg\_C}$$

$$V = 0.352$$

$$x = \begin{pmatrix} 0.238 \\ 0.345 \\ 0.417 \end{pmatrix}$$

$$y = \begin{pmatrix} 0.508 \\ 0.312 \\ 0.18 \end{pmatrix}$$

$$P = 110 \cdot \text{kPa}$$

$$\text{(d) } T = 110 \cdot \text{deg\_C}$$

$$V = 0.146$$

$$x = \begin{pmatrix} 0.293 \\ 0.342 \\ 0.366 \end{pmatrix}$$

$$y = \begin{pmatrix} 0.572 \\ 0.284 \\ 0.144 \end{pmatrix}$$

$$P = 120 \cdot \text{kPa}$$

**10.10** As the pressure increases, the fraction of vapor phase formed (V) decreases, the mole fraction of benzene in both phases increases and the the mole fraction of ethylbenzene in both phases decreases.

10.11 (a) (1) = acetone  
 (2) = acetonitrile

$$A := \begin{pmatrix} 14.3145 \\ 14.8950 \end{pmatrix} \quad B := \begin{pmatrix} 2756.22 \\ 3413.10 \end{pmatrix} \quad C := \begin{pmatrix} 228.060 \\ 250.523 \end{pmatrix}$$

$$n := \text{rows}(A) \quad i := 1..n$$

$$z_1 := 0.75 \quad T := (340 - 273.15) \cdot \text{degC} \quad P := 115 \cdot \text{kPa}$$

$$z_2 := 1 - z_1$$

$$\text{Psat}(i, T) := e^{A_i \cdot \frac{B_i}{T} - \frac{C_i}{\text{degC}}} \cdot \text{kPa} \quad k_i := \frac{\text{Psat}(i, T)}{P}$$

**Guess:**  $V := 0.5$

Given 
$$\sum_{i=1}^n \frac{z_i \cdot k_i}{1 + V \cdot (k_i - 1)} = 1 \quad \text{Eq. (10.17)}$$

$V := \text{Find}(V)$   $V = 0.656$  **Ans.**

**Eq. (10.16)** 
$$y_i := \frac{z_i \cdot k_i}{1 + V \cdot (k_i - 1)} \quad y_1 = 0.805 \quad \text{Ans.}$$

$$x_i := \frac{y_i \cdot P}{\text{Psat}(i, T)} \quad x_1 = 0.644 \quad \text{Ans.}$$

$$r := \frac{y_1 \cdot V}{z_1} \quad r = 0.705 \quad \text{Ans.}$$

(b)  $x_1 = 0.285 \quad y_1 = 0.678 \quad V = 0.547 \quad r = 0.741$

(c)  $x_1 = 0.183 \quad y_1 = 0.320 \quad V = 0.487 \quad r = 0.624$

(d)  $x_1 = 0.340 \quad y_1 = 0.682 \quad V = 0.469 \quad r = 0.639$



10.13  $H_1 := 200 \cdot \text{bar}$        $Psat_2 := 0.10 \cdot \text{bar}$        $P := 1 \cdot \text{bar}$

Assume at 1 bar that the vapor is an ideal gas. The vapor-phase fugacities are then equal to the partial pressures. Assume the Lewis/Randall rule applies to concentrated species 2 and that Henry's law applies to dilute species 1. Then:

$$y_1 \cdot P = H_1 \cdot x_1 \qquad y_2 \cdot P = x_2 \cdot Psat_2 \qquad P = y_1 \cdot P + y_2 \cdot P$$

$$x_1 + x_2 = 1 \qquad P = H_1 \cdot x_1 + (1 - x_1) \cdot Psat_2$$

Solve for  $x_1$  and  $y_1$ :

$$x_1 := \frac{P - Psat_2}{H_1 - Psat_2} \qquad y_1 := \frac{H_1 \cdot x_1}{P}$$

$$x_1 = 4.502 \times 10^{-3}$$

$$y_1 = 0.9 \qquad \text{Ans.}$$

10.16 Pressures in kPa

$Psat_1 := 32.27$        $Psat_2 := 73.14$        $A := 0.67$        $z_1 := 0.65$

$$\gamma_1(x_1, x_2) := \exp(A \cdot x_2^2) \qquad \gamma_2(x_1, x_2) := \exp(A \cdot x_1^2)$$

$$P(x_1, x_2) := x_1 \cdot \gamma_1(x_1, x_2) \cdot Psat_1 + x_2 \cdot \gamma_2(x_1, x_2) \cdot Psat_2$$

(a) **BUBL P calculation:**       $x_1 := z_1$        $x_2 := 1 - x_1$

$$P_{\text{bubl}} := P(x_1, x_2) \qquad P_{\text{bubl}} = 56.745 \qquad \text{Ans.}$$

**DEW P calculation:**       $y_1 := z_1$        $y_2 := 1 - y_1$

**Guess:**       $x_1 := 0.5$        $P' := \frac{Psat_1 + Psat_2}{2}$

Given       $y_1 \cdot P' = x_1 \cdot \gamma_1(x_1, 1 - x_1) \cdot Psat_1$

$$P' = x_1 \cdot \gamma_1(x_1, 1 - x_1) \cdot Psat_1 \dots \\ + (1 - x_1) \cdot \gamma_2(x_1, 1 - x_1) \cdot Psat_2$$

$$\begin{pmatrix} x_1 \\ P_{\text{dew}} \end{pmatrix} := \text{Find}(x_1, P') \qquad P_{\text{dew}} = 43.864 \qquad \text{Ans.}$$

The pressure range for two phases is from the dewpoint to the bubblepoint: From 43.864 to 56.745 kPa

(b) BUBL P calculation:  $x_1 := 0.75$   $x_2 := 1 - x_1$

$$y_1(x_1) := \frac{x_1 \cdot \gamma_1(x_1, 1 - x_1) \cdot P_{\text{sat}1}}{P(x_1, 1 - x_1)}$$

The fraction vapor, by material balance is:

$$V := \frac{z_1 - x_1}{y_1(x_1) - x_1} \quad V = 0.379 \quad P(x_1, x_2) = 51.892 \quad \text{Ans.}$$

(c) See Example 10.3(e).

$$\alpha_{12.0} := \frac{\gamma_1(0, 1) \cdot P_{\text{sat}1}}{P_{\text{sat}2}} \quad \alpha_{12.1} := \frac{P_{\text{sat}1}}{\gamma_2(1, 0) \cdot P_{\text{sat}2}}$$

$$\alpha_{12.0} = 0.862$$

$$\alpha_{12.1} = 0.226$$

Since alpha does not pass through 1.0 for  $0 < x_1 < 1$ , there is no azeotrope.

10.17  $P_{\text{sat}1} := 79.8$   $P_{\text{sat}2} := 40.5$   $A := 0.95$

$$\gamma_1(x_1, x_2) := \exp(A \cdot x_2^2) \quad \gamma_2(x_1, x_2) := \exp(A \cdot x_1^2)$$

$$P(x_1, x_2) := x_1 \cdot \gamma_1(x_1, x_2) \cdot P_{\text{sat}1} + x_2 \cdot \gamma_2(x_1, x_2) \cdot P_{\text{sat}2}$$

$$y_1(x_1) := \frac{x_1 \cdot \gamma_1(x_1, 1 - x_1) \cdot P_{\text{sat}1}}{P(x_1, 1 - x_1)}$$

(a) BUBL P calculation:  $x_1 := 0.05$   $x_2 := 1 - x_1$

$$P_{\text{bubl}} := P(x_1, x_2) \quad P_{\text{bubl}} = 47.971 \quad \text{Ans.}$$

$$y_1(x_1) = 0.196$$

(b) DEW P calculation:  $y_1 := 0.05$   $y_2 := 1 - y_1$

$$\text{Guess:} \quad x_1 := 0.1 \quad P' := \frac{P_{\text{sat}1} + P_{\text{sat}2}}{2}$$

Given

$$y_1 \cdot P' = x_1 \cdot \gamma_1(x_1, 1 - x_1) \cdot P_{sat1}$$

$$P' = x_1 \cdot \gamma_1(x_1, 1 - x_1) \cdot P_{sat1} \dots$$

$$+ (1 - x_1) \cdot \gamma_2(x_1, 1 - x_1) \cdot P_{sat2}$$

$$\begin{pmatrix} x_1 \\ P_{dew} \end{pmatrix} := \text{Find}(x_1, P')$$

$P_{dew} = 42.191$

$x_1 = 0.0104$

**Ans.**

**(c) Azeotrope Calculation:**

**Guess:**  $x_1 := 0.8$      $y_1 := x_1$      $P := \frac{P_{sat1} + P_{sat2}}{2}$

Given

$$y_1 = \frac{x_1 \cdot \gamma_1(x_1, 1 - x_1) \cdot P_{sat1}}{P}$$

$x_1 \geq 0$      $x_1 \leq 1$      $x_1 = y_1$

$$P = x_1 \cdot \gamma_1(x_1, 1 - x_1) \cdot P_{sat1} + (1 - x_1) \cdot \gamma_2(x_1, 1 - x_1) \cdot P_{sat2}$$

$$\begin{pmatrix} x_{az1} \\ y_{az1} \\ P_{az} \end{pmatrix} := \text{Find}(x_1, y_1, P)$$

$$\begin{pmatrix} x_{az1} \\ y_{az1} \\ P_{az} \end{pmatrix} = \begin{pmatrix} 0.857 \\ 0.857 \\ 81.366 \end{pmatrix}$$

**Ans.**

**10.18**  $P_{sat1} := 75.20 \cdot \text{kPa}$

$P_{sat2} := 31.66 \cdot \text{kPa}$

**At the azeotrope:**  $y_1 = x_1$     **and**     $\gamma_i = \frac{P}{P_{sat_i}}$

**Therefore**  $\frac{\gamma_2}{\gamma_1} = \frac{P_{sat1}}{P_{sat2}}$      $x_1 := 0.294$      $x_2 := 1 - x_1$

$$\ln \gamma_1 = A \cdot x_2^2$$

$$\ln \gamma_2 = A \cdot x_1^2$$

$$\ln \left( \frac{\gamma_2}{\gamma_1} \right) = A \cdot (x_1^2 - x_2^2)$$

**Whence**  $A := \frac{\ln \left( \frac{P_{sat1}}{P_{sat2}} \right)}{x_2^2 - x_1^2}$      $A = 2.0998$

**For**  $x_1 := 0.6$      $x_2 := 1 - x_1$

$$\gamma_1 := \exp(A \cdot x_2^2) \quad \gamma_2 := \exp(A \cdot x_1^2) \quad P := x_1 \cdot \gamma_1 \cdot P_{\text{sat}1} + x_2 \cdot \gamma_2 \cdot P_{\text{sat}2}$$

$$y_1 := \frac{x_1 \cdot \gamma_1 \cdot P_{\text{sat}1}}{P} \quad P = 90.104 \text{ kPa} \quad y_1 = 0.701 \quad \text{Ans.}$$

10.19 Pressures in bars:

$$P_{\text{sat}1} := 1.24$$

$$P_{\text{sat}2} := 0.89$$

$$A := 1.8$$

$$x_1 := 0.65$$

$$x_2 := 1 - x_1$$

$$\gamma_1 := \exp(A \cdot x_2^2)$$

$$\gamma_2 := \exp(A \cdot x_1^2)$$

$$P := x_1 \cdot \gamma_1 \cdot P_{\text{sat}1} + x_2 \cdot \gamma_2 \cdot P_{\text{sat}2}$$

$$y_1 := \frac{x_1 \cdot \gamma_1 \cdot P_{\text{sat}1}}{P}$$

$$y_1 = 0.6013$$

$$P = 1.671$$

Answer to Part (b)

By a material balance,

$$V = \frac{z_1 - x_1}{y_1 - x_1} \quad \text{For } 0 \leq V \leq 1 \quad 0.6013 \leq z_1 \leq 0.65 \quad \text{Ans. (a)}$$

(c) Azeotrope calculation:

$$\text{Guess: } x_1 := 0.6 \quad y_1 := x_1 \quad P := \frac{P_{\text{sat}1} + P_{\text{sat}2}}{2}$$

$$\gamma_1(x_1) := \exp[A \cdot (1 - x_1)^2]$$

$$\gamma_2(x_1) := \exp(A \cdot x_1^2)$$

$$\text{Given } P = x_1 \cdot \gamma_1(x_1) \cdot P_{\text{sat}1} + (1 - x_1) \cdot \gamma_2(x_1) \cdot P_{\text{sat}2}$$

$$y_1 = \frac{x_1 \cdot \gamma_1(x_1) \cdot P_{\text{sat}1}}{P} \quad x_1 \geq 0 \quad x_1 \leq 1 \quad x_1 = y_1$$

$$\begin{pmatrix} x_1 \\ y_1 \\ P \end{pmatrix} := \text{Find}(x_1, y_1, P)$$

$$\begin{pmatrix} x_1 \\ y_1 \\ P \end{pmatrix} = \begin{pmatrix} 0.592 \\ 0.592 \\ 1.673 \end{pmatrix} \quad \text{Ans.}$$

**10.20 Antoine coefficients:**

**P in kPa; T in degC**

**Acetone(1):**  $A_1 := 14.3145$        $B_1 := 2756.22$        $C_1 := 228.060$

**Methanol(2):**  $A_2 := 16.5785$        $B_2 := 3638.27$        $C_2 := 239.500$

$$P_{1sat}(T) := \exp\left(A_1 - \frac{B_1}{T + C_1}\right) \qquad P_{2sat}(T) := \exp\left(A_2 - \frac{B_2}{T + C_2}\right)$$

$A := 0.64$        $x_1 := 0.175$        $z_1 := 0.25$        $p := 100$  (kPa)

$$\gamma_1(x_1, x_2) := \exp(A \cdot x_2^2) \qquad \gamma_2(x_1, x_2) := \exp(A \cdot x_1^2)$$

$$P(x_1, T) := x_1 \cdot \gamma_1(x_1, 1 - x_1) \cdot P_{1sat}(T) \dots \\ + (1 - x_1) \cdot \gamma_2(x_1, 1 - x_1) \cdot P_{2sat}(T)$$

$$y_1(x_1, T) := \frac{x_1 \cdot \gamma_1(x_1, 1 - x_1) \cdot P_{1sat}(T)}{P(x_1, T)} \qquad F := 1$$

**Guesses:**       $V := 0.5$        $L := 0.5$        $T := 100$

Given

$$F = L + V \qquad z_1 \cdot F = x_1 \cdot L + y_1(x_1, T) \cdot V \qquad p = P(x_1, T)$$

$$\begin{pmatrix} L \\ V \\ T \end{pmatrix} := \text{Find}(L, V, T) \qquad \begin{pmatrix} L \\ V \\ T \end{pmatrix} = \begin{pmatrix} 0.431 \\ 0.569 \\ 59.531 \end{pmatrix}$$

$T = 59.531$  (degC)

$y_1(x_1, T) = 0.307$  **Ans.**

10.22

$$x_1 := 0.002$$

$$y_1 := 0.95$$

**Guess:**  $T := 300 \cdot \text{K}$

$$A_1 := 10.08$$

$$B_1 := 2572.0$$

$$A_2 := 11.63$$

$$B_2 := 6254.0$$

$$P_{\text{sat}1}(T) := e^{A_1 - \frac{B_1}{\left(\frac{T}{\text{K}}\right)}} \cdot \text{bar}$$

$$P_{\text{sat}2}(T) := e^{A_2 - \frac{B_2}{\left(\frac{T}{\text{K}}\right)}} \cdot \text{bar}$$

$$x_2 := 1 - x_1 \quad y_2 := 1 - y_1$$

$$\gamma_1 := e^{0.93 \cdot x_2^2} \quad \gamma_2 := e^{0.93 \cdot x_1^2}$$

Given  $\frac{P_{\text{sat}1}(T)}{P_{\text{sat}2}(T)} = \frac{x_2 \cdot \gamma_2 \cdot y_1}{x_1 \cdot \gamma_1 \cdot y_2}$

$T := \text{Find}(T)$   $T = 376.453 \text{ K}$  **Ans.**

$$P := \frac{x_1 \cdot \gamma_1 \cdot P_{\text{sat}1}(T)}{y_1}$$

$P = 0.137 \text{ bar}$  **Ans.**

Problems 10.25 to 10.34 have been solved using MS-EXCEL 2000

We give the resulting spreadsheets.

**Problem 10.25**

a) BUBL P      T=-60 F (-51.11 C)

Component	xi	P=200 psia		P=250 psia		P=215 psia (14.824 bar)		ANSWER
		Ki	yi=Ki*xi	Ki	yi=Ki*xi	Ki	yi=Ki*xi	
methane	0.100	5.600	0.560	4.600	0.460	5.150	0.515	
ethylene	0.500	0.700	0.350	0.575	0.288	0.650	0.325	
ethane	0.400	0.445	0.178	0.380	0.152	0.420	0.168	
		<b>SUM =</b>	<b>1.088</b>	<b>SUM =</b>	<b>0.900</b>	<b>SUM =</b>	<b>1.008</b>	close enough

b) DEW P      T=-60 F (-51.11 C)

Component	yi	P=190 psia		P=200 psia (13.79 bar)		ANSWER
		Ki	xi=yi/Ki	Ki	xi=yi/Ki	
methane	0.500	5.900	0.085	5.600	0.089	
ethylene	0.250	0.730	0.342	0.700	0.357	
ethane	0.250	0.460	0.543	0.445	0.562	
		<b>SUM =</b>	<b>0.971</b>	<b>SUM =</b>	<b>1.008</b>	close enough

c) BUBL T      P=250 psia (17.24 bar)

Component	xi	T=-50 F		T=-60 F		T=-57 F (-49.44 C)		ANSWER
		Ki	yi=Ki*xi	Ki	yi=Ki*xi	Ki	yi=Ki*xi	
methane	0.120	4.900	0.588	4.600	0.552	4.700	0.564	
ethylene	0.400	0.680	0.272	0.570	0.228	0.615	0.246	
ethane	0.480	0.450	0.216	0.380	0.182	0.405	0.194	
		<b>SUM =</b>	<b>1.076</b>	<b>SUM =</b>	<b>0.962</b>	<b>SUM =</b>	<b>1.004</b>	close enough

d) DEW T      P=250 psia (17.24 bar)

Component	yi	T=-40 F		T = -50 F		T = -45 F (-27.33 C)		ANSWER
		Ki	xi=yi/Ki	Ki	xi=yi/Ki	Ki	xi=yi/Ki	
methane	0.430	5.200	0.083	4.900	0.088	5.050	0.085	
ethylene	0.360	0.800	0.450	0.680	0.529	0.740	0.486	
ethane	0.210	0.520	0.404	0.450	0.467	0.485	0.433	
		<b>SUM =</b>	<b>0.937</b>	<b>SUM =</b>	<b>1.084</b>	<b>SUM =</b>	<b>1.005</b>	close enough

**Problem 10.26**

**a) BUBL P T=60 C (140 F)**

Component	xi	P=200 psia		P=50 psia		P=80 psia (5.516 bar)		ANSWER
		Ki	yi=Ki*xi	Ki	yi=Ki*xi	Ki	yi=Ki*xi	
ethane	0.10	2.015	0.202	6.800	0.680	4.950	0.495	
propane	0.20	0.620	0.124	2.050	0.410	1.475	0.295	
isobutane	0.30	0.255	0.077	0.780	0.234	0.560	0.168	
isopentane	0.40	0.071	0.028	0.205	0.082	0.12	0.048	
		<b>SUM =</b>	<b>0.430</b>	<b>SUM =</b>	<b>1.406</b>	<b>SUM =</b>	<b>1.006</b>	close enough

**b) DEW P T=60 C (140 F)**

Component	yi	P=80 psia		P=50 psia		P=52 psia (3.585 bar)		ANSWER
		Ki	xi=yi/Ki	Ki	xi=yi/Ki	Ki	xi=yi/Ki	
ethane	0.48	4.950	0.097	6.800	0.071	6.600	0.073	
propane	0.25	1.475	0.169	2.050	0.122	2.000	0.125	
isobutane	0.15	0.560	0.268	0.780	0.192	0.760	0.197	
isopentane	0.12	0.12	1.000	0.205	0.585	0.195	0.615	
		<b>SUM =</b>	<b>1.534</b>	<b>SUM =</b>	<b>0.970</b>	<b>SUM =</b>	<b>1.010</b>	close enough

**c) BUBL T P=15 bar (217.56 psia)**

Component	xi	T=220 F		T=150 F		T=145 F (62.78 C)		ANSWER
		Ki	yi=Ki*xi	Ki	yi=Ki*xi	Ki	yi=Ki*xi	
ethane	0.14	5.350	0.749	3.800	0.532	3.700	0.518	
propane	0.13	2.500	0.325	1.525	0.198	1.475	0.192	
isobutane	0.25	1.475	0.369	0.760	0.190	0.720	0.180	
isopentane	0.48	0.57	0.274	0.27	0.130	0.25	0.120	
		<b>SUM =</b>	<b>1.716</b>	<b>SUM =</b>	<b>1.050</b>	<b>SUM =</b>	<b>1.010</b>	close enough

**d) DEW T P=15 bar (217.56 psia)**

Component	yi	T=150 F		T=145 F		T=148 F (64.44 C)		ANSWER
		Ki	xi=yi/Ki	Ki	xi=yi/Ki	Ki	xi=yi/Ki	
ethane	0.42	3.800	0.111	3.700	0.114	3.800	0.111	
propane	0.30	1.525	0.197	1.475	0.203	1.500	0.200	
isobutane	0.15	0.760	0.197	0.720	0.208	0.740	0.203	
isopentane	0.13	0.27	0.481	0.25	0.520	0.26	0.500	
		<b>SUM =</b>	<b>0.986</b>	<b>SUM =</b>	<b>1.045</b>	<b>SUM =</b>	<b>1.013</b>	close enough



**Problem 10.27**

**FLASH**      **T=80 F (14.81 C)**      **P=250 psia (17.24 bar)**

Component	zi	Fraction condensed		
		V= 0.855	L= 0.145	ANSWER
		Ki	yi	xi=yi/Ki
methane	0.50	10.000	0.575	0.058
ethane	0.10	2.075	0.108	0.052
propane	0.20	0.680	0.187	0.275
n-butane	0.20	0.21	0.129	0.616
		<b>SUM = 1.000</b>	<b>SUM = 1.001</b>	

**Problem 10.28**

First calculate equilibrium composition

**T=95 C (203 F)**

Component	xi	P=80 psia		P=65 psia		P=69 psia (4.83 bar)		ANSWER
		Ki	yi=Ki*xi	Ki	yi=Ki*xi	Ki	yi=Ki*xi	
n-butane	0.25	2.25	0.5625	2.7	0.675	2.6	0.633	
n-hexane	0.75	0.45	0.3375	0.51	0.3825	0.49	0.3675	
		<b>SUM = 0.9000</b>	<b>SUM = 1.0575</b>	<b>SUM = 1.0005</b>	<b>SUM = 1.0005</b>	<b>SUM = 1.0005</b>	<b>SUM = 1.0005</b>	Close enough

Now calculate liquid fraction from mole balances

$z_1 = 0.5$   
 $x_1 = 0.25$   
 $y_1 = 0.633$   
**ANSWER**       $L = 0.347$

**Problem 10.29**

**FLASH**      **P = 2.00 atm (29.39 psia)**  
**T = 200 F (93.3 C)**

Component	zi	Fraction condensed		
		V= 0.266	L= 0.73	ANSWER
		Ki	yi	xi=yi/Ki
n-pentane	0.25	2.150	0.412	0.191
n-hexane	0.45	0.960	0.437	0.455
n-heptane	0.30	0.430	0.152	0.354
		<b>SUM = 1.000</b>	<b>SUM = 1.000</b>	

**Problem 10.30**

**FLASH T=40 C (104 F)**

Component	z <sub>i</sub>	Fraction condensed						ANSWER			
		V= 0.60			L= 0.40			P=120 psia (8.274 bar)			
		P=110 psia			P=100 psia						
	K <sub>i</sub>	y <sub>i</sub>	x <sub>i</sub> =y <sub>i</sub> /K <sub>i</sub>	K <sub>i</sub>	y <sub>i</sub>	x <sub>i</sub> =y <sub>i</sub> /K <sub>i</sub>	K <sub>i</sub>	y <sub>i</sub>	x <sub>i</sub> =y <sub>i</sub> /K <sub>i</sub>		
ethane	0.15	5.400	0.223	0.041	4.900	0.220	0.045	4.660	0.219	0.047	
propane	0.35	1.900	0.432	0.227	1.700	0.419	0.246	1.620	0.413	0.255	
n-butane	0.50	0.610	0.398	0.653	0.540	0.373	0.691	0.525	0.367	0.699	
	<b>SUM =</b>	<b>1.053</b>	<b>0.921</b>	<b>SUM =</b>	<b>1.012</b>	<b>0.982</b>	<b>SUM =</b>	<b>0.999</b>	<b>1.001</b>		

**Problem 10.31**

**FLASH T=70 F (21.11 C)**

Component	z <sub>i</sub>	Fraction condensed						ANSWER			
		V= 0.20			L= 0.80			P=44 psia (3.034 bar)			
		P=50 psia			P=40 psia						
	K <sub>i</sub>	y <sub>i</sub>	x <sub>i</sub> =y <sub>i</sub> /K <sub>i</sub>	K <sub>i</sub>	y <sub>i</sub>	x <sub>i</sub> =y <sub>i</sub> /K <sub>i</sub>	K <sub>i</sub>	y <sub>i</sub>	x <sub>i</sub> =y <sub>i</sub> /K <sub>i</sub>		
ethane	0.01	7.400	0.032	0.004	9.300	0.035	0.004	8.500	0.034	0.004	
propane	0.05	2.400	0.094	0.039	3.000	0.107	0.036	2.700	0.101	0.037	
i-butane	0.50	0.925	0.470	0.508	1.150	0.558	0.485	1.060	0.524	0.494	
n-butane	0.44	0.660	0.312	0.472	0.810	0.370	0.457	0.740	0.343	0.464	
	<b>SUM =</b>	<b>0.907</b>	<b>1.023</b>	<b>SUM =</b>	<b>1.071</b>	<b>0.982</b>	<b>SUM =</b>	<b>1.002</b>	<b>1.000</b>		

**Problem 10.32**

**FLASH**

**T=-15 C (5 F)**

**Target:  $y_1=0.8$**

**P=300 psia**

**V= 0.1855**

**L= 0.8145**

<b>Component</b>	<b>zi</b>	<b>Ki</b>	<b>yi</b>	<b>xi=yi/Ki</b>
methane	0.30	5.600	0.906	0.162
ethane	0.10	0.820	0.085	0.103
propane	0.30	0.200	0.070	0.352
n-butane	0.30	0.047	0.017	0.364
		<b>SUM =</b>	<b>1.079</b>	<b>SUM = 0.982</b>

**P=150 psia**

**V= 0.3150**

**L= 0.6850**

<b>Component</b>	<b>zi</b>	<b>Ki</b>	<b>yi</b>	<b>xi=yi/Ki</b>
methane	0.30	10.900	0.794	0.073
ethane	0.10	1.420	0.125	0.088
propane	0.30	0.360	0.135	0.376
n-butane	0.30	0.074	0.031	0.424
		<b>SUM =</b>	<b>1.086</b>	<b>SUM = 0.960</b>

**P=270 psia (18.616 bar)**

**V= 0.2535**

**L= 0.7465 ANSWER**

<b>Component</b>	<b>zi</b>	<b>Ki</b>	<b>yi</b>	<b>xi=yi/Ki</b>
methane	0.30	6.200	0.802	0.129
ethane	0.10	0.900	0.092	0.103
propane	0.30	0.230	0.086	0.373
n-butane	0.30	0.0495	0.020	0.395
		<b>SUM =</b>	<b>1.000</b>	<b>SUM = 1.000</b>

**Problem 10.33**

First calculate vapor composition and temperature on top tray

**BUBL T:** P=20 psia

Component	xi	T=70 F		T=60 F		T=69 F (20.56 C)		ANSWER
		Ki	yi=Ki*xi	Ki	yi=Ki*xi	Ki	yi=Ki*xi	
n-butane	0.50	1.575	0.788	1.350	0.675	1.550	0.775	
n-pentane	0.50	0.450	0.225	0.360	0.180	0.440	0.220	
		<b>SUM =</b>	<b>1.013</b>	<b>SUM =</b>	<b>0.855</b>	<b>SUM =</b>	<b>0.995</b>	close enough

Using calculated vapor composition from top tray, calculate composition out of condenser

**FLASH** P=20 psia (1.379 bar)

Component	zi	T=70 F		T=60 F (15.56 C)		ANSWER	
		Ki	yi	Ki	yi		
n-butane	0.78	1.575	0.948	1.350	0.890	0.660	
n-pentane	0.22	0.450	0.137	0.360	0.116	0.324	
		<b>SUM =</b>	<b>1.085</b>	<b>0.905</b>	<b>SUM =</b>	<b>1.007</b>	<b>0.983</b>

**Problem 10.34**

**FLASH** T=40 C (104 F)

Component	zi	P=350 psia			P=250 psia			ANSWER P=325 psia (7.929 bar)		
		Ki	yi	xi=yi/Ki	Ki	yi	xi=yi/Ki	Ki	yi	xi=yi/Ki
methane	0.50	7.900	0.768	0.097	11.000	0.786	0.071	8.400	0.772	0.092
n-butane	0.50	0.235	0.217	0.924	0.290	0.253	0.871	0.245	0.224	0.914
		<b>SUM =</b>	<b>0.986</b>	<b>1.021</b>	<b>SUM =</b>	<b>1.038</b>	<b>0.943</b>	<b>SUM =</b>	<b>0.996</b>	<b>1.006</b>

close enough

10.35 a) The equation from NIST is:  $M_i = k_i \cdot y_i \cdot P$  Eq. (1)

The equation for Henry's Law is:  $x_i \cdot H_i = y_i \cdot P$  Eq. (2)

Solving to eliminate P gives:  $H_i = \frac{M_i}{k_i \cdot x_i}$  Eq. (3)

By definition:  $M_i = \frac{n_i}{n_s \cdot M_s}$  where M is the molar mass and the subscript s refers to the solvent.

Dividing by the total number of moles gives:  $M_i = \frac{x_i}{x_s \cdot M_s}$  Eq. (4)

Combining Eqs. (3) and (4) gives:  $H_i = \frac{1}{x_s \cdot M_s \cdot k_i}$

If  $x_i$  is small, then  $x_s$  is approximately equal to 1 and:  $H_i = \frac{1}{M_s \cdot k_i}$  Eq. (5)

b) For water as solvent:  $M_s := 18.015 \frac{\text{gm}}{\text{mol}}$

For CO<sub>2</sub> in H<sub>2</sub>O:  $k_i := 0.034 \frac{\text{mol}}{\text{kg} \cdot \text{bar}}$

By Eq. (5):  $H_i := \frac{1}{M_s \cdot k_i}$   $H_i = 1633 \text{ bar}$  Ans.

The value in Table 10.1 is 1670 bar. The values agree within about 2%.

10.36

Acetone:

$$P_{\text{sat}1}(T) := e^{14.3145 - \frac{2756.22}{\frac{T}{\text{degC}} + 228.060}} \cdot \text{kPa}$$

Acetonitrile

$$P_{\text{sat}2}(T) := e^{14.8950 - \frac{3413.10}{\frac{T}{\text{degC}} + 250.523}} \cdot \text{kPa}$$

a) Find BUBL P and DEW P values

$T := 50 \text{ degC}$      $x_1 := 0.5$      $y_1 := 0.5$

$$\text{BUBLP} := x_1 \cdot \text{Psat}_1(T) + (1 - x_1) \cdot \text{Psat}_2(T) \quad \text{BUBLP} = 0.573 \text{ atm} \quad \text{Ans.}$$

$$\text{DEWP} := \frac{1}{\frac{y_1}{\text{Psat}_1(T)} + \frac{(1 - y_1)}{\text{Psat}_2(T)}} \quad \text{DEWP} = 0.478 \text{ atm} \quad \text{Ans.}$$

At T = 50 C two phases will form between P = 0.478 atm and 0.573 atm

b) Find BUBL T and DEW T values

$$P := 0.5 \text{ atm} \quad x_1 := 0.5 \quad y_1 := 0.5 \quad \text{Guess: } T := 50 \text{ degC}$$

$$\text{Given } x_1 \cdot \text{Psat}_1(T) + (1 - x_1) \cdot \text{Psat}_2(T) = P$$

$$\text{BUBLT} := \text{Find}(T) \quad \text{BUBLT} = 46.316 \text{ degC} \quad \text{Ans.}$$

$$\text{Given } x_1 \cdot \text{Psat}_1(T) = y_1 \cdot P \quad (1 - x_1) \cdot \text{Psat}_2(T) = (1 - y_1) \cdot P$$

$$\begin{pmatrix} x_1 \\ \text{DEWT} \end{pmatrix} := \text{Find}(x_1, T) \quad \text{DEWT} = 51.238 \text{ degC} \quad \text{Ans.}$$

At P = 0.5 atm, two phases will form between T = 46.3 C and 51.2 C

10.37 Calculate x and y at T = 90 C and P = 75 kPa

$$\text{Benzene: } \text{Psat}_1(T) := e^{13.7819 - \frac{2726.81}{\frac{T}{\text{degC}} + 217.572}} \cdot \text{kPa}$$

$$\text{Toluene: } \text{Psat}_2(T) := e^{13.9320 - \frac{3056.96}{\frac{T}{\text{degC}} + 217.625}} \cdot \text{kPa}$$

a) Calculate the equilibrium composition of the liquid and vapor at the flash T and P

$$T := 90 \text{ degC} \quad P := 75 \text{ kPa} \quad \text{Guess: } x_1 := 0.5 \quad y_1 := 0.5$$

$$\text{Given } x_1 \cdot P_{\text{sat}_1}(T) = y_1 \cdot P \quad (1 - x_1) \cdot P_{\text{sat}_2}(T) = (1 - y_1) \cdot P$$

$$\begin{pmatrix} x_1 \\ y_1 \end{pmatrix} := \text{Find}(x_1, y_1) \quad x_1 = 0.252 \quad y_1 = 0.458$$

The equilibrium compositions do not agree with the measured values.

- b) Assume that the measured values are correct. Since air will not dissolve in the liquid to any significant extent, the mole fractions of toluene in the liquid can be calculated.

$$x_1 := 0.1604 \quad y_1 := 0.2919 \quad x_2 := 1 - x_1 \quad x_2 = 0.8396$$

Now calculate the composition of the vapor.  $y_3$  represents the mole fraction of air in the vapor.

$$\text{Guess: } y_2 := 0.5 \quad y_3 := 1 - y_2 - y_1$$

Given

$$(1 - x_1) \cdot P_{\text{sat}_2}(T) = (1 - y_1 - y_3) \cdot P \quad y_1 + y_2 + y_3 = 1$$

$$\begin{pmatrix} y_2 \\ y_3 \end{pmatrix} := \text{Find}(y_2, y_3) \quad y_2 = 0.608 \\ y_3 = 0.1 \quad \text{Ans.}$$

Conclusion: An air leak is consistent with the measured compositions.

$$10.38 \quad y_{\text{O}_2} := 0.0387 \quad y_{\text{N}_2} := 0.7288 \quad y_{\text{CO}_2} := 0.0775 \quad y_{\text{H}_2\text{O}} := 0.1550$$

$$\dot{n} := 10 \frac{\text{kmol}}{\text{hr}} \quad T_1 := 100 \text{ degC} \quad T_2 := 25 \text{ degC} \quad P := 1 \text{ atm}$$

$$P_{\text{sat}_{\text{H}_2\text{O}}}(T) := e^{16.3872 - \frac{3885.70}{\frac{T}{\text{degC}} + 230.170}} \cdot \text{kPa}$$

Calculate the mole fraction of water in the exit gas if the exit gas is saturated with water.

$$y_{\text{H}_2\text{O}_2} := \frac{P_{\text{satH}_2\text{O}}(T_2)}{P} \quad y_{\text{H}_2\text{O}_2} = 0.0315$$

This is less than the mole fraction of water in the feed. Therefore, some of the water will condense.

Assume that two streams leave the process: a liquid water stream at rate  $\dot{n}_{\text{liq}}$  and a vapor stream at rate  $\dot{n}_{\text{vap}}$ . Apply mole balances around the cooler to calculate the exit composition of the vapor phase.

**Guess:**

$$\dot{n}_{\text{vap}} := \frac{\dot{n}}{2} \quad \dot{n}_{\text{liq}} := \frac{\dot{n}}{2}$$

$$y_{\text{O}_2} := 0.0387 \quad y_{\text{N}_2} := 0.7288 \quad y_{\text{CO}_2} := 0.0775$$

Given  $\dot{n} = \dot{n}_{\text{liq}} + \dot{n}_{\text{vap}}$  **Overall balance**

$$\dot{n} \cdot y_{\text{O}_2_1} = \dot{n}_{\text{vap}} \cdot y_{\text{O}_2_2} \quad \text{O}_2 \text{ balance}$$

$$\dot{n} \cdot y_{\text{N}_2_1} = \dot{n}_{\text{vap}} \cdot y_{\text{N}_2_2} \quad \text{N}_2 \text{ balance}$$

$$\dot{n} \cdot y_{\text{CO}_2_1} = \dot{n}_{\text{vap}} \cdot y_{\text{CO}_2_2} \quad \text{CO}_2 \text{ balance}$$

$$y_{\text{O}_2_2} + y_{\text{N}_2_2} + y_{\text{CO}_2_2} + y_{\text{H}_2\text{O}_2} = 1 \quad \text{Summation equation}$$

$$\begin{pmatrix} \dot{n}_{\text{liq}} \\ \dot{n}_{\text{vap}} \\ y_{\text{O}_2_2} \\ y_{\text{N}_2_2} \\ y_{\text{CO}_2_2} \end{pmatrix} := \text{Find}(\dot{n}_{\text{liq}}, \dot{n}_{\text{vap}}, y_{\text{O}_2_2}, y_{\text{N}_2_2}, y_{\text{CO}_2_2})$$

$$\dot{n}_{\text{liq}} = 1.276 \frac{\text{kmol}}{\text{hr}}$$

$$\dot{n}_{\text{vap}} = 8.724 \frac{\text{kmol}}{\text{hr}}$$

$$y_{\text{O}_2_2} = 0.044$$

$$y_{\text{N}_2_2} = 0.835$$

$$y_{\text{CO}_2_2} = 0.089$$

$$y_{\text{H}_2\text{O}_2} = 0.031$$



Apply an energy balance around the cooler to calculate heat transfer rate.

$$\Delta H_{lvH_2O} := 40.66 \frac{\text{kJ}}{\text{mol}} \quad T_1 := T_1 + 273.15\text{K} \quad T_2 := T_2 + 273.15\text{K}$$

$$\begin{aligned} \dot{Q} := & \dot{n}_{\text{vap}} \cdot y_{\text{O}_2} \cdot R \cdot \text{ICPH}(T_1, T_2, 3.639, 0.506 \cdot 10^{-3}, 0, -0.227 \cdot 10^5) \dots \\ & + \dot{n}_{\text{vap}} \cdot y_{\text{N}_2} \cdot R \cdot \text{ICPH}(T_1, T_2, 3.280, 0.539 \cdot 10^{-3}, 0, 0.040 \cdot 10^5) \dots \\ & + \dot{n}_{\text{vap}} \cdot y_{\text{CO}_2} \cdot R \cdot \text{ICPH}(T_1, T_2, 5.457, 1.045 \cdot 10^{-3}, 0, -1.157 \cdot 10^5) \dots \\ & + \dot{n}_{\text{vap}} \cdot y_{\text{H}_2\text{O}} \cdot R \cdot \text{ICPH}(T_1, T_2, 3.470, 1.450 \cdot 10^{-3}, 0, 0.121 \cdot 10^5) \dots \\ & + -(\Delta H_{lvH_2O} \cdot \dot{n}_{\text{liq}}) \end{aligned}$$

$$\dot{Q} = -19.895 \text{ kW} \quad \text{Ans.}$$

10.39 Assume the liquid is stored at the bubble point at  $T = 40 \text{ F}$

Taking values from Fig 10.14 at pressure:  $P := 18 \text{ psia}$  Ans.

$$x_{C3} := 0.05 \quad K_{C3} := 3.9$$

$$x_{C4} := 0.85 \quad K_{C4} := 0.925$$

$$x_{C5} := 0.10 \quad K_{C5} := 0.23$$

The vapor mole fractions must sum to 1.

$$x_{C3} \cdot K_{C3} + x_{C4} \cdot K_{C4} + x_{C5} \cdot K_{C5} = 1.004$$

10.40  $\text{H}_2\text{S} + 3/2 \text{O}_2 \rightarrow \text{H}_2\text{O} + \text{SO}_2$

By a stoichiometric balance, calculate the following total molar flow rates

Feed:  $\dot{n}_{\text{H}_2\text{S}} := 10 \frac{\text{kmol}}{\text{hr}}$   $\dot{n}_{\text{O}_2} := \frac{3}{2} \dot{n}_{\text{H}_2\text{S}}$

Products  $\dot{n}_{\text{SO}_2} := \dot{n}_{\text{H}_2\text{S}}$   $\dot{n}_{\text{H}_2\text{O}} := \dot{n}_{\text{H}_2\text{S}}$

Exit conditions:

$P := 1 \text{ atm}$   $T_2 := 70 \text{ degC}$   $P_{\text{satH}_2\text{O}}(T) := e^{\frac{16.3872 - \frac{3885.70}{T}}{\text{degC} + 230.170}} \cdot \text{kPa}$

a) Calculate the mole fraction of  $\text{H}_2\text{O}$  and  $\text{SO}_2$  in the exiting vapor stream assuming vapor is saturated with  $\text{H}_2\text{O}$

$y_{\text{H}_2\text{Ovapor}} := \frac{P_{\text{satH}_2\text{O}}(T_2)}{P}$   $y_{\text{H}_2\text{Ovapor}} = 0.308$  **Ans.**

$y_{\text{SO}_2} := 1 - y_{\text{H}_2\text{Ovapor}}$   $y_{\text{SO}_2} = 0.692$  **Ans.**

b) Calculate the vapor stream molar flow rate using balance on  $\text{SO}_2$

$\dot{n}_{\text{vapor}} := \frac{\dot{n}_{\text{SO}_2}}{y_{\text{SO}_2}}$   $\dot{n}_{\text{vapor}} = 14.461 \frac{\text{kmol}}{\text{hr}}$  **Ans.**

Calculate the liquid  $\text{H}_2\text{O}$  flow rate using balance on  $\text{H}_2\text{O}$

$\dot{n}_{\text{H}_2\text{Ovapor}} := \dot{n}_{\text{vapor}} \cdot y_{\text{H}_2\text{Ovapor}}$   $\dot{n}_{\text{H}_2\text{Ovapor}} = 4.461 \frac{\text{kmol}}{\text{hr}}$

$\dot{n}_{\text{H}_2\text{Oliq}} := \dot{n}_{\text{H}_2\text{O}} - \dot{n}_{\text{H}_2\text{Ovapor}}$   $\dot{n}_{\text{H}_2\text{Oliq}} = 5.539 \frac{\text{kmol}}{\text{hr}}$  **Ans.**

$$10.41 \quad NCL := 0.01 \frac{\text{kg}}{\text{kg}} \quad M_{H_2O} := 18.01 \frac{\text{gm}}{\text{mol}} \quad M_{air} := 29 \frac{\text{gm}}{\text{mol}}$$

$$a) \quad Y_{H_2O} := NCL \cdot \frac{M_{air}}{M_{H_2O}}$$

$$Y_{H_2O} = 0.0161$$

$$y_{H_2O} := \frac{Y_{H_2O}}{1 + Y_{H_2O}}$$

$$y_{H_2O} = 0.0158$$

Ans.

$$b) \quad P := 1 \text{ atm}$$

$$p_{H_2O} := Y_{H_2O} \cdot P$$

$$p_{H_2O} = 1.606 \text{ kPa} \quad \text{Ans.}$$

$$c) \quad P_{satH_2O}(T) := e^{16.3872 - \frac{3885.70}{\frac{T}{\text{degC}} + 230.170}} \cdot \text{kPa} \quad \text{Guess: } T := 20 \text{ degC}$$

Given

$$Y_{H_2O} \cdot P = P_{satH_2O}(T) \quad T_{dp} := \text{Find}(T)$$

$$T_{dp} = 14.004 \text{ degC}$$

$$T_{dp} := T_{dp} + 32 \text{ degF}$$

$$T_{dp} = 57.207 \text{ degF} \quad \text{Ans.}$$

$$10.42 \quad \dot{n}_{d1} := 50 \frac{\text{kmol}}{\text{hr}} \quad T_{dp1} := 20 \text{ degC} \quad T_{dp2} := 10 \text{ degC} \quad P := 1 \text{ atm}$$

$$P_{satH_2O}(T) := e^{16.3872 - \frac{3885.70}{\frac{T}{\text{degC}} + 230.170}} \cdot \text{kPa}$$

$$M_{H_2O} := 18.01 \frac{\text{gm}}{\text{mol}}$$

$$y_1 := \frac{P_{satH_2O}(T_{dp1})}{P}$$

$$y_1 = 0.023$$

$$y_2 := \frac{P_{satH_2O}(T_{dp2})}{P}$$

$$y_2 = 0.012$$

**By a mole balances on the process**

$$\text{Guess: } \dot{n}_{d2liq} := \dot{n}_{d1} \quad \dot{n}_{d2vap} := \dot{n}_{d1}$$

Given  $\dot{n}_1 \cdot y_1 = \dot{n}_{2\text{vap}} \cdot y_2 + \dot{n}_{2\text{liq}}$

**H2O balance**

$\dot{n}_1 = \dot{n}_{2\text{vap}} + \dot{n}_{2\text{liq}}$

**Overall balance**

$$\begin{pmatrix} \dot{n}_{2\text{liq}} \\ \dot{n}_{2\text{vap}} \end{pmatrix} := \text{Find}(\dot{n}_{2\text{liq}}, \dot{n}_{2\text{vap}})$$

$$\dot{n}_{2\text{vap}} = 49.441 \frac{\text{kmol}}{\text{hr}}$$

$$\dot{n}_{2\text{liq}} = 0.559 \frac{\text{kmol}}{\text{hr}}$$

$$\dot{m}_{2\text{liq}} := \dot{n}_{2\text{liq}} \cdot M_{\text{H}_2\text{O}}$$

$$\dot{m}_{2\text{liq}} = 10.074 \frac{\text{kg}}{\text{hr}}$$

**Ans.**

**10.43 Benzene:**

$$A1 := 13.7819$$

$$B1 := 2726.81$$

$$C1 := 217.572$$

**Cyclohexane:**

$$A2 := 13.6568$$

$$B2 := 2723.44$$

$$C2 := 220.618$$

$$P_{\text{sat1}}(T) := \exp\left(A1 - \frac{B1}{\frac{T}{\text{degC}} + C1}\right) \text{ kPa}$$

$$P_{\text{sat2}}(T) := \exp\left(A2 - \frac{B2}{\frac{T}{\text{degC}} + C2}\right) \text{ kPa}$$

**Guess:**  $T := 66 \text{ degC}$

Given  $P_{\text{sat1}}(T) = P_{\text{sat2}}(T)$        $T := \text{Find}(T)$

**The Bancroft point for this system is:**

$$P_{\text{sat1}}(T) = 39.591 \text{ kPa}$$

$$T = 52.321 \text{ degC}$$

**Ans.**

Component 1	Component 2	T ( C )	P (kPa)
Benzene	Cyclohexane	52.3	39.6
2-Butanol	Water	87.7	64.2
Acetonitrile	Ethanol	65.8	60.6

## Chapter 11 - Section A - Mathcad Solutions

### 11.1 For an ideal gas mole fraction = volume fraction

CO<sub>2</sub> (1):  $x_1 := 0.7$   $V_1 := 0.7\text{m}^3$

N<sub>2</sub> (2):  $x_2 := 0.3$   $V_2 := 0.3\text{m}^3$

$i := 1..2$   $P := 1\text{bar}$   $T := (25 + 273.15)\text{K}$

$$n := \frac{P \cdot \sum_i V_i}{R \cdot T} \quad n = 40.342 \text{ mol}$$

$$\Delta S := -n \cdot R \cdot \sum_i (x_i \cdot \ln(x_i)) \quad \Delta S = 204.885 \frac{\text{J}}{\text{K}} \quad \text{Ans.}$$

### 11.2 For a closed, adiabatic, fixed-volume system, $\Delta U = 0$ . Also, for an ideal gas, $\Delta U = C_v \Delta T$ . First calculate the equilibrium T and P.

$n_{\text{N}_2} := 4 \cdot \text{mol}$   $T_{\text{N}_2} := [(75 + 273.15) \cdot \text{K}]$   $P_{\text{N}_2} := 30 \cdot \text{bar}$

$n_{\text{Ar}} := 2.5 \cdot \text{mol}$   $T_{\text{Ar}} := (130 + 273.15) \cdot \text{K}$   $P_{\text{Ar}} := 20 \cdot \text{bar}$

$T_{\text{N}_2} = 348.15 \text{ K}$   $T_{\text{Ar}} = 403.15 \text{ K}$   $i := 1..2$

$$n_{\text{total}} := n_{\text{N}_2} + n_{\text{Ar}} \quad x_1 := \frac{n_{\text{N}_2}}{n_{\text{total}}} \quad x_2 := \frac{n_{\text{Ar}}}{n_{\text{total}}}$$

$x_1 = 0.615$   $x_2 = 0.385$

$C_{v\text{Ar}} := \frac{3}{2} \cdot R$   $C_{v\text{N}_2} := \frac{5}{2} \cdot R$

$C_{p\text{Ar}} := C_{v\text{Ar}} + R$   $C_{p\text{N}_2} := C_{v\text{N}_2} + R$

Find T after mixing by energy balance:

$$T := \frac{T_{\text{N}_2} + T_{\text{Ar}}}{2} \quad (\text{guess})$$

Given  $n_{\text{N}_2} \cdot C_{v\text{N}_2} \cdot (T - T_{\text{N}_2}) = n_{\text{Ar}} \cdot C_{v\text{Ar}} \cdot (T_{\text{Ar}} - T)$   $T := \text{Find}(T)$

$$T = 273.15 \cdot K = 90 \text{ degC}$$

**Find P after mixing:**

$$P := \frac{P_{N2} + P_{Ar}}{2} \quad (\text{guess})$$

Given

$$\frac{(n_{N2} + n_{Ar}) \cdot R \cdot T}{P} = \frac{n_{N2} \cdot R \cdot T_{N2}}{P_{N2}} + \frac{n_{Ar} \cdot R \cdot T_{Ar}}{P_{Ar}}$$

$$P := \text{Find}(P) \quad P = 24.38 \text{ bar}$$

**Calculate entropy change by two-step path:**

**1) Bring individual stream to mixture T and P.**

**2) Then mix streams at mixture T and P.**

$$\Delta S_{N2} := n_{N2} \cdot \left( C_{pN2} \cdot \ln\left(\frac{T}{T_{N2}}\right) - R \cdot \ln\left(\frac{P}{P_{N2}}\right) \right) \quad \Delta S_{N2} = 11.806 \frac{J}{K}$$

$$\Delta S_{Ar} := n_{Ar} \cdot \left( C_{pAr} \cdot \ln\left(\frac{T}{T_{Ar}}\right) - R \cdot \ln\left(\frac{P}{P_{Ar}}\right) \right) \quad \Delta S_{Ar} = -9.547 \frac{J}{K}$$

$$\Delta S_{mix} := n_{total} \cdot \left[ -R \cdot \sum_i (x_i \cdot \ln(x_i)) \right] \quad \Delta S_{mix} = 36.006 \frac{J}{K}$$

$$\Delta S := \Delta S_{N2} + \Delta S_{Ar} + \Delta S_{mix} \quad \Delta S = 38.27 \frac{J}{K} \quad \text{Ans.}$$

**11.3**

$$\dot{m}_{N2} := 2 \cdot \frac{kg}{sec}$$

$$\dot{m}_{H2} := 0.5 \cdot \frac{kg}{sec}$$

$$molwt_{N2} := 28.014 \cdot \frac{gm}{mol}$$

$$molwt_{H2} := 2.016 \cdot \frac{gm}{mol} \quad i := 1..2$$

$$molarflow_{N2} := \frac{\dot{m}_{N2}}{molwt_{N2}}$$

$$molarflow_{H2} := \frac{\dot{m}_{H2}}{molwt_{H2}}$$

$$molarflow_{total} := molarflow_{N2} + molarflow_{H2} \quad molarflow_{total} = 319.409 \frac{mol}{sec}$$

$$y_1 := \frac{\text{molarflow}_{\text{N}_2}}{\text{molarflow}_{\text{total}}} \quad y_1 = 0.224 \quad y_2 := \frac{\text{molarflow}_{\text{H}_2}}{\text{molarflow}_{\text{total}}} \quad y_2 = 0.776$$

$$\Delta S := -R \cdot \text{molarflow}_{\text{total}} \cdot \sum_i (y_i \cdot \ln(y_i)) \quad \Delta S = 1411 \frac{\text{J}}{\text{sec} \cdot \text{K}} \quad \text{Ans.}$$

11.4  $T_1 := 448.15 \cdot \text{K}$   $T_2 := 308.15 \cdot \text{K}$   $P_1 := 3 \cdot \text{bar}$   $P_2 := 1 \cdot \text{bar}$

**For methane:**

$$\text{MCPH}_m := \text{MCPH}(T_1, T_2, 1.702, 9.081 \cdot 10^{-3}, -2.164 \cdot 10^{-6}, 0.0)$$

$$\text{MCPS}_m := \text{MCPS}(T_1, T_2, 1.702, 9.081 \cdot 10^{-3}, -2.164 \cdot 10^{-6}, 0.0)$$

**For ethane:**

$$\text{MCPH}_e := \text{MCPH}(T_1, T_2, 1.131, 19.225 \cdot 10^{-3}, -5.561 \cdot 10^{-6}, 0.0)$$

$$\text{MCPS}_e := \text{MCPS}(T_1, T_2, 1.131, 19.225 \cdot 10^{-3}, -5.561 \cdot 10^{-6}, 0.0)$$

$$\text{MCPH}_{\text{mix}} := 0.5 \cdot \text{MCPH}_m + 0.5 \cdot \text{MCPH}_e \quad \text{MCPH}_{\text{mix}} = 6.21$$

$$\text{MCPS}_{\text{mix}} := 0.5 \cdot \text{MCPS}_m + 0.5 \cdot \text{MCPS}_e \quad \text{MCPS}_{\text{mix}} = 6.161$$

$$\Delta H := R \cdot \text{MCPH}_{\text{mix}} \cdot (T_2 - T_1) \quad \Delta H = -7228 \frac{\text{J}}{\text{mol}}$$

$$\Delta S := R \cdot \text{MCPS}_{\text{mix}} \cdot \ln\left(\frac{T_2}{T_1}\right) - R \cdot \ln\left(\frac{P_2}{P_1}\right) + R \cdot 2 \cdot 0.5 \cdot \ln(0.5)$$

**The last term is the entropy change of UNmixing**

$$\Delta S = -15.813 \frac{\text{J}}{\text{mol} \cdot \text{K}}$$

$$T_\sigma := 300 \cdot \text{K}$$

$$W_{\text{ideal}} := \Delta H - T_\sigma \cdot \Delta S$$

$$W_{\text{ideal}} = -2484 \frac{\text{J}}{\text{mol}} \quad \text{Ans.}$$

11.5 **Basis: 1 mole entering air.**

$$y_1 := 0.21$$

$$y_2 := 0.79$$

$$\eta_t := 0.05$$

$$T_\sigma := 300 \cdot \text{K}$$

Assume ideal gases; then  $\Delta H = 0$

The entropy change of mixing for ideal gases is given by the equation following Eq. (11.26). For UNmixing of a binary mixture it becomes:

$$\Delta S := R \cdot (y_1 \cdot \ln(y_1) + y_2 \cdot \ln(y_2))$$

$$\Delta S = -4.273 \frac{\text{J}}{\text{mol} \cdot \text{K}}$$

By Eq. (5.27):  $W_{\text{ideal}} := -\Delta S \cdot S$

$$W_{\text{ideal}} = 1.282 \times 10^3 \frac{\text{J}}{\text{mol}}$$

By Eq. (5.28):  $\text{Work} := \frac{W_{\text{ideal}}}{\eta_t}$

$$\text{Work} = 25638 \frac{\text{J}}{\text{mol}} \text{ Ans.}$$

11.16

$$P := \begin{pmatrix} 0 \\ 10 \\ 20 \\ 40 \\ 60 \\ 80 \\ 100 \\ 200 \\ 300 \\ 400 \\ 500 \end{pmatrix} \cdot \text{bar}$$

$$Z := \begin{pmatrix} 1.000 \\ 0.985 \\ 0.970 \\ 0.942 \\ 0.913 \\ 0.885 \\ 0.869 \\ 0.765 \\ 0.762 \\ 0.824 \\ 0.910 \end{pmatrix}$$

$$\ln \phi_1 := 0$$

$$\phi_1 := 1$$

$$\text{end} := \text{rows}(P)$$

$$i := 2.. \text{end}$$

$$F_i := \frac{Z_i - 1}{P_i}$$

$F_i$  is a well behaved function; use the trapezoidal rule to integrate Eq. (11.35) numerically.

$$A_i := \frac{F_i + F_{i-1}}{2} \cdot (P_i - P_{i-1}) \quad \ln \phi_i := \ln \phi_{i-1} + A_i$$

$$\phi_i := \exp(\ln \phi_i) \quad f_i := \phi_i \cdot P_i$$

**Generalized correlation for fugacity coefficient:**

For CO<sub>2</sub>:  $T_c := 304.2 \cdot \text{K}$   $P_c := 73.83 \cdot \text{bar}$   $\omega := 0.224$

$$T := (150 + 273.15) \cdot \text{K} \quad T_r := \frac{T}{T_c} \quad T_r = 1.391$$

$$\phi_G(P) := \exp \left[ \frac{P}{P_c} \cdot (B_0(T_r) + \omega \cdot B_1(T_r)) \right] \quad f_G(P) := \phi_G(P) \cdot P$$



Calculate values:

$\frac{P_i}{\text{bar}} =$	$\phi_i =$	$\frac{f_i}{\text{bar}} =$
10	0.993	9.925
20	0.978	19.555
40	0.949	37.973
60	0.922	55.332
80	0.896	71.676
100	0.872	87.167
200	0.77	153.964
300	0.698	209.299
400	0.656	262.377
500	0.636	317.96

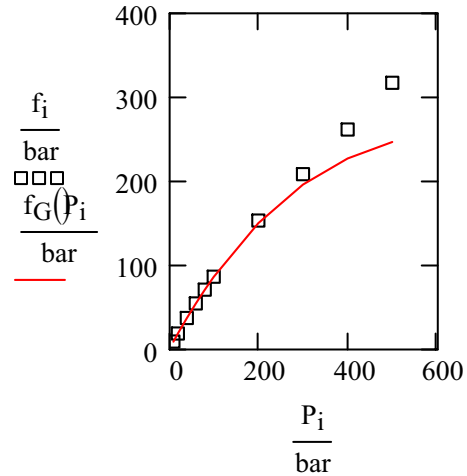
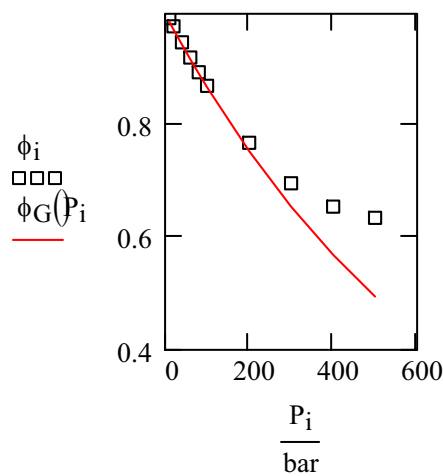

Agreement looks good up to about 200 bar ( $Pr=2.7$  @  $Tr=1.39$ )

11.17 For SO<sub>2</sub>:

$$T_c := 430.8 \cdot K$$

$$P_c := 78.84 \cdot \text{bar}$$

$$\omega := 0.245$$

$$T := 600 \cdot K$$

$$P := 300 \cdot \text{bar}$$

$$T_r := \frac{T}{T_c}$$

$$T_r = 1.393$$

$$P_r := \frac{P}{P_c}$$

$$P_r = 3.805$$

For the given conditions, we see from Fig. 3.14 that the Lee/Kesler correlation is appropriate.

Data from Tables E.15 & E.16 and by Eq. (11.67):

$$\phi_0 := 0.672$$

$$\phi_1 := 1.354$$

$$\phi = \phi_0 \phi_1^\omega$$

$$\phi = 0.724$$

$$f := \phi \cdot P$$

$$\text{GRRT} := \ln(\phi)$$

$$f = 217.14 \text{ bar}$$

$$\text{GRRT} = -0.323 \quad \text{Ans.}$$

11.18 Isobutylene:

$$T_c := 417.9 \cdot \text{K}$$

$$P_c := 40.00 \cdot \text{bar}$$

$$\omega := 0.194$$

a) At 280 degC and 20 bar:

$$T := (280 + 273.15) \cdot \text{K}$$

$$P := 20 \cdot \text{bar}$$

$$T_r(T) := \frac{T}{T_c}$$

$$T_r(T) = 1.3236$$

$$P_r(P) := \frac{P}{P_c}$$

$$P_r(P) = 0.5$$

At these conditions use the generalized virial-coefficient correlation.

$$f := \text{PHIB}(T_r(T), P_r(P), \omega) \cdot P$$

$$f = 18.76 \text{ bar} \quad \text{Ans.}$$

b) At 280 degC and 100 bar:

$$T := (280 + 273.15) \cdot \text{K}$$

$$P := 100 \cdot \text{bar}$$

$$T_r(T) = 1.3236$$

$$P_r(P) = 2.5$$

At these conditions use the Lee/Kesler correlation, Tables E.15 & E.16 and Eq. (11.67).

$$\phi_0 := 0.7025$$

$$\phi_1 := 1.2335$$

$$\phi = \phi_0 \phi_1^\omega$$

$$f := \phi \cdot P$$

$$\phi = 0.732$$

$$f = 73.169 \text{ bar} \quad \text{Ans.}$$

11.19 The following vectors contain data for Parts (a) and (b):

(a) = Cyclopentane; (b) = 1-butene

$$T_c := \begin{pmatrix} 511.8 \\ 420.0 \end{pmatrix} \cdot \text{K}$$

$$P_c := \begin{pmatrix} 45.02 \\ 40.43 \end{pmatrix} \cdot \text{bar}$$

$$\omega := \begin{pmatrix} 0.196 \\ 0.191 \end{pmatrix}$$

$$Z_c := \begin{pmatrix} 0.273 \\ 0.277 \end{pmatrix}$$

$$V_c := \begin{pmatrix} 258 \\ 239.3 \end{pmatrix} \cdot \frac{\text{cm}^3}{\text{mol}}$$

$$T_n := \begin{pmatrix} 322.4 \\ 266.9 \end{pmatrix} \cdot \text{K}$$

$$T := \begin{pmatrix} 383.15 \\ 393.15 \end{pmatrix} \cdot \text{K}$$

$$P := \begin{pmatrix} 275 \\ 34 \end{pmatrix} \cdot \text{bar}$$

$$P_{\text{sat}} := \begin{pmatrix} 5.267 \\ 25.83 \end{pmatrix} \cdot \text{bar}$$

$$T_r := \frac{\overrightarrow{T}}{T_c} \quad T_r = \begin{pmatrix} 0.7486 \\ 0.9361 \end{pmatrix} \quad P_{sat_r} := \frac{\overrightarrow{P_{sat}}}{P_c} \quad P_{sat_r} = \begin{pmatrix} 0.117 \\ 0.6389 \end{pmatrix}$$

Calculate the fugacity coefficient at the vapor pressure by Eq. (11.68):

(a)  $\text{PHIB}(T_{r_1}, \phi_{sat_{r_1}}, 1) = 0.900$

(b)  $\text{PHIB}(T_{r_2}, \phi_{sat_{r_2}}, 2) = 0.76$

Eq. (3.72), the Rackett equation:

$$T_r := \frac{\overrightarrow{T}}{T_c} \quad T_r = \begin{pmatrix} 0.749 \\ 0.936 \end{pmatrix}$$

Eq. (11.44):

$$V_{sat} := \left[ V_c \cdot Z_c \left( 1 - T_r \right)^{\frac{2}{7}} \right] \quad V_{sat} = \begin{pmatrix} 107.546 \\ 133.299 \end{pmatrix} \frac{\text{cm}^3}{\text{mol}}$$

$$f := \left[ \text{PHIB}(T_r, \phi_{sat_r}, \cdot) \cdot P_{sat} \cdot \exp \left[ \frac{V_{sat} \cdot (P - P_{sat})}{R \cdot T} \right] \right]$$

$$f = \begin{pmatrix} 11.78 \\ 20.29 \end{pmatrix} \text{bar} \quad \text{Ans.}$$

11.21 Table F.1, 150 degC:

$$P_{sat} := 476.00 \cdot \text{kPa}$$

$$\text{molwt} := 18 \cdot \frac{\text{gm}}{\text{mol}}$$

$$V_{sat} := 1.091 \cdot \frac{\text{cm}^3}{\text{gm}} \cdot \text{molwt}$$

$$T := (150 + 273.15) \cdot \text{K}$$

$$P := 150 \cdot \text{bar}$$

$$V_{sat} = 19.638 \frac{\text{cm}^3}{\text{mol}}$$

$$T = 423.15 \text{ K}$$

Equation Eq. (11.44) with  $\phi_{sat} P_{sat} = f_{sat}$

$$r := \exp \left[ \frac{V_{sat} \cdot (P - P_{sat})}{R \cdot T} \right]$$

$$r = 1.084$$

$$r = \frac{f}{f_{sat}} = 1.084 \quad \text{Ans.}$$

11.22 The following vectors contain data for Parts (a) and (b):  $\text{molwt} := 18 \cdot \frac{\text{gm}}{\text{mol}}$

Table F.2: (a) 9000 kPa & 400 degC; (b) 1000(psia) & 800 degF:

$$T_1 := \begin{pmatrix} (400 + 273.15) \cdot \text{K} \\ (800 + 459.67) \cdot \text{rankine} \end{pmatrix}$$

$$H_1 := \begin{pmatrix} 3121.2 \cdot \frac{\text{J}}{\text{gm}} \\ 1389.6 \cdot \frac{\text{Btu}}{\text{lb}_m} \end{pmatrix}$$

$$S_1 := \begin{pmatrix} 6.2915 \cdot \frac{\text{J}}{\text{gm} \cdot \text{K}} \\ 1.5677 \cdot \frac{\text{Btu}}{\text{lb}_m \cdot \text{rankine}} \end{pmatrix}$$

Table F.2: (a) 300 kPa & 400 degC; (b) 50(psia) & 800 degF:  $T_2 := T_1$

$$H_2 := \begin{pmatrix} 3275.2 \cdot \frac{\text{J}}{\text{gm}} \\ 1431.7 \cdot \frac{\text{Btu}}{\text{lb}_m} \end{pmatrix}$$

$$S_2 := \begin{pmatrix} 8.0338 \cdot \frac{\text{J}}{\text{gm} \cdot \text{K}} \\ 1.9227 \cdot \frac{\text{Btu}}{\text{lb}_m \cdot \text{rankine}} \end{pmatrix}$$

Eq. (A) on page 399 may be recast for this problem as:

$$r := \exp \left[ \frac{\text{molwt}}{R} \cdot \left[ \frac{H_2 - H_1}{T_1} - (S_2 - S_1) \right] \right] \quad r = \begin{pmatrix} 0.0377 \\ 0.0542 \end{pmatrix}$$

(a)  $r = \frac{f_2}{f_1} = 0.0377$       (b)  $r = \frac{f_2}{f_1} = 0.0542$       Ans.

11.23 The following vectors contain data for Parts (a), (b), and (c):

(a) = n-pentane

(b) = Isobutylene

(c) = 1-Butene:

$$T_c := \begin{pmatrix} 469.7 \\ 417.9 \\ 420.0 \end{pmatrix} \cdot \text{K}$$

$$P_c := \begin{pmatrix} 33.70 \\ 40.0 \\ 40.43 \end{pmatrix} \cdot \text{bar}$$

$$\omega := \begin{pmatrix} 0.252 \\ 0.194 \\ 0.191 \end{pmatrix}$$

$$Z_c := \begin{pmatrix} 0.270 \\ 0.275 \\ 0.277 \end{pmatrix}$$

$$V_c := \begin{pmatrix} 313.0 \\ 238.9 \\ 239.3 \end{pmatrix} \cdot \frac{\text{cm}^3}{\text{mol}}$$

$$T_n := \begin{pmatrix} 309.2 \\ 266.3 \\ 266.9 \end{pmatrix} \cdot \text{K}$$

$$P := \begin{pmatrix} 200 \\ 300 \\ 150 \end{pmatrix} \cdot \text{bar}$$

$$P_{\text{sat}} := \begin{pmatrix} 1.01325 \\ 1.01325 \\ 1.01325 \end{pmatrix} \cdot \text{bar}$$

$$T_r := \frac{T_n}{T_c}$$

$$T_r = \begin{pmatrix} 0.6583 \\ 0.6372 \\ 0.6355 \end{pmatrix}$$

$$P_r := \frac{P_{\text{sat}}}{P_c}$$

$$P_r = \begin{pmatrix} 0.0301 \\ 0.0253 \\ 0.0251 \end{pmatrix}$$

Calculate the fugacity coefficient at the nbp by Eq. (11.68):

(a)  $\text{PHIB}(T_{r1}, \Phi_{r1}, 1) = 0.9572$

(b)  $\text{PHIB}(T_{r2}, \Phi_{r2}, 2) = 0.9618$

(c)  $\text{PHIB}(T_{r3}, \Phi_{r3}, 3) = 0.9620$

Eq. (3.72):  $V_{\text{sat}} := \left[ V_c \cdot Z_c \left( 1 - T_r \right)^{0.2857} \right]$

Eq. (11.44):  $f := \left[ \text{PHIB}(T_r, \Phi_r, \cdot) \cdot P_{\text{sat}} \cdot \exp \left[ \frac{V_{\text{sat}} \cdot (P - P_{\text{sat}})}{R \cdot T_n} \right] \right]$

$$f = \begin{pmatrix} 2.445 \\ 3.326 \\ 1.801 \end{pmatrix} \text{ bar} \quad \text{Ans.}$$

11.24 (a) Chloroform:  $T_c := 536.4 \cdot \text{K}$        $P_c := 54.72 \cdot \text{bar}$        $\omega := 0.222$

$$Z_c := 0.293$$

$$V_c := 239.0 \cdot \frac{\text{cm}^3}{\text{mol}}$$

$$T_n := 334.3 \cdot \text{K}$$

$$P_{\text{sat}} := 22.27 \cdot \text{bar}$$

$$T := 473.15 \cdot \text{K}$$

$$T_r := \frac{T}{T_c}$$

$$T_r = 0.882$$

$$T_m := \frac{T_n}{T_c}$$

$$T_m = 0.623$$

Eq. (3.72):

$$V_{\text{sat}} := V_c \cdot Z_c \left( 1 - T_m \right)^{\frac{2}{7}}$$

$$V_{\text{sat}} = 94.41 \frac{\text{cm}^3}{\text{mol}}$$

Calculate fugacity coefficients by Eqs. (11.68):

$$P_r(P) := \frac{P}{P_c} \quad \phi(P) := \exp \left[ \frac{P_r(P)}{T_r} \cdot (B_0(T_r) + \omega \cdot B_1(T_r)) \right]$$

$$f(P) := \text{if} \left[ P \leq \phi P_{\text{sat}}, \phi(P) \cdot P, (P_{\text{sat}}) \cdot P_{\text{sat}} \cdot \exp \left[ \frac{V_{\text{sat}} \cdot (P - P_{\text{sat}})}{R \cdot T} \right] \right]$$

$$\phi(P) := \text{if} \left[ P \leq \phi P_{\text{sat}}, \phi(P), (P_{\text{sat}}) \cdot \frac{P_{\text{sat}}}{P} \cdot \exp \left[ \frac{V_{\text{sat}} \cdot (P - P_{\text{sat}})}{R \cdot T} \right] \right]$$

$P := 0 \cdot \text{bar}, 0.5 \cdot \text{bar} .. 40 \cdot \text{bar}$

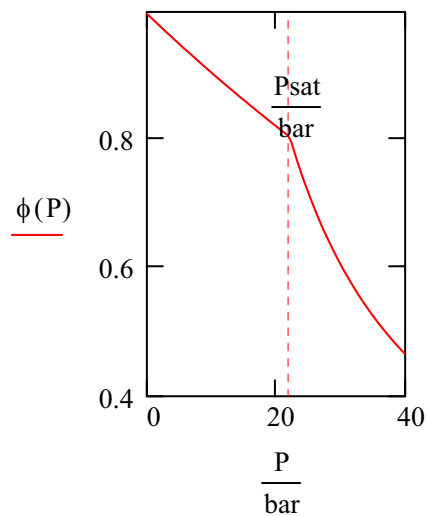
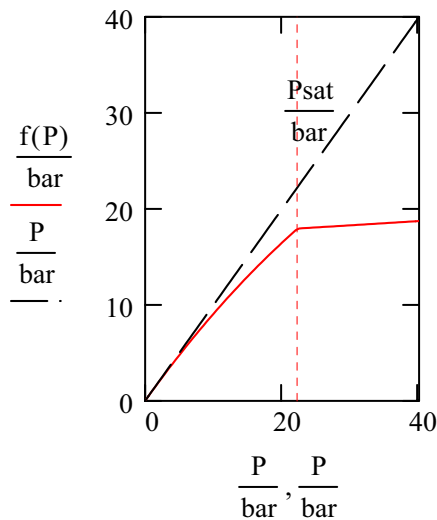

(b) Isobutane

$$T_c := 408.1 \cdot \text{K}$$

$$P_c := 36.48 \cdot \text{bar}$$

$$\omega := 0.181$$

$$Z_c := 0.282$$

$$V_c := 262.7 \cdot \frac{\text{cm}^3}{\text{mol}}$$

$$T_n := 261.4 \cdot \text{K}$$

$$P_{\text{sat}} := 5.28 \cdot \text{bar}$$

$$T := 313.15 \cdot \text{K}$$

$$T_r := \frac{T}{T_c}$$

$$T_r = 0.767$$

$$T_m := \frac{T_n}{T_c}$$

$$T_m = 0.641$$

Eq. (3.72):

$$V_{\text{sat}} := V_c \cdot Z_c \left( 1 - T_m \right)^{\frac{2}{7}}$$

$$V_{\text{sat}} = 102.107 \frac{\text{cm}^3}{\text{mol}}$$

Calculate fugacity coefficients by Eq. (11.68):

$$P_r(P) := \frac{P}{P_c} \quad \phi(P) := \exp \left[ \frac{P_r(P)}{T_r} \cdot (B_0(T_r) + \omega \cdot B_1(T_r)) \right]$$

$$f(P) := \text{if} \left[ P \leq P_{\text{sat}}, \phi(P) \cdot P, (P_{\text{sat}}) \cdot P_{\text{sat}} \cdot \exp \left[ \frac{V_{\text{sat}} \cdot (P - P_{\text{sat}})}{R \cdot T} \right] \right]$$

$$\phi(P) := \text{if} \left[ P \leq P_{\text{sat}}, \phi(P), (P_{\text{sat}}) \cdot \frac{P_{\text{sat}}}{P} \cdot \exp \left[ \frac{V_{\text{sat}} \cdot (P - P_{\text{sat}})}{R \cdot T} \right] \right]$$

P := 0·bar, 0.5·bar.. 10·bar

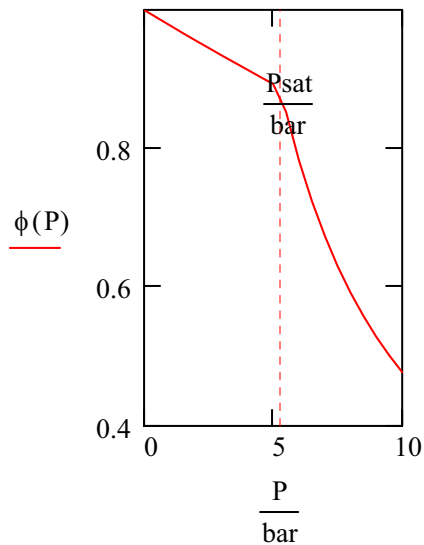
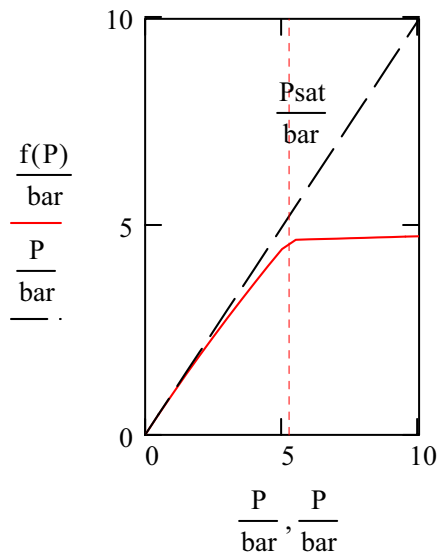

### 11.25 Ethylene = species 1; Propylene = species 2

$$T_c := \begin{pmatrix} 282.3 \\ 365.6 \end{pmatrix} \cdot \text{K}$$

$$P_c := \begin{pmatrix} 50.40 \\ 46.65 \end{pmatrix} \cdot \text{bar}$$

$$w := \begin{pmatrix} 0.087 \\ 0.140 \end{pmatrix}$$

$$Z_c := \begin{pmatrix} 0.281 \\ 0.289 \end{pmatrix}$$

$$V_c := \begin{pmatrix} 131.0 \\ 188.4 \end{pmatrix} \cdot \frac{\text{cm}^3}{\text{mol}}$$

$$T := 423.15 \cdot \text{K}$$

$$P := 30 \cdot \text{bar}$$

$$y_1 := 0.35$$

$$y_2 := 1 - y_1$$

$$n := 2$$

$$i := 1..n$$

$$j := 1..n$$

$$k := 1..n$$

By Eqs. (11.70) through (11.74)

$$\omega_{i,j} := \frac{w_i + w_j}{2} \quad T_{c_{i,j}} := \sqrt{T_{c_i} T_{c_j}} \quad Z_{c_{i,j}} := \frac{Z_{c_i} + Z_{c_j}}{2}$$

$$V_{c_{i,j}} := \left[ \frac{V_{c_i}^{\frac{1}{3}} + V_{c_j}^{\frac{1}{3}}}{2} \right]^3 \quad P_{c_{i,j}} := \frac{Z_{c_{i,j}} \cdot R \cdot T_{c_{i,j}}}{V_{c_{i,j}}}$$

$$T_{r_{i,j}} := \frac{T}{T_{c_{i,j}}}$$

$$T_r = \begin{pmatrix} 1.499 & 1.317 \\ 1.317 & 1.157 \end{pmatrix}$$

$$V_c = \begin{pmatrix} 131 & 157.966 \\ 157.966 & 188.4 \end{pmatrix} \frac{\text{cm}^3}{\text{mol}}$$

$$P_c = \begin{pmatrix} 50.345 & 48.189 \\ 48.189 & 46.627 \end{pmatrix} \text{bar}$$

$$\omega = \begin{pmatrix} 0.087 & 0.114 \\ 0.114 & 0.14 \end{pmatrix}$$

$$T_c = \begin{pmatrix} 282.3 & 321.261 \\ 321.261 & 365.6 \end{pmatrix} \text{K}$$

$$Z_c = \begin{pmatrix} 0.281 & 0.285 \\ 0.285 & 0.289 \end{pmatrix}$$

By Eqs. (3.65) and (3.66):

$$B_{0i,j} := B_0(T_{r_{i,j}})$$

$$B_{1i,j} := B_1(T_{r_{i,j}})$$

$$B_0 = \begin{pmatrix} -0.138 & -0.189 \\ -0.189 & -0.251 \end{pmatrix}$$

$$B_1 = \begin{pmatrix} 0.108 & 0.085 \\ 0.085 & 0.046 \end{pmatrix}$$

$$B_{i,j} := \frac{R \cdot T_{c_{i,j}}}{P_{c_{i,j}}} \cdot (B_{0i,j} + \omega_{i,j} \cdot B_{1i,j})$$

$$B = \begin{pmatrix} -59.892 & -99.181 \\ -99.181 & -159.43 \end{pmatrix} \frac{\text{cm}^3}{\text{mol}}$$

By Eq. (11.64):

$$\delta_{i,j} := 2 \cdot B_{i,j} - B_{i,i} - B_{j,j}$$

$$\delta = \begin{pmatrix} 0 & 20.96 \\ 20.96 & 0 \end{pmatrix} \frac{\text{cm}^3}{\text{mol}}$$

$$\hat{\phi}_k := \exp \left[ \frac{P}{R \cdot T} \cdot \left[ B_{k,k} + \frac{1}{2} \cdot \sum_i \sum_j [y_i \cdot y_j \cdot (\delta_{i,k} - \delta_{i,j})] \right] \right]$$

$$\hat{f}_k := \hat{\phi}_k \cdot y_k \cdot P \quad \hat{\phi} = \begin{pmatrix} 0.957 \\ 0.875 \end{pmatrix}$$

$$\hat{f} = \begin{pmatrix} 10.053 \\ 17.059 \end{pmatrix} \text{bar}$$

Ans.



For an *ideal solution*,  $\phi_{id} = \phi$  pure species

$$P_{r,k} := \frac{P}{P_{c,k}} \quad P_r = \begin{pmatrix} 0.595 \\ 0.643 \end{pmatrix} \quad \phi_{id,k} := \exp \left[ \frac{P_{r,k}}{T_{r,k,k}} \cdot (\beta_{0,k,k} + \omega_{k,k} \cdot B_{1,k,k}) \right]$$

$$\hat{f}_{at_{id},k} := \phi_{id,k} \cdot y_k \cdot P \quad \phi_{id} = \begin{pmatrix} 0.95 \\ 0.873 \end{pmatrix} \quad \hat{f}_{at_{id}} = \begin{pmatrix} 9.978 \\ 17.022 \end{pmatrix} \text{ bar} \quad \text{Ans.}$$

Alternatively,

$$P_{r,i,j} := \frac{P}{P_{c,i,j}} \quad \phi_{id,k} := \exp \left[ \frac{P_{r,k,k}}{T_{r,k,k}} \cdot (\beta_{0,k,k} + \omega_{k,k} \cdot B_{1,k,k}) \right] \quad \phi_{id} = \begin{pmatrix} 0.95 \\ 0.873 \end{pmatrix}$$

**11.27 Methane = species 1**  
**Ethane = species 2**  
**Propane = species 3**

$$T := 373.15 \cdot \text{K}$$

$$P := 35 \cdot \text{bar}$$

$$y := \begin{pmatrix} 0.21 \\ 0.43 \\ 0.36 \end{pmatrix}$$

$$w := \begin{pmatrix} 0.012 \\ 0.100 \\ 0.152 \end{pmatrix}$$

$$Z_c := \begin{pmatrix} 0.286 \\ 0.279 \\ 0.276 \end{pmatrix}$$

$$T_c := \begin{pmatrix} 190.6 \\ 305.3 \\ 369.8 \end{pmatrix} \cdot \text{K}$$

$$P_c := \begin{pmatrix} 45.99 \\ 48.72 \\ 42.48 \end{pmatrix} \cdot \text{bar}$$

$$V_c := \begin{pmatrix} 98.6 \\ 145.5 \\ 200.0 \end{pmatrix} \cdot \frac{\text{cm}^3}{\text{mol}}$$

$$n := 3$$

$$i := 1..n$$

$$j := 1..n$$

$$k := 1..n$$

By Eqs. (11.70) through (11.74)

$$\omega_{i,j} := \frac{w_i + w_j}{2}$$

$$T_{c,i,j} := \sqrt{T_{c,i} \cdot T_{c,j}}$$

$$Z_{c,i,j} := \frac{Z_{c,i} + Z_{c,j}}{2}$$

$$V_{c,i,j} := \left[ \frac{V_{c,i}^{\frac{1}{3}} + V_{c,j}^{\frac{1}{3}}}{2} \right]^3$$

$$P_{c,i,j} := \frac{Z_{c,i,j} \cdot R \cdot T_{c,i,j}}{V_{c,i,j}}$$

$$T_{r,i,j} := \frac{T}{T_{c,i,j}} \quad T_r = \begin{pmatrix} 1.958 & 1.547 & 1.406 \\ 1.547 & 1.222 & 1.111 \\ 1.406 & 1.111 & 1.009 \end{pmatrix}$$

$$V_c = \begin{pmatrix} 98.6 & 120.533 & 143.378 \\ 120.533 & 145.5 & 171.308 \\ 143.378 & 171.308 & 200 \end{pmatrix} \frac{\text{cm}^3}{\text{mol}}$$

$$P_c = \begin{pmatrix} 45.964 & 47.005 & 43.259 \\ 47.005 & 48.672 & 45.253 \\ 43.259 & 45.253 & 42.428 \end{pmatrix} \text{bar}$$

$$\omega = \begin{pmatrix} 0.012 & 0.056 & 0.082 \\ 0.056 & 0.1 & 0.126 \\ 0.082 & 0.126 & 0.152 \end{pmatrix}$$

$$T_c = \begin{pmatrix} 190.6 & 241.226 & 265.488 \\ 241.226 & 305.3 & 336.006 \\ 265.488 & 336.006 & 369.8 \end{pmatrix} \text{K}$$

$$Z_c = \begin{pmatrix} 0.286 & 0.282 & 0.281 \\ 0.282 & 0.279 & 0.278 \\ 0.281 & 0.278 & 0.276 \end{pmatrix}$$

By Eqs. (3.65) and (3.66):

$$B_{0i,j} := B_0(T_{r,i,j})$$

$$B_{1i,j} := B_1(T_{r,i,j})$$

$$B_{i,j} := \frac{R \cdot T_{c,i,j}}{P_{c,i,j}} \cdot (B_{0i,j} + \omega_{i,j} \cdot B_{1i,j})$$

By Eq. (11.64):

$$\delta_{i,j} := 2 \cdot B_{i,j} - B_{i,i} - B_{j,j} \quad \delta = \begin{pmatrix} 0 & 30.442 & 107.809 \\ 30.442 & 0 & 23.482 \\ 107.809 & 23.482 & 0 \end{pmatrix} \frac{\text{cm}^3}{\text{mol}}$$

$$\phi_{\text{hat}_k} := \exp \left[ \frac{P}{R \cdot T} \cdot \left[ B_{k,k} + \frac{1}{2} \cdot \sum_i \sum_j [y_i \cdot y_j \cdot (\delta_{i,k} - \delta_{i,j})] \right] \right]$$

$$f_{\text{hat}_k} := \phi_{\text{hat}_k} \cdot y_k \cdot P$$

$$\phi_{\text{hat}} = \begin{pmatrix} 1.019 \\ 0.881 \\ 0.775 \end{pmatrix}$$

$$f_{\text{hat}} = \begin{pmatrix} 7.491 \\ 13.254 \\ 9.764 \end{pmatrix} \text{bar}$$

Ans.

For an *ideal solution*,  $\phi_{id} = \phi$  pure species

$$Pr_k := \frac{P}{P_{c,k}} \quad Pr = \begin{pmatrix} 0.761 \\ 0.718 \\ 0.824 \end{pmatrix} \quad \phi_{id,k} := \exp \left[ \frac{Pr_k}{T_{r,k,k}} \cdot (B_{0,k,k} + \omega_{k,k} \cdot B_{1,k,k}) \right]$$

$$\hat{\phi}_{id,k} := \phi_{id,k} \cdot y_k \cdot P \quad \phi_{id} = \begin{pmatrix} 0.977 \\ 0.88 \\ 0.759 \end{pmatrix} \quad \hat{\phi}_{id} = \begin{pmatrix} 7.182 \\ 13.251 \\ 9.569 \end{pmatrix} \text{ bar} \quad \text{Ans.}$$

11.28 Given:  $\frac{GE}{RT} = (-)2.6 \cdot x_1 - 1.8 \cdot x_2 \cdot x_1 \cdot x_2$

(a) Substitute  $x_2 = 1 - x_1$ :

$$\frac{GE}{RT} = (-)0.8 \cdot x_1 - 1.8 \cdot x_1 \cdot (1 - x_1) = -1.8 \cdot x_1 + x_1^2 + 0.8 \cdot x_1^3$$

Apply Eqs. (11.15) & (11.16) for  $M = GE/RT$ :

$$\ln \gamma_1 = \frac{GE}{RT} + (1 - x_1) \cdot \frac{d\left(\frac{GE}{RT}\right)}{dx_1} \quad \ln \gamma_2 = \frac{GE}{RT} - x_1 \cdot \frac{d\left(\frac{GE}{RT}\right)}{dx_1}$$

$$\frac{d\left(\frac{GE}{RT}\right)}{dx_1} = -1.8 + 2 \cdot x_1 + 2.4 \cdot x_1^2$$

$$\ln \gamma_1 = -1.8 + 2 \cdot x_1 + 1.4 \cdot x_1^2 - 1.6 \cdot x_1^3$$

$$\ln \gamma_2 = -x_1^2 - 1.6 \cdot x_1^3$$

Ans.

(b) Apply Eq. (11.100):

$$\frac{GE}{RT} = x_1 \cdot (-)1.8 + 2 \cdot x_1 + 1.4 \cdot x_1^2 - 1.6 \cdot x_1^3 \dots + (1 - x_1) \cdot (-)x_1^2 - 1.6 \cdot x_1^3$$

This reduces to the initial condition:

(c) Divide Gibbs/Duhem eqn. (11.100) by  $dx_1$ :

$$x_1 \cdot \frac{d(\ln \gamma_1)}{dx_1} + x_2 \cdot \frac{d(\ln \gamma_2)}{dx_1} = 0$$

Differentiate answers to Part (a):

$$\frac{d(\ln \gamma_1)}{dx_1} = 2 + 2.8 \cdot x_1 - 4.8 \cdot x_1^2 \qquad \frac{d(\ln \gamma_2)}{dx_1} = -2 \cdot x_1 - 4.8 \cdot x_1^2$$

$$x_1 \cdot \frac{d(\ln \gamma_1)}{dx_1} = 2 \cdot x_1 + 2.8 \cdot x_1^2 - 4.8 \cdot x_1^3$$

$$x_2 \cdot \frac{d(\ln \gamma_2)}{dx_1} = (1 - x_1) \cdot (-2 \cdot x_1 - 4.8 \cdot x_1^2)$$

These two equations sum to zero in agreement with the Gibbs/Duhem equation.

(d) When  $x_1 = 1$ , we see from the 2nd eq. of Part (c) that

$$\frac{d(\ln \gamma_1)}{dx_1} = 0 \quad \text{Q.E.D.}$$

When  $x_1 = 0$ , we see from the 3rd eq. of Part (c) that

$$\frac{d(\ln \gamma_2)}{dx_1} = 0 \quad \text{Q.E.D.}$$

(e) DEFINE:  $g = GE/RT$

$$g(x_1) := -1.8 \cdot x_1 + x_1^2 + 0.8 \cdot x_1^3$$

$$\ln \gamma_1(x_1) := -1.8 + 2 \cdot x_1 + 1.4 \cdot x_1^2 - 1.6 \cdot x_1^3$$

$$\ln \gamma_2(x_1) := -x_1^2 - 1.6 \cdot x_1^3$$

$$\ln \gamma_1(0) = -1.8$$

$$\ln \gamma_2(1) = -2.6$$

$$x_1 := 0, 0.1 \dots 1.0$$

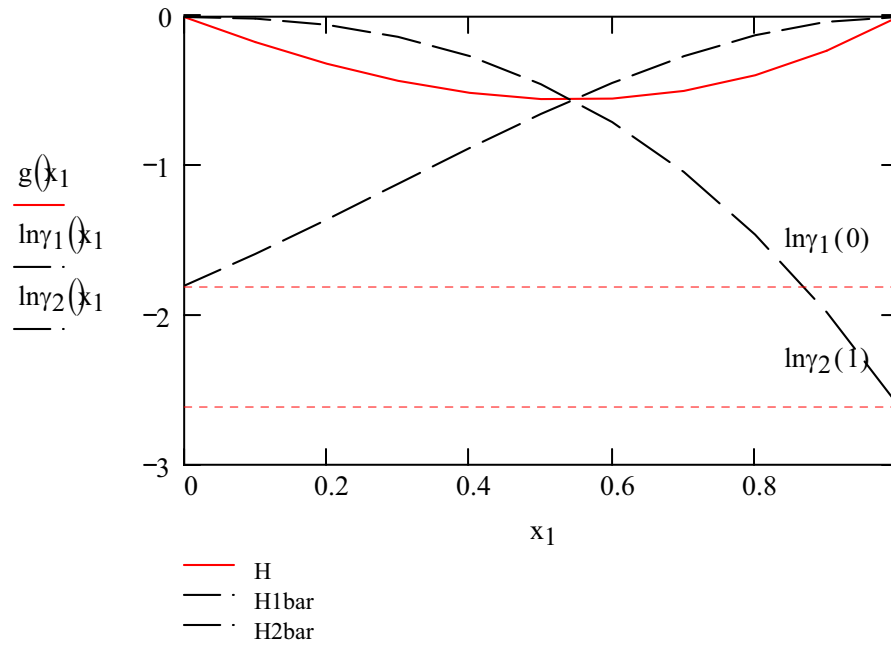

11.32

$x_1 :=$	( 0.02715 )	( 87.5 )
	0.09329	265.6
	0.17490	417.4
	0.32760	534.5
	0.40244	531.7
	0.56689	421.1
	0.63128	347.1
	0.66233	321.7
	0.69984	276.4
	0.72792	252.9
	0.77514	190.7
	0.79243	178.1
	0.82954	138.4
	0.86835	98.4
	0.93287	37.6
	( 0.98233 )	( 10.0 )

$n := \text{rows}(x_1) \quad i := 1..n$

$x_1 := 0, 0.01..1$

(a) **Guess:**     $a := -3000$      $b := -3000$      $c := 250$

$$F(x_1) := \begin{bmatrix} x_1 \cdot (1 - x_1) \\ x_1^2 \cdot (1 - x_1) \\ x_1^3 \cdot (1 - x_1) \end{bmatrix} \begin{pmatrix} a \\ b \\ c \end{pmatrix} := \text{linfit}(x_1, VE, F) \quad \begin{pmatrix} a \\ b \\ c \end{pmatrix} = \begin{pmatrix} 3.448 \times 10^3 \\ -3.202 \times 10^3 \\ 244.615 \end{pmatrix} \quad \text{Ans.}$$

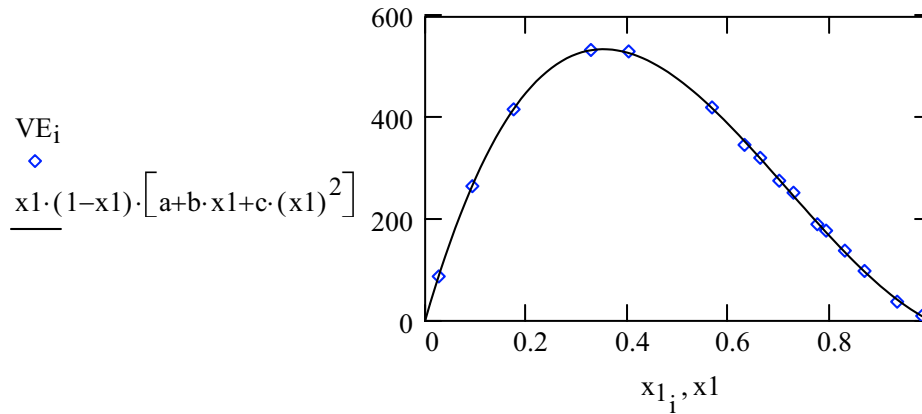

**By definition of the excess properties**

$$V^E = x_1 \cdot x_2 \cdot [a + b \cdot x_1 + c \cdot (x_1)^2]$$

$$\frac{d}{dx_1} V^E = -4 \cdot c \cdot (x_1)^3 + 3 \cdot (c - b) \cdot (x_1)^2 + 2 \cdot (b - a) \cdot x_1 + a$$

$$(V_{\text{bar}_1})^E = (x_2)^2 \cdot [a + 2 \cdot b \cdot x_1 + 3 \cdot c \cdot (x_1)^2]$$

$$(V_{\text{bar}_2})^E = (x_1)^2 \cdot [a - b + 2 \cdot (b - c) \cdot x_1 + 3 \cdot c \cdot (x_1)^2]$$

(b) **To find the maximum, set  $dV^E/dx_1 = 0$  and solve for  $x_1$ . Then use  $x_1$  to find  $V_{\text{max}}^E$ .**

**Guess:**     $x_1 := 0.5$

Given

$$-4 \cdot c \cdot (x_1)^3 + 3 \cdot (c - b) \cdot (x_1)^2 + 2 \cdot (b - a) \cdot x_1 + a = 0$$

$x_1 := \text{Find}(x_1)$      $x_1 = 0.353$     **Ans.**

$$V_{E_{\max}} := x_1 \cdot (1 - x_1) \cdot (a + b \cdot x_1 + c \cdot x_1^2) \quad V_{E_{\max}} = 536.294 \quad \text{Ans.}$$

$$(c) \quad V_{E_{\text{bar}_1}}(x_1) := (1 - x_1)^2 \cdot [a + 2 \cdot b \cdot x_1 + 3 \cdot c \cdot (x_1)^2]$$

$$V_{E_{\text{bar}_2}}(x_1) := (x_1)^2 \cdot [a - b + 2 \cdot (b - c) \cdot x_1 + 3 \cdot c \cdot (x_1)^2]$$

$$x_1 := 0, 0.01 \dots 1$$

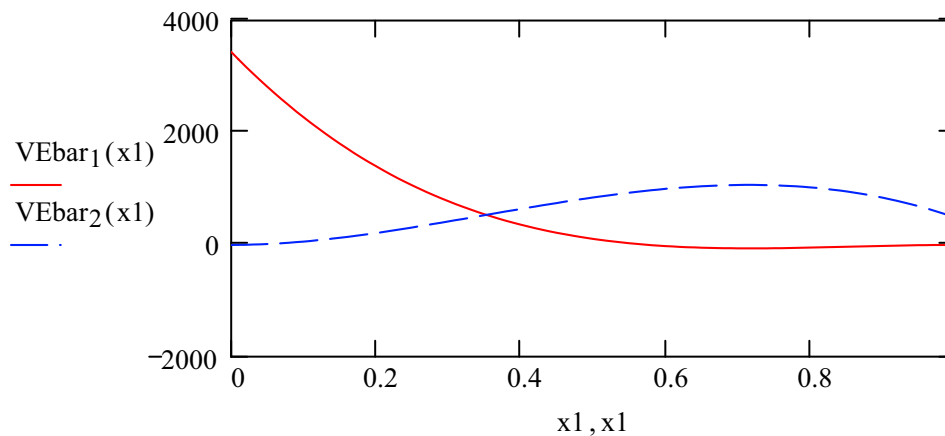

#### Discussion:

- Partial property for species  $i$  goes to zero WITH ZERO SLOPE as  $x_i \rightarrow 1$ .
- Interior extrema come in pairs:  $V_{E_{\text{bar}_1}}^{\text{min}}$  for species 1 occurs at the same  $x_1$  as  $V_{E_{\text{bar}_2}}^{\text{max}}$  for species 2, and both occur at an inflection point on the  $V^E$  vs.  $x_1$  plot.
- At the point where the  $V_{E_{\text{bar}_i}}$  lines cross, the  $V^E$  plot shows a maximum.

#### 11.33 Propane = 1; n-Pentane = 2

$$T := (75 + 273.15) \cdot \text{K}$$

$$P := 2 \cdot \text{bar}$$

$$y_1 := 0.5$$

$$y_2 := 1 - y_1$$

$$B := \begin{pmatrix} -276 & -466 \\ -466 & -809 \end{pmatrix} \cdot \frac{\text{cm}^3}{\text{mol}}$$

$$n := 2$$

$$i := 1 \dots n$$

$$j := 1 \dots n$$

By Eq. (11.61):

$$B := \sum_i \sum_j (y_i \cdot y_j \cdot B_{i,j})$$

$$B = -504.25 \frac{\text{cm}^3}{\text{mol}}$$

Use a spline fit of B as a function of T to find derivatives:

$$b_{11} := \begin{pmatrix} -331 \\ -276 \\ -235 \end{pmatrix} \cdot \frac{\text{cm}^3}{\text{mol}}$$

$$b_{22} := \begin{pmatrix} -980 \\ -809 \\ -684 \end{pmatrix} \cdot \frac{\text{cm}^3}{\text{mol}}$$

$$b_{12} := \begin{pmatrix} -558 \\ -466 \\ -399 \end{pmatrix} \cdot \frac{\text{cm}^3}{\text{mol}}$$

$$t := \begin{pmatrix} 50 \\ 75 \\ 100 \end{pmatrix} + 273.15 \cdot \text{K}$$

$$t = \begin{pmatrix} 323.15 \\ 348.15 \\ 373.15 \end{pmatrix} \text{K}$$

$$vs_{11} := \text{lspline}(t, b_{11}) \quad B_{11}(T) := \text{interp}(vs_{11}, t, b_{11}, T) \quad B_{11}(T) = -276 \frac{\text{cm}^3}{\text{mol}}$$

$$vs_{22} := \text{lspline}(t, b_{22}) \quad B_{22}(T) := \text{interp}(vs_{22}, t, b_{22}, T) \quad B_{22}(T) = -809 \frac{\text{cm}^3}{\text{mol}}$$

$$vs_{12} := \text{lspline}(t, b_{12}) \quad B_{12}(T) := \text{interp}(vs_{12}, t, b_{12}, T) \quad B_{12}(T) = -466 \frac{\text{cm}^3}{\text{mol}}$$

$$dBdT := \begin{pmatrix} \frac{d}{dT} B_{11}(T) & \frac{d}{dT} B_{12}(T) \\ \frac{d}{dT} B_{12}(T) & \frac{d}{dT} B_{22}(T) \end{pmatrix} \quad dBdT = \begin{pmatrix} 1.92 & 3.18 \\ 3.18 & 5.92 \end{pmatrix} \frac{\text{cm}^3}{\text{mol} \cdot \text{K}}$$

**Differentiate Eq. (11.61):**  $dBdT := \sum_i \sum_j (y_i \cdot y_j \cdot dBdT_i) \quad dBdT = 3.55 \frac{\text{cm}^3}{\text{mol} \cdot \text{K}}$

**By Eq. (3.38):**  $Z := 1 + \frac{B \cdot P}{R \cdot T} \quad Z = 0.965 \quad V := \frac{Z \cdot R \cdot T}{P}$

**By Eq. (6.55):**  $HRRT := \frac{P}{R} \cdot \left( \frac{B}{T} - dBdT \right) \quad HRRT = -0.12 \quad HR := HRRT \cdot R \cdot T$

**By Eq. (6.56):**  $SRR := -\frac{P}{R} \cdot dBdT \quad SRR = -0.085 \quad SR := SRR \cdot R$

$$V = 13968 \frac{\text{cm}^3}{\text{mol}}$$

$$HR = -348.037 \frac{\text{J}}{\text{mol}}$$

$$SR = -0.71 \frac{\text{J}}{\text{mol} \cdot \text{K}}$$

Ans.



**11.34 Propane = 1; n-Pentane = 2**

$$T := (75 + 273.15) \cdot K$$

$$P := 2 \cdot \text{bar}$$

$$y_1 := 0.5$$

$$y_2 := 1 - y_1$$

$$B := \begin{pmatrix} -276 & -466 \\ -466 & -809 \end{pmatrix} \cdot \frac{\text{cm}^3}{\text{mol}}$$

$$n := 2 \quad i := 1..n$$

$$j := 1..n$$

$$\delta_{i,j} := 2 \cdot B_{i,j} - B_{i,i} - B_{j,j}$$

By Eqs. (11.63a) and (11.63b):

$$\hat{\phi}_1(y_1) := \exp \left[ \frac{P}{R \cdot T} \cdot \left[ B_{1,1} + (1 - y_1)^2 \cdot \delta_{1,2} \right] \right]$$

$$\hat{\phi}_2(y_1) := \exp \left[ \frac{P}{R \cdot T} \cdot \left( B_{2,2} + y_1^2 \cdot \delta_{1,2} \right) \right]$$

$$y_1 := 0, 0.1..1.0$$

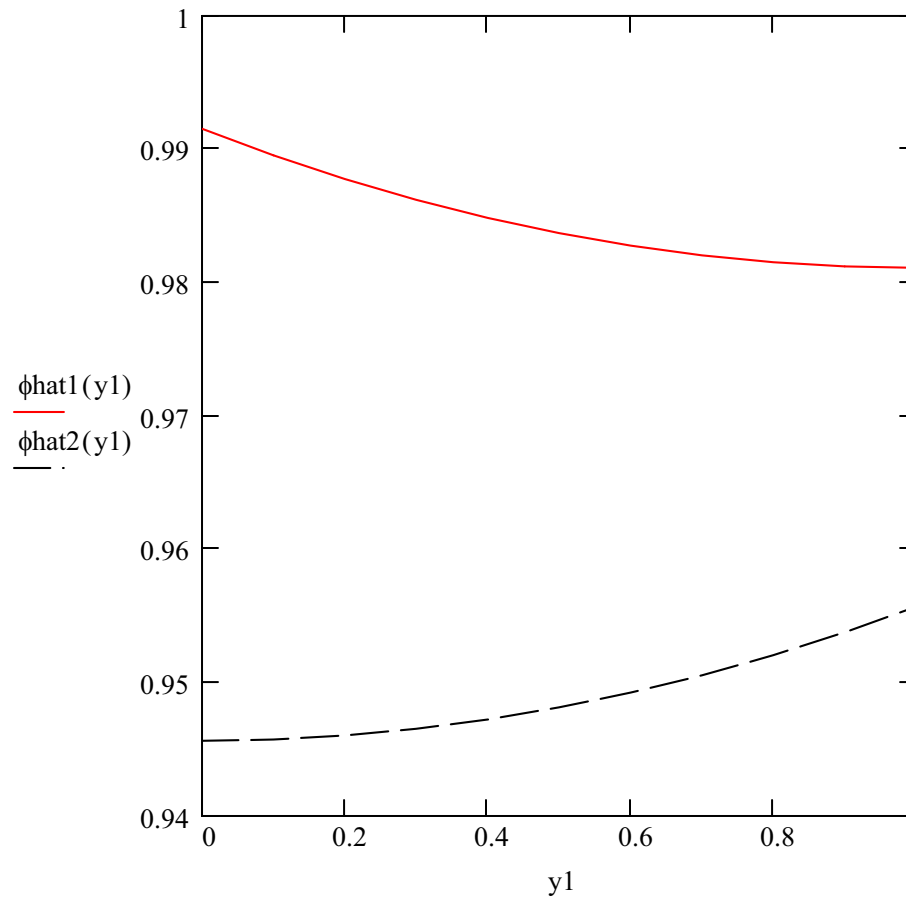

11.36

$x_1 :=$

0.0426
0.0817
0.1177
0.1510
0.2107
0.2624
0.3472
0.4158
0.5163
0.6156
0.6810
0.7621
0.8181
0.8650
0.9276
0.9624

$HE :=$

-23.3
-45.7
-66.5
-86.6
-118.2
-144.6
-176.6
-195.7
-204.2
-191.7
-174.1
-141.0
-116.8
-85.6
-43.5
-22.6

$n := \text{rows}(x_1) \quad i := 1..n$   
 $x_1 := 0, 0.01..1$

(a) **Guess:**  $a := -500 \quad b := -100 \quad c := 0.01$

$$F(x_1) := \begin{bmatrix} x_1 \cdot (1 - x_1) \\ x_1^2 \cdot (1 - x_1) \\ x_1^3 \cdot (1 - x_1) \end{bmatrix} \begin{pmatrix} a \\ b \\ c \end{pmatrix} := \text{linfit}(x_1, HE, F) \quad \begin{pmatrix} a \\ b \\ c \end{pmatrix} = \begin{pmatrix} -539.653 \\ -1.011 \times 10^3 \\ 913.122 \end{pmatrix} \quad \text{Ans.}$$

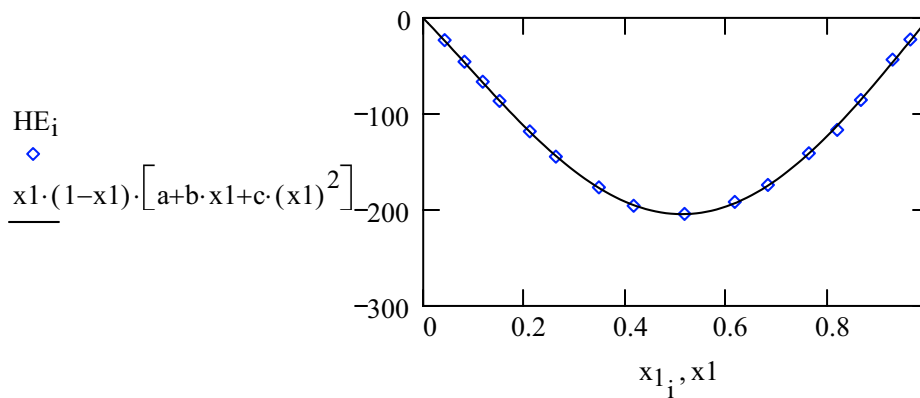

**By definition of the excess properties**

$$H^E = x_1 \cdot x_2 \cdot [a + b \cdot x_1 + c \cdot (x_1)^2]$$

$$\frac{d}{dx_1} H^E = -4 \cdot c \cdot (x_1)^3 + 3 \cdot (c - b) \cdot (x_1)^2 + 2 \cdot (b - a) \cdot x_1 + a$$

$$(H\bar{b}_1)^E = (x_2)^2 \cdot [a + 2 \cdot b \cdot x_1 + 3 \cdot c \cdot (x_1)^2]$$

$$(H\bar{b}_2)^E = (x_1)^2 \cdot [a - b + 2 \cdot (b - c) \cdot x_1 + 3 \cdot c \cdot (x_1)^2]$$

**(b) To find the minimum, set  $dH^E/dx_1 = 0$  and solve for  $x_1$ . Then use  $x_1$  to find  $H^E_{\min}$ .**

**Guess:**  $x_1 := 0.5$        $HE(x_1) := x_1 \cdot (1 - x_1) \cdot (a + b \cdot x_1 + c \cdot x_1^2)$

Given  $-4 \cdot c \cdot (x_1)^3 + 3 \cdot (c - b) \cdot (x_1)^2 + 2 \cdot (b - a) \cdot x_1 + a = 0$

$x_1 := \text{Find}(x_1)$        $x_1 = 0.512$       **Ans.**

$HE_{\min} := x_1 \cdot (1 - x_1) \cdot (a + b \cdot x_1 + c \cdot x_1^2)$        $HE_{\min} = -204.401$       **Ans.**

**(c)**  $HE\bar{b}_1(x_1) := HE(x_1) + (1 - x_1) \cdot \frac{d}{dx_1} HE(x_1)$

$$HE\bar{b}_2(x_1) := HE(x_1) - x_1 \cdot \left( \frac{d}{dx_1} HE(x_1) \right)$$

$x_1 := 0, 0.01 .. 1$

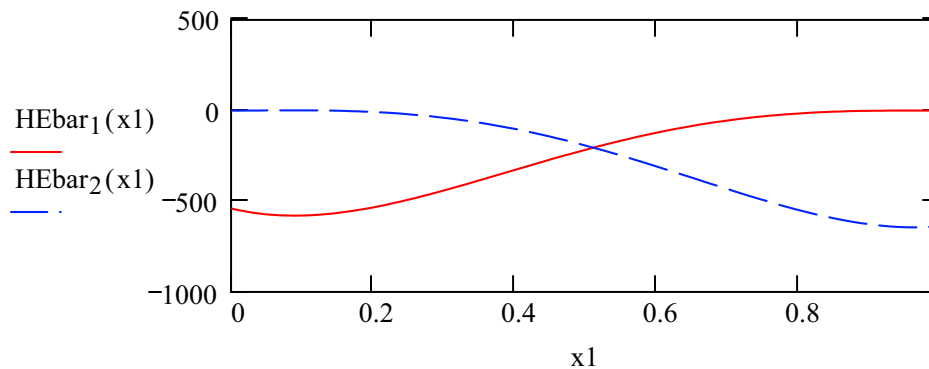

**Discussion:**

- a) Partial property for species i goes to zero WITH ZERO SLOPE as  $x_i \rightarrow 1$ .
- b) Interior extrema come in pairs:  $H^E$  min for species 1 occurs at the same  $x_1$  as  $H^E$  max for species 2, and both occur at an inflection point on the  $H^E$  vs.  $x_1$  plot.
- c) At the point where the  $H^E$  lines cross, the  $H^E$  plot shows a minimum.

11.37 (a) (1) = Acetone (2) = 1,3-butadiene

$$y_1 := 0.28 \quad y_2 := 1 - y_1 \quad T := (60 + 273.15) \cdot K \quad P := 170 \cdot \text{kPa}$$

$$w := \begin{pmatrix} 0.307 \\ 0.190 \end{pmatrix} \quad T_c := \begin{pmatrix} 508.2 \\ 425.2 \end{pmatrix} \cdot K \quad Z_c := \begin{pmatrix} 0.233 \\ 0.267 \end{pmatrix} \quad V_c := \begin{pmatrix} 209 \\ 220.4 \end{pmatrix} \cdot \frac{\text{cm}^3}{\text{mol}}$$

$$n := 2 \quad i := 1..n \quad j := 1..n \quad k_{i,j} := 0$$

Eq. (11.70)  $\omega_{i,j} := \frac{w_i + w_j}{2}$

$$\omega = \begin{pmatrix} 0.307 & 0.2485 & 0.082 \\ 0.2485 & 0.19 & 0.126 \\ 0.082 & 0.126 & 0.152 \end{pmatrix}$$

Eq. (11.71)  $T_{c_{i,j}} := \sqrt{T_{c_i} \cdot T_{c_j}} \cdot (1 - k_{i,j})$

$$T_c = \begin{pmatrix} 508.2 & 464.851 \\ 464.851 & 425.2 \\ 369.8 & 0 \end{pmatrix} K$$

Eq. (11.73)  $Z_{c_{i,j}} := \frac{Z_{c_i} + Z_{c_j}}{2}$

$$Z_c = \begin{pmatrix} 0.233 & 0.25 \\ 0.25 & 0.267 \\ 0.276 & 0 \end{pmatrix}$$

Eq. (11.74)  $V_{c_{i,j}} := \left[ \frac{\left( \frac{1}{V_{c_i}} \right)^{\frac{1}{3}} + \left( \frac{1}{V_{c_j}} \right)^{\frac{1}{3}}}{2} \right]^3$

$$V_c = \begin{pmatrix} 209 & 214.65 \\ 214.65 & 220.4 \\ 200 & 0 \end{pmatrix} \frac{\text{cm}^3}{\text{mol}}$$

Eq. (11.72)  $P_{c_{i,j}} := \frac{Z_{c_{i,j}} \cdot R \cdot T_{c_{i,j}}}{V_{c_{i,j}}}$

$$P_c = \begin{pmatrix} 47.104 & 45.013 \\ 45.013 & 42.826 \\ 42.48 & 0 \end{pmatrix} \text{bar}$$

**Note: the calculated pure species  $P_c$  values in the matrix above do not agree exactly with the values in Table B.1 due to round-off error in the calculations.**

$$Tr_{i,j} := \frac{T}{T_{c_{i,j}}}$$

$$Pr_{i,j} := \frac{P}{P_{c_{i,j}}}$$

$$Tr = \begin{pmatrix} 0.656 & 0.717 \\ 0.717 & 0.784 \end{pmatrix}$$

$$Pr = \begin{pmatrix} 0.036 & 0.038 \\ 0.038 & 0.04 \\ 0.824 & 0 \end{pmatrix}$$

**Eq. (3.65)**  $B_{0i,j} := B_0(Tr_{i,j})$

$$B_0 = \begin{pmatrix} -0.74636 & -0.6361 & -0.16178 \\ -0.6361 & -0.5405 & -0.27382 \\ -0.16178 & -0.27382 & -0.33295 \end{pmatrix}$$

**Eq. (3.66)**  $B_{1i,j} := B_1(Tr_{i,j})$

$$B_1 = \begin{pmatrix} -0.874 & -0.558 & 0.098 \\ -0.558 & -0.34 & 0.028 \\ 0.098 & 0.028 & -0.027 \end{pmatrix}$$

**Eq. (11.69a) + (11.69b)**  $B_{i,j} := \frac{R \cdot T_{c_{i,j}}}{P_{c_{i,j}}} \cdot (B_{0i,j} + \omega_{i,j} \cdot B_{1i,j})$

$$B = \begin{pmatrix} -910.278 & -665.188 \\ -665.188 & -499.527 \end{pmatrix} \frac{\text{cm}^3}{\text{mol}}$$

**Eq. (11.61)**  $B := \sum_{i=1}^n \sum_{j=1}^n (y_i \cdot y_j \cdot B_{i,j})$   $B = -598.524 \frac{\text{cm}^3}{\text{mol}}$

**Eq. (3.38)**  $Z := 1 + \frac{B \cdot P}{R \cdot T}$

$$Z = 0.963$$

$$V := \frac{R \cdot T \cdot Z}{P}$$

$$V = 1.5694 \times 10^4 \frac{\text{cm}^3}{\text{mol}} \quad \text{Ans.}$$

**Eq. (6.89)**  $dB_{0d}Tr_{i,j} := \frac{0.675}{(Tr_{i,j})^{2.6}}$

**Eq. (6.90)**  $dB_{1d}Tr_{i,j} := \frac{0.722}{(Tr_{i,j})^{5.2}}$

Differentiating Eq. (11.61) and using Eq. (11.69a) + (11.69b)

$$dBdT := \sum_{i=1}^n \sum_{j=1}^n \left[ y_i \cdot y_j \left[ \frac{R}{P c_{i,j}} \cdot (dB_0 dTr_{i,j} + \omega_{i,j} \cdot dB_1 dTr_{i,j}) \right] \right]$$

Eq. (6.55)  $HR := P \cdot T \cdot \left( \frac{B}{T} - dBdT \right)$  HR =  $-344.051 \frac{J}{mol}$  **Ans.**

Eq. (6.56)  $SR := -P \cdot dBdT$  SR =  $-0.727 \frac{J}{mol \cdot K}$  **Ans.**

Eq. (6.54)  $GR := B \cdot P$  GR =  $-101.7 \frac{J}{mol}$  **Ans.**

(b)  $V = 15694 \cdot \frac{cm^3}{mol}$  HR =  $-450.322 \cdot \frac{J}{mol}$

$SR = -1.006 \cdot \frac{J}{mol \cdot K}$  GR =  $-125.1 \cdot \frac{J}{mol}$

(c)  $V = 24255 \cdot \frac{cm^3}{mol}$  HR =  $-175.666 \cdot \frac{J}{mol}$

$SR = -0.41 \cdot \frac{J}{mol \cdot K}$  GR =  $-53.3 \cdot \frac{J}{mol}$

(d)  $V = 80972 \cdot \frac{cm^3}{mol}$  HR =  $-36.48 \cdot \frac{J}{mol}$

$SR = -0.097 \cdot \frac{J}{mol \cdot K}$  GR =  $-8.1 \cdot \frac{J}{mol}$

(e)  $V = 56991 \cdot \frac{cm^3}{mol}$  HR =  $-277.96 \cdot \frac{J}{mol}$

$SR = -0.647 \cdot \frac{J}{mol \cdot K}$  GR =  $-85.2 \cdot \frac{J}{mol}$

**Data for Problems 11.38 - 11.40**

$$T := \begin{pmatrix} 325 \\ 200 \\ 575 \\ 350 \\ 300 \\ 525 \\ 225 \\ 200 \end{pmatrix} \quad P := \begin{pmatrix} 15 \\ 100 \\ 40 \\ 35 \\ 50 \\ 10 \\ 25 \\ 75 \end{pmatrix} \quad T_c := \begin{pmatrix} 308.3 \\ 150.9 \\ 562.2 \\ 304.2 \\ 282.3 \\ 507.6 \\ 190.6 \\ 126.2 \end{pmatrix} \quad P_c := \begin{pmatrix} 61.39 \\ 48.98 \\ 48.98 \\ 73.83 \\ 50.40 \\ 30.25 \\ 45.99 \\ 34.00 \end{pmatrix} \quad \omega := \begin{pmatrix} .187 \\ .000 \\ .210 \\ .224 \\ .087 \\ .301 \\ .012 \\ .038 \end{pmatrix}$$

$$Tr := \frac{T}{T_c} \rightarrow Tr = \begin{pmatrix} 1.054 \\ 1.325 \\ 1.023 \\ 1.151 \\ 1.063 \\ 1.034 \\ 1.18 \\ 1.585 \end{pmatrix} \quad Pr := \frac{P}{P_c} \rightarrow Pr = \begin{pmatrix} 0.244 \\ 2.042 \\ 0.817 \\ 0.474 \\ 0.992 \\ 0.331 \\ 0.544 \\ 2.206 \end{pmatrix}$$

**11.38 Redlich/Kwong Equation:**

$\Omega := 0.08664$

$\Psi := 0.42748$

$$\beta\Omega = \left( \frac{Pr}{Tr} \right) \text{ Eq. (3.53)} \quad \beta = \begin{pmatrix} 0.02 \\ 0.133 \\ 0.069 \\ 0.036 \\ 0.081 \\ 0.028 \\ 0.04 \\ 0.121 \end{pmatrix} \quad q := \left( \frac{\Psi}{\Omega \cdot Tr^{1.5}} \right) \text{ Eq. (3.54)} \quad q = \begin{pmatrix} 4.559 \\ 3.234 \\ 4.77 \\ 3.998 \\ 4.504 \\ 4.691 \\ 3.847 \\ 2.473 \end{pmatrix}$$

**Guess:**  $z := 1$

Given  $z = 1 + \beta - q \cdot \beta \cdot \frac{z - \beta}{z \cdot (z + \beta)}$  Eq. (3.52)  $Z(\beta, q) := \text{Find}(z)$

$i := 1..8$   $I_i := \ln\left(\frac{Z(\beta_i, q_i + \beta_i)}{Z(\beta_i, q_i)}\right)$  Eq. (6.65)

$\phi_i := \exp(Z(\beta_i, q_i) - 1 - \ln(Z(\beta_i, q_i) - \beta_i - q_i \cdot I_i))$  Eq. (11.37)

$f_i := \phi_i \cdot P_i$

$Z(\beta_i, q_i) =$	$\phi_i =$	$f_i =$
0.925	0.93	13.944
0.722	0.744	74.352
0.668	0.749	29.952
0.887	0.896	31.362
0.639	0.73	36.504
0.891	0.9	8.998
0.881	0.89	22.254
0.859	0.85	63.743

**11.39 Soave/Redlich/Kwong Equation**

$\Omega := 0.08664$

$\Psi := 0.42748$

$c := (0.480 + 1.574 \cdot \omega - 0.176 \cdot \omega^2)$

$\alpha := [1 + c \cdot (1 - \text{Tr}^{0.5})]^2$

$\beta\Omega = \left(\frac{\text{Pr}}{\text{Tr}}\right)$  Eq. (3.53)  $\beta = \begin{pmatrix} 0.02 \\ 0.133 \\ 0.069 \\ 0.036 \\ 0.081 \\ 0.028 \\ 0.04 \\ 0.121 \end{pmatrix}$

$q := \left(\frac{\Psi\alpha}{\Omega \cdot \text{Tr}}\right)$  Eq. (3.54)  $q = \begin{pmatrix} 4.49 \\ 3.202 \\ 4.737 \\ 3.79 \\ 4.468 \\ 4.62 \\ 3.827 \\ 2.304 \end{pmatrix}$

**Guess:**  $z := 1$



Given  $z = 1 + \beta - q \cdot \beta \cdot \frac{z - \beta}{z \cdot (z + \beta)}$  Eq. (3.52)  $Z(\beta, q) := \text{Find}(z)$

$i := 1..8$   $I_i := \ln\left(\frac{Z(\beta_i, q_i + \beta_i)}{Z(\beta_i, q_i)}\right)$  Eq. (6.65)

$\phi_i := \exp(Z(\beta_i, q_i) - 1 - \ln(Z(\beta_i, q_i) - \beta_i - q_i \cdot I_i))$  Eq. (11.37)

$f_i := \phi_i \cdot P_i$

$Z(\beta_i, q_i) =$	$\phi_i =$	$f_i =$
0.927	0.931	13.965
0.729	0.748	74.753
0.673	0.751	30.05
0.896	0.903	31.618
0.646	0.733	36.66
0.893	0.902	9.018
0.882	0.891	22.274
0.881	0.869	65.155

### 11.40 Peng/Robinson Equation

$\sigma := 1 + \sqrt{2}$

$\varepsilon := 1 - \sqrt{2}$

$\Omega := 0.07779$

$\Psi := 0.45724$

$c := (0.37464 + 1.54226 \cdot \omega - 0.26992 \cdot \omega^2)$

$\alpha := [1 + c \cdot (1 - \text{Tr}^{0.5})]^2$

$\beta\Omega = \begin{pmatrix} \cdot \\ \text{Pr} \\ \text{Tr} \end{pmatrix}$  Eq.(3.53)  $\beta = \begin{pmatrix} 0.018 \\ 0.12 \\ 0.062 \\ 0.032 \\ 0.073 \\ 0.025 \\ 0.036 \\ 0.108 \end{pmatrix}$

$q = \begin{pmatrix} \Psi\alpha \\ \Omega \cdot \text{Tr} \end{pmatrix}$  Eq.(3.54)  $q = \begin{pmatrix} 5.383 \\ 3.946 \\ 5.658 \\ 4.598 \\ 5.359 \\ 5.527 \\ 4.646 \\ 2.924 \end{pmatrix}$

**Guess:**  $z := 1$

Given  $z = 1 + \beta - q \cdot \beta \cdot \frac{z - \beta}{(z + \varepsilon\beta) \cdot (z + \sigma\beta)}$  **Eq. (3.52)**  $Z(\beta, q) := \text{Find}(z)$

$i := 1..8$   $I_i := \frac{1}{2 \cdot \sqrt{2}} \cdot \ln \left( \frac{Z(\beta_i, q_i + \sigma\beta_i)}{Z(\beta_i, q_i + \varepsilon\beta_i)} \right)$  **Eq. (6.65)**

$\phi_i := \exp(Z(\beta_i, q_i) - 1 - \ln(Z(\beta_i, q_i) - \beta_i - q_i \cdot I_i))$  **Eq. (11.37)**

$f_i := \phi_i \cdot P_i$	$Z(\beta_i, q_i) =$	$\phi_i =$	$f_i =$
0.918	0.923	0.923	13.842
0.69	0.711	0.711	71.113
0.647	0.73	0.73	29.197
0.882	0.89	0.89	31.142
0.617	0.709	0.709	35.465
0.881	0.891	0.891	8.91
0.865	0.876	0.876	21.895
0.845	0.832	0.832	62.363

**φ BY GENERALIZED CORRELATIONS**

**Parts (a), (d), (f), and (g) --- Virial equation:**

$T := \begin{pmatrix} 325 \\ 350 \\ 525 \\ 225 \end{pmatrix}$	$T_c := \begin{pmatrix} 308.3 \\ 304.2 \\ 507.6 \\ 190.6 \end{pmatrix}$	$P := \begin{pmatrix} 15 \\ 35 \\ 10 \\ 25 \end{pmatrix}$	$P_c := \begin{pmatrix} 61.39 \\ 73.83 \\ 30.25 \\ 45.99 \end{pmatrix}$	$\omega := \begin{pmatrix} .187 \\ .224 \\ .301 \\ .012 \end{pmatrix}$
---	---	---	---	--

$\text{Tr} := \frac{T}{T_c}$        $\text{Pr} := \frac{P}{P_c}$

**Evaluation of φ:**

$B_0 := B_0(\text{Tr})$  **Eq. (3.65)**       $B_1 := B_1(\text{Tr})$  **Eq. (3.66)**

$$DB0 := \frac{0.675}{Tr^{2.6}} \quad \text{Eq. (6.89)}$$

$$DB1 := \frac{0.722}{Tr^{5.2}} \quad \text{Eq. (6.90)}$$

$$\phi := \exp\left[\frac{Pr}{Tr} \cdot (B0 + \omega \cdot B1)\right] \quad \text{Eq. (11.60)}$$

$$\phi = \begin{pmatrix} 0.932 \\ 0.904 \\ 0.903 \\ 0.895 \end{pmatrix} \quad \begin{matrix} \text{(a)} \\ \text{(d)} \\ \text{(f)} \\ \text{(g)} \end{matrix}$$

Parts (b), (c), (e), and (h) --- Lee/Kesler correlation:

Interpolate in Tables E.13 - E.16:

$$\phi0 := \begin{pmatrix} .7454 \\ .7517 \\ .7316 \\ .8554 \end{pmatrix}$$

$$\phi1 := \begin{pmatrix} 1.1842 \\ 0.9634 \\ 0.9883 \\ 1.2071 \end{pmatrix}$$

$$\omega := \begin{pmatrix} 0.000 \\ 0.210 \\ 0.087 \\ 0.038 \end{pmatrix}$$

$$\phi\phi = \left( \right) 0 \cdot \phi1^\omega \quad \text{Eq. (11.67):}$$

$$\phi = \begin{pmatrix} 0.745 \\ 0.746 \\ 0.731 \\ 0.862 \end{pmatrix} \quad \begin{matrix} \text{(b)} \\ \text{(c)} \\ \text{(e)} \\ \text{(h)} \end{matrix}$$

11.43  $\dot{n}1 := 2 \frac{\text{kmol}}{\text{hr}}$   $\dot{n}2 := 4 \frac{\text{kmol}}{\text{hr}}$   $\dot{n}3 := \dot{n}1 + \dot{n}2$

$$x1 := \frac{\dot{n}1}{\dot{n}3} \quad x1 = 0.333 \quad x2 := 1 - x1 \quad x2 = 0.667$$

a) Assume an ideal solution since n-octane and iso-octane are non-polar and very similar in chemical structure. For an ideal solution, there is no heat of mixing therefore the heat transfer rate is zero.

b)  $\Delta S_t := -R \cdot (x1 \cdot \ln(x1) + x2 \cdot \ln(x2)) \cdot \dot{n}3$   $\Delta S_t = 8.82 \frac{\text{W}}{\text{K}}$  Ans.

11.44 For air entering the process:

$$x_{O21} := 0.21$$

$$x_{N21} := 0.79$$

For the enhanced air leaving the process:

$$x_{O22} := 0.5$$

$$x_{N22} := 0.5$$

$$\dot{n}_{O2} := 50 \frac{\text{mol}}{\text{sec}}$$

a) Apply mole balances to find rate of air and O<sub>2</sub> fed to process

**Guess:**  $\dot{n}_{\text{air}} := 40 \frac{\text{mol}}{\text{sec}}$        $\dot{n}_{O2} := 10 \frac{\text{mol}}{\text{sec}}$

Given

$$x_{O21} \cdot \dot{n}_{\text{air}} + \dot{n}_{O2} = x_{O22} \cdot \dot{n}_{O2} \quad \text{Mole balance on O}_2$$

$$x_{N21} \cdot \dot{n}_{\text{air}} = x_{N22} \cdot \dot{n}_{O2} \quad \text{Mole balance on N}_2$$

$$\begin{pmatrix} \dot{n}_{\text{air}} \\ \dot{n}_{O2} \end{pmatrix} := \text{Find}(\dot{n}_{\text{air}}, \dot{n}_{O2})$$

$$\dot{n}_{\text{air}} = 31.646 \frac{\text{mol}}{\text{sec}} \quad \text{Ans.}$$

$$\dot{n}_{O2} = 18.354 \frac{\text{mol}}{\text{sec}} \quad \text{Ans.}$$

b) Assume ideal gas behavior. For an ideal gas there is no heat of mixing, therefore, the heat transfer rate is zero.

c) To calculate the entropy change, treat the process in two steps:

1. Demix the air to O<sub>2</sub> and N<sub>2</sub>

2. Mix the N<sub>2</sub> and combined O<sub>2</sub> to produce the enhanced air

$$\text{Entropy change of demixing } \Delta S_{12} := R \cdot (x_{O21} \cdot \ln(x_{O21}) + x_{N21} \cdot \ln(x_{N21}))$$

$$\text{Entropy change of mixing } \Delta S_{23} := -R \cdot (x_{O22} \cdot \ln(x_{O22}) + x_{N22} \cdot \ln(x_{N22}))$$

$$\text{Total rate of entropy generation: } S_{\dot{G}} := \dot{n}_{\text{air}} \cdot \Delta S_{12} + \dot{n}_{O2} \cdot \Delta S_{23}$$

$$S_{\dot{G}} = 152.919 \frac{\text{W}}{\text{K}} \quad \text{Ans.}$$

$$11.50 \quad T := \begin{pmatrix} 10 \\ 30 \\ 50 \end{pmatrix} \text{K} + 273.15\text{K} \quad GE := \begin{pmatrix} 544.0 \\ 513.0 \\ 494.2 \end{pmatrix} \frac{\text{J}}{\text{mol}} \quad HE := \begin{pmatrix} 932.1 \\ 893.4 \\ 845.9 \end{pmatrix} \frac{\text{J}}{\text{mol}}$$

Assume  $C_p$  is constant. Then HE is of the form:  $HE = c + a \cdot T$

Find  $a$  and  $c$  using the given HE and T values.

$$a := \text{slope}(T, HE) \quad a = -2.155 \frac{\text{J}}{\text{mol} \cdot \text{K}}$$

$$c := \text{intercept}(T, HE) \quad c = 1.544 \times 10^3 \frac{\text{J}}{\text{mol}}$$

$$GE \text{ is of the form: } GE = -a \cdot \left( T \cdot \ln\left(\frac{T}{K}\right) - T \right) + b \cdot T + c$$

Rearrange to find  $b$  using estimated  $a$  and  $c$  values along with GE and T data.

$$B := \frac{GE + a \cdot \left( T \cdot \ln\left(\frac{T}{K}\right) - T \right) - c}{T} \quad B = \begin{pmatrix} -13.543 \\ -13.559 \\ -13.545 \end{pmatrix} \frac{\text{J}}{\text{mol} \cdot \text{K}}$$

Use averaged  $b$  value

$$b := \frac{\sum_{i=1}^3 B_i}{3} \quad b = -13.549 \frac{\text{J}}{\text{mol} \cdot \text{K}}$$

Now calculate HE, GE and T\*SE at 25 C using  $a$ ,  $b$  and  $c$  values.

$$HE(T) := a \cdot T + c \quad HE[(25 + 273.15)\text{K}] = 901.242 \frac{\text{J}}{\text{mol}} \text{ Ans.}$$

$$GE(T) := -a \cdot \left( T \cdot \ln\left(\frac{T}{K}\right) - T \right) + b \cdot T + c \quad GE[(25 + 273.15)\text{K}] = 522.394 \frac{\text{J}}{\text{mol}} \text{ Ans.}$$

$$TSE(T) := HE(T) - GE(T) \quad TSE[(25 + 273.15)\text{K}] = 378.848 \frac{\text{J}}{\text{mol}} \text{ Ans.}$$

## Chapter 12 - Section A - Mathcad Solutions

### 12.1 Methanol(1)/Water(2)-- VLE data:

$$T := 333.15 \cdot K$$

$$P := \begin{pmatrix} 39.223 \\ 42.984 \\ 48.852 \\ 52.784 \\ 56.652 \\ 60.614 \\ 63.998 \\ 67.924 \\ 70.229 \\ 72.832 \end{pmatrix} \cdot \text{kPa}$$

$$x_1 := \begin{pmatrix} 0.1686 \\ 0.2167 \\ 0.3039 \\ 0.3681 \\ 0.4461 \\ 0.5282 \\ 0.6044 \\ 0.6804 \\ 0.7255 \\ 0.7776 \end{pmatrix}$$

$$y_1 := \begin{pmatrix} 0.5714 \\ 0.6268 \\ 0.6943 \\ 0.7345 \\ 0.7742 \\ 0.8085 \\ 0.8383 \\ 0.8733 \\ 0.8922 \\ 0.9141 \end{pmatrix}$$

**Number of data points:**  $n := \text{rows}(P)$        $n = 10$        $i := 1..n$

**Calculate x2 and y2:**  $x_2 := \overrightarrow{(1 - x_1)}$        $y_2 := \overrightarrow{(1 - y_1)}$

**Vapor Pressures from equilibrium data:**

$$P_{\text{sat}1} := 84.562 \cdot \text{kPa}$$

$$P_{\text{sat}2} := 19.953 \cdot \text{kPa}$$

**Calculate EXPERIMENTAL values of activity coefficients and excess Gibbs energy.**

$$\gamma_1 := \frac{\overrightarrow{y_1 \cdot P}}{\overrightarrow{x_1 \cdot P_{\text{sat}1}}} \quad \gamma_2 := \frac{\overrightarrow{y_2 \cdot P}}{\overrightarrow{x_2 \cdot P_{\text{sat}2}}} \quad \text{GERT} := \overrightarrow{(x_1 \cdot \ln(\gamma_1) + x_2 \cdot \ln(\gamma_2))}$$

$i =$	$\gamma_{1_i} =$	$\gamma_{2_i} =$	$\ln(\gamma_{1_i}) =$	$\ln(\gamma_{2_i}) =$	$GERT_i =$
1	1.572	1.013	0.452	0.013	0.087
2	1.47	1.026	0.385	0.026	0.104
3	1.32	1.075	0.278	0.073	0.135
4	1.246	1.112	0.22	0.106	0.148
5	1.163	1.157	0.151	0.146	0.148
6	1.097	1.233	0.093	0.209	0.148
7	1.05	1.311	0.049	0.271	0.136
8	1.031	1.35	0.031	0.3	0.117
9	1.021	1.382	0.021	0.324	0.104
10	1.012	1.41	0.012	0.343	0.086

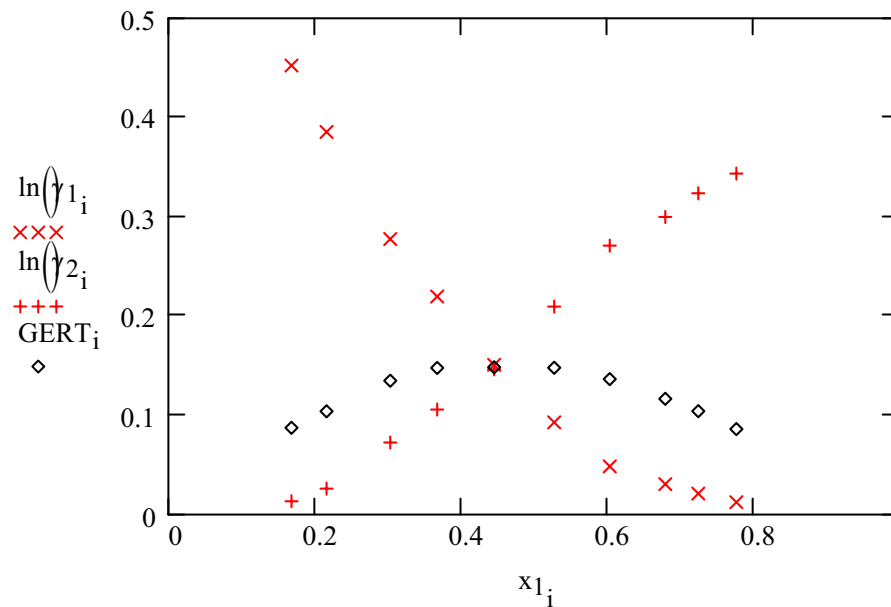

(a) Fit GE/RT data to Margules eqn. by linear least squares:

$$VX_i := x_{1_i} \qquad VY_i := \frac{GERT_i}{x_{1_i} \cdot x_{2_i}}$$

Slope := slope(VX, VY)      Intercept := intercept(VX, VY)

Slope = -0.208

Intercept = 0.683

$A_{12} :=$  Intercept

$A_{21} :=$  Slope +  $A_{12}$

$A_{12} = 0.683$

$A_{21} = 0.475$       **Ans.**

The following equations give CALCULATED values:

$$\gamma_1(x_1, x_2) := \exp\left[x_2^2 \cdot \left[A_{12} + 2 \cdot (A_{21} - A_{12}) \cdot x_1\right]\right]$$

$$\gamma_2(x_1, x_2) := \exp\left[x_1^2 \cdot \left[A_{21} + 2 \cdot (A_{12} - A_{21}) \cdot x_2\right]\right]$$

$$j := 1..101 \quad X_{1j} := .01 \cdot j - .01 \quad X_{2j} := 1 - X_{1j}$$

$$P_{\text{calc}_j} := X_{1j} \cdot \gamma_1(X_{1j}, X_{2j}) \cdot P_{\text{sat}_1} + X_{2j} \cdot \gamma_2(X_{1j}, X_{2j}) \cdot P_{\text{sat}_2}$$

$$Y_{1\text{calc}_j} := \frac{X_{1j} \cdot \gamma_1(X_{1j}, X_{2j}) \cdot P_{\text{sat}_1}}{P_{\text{calc}_j}}$$

**P-x,y Diagram: Margules eqn. fit to GE/RT data.**

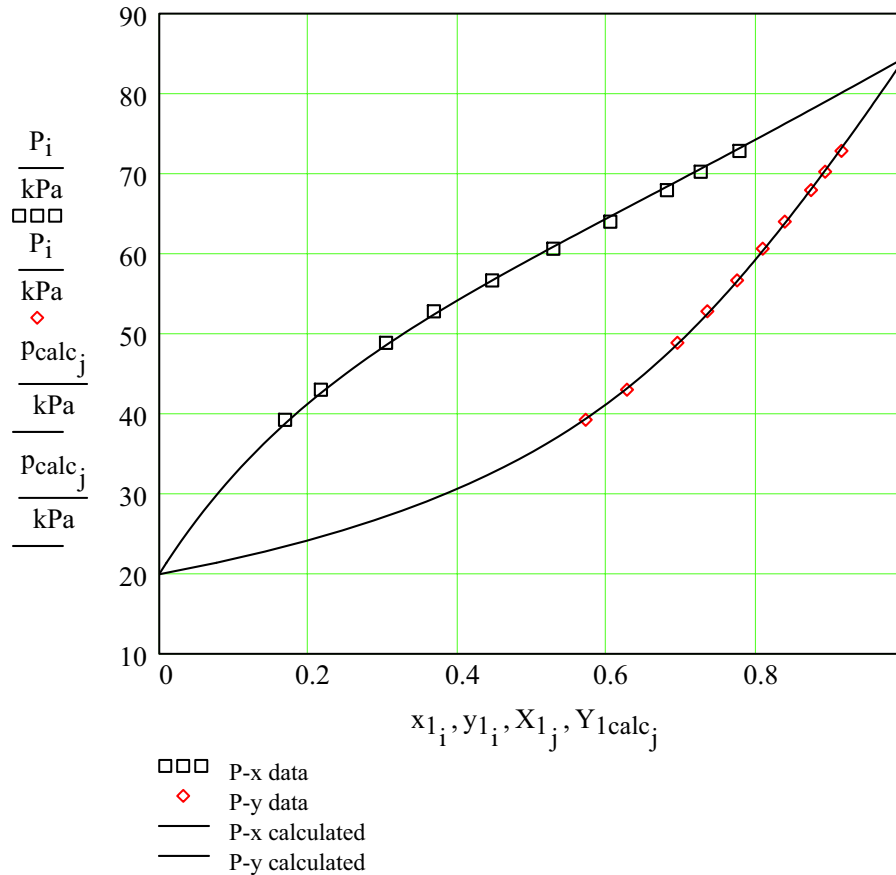



$$P_{\text{calc}_i} := x_{1_i} \cdot \gamma_1(x_{1_i}, x_{2_i}) \cdot P_{\text{sat}_1} + x_{2_i} \cdot \gamma_2(x_{1_i}, x_{2_i}) \cdot P_{\text{sat}_2}$$

$$y_{1\text{calc}_i} := \frac{x_{1_i} \cdot \gamma_1(x_{1_i}, x_{2_i}) \cdot P_{\text{sat}_1}}{P_{\text{calc}_i}}$$

**RMS deviation in P:**

$$\text{RMS} := \sqrt{\sum_i \frac{(P_i - P_{\text{calc}_i})^2}{n}} \quad \text{RMS} = 0.399 \text{ kPa}$$

**(b) Fit GE/RT data to van Laar eqn. by linear least squares:**

$$VX_i := x_{1_i} \quad VY_i := \frac{x_{1_i} \cdot x_{2_i}}{GERT_i}$$

$$\text{Slope} := \text{slope}(VX, VY) \quad \text{Intercept} := \text{intercept}(VX, VY)$$

$$\text{Slope} = 0.641$$

$$\text{Intercept} = 1.418$$

$$a_{12} := \frac{1}{\text{Intercept}}$$

$$a_{21} := \frac{1}{(\text{Slope} + \text{Intercept})}$$

$$a_{12} = 0.705$$

$$a_{21} = 0.485 \quad \text{Ans.}$$

$$\gamma_1(x_1, x_2) := \exp \left[ a_{12} \cdot \left( 1 + \frac{a_{12} \cdot x_1}{a_{21} \cdot x_2} \right)^{-2} \right]$$

$$\gamma_2(x_1, x_2) := \exp \left[ a_{21} \cdot \left( 1 + \frac{a_{21} \cdot x_2}{a_{12} \cdot x_1} \right)^{-2} \right]$$

$$j := 1..101 \quad X_{1_j} := .01 \cdot j - .00999 \quad \text{(To avoid singularities)}$$

$$X_{2_j} := 1 - X_{1_j}$$

$$P_{\text{calc},j} := X_{1,j} \cdot \gamma_1(X_{1,j}, X_{2,j}) \cdot P_{\text{sat}1} + X_{2,j} \cdot \gamma_2(X_{1,j}, X_{2,j}) \cdot P_{\text{sat}2}$$

$$P_{\text{calc},i} := x_{1,i} \cdot \gamma_1(x_{1,i}, x_{2,i}) \cdot P_{\text{sat}1} + x_{2,i} \cdot \gamma_2(x_{1,i}, x_{2,i}) \cdot P_{\text{sat}2}$$

$$Y_{1\text{calc},j} := \frac{X_{1,j} \cdot \gamma_1(X_{1,j}, X_{2,j}) \cdot P_{\text{sat}1}}{P_{\text{calc},j}} \quad y_{1\text{calc},i} := \frac{x_{1,i} \cdot \gamma_1(x_{1,i}, x_{2,i}) \cdot P_{\text{sat}1}}{P_{\text{calc},i}}$$

**P-x,y Diagram: van Laar eqn. fit to GE/RT data.**

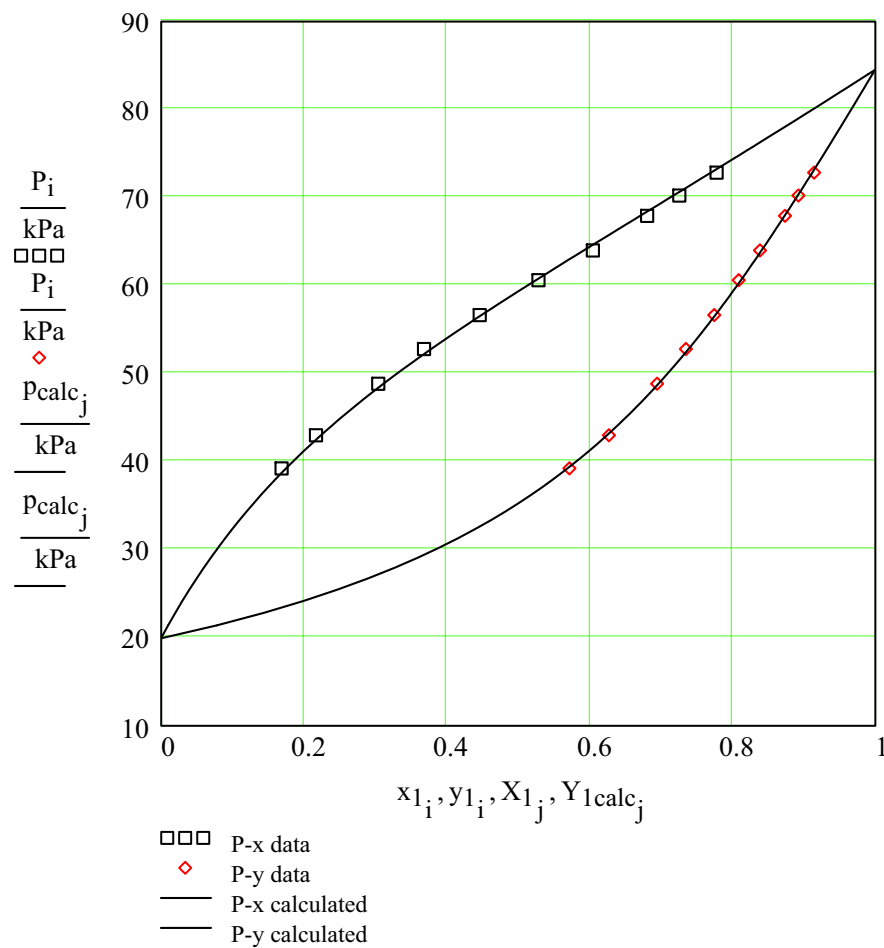

**RMS deviation in P:**

$$\text{RMS} := \sqrt{\sum_i \frac{(P_i - P_{\text{calc},i})^2}{n}}$$

**RMS = 0.454 kPa**

(c) Fit GE/RT data to Wilson eqn. by non-linear least squares.

Minimize the sum of the squared errors using the Mathcad Minimize function.

Guesses:  $\Lambda_{12} := 0.5$        $\Lambda_{21} := 1.0$

$$SSE(\Lambda_{12}, \Lambda_{21}) := \sum_i \left[ \text{GERT}_i + \begin{pmatrix} x_{1_i} \cdot \ln(x_{1_i} + x_{2_i} \cdot \Lambda_{12}) \\ + x_{2_i} \cdot \ln(x_{2_i} + x_{1_i} \cdot \Lambda_{21}) \end{pmatrix} \right]^2$$

$$\begin{pmatrix} \Lambda_{12} \\ \Lambda_{21} \end{pmatrix} := \text{Minimize}(SSE, \Lambda_{12}, \Lambda_{21}) \quad \begin{pmatrix} \Lambda_{12} \\ \Lambda_{21} \end{pmatrix} = \begin{pmatrix} 0.476 \\ 1.026 \end{pmatrix} \quad \text{Ans.}$$

$$\gamma_1(x_1, x_2) := \frac{\exp \left[ x_2 \cdot \left( \frac{\Lambda_{12}}{x_1 + x_2 \cdot \Lambda_{12}} - \frac{\Lambda_{21}}{x_2 + x_1 \cdot \Lambda_{21}} \right) \right]}{(x_1 + x_2 \cdot \Lambda_{12})}$$

$$\gamma_2(x_1, x_2) := \frac{\exp \left[ -x_1 \cdot \left( \frac{\Lambda_{12}}{x_1 + x_2 \cdot \Lambda_{12}} - \frac{\Lambda_{21}}{x_2 + x_1 \cdot \Lambda_{21}} \right) \right]}{(x_2 + x_1 \cdot \Lambda_{21})}$$

$$j := 1..101 \quad X_{1_j} := .01 \cdot j - .01 \quad X_{2_j} := 1 - X_{1_j}$$

$$P_{\text{calc}_j} := X_{1_j} \cdot \gamma_1(X_{1_j}, X_{2_j}) \cdot P_{\text{sat}_1} + X_{2_j} \cdot \gamma_2(X_{1_j}, X_{2_j}) \cdot P_{\text{sat}_2}$$

$$P_{\text{calc}_i} := x_{1_i} \cdot \gamma_1(x_{1_i}, x_{2_i}) \cdot P_{\text{sat}_1} + x_{2_i} \cdot \gamma_2(x_{1_i}, x_{2_i}) \cdot P_{\text{sat}_2}$$

$$Y_{1\text{calc}_j} := \frac{X_{1_j} \cdot \gamma_1(X_{1_j}, X_{2_j}) \cdot P_{\text{sat}_1}}{P_{\text{calc}_j}} \quad y_{1\text{calc}_i} := \frac{x_{1_i} \cdot \gamma_1(x_{1_i}, x_{2_i}) \cdot P_{\text{sat}_1}}{P_{\text{calc}_i}}$$

**P-x,y diagram: Wilson eqn. fit to GE/RT data.**

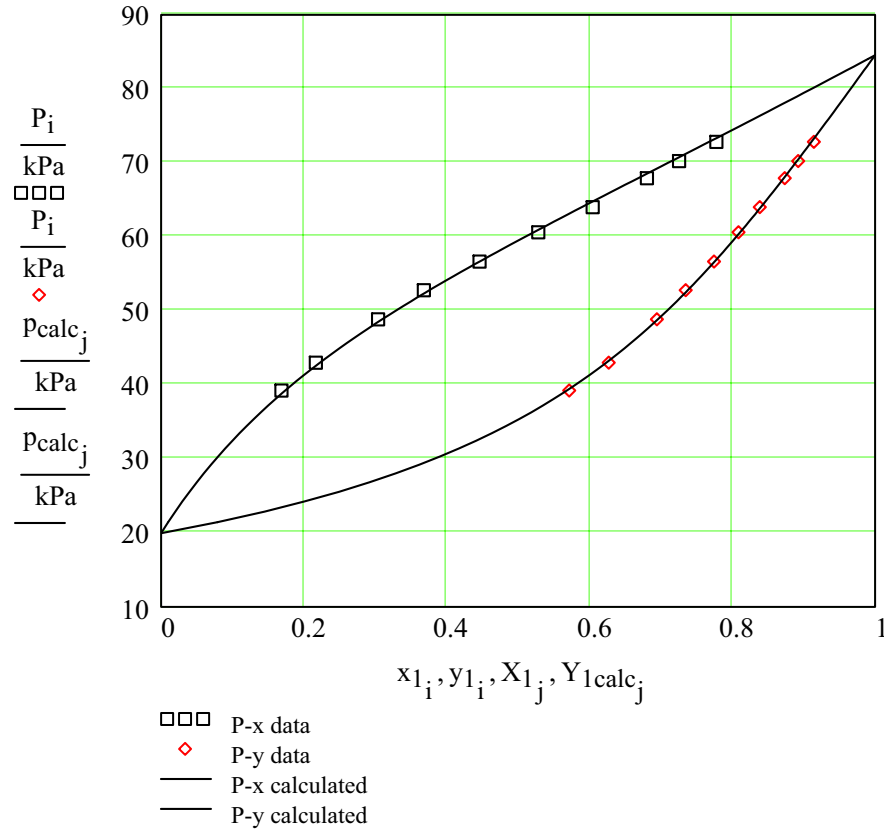

**RMS deviation in P:**

$$\text{RMS} := \sqrt{\sum_i \frac{(P_i - P_{\text{calc}_i})^2}{n}} \quad \text{RMS} = 0.48 \text{ kPa}$$

**(d) BARKER'S METHOD by non-linear least squares. Margules equation.**

**Guesses for parameters: answers to Part (a).**

$$\gamma_1(x_1, x_2, A_{12}, A_{21}) := \exp\left[(x_2)^2 \cdot [A_{12} + 2 \cdot (A_{21} - A_{12} \cdot x_1)]\right]$$

$$\gamma_2(x_1, x_2, A_{12}, A_{21}) := \exp\left[(x_1)^2 \cdot [A_{21} + 2 \cdot (A_{12} - A_{21} \cdot x_2)]\right]$$

**Minimize the sum of the squared errors using the Mathcad Minimize function.**

**Guesses:**  $A_{12} := 0.5$        $A_{21} := 1.0$

$$SSE(A_{12}, A_{21}) := \sum_i \left[ P_i - \left( x_{1_i} \cdot \gamma_1(x_{1_i}, x_{2_i}, A_{12}, A_{21}) \cdot P_{sat1} \dots \right) \right]^2$$

$$\left( + x_{2_i} \cdot \gamma_2(x_{1_i}, x_{2_i}, A_{12}, A_{21}) \cdot P_{sat2} \right)$$

$$\begin{pmatrix} A_{12} \\ A_{21} \end{pmatrix} := \text{Minimize}(SSE, A_{12}, A_{21}) \quad \begin{pmatrix} A_{12} \\ A_{21} \end{pmatrix} = \begin{pmatrix} 0.758 \\ 0.435 \end{pmatrix} \quad \text{Ans.}$$

$$P_{calc_j} := x_{1_j} \cdot \gamma_1(x_{1_j}, x_{2_j}, A_{12}, A_{21}) \cdot P_{sat1} \dots$$

$$+ x_{2_j} \cdot \gamma_2(x_{1_j}, x_{2_j}, A_{12}, A_{21}) \cdot P_{sat2}$$

$$Y_{1calc_j} := \frac{x_{1_j} \cdot \gamma_1(x_{1_j}, x_{2_j}, A_{12}, A_{21}) \cdot P_{sat1}}{P_{calc_j}}$$

$$P_{calc_i} := x_{1_i} \cdot \gamma_1(x_{1_i}, x_{2_i}, A_{12}, A_{21}) \cdot P_{sat1} \dots$$

$$+ x_{2_i} \cdot \gamma_2(x_{1_i}, x_{2_i}, A_{12}, A_{21}) \cdot P_{sat2}$$

$$Y_{1calc_i} := \frac{x_{1_i} \cdot \gamma_1(x_{1_i}, x_{2_i}, A_{12}, A_{21}) \cdot P_{sat1}}{P_{calc_i}}$$

**RMS deviation in P:**

$$RMS := \sqrt{\sum_i \frac{(P_i - P_{calc_i})^2}{n}} \quad \text{RMS} = 0.167 \text{ kPa}$$

### P-x-y diagram, Margules eqn. by Barker's method

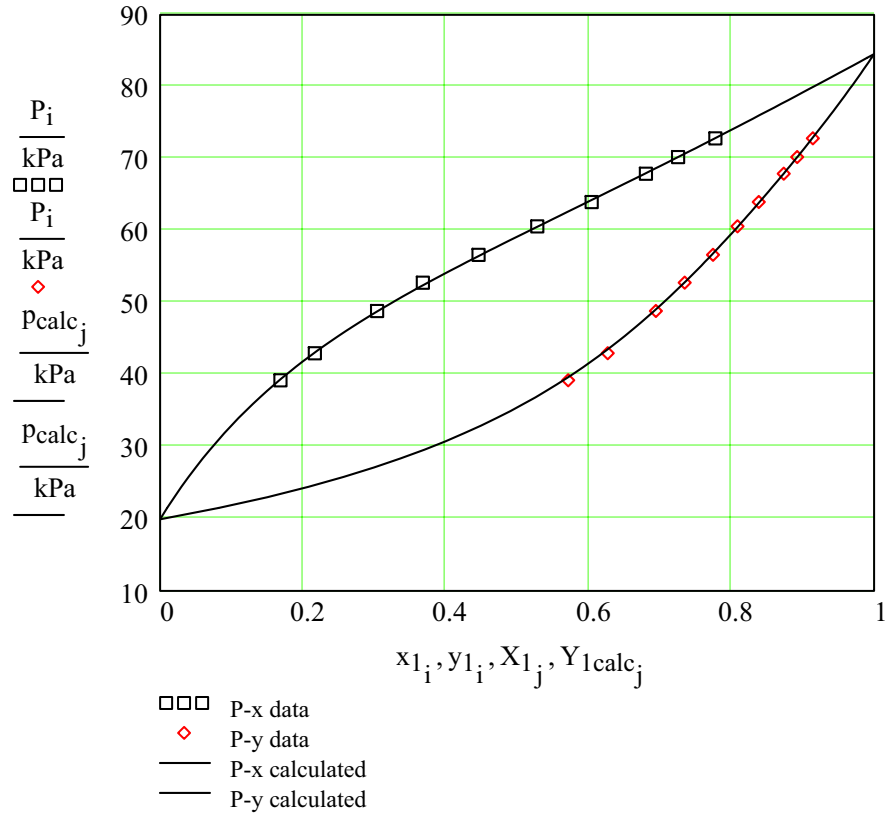

### Residuals in P and y1

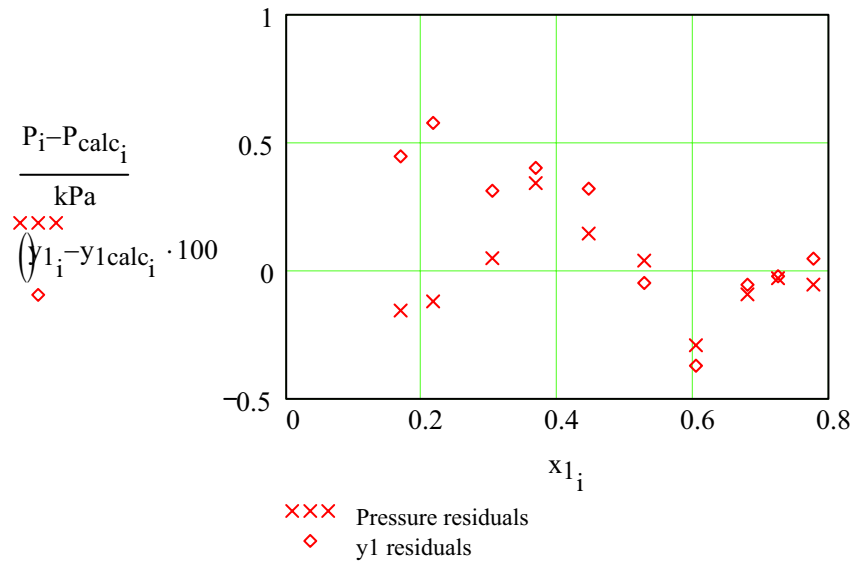

(e) **BARKER'S METHOD** by non-linear least squares.  
van Laar equation.

**Guesses for parameters: answers to Part (b).**

$$j := 1..101 \quad X_{1j} := .01 \cdot j - .00999 \quad X_{2j} := 1 - X_{1j}$$

$$\gamma_1(x_1, x_2, a_{12}, a_{21}) := \exp \left[ a_{12} \cdot \left( 1 + \frac{a_{12} \cdot x_1}{a_{21} \cdot x_2} \right)^{-2} \right]$$

$$\gamma_2(x_1, x_2, a_{12}, a_{21}) := \exp \left[ a_{21} \cdot \left( 1 + \frac{a_{21} \cdot x_2}{a_{12} \cdot x_1} \right)^{-2} \right]$$

**Minimize the sum of the squared errors using the Mathcad Minimize function.**

**Guesses:**  $a_{12} := 0.5 \quad a_{21} := 1.0$

$$SSE(a_{12}, a_{21}) := \sum_i \left[ P_i - \left( x_{1i} \cdot \gamma_1(x_{1i}, x_{2i}, a_{12}, a_{21}) \cdot Psat_1 \dots \right. \right. \\ \left. \left. + x_{2i} \cdot \gamma_2(x_{1i}, x_{2i}, a_{12}, a_{21}) \cdot Psat_2 \right) \right]^2$$

$$\begin{pmatrix} a_{12} \\ a_{21} \end{pmatrix} := \text{Minimize}(SSE, a_{12}, a_{21}) \quad \begin{pmatrix} a_{12} \\ a_{21} \end{pmatrix} = \begin{pmatrix} 0.83 \\ 0.468 \end{pmatrix} \quad \text{Ans.}$$

$$P_{\text{calc}_j} := X_{1j} \cdot \gamma_1(X_{1j}, X_{2j}, a_{12}, a_{21}) \cdot Psat_1 \dots \\ + X_{2j} \cdot \gamma_2(X_{1j}, X_{2j}, a_{12}, a_{21}) \cdot Psat_2$$

$$Y_{1\text{calc}_j} := \frac{X_{1j} \cdot \gamma_1(X_{1j}, X_{2j}, a_{12}, a_{21}) \cdot Psat_1}{P_{\text{calc}_j}}$$

$$P_{\text{calc}_i} := x_{1i} \cdot \gamma_1(x_{1i}, x_{2i}, a_{12}, a_{21}) \cdot Psat_1 \dots \\ + x_{2i} \cdot \gamma_2(x_{1i}, x_{2i}, a_{12}, a_{21}) \cdot Psat_2$$

$$Y_{1\text{calc}_i} := \frac{x_{1i} \cdot \gamma_1(x_{1i}, x_{2i}, a_{12}, a_{21}) \cdot Psat_1}{P_{\text{calc}_i}}$$

**RMS deviation in P:**

$$\text{RMS} := \sqrt{\sum_i \frac{(P_i - P_{\text{calc}_i})^2}{n}}$$

RMS = 0.286 kPa

**P-x,y diagram, van Laar Equation by Barker's Method**

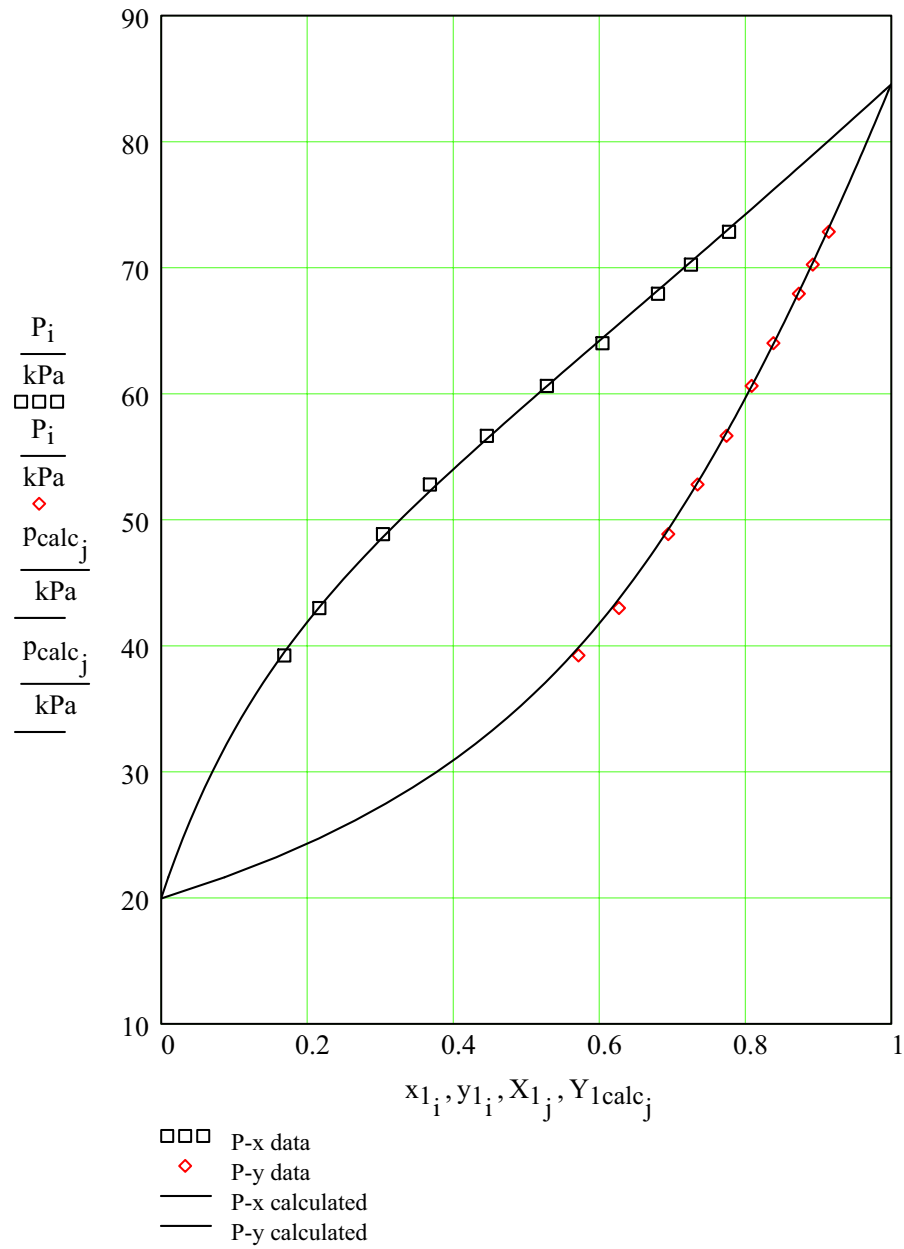



**Residuals in P and y1.**

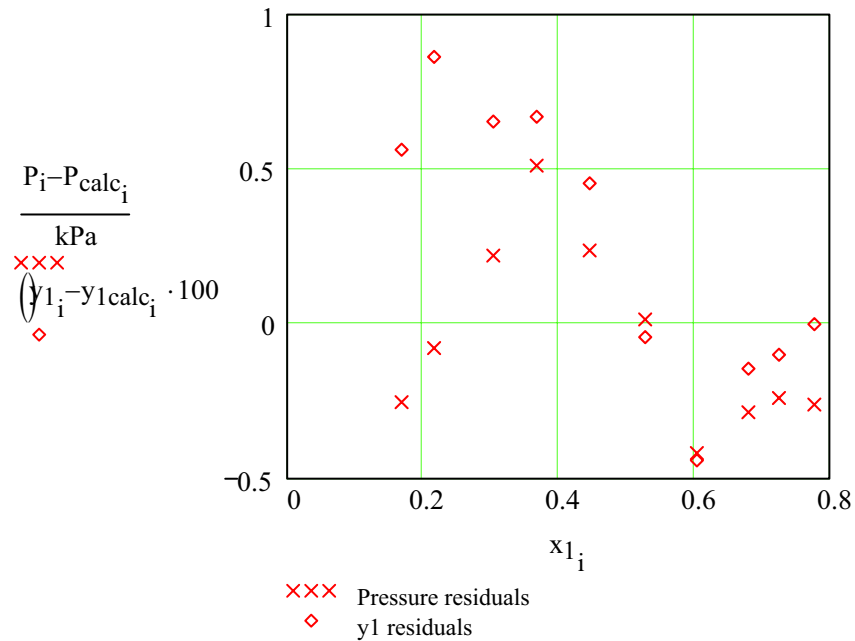

**(f) BARKER'S METHOD by non-linear least squares.**

**Wilson equation.**

**Guesses for parameters: answers to Part (c).**

$$j := 1..101 \quad X_{1j} := .01 \cdot j - .01 \quad X_{2j} := 1 - X_{1j}$$

$$\gamma_1(x_1, \Lambda_{12}, \Lambda_{21}) := \exp \left[ -\ln(x_1 + x_2 \cdot \Lambda_{12}) \dots \right. \\ \left. + x_2 \cdot \left( \frac{\Lambda_{12}}{x_1 + x_2 \cdot \Lambda_{12}} - \frac{\Lambda_{21}}{x_2 + x_1 \cdot \Lambda_{21}} \right) \right]$$

$$\gamma_2(x_1, \Lambda_{12}, \Lambda_{21}) := \exp \left[ -\ln(x_2 + x_1 \cdot \Lambda_{21}) \dots \right. \\ \left. + x_1 \cdot \left( \frac{-\Lambda_{12}}{x_1 + x_2 \cdot \Lambda_{12}} + \frac{\Lambda_{21}}{x_2 + x_1 \cdot \Lambda_{21}} \right) \right]$$

**Minimize the sum of the squared errors using the Mathcad Minimize function.**

**Guesses:**       $\Lambda_{12} := 0.5$        $\Lambda_{21} := 1.0$

$$SSE(\Lambda_{12}, \Lambda_{21}) := \sum_i \left[ P_i - \left( x_{1i} \cdot \gamma_1(x_{1i}, \Lambda_{2i}, \Lambda_{12}, \Lambda_{21}) \cdot P_{sat1} \dots \right) \right]^2$$

$$\begin{pmatrix} \Lambda_{12} \\ \Lambda_{21} \end{pmatrix} := \text{Minimize}(SSE, \Lambda_{12}, \Lambda_{21})$$

$$\begin{pmatrix} \Lambda_{12} \\ \Lambda_{21} \end{pmatrix} = \begin{pmatrix} 0.348 \\ 1.198 \end{pmatrix}$$

Ans.

$$P_{calc_j} := x_{1j} \cdot \gamma_1(x_{1j}, \Lambda_{2j}, \Lambda_{12}, \Lambda_{21}) \cdot P_{sat1} \dots + x_{2j} \cdot \gamma_2(x_{1j}, \Lambda_{2j}, \Lambda_{12}, \Lambda_{21}) \cdot P_{sat2}$$

$$Y_{1calc_j} := \frac{x_{1j} \cdot \gamma_1(x_{1j}, \Lambda_{2j}, \Lambda_{12}, \Lambda_{21}) \cdot P_{sat1}}{P_{calc_j}}$$

$$P_{calc_i} := x_{1i} \cdot \gamma_1(x_{1i}, \Lambda_{2i}, \Lambda_{12}, \Lambda_{21}) \cdot P_{sat1} \dots + x_{2i} \cdot \gamma_2(x_{1i}, \Lambda_{2i}, \Lambda_{12}, \Lambda_{21}) \cdot P_{sat2}$$

$$Y_{1calc_i} := \frac{x_{1i} \cdot \gamma_1(x_{1i}, \Lambda_{2i}, \Lambda_{12}, \Lambda_{21}) \cdot P_{sat1}}{P_{calc_i}}$$

**RMS deviation in P:**

$$RMS := \sqrt{\sum_i \frac{(P_i - P_{calc_i})^2}{n}}$$

$$RMS = 0.305 \text{ kPa}$$

### P-x,y diagram, Wilson Equation by Barker's Method

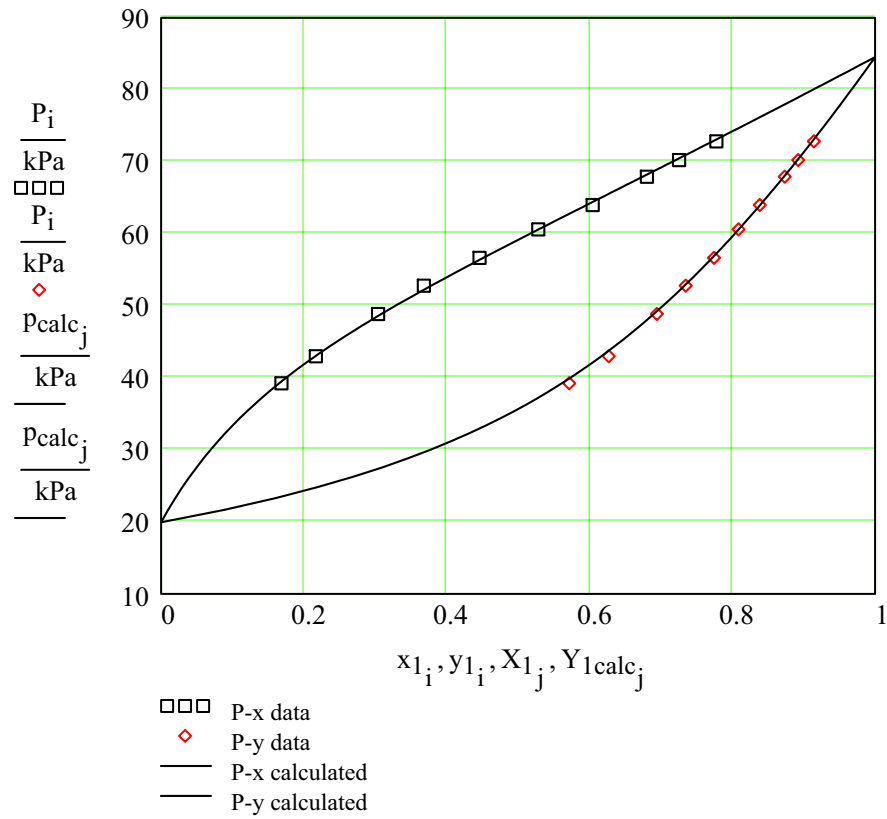

### Residuals in P and y1.

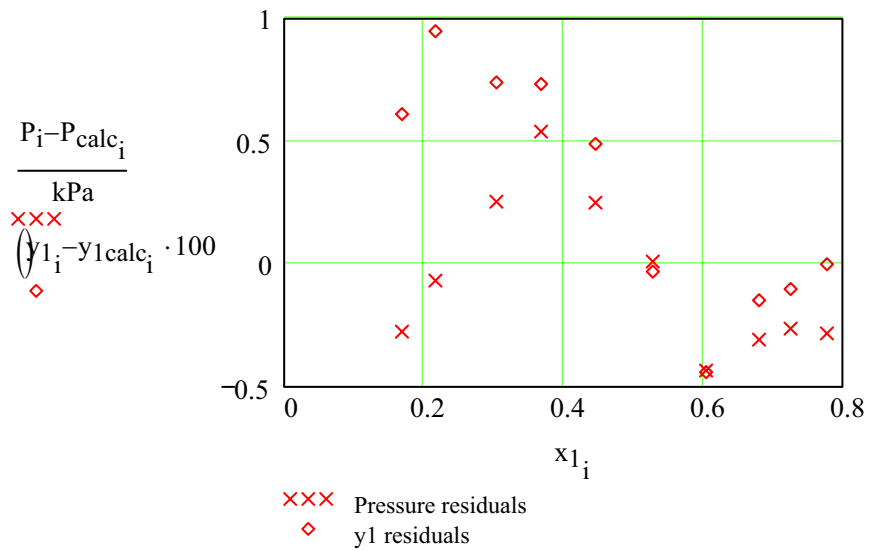

12.3 Acetone(1)/Methanol(2)-- VLE data:

T := 328.15·K

P :=	( 72.278 )	x <sub>1</sub> :=	( 0.0287 )	y <sub>1</sub> :=	( 0.0647 )
	75.279		0.0570		0.1295
	77.524		0.0858		0.1848
	78.951		0.1046		0.2190
	82.528		0.1452		0.2694
	86.762		0.2173		0.3633
	90.088		0.2787		0.4184
	93.206		0.3579		0.4779
	95.017		0.4050		0.5135
	96.365		0.4480		0.5512
	97.646		0.5052		0.5844
	98.462		0.5432		0.6174
	99.811		0.6332		0.6772
	99.950		0.6605		0.6926
	100.278		0.6945		0.7124
	100.467		0.7327		0.7383
	100.999		0.7752		0.7729
	101.059		0.7922		0.7876
	99.877		0.9080		0.8959
	( 99.799 )		( 0.9448 )		( 0.9336 )

Number of data points: n := rows(P)      n = 20      i := 1..n

Calculate x<sub>2</sub> and y<sub>2</sub>:  $x_2 := \overrightarrow{1 - x_1}$        $y_2 := \overrightarrow{1 - y_1}$

Vapor Pressures from equilibrium data:

Psat<sub>1</sub> := 96.885·kPa

Psat<sub>2</sub> := 68.728·kPa

Calculate EXPERIMENTAL values of activity coefficients and excess Gibbs energy.

$$\gamma_1 := \frac{y_1 \cdot P}{x_1 \cdot P_{\text{sat}1}} \quad \gamma_2 := \frac{y_2 \cdot P}{x_2 \cdot P_{\text{sat}2}} \quad \text{GERT} := (x_1 \cdot \ln(\gamma_1) + x_2 \cdot \ln(\gamma_2))$$

i =	$\gamma_{1,i} =$	$\gamma_{2,i} =$	$\ln(\gamma_{1,i}) =$	$\ln(\gamma_{2,i}) =$	GERT <sub>i</sub> =
1	1.682	1.013	0.52	0.013	0.027
2	1.765	1.011	0.568	0.011	0.043
3	1.723	1.006	0.544	$5.815 \cdot 10^{-3}$	0.052
4	1.706	1.002	0.534	$1.975 \cdot 10^{-3}$	0.058
5	1.58	1.026	0.458	0.026	0.089
6	1.497	1.027	0.404	0.027	0.108
7	1.396	1.057	0.334	0.055	0.133
8	1.285	1.103	0.25	0.098	0.152
9	1.243	1.13	0.218	0.123	0.161
10	1.224	1.14	0.202	0.131	0.163
11	1.166	1.193	0.153	0.177	0.165
12	1.155	1.2	0.144	0.182	0.162
13	1.102	1.278	0.097	0.245	0.151
14	1.082	1.317	0.079	0.275	0.145
15	1.062	1.374	0.06	0.317	0.139
16	1.045	1.431	0.044	0.358	0.128
17	1.039	1.485	0.039	0.395	0.119
18	1.037	1.503	0.036	0.407	0.113
19	1.017	1.644	0.017	0.497	0.061
20	1.018	1.747	0.018	0.558	0.048

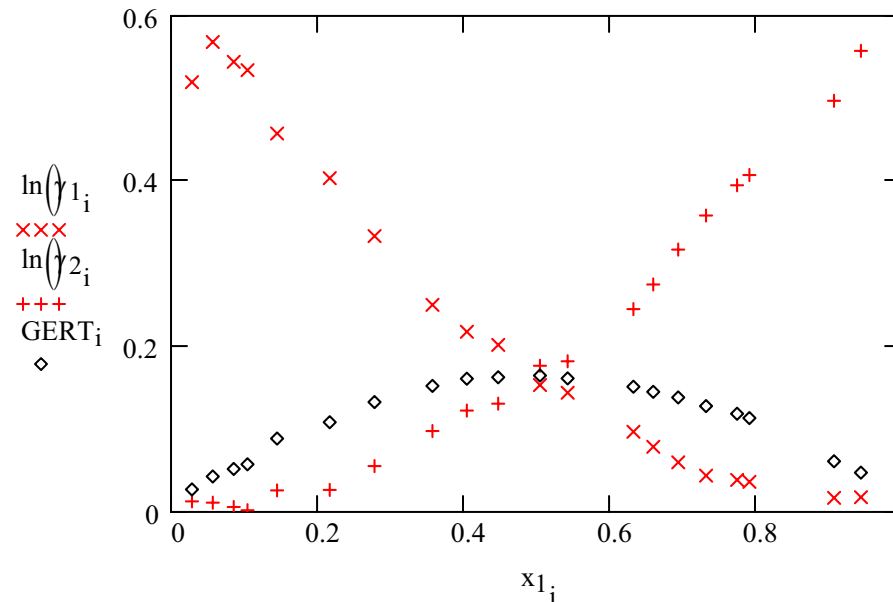

(a) Fit GE/RT data to Margules eqn. by linear least squares:

$$VX_i := x1_i \qquad VY_i := \frac{GERT_i}{x1_i \cdot x2_i}$$

$$\text{Slope} := \text{slope}(VX, VY) \qquad \text{Intercept} := \text{intercept}(VX, VY)$$

$$\text{Slope} = -0.018$$

$$\text{Intercept} = 0.708$$

$$A_{12} := \text{Intercept}$$

$$A_{21} := \text{Slope} + A_{12}$$

$$A_{12} = 0.708$$

$$A_{21} = 0.69 \qquad \text{Ans.}$$

The following equations give CALCULATED values:

$$\gamma_1(x_1, x_2) := \exp\left[x_2^2 \cdot \left[A_{12} + 2 \cdot (A_{21} - A_{12} \cdot x_1)\right]\right]$$

$$\gamma_2(x_1, x_2) := \exp\left[x_1^2 \cdot \left[A_{21} + 2 \cdot (A_{12} - A_{21} \cdot x_2)\right]\right]$$

$$j := 1..101$$

$$X_{1_j} := .01 \cdot j - .01$$

$$X_{2_j} := 1 - X_{1_j}$$

$$P_{\text{calc}_j} := X_{1_j} \cdot \gamma_1(X_{1_j}, X_{2_j}) \cdot P_{\text{sat}_1} + X_{2_j} \cdot \gamma_2(X_{1_j}, X_{2_j}) \cdot P_{\text{sat}_2}$$

$$Y_{1\text{calc}_j} := \frac{X_{1_j} \cdot \gamma_1(X_{1_j}, X_{2_j}) \cdot P_{\text{sat}_1}}{P_{\text{calc}_j}}$$

**P-x,y Diagram: Margules eqn. fit to GE/RT data.**

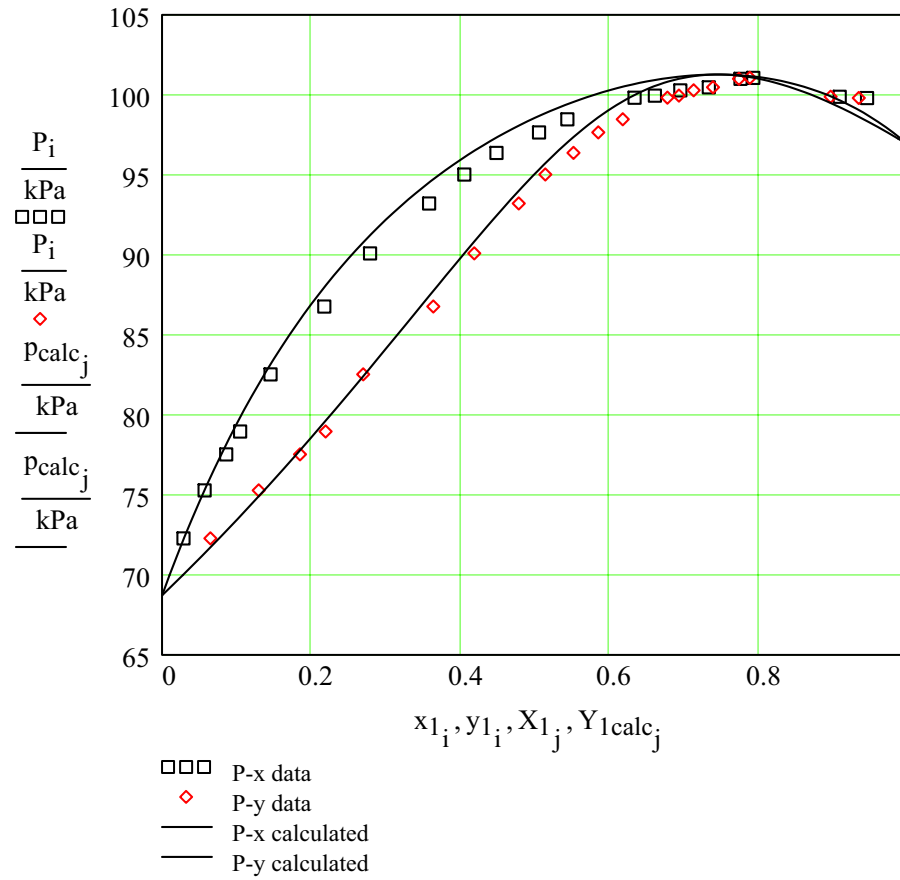

$$P_{\text{calc},i} := x_{1,i} \cdot \gamma_1(x_{1,i}, x_{2,i}) \cdot P_{\text{sat}1} + x_{2,i} \cdot \gamma_2(x_{1,i}, x_{2,i}) \cdot P_{\text{sat}2}$$

$$y_{1,\text{calc},i} := \frac{x_{1,i} \cdot \gamma_1(x_{1,i}, x_{2,i}) \cdot P_{\text{sat}1}}{P_{\text{calc},i}}$$

**RMS deviation in P:**

$$\text{RMS} := \sqrt{\sum_i \frac{(P_i - P_{\text{calc},i})^2}{n}}$$

**RMS = 0.851 kPa**

(b) Fit GE/RT data to van Laar eqn. by linear least squares:

$$VX_i := x_{1_i} \qquad VY_i := \frac{x_{1_i} \cdot x_{2_i}}{GERT_i}$$

$$\text{Slope} := \text{slope}(VX, VY) \qquad \text{Intercept} := \text{intercept}(VX, VY)$$

$$\text{Slope} = 0.015$$

$$\text{Intercept} = 1.442$$

$$a_{12} := \frac{1}{\text{Intercept}}$$

$$a_{21} := \frac{1}{(\text{Slope} + \text{Intercept})}$$

$$a_{12} = 0.693$$

$$a_{21} = 0.686$$

Ans.

$$\gamma_1(x_1, x_2) := \exp \left[ a_{12} \cdot \left( 1 + \frac{a_{12} \cdot x_1}{a_{21} \cdot x_2} \right)^{-2} \right]$$

$$\gamma_2(x_1, x_2) := \exp \left[ a_{21} \cdot \left( 1 + \frac{a_{21} \cdot x_2}{a_{12} \cdot x_1} \right)^{-2} \right]$$

$$j := 1..101 \qquad X_{1_j} := .01 \cdot j - .00999 \qquad \text{(To avoid singularities)}$$

$$X_{2_j} := 1 - X_{1_j}$$

$$P_{\text{calc}_j} := X_{1_j} \cdot \gamma_1(X_{1_j}, X_{2_j}) \cdot P_{\text{sat}_1} + X_{2_j} \cdot \gamma_2(X_{1_j}, X_{2_j}) \cdot P_{\text{sat}_2}$$

$$P_{\text{calc}_i} := x_{1_i} \cdot \gamma_1(x_{1_i}, x_{2_i}) \cdot P_{\text{sat}_1} + x_{2_i} \cdot \gamma_2(x_{1_i}, x_{2_i}) \cdot P_{\text{sat}_2}$$

$$Y_{1\text{calc}_j} := \frac{X_{1_j} \cdot \gamma_1(X_{1_j}, X_{2_j}) \cdot P_{\text{sat}_1}}{P_{\text{calc}_j}}$$

$$y_{1\text{calc}_i} := \frac{x_{1_i} \cdot \gamma_1(x_{1_i}, x_{2_i}) \cdot P_{\text{sat}_1}}{P_{\text{calc}_i}}$$



**P-x,y Diagram: van Laar eqn. fit to GE/RT data.**

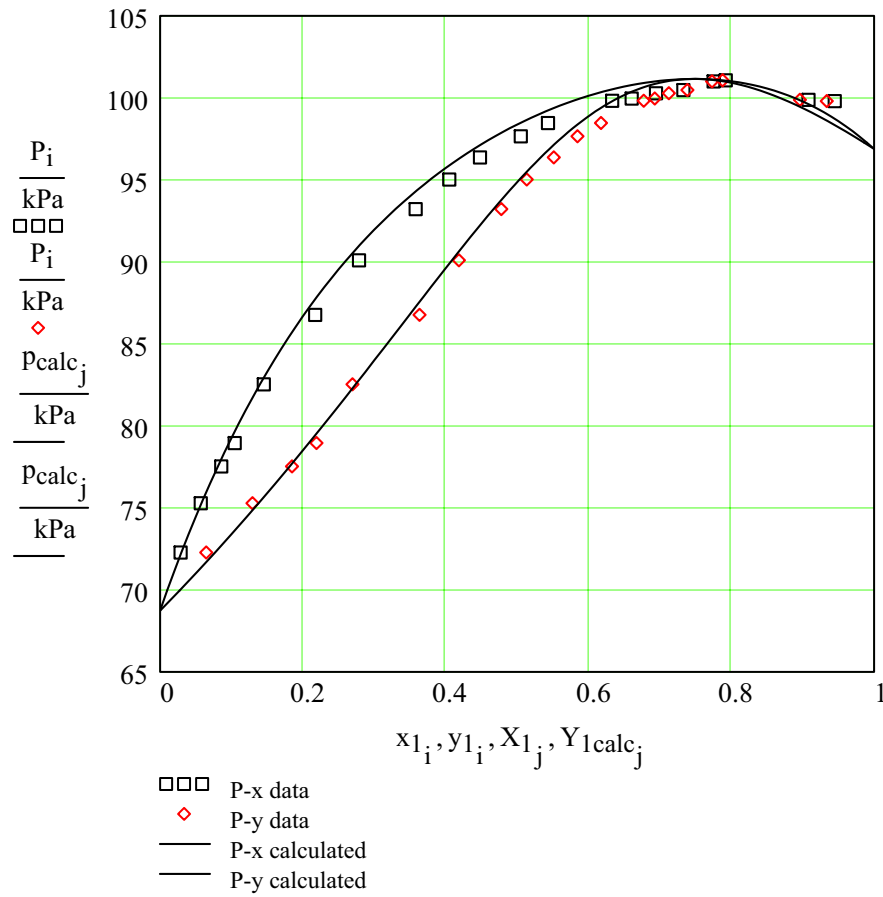

**RMS deviation in P:**

$$\text{RMS} := \sqrt{\sum_i \frac{(P_i - P_{\text{calc},i})^2}{n}}$$

RMS = 0.701 kPa

**(c) Fit GE/RT data to Wilson eqn. by non-linear least squares.**

**Minimize the sum of the squared errors using the Mathcad Minimize function.**

**Guesses:**       $\Lambda_{12} := 0.5$        $\Lambda_{21} := 1.0$

$$\text{SSE}(\Lambda_{12}, \Lambda_{21}) := \sum_i \left[ \text{GERT}_i + \begin{pmatrix} x_{1,i} \cdot \ln(x_{1,i} + x_{2,i} \cdot \Lambda_{12}) & \dots \\ + x_{2,i} \cdot \ln(x_{2,i} + x_{1,i} \cdot \Lambda_{21}) & \end{pmatrix} \right]^2$$

$$\begin{pmatrix} \Lambda_{12} \\ \Lambda_{21} \end{pmatrix} := \text{Minimize}(\text{SSE}, \Lambda_{12}, \Lambda_{21}) \quad \begin{pmatrix} \Lambda_{12} \\ \Lambda_{21} \end{pmatrix} = \begin{pmatrix} 0.71 \\ 0.681 \end{pmatrix} \quad \text{Ans.}$$

$$\gamma_1(x_1, x_2) := \frac{\exp\left[x_2 \cdot \left(\frac{\Lambda_{12}}{x_1 + x_2 \cdot \Lambda_{12}} - \frac{\Lambda_{21}}{x_2 + x_1 \cdot \Lambda_{21}}\right)\right]}{(x_1 + x_2 \cdot \Lambda_{12})}$$

$$\gamma_2(x_1, x_2) := \frac{\exp\left[-x_1 \cdot \left(\frac{\Lambda_{12}}{x_1 + x_2 \cdot \Lambda_{12}} - \frac{\Lambda_{21}}{x_2 + x_1 \cdot \Lambda_{21}}\right)\right]}{(x_2 + x_1 \cdot \Lambda_{21})}$$

$$j := 1..101 \quad X_{1,j} := .01 \cdot j - .01 \quad X_{2,j} := 1 - X_{1,j}$$

$$P_{\text{calc},j} := X_{1,j} \cdot \gamma_1(X_{1,j}, X_{2,j}) \cdot P_{\text{sat}1} + X_{2,j} \cdot \gamma_2(X_{1,j}, X_{2,j}) \cdot P_{\text{sat}2}$$

$$P_{\text{calc},i} := x_{1,i} \cdot \gamma_1(x_{1,i}, x_{2,i}) \cdot P_{\text{sat}1} + x_{2,i} \cdot \gamma_2(x_{1,i}, x_{2,i}) \cdot P_{\text{sat}2}$$

$$Y_{1\text{calc},j} := \frac{X_{1,j} \cdot \gamma_1(X_{1,j}, X_{2,j}) \cdot P_{\text{sat}1}}{P_{\text{calc},j}} \quad y_{1\text{calc},i} := \frac{x_{1,i} \cdot \gamma_1(x_{1,i}, x_{2,i}) \cdot P_{\text{sat}1}}{P_{\text{calc},i}}$$

**P-x,y diagram: Wilson eqn. fit to GE/RT data.**

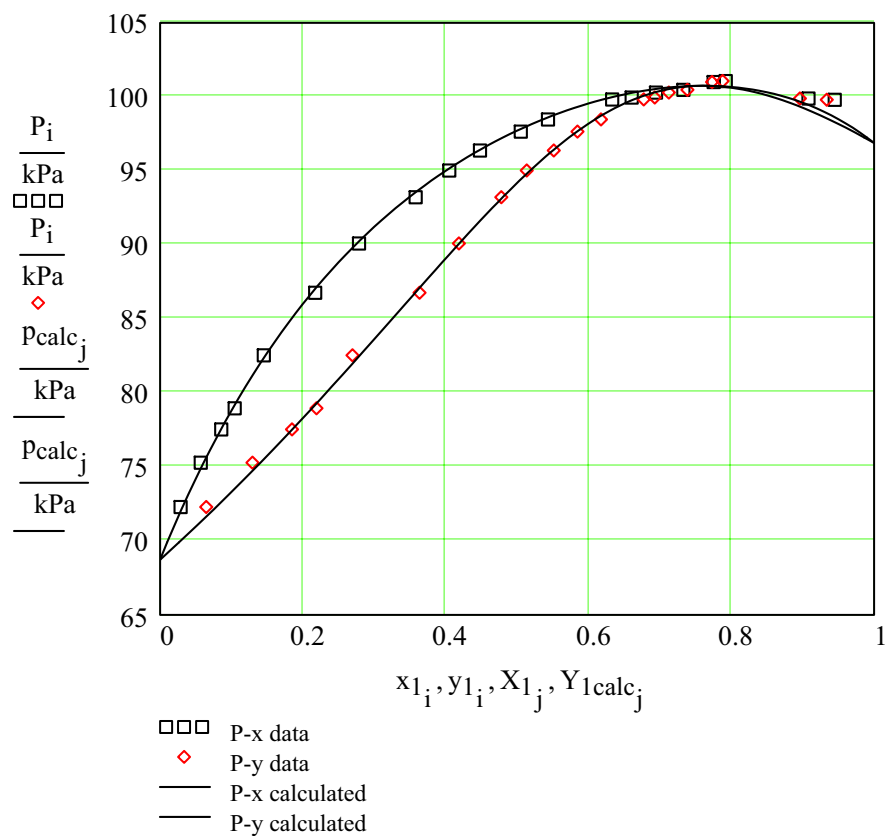

**RMS deviation in P:**

$$\text{RMS} := \sqrt{\sum_i \frac{(P_i - P_{\text{calc},i})^2}{n}} \quad \text{RMS} = 0.361 \text{ kPa}$$

**(d) BARKER'S METHOD by non-linear least squares.  
Margules equation.**

**Guesses for parameters: answers to Part (a).**

$$\gamma_1(x_1, x_2, A_{12}, A_{21}) := \exp\left[(x_2)^2 \cdot [A_{12} + 2 \cdot (A_{21} - A_{12} \cdot x_1)]\right]$$

$$\gamma_2(x_1, x_2, A_{12}, A_{21}) := \exp\left[(x_1)^2 \cdot [A_{21} + 2 \cdot (A_{12} - A_{21} \cdot x_2)]\right]$$

**Minimize the sum of the squared errors using the Mathcad Minimize function.**

**Guesses:**  $A_{12} := 0.5$        $A_{21} := 1.0$

$$SSE(A_{12}, A_{21}) := \sum_i \left[ P_i - \left( x_{1_i} \cdot \gamma_1(x_{1_i}, x_{2_i}, A_{12}, A_{21}) \cdot P_{sat1} \dots \right) \right]^2$$

$$\left( + x_{2_i} \cdot \gamma_2(x_{1_i}, x_{2_i}, A_{12}, A_{21}) \cdot P_{sat2} \right)$$

$$\begin{pmatrix} A_{12} \\ A_{21} \end{pmatrix} := \text{Minimize}(SSE, A_{12}, A_{21}) \quad \begin{pmatrix} A_{12} \\ A_{21} \end{pmatrix} = \begin{pmatrix} 0.644 \\ 0.672 \end{pmatrix} \quad \text{Ans.}$$

$$P_{calc_j} := x_{1_j} \cdot \gamma_1(x_{1_j}, x_{2_j}, A_{12}, A_{21}) \cdot P_{sat1} \dots$$

$$+ x_{2_j} \cdot \gamma_2(x_{1_j}, x_{2_j}, A_{12}, A_{21}) \cdot P_{sat2}$$

$$Y_{1calc_j} := \frac{x_{1_j} \cdot \gamma_1(x_{1_j}, x_{2_j}, A_{12}, A_{21}) \cdot P_{sat1}}{P_{calc_j}}$$

$$P_{calc_i} := x_{1_i} \cdot \gamma_1(x_{1_i}, x_{2_i}, A_{12}, A_{21}) \cdot P_{sat1} \dots$$

$$+ x_{2_i} \cdot \gamma_2(x_{1_i}, x_{2_i}, A_{12}, A_{21}) \cdot P_{sat2}$$

$$Y_{1calc_i} := \frac{x_{1_i} \cdot \gamma_1(x_{1_i}, x_{2_i}, A_{12}, A_{21}) \cdot P_{sat1}}{P_{calc_i}}$$

**RMS deviation in P:**

$$RMS := \sqrt{\sum_i \frac{(P_i - P_{calc_i})^2}{n}} \quad \text{RMS} = 0.365 \text{ kPa}$$

### P-x-y diagram, Margules eqn. by Barker's method

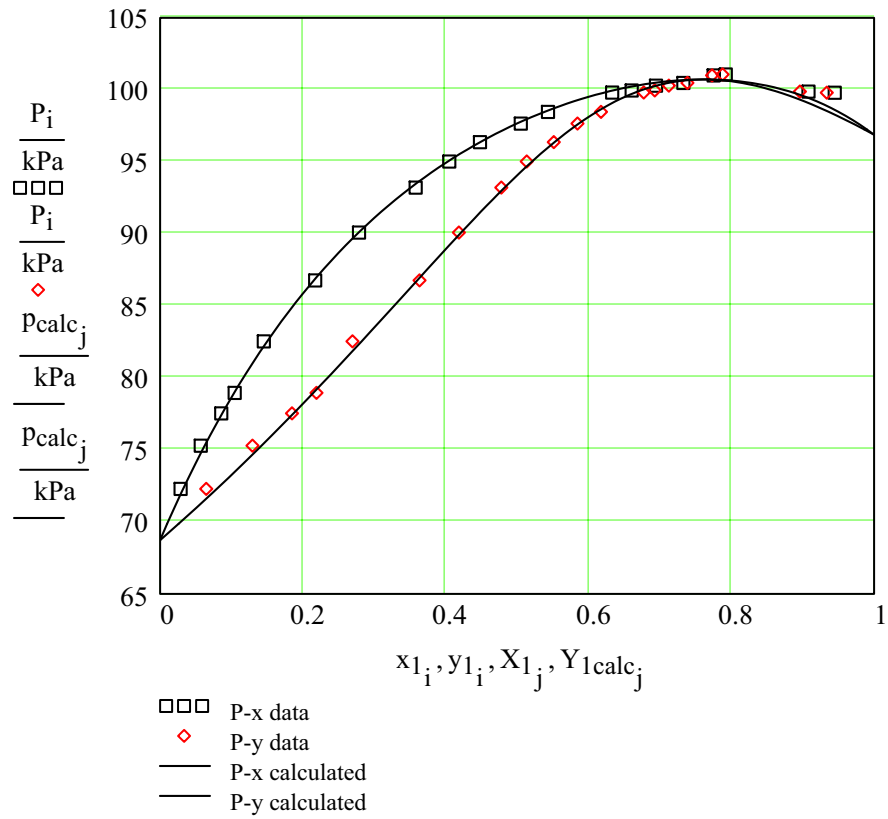

### Residuals in P and y1

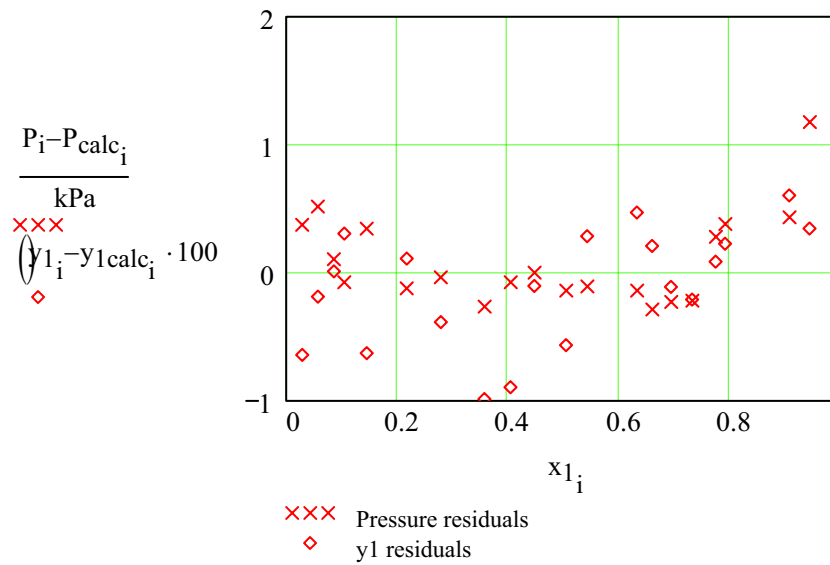

(e) **BARKER'S METHOD** by non-linear least squares.  
**van Laar equation.**

**Guesses for parameters: answers to Part (b).**

$$j := 1..101 \quad X_{1j} := .01 \cdot j - .00999 \quad X_{2j} := 1 - X_{1j}$$

$$\gamma_1(x_1, x_2, a_{12}, a_{21}) := \exp \left[ a_{12} \cdot \left( 1 + \frac{a_{12} \cdot x_1}{a_{21} \cdot x_2} \right)^{-2} \right]$$

$$\gamma_2(x_1, x_2, a_{12}, a_{21}) := \exp \left[ a_{21} \cdot \left( 1 + \frac{a_{21} \cdot x_2}{a_{12} \cdot x_1} \right)^{-2} \right]$$

**Minimize the sum of the squared errors using the Mathcad Minimize function.**

**Guesses:**  $a_{12} := 0.5 \quad a_{21} := 1.0$

$$SSE(a_{12}, a_{21}) := \sum_i \left[ P_i - \left( x_{1i} \cdot \gamma_1(x_{1i}, x_{2i}, a_{12}, a_{21}) \cdot Psat_1 \dots \right. \right. \\ \left. \left. + x_{2i} \cdot \gamma_2(x_{1i}, x_{2i}, a_{12}, a_{21}) \cdot Psat_2 \right) \right]^2$$

$$\begin{pmatrix} a_{12} \\ a_{21} \end{pmatrix} := \text{Minimize}(SSE, a_{12}, a_{21}) \quad \begin{pmatrix} a_{12} \\ a_{21} \end{pmatrix} = \begin{pmatrix} 0.644 \\ 0.672 \end{pmatrix} \quad \text{Ans.}$$

$$P_{calc_j} := X_{1j} \cdot \gamma_1(X_{1j}, X_{2j}, a_{12}, a_{21}) \cdot Psat_1 \dots \\ + X_{2j} \cdot \gamma_2(X_{1j}, X_{2j}, a_{12}, a_{21}) \cdot Psat_2$$

$$Y_{1calc_j} := \frac{X_{1j} \cdot \gamma_1(X_{1j}, X_{2j}, a_{12}, a_{21}) \cdot Psat_1}{P_{calc_j}}$$

$$P_{calc_i} := x_{1i} \cdot \gamma_1(x_{1i}, x_{2i}, a_{12}, a_{21}) \cdot Psat_1 \dots \\ + x_{2i} \cdot \gamma_2(x_{1i}, x_{2i}, a_{12}, a_{21}) \cdot Psat_2$$

$$Y_{1calc_i} := \frac{x_{1i} \cdot \gamma_1(x_{1i}, x_{2i}, a_{12}, a_{21}) \cdot Psat_1}{P_{calc_i}}$$

**RMS deviation in P:**

$$\text{RMS} := \sqrt{\sum_i \frac{(P_i - P_{\text{calc}_i})^2}{n}}$$

RMS = 0.364 kPa

**P-x,y diagram, van Laar Equation by Barker's Method**

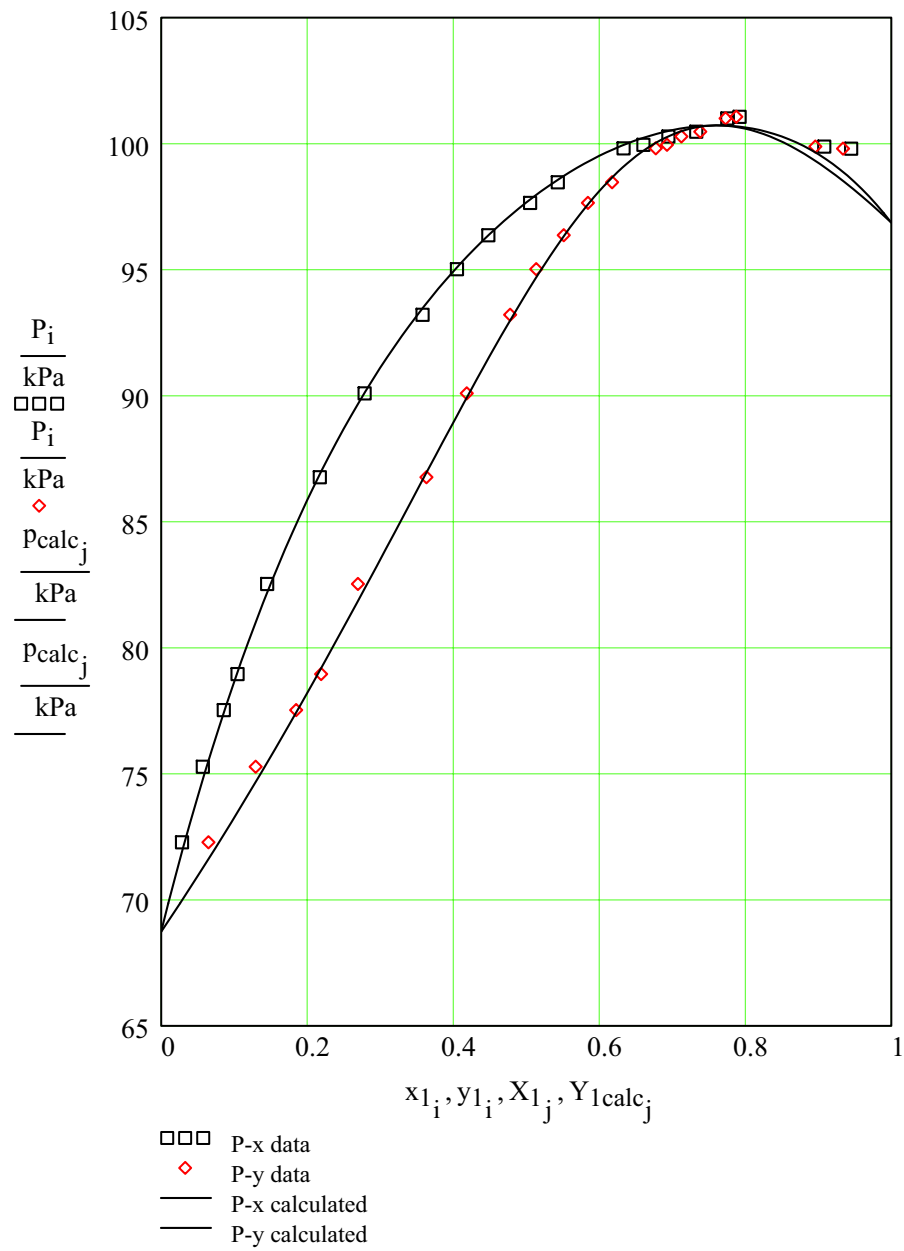

**Residuals in P and y1.**

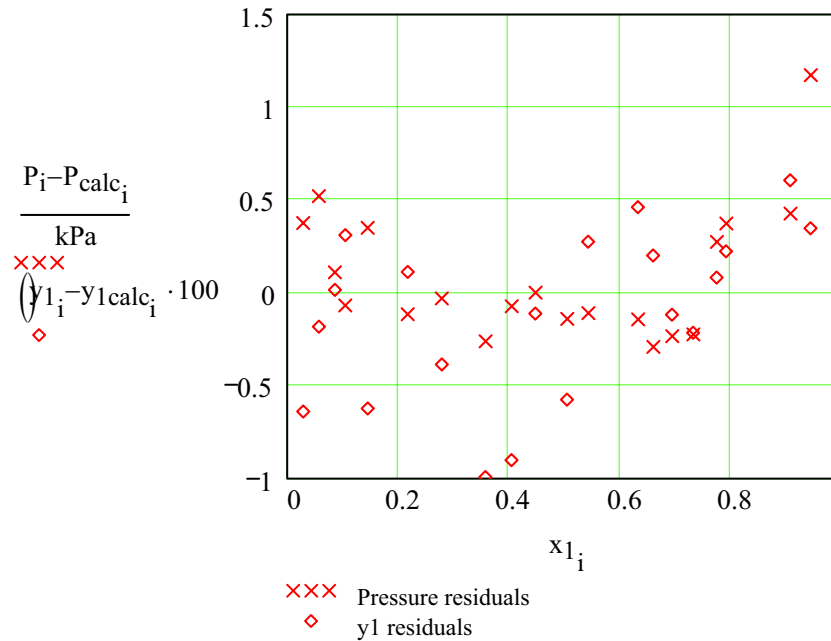

**(f) BARKER'S METHOD by non-linear least squares.**

**Wilson equation.**

**Guesses for parameters: answers to Part (c).**

$$j := 1..101 \quad X_{1,j} := .01 \cdot j - .01 \quad X_{2,j} := 1 - X_{1,j}$$

$$\gamma_1(x_1, \Lambda_{12}, \Lambda_{21}) := \exp \left[ -\ln(x_1 + x_2 \cdot \Lambda_{12}) + x_2 \cdot \left( \frac{\Lambda_{12}}{x_1 + x_2 \cdot \Lambda_{12}} - \frac{\Lambda_{21}}{x_2 + x_1 \cdot \Lambda_{21}} \right) \right]$$

$$\gamma_2(x_1, \Lambda_{12}, \Lambda_{21}) := \exp \left[ -\ln(x_2 + x_1 \cdot \Lambda_{21}) + x_1 \cdot \left( \frac{-\Lambda_{12}}{x_1 + x_2 \cdot \Lambda_{12}} + \frac{\Lambda_{21}}{x_2 + x_1 \cdot \Lambda_{21}} \right) \right]$$

**Minimize the sum of the squared errors using the Mathcad Minimize function.**

**Guesses:**  $\Lambda_{12} := 0.5 \quad \Lambda_{21} := 1.0$



$$SSE(\Lambda_{12}, \Lambda_{21}) := \sum_i \left[ P_i - \left( x_{1i} \cdot \gamma_1(x_{1i}, \Lambda_{21}, \Lambda_{12}, \Lambda_{21}) \cdot P_{sat1} \dots \right) \right]^2$$

$$\begin{pmatrix} \Lambda_{12} \\ \Lambda_{21} \end{pmatrix} := \text{Minimize}(SSE, \Lambda_{12}, \Lambda_{21}) \quad \begin{pmatrix} \Lambda_{12} \\ \Lambda_{21} \end{pmatrix} = \begin{pmatrix} 0.732 \\ 0.663 \end{pmatrix} \quad \text{Ans.}$$

$$P_{calc_j} := x_{1j} \cdot \gamma_1(x_{1j}, \Lambda_{2j}, \Lambda_{12}, \Lambda_{21}) \cdot P_{sat1} \dots + x_{2j} \cdot \gamma_2(x_{1j}, \Lambda_{2j}, \Lambda_{12}, \Lambda_{21}) \cdot P_{sat2}$$

$$Y_{1calc_j} := \frac{x_{1j} \cdot \gamma_1(x_{1j}, \Lambda_{2j}, \Lambda_{12}, \Lambda_{21}) \cdot P_{sat1}}{P_{calc_j}}$$

$$P_{calc_i} := x_{1i} \cdot \gamma_1(x_{1i}, \Lambda_{2i}, \Lambda_{12}, \Lambda_{21}) \cdot P_{sat1} \dots + x_{2i} \cdot \gamma_2(x_{1i}, \Lambda_{2i}, \Lambda_{12}, \Lambda_{21}) \cdot P_{sat2}$$

$$Y_{1calc_i} := \frac{x_{1i} \cdot \gamma_1(x_{1i}, \Lambda_{2i}, \Lambda_{12}, \Lambda_{21}) \cdot P_{sat1}}{P_{calc_i}}$$

**RMS deviation in P:**

$$RMS := \sqrt{\sum_i \frac{(P_i - P_{calc_i})^2}{n}}$$

$$RMS = 0.35 \text{ kPa}$$

### P-x,y diagram, Wilson Equation by Barker's Method

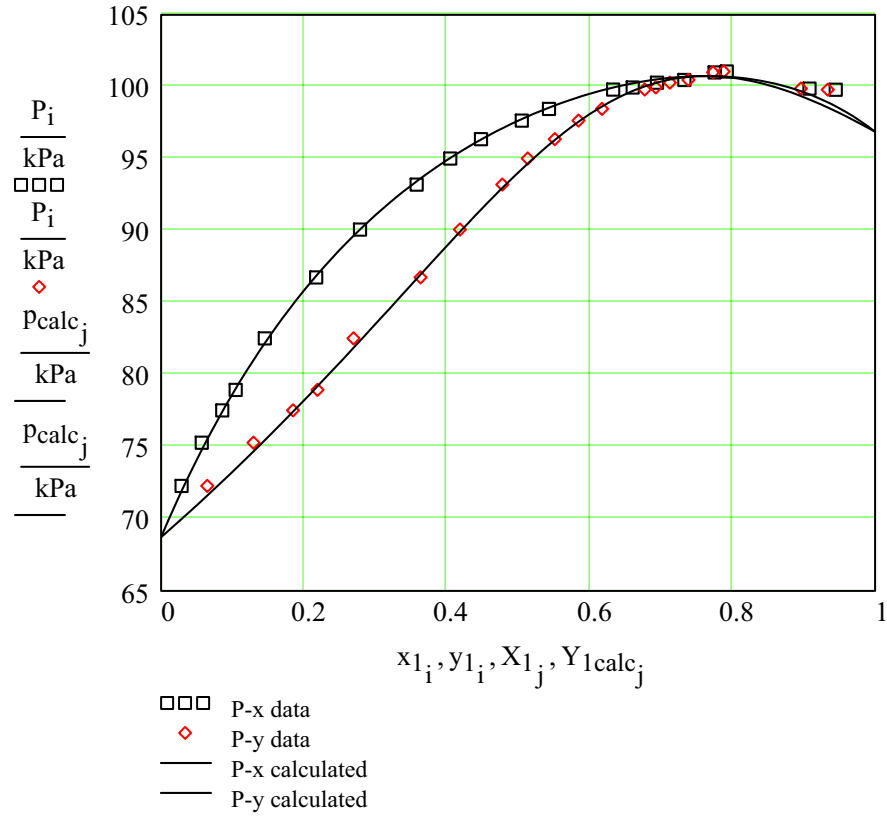

### Residuals in P and y1.

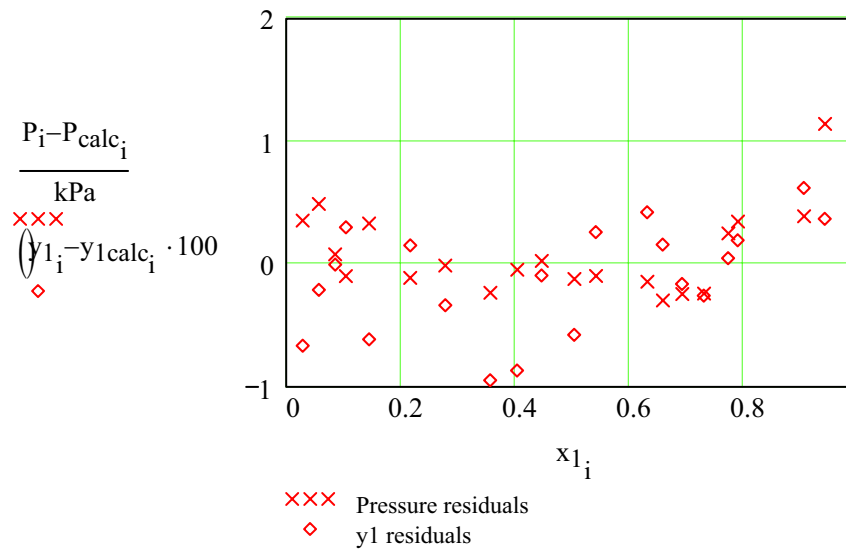

12.6 Methyl t-butyl ether(1)/Dichloromethane--VLE data: T := 308.15·K

P :=	$\begin{pmatrix} 83.402 \\ 82.202 \\ 80.481 \\ 76.719 \\ 72.442 \\ 68.005 \\ 65.096 \\ 59.651 \\ 56.833 \\ 53.689 \\ 51.620 \\ 50.455 \\ 49.926 \\ 49.720 \end{pmatrix}$	·kPa	x <sub>1</sub> :=	$\begin{pmatrix} 0.0330 \\ 0.0579 \\ 0.0924 \\ 0.1665 \\ 0.2482 \\ 0.3322 \\ 0.3880 \\ 0.5036 \\ 0.5749 \\ 0.6736 \\ 0.7676 \\ 0.8476 \\ 0.9093 \\ 0.9529 \end{pmatrix}$	y <sub>1</sub> :=	$\begin{pmatrix} 0.0141 \\ 0.0253 \\ 0.0416 \\ 0.0804 \\ 0.1314 \\ 0.1975 \\ 0.2457 \\ 0.3686 \\ 0.4564 \\ 0.5882 \\ 0.7176 \\ 0.8238 \\ 0.9002 \\ 0.9502 \end{pmatrix}$
------	--	------	-------------------	--	-------------------	--

$$x_2 := \overrightarrow{(1 - x_1)}$$

$$y_2 := \overrightarrow{(1 - y_1)}$$

$$P_{sat1} := 49.624 \cdot \text{kPa}$$

$$P_{sat2} := 85.265 \cdot \text{kPa}$$

Calculate EXPERIMENTAL values of activity coefficients and excess Gibbs energy.

$$\gamma_1 := \frac{\overrightarrow{y_1 \cdot P}}{\overrightarrow{x_1 \cdot P_{sat1}}} \quad \gamma_2 := \frac{\overrightarrow{y_2 \cdot P}}{\overrightarrow{x_2 \cdot P_{sat2}}} \quad \text{GERT} := \overrightarrow{(x_1 \cdot \ln(\gamma_1) + x_2 \cdot \ln(\gamma_2))}$$

$$\text{GERT}_{x1x2} := \frac{\overrightarrow{\text{GERT}}}{\overrightarrow{x_1 \cdot x_2}} \quad n := \text{rows}(P) \quad n = 14 \quad i := 1..n$$

(a) Fit GE/RT data to Margules eqn. by nonlinear least squares.

Minimize sum of the squared errors using the Mathcad Minimize function.

Guesses:  $A_{12} := -0.3$      $A_{21} := -0.5$      $C := 0.2$

$$\text{SSE}(A_{12}, A_{21}, C) := \sum_i \left[ \text{GERT}_i - (A_{21} \cdot x_{1_i} + A_{12} \cdot x_{2_i} - C \cdot x_{1_i} \cdot x_{2_i}) \cdot x_{1_i} \cdot x_{2_i} \right]^2$$

$$\begin{pmatrix} A_{12} \\ A_{21} \\ C \end{pmatrix} := \text{Minimize}(\text{SSE}, A_{12}, A_{21}, C) \quad \begin{pmatrix} A_{12} \\ A_{21} \\ C \end{pmatrix} = \begin{pmatrix} -0.336 \\ -0.535 \\ 0.195 \end{pmatrix} \quad \text{Ans.}$$

(b) Plot data and fit

$$\text{GeRTx1x2}(x_1, x_2) := (A_{21} \cdot x_1 + A_{12} \cdot x_2 - C \cdot x_1 \cdot x_2)$$

$$\text{GeRT}(x_1, x_2) := \text{GeRTx1x2}(x_1, x_2) \cdot x_1 \cdot x_2$$

$$\ln \gamma_1(x_1, x_2) := x_2^2 \cdot [A_{12} + 2 \cdot (A_{21} - A_{12} - C \cdot x_1 + 3 \cdot C \cdot x_1^2)]$$

$$\ln \gamma_2(x_1, x_2) := x_1^2 \cdot [A_{21} + 2 \cdot (A_{12} - A_{21} - C \cdot x_2 + 3 \cdot C \cdot x_2^2)]$$

$$j := 1..101$$

$$X_{1_j} := .01 \cdot j - .01$$

$$X_{2_j} := 1 - X_{1_j}$$

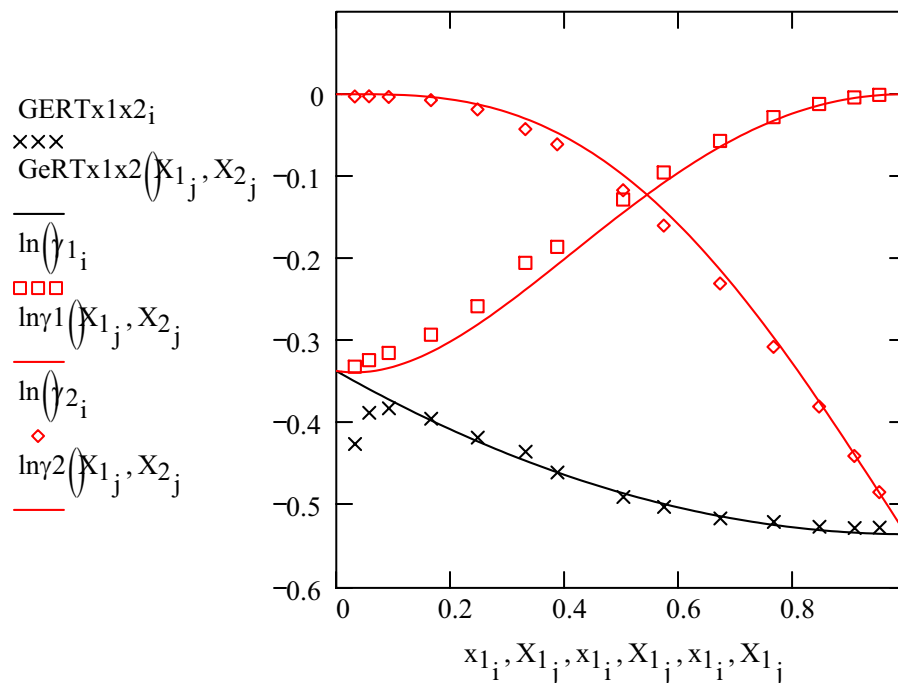

**(c) Plot Pxy diagram with fit and data**

$$\gamma_1(x_1, x_2) := \exp(\ln \gamma_1(x_1, x_2))$$

$$\gamma_2(x_1, x_2) := \exp(\ln \gamma_2(x_1, x_2))$$

$$P_{\text{calc},j} := X_{1,j} \cdot \gamma_1(X_{1,j}, X_{2,j}) \cdot P_{\text{sat}1} + X_{2,j} \cdot \gamma_2(X_{1,j}, X_{2,j}) \cdot P_{\text{sat}2}$$

$$y_{1\text{calc},j} := \frac{X_{1,j} \cdot \gamma_1(X_{1,j}, X_{2,j}) \cdot P_{\text{sat}1}}{P_{\text{calc},j}}$$

**P-x,y Diagram from Margules Equation fit to GE/RT data.**

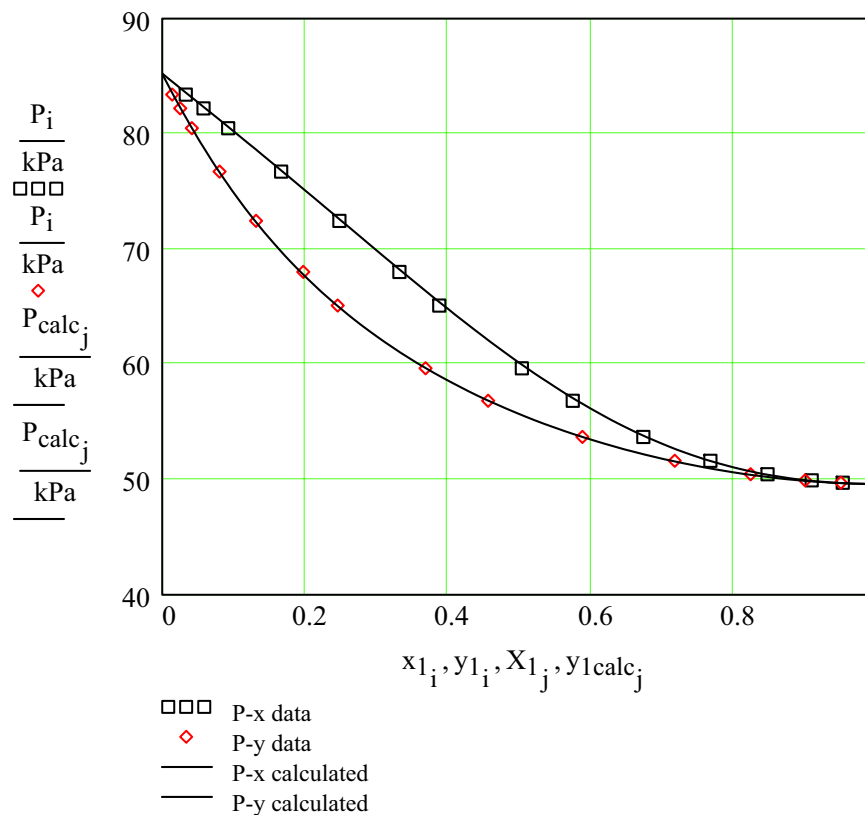

**(d) Consistency Test:**  $\delta G_{\text{ERT}_i} := G_{\text{ERT}}(x_{1_i}, x_{2_i}) - G_{\text{ERT}_i}$

$$\delta \ln \gamma_1 \gamma_{2i} := \ln \left( \frac{\gamma_1(x_{1_i}, x_{2_i})}{\gamma_2(x_{1_i}, x_{2_i})} \right) - \ln \left( \frac{\gamma_{1_i}}{\gamma_{2_i}} \right)$$

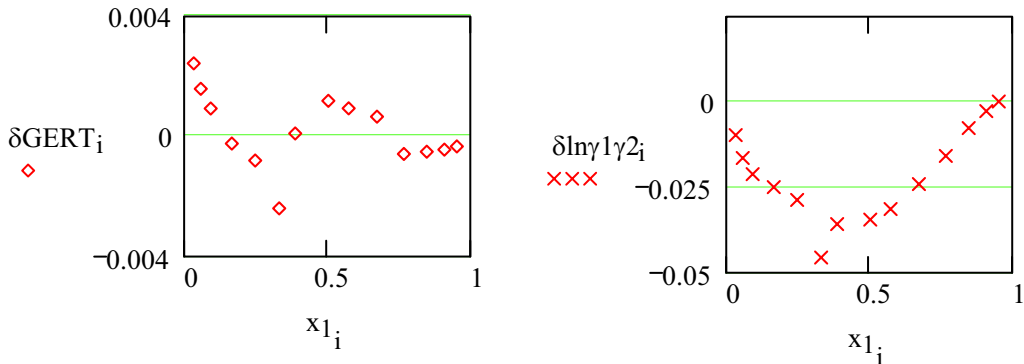

Calculate mean absolute deviation of residuals

$$\text{mean}(|\delta GERT_i|) = 9.391 \times 10^{-4}$$

$$\text{mean}(|\delta \ln \gamma_1 \gamma_2_i|) = 0.021$$

(e) Barker's Method by non-linear least squares:  
Margules Equation

$$\gamma_1(x_1, x_2, A_{12}, A_{21}, C) := \exp \left[ (x_2)^2 \cdot \frac{A_{12} + 2 \cdot (A_{21} - A_{12} - C \cdot x_1 \dots)}{+ 3 \cdot C \cdot x_1^2} \right]$$

$$\gamma_2(x_1, x_2, A_{12}, A_{21}, C) := \exp \left[ (x_1)^2 \cdot \frac{A_{21} + 2 \cdot (A_{12} - A_{21} - C \cdot x_2 \dots)}{+ 3 \cdot C \cdot x_2^2} \right]$$

Minimize sum of the squared errors using the Mathcad Minimize function.

Guesses:  $A_{12} := -0.3$      $A_{21} := -0.5$      $C := 0.2$

$$\text{SSE}(A_{12}, A_{21}, C) := \sum_i \left[ P_i - \left( x_{1_i} \cdot \gamma_1(x_{1_i}, x_{2_i}, A_{12}, A_{21}, C) \cdot P_{\text{sat}1} \dots \right) \right]^2$$

$$\begin{pmatrix} A_{12} \\ A_{21} \\ C \end{pmatrix} := \text{Minimize}(\text{SSE}, A_{12}, A_{21}, C) \quad \begin{pmatrix} A_{12} \\ A_{21} \\ C \end{pmatrix} = \begin{pmatrix} -0.364 \\ -0.521 \\ 0.23 \end{pmatrix} \quad \text{Ans.}$$

**Plot P-x,y diagram for Margules Equation with parameters from Barker's Method.**

$$P_{\text{calc}_j} := X_{1_j} \cdot \gamma_1(X_{1_j}, X_{2_j}, A_{12}, A_{21}, C) \cdot P_{\text{sat}_1} \dots \\ + X_{2_j} \cdot \gamma_2(X_{1_j}, X_{2_j}, A_{12}, A_{21}, C) \cdot P_{\text{sat}_2}$$

$$y_{1\text{calc}_j} := \frac{X_{1_j} \cdot \gamma_1(X_{1_j}, X_{2_j}, A_{12}, A_{21}, C) \cdot P_{\text{sat}_1}}{P_{\text{calc}_j}}$$

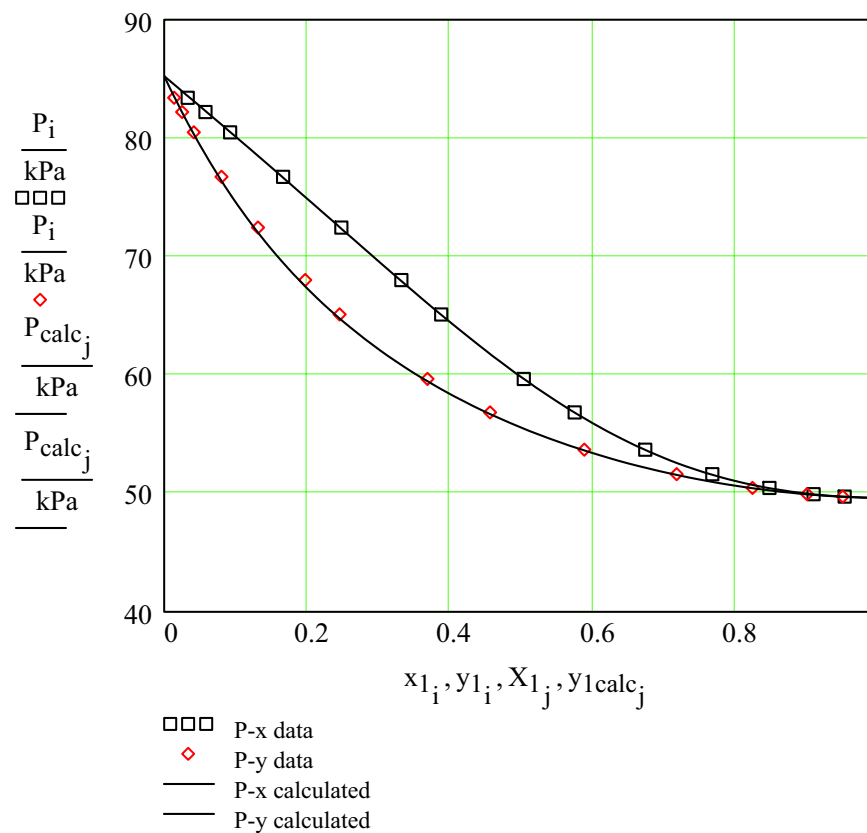

$$P_{\text{calc}_i} := x_{1_i} \cdot \gamma_1(x_{1_i}, x_{2_i}, A_{12}, A_{21}, C) \cdot P_{\text{sat}_1} \dots \\ + x_{2_i} \cdot \gamma_2(x_{1_i}, x_{2_i}, A_{12}, A_{21}, C) \cdot P_{\text{sat}_2}$$

$$y_{1\text{calc}_i} := \frac{x_{1_i} \cdot \gamma_1(x_{1_i}, x_{2_i}, A_{12}, A_{21}, C) \cdot P_{\text{sat}_1}}{P_{\text{calc}_i}}$$

**Plot of P and y1 residuals.**

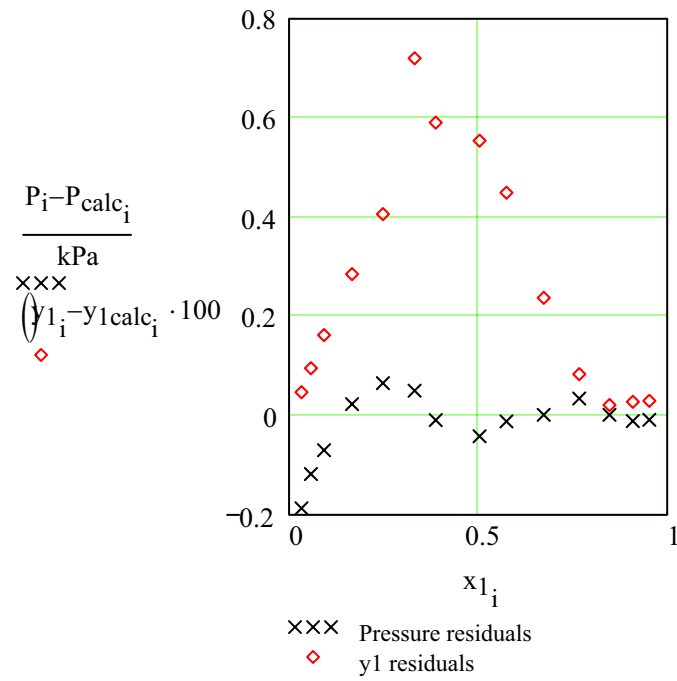

**RMS deviations in P:**

$$RMS := \sqrt{\sum_i \frac{(P_i - P_{calc_i})^2}{n}}$$

RMS = 0.068 kPa



12.8 (a) Data:

$$x_1 := \begin{pmatrix} 0.0523 \\ 0.1299 \\ 0.2233 \\ 0.2764 \\ 0.3482 \\ 0.4187 \\ 0.5001 \\ 0.5637 \\ 0.6469 \\ 0.7832 \\ 0.8576 \\ 0.9388 \\ 0.9813 \end{pmatrix}$$

$$\gamma_1 := \begin{pmatrix} 1.202 \\ 1.307 \\ 1.295 \\ 1.228 \\ 1.234 \\ 1.180 \\ 1.129 \\ 1.120 \\ 1.076 \\ 1.032 \\ 1.016 \\ 1.001 \\ 1.003 \end{pmatrix}$$

$$\gamma_2 := \begin{pmatrix} 1.002 \\ 1.004 \\ 1.006 \\ 1.024 \\ 1.022 \\ 1.049 \\ 1.092 \\ 1.102 \\ 1.170 \\ 1.298 \\ 1.393 \\ 1.600 \\ 1.404 \end{pmatrix}$$

$$n := \text{rows}(x_1)$$

$$i := 1..n$$

$$n = 13$$

$$x_{2_i} := 1 - x_{1_i}$$

$$\text{GERT}_i := x_{1_i} \cdot \ln(\gamma_{1_i}) + x_{2_i} \cdot \ln(\gamma_{2_i})$$

(b) Fit GE/RT data to Margules eqn. by linear least-squares procedure:

$$X_i := x_{1_i}$$

$$Y_i := \frac{\text{GERT}_i}{x_{1_i} \cdot x_{2_i}}$$

$$\text{Slope} := \text{slope}(X, Y)$$

$$\text{Intercept} := \text{intercept}(X, Y)$$

$$\text{Slope} = 0.247$$

$$\text{Intercept} = 0.286$$

$$A_{12} := \text{Intercept}$$

$$A_{21} := \text{Slope} + A_{12}$$

$$A_{12} = 0.286$$

$$A_{21} = 0.534$$

Ans.

$$\gamma_1(x_1, x_2) := \exp\left[ x_2^2 \cdot \left[ A_{12} + 2 \cdot (A_{21} - A_{12} \cdot x_1) \right] \right]$$

$$\gamma_2(x_1, x_2) := \exp\left[ x_1^2 \cdot \left[ A_{21} + 2 \cdot (A_{12} - A_{21} \cdot x_2) \right] \right]$$

$$\text{GeRT}(x_1, x_2) := x_1 \cdot \ln(\gamma_1(x_1, x_2)) + x_2 \cdot \ln(\gamma_2(x_1, x_2))$$

**Plot of data and correlation:**

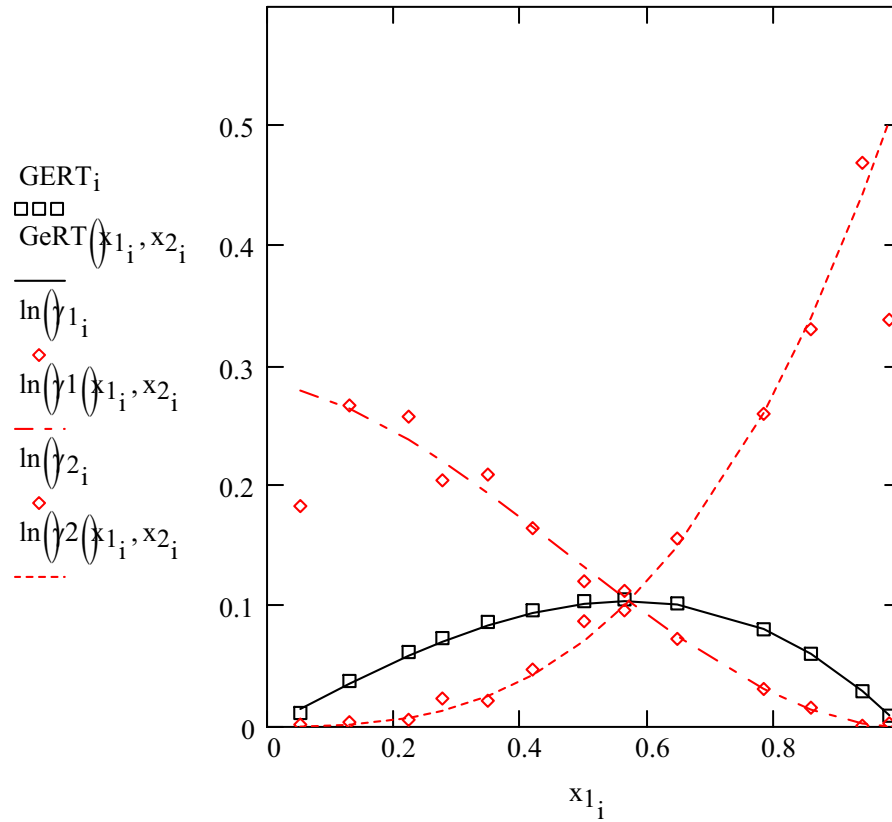

**(c) Calculate and plot residuals for consistency test:**

$$\delta GERT_i := GeRT(x_{1_i}, x_{2_i}) - GERT_i$$

$$\delta \ln \gamma_1 \gamma_{2_i} := \ln \left( \frac{\gamma_1(x_{1_i}, x_{2_i})}{\gamma_2(x_{1_i}, x_{2_i})} \right) - \ln \left( \frac{\gamma_{1_i}}{\gamma_{2_i}} \right)$$

$\delta G_{ERT_i} =$	$\delta \ln \gamma_1 \gamma_2 =$
$3.314 \cdot 10^{-3}$	0.098
$-2.264 \cdot 10^{-3}$	$-9.153 \cdot 10^{-5}$
$-3.14 \cdot 10^{-3}$	-0.021
$-2.998 \cdot 10^{-3}$	0.026
$-2.874 \cdot 10^{-3}$	-0.019
$-2.22 \cdot 10^{-3}$	$5.934 \cdot 10^{-3}$
$-2.174 \cdot 10^{-3}$	0.028
$-1.553 \cdot 10^{-3}$	$-9.59 \cdot 10^{-3}$
$-8.742 \cdot 10^{-4}$	$9.139 \cdot 10^{-3}$
$2.944 \cdot 10^{-4}$	$-5.617 \cdot 10^{-4}$
$5.962 \cdot 10^{-5}$	-0.011
$9.025 \cdot 10^{-5}$	0.028
$4.236 \cdot 10^{-4}$	-0.168

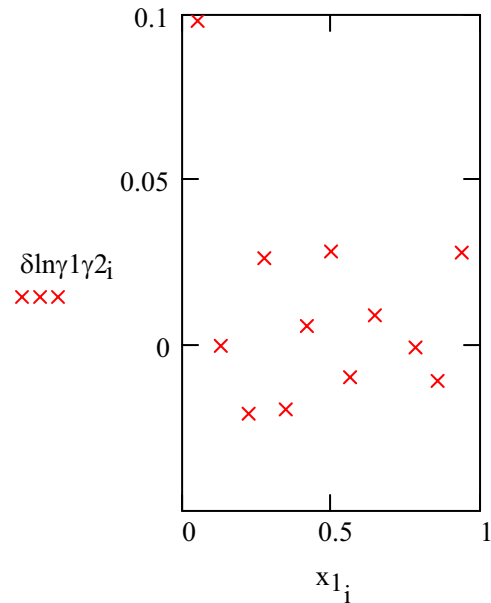

Calculate mean absolute deviation of residuals:

$$\text{mean}(|\delta G_{ERT}|) = 1.615 \times 10^{-3}$$

$$\text{mean}(|\delta \ln \gamma_1 \gamma_2|) = 0.03$$

Based on the graph and mean absolute deviations, the data show a high degree of consistency

### 12.9 Acetonitrile(1)/Benzene(2)-- VLE data

T := 318.15·K

P :=	(31.957)	·kPa
	33.553	
	35.285	
	36.457	
	36.996	
	37.068	
	36.978	
	36.778	
	35.792	
	34.372	
	32.331	
	(30.038)	

x <sub>1</sub> :=	(0.0455)
	0.0940
	0.1829
	0.2909
	0.3980
	0.5069
	0.5458
	0.5946
	0.7206
	0.8145
	0.8972
	(0.9573)

y <sub>1</sub> :=	(0.1056)
	0.1818
	0.2783
	0.3607
	0.4274
	0.4885
	0.5098
	0.5375
	0.6157
	0.6913
	0.7869
	(0.8916)

$$x_2 := \overrightarrow{(1 - x_1)}$$

$$y_2 := \overrightarrow{(1 - y_1)}$$

$$P_{sat1} := 27.778 \cdot \text{kPa}$$

$$P_{sat2} := 29.819 \cdot \text{kPa}$$

Calculate EXPERIMENTAL values of activity coefficients and excess Gibbs energy.

$$\gamma_1 := \frac{\overrightarrow{y_1 \cdot P}}{x_1 \cdot P_{sat1}} \quad \gamma_2 := \frac{\overrightarrow{y_2 \cdot P}}{x_2 \cdot P_{sat2}} \quad \text{GERT} := \overrightarrow{(x_1 \cdot \ln(\gamma_1) + x_2 \cdot \ln(\gamma_2))}$$

$$\text{GERT}_{x1x2} := \frac{\overrightarrow{\text{GERT}}}{x_1 \cdot x_2} \quad n := \text{rows}(P) \quad n = 12 \quad i := 1..n$$

(a) Fit GE/RT data to Margules eqn. by nonlinear least squares.

Minimize sum of the squared errors using the Mathcad Minimize function.

Guesses:  $A_{12} := -0.3 \quad A_{21} := -0.5 \quad C := 0.2$

$$\text{SSE}(A_{12}, A_{21}, C) := \sum_i \left[ \text{GERT}_i - (A_{21} \cdot x_{1i} + A_{12} \cdot x_{2i} - C \cdot x_{1i} \cdot x_{2i}) \cdot x_{1i} \cdot x_{2i} \right]^2$$

$$\begin{pmatrix} A_{12} \\ A_{21} \\ C \end{pmatrix} := \text{Minimize}(\text{SSE}, A_{12}, A_{21}, C) \quad \begin{pmatrix} A_{12} \\ A_{21} \\ C \end{pmatrix} = \begin{pmatrix} 1.128 \\ 1.155 \\ 0.53 \end{pmatrix} \quad \text{Ans.}$$

(b) Plot data and fit

$$\text{GeRT}_{x1x2}(x_1, x_2) := (A_{21} \cdot x_1 + A_{12} \cdot x_2 - C \cdot x_1 \cdot x_2)$$

$$\text{GeRT}(x_1, x_2) := \text{GeRT}_{x1x2}(x_1, x_2) \cdot x_1 \cdot x_2$$

$$\ln \gamma_1(x_1, x_2) := x_2^2 \cdot [A_{12} + 2 \cdot (A_{21} - A_{12} - C) \cdot x_1 + 3 \cdot C \cdot x_1^2]$$

$$\ln \gamma_2(x_1, x_2) := x_1^2 \cdot [A_{21} + 2 \cdot (A_{12} - A_{21} - C) \cdot x_2 + 3 \cdot C \cdot x_2^2]$$

$$j := 1..101$$

$$X_{1j} := .01 \cdot j - .01$$

$$X_{2j} := 1 - X_{1j}$$

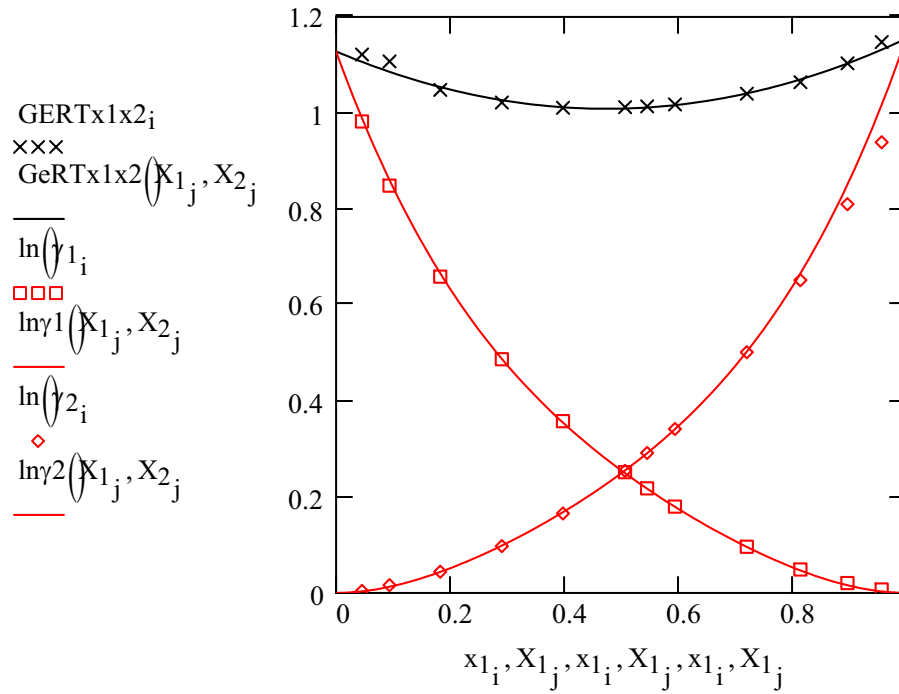

**(c) Plot Pxy diagram with fit and data**

$$\gamma_1(x_1, x_2) := \exp(\ln\gamma_1(x_1, x_2))$$

$$\gamma_2(x_1, x_2) := \exp(\ln\gamma_2(x_1, x_2))$$

$$P_{\text{calc}_j} := X_{1j} \cdot \gamma_1(X_{1j}, X_{2j}) \cdot P_{\text{sat}_1} + X_{2j} \cdot \gamma_2(X_{1j}, X_{2j}) \cdot P_{\text{sat}_2}$$

$$y_{1\text{calc}_j} := \frac{X_{1j} \cdot \gamma_1(X_{1j}, X_{2j}) \cdot P_{\text{sat}_1}}{P_{\text{calc}_j}}$$

**P-x,y Diagram from Margules Equation fit to GE/RT data.**

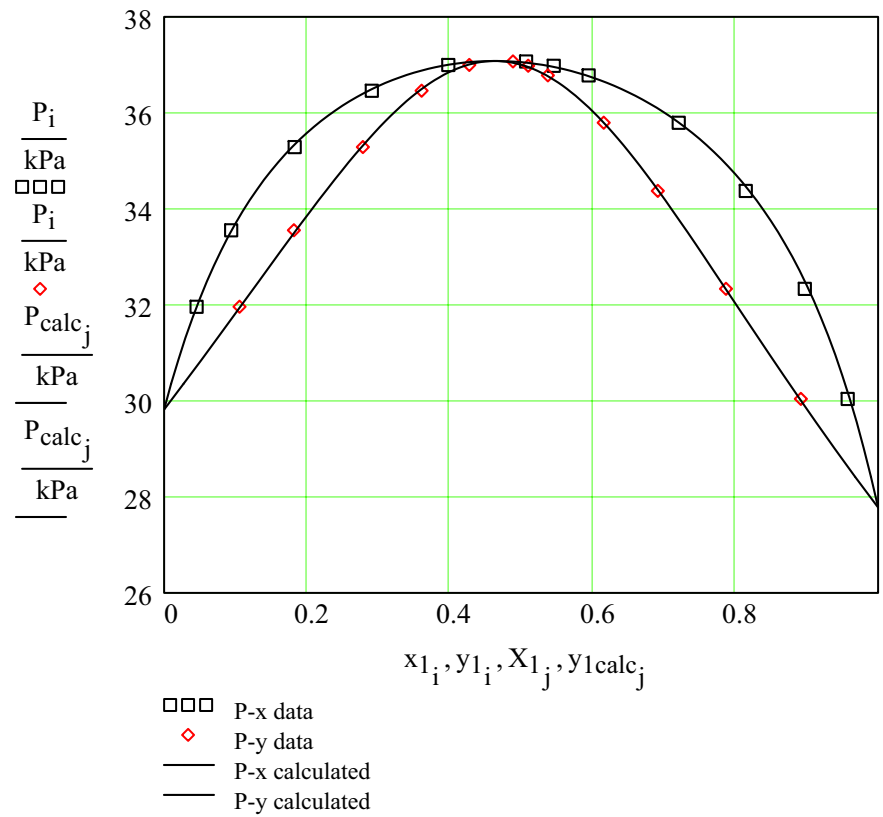

**(d) Consistency Test:**  $\delta\text{GERT}_i := \text{GeRT}(x_{1_i}, x_{2_i}) - \text{GERT}_i$

$$\delta \ln \gamma_1 \gamma_2 := \ln \left( \frac{\gamma_1(x_{1_i}, x_{2_i})}{\gamma_2(x_{1_i}, x_{2_i})} \right) - \ln \left( \frac{\gamma_{1_i}}{\gamma_{2_i}} \right)$$

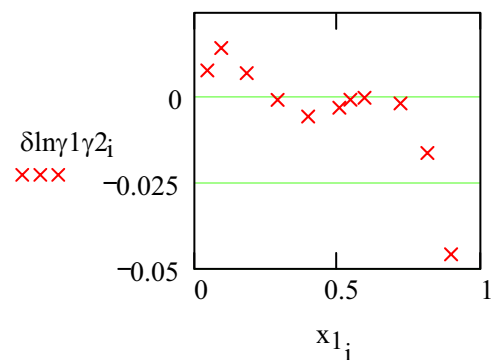
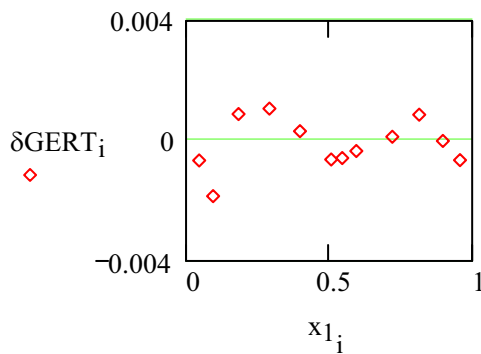

Calculate mean absolute deviation of residuals

$$\text{mean}(|\delta \text{GERT}|) = 6.237 \times 10^{-4}$$

$$\text{mean}(|\delta \ln \gamma_1 \gamma_2|) = 0.025$$

(e) **Barker's Method by non-linear least squares:**  
**Margules Equation**

$$\gamma_1(x_1, x_2, A_{12}, A_{21}, C) := \exp \left[ (x_2)^2 \cdot \left[ \begin{array}{l} A_{12} + 2 \cdot (A_{21} - A_{12} - C \cdot x_1 \dots) \\ + 3 \cdot C \cdot x_1^2 \end{array} \right] \right]$$

$$\gamma_2(x_1, x_2, A_{12}, A_{21}, C) := \exp \left[ (x_1)^2 \cdot \left[ \begin{array}{l} A_{21} + 2 \cdot (A_{12} - A_{21} - C \cdot x_2 \dots) \\ + 3 \cdot C \cdot x_2^2 \end{array} \right] \right]$$

Minimize sum of the squared errors using the Mathcad Minimize function.

**Guesses:**  $A_{12} := -0.3$      $A_{21} := -0.5$      $C := 0.2$

$$\text{SSE}(A_{12}, A_{21}, C) := \sum_i \left[ P_i - \left( \begin{array}{l} x_{1,i} \cdot \gamma_1(x_{1,i}, x_{2,i}, A_{12}, A_{21}, C \cdot \text{Psat}_1 \dots) \\ + x_{2,i} \cdot \gamma_2(x_{1,i}, x_{2,i}, A_{12}, A_{21}, C \cdot \text{Psat}_2) \end{array} \right) \right]^2$$

$$\begin{pmatrix} A_{12} \\ A_{21} \\ C \end{pmatrix} := \text{Minimize}(\delta \text{SSE}, A_{12}, A_{21}, C) \quad \begin{pmatrix} A_{12} \\ A_{21} \\ C \end{pmatrix} = \begin{pmatrix} 1.114 \\ 1.098 \\ 0.387 \end{pmatrix} \quad \text{Ans.}$$

**Plot P-x,y diagram for Margules Equation with parameters from Barker's Method.**

$$P_{\text{calc},j} := X_{1,j} \cdot \gamma_1(X_{1,j}, X_{2,j}, A_{12}, A_{21}, C \cdot \text{Psat}_1 \dots) + X_{2,j} \cdot \gamma_2(X_{1,j}, X_{2,j}, A_{12}, A_{21}, C \cdot \text{Psat}_2)$$

$$y_{1\text{calc},j} := \frac{X_{1,j} \cdot \gamma_1(X_{1,j}, X_{2,j}, A_{12}, A_{21}, C \cdot \text{Psat}_1)}{P_{\text{calc},j}}$$

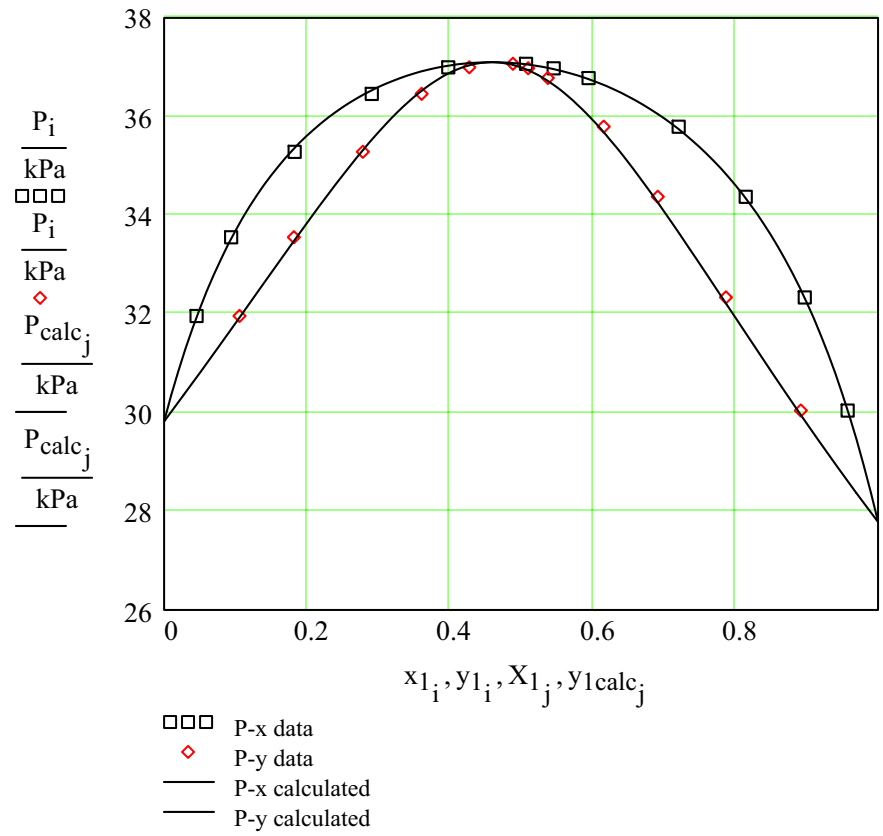

$$\begin{aligned}
 P_{\text{calc},i} &:= x_{1_i} \cdot \gamma_1(x_{1_i}, x_{2_i}, A_{12}, A_{21}, C) \cdot P_{\text{sat}1} \dots \\
 &\quad + x_{2_i} \cdot \gamma_2(x_{1_i}, x_{2_i}, A_{12}, A_{21}, C) \cdot P_{\text{sat}2} \\
 y_{1\text{calc},i} &:= \frac{x_{1_i} \cdot \gamma_1(x_{1_i}, x_{2_i}, A_{12}, A_{21}, C) \cdot P_{\text{sat}1}}{P_{\text{calc},i}}
 \end{aligned}$$



**Plot of P and y1 residuals.**

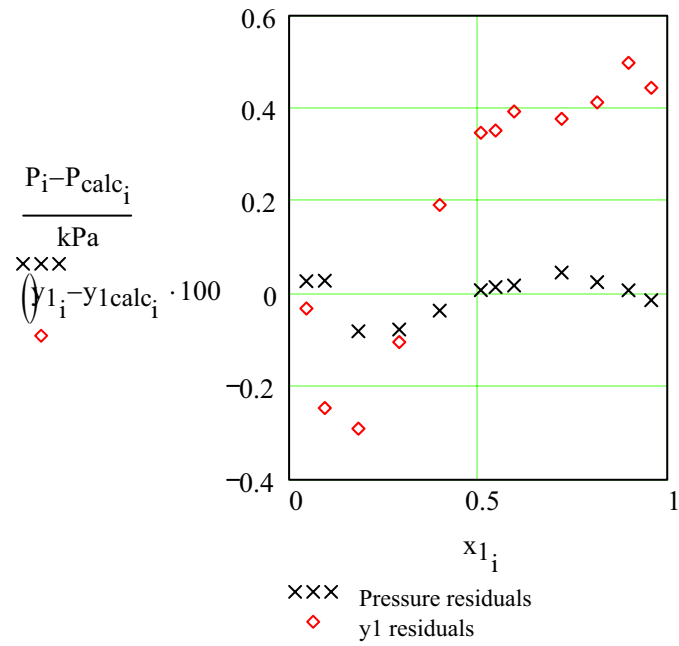

**RMS deviations in P:**

$$RMS := \sqrt{\sum_i \frac{(P_i - P_{calc_i})^2}{n}}$$

**RMS = 0.04 kPa**

**12.12** It is impractical to provide solutions for all of the systems listed in the table on Page 474 we present as an example only the solution for the system 1-propanol(1)/water(2). Solutions for the other systems can be obtained by rerunning the following Mathcad program with the appropriate parameter values substituted for those given. The file WILSON.mcd reproduces the table of Wilson parameters on Page 474 and includes the necessary Antoine coefficients.

**Antoine coefficients:**

<b>1-Propanol:</b>	$A1 := 16.1154$	$B1 := 3483.67 \cdot K$	$C1 := 205.807 \cdot K$
<b>Water:</b>	$A2 := 16.3872$	$B2 := 3885.70 \cdot K$	$C2 := 230.170 \cdot K$

$$P_{sat1}(T) := \exp \left[ A1 - \frac{B1}{(T - 273.15 \cdot K) + C1} \right] \cdot \text{kPa}$$

$$P_{sat2}(T) := \exp \left[ A2 - \frac{B2}{(T - 273.15 \cdot K) + C2} \right] \cdot \text{kPa}$$

**Parameters for the Wilson equation:**

$$V1 := 75.14 \cdot \frac{\text{cm}^3}{\text{mol}}$$

$$V2 := 18.07 \cdot \frac{\text{cm}^3}{\text{mol}}$$

$$a12 := 775.48 \cdot \frac{\text{cal}}{\text{mol}}$$

$$a21 := 1351.90 \cdot \frac{\text{cal}}{\text{mol}}$$

$$\Lambda_{12}(T) := \frac{V2}{V1} \cdot \exp \left( \frac{-a12}{R \cdot T} \right) \qquad \Lambda_{21}(T) := \frac{V1}{V2} \cdot \exp \left( \frac{-a21}{R \cdot T} \right)$$

$$\gamma_1(x_1, x_2, T) := \frac{\exp \left[ x_2 \cdot \left( \frac{\Lambda_{12}(T)}{x_1 + x_2 \cdot \Lambda_{12}(T)} - \frac{\Lambda_{21}(T)}{x_2 + x_1 \cdot \Lambda_{21}(T)} \right) \right]}{(x_1 + x_2 \cdot \Lambda_{12}(T))}$$

$$\gamma_2(x_1, x_2, T) := \frac{\exp \left[ -x_1 \cdot \left( \frac{\Lambda_{12}(T)}{x_1 + x_2 \cdot \Lambda_{12}(T)} - \frac{\Lambda_{21}(T)}{x_2 + x_1 \cdot \Lambda_{21}(T)} \right) \right]}{(x_2 + x_1 \cdot \Lambda_{21}(T))}$$

**P-x,y diagram at**

$$T := (60 + 273.15) \cdot K$$

**Guess:**  $P := 70 \cdot \text{kPa}$

Given

$$P = x_1 \cdot \gamma_1(x_1, 1 - x_1, T) \cdot P_{\text{sat}_1}(T) \dots$$
$$+ (1 - x_1) \cdot \gamma_2(x_1, 1 - x_1, T) \cdot P_{\text{sat}_2}(T)$$

$$P_{\text{eq}}(x_1) := \text{Find}(P)$$

$$y_{\text{eq}}(x_1) := \frac{x_1 \cdot \gamma_1(x_1, 1 - x_1, T) \cdot P_{\text{sat}_1}(T)}{P_{\text{eq}}(x_1)} \quad x := 0, 0.05 \dots 1.0$$

$x =$	$y_{\text{eq}}(x) =$	$\frac{P_{\text{eq}}(x)}{\text{kPa}} =$
0	0	20.007
0.05	0.315	28.324
0.1	0.363	30.009
0.15	0.383	30.639
0.2	0.395	30.97
0.25	0.404	31.182
0.3	0.413	31.331
0.35	0.421	31.435
0.4	0.431	31.496
0.45	0.441	31.51
0.5	0.453	31.467
0.55	0.466	31.353
0.6	0.483	31.148
0.65	0.502	30.827
0.7	0.526	30.355
0.75	0.556	29.686
0.8	0.594	28.759
0.85	0.646	27.491
0.9	0.718	25.769
0.95	0.825	23.437
1	1	20.275

**P,x,y Diagram at T = 333.15 K**

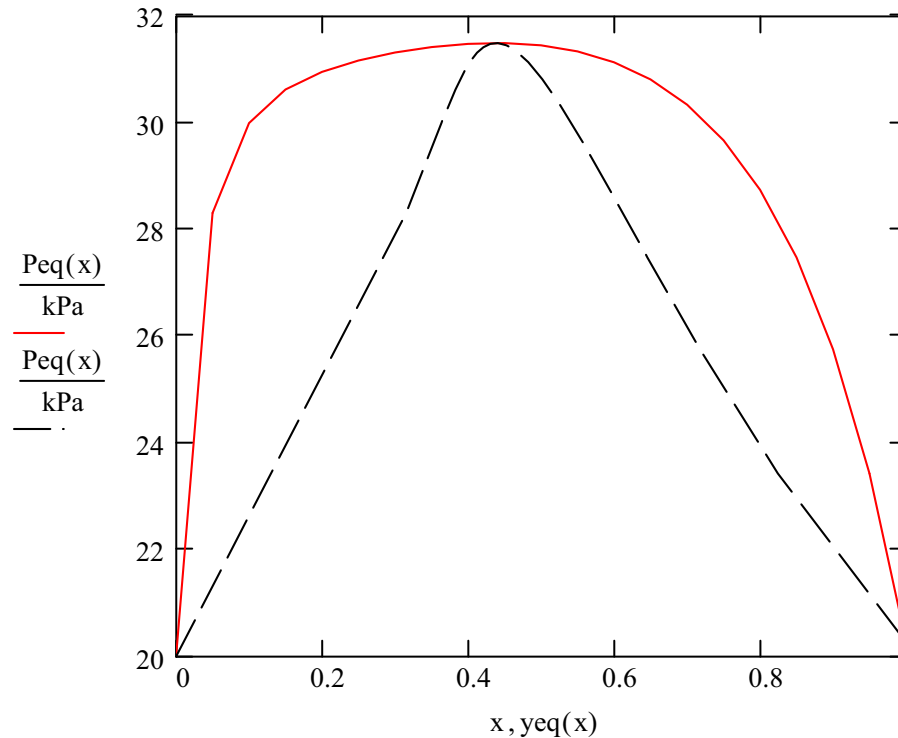

**12.13** It is impractical to provide solutions for all of the systems listed in the table on Page 474; we present as an example only the solution for the system 1-propanol(1)/water(2). Solutions for the other systems can be obtained by rerunning the following Mathcad program with the appropriate parameter values substituted for those given. The file WILSON.mcd reproduces the table of Wilson parameters on Page 474 and includes the necessary Antoine coefficients.

**Antoine coefficients:**

**1-Propanol:**  $A1 := 16.1154$        $B1 := 3483.67 \cdot K$        $C1 := 205.807 \cdot K$

**Water:**       $A2 := 16.3872$        $B2 := 3885.70 \cdot K$        $C2 := 230.170 \cdot K$

$$P_{sat1}(T) := \exp \left[ A1 - \frac{B1}{(T - 273.15 \cdot K) + C1} \right] \cdot kPa$$

$$P_{sat2}(T) := \exp \left[ A2 - \frac{B2}{(T - 273.15 \cdot K) + C2} \right] \cdot kPa$$

**Parameters for the Wilson equation:**

$$V1 := 75.14 \cdot \frac{\text{cm}^3}{\text{mol}}$$

$$V2 := 18.07 \cdot \frac{\text{cm}^3}{\text{mol}}$$

$$a12 := 775.48 \cdot \frac{\text{cal}}{\text{mol}}$$

$$a21 := 1351.90 \cdot \frac{\text{cal}}{\text{mol}}$$

$$\Lambda_{12}(T) := \frac{V2}{V1} \cdot \exp\left(\frac{-a12}{R \cdot T}\right) \quad \Lambda_{21}(T) := \frac{V1}{V2} \cdot \exp\left(\frac{-a21}{R \cdot T}\right)$$

$$\gamma_1(x_1, x_2, T) := \frac{\exp\left[x_2 \cdot \left(\frac{\Lambda_{12}(T)}{x_1 + x_2 \cdot \Lambda_{12}(T)} - \frac{\Lambda_{21}(T)}{x_2 + x_1 \cdot \Lambda_{21}(T)}\right)\right]}{(x_1 + x_2 \cdot \Lambda_{12}(T))}$$

$$\gamma_2(x_1, x_2, T) := \frac{\exp\left[-x_1 \cdot \left(\frac{\Lambda_{12}(T)}{x_1 + x_2 \cdot \Lambda_{12}(T)} - \frac{\Lambda_{21}(T)}{x_2 + x_1 \cdot \Lambda_{21}(T)}\right)\right]}{(x_2 + x_1 \cdot \Lambda_{21}(T))}$$

**T-x,y diagram at**  $P := 101.33 \cdot \text{kPa}$

**Guess:**  $T := (90 + 273.15) \cdot \text{K}$

**Given**  $P = x_1 \cdot \gamma_1(x_1, 1 - x_1, T) \cdot \text{Psat}_1(T) \dots$   
 $+ (1 - x_1) \cdot \gamma_2(x_1, 1 - x_1, T) \cdot \text{Psat}_2(T)$

$$\text{Teq}(x_1) := \text{Find}(T)$$

$$y_{\text{eq}}(x_1) := \frac{x_1 \cdot \gamma_1(x_1, 1 - x_1, \text{Teq}(x_1)) \cdot \text{Psat}_1(\text{Teq}(x_1))}{P}$$

$$x := 0, 0.05 .. 1.0$$

x =	yeq(x) =	$\frac{T_{eq}(x)}{K} =$
0	0	373.149
0.05	0.304	364.159
0.1	0.358	362.476
0.15	0.381	361.836
0.2	0.395	361.49
0.25	0.407	361.264
0.3	0.418	361.101
0.35	0.429	360.985
0.4	0.44	360.911
0.45	0.453	360.881
0.5	0.468	360.904
0.55	0.484	360.99
0.6	0.504	361.154
0.65	0.527	361.418
0.7	0.555	361.809
0.75	0.589	362.364
0.8	0.631	363.136
0.85	0.686	364.195
0.9	0.759	365.644
0.95	0.858	367.626
1	1	370.349

**T,x,y Diagram at P := 101.33·kPa**

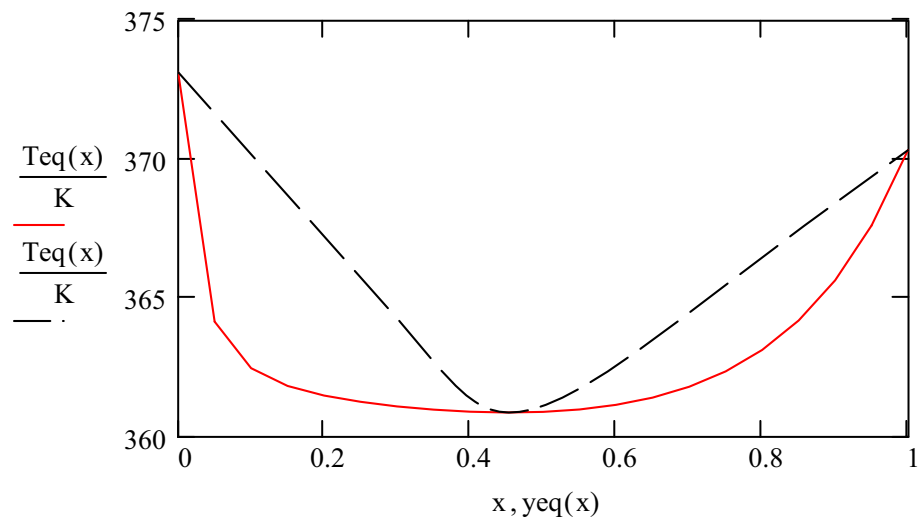

**12.14** It is impractical to provide solutions for all of the systems listed in the table on Page 474; we present as an example only the solution for the system 1-propanol(1)/water(2). Solutions for the other systems can be obtained by rerunning the following Mathcad program with the appropriate parameter values substituted for those given. The file NRTL.mcd reproduces the table of NRTL parameters on Page 474 and includes the necessary Antoine coefficients.

**Antoine coefficients:**

**1-Propanol:**  $A1 := 16.1154$        $B1 := 3483.67 \cdot K$        $C1 := 205.807 \cdot K$

**Water:**       $A2 := 16.3872$        $B2 := 3885.70 \cdot K$        $C2 := 230.170 \cdot K$

$$P_{sat1}(T) := \exp \left[ A1 - \frac{B1}{(T - 273.15 \cdot K) + C1} \right] \cdot \text{kPa}$$

$$P_{sat2}(T) := \exp \left[ A2 - \frac{B2}{(T - 273.15 \cdot K) + C2} \right] \cdot \text{kPa}$$

**Parameters for the NRTL equation:**

$$b_{12} := 500.40 \cdot \frac{\text{cal}}{\text{mol}}$$

$$b_{21} := 1636.57 \cdot \frac{\text{cal}}{\text{mol}}$$

$$\alpha := 0.5081$$

$$\tau_{12}(T) := \frac{b_{12}}{R \cdot T}$$

$$\tau_{21}(T) := \frac{b_{21}}{R \cdot T}$$

$$G_{12}(T) := \exp(-\alpha \cdot \tau_{12}(T))$$

$$G_{21}(T) := \exp(-\alpha \cdot \tau_{21}(T))$$

$$\gamma_1(x_1, x_2, T) := \exp \left[ x_2^2 \cdot \left[ \tau_{21}(T) \cdot \left( \frac{G_{21}(T)}{x_1 + x_2 \cdot G_{21}(T)} \right)^2 + \frac{G_{12}(T) \cdot \tau_{12}(T)}{(x_2 + x_1 \cdot G_{12}(T))^2} \right] \right]$$

$$\gamma_2(x_1, x_2, T) := \exp \left[ x_1^2 \cdot \left[ \tau_{12}(T) \cdot \left( \frac{G_{12}(T)}{x_2 + x_1 \cdot G_{12}(T)} \right)^2 + \frac{G_{21}(T) \cdot \tau_{21}(T)}{(x_1 + x_2 \cdot G_{21}(T))^2} \right] \right]$$

**P-x,y diagram at**  $T := (60 + 273.15) \cdot K$

**Guess:**  $P := 70 \cdot \text{kPa}$

**Given**  $P = x_1 \cdot \gamma_1(x_1, 1 - x_1, T) \cdot P_{\text{sat}1}(T) \dots$   
 $+ (1 - x_1) \cdot \gamma_2(x_1, 1 - x_1, T) \cdot P_{\text{sat}2}(T)$

$P_{\text{eq}}(x_1) := \text{Find}(P)$

$$y_{\text{eq}}(x_1) := \frac{x_1 \cdot \gamma_1(x_1, 1 - x_1, T) \cdot P_{\text{sat}1}(T)}{P_{\text{eq}}(x_1)} \quad x := 0, 0.05 .. 1.0$$

$x =$	$y_{\text{eq}}(x) =$	$\frac{P_{\text{eq}}(x)}{\text{kPa}} =$
0	0	20.007
0.05	0.33	28.892
0.1	0.373	30.48
0.15	0.382	30.783
0.2	0.386	30.876
0.25	0.39	30.959
0.3	0.395	31.048
0.35	0.404	31.127
0.4	0.414	31.172
0.45	0.427	31.163
0.5	0.442	31.085
0.55	0.459	30.922
0.6	0.479	30.657
0.65	0.503	30.271
0.7	0.531	29.74
0.75	0.564	29.03
0.8	0.606	28.095
0.85	0.659	26.868
0.9	0.732	25.256
0.95	0.836	23.124
1	1	20.275



**P,x,y Diagram at T = 333.15 K**

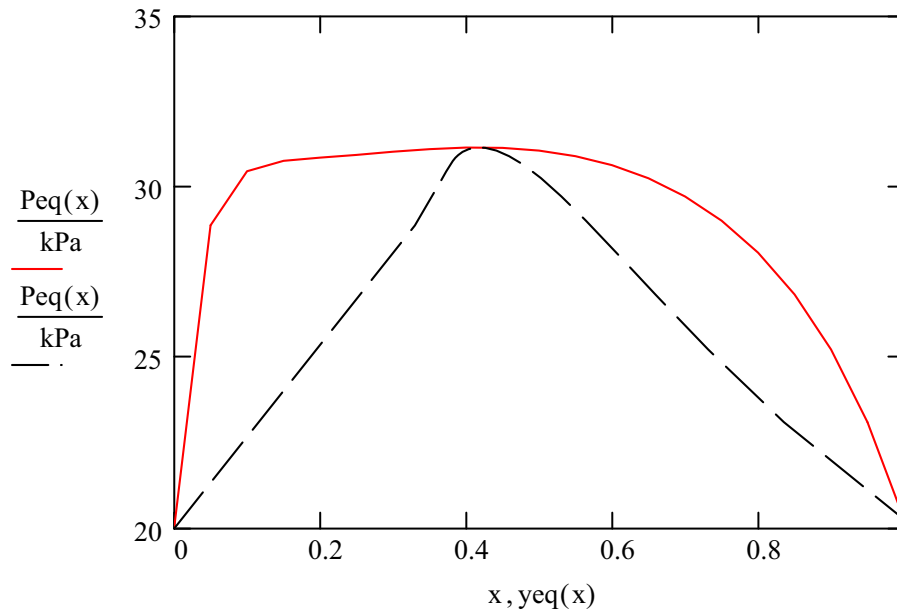

**12.15** It is impractical to provide solutions for all of the systems listed in the table on Page 474; we present as an example only the solution for the system 1-propanol(1)/water(2). Solutions for the other systems can be obtained by rerunning the following Mathcad program with the appropriate parameter values substituted for those given. The file NRTL.mcd reproduces the table of NRTL parameters on Page 474 and includes the necessary Antoine coefficients.

**Antoine coefficients:**

**1-Propanol:**  $A1 := 16.1154$        $B1 := 3483.67 \cdot K$        $C1 := 205.807 \cdot K$

**Water:**  $A2 := 16.3872$        $B2 := 3885.70 \cdot K$        $C2 := 230.170 \cdot K$

$$P_{sat1}(T) := \exp \left[ A1 - \frac{B1}{(T - 273.15 \cdot K) + C1} \right] \cdot \text{kPa}$$

$$P_{sat2}(T) := \exp \left[ A2 - \frac{B2}{(T - 273.15 \cdot K) + C2} \right] \cdot \text{kPa}$$

**Parameters for the NRTL equation:**

$$b_{12} := 500.40 \cdot \frac{\text{cal}}{\text{mol}}$$

$$b_{21} := 1636.57 \cdot \frac{\text{cal}}{\text{mol}}$$

$$\alpha := 0.5081$$

$$\tau_{12}(T) := \frac{b_{12}}{R \cdot T}$$

$$\tau_{21}(T) := \frac{b_{21}}{R \cdot T}$$

$$G_{12}(T) := \exp(-\alpha \cdot 12(T))$$

$$G_{21}(T) := \exp(-\alpha \cdot 21(T))$$

$$\gamma_1(x_1, x_2, T) := \exp \left[ x_2^2 \cdot \left[ \tau_{21}(T) \cdot \left( \frac{G_{21}(T)}{x_1 + x_2 \cdot G_{21}(T)} \right)^2 \dots \right. \right. \\ \left. \left. + \frac{G_{12}(T) \cdot \tau_{12}(T)}{(x_2 + x_1 \cdot G_{12}(T))^2} \right] \right]$$

$$\gamma_2(x_1, x_2, T) := \exp \left[ x_1^2 \cdot \left[ \tau_{12}(T) \cdot \left( \frac{G_{12}(T)}{x_2 + x_1 \cdot G_{12}(T)} \right)^2 \dots \right. \right. \\ \left. \left. + \frac{G_{21}(T) \cdot \tau_{21}(T)}{(x_1 + x_2 \cdot G_{21}(T))^2} \right] \right]$$

**T-x,y diagram at**  $P := 101.33 \cdot \text{kPa}$

**Guess:**  $T := (90 + 273.15) \cdot \text{K}$

**Given**  $P = x_1 \cdot \gamma_1(x_1, 1 - x_1, T) \cdot \text{Psat}_1(T) \dots$   
 $+ (1 - x_1) \cdot \gamma_2(x_1, 1 - x_1, T) \cdot \text{Psat}_2(T)$

$\text{Teq}(x_1) := \text{Find}(T)$

$\text{yeq}(x_1) := \frac{x_1 \cdot \gamma_1(x_1, 1 - x_1, \text{Teq}(x_1)) \cdot \text{Psat}_1(\text{Teq}(x_1))}{P}$

$x := 0, 0.05 \dots 1.0$

$x =$	$yeq(x) =$	$\frac{Teq(x)}{K} =$
0	0	373.149
0.05	0.32	363.606
0.1	0.377	361.745
0.15	0.394	361.253
0.2	0.402	361.066
0.25	0.408	360.946
0.3	0.415	360.843
0.35	0.424	360.757
0.4	0.434	360.697
0.45	0.447	360.676
0.5	0.462	360.709
0.55	0.48	360.807
0.6	0.5	360.985
0.65	0.524	361.262
0.7	0.552	361.66
0.75	0.586	362.215
0.8	0.629	362.974
0.85	0.682	364.012
0.9	0.754	365.442
0.95	0.853	367.449
1	1	370.349

**T,x,y Diagram at  $P := 101.33 \cdot \text{kPa}$**

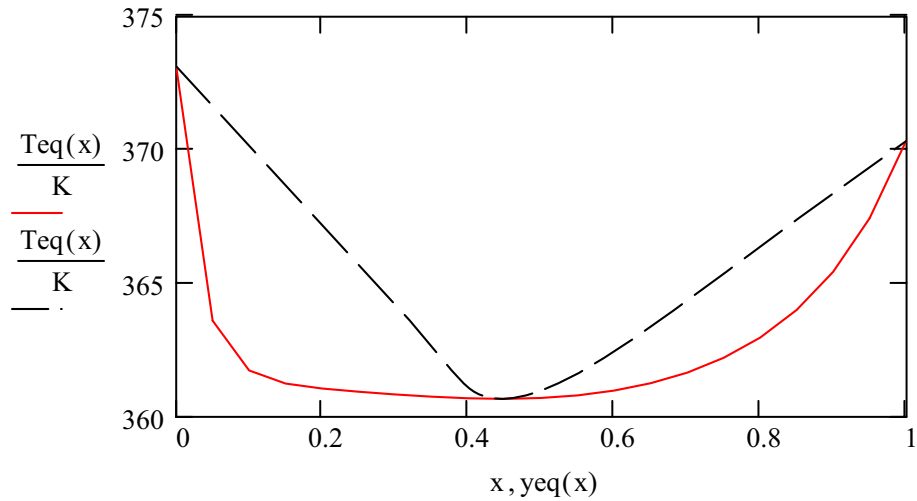

**12.16** It is impractical to provide solutions for all of the systems listed in the table on Page 474; we present as an example only the solution for the system 1-propanol(1)/water(2). Solutions for the other systems can be obtained by rerunning the following Mathcad program with the appropriate parameter values substituted for those given. The file WILSON.mcd reproduces the table of Wilson parameters on Page 474 and includes the necessary Antoine coefficients.

**Antoine coefficients:**

**1-Propanol:**  $A1 := 16.1154$        $B1 := 3483.67 \cdot K$        $C1 := 205.807 \cdot K$

**Water:**  $A2 := 16.3872$        $B2 := 3885.70 \cdot K$        $C2 := 230.170 \cdot K$

$$P_{sat1}(T) := \exp \left[ A1 - \frac{B1}{(T - 273.15 \cdot K) + C1} \right] \cdot \text{kPa}$$

$$P_{sat2}(T) := \exp \left[ A2 - \frac{B2}{(T - 273.15 \cdot K) + C2} \right] \cdot \text{kPa}$$

**Parameters for the Wilson equation:**

$$V1 := 75.14 \cdot \frac{\text{cm}^3}{\text{mol}}$$

$$V2 := 18.07 \cdot \frac{\text{cm}^3}{\text{mol}}$$

$$a12 := 775.48 \cdot \frac{\text{cal}}{\text{mol}}$$

$$a21 := 1351.90 \cdot \frac{\text{cal}}{\text{mol}}$$

$$\Lambda_{12}(T) := \frac{V2}{V1} \cdot \exp \left( \frac{-a12}{R \cdot T} \right) \qquad \Lambda_{21}(T) := \frac{V1}{V2} \cdot \exp \left( \frac{-a21}{R \cdot T} \right)$$

$$\gamma_1(x_1, x_2, T) := \frac{\exp \left[ x_2 \cdot \left( \frac{\Lambda_{12}(T)}{x_1 + x_2 \cdot \Lambda_{12}(T)} - \frac{\Lambda_{21}(T)}{x_2 + x_1 \cdot \Lambda_{21}(T)} \right) \right]}{(x_1 + x_2 \cdot \Lambda_{12}(T))}$$

$$\gamma_2(x_1, x_2, T) := \frac{\exp \left[ -x_1 \cdot \left( \frac{\Lambda_{12}(T)}{x_1 + x_2 \cdot \Lambda_{12}(T)} - \frac{\Lambda_{21}(T)}{x_2 + x_1 \cdot \Lambda_{21}(T)} \right) \right]}{(x_2 + x_1 \cdot \Lambda_{21}(T))}$$

**(a) BUBL P:**  $T := (60 + 273.15) \cdot K$   $x1 := 0.3$   $x2 := 1 - x1$

**Guess:**  $P := 101.33 \cdot kPa$   $y1 := 0.4$   $y2 := 1 - y1$

Given  $y1 \cdot P = x1 \cdot \gamma1(x1, x2, T) \cdot Psat1(T)$   $y1 + y2 = 1$   
 $y2 \cdot P = x2 \cdot \gamma2(x1, x2, T) \cdot Psat2(T)$

$$\begin{pmatrix} P_{bubl} \\ y1 \\ y2 \end{pmatrix} := \text{Find}(P, y1, y2)$$

$P_{bubl} = 31.33 \text{ kPa}$   $y1 = 0.413$   $y2 = 0.587$  **Ans.**

**(b) DEW P:**  $T := (60 + 273.15) \cdot K$   $y1 := 0.3$   $y2 := 1 - y1$

**Guess:**  $P := 101.33 \cdot kPa$   $x1 := 0.1$   $x2 := 1 - x1$

Given  $y1 \cdot P = x1 \cdot \gamma1(x1, x2, T) \cdot Psat1(T)$   $x1 + x2 = 1$   
 $y2 \cdot P = x2 \cdot \gamma2(x1, x2, T) \cdot Psat2(T)$

$$\begin{pmatrix} P_{dew} \\ x1 \\ x2 \end{pmatrix} := \text{Find}(P, x1, x2)$$

$P_{dew} = 27.79 \text{ kPa}$   $x1 = 0.042$   $x2 = 0.958$  **Ans.**

**(c) P,T-flash Calculation**

$P := \frac{P_{dew} + P_{bubl}}{2}$   $T := (60 + 273.15) \cdot K$   $z1 := 0.3$

**Guess:**  $V := 0.5$   $x1 := 0.1$   $x2 := 1 - y1$   
 $y1 := 0.1$   $y2 := 1 - x1$

Given  $y1 = \frac{x1 \cdot \gamma1(x1, x2, T) \cdot Psat1(T)}{P}$   $x1 + x2 = 1$

$y2 = \frac{x2 \cdot \gamma2(x1, x2, T) \cdot Psat2(T)}{P}$   $y1 + y2 = 1$

$$x_1 \cdot (1 - V) + y_1 \cdot V = z_1 \quad \text{Eq. (10.15)}$$

$$\begin{pmatrix} x_1 \\ x_2 \\ y_1 \\ y_2 \\ V \end{pmatrix} := \text{Find}(x_1, x_2, y_1, y_2, V)$$

$$x_1 = 0.08$$

$$x_2 = 0.92$$

$$y_1 = 0.351$$

$$y_2 = 0.649$$

$$V = 0.813$$

#### (d) Azeotrope Calculation

Test for azeotrope at:

$$T := (60 + 273.15) \cdot \text{K}$$

$$\gamma_1(0, 1, T) = 21.296$$

$$\gamma_2(1, 0, T) = 4.683$$

$$\alpha_{12_0} := \frac{\gamma_1(0, 1, T) \cdot P_{\text{sat}_1}(T)}{P_{\text{sat}_2}(T)}$$

$$\alpha_{12_0} = 21.581$$

$$\alpha_{12_1} := \frac{P_{\text{sat}_1}(T)}{\gamma_2(1, 0, T) \cdot P_{\text{sat}_2}(T)}$$

$$\alpha_{12_1} = 0.216$$

Since one of these values is  $>1$  and the other is  $<1$ , an azeotrope exists.

See Ex. 10.3(e)

**Guess:**  $P := 101.33 \cdot \text{kPa}$      $x_1 := 0.3$      $x_2 := 1 - x_1$   
 $y_1 := 0.3$      $y_2 := 1 - x_1$

Given  $y_1 \cdot P = x_1 \cdot \gamma_1(x_1, x_2, T) \cdot P_{\text{sat}_1}(T)$

$$y_2 \cdot P = x_2 \cdot \gamma_2(x_1, x_2, T) \cdot P_{\text{sat}_2}(T)$$

$$x_1 + x_2 = 1 \quad y_1 + y_2 = 1 \quad x_1 = y_1$$

$$\begin{pmatrix} x_1 \\ x_2 \\ y_1 \\ y_2 \\ P_{\text{az}} \end{pmatrix} := \text{Find}(x_1, x_2, y_1, y_2, P)$$

$$P_{\text{az}} = 31.511 \text{ kPa}$$

$$x_1 = 0.4386$$

$$y_1 = 0.4386$$

**Ans.**

12.17 It is impractical to provide solutions for all of the systems listed in the table on Page 474; we present as an example only the solution for the system 1-propanol(1)/water(2). Solutions for the other systems can be obtained by rerunning the following Mathcad program with the appropriate parameter values substituted for those given. The file NRTL.mcd reproduces the table of NRTL parameters on Page 474 and includes the necessary Antoine coefficients.

Antoine coefficients:

1-Propanol:  $A1 := 16.1154$        $B1 := 3483.67 \cdot K$        $C1 := 205.807 \cdot K$

Water:  $A2 := 16.3872$        $B2 := 3885.70 \cdot K$        $C2 := 230.170 \cdot K$

$$P_{sat1}(T) := \exp \left[ A1 - \frac{B1}{(T - 273.15 \cdot K) + C1} \right] \cdot \text{kPa}$$

$$P_{sat2}(T) := \exp \left[ A2 - \frac{B2}{(T - 273.15 \cdot K) + C2} \right] \cdot \text{kPa}$$

Parameters for the NRTL equation:

$$b_{12} := 500.40 \cdot \frac{\text{cal}}{\text{mol}}$$

$$b_{21} := 1636.57 \cdot \frac{\text{cal}}{\text{mol}}$$

$$\alpha := 0.5081$$

$$\tau_{12}(T) := \frac{b_{12}}{R \cdot T}$$

$$\tau_{21}(T) := \frac{b_{21}}{R \cdot T}$$

$$G_{12}(T) := \exp(-\alpha \cdot \tau_{12}(T))$$

$$G_{21}(T) := \exp(-\alpha \cdot \tau_{21}(T))$$

$$\gamma_1(x_1, x_2, T) := \exp \left[ x_2^2 \cdot \left[ \tau_{21}(T) \cdot \left( \frac{G_{21}(T)}{x_1 + x_2 \cdot G_{21}(T)} \right)^2 + \frac{G_{12}(T) \cdot \tau_{12}(T)}{(x_2 + x_1 \cdot G_{12}(T))^2} \right] \right]$$

$$\gamma_2(x_1, x_2, T) := \exp \left[ x_1^2 \cdot \left[ \tau_{12}(T) \cdot \left( \frac{G_{12}(T)}{x_2 + x_1 \cdot G_{12}(T)} \right)^2 + \frac{G_{21}(T) \cdot \tau_{21}(T)}{(x_1 + x_2 \cdot G_{21}(T))^2} \right] \right]$$







**12.18** It is impractical to provide solutions for all of the systems listed in the table on Page 474; we present as an example only the solution for the system 1-propanol(1)/water(2). Solutions for the other systems can be obtained by rerunning the following Mathcad program with the appropriate parameter values substituted for those given. The file WILSON.mcd reproduces the table of Wilson parameters on Page 474 and includes the necessary Antoine coefficients.

**Antoine coefficients:**

**1-Propanol:**  $A1 := 16.1154$        $B1 := 3483.67 \cdot K$        $C1 := 205.807 \cdot K$

**Water:**  $A2 := 16.3872$        $B2 := 3885.70 \cdot K$        $C2 := 230.170 \cdot K$

$$P_{sat1}(T) := \exp \left[ A1 - \frac{B1}{(T - 273.15 \cdot K) + C1} \right] \cdot \text{kPa}$$

$$P_{sat2}(T) := \exp \left[ A2 - \frac{B2}{(T - 273.15 \cdot K) + C2} \right] \cdot \text{kPa}$$

**Parameters for the Wilson equation:**

$$V1 := 75.14 \cdot \frac{\text{cm}^3}{\text{mol}}$$

$$V2 := 18.07 \cdot \frac{\text{cm}^3}{\text{mol}}$$

$$a12 := 775.48 \cdot \frac{\text{cal}}{\text{mol}}$$

$$a21 := 1351.90 \cdot \frac{\text{cal}}{\text{mol}}$$

$$\Lambda_{12}(T) := \frac{V2}{V1} \cdot \exp \left( \frac{-a12}{R \cdot T} \right) \quad \Lambda_{21}(T) := \frac{V1}{V2} \cdot \exp \left( \frac{-a21}{R \cdot T} \right)$$

$$\gamma_1(x_1, x_2, T) := \frac{\exp \left[ x_2 \cdot \left( \frac{\Lambda_{12}(T)}{x_1 + x_2 \cdot \Lambda_{12}(T)} - \frac{\Lambda_{21}(T)}{x_2 + x_1 \cdot \Lambda_{21}(T)} \right) \right]}{(x_1 + x_2 \cdot \Lambda_{12}(T))}$$

$$\gamma_2(x_1, x_2, T) := \frac{\exp \left[ -x_1 \cdot \left( \frac{\Lambda_{12}(T)}{x_1 + x_2 \cdot \Lambda_{12}(T)} - \frac{\Lambda_{21}(T)}{x_2 + x_1 \cdot \Lambda_{21}(T)} \right) \right]}{(x_2 + x_1 \cdot \Lambda_{21}(T))}$$

**(a) BUBL T:**  $P := 101.33 \cdot \text{kPa}$   $x_1 := 0.3$   $x_2 := 1 - x_1$

**Guess:**  $T := (60 + 273.15) \cdot \text{K}$   $y_1 := 0.3$   $y_2 := 1 - y_1$

**Given**  $y_1 \cdot P = x_1 \cdot \gamma_1(x_1, x_2, T) \cdot P_{\text{sat}1}(T)$   
 $y_2 \cdot P = x_2 \cdot \gamma_2(x_1, x_2, T) \cdot P_{\text{sat}2}(T)$   $y_1 + y_2 = 1$

$$\begin{pmatrix} T_{\text{bubl}} \\ y_1 \\ y_2 \end{pmatrix} := \text{Find}(T, y_1, y_2)$$

$T_{\text{bubl}} = 361.1 \text{ K}$   $y_1 = 0.418$   $y_2 = 0.582$  **Ans.**

**(b) DEW T:**  $P := 101.33 \cdot \text{kPa}$   $y_1 := 0.3$   $y_2 := 1 - x_1$

**Guess:**  $T := (60 + 273.15) \cdot \text{K}$   $x_1 := 0.1$   $x_2 := 1 - y_1$

**Given**  $y_1 \cdot P = x_1 \cdot \gamma_1(x_1, x_2, T) \cdot P_{\text{sat}1}(T)$   
 $y_2 \cdot P = x_2 \cdot \gamma_2(x_1, x_2, T) \cdot P_{\text{sat}2}(T)$   $x_1 + x_2 = 1$

$$\begin{pmatrix} T_{\text{dew}} \\ x_1 \\ x_2 \end{pmatrix} := \text{Find}(T, x_1, x_2)$$

$T_{\text{dew}} = 364.28 \text{ K}$   $x_1 = 0.048$   $x_2 = 0.952$  **Ans.**

**(c) P,T-flash Calculation**

$T := \frac{T_{\text{dew}} + T_{\text{bubl}}}{2}$   $P := 101.33 \cdot \text{kPa}$   $z_1 := 0.3$

**Guess:**  $V := 0.5$   $x_1 := 0.1$   $x_2 := 1 - y_1$   
 $y_1 := 0.1$   $y_2 := 1 - x_1$

**Given**  $y_1 = \frac{x_1 \cdot \gamma_1(x_1, x_2, T) \cdot P_{\text{sat}1}(T)}{P}$   $x_1 + x_2 = 1$

$y_2 = \frac{x_2 \cdot \gamma_2(x_1, x_2, T) \cdot P_{\text{sat}2}(T)}{P}$   $y_1 + y_2 = 1$

$x_1 \cdot (1 - V) + y_1 \cdot V = z_1$  **Eq. (10.15)**

$$\begin{pmatrix} x1 \\ x2 \\ y1 \\ y2 \\ V \end{pmatrix} := \text{Find}(x1, x2, y1, y2, V)$$

$$x1 = 0.09$$

$$x2 = 0.91$$

$$y1 = 0.35$$

$$y2 = 0.65$$

$$V = 0.807$$

#### (d) Azeotrope Calculation

Test for azeotrope at:  $P := 101.33 \cdot \text{kPa}$

$$Tb1 := \left[ \left( \frac{B1}{A1 - \ln\left(\frac{P}{\text{kPa}}\right)} - C1 \right) + 273.15 \cdot \text{K} \right] \quad Tb1 = 370.349 \text{ K}$$

$$Tb2 := \left[ \left( \frac{B2}{A2 - \ln\left(\frac{P}{\text{kPa}}\right)} - C2 \right) + 273.15 \cdot \text{K} \right] \quad Tb2 = 373.149 \text{ K}$$

$$\gamma1(0, 1, Tb2) = 16.459$$

$$\gamma2(1, 0, Tb1) = 3.779$$

$$\alpha12_0 := \frac{\gamma1(0, 1, T) \cdot Psat_1(Tb2)}{P}$$

$$\alpha12_0 = 19.506$$

$$\alpha12_1 := \frac{P}{\gamma2(1, 0, T) \cdot Psat_2(Tb1)}$$

$$\alpha12_1 = 0.281$$

Since one of these values is  $>1$  and the other is  $<1$ , an azeotrope exists.

See Ex. 10.3(e). Guesses:

$$T := (60 + 273.15) \cdot \text{K} \quad x1 := 0.4 \quad x2 := 1 - y1 \quad y1 := 0.4 \quad y2 := 1 - x1$$

$$\text{Given } y1 \cdot P = x1 \cdot \gamma1(x1, x2, T) \cdot Psat_1(T) \quad x1 + x2 = 1$$

$$y2 \cdot P = x2 \cdot \gamma2(x1, x2, T) \cdot Psat_2(T) \quad y1 + y2 = 1 \quad x1 = y1$$

$$\begin{pmatrix} x1 \\ x2 \\ y1 \\ y2 \\ T_{az} \end{pmatrix} := \text{Find}(x1, x2, y1, y2, T)$$

$$T_{az} = 360.881 \text{ K}$$

$$x1 = 0.4546$$

$$y1 = 0.4546$$

Ans.

**12.19** It is impractical to provide solutions for all of the systems listed in the table on page 474; we present as an example only the solution for the system 1-propanol(1)/water(2). Solutions for the other systems can be obtained by rerunning the following Mathcad program with the appropriate parameter values substituted for those given. The file NRTL.mcd reproduces the table of NRTL parameters on Page 474 and includes the necessary Antoine coefficients.

**Antoine coefficients:**

**1-Propanol:**  $A1 := 16.1154$        $B1 := 3483.67 \cdot \text{K}$        $C1 := 205.807 \cdot \text{K}$

**Water:**       $A2 := 16.3872$        $B2 := 3885.70 \cdot \text{K}$        $C2 := 230.170 \cdot \text{K}$

$$P_{\text{sat}1}(T) := \exp \left[ A1 - \frac{B1}{(T - 273.15 \cdot \text{K}) + C1} \right] \cdot \text{kPa}$$

$$P_{\text{sat}2}(T) := \exp \left[ A2 - \frac{B2}{(T - 273.15 \cdot \text{K}) + C2} \right] \cdot \text{kPa}$$

**Parameters for the NRTL equation:**

$$b_{12} := 500.40 \cdot \frac{\text{cal}}{\text{mol}}$$

$$b_{21} := 1636.57 \cdot \frac{\text{cal}}{\text{mol}}$$

$$\alpha := 0.5081$$

$$\tau_{12}(T) := \frac{b_{12}}{R \cdot T}$$

$$\tau_{21}(T) := \frac{b_{21}}{R \cdot T}$$

$$G_{12}(T) := \exp(-\alpha \cdot \tau_{12}(T))$$

$$G_{21}(T) := \exp(-\alpha \cdot \tau_{21}(T))$$

$$\gamma_1(x_1, x_2, T) := \exp \left[ x_2^2 \cdot \left[ \tau_{21}(T) \cdot \left( \frac{G_{21}(T)}{x_1 + x_2 \cdot G_{21}(T)} \right)^2 + \frac{G_{12}(T) \cdot \tau_{12}(T)}{(x_2 + x_1 \cdot G_{12}(T))^2} \right] \right]$$

$$\gamma_2(x_1, x_2, T) := \exp \left[ x_1^2 \cdot \left[ \tau_{12}(T) \cdot \left( \frac{G_{12}(T)}{x_2 + x_1 \cdot G_{12}(T)} \right)^2 + \frac{G_{21}(T) \cdot \tau_{21}(T)}{(x_1 + x_2 \cdot G_{21}(T))^2} \right] \right]$$

**(a) BUBL T:**  $P := 101.33 \cdot \text{kPa}$   $x_1 := 0.3$   $x_2 := 1 - x_1$

**Guess:**  $T := (60 + 273.15) \cdot \text{K}$   $y_1 := 0.3$   $y_2 := 1 - y_1$

Given  $y_1 \cdot P = x_1 \cdot \gamma_1(x_1, x_2, T) \cdot P_{\text{sat}1}(T)$   $y_1 + y_2 = 1$   
 $y_2 \cdot P = x_2 \cdot \gamma_2(x_1, x_2, T) \cdot P_{\text{sat}2}(T)$

$$\begin{pmatrix} T_{\text{bubl}} \\ y_1 \\ y_2 \end{pmatrix} := \text{Find}(T, y_1, y_2)$$

$T_{\text{bubl}} = 360.84 \text{ K}$   $y_1 = 0.415$   $y_2 = 0.585$  **Ans.**

**(b) DEW T:**  $P := 101.33 \cdot \text{kPa}$   $y_1 := 0.3$   $y_2 := 1 - x_1$

**Guess:**  $T := (90 + 273.15) \cdot \text{K}$   $x_1 := 0.05$   $x_2 := 1 - y_1$

Given  $y_1 \cdot P = x_1 \cdot \gamma_1(x_1, x_2, T) \cdot P_{\text{sat}1}(T)$   $x_1 + x_2 = 1$   
 $y_2 \cdot P = x_2 \cdot \gamma_2(x_1, x_2, T) \cdot P_{\text{sat}2}(T)$

$$\begin{pmatrix} T_{\text{dew}} \\ x_1 \\ x_2 \end{pmatrix} := \text{Find}(T, x_1, x_2)$$

$T_{\text{dew}} = 364.27 \text{ K}$   $x_1 = 0.042$   $x_2 = 0.958$  **Ans.**

**(c) P,T-flash Calculation**

$$T := \frac{T_{\text{dew}} + T_{\text{bubl}}}{2}$$

$$P := 101.33 \cdot \text{kPa}$$

$$z1 := 0.3$$

**Guess:**

$$V := 0.5$$

$$x1 := 0.1$$

$$x2 := 1 - y1$$

$$y1 := 0.1$$

$$y2 := 1 - x1$$

Given 
$$y1 = \frac{x1 \cdot \gamma1(x1, x2, T) \cdot \text{Psat}_1(T)}{P}$$

$$x1 + x2 = 1$$

$$y2 = \frac{x2 \cdot \gamma2(x1, x2, T) \cdot \text{Psat}_2(T)}{P}$$

$$y1 + y2 = 1$$

$$x1 \cdot (1 - V) + y1 \cdot V = z1 \quad \text{Eq. (10.15)}$$

$$\begin{pmatrix} x1 \\ x2 \\ y1 \\ y2 \\ V \end{pmatrix} := \text{Find}(x1, x2, y1, y2, V)$$

$$x1 = 0.069$$

$$x2 = 0.931$$

$$y1 = 0.352$$

$$y2 = 0.648$$

$$V = 0.816$$

**(d) Azeotrope Calculation**

**Test for azeotrope at:**  $P := 101.33 \cdot \text{kPa}$

$$Tb1 := \left[ \left( \frac{B1}{A1 - \ln\left(\frac{P}{\text{kPa}}\right)} - C1 \right) + 273.15 \cdot \text{K} \right]$$

$$Tb1 = 370.349 \text{ K}$$

$$Tb2 := \left[ \left( \frac{B2}{A2 - \ln\left(\frac{P}{\text{kPa}}\right)} - C2 \right) + 273.15 \cdot \text{K} \right]$$

$$Tb2 = 373.149 \text{ K}$$

$$\gamma1(0, 1, Tb2) = 14.699$$

$$\gamma2(1, 0, Tb1) = 4.05$$

$$\alpha_{12_0} := \frac{\gamma_1(0, 1, T) \cdot P_{\text{sat}_1}(T_{b2})}{P} \quad \alpha_{12_0} = 17.578$$

$$\alpha_{12_1} := \frac{P}{\gamma_2(1, 0, T) \cdot P_{\text{sat}_2}(T_{b1})} \quad \alpha_{12_1} = 0.27$$

Since one of these values is >1 and the other is <1, an azeotrope exists.  
See Ex. 10.3(e). Guesses:

$$T := (90 + 273.15) \cdot \text{K} \quad x_1 := 0.4 \quad x_2 := 1 - y_1 \quad y_1 := 0.4 \quad y_2 := 1 - x_1$$

$$\text{Given} \quad y_1 \cdot P = x_1 \cdot \gamma_1(x_1, x_2, T) \cdot P_{\text{sat}_1}(T) \quad x_1 + x_2 = 1$$

$$y_2 \cdot P = x_2 \cdot \gamma_2(x_1, x_2, T) \cdot P_{\text{sat}_2}(T) \quad y_1 + y_2 = 1 \quad x_1 = y_1$$

$$\begin{pmatrix} x_1 \\ x_2 \\ y_1 \\ y_2 \\ T_{\text{az}} \end{pmatrix} := \text{Find}(x_1, x_2, y_1, y_2, T)$$

$$T_{\text{az}} = 360.676 \text{ K}$$

$$x_1 = 0.4461$$

$$y_1 = 0.4461$$

Ans.

## 12.20 Molar volumes & Antoine coefficients:

$$V := \begin{pmatrix} 74.05 \\ 40.73 \\ 18.07 \end{pmatrix}$$

$$A := \begin{pmatrix} 14.3145 \\ 16.5785 \\ 16.3872 \end{pmatrix}$$

$$B := \begin{pmatrix} 2756.22 \\ 3638.27 \\ 3885.70 \end{pmatrix}$$

$$C := \begin{pmatrix} 228.060 \\ 239.500 \\ 230.170 \end{pmatrix}$$

$$P_{\text{sat}}(i, T) := \exp \left[ A_i - \frac{B_i}{\left( \frac{T}{\text{K}} - 273.15 \right) + C_i} \right] \cdot \text{kPa} \quad T := (65 + 273.15) \text{ K}$$

Wilson parameters:

$$a := \begin{pmatrix} 0 & -161.88 & 291.27 \\ 583.11 & 0 & 107.38 \\ 1448.01 & 469.55 & 0 \end{pmatrix} \cdot \frac{\text{cal}}{\text{mol}}$$



$$\Lambda(i, j, T) := \frac{V_j}{V_i} \cdot \exp\left(\frac{-a_{i,j}}{R \cdot T}\right) \quad i := 1..3 \quad j := 1..3 \quad p := 1..3$$

**(a) BUBL P calculation: No iteration required.**

$$x_1 := 0.3 \quad x_2 := 0.4 \quad x_3 := 1 - x_1 - x_2$$

$$\gamma(i, x, T) := \exp\left[1 - \left[ \ln\left[ \sum_j (x_j \cdot \Lambda(i, j, T)) \right] \dots \right] + \sum_p \frac{x_p \cdot \Lambda(p, i, T)}{\sum_j (x_j \cdot \Lambda(p, j, T))} \right]$$

$$P_{\text{bubl}} := \sum_i (x_i \cdot \gamma(i, x, T) \cdot P_{\text{sat}}(i, T)) \quad y_i := \frac{x_i \cdot \gamma(i, x, T) \cdot P_{\text{sat}}(i, T)}{P_{\text{bubl}}}$$

$$y = \begin{pmatrix} 0.527 \\ 0.367 \\ 0.106 \end{pmatrix} \quad P_{\text{bubl}} = 117.1 \text{ kPa} \quad \text{Ans.}$$

**(b) DEW P calculation:**

$$y_1 := 0.3 \quad y_2 := 0.4 \quad y_3 := 1 - y_1 - y_2$$

**Guess:**  $x_1 := 0.05 \quad x_2 := 0.2 \quad x_3 := 1 - x_1 - x_2 \quad P := P_{\text{bubl}}$

Given

$$P \cdot y_1 = x_1 \cdot \gamma(1, x, T) \cdot P_{\text{sat}}(1, T) \quad P \cdot y_2 = x_2 \cdot \gamma(2, x, T) \cdot P_{\text{sat}}(2, T)$$

$$P \cdot y_3 = x_3 \cdot \gamma(3, x, T) \cdot P_{\text{sat}}(3, T) \quad \sum_i x_i = 1$$

$$\begin{pmatrix} x_1 \\ x_2 \\ x_3 \\ P_{\text{dew}} \end{pmatrix} := \text{Find}(x_1, x_2, x_3, P)$$

$$x = \begin{pmatrix} 0.035 \\ 0.19 \\ 0.775 \end{pmatrix}$$

$$P_{\text{dew}} = 69.14 \text{ kPa}$$

Ans.

(c) P,T-flash calculation:

$$P := \frac{P_{\text{dew}} + P_{\text{bubl}}}{2}$$

$$T = 338.15 \text{ K}$$

$$z_1 := 0.3$$

$$z_2 := 0.4$$

$$z_3 := 1 - z_1 - z_2$$

**Guess:**  $V := 0.5$  Use  $x$  from DEW  $P$  and  $y$  from BUBL  $P$  as initial guess.

Given

$$P \cdot y_1 = x_1 \cdot \gamma(1, x, T) \cdot P_{\text{sat}}(1, T) \quad x_1 \cdot (1 - V) + y_1 \cdot V = z_1$$

$$P \cdot y_2 = x_2 \cdot \gamma(2, x, T) \cdot P_{\text{sat}}(2, T) \quad x_2 \cdot (1 - V) + y_2 \cdot V = z_2$$

$$P \cdot y_3 = x_3 \cdot \gamma(3, x, T) \cdot P_{\text{sat}}(3, T) \quad x_3 \cdot (1 - V) + y_3 \cdot V = z_3$$

$$\sum_i x_i = 1 \quad \sum_i y_i = 1$$

$$\begin{pmatrix} x_1 \\ x_2 \\ x_3 \\ y_1 \\ y_2 \\ y_3 \\ V \end{pmatrix} := \text{Find}(x_1, x_2, x_3, y_1, y_2, y_3, V)$$

$$x = \begin{pmatrix} 0.109 \\ 0.345 \\ 0.546 \end{pmatrix}$$

$$y = \begin{pmatrix} 0.391 \\ 0.426 \\ 0.183 \end{pmatrix}$$

$$V = 0.677$$

Ans.

### 12.21 Molar volumes & Antoine coefficients:

Antoine coefficients:

$$V := \begin{pmatrix} 74.05 \\ 40.73 \\ 18.07 \end{pmatrix} \quad A := \begin{pmatrix} 14.3145 \\ 16.5785 \\ 16.3872 \end{pmatrix} \quad B := \begin{pmatrix} 2756.22 \\ 3638.27 \\ 3885.70 \end{pmatrix} \quad C := \begin{pmatrix} 228.060 \\ 239.500 \\ 230.170 \end{pmatrix}$$

$$T := (65 + 273.15)\text{K} \quad P_{\text{sat}}(i, T) := \exp \left[ A_i - \frac{B_i}{\left( \frac{T}{\text{K}} - 273.15 \right) + C_i} \right] \cdot \text{kPa}$$

NRTL parameters:

$$\alpha := \begin{pmatrix} 0 & 0.3084 & 0.5343 \\ 0.3084 & 0 & 0.2994 \\ 0.5343 & 0.2994 & 0 \end{pmatrix} \quad b := \begin{pmatrix} 0 & 184.70 & 631.05 \\ 222.64 & 0 & -253.88 \\ 1197.41 & 845.21 & 0 \end{pmatrix} \cdot \frac{\text{cal}}{\text{mol}}$$

$$i := 1..3 \quad j := 1..3$$

$$l := 1..3 \quad k := 1..3 \quad \tau_{i,j} := \frac{b_{i,j}}{R \cdot T} \quad G_{i,j} := \exp(-\alpha_{i,j} \cdot \tau_{i,j})$$

(a) BUBL P calculation: No iteration required.

$$x_1 := 0.3 \quad x_2 := 0.4 \quad x_3 := 1 - x_1 - x_2$$

$$\gamma(i, x, T) := \exp \left[ \frac{\sum_j (\tau_{j,i} \cdot G_{j,i} \cdot x_j)}{\sum_l (G_{l,i} \cdot x_l)} \dots + \sum_j \left[ \frac{x_j \cdot G_{i,j}}{\sum_l (G_{l,j} \cdot x_l)} \cdot \left[ \tau_{i,j} - \frac{\sum_k (\tau_{k,j} \cdot G_{k,j})}{\sum_l (G_{l,j} \cdot x_l)} \right] \right] \right]$$

$$P_{\text{bubl}} := \sum_i (x_i \cdot \gamma(i, x, T) \cdot P_{\text{sat}}(i, T))$$

$$y_i := \frac{x_i \cdot \gamma(i, x, T) \cdot P_{\text{sat}}(i, T)}{P_{\text{bubl}}}$$

$$y = \begin{pmatrix} 0.525 \\ 0.37 \\ 0.105 \end{pmatrix}$$

$$P_{\text{bubl}} = 115.3 \text{ kPa}$$

Ans.

**(b) DEW P calculation:**

$$y_1 := 0.3 \quad y_2 := 0.4 \quad y_3 := 1 - y_1 - y_2$$

**Guess:**  $x_1 := 0.05 \quad x_2 := 0.2 \quad x_3 := 1 - x_1 - x_2 \quad P := P_{\text{bubl}}$

Given

$$P \cdot y_1 = x_1 \cdot \gamma(1, x, T) \cdot P_{\text{sat}}(1, T) \quad P \cdot y_2 = x_2 \cdot \gamma(2, x, T) \cdot P_{\text{sat}}(2, T)$$

$$P \cdot y_3 = x_3 \cdot \gamma(3, x, T) \cdot P_{\text{sat}}(3, T) \quad \sum_i x_i = 1$$

$$\begin{pmatrix} x_1 \\ x_2 \\ x_3 \\ P_{\text{dew}} \end{pmatrix} := \text{Find}(x_1, x_2, x_3, P)$$

$$x = \begin{pmatrix} 0.038 \\ 0.192 \\ 0.77 \end{pmatrix}$$

$$P_{\text{dew}} = 68.9 \text{ kPa}$$

**Ans.**

**(c) P,T-flash calculation:**

$$P := \frac{P_{\text{dew}} + P_{\text{bubl}}}{2}$$

$$T = 338.15 \text{ K}$$

$$z_1 := 0.3 \quad z_2 := 0.4 \quad z_3 := 1 - z_1 - z_2$$

**Guess:**  $V := 0.5$  Use  $x$  from DEW P and  $y$  from BUBL P as initial guess.

Given  $P \cdot y_1 = x_1 \cdot \gamma(1, x, T) \cdot P_{\text{sat}}(1, T) \quad x_1 \cdot (1 - V) + y_1 \cdot V = z_1$

$$P \cdot y_2 = x_2 \cdot \gamma(2, x, T) \cdot P_{\text{sat}}(2, T) \quad x_2 \cdot (1 - V) + y_2 \cdot V = z_2$$

$$P \cdot y_3 = x_3 \cdot \gamma(3, x, T) \cdot P_{\text{sat}}(3, T) \quad x_3 \cdot (1 - V) + y_3 \cdot V = z_3$$

$$\sum_i x_i = 1 \quad \sum_i y_i = 1$$

$$\begin{pmatrix} x_1 \\ x_2 \\ x_3 \\ y_1 \\ y_2 \\ y_3 \\ V \end{pmatrix} := \text{Find}(x_1, x_2, x_3, y_1, y_2, y_3, V)$$

$$x = \begin{pmatrix} 0.118 \\ 0.347 \\ 0.534 \end{pmatrix}$$

$$y = \begin{pmatrix} 0.391 \\ 0.426 \\ 0.183 \end{pmatrix}$$

$$V = 0.667$$

Ans.

### 12.22 Molar volumes & Antoine coefficients:

$$V := \begin{pmatrix} 74.05 \\ 40.73 \\ 18.07 \end{pmatrix}$$

$$A := \begin{pmatrix} 14.3145 \\ 16.5785 \\ 16.3872 \end{pmatrix}$$

$$B := \begin{pmatrix} 2756.22 \\ 3638.27 \\ 3885.70 \end{pmatrix}$$

$$C := \begin{pmatrix} 228.060 \\ 239.500 \\ 230.170 \end{pmatrix}$$

$$P_{\text{sat}}(i, T) := \exp \left[ A_i - \frac{B_i}{\left( \frac{T}{K} - 273.15 \right) + C_i} \right] \cdot \text{kPa} \quad P := 101.33 \text{ kPa}$$

Wilson parameters:

$$a := \begin{pmatrix} 0 & -161.88 & 291.27 \\ 583.11 & 0 & 107.38 \\ 1448.01 & 469.55 & 0 \end{pmatrix} \cdot \frac{\text{cal}}{\text{mol}}$$

$$\Lambda(i, j, T) := \frac{V_j}{V_i} \cdot \exp \left( \frac{-a_{i,j}}{R \cdot T} \right) \quad i := 1..3 \quad j := 1..3 \quad p := 1..3$$

(a) BUBL T calculation:

$$x_1 := 0.3$$

$$x_2 := 0.4$$

$$x_3 := 1 - x_1 - x_2$$

$$\gamma(i, x, T) := \exp \left[ 1 - \left[ \ln \left[ \sum_j (x_j \cdot \Lambda(i, j, T)) \right] \dots \right] + \sum_p \frac{x_p \cdot \Lambda(p, i, T)}{\sum_j (x_j \cdot \Lambda(p, j, T))} \right]$$

**Guess:**     $T := 300\text{K}$      $y_1 := 0.3$      $y_2 := 0.3$      $y_3 := 1 - y_1 - y_2$

Given

$$P \cdot y_1 = x_1 \cdot \gamma(1, x, T) \cdot \text{Psat}(1, T) \quad P \cdot y_2 = x_2 \cdot \gamma(2, x, T) \cdot \text{Psat}(2, T)$$

$$P \cdot y_3 = x_3 \cdot \gamma(3, x, T) \cdot \text{Psat}(3, T) \quad P = \sum_i (x_i \cdot \gamma(i, x, T) \cdot \text{Psat}(i, T))$$

$$\begin{pmatrix} y_1 \\ y_2 \\ y_3 \\ T_{\text{bubl}} \end{pmatrix} := \text{Find}(y_1, y_2, y_3, T)$$

$$y = \begin{pmatrix} 0.536 \\ 0.361 \\ 0.102 \end{pmatrix}$$

$$T_{\text{bubl}} = 334.08\text{K}$$

**Ans.**

**(b) DEW T calculation:**

$$y_1 := 0.3 \quad y_2 := 0.4 \quad y_3 := 1 - y_1 - y_2$$

**Guess:**     $x_1 := 0.05$      $x_2 := 0.2$      $x_3 := 1 - x_1 - x_2$      $T := T_{\text{bubl}}$

Given

$$P \cdot y_1 = x_1 \cdot \gamma(1, x, T) \cdot \text{Psat}(1, T) \quad P \cdot y_2 = x_2 \cdot \gamma(2, x, T) \cdot \text{Psat}(2, T)$$

$$P \cdot y_3 = x_3 \cdot \gamma(3, x, T) \cdot \text{Psat}(3, T) \quad \sum_i x_i = 1$$

$$\begin{pmatrix} x_1 \\ x_2 \\ x_3 \\ T_{\text{dew}} \end{pmatrix} := \text{Find}(x_1, x_2, x_3, T)$$

$$x = \begin{pmatrix} 0.043 \\ 0.204 \\ 0.753 \end{pmatrix}$$

$$T_{\text{dew}} = 347.4 \text{ K}$$

Ans.

(c) P,T-flash calculation:  $T := \frac{T_{\text{dew}} + T_{\text{bubl}}}{2}$

$$T = 340.75 \text{ K}$$

$$z_1 := 0.3$$

$$z_2 := 0.2$$

$$z_3 := 1 - z_1 - z_2$$

**Guess:**  $V := 0.5$  Use  $x$  from DEW P and  $y$  from BUBL P as initial guess.

$$\text{Given } P \cdot y_1 = x_1 \cdot \gamma(1, x, T) \cdot \text{Psat}(1, T) \quad x_1 \cdot (1 - V) + y_1 \cdot V = z_1$$

$$P \cdot y_2 = x_2 \cdot \gamma(2, x, T) \cdot \text{Psat}(2, T) \quad x_2 \cdot (1 - V) + y_2 \cdot V = z_2$$

$$P \cdot y_3 = x_3 \cdot \gamma(3, x, T) \cdot \text{Psat}(3, T) \quad x_3 \cdot (1 - V) + y_3 \cdot V = z_3$$

$$\sum_i x_i = 1 \quad \sum_i y_i = 1$$

$$\begin{pmatrix} x_1 \\ x_2 \\ x_3 \\ y_1 \\ y_2 \\ y_3 \\ V \end{pmatrix} := \text{Find}(x_1, x_2, x_3, y_1, y_2, y_3, V)$$

$$x = \begin{pmatrix} 0.125 \\ 0.17 \\ 0.705 \end{pmatrix}$$

$$y = \begin{pmatrix} 0.536 \\ 0.241 \\ 0.223 \end{pmatrix}$$

$$V = 0.426$$

Ans.

### 12.23 Molar volumes & Antoine coefficients:

Antoine coefficients:

$$V := \begin{pmatrix} 74.05 \\ 40.73 \\ 18.07 \end{pmatrix}$$

$$A := \begin{pmatrix} 14.3145 \\ 16.5785 \\ 16.3872 \end{pmatrix}$$

$$B := \begin{pmatrix} 2756.22 \\ 3638.27 \\ 3885.70 \end{pmatrix}$$

$$C := \begin{pmatrix} 228.060 \\ 239.500 \\ 230.170 \end{pmatrix}$$

$$P := 101.33 \text{ kPa}$$

$$P_{\text{sat}}(i, T) := \exp \left[ A_i - \frac{B_i}{\left( \frac{T}{K} - 273.15 \right) + C_i} \right] \cdot \text{kPa}$$

NRTL parameters:

$$\alpha := \begin{pmatrix} 0 & 0.3084 & 0.5343 \\ 0.3084 & 0 & 0.2994 \\ 0.5343 & 0.2994 & 0 \end{pmatrix}$$

$$b := \begin{pmatrix} 0 & 184.70 & 631.05 \\ 222.64 & 0 & -253.88 \\ 1197.41 & 845.21 & 0 \end{pmatrix} \cdot \frac{\text{cal}}{\text{mol}}$$

$$i := 1..3 \quad j := 1..3 \quad l := 1..3$$

$$k := 1..3$$

$$G(i, j, T) := \exp(-\alpha_{i,j} \cdot (i, j, T))$$

$$\tau(i, j, T) := \frac{b_{i,j}}{R \cdot T}$$

(a) BUBL T calculation:

$$x_1 := 0.3$$

$$x_2 := 0.4$$

$$x_3 := 1 - x_1 - x_2$$

$$\gamma(i, x, T) := \exp \left[ \frac{\sum_j \left( \tau(j, i, T) \cdot G(j, i, T) \cdot x_j \right)}{\sum_l \left( G(l, i, T) \cdot x_l \right)} \dots \right. \\ \left. + \sum_j \left[ \frac{x_j \cdot G(i, j, T)}{\sum_l \left( G(l, j, T) \cdot x_l \right)} \cdot \left[ \tau(i, j, T) - \frac{\sum_k \left( x_k \cdot \tau(k, j, T) \cdot G(k, j, T) \right)}{\sum_l \left( G(l, j, T) \cdot x_l \right)} \right] \right] \right]$$



**Guess:**  $T := 300\text{K}$      $y_1 := 0.3$      $y_2 := 0.3$      $y_3 := 1 - y_1 - y_2$

Given

$$P \cdot y_1 = x_1 \cdot \gamma(1, x, T) \cdot \text{Psat}(1, T) \quad P \cdot y_2 = x_2 \cdot \gamma(2, x, T) \cdot \text{Psat}(2, T)$$

$$P \cdot y_3 = x_3 \cdot \gamma(3, x, T) \cdot \text{Psat}(3, T) \quad P = \sum_i (x_i \cdot \gamma(i, x, T) \cdot \text{Psat}(i, T))$$

$$\begin{pmatrix} y_1 \\ y_2 \\ y_3 \\ T_{\text{bubl}} \end{pmatrix} := \text{Find}(y_1, y_2, y_3, T)$$

$$y = \begin{pmatrix} 0.533 \\ 0.365 \\ 0.102 \end{pmatrix}$$

$$T_{\text{bubl}} = 334.6\text{K}$$

**Ans.**

**(b) DEW T calculation:**

$$y_1 := 0.3$$

$$y_2 := 0.4$$

$$y_3 := 1 - y_1 - y_2$$

**Guess:**  $x_1 := 0.05$      $x_2 := 0.2$      $x_3 := 1 - x_1 - x_2$      $T := T_{\text{bubl}}$

Given

$$P \cdot y_1 = x_1 \cdot \gamma(1, x, T) \cdot \text{Psat}(1, T) \quad P \cdot y_2 = x_2 \cdot \gamma(2, x, T) \cdot \text{Psat}(2, T)$$

$$P \cdot y_3 = x_3 \cdot \gamma(3, x, T) \cdot \text{Psat}(3, T) \quad \sum_i x_i = 1$$

$$\begin{pmatrix} x_1 \\ x_2 \\ x_3 \\ T_{\text{dew}} \end{pmatrix} := \text{Find}(x_1, x_2, x_3, T)$$

$$x = \begin{pmatrix} 0.046 \\ 0.205 \\ 0.749 \end{pmatrix}$$

$$T_{\text{dew}} = 347.5\text{K}$$

**Ans.**

(c) **P,T-flash calculation:**  $T := \frac{T_{\text{dew}} + T_{\text{bubl}}}{2}$   $T = 341.011 \text{ K}$

$z_1 := 0.3$      $z_2 := 0.2$      $z_3 := 1 - z_1 - z_2$

**Guess:**     $V := 0.5$     **Use x from DEW P and y from BUBL P as initial guess.**

Given  $P \cdot y_1 = x_1 \cdot \gamma(1, x, T) \cdot \text{Psat}(1, T)$      $x_1 \cdot (1 - V) + y_1 \cdot V = z_1$

$P \cdot y_2 = x_2 \cdot \gamma(2, x, T) \cdot \text{Psat}(2, T)$      $x_2 \cdot (1 - V) + y_2 \cdot V = z_2$

$P \cdot y_3 = x_3 \cdot \gamma(3, x, T) \cdot \text{Psat}(3, T)$      $x_3 \cdot (1 - V) + y_3 \cdot V = z_3$

$\sum_i x_i = 1$      $\sum_i y_i = 1$

$\begin{pmatrix} x_1 \\ x_2 \\ x_3 \\ y_1 \\ y_2 \\ y_3 \\ V \end{pmatrix} := \text{Find}(x_1, x_2, x_3, y_1, y_2, y_3, V)$

$x = \begin{pmatrix} 0.133 \\ 0.173 \\ 0.694 \end{pmatrix}$

$y = \begin{pmatrix} 0.537 \\ 0.238 \\ 0.225 \end{pmatrix}$

$V = 0.414$

**Ans.**

12.26  $x_1 := 0.4$   $x_2 := 1 - x_1$   $V_1 := 110 \frac{\text{cm}^3}{\text{mol}}$   $V_2 := 90 \frac{\text{cm}^3}{\text{mol}}$

$VE(x_1, x_2) := x_1 \cdot x_2 \cdot (45 \cdot x_1 + 25 \cdot x_2) \frac{\text{cm}^3}{\text{mol}}$   $VE(x_1, x_2) = 7.92 \frac{\text{cm}^3}{\text{mol}}$

By Eq. (12.27):  $V(x_1, x_2) := VE(x_1, x_2) + x_1 \cdot V_1 + x_2 \cdot V_2$

$V(x_1, x_2) = 105.92 \frac{\text{cm}^3}{\text{mol}}$

By Eqs. (11.15) & (11.16):

$V_{\text{bar}_1} := V(x_1, x_2) + x_2 \cdot \frac{d}{dx_1} V(x_1, x_2)$

$V_{\text{bar}_1} = 190.28 \frac{\text{cm}^3}{\text{mol}}$

Ans.

$V_{\text{bar}_2} := V(x_1, x_2) - x_1 \cdot \left( \frac{d}{dx_1} V(x_1, x_2) \right)$

$V_{\text{bar}_2} = 49.68 \frac{\text{cm}^3}{\text{mol}}$

Check by Eq. (11.11):

$V := x_1 \cdot V_{\text{bar}_1} + x_2 \cdot V_{\text{bar}_2}$

$V = 105.92 \frac{\text{cm}^3}{\text{mol}}$

OK

12.27  $V_1 := 58.63 \frac{\text{cm}^3}{\text{mol}}$   $V_2 := 118.46 \frac{\text{cm}^3}{\text{mol}}$

$\text{moles}_1 := \frac{750 \cdot \text{cm}^3}{V_1}$

$\text{moles}_2 := \frac{1500 \cdot \text{cm}^3}{V_2}$

$\text{moles} := \text{moles}_1 + \text{moles}_2$

$\text{moles} = 25.455 \text{ mol}$

$x_1 := \frac{\text{moles}_1}{\text{moles}}$

$x_1 = 0.503$

$x_2 := 1 - x_1$

$VE := x_1 \cdot x_2 \cdot \left[ -1.026 + 0.220 \cdot (x_1 - x_2) \right] \cdot \frac{\text{cm}^3}{\text{mol}}$

$VE = -0.256 \frac{\text{cm}^3}{\text{mol}}$

By Eq. (12.27),  $V := VE + x_1 \cdot V_1 + x_2 \cdot V_2$

$V = 88.136 \frac{\text{cm}^3}{\text{mol}}$

$$V_{\text{total}} := V \cdot \text{moles} \quad V_{\text{total}} = 2243 \text{ cm}^3 \quad \text{Ans.}$$

For an ideal solution, Eq. (11.81) applies:

$$V_{\text{total}} := (x_1 \cdot V_1 + x_2 \cdot V_2) \cdot \text{moles} \quad V_{\text{total}} = 2250 \text{ cm}^3 \quad \text{Ans.}$$

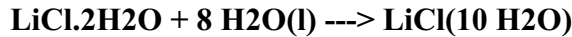
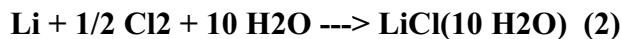
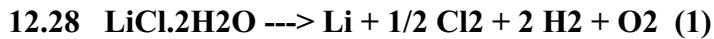

$\Delta H_1 := -(-1012650) \cdot \text{J}$  (Table C.4)

$\Delta H_2 := -441579 \cdot \text{J}$  (Pg. 457)

$\Delta H_3 := 2 \cdot (-285830 \cdot \text{J})$  (Table C.4)

$\Delta H := \Delta H_1 + \Delta H_2 + \Delta H_3$

$\Delta H = -589 \text{ J}$  (On the basis of 1 mol of solute)

Since there are 11 moles of solution per mole of solute, the result on the basis of 1 mol of solution is

$\frac{\Delta H}{11} = -53.55 \text{ J}$  Ans.

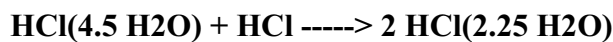
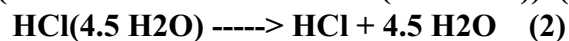
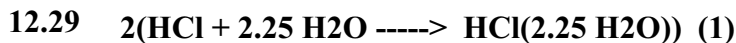

$\Delta H_1 := 2 \cdot (-50.6 \cdot \text{kJ})$  (Fig. 12.14 @ n=2.25)

$\Delta H_2 := 62 \cdot \text{kJ}$  (Fig. 12.14 @ n=4.5 with sign change)

$\Delta H := \Delta H_1 + \Delta H_2$

$\Delta H = -39.2 \text{ kJ}$  Ans.

**12.30 Calculate moles of LiCl and H2O in original solution:**

$$n_{\text{LiCl}} := \frac{0.1 \cdot 125}{42.39} \cdot \text{kmol}$$

$$n_{\text{H}_2\text{O}} := \frac{0.9 \cdot 125}{18.015} \cdot \text{kmol}$$

$$n_{\text{LiCl}} = 0.295 \text{ kmol}$$

$$n_{\text{H}_2\text{O}} = 6.245 \times 10^3 \text{ mol}$$

**Moles of LiCl added:**  $n'_{\text{LiCl}} := \frac{20}{42.39} \cdot \text{kmol}$   $n'_{\text{LiCl}} = 0.472 \text{ kmol}$

**Mole ratio, original solution:**  $\frac{n_{\text{H}_2\text{O}}}{n_{\text{LiCl}}} = 21.18$

**Mole ratio, final solution:**  $\frac{n_{\text{H}_2\text{O}}}{n_{\text{LiCl}} + n'_{\text{LiCl}}} = 8.15$

$$n_{\text{LiCl}} + n'_{\text{LiCl}} = 0.7667 \text{ kmol}$$

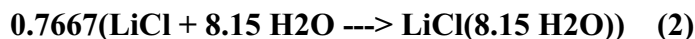

$$\Delta H_1 := n_{\text{LiCl}} \cdot \left( 35 \cdot \frac{\text{kJ}}{\text{mol}} \right) \quad (\text{Fig. 12.14, } n=21.18)$$

$$\Delta H_2 := (n_{\text{LiCl}} + n'_{\text{LiCl}}) \cdot \left( -32 \cdot \frac{\text{kJ}}{\text{mol}} \right) \quad (\text{Fig. 12.14, } n=8.15)$$

$$Q := \Delta H_1 + \Delta H_2 \quad Q = -14213 \text{ kJ} \quad \text{Ans.}$$

**12.31 Basis: 1 mole of 20% LiCl solution entering the process.**

Assume 3 steps in the process:

1. Heat M1 moles of water from 10 C to 25 C
2. Unmix 1 mole (0.8 moles water + 0.2 moles LiCl) of 20 % LiCl solution
3. Mix (M1 + 0.8) moles of water and 0.2 moles of LiCl

**Step 1: From Steam Tables**

$$\Delta H_1 := \left( 104.8 \cdot \frac{\text{kJ}}{\text{kg}} - 41.99 \cdot \frac{\text{kJ}}{\text{kg}} \right) \cdot 18.015 \cdot \frac{\text{kg}}{\text{kmol}}$$

$$\Delta H_1 = 1.132 \frac{\text{kJ}}{\text{mol}}$$

**Step 2: From Fig. 12.14 with n = 4 moles H<sub>2</sub>O/mole solute:**

$$\Delta H_2 := -25.5 \cdot \frac{\text{kJ}}{\text{mol}}$$

**Step 3: Guess M<sub>1</sub> and find ΔH<sub>3</sub> solution from Figure 12.14. Calculate ΔH for process. Continue to guess M<sub>1</sub> until ΔH = 0 for adiabatic process.**

$$M_1 := 1.3 \cdot \text{mol}$$

$$n_3 := \frac{(0.8 \cdot \text{mol} + M_1)}{0.2 \cdot \text{mol}}$$

$$\Delta H_3 := -33.16 \cdot \frac{\text{kJ}}{\text{mol}}$$

$$n_3 = 10.5$$

$$\Delta H := M_1 \cdot \Delta H_1 - 0.2 \cdot \text{mol} \cdot H_2 + 0.2 \cdot \text{mol} \cdot H_3$$

$$\Delta H = -0.061 \text{ kJ} \quad \text{Close enough}$$

$$x := \frac{0.2 \cdot \text{mol}}{M_1 + 1 \cdot \text{mol}} \quad x = 0.087 \quad \text{Ans.}$$

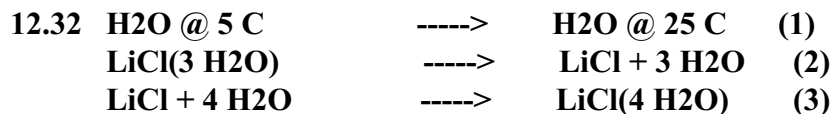

$$\Delta H_1 := \left( 104.8 \cdot \frac{\text{kJ}}{\text{kg}} - 21.01 \cdot \frac{\text{kJ}}{\text{kg}} \right) \cdot 18.015 \cdot \frac{\text{gm}}{\text{mol}} \quad \Delta H_1 = 1.509 \frac{\text{kJ}}{\text{mol}}$$

$$\Delta H_2 := 20.756 \cdot \frac{\text{kJ}}{\text{mol}} \quad \text{From p. 457 } (\Delta H \text{ LiCl(s)} - \Delta H \text{ LiCl in 3 mol H}_2\text{O})$$

$$\Delta H_3 := -25.5 \cdot \frac{\text{kJ}}{\text{mol}} \quad \text{From Figure 12.14}$$

$$\Delta H := (\Delta H_1 + \Delta H_2 + H_3) \cdot 0.2 \cdot \text{mol} \quad \Delta H = -646.905 \text{ J} \quad \text{Ans.}$$

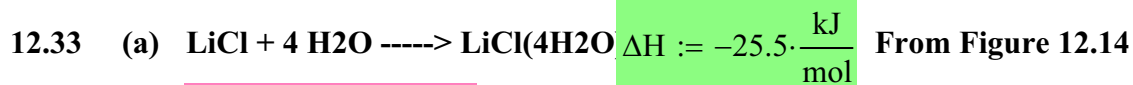

$0.2 \cdot \Delta H \cdot H = -5.1 \text{ kJ}$  Ans.



$\Delta H_1 := 20.756 \cdot \frac{\text{kJ}}{\text{mol}}$  From p. 457 ( $\Delta H \text{ LiCl}(s) - \Delta H \text{ LiCl}$  in 3 mol  $\text{H}_2\text{O}$ )

$\Delta H_2 := -25.5 \cdot \frac{\text{kJ}}{\text{mol}}$  From Figure 12.14

$\Delta H := 0.2 \cdot \Delta H \cdot (H_1 + \Delta H_2)$   $\Delta H = -0.949 \text{ kJ}$  Ans.

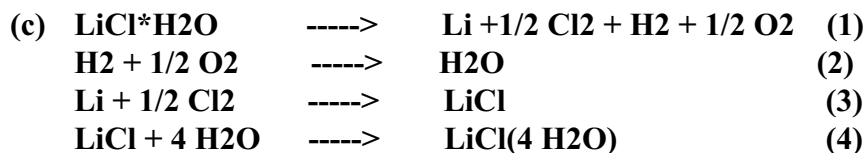

$\Delta H_1 := 712.58 \cdot \frac{\text{kJ}}{\text{mol}}$  From p. 457 for  $\text{LiCl} \cdot \text{H}_2\text{O}$

$\Delta H_2 := -285.83 \cdot \frac{\text{kJ}}{\text{mol}}$  From Table C.4  $\Delta H_f \text{H}_2\text{O}(l)$

$\Delta H_3 := -408.61 \cdot \frac{\text{kJ}}{\text{mol}}$  From p. 457 for  $\text{LiCl}$

$\Delta H_4 := -25.5 \cdot \frac{\text{kJ}}{\text{mol}}$  From Figure 12.14

$\Delta H := 0.2 \cdot \Delta H \cdot (H_1 + \Delta H_2 + \Delta H_3 + H_4)$   $\Delta H = -1.472 \text{ kJ}$  Ans.

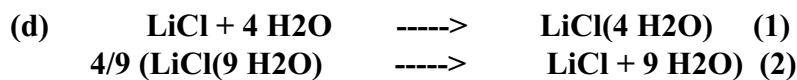

$$\Delta H_1 := -25.5 \cdot \frac{\text{kJ}}{\text{mol}}$$

From Figure 12.14

$$\Delta H_2 := \frac{4}{9} \cdot (32.4) \cdot \frac{\text{kJ}}{\text{mol}}$$

From Figure 12.14

$$\Delta H := 0.2 \cdot \text{mol} \cdot (\Delta H_1 + \Delta H_2) \quad \Delta H = -2.22 \text{ kJ} \quad \text{Ans.}$$

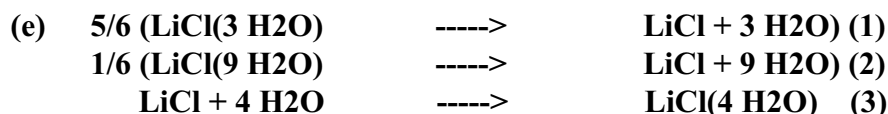

$$\Delta H_1 := \frac{5}{6} \cdot (20.756) \cdot \frac{\text{kJ}}{\text{mol}}$$

From p. 457 ( $\Delta H \text{ LiCl}(s) - \Delta H \text{ LiCl}$  in 3 mol  $\text{H}_2\text{O}$ )

$$\Delta H_2 := \frac{1}{6} \cdot (32.4) \cdot \frac{\text{kJ}}{\text{mol}}$$

From Figure 12.14

$$\Delta H_3 := -25.5 \cdot \frac{\text{kJ}}{\text{mol}}$$

From Figure 12.14

$$\Delta H := 0.2 \cdot \text{mol} \cdot (\Delta H_1 + \Delta H_2 + \Delta H_3) \quad \Delta H = -0.561 \text{ kJ} \quad \text{Ans.}$$

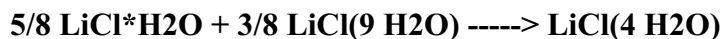
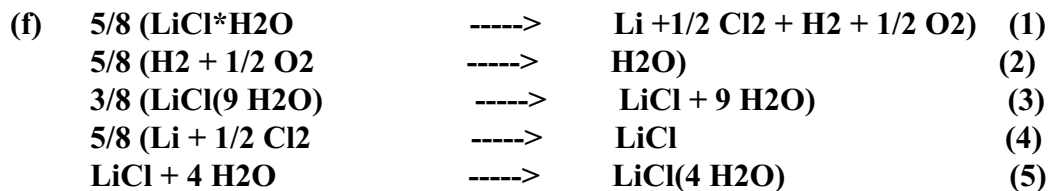

$$\Delta H_1 := \frac{5}{8} \cdot (712.58) \cdot \frac{\text{kJ}}{\text{mol}}$$

From p. 457 for  $\text{LiCl} \cdot \text{H}_2\text{O}$

$$\Delta H_2 := \frac{5}{8} \cdot (-285.83) \cdot \frac{\text{kJ}}{\text{mol}}$$

From Table C.4  $\Delta H_f \text{ H}_2\text{O}(l)$



$$\Delta H_3 := \frac{3}{8} \cdot (32.4) \cdot \frac{\text{kJ}}{\text{mol}}$$

From Figure 12.14

$$\Delta H_4 := \frac{5}{8} \cdot (-408.61) \cdot \frac{\text{kJ}}{\text{mol}}$$

From p. 457 for LiCl

$$\Delta H_5 := -25.5 \cdot \frac{\text{kJ}}{\text{mol}}$$

From Figure 12.14

$$\Delta H := 0.2 \cdot \text{mol} \cdot (\Delta H_1 + \Delta H_2 + \Delta H_3 + \Delta H_4 + \Delta H_5) \quad \Delta H = -0.403 \text{ kJ} \quad \text{Ans.}$$

12.34 BASIS: 1 second, during which the following are mixed:

(1) 12 kg hydrated (6 H<sub>2</sub>O) copper nitrate

(2) 15 kg H<sub>2</sub>O

$$n_1 := \frac{12 \text{ kg}}{295.61 \text{ kg/kmol}} \cdot \frac{\text{kmol}}{\text{sec}}$$

$$n_2 := \frac{15 \text{ kg}}{18.015 \text{ kg/kmol}} \cdot \frac{\text{kmol}}{\text{sec}}$$

$$n_1 = 0.041 \frac{\text{kmol}}{\text{sec}}$$

$$n_2 = 0.833 \frac{\text{kmol}}{\text{sec}}$$

Mole ratio, final solution:

$$\frac{6 \cdot n_1 + n_2}{n_1} = 26.51$$

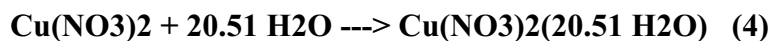
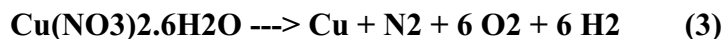

$$\Delta H_1 := 6 \cdot (-285.83 \cdot \text{kJ}) \quad (\text{Table C.4})$$

$$\Delta H_2 := -302.9 \cdot \text{kJ}$$

$$\Delta H_3 := -(-2110.8 \cdot \text{kJ})$$

$$\Delta H_4 := -47.84 \cdot \text{kJ}$$

$$\Delta H := \Delta H_1 + \Delta H_2 + \Delta H_3 + \Delta H_4$$

$$\Delta H = 45.08 \text{ kJ}$$

This value is for 1 mol of the hydrated copper nitrate. On the basis of 1 second,

$$Q := n_1 \cdot \frac{\Delta H}{\text{mol}} \quad Q = 1830 \frac{\text{kJ}}{\text{sec}} \quad \text{Ans.}$$

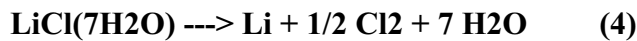
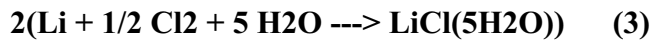
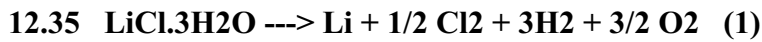

$\Delta H_1 := 1311.3 \cdot \text{kJ}$        $\Delta H_2 := 3 \cdot (-285.83 \cdot \text{kJ})$       (Table C.4)

$\Delta H_3 := 2 \cdot (-436.805 \cdot \text{kJ})$        $\Delta H_4 := -(-439.288 \cdot \text{kJ})$       (Pg. 457)

$\Delta H := \Delta H_1 + \Delta H_2 + \Delta H_3 + \Delta H_4$        $\Delta H = 19.488 \text{ kJ}$

$Q := \Delta H$        $Q = 19.488 \text{ kJ}$       Ans.

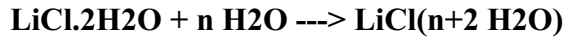
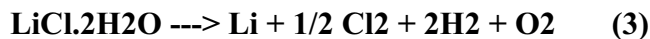

$\Delta H_2 := 2 \cdot (-285.83 \cdot \text{kJ})$        $\Delta H_3 := 1012.65 \cdot \text{kJ}$       (Table C.4)

Since the process is isothermal,  $\Delta H = \Delta H_1 + \Delta H_2 + \Delta H_3$

Since it is also adiabatic,  $\Delta H = 0$

Therefore,  $\Delta H_1 := -\Delta H_2 - \Delta H_3$        $\Delta H_1 = -440.99 \text{ kJ}$

Interpolation in the table on pg. 457 shows that the LiCl is dissolved in 8.878 mol H<sub>2</sub>O.

$x_{\text{LiCl}} := \frac{1}{9.878}$        $x_{\text{LiCl}} = 0.1012$       Ans.

12.37 Data:

n :=  $\begin{pmatrix} 10 \\ 15 \\ 20 \\ 25 \\ 50 \\ 100 \\ 300 \\ 500 \\ 1000 \end{pmatrix}$

$\Delta H_f := \begin{pmatrix} -862.74 \\ -867.85 \\ -870.06 \\ -871.07 \\ -872.91 \\ -873.82 \\ -874.79 \\ -875.13 \\ -875.54 \end{pmatrix} \cdot \text{kJ}$

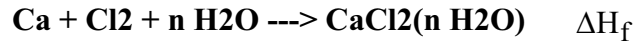

From Table C.4:  $\Delta H_{f\text{CaCl}_2} := -795.8 \cdot \text{kJ}$

i := 1 .. rows(n)

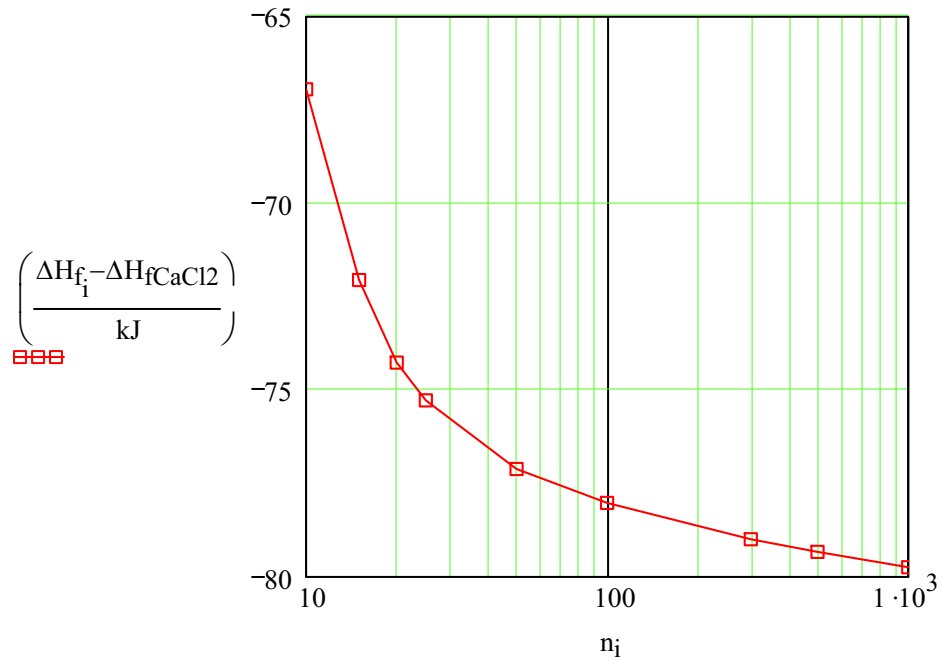

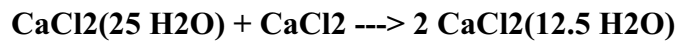
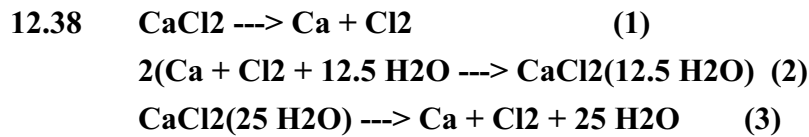

$\Delta H_1 := 795.8 \cdot \text{kJ}$  (Table C.4)

$\Delta H_2 := 2 \cdot (-865.295 \cdot \text{kJ})$        $\Delta H_3 := 871.07 \cdot \text{kJ}$

$\Delta H := \Delta H_1 + \Delta H_2 + \Delta H_3$        $Q := \Delta H$        $Q = -63.72 \text{kJ}$       **Ans.**

12.39 The process may be considered in two steps:  
 Mix at 25 degC, then heat/cool solution to the final temperature. The two steps together are adiabatic and the overall enthalpy change is 0.

Calculate moles H<sub>2</sub>O needed to form solution:

$n := \frac{\frac{85}{18.015}}{\frac{15}{110.986}}$        $n = 34.911$  Moles of H<sub>2</sub>O per mol CaCl<sub>2</sub> in final solution.

Moles of water added per mole of CaCl<sub>2</sub>·6H<sub>2</sub>O:

$n - 6 = 28.911$

Basis: 1 mol of CaCl<sub>2</sub>·6H<sub>2</sub>O dissolved

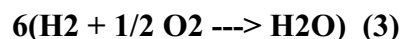
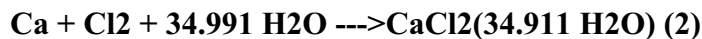
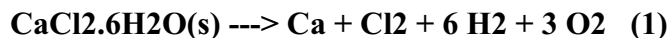

$\Delta H_1 := 2607.9 \cdot \text{kJ}$        $\Delta H_3 := 6 \cdot (-285.83 \cdot \text{kJ})$  (Table C.4)

$\Delta H_2 := -871.8 \cdot \text{kJ}$  (Pb. 12.37)

$\Delta H_{298} := \Delta H_1 + \Delta H_2 + \Delta H_3$  for reaction at 25 degC

$\Delta H_{298} = 21.12 \text{kJ}$

$m_{\text{soln}} := (110.986 + 34.911 \cdot 18.015) \cdot \text{gm}$

$m_{\text{soln}} = 739.908 \text{gm}$

$$C_P := 3.28 \cdot \frac{\text{kJ}}{\text{kg} \cdot \text{degC}}$$

$$\Delta H_{298} + C_P \cdot \Delta T = 0 \quad \Delta T := \frac{-\Delta H_{298}}{m_{\text{soln}} \cdot C_P}$$

$$\Delta T = -8.702 \text{ degC}$$

$$T := 25 \cdot \text{degC} + T$$

$$T = 16.298 \text{ degC} \quad \text{Ans.}$$

12.43  $m_1 := 150 \cdot \text{lb}$  (H<sub>2</sub>SO<sub>4</sub>)

$m_2 := 350 \cdot \text{lb}$  (25% soln.)

$$H_1 := 8 \cdot \frac{\text{BTU}}{\text{lb}_m}$$

$$H_2 := -23 \cdot \frac{\text{BTU}}{\text{lb}_m} \quad \text{(Fig. 12.17)}$$

$$\frac{100\% \cdot m_1 + 25\% \cdot m_2}{m_1 + m_2} = 47.5\%$$

(Final soln.)

$$m_3 := m_1 + m_2$$

$$H_3 := -90 \cdot \frac{\text{BTU}}{\text{lb}_m} \quad \text{(Fig. 12.17)}$$

$$Q := m_3 \cdot H_3 - (m_1 \cdot H_1 + m_2 \cdot H_2)$$

$$Q = -38150 \text{ BTU} \quad \text{Ans.}$$

12.44 Enthalpies from Fig. 12.17.

$$x_1 := 0.5$$

$$x_2 := 1 - x_1$$

$$H := -69 \cdot \frac{\text{BTU}}{\text{lb}_m} \quad \text{(50 % soln)}$$

$$H_1 := 20 \cdot \frac{\text{BTU}}{\text{lb}_m} \quad \text{(pure H}_2\text{SO}_4\text{)}$$

$$H_2 := 108 \cdot \frac{\text{BTU}}{\text{lb}_m} \quad \text{(pure H}_2\text{O)}$$

$$H_E := H - (x_1 \cdot H_1 + x_2 \cdot H_2)$$

$$H_E = -133 \frac{\text{BTU}}{\text{lb}_m} \quad \text{Ans.}$$

12.45 (a)  $m_1 := 400 \cdot \text{lb}_m$  (35% soln. at 130 degF)

$m_2 := 175 \cdot \text{lb}_m$  (10% soln. at 200 degF)

$$H_1 := 100 \cdot \frac{\text{BTU}}{\text{lb}_m} \quad H_2 := 152 \cdot \frac{\text{BTU}}{\text{lb}_m} \quad \text{(Fig. 12.19)}$$

$$\frac{35\% \cdot m_1 + 10\% \cdot m_2}{m_1 + m_2} = 27.39\% \quad \text{(Final soln)}$$

$$m_3 := m_1 + m_2 \quad H_3 := 41 \cdot \frac{\text{BTU}}{\text{lb}_m} \quad \text{(Fig. 12.19)}$$

$$Q := m_3 \cdot H_3 - (m_1 \cdot H_1 + m_2 \cdot H_2) \quad Q = -43025 \text{ BTU} \quad \text{Ans.}$$

(b) Adiabatic process,  $Q = 0$ .

$$H_3 := \frac{m_1 \cdot H_1 + m_2 \cdot H_2}{m_3} \quad H_3 = 115.826 \frac{\text{BTU}}{\text{lb}_m}$$

From Fig. 12.19 the final soln. with this enthalpy has a temperature of about 165 degF.

12.46  $m_1 := 25 \cdot \frac{\text{lb}_m}{\text{sec}}$  (feed rate)  $x_1 := 0.2$

$H_1 := -24 \cdot \frac{\text{BTU}}{\text{lb}_m}$  (Fig. 12.17 at 20% & 80 degF)

$H_2 := -55 \cdot \frac{\text{BTU}}{\text{lb}_m}$  (Fig. 12.17 at 70% and 217 degF)  
[Slight extrapolation]

$x_2 := 0.7$

$H_3 := 1157.7 \cdot \frac{\text{BTU}}{\text{lb}_m}$  (Table F.4, 1.5(psia) & 217 degF)

$m_2 := \frac{x_1 \cdot m_1}{x_2} \quad m_2 = 7.143 \frac{\text{lb}_m}{\text{sec}} \quad m_3 := m_1 - m_2 \quad m_3 = 17.857 \frac{\text{lb}_m}{\text{sec}}$

$Q := m_2 \cdot H_2 + m_3 \cdot H_3 - m_1 \cdot H_1 \quad Q = 20880 \frac{\text{BTU}}{\text{sec}} \quad \text{Ans.}$

12.47 Mix  $m_1$  lbm NaOH with  $m_2$  lbm 10% soln. @ 68 degF.

BASIS:  $m_2 := 1 \cdot \text{lb}_m$   $x_3 := 0.35$   $x_2 := 0.1$

$m_1 := 1 \cdot \text{lb}_m$  (guess)  $m_3 := m_1 + m_2$

Given  $m_1 + m_2 = m_3$   $m_1 + x_2 \cdot m_2 = x_3 \cdot m_3$

$\begin{pmatrix} m_1 \\ m_3 \end{pmatrix} := \text{Find}(m_1, m_3) \quad m_1 = 0.385 \text{ lb}_m \quad m_3 = 1.385 \text{ lb}_m$

From Example 12.8 and Fig. 12.19

$$H_1 := 478.7 \cdot \frac{\text{BTU}}{\text{lb}_m}$$

$$H_2 := 43 \cdot \frac{\text{BTU}}{\text{lb}_m}$$

$$H_3 := \frac{m_1 \cdot H_1 + m_2 \cdot H_2}{m_3}$$

$$H_3 = 164 \frac{\text{BTU}}{\text{lb}_m}$$

From Fig. 12.19 at 35% and this enthalpy, we find the temperature to be about 205 degF.

12.48 First react 1 mol SO<sub>3</sub>(l) with 1 mol H<sub>2</sub>O(l) to form 1 mol H<sub>2</sub>SO<sub>4</sub>(l):

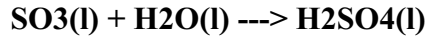

With data from Table C.4:

$$\Delta H_{298} := [-813989 - (-441040 - 285830)] \cdot \text{J}$$

$$\Delta H_{298} = -8.712 \times 10^4 \text{ J}$$

Mix 1 mol or 98.08 gm H<sub>2</sub>SO<sub>4</sub>(l) with m gm H<sub>2</sub>O to form a 50% solution.

$$m_{\text{H}_2\text{SO}_4} := 98.08 \cdot \text{gm}$$

$$m_{\text{soln}} := \frac{m_{\text{H}_2\text{SO}_4}}{0.5}$$

$$m_{\text{H}_2\text{O}} := m_{\text{soln}} - m_{\text{H}_2\text{SO}_4}$$

Data from Fig. 12.17:

$$H_{\text{H}_2\text{SO}_4} := 0 \cdot \frac{\text{BTU}}{\text{lb}_m}$$

[pure acid @ 77 degF (25 degC)]

$$H_{\text{H}_2\text{O}} := 45 \cdot \frac{\text{BTU}}{\text{lb}_m}$$

[pure water @ 77 degF (25 degC)]

$$H_{\text{soln}} := -70 \cdot \frac{\text{BTU}}{\text{lb}_m}$$

[50% soln. @ 140 degF (40 deg C)]

$$\Delta H_{\text{mix}} := m_{\text{soln}} \cdot H_{\text{soln}} - m_{\text{H}_2\text{SO}_4} \cdot H_{\text{H}_2\text{SO}_4} - m_{\text{H}_2\text{O}} \cdot H_{\text{H}_2\text{O}}$$

$$\Delta H_{\text{mix}} = -18.145 \text{ kg} \frac{\text{BTU}}{\text{lb}_m}$$

$$Q := \frac{\Delta H_{298} + \Delta H_{\text{mix}}}{m_{\text{soln}}}$$

$$Q = -283 \frac{\text{BTU}}{\text{lb}_m} \quad \text{Ans.}$$

12.49  $m_1 := 140 \cdot \text{lb}_m$        $x_1 := 0.15$        $m_2 := 230 \cdot \text{lb}_m$        $x_2 := 0.8$

$$H_1 := 65 \cdot \frac{\text{BTU}}{\text{lb}}$$

(Fig. 12.17 at 160 degF)

$$H_2 := -102 \cdot \frac{\text{BTU}}{\text{lb}}$$

(Fig. 12.17 at 100 degF)

$$m_3 := m_1 + m_2$$

$$x_3 := \frac{m_1 \cdot x_1 + m_2 \cdot x_2}{m_3} \quad x_3 = 55.4\%$$

$$Q := -20000 \cdot \text{BTU}$$

$$H_3 := \frac{Q + (m_1 \cdot H_1 + m_2 \cdot H_2)}{m_3}$$

$$H_3 = -92.9 \frac{\text{BTU}}{\text{lb}_m}$$

From Fig. 12.17 find temperature about 118 degF

12.50 Initial solution (1) at 60 degF; Fig. 12.17:

$$m_1 := 1500 \cdot \text{lb}_m$$

$$x_1 := 0.40$$

$$H_1 := -98 \cdot \frac{\text{BTU}}{\text{lb}_m}$$

Saturated steam at 1(atm); Table F.4:

$$m_3(m_2) := m_1 + m_2$$

$$H_2 := 1150.5 \cdot \frac{\text{BTU}}{\text{lb}_m}$$

$$x_3(m_2) := \frac{x_1 \cdot m_1}{m_1 + m_2}$$

$$H_3(m_2) := \frac{m_1 \cdot H_1 + m_2 \cdot H_2}{m_3(m_2)}$$

$$m_2 := 125 \cdot \text{lb}_m$$

$$x_3(m_2) = 36.9\%$$

$$H_3(m_2) = -2 \frac{\text{BTU}}{\text{lb}_m}$$

The question now is whether this result is in agreement with the value read from Fig. 12.17 at 36.9% and 180 degF. It is close, but we make a second calculation:

$$m_2 := 120 \cdot \text{lb}_m$$

$$x_3(m_2) = 37\%$$

$$H_3(m_2) = -5.5 \frac{\text{BTU}}{\text{lb}_m}$$

This is about as good a result as we can get.



**12.51 Initial solution (1) at 80 degF; Fig. 12.17:**

$$m_1 := 1 \cdot \text{lb}_m$$

$$x_1 := 0.45$$

$$H_1 := -95 \cdot \frac{\text{BTU}}{\text{lb}_m}$$

**Saturated steam at 40(psia); Table F.4:**

$$m_3(m_2) := m_1 + m_2$$

$$H_2 := 1169.8 \cdot \frac{\text{BTU}}{\text{lb}_m}$$

$$x_3(m_2) := \frac{x_1 \cdot m_1}{m_1 + m_2}$$

$$H_3(m_2) := \frac{m_1 \cdot H_1 + m_2 \cdot H_2}{m_3(m_2)}$$

$$m_2 := 0.05 \cdot \text{lb}_m$$

$$x_3(m_2) = 42.9\%$$

$$H_3(m_2) = -34.8 \frac{\text{BTU}}{\text{lb}_m}$$

The question now is whether this result is in agreement with the value read from Fig. 12.17 at 36.9% and 180 degF. It is close, but we make a second calculation:

$$m_2 := 0.048 \cdot \text{lb}_m$$

$$x_3(m_2) = 42.9\%$$

$$H_3(m_2) = -37.1 \frac{\text{BTU}}{\text{lb}_m}$$

This is about as good a result as we can get.

**12.52 Initial solution (1) at 80 degF; Fig. 12.19:**

$$m_1 := 1 \cdot \text{lb}_m$$

$$x_1 := 0.40$$

$$H_1 := 77 \cdot \frac{\text{BTU}}{\text{lb}_m}$$

**Saturated steam at 35(psia); Table F.4:**

$$H_2 := 1161.1 \cdot \frac{\text{BTU}}{\text{lb}_m}$$

$$x_3 := 0.38$$

$$m_2 := \frac{x_1 \cdot m_1}{x_3} - m_1$$

$$m_3 := m_1 + m_2$$

$$m_3 = 1.053 \text{ lb}_m$$

$$m_2 = 0.053 \text{ lb}_m$$

$$H_3 := \frac{m_1 \cdot H_1 + m_2 \cdot H_2}{m_3}$$

$$H_3 = 131.2 \frac{\text{BTU}}{\text{lb}_m}$$

We see from Fig. 12.19 that for this enthalpy at 38% the temperature is about 155 degF.

12.53 Read values for H, H1, & H2 from Fig. 12.17 at 100 degF:

$$H := -56 \cdot \frac{\text{BTU}}{\text{lb}_m}$$

$$H_1 := 8 \cdot \frac{\text{BTU}}{\text{lb}_m}$$

$$H_2 := 68 \cdot \frac{\text{BTU}}{\text{lb}_m}$$

$$x_1 := 0.35$$

$$x_2 := 1 - x_1$$

$$\Delta H := H - x_1 \cdot H_1 - x_2 \cdot H_2$$

$$\Delta H = -103 \frac{\text{BTU}}{\text{lb}_m} \quad \text{Ans.}$$

12.54 BASIS: 1(lbm) of soln.

Read values for H1 & H2 from Fig. 12.17 at 80 degF:

$$H_1 := 4 \cdot \frac{\text{BTU}}{\text{lb}_m}$$

$$H_2 := 48 \cdot \frac{\text{BTU}}{\text{lb}_m}$$

$$x_1 := 0.4$$

$$x_2 := 1 - x_1$$

$$Q = \Delta H = H - x_1 \cdot H_1 - x_2 \cdot H_2 = 0$$

$$H := x_1 \cdot H_1 + x_2 \cdot H_2$$

$$H = 30.4 \frac{\text{BTU}}{\text{lb}_m}$$

From Fig. 12.17, for a 40% soln. to have this enthalpy the temperature is well above 200 degF, probably about 250 degF.

12.55 Initial solution:

$$x_1 := \frac{2 \cdot 98.08}{2 \cdot 98.08 + 15 \cdot 18.015}$$

$$x_1 = 0.421$$

Final solution:

$$x_2 := \frac{3 \cdot 98.08}{3 \cdot 98.08 + 14 \cdot 18.015}$$

$$x_2 = 0.538$$

Data from Fig. 12.17 at 100 degF:

$$H_{\text{H}_2\text{O}} := 68 \cdot \frac{\text{BTU}}{\text{lb}_m}$$

$$H_{\text{H}_2\text{SO}_4} := 9 \cdot \frac{\text{BTU}}{\text{lb}_m}$$

$$H_1 := -75 \cdot \frac{\text{BTU}}{\text{lb}_m}$$

$$H_2 := -101 \cdot \frac{\text{BTU}}{\text{lb}_m}$$

**Unmix the initial solution:**

$$\Delta H_{\text{unmix}} := [x_1 \cdot H_{\text{H}_2\text{SO}_4} + (1 - x_1) \cdot H_{\text{H}_2\text{O}}] - H_1$$

$$\Delta H_{\text{unmix}} = 118.185 \frac{\text{BTU}}{\text{lb}_m}$$

**React 1 mol SO<sub>3</sub>(g) with 1 mol H<sub>2</sub>O(l) to form 1 mol H<sub>2</sub>SO<sub>4</sub>(l). We neglect the effect of T on the heat of reaction, taking the value at 100 degF equal to the value at 77 degF (25 degC)**

$$\Delta H_{\text{fSO}_3} := -395720 \cdot \frac{\text{J}}{\text{mol}}$$

$$\Delta H_{\text{fH}_2\text{O}} := -285830 \cdot \frac{\text{J}}{\text{mol}}$$

$$\Delta H_{\text{fH}_2\text{SO}_4} := -813989 \cdot \frac{\text{J}}{\text{mol}}$$

$$\Delta H_{\text{rx}} := \Delta H_{\text{fH}_2\text{SO}_4} - \Delta H_{\text{fH}_2\text{O}} - \Delta H_{\text{fSO}_3}$$

$$\Delta H_{\text{rx}} = -1.324 \times 10^5 \frac{\text{J}}{\text{mol}}$$

**Finally, mix the constituents to form the final solution:**

$$\Delta H_{\text{mix}} := H_2 - [x_2 \cdot H_{\text{H}_2\text{SO}_4} + (1 - x_2) \cdot H_{\text{H}_2\text{O}}] \quad \Delta H_{\text{mix}} = -137.231 \frac{\text{BTU}}{\text{lb}_m}$$

$$\begin{aligned} Q := & \Delta H_{\text{unmix}} \cdot (2 \cdot 98.08 + 15 \cdot 18.015) \cdot \text{lb} \dots \\ & + 1 \cdot \text{lb} \cdot \Delta H_{\text{rx}} \dots \\ & + \Delta H_{\text{mix}} \cdot (3 \cdot 98.08 + 14 \cdot 18.015) \cdot \text{lb} \end{aligned}$$

$$Q = -76809 \text{ BTU} \quad \text{Ans.}$$

**12.56 Read values for H(x<sub>1</sub>=0.65), H<sub>1</sub>, & H<sub>2</sub> from Fig. 12.17 at 77 degF:**

$$H := -125 \cdot \frac{\text{BTU}}{\text{lb}_m}$$

$$H_1 := 0 \cdot \frac{\text{BTU}}{\text{lb}_m}$$

$$H_2 := 45 \cdot \frac{\text{BTU}}{\text{lb}_m}$$

$$x_1 := 0.65$$

$$x_2 := 1 - x_1$$

$$\Delta H := H - x_1 \cdot H_1 - x_2 \cdot H_2$$

$$\Delta H = -140.8 \frac{\text{BTU}}{\text{lb}_m} \quad \text{Ans.}$$

From the intercepts of a tangent line drawn to the 77 degF curve of Fig. 12.17 at 65%, find the approximate values:

$$H_{bar_1} := -136 \cdot \frac{\text{BTU}}{\text{lb}_m}$$

$$H_{bar_2} := -103 \cdot \frac{\text{BTU}}{\text{lb}_m}$$

Ans.

**12.57 Graphical solution:** If the mixing is adiabatic and water is added to bring the temperature to 140 degF, then the point on the H-x diagram of Fig. 12.17 representing the final solution is the intersection of the 140-degF isotherm with a straight line between points representing the 75 wt % solution at 140 degF and pure water at 40 degF. This intersection gives  $x_3$ , the wt % of the final solution at 140 degF:

$$x_3 := 42\%$$

$$m_1 := 1 \cdot \text{lb}$$

By a mass balance:

$$x_3 = \frac{0.75 \cdot m_1}{m_1 + m_2}$$

$$m_2 := \frac{0.75 \cdot m_1}{x_3} - m_1$$

$$m_2 = 0.786 \text{ lb}_m$$

Ans.

**12.58 (a)**  $m_1 := 25 \cdot \text{lb}_m$

$$m_2 := 40 \cdot \text{lb}_m$$

$$m_3 := 75 \cdot \text{lb}_m$$

$$x_1 := 0$$

$$x_2 := 1$$

$$x_3 := 0.25$$

Enthalpy data from Fig. 12.17 at 120 degF:

$$H_1 := 88 \cdot \frac{\text{BTU}}{\text{lb}_m}$$

$$H_2 := 14 \cdot \frac{\text{BTU}}{\text{lb}_m}$$

$$H_3 := -7 \cdot \frac{\text{BTU}}{\text{lb}_m}$$

$$m_4 := m_1 + m_2 + m_3$$

$$m_4 = 140 \text{ lb}_m$$

$$x_4 := \frac{x_1 \cdot m_1 + x_2 \cdot m_2 + x_3 \cdot m_3}{m_4}$$

$$x_4 = 0.42$$

$$H_4 := -63 \cdot \frac{\text{BTU}}{\text{lb}_m}$$

(Fig. 12.17)

$$Q := m_4 \cdot H_4 - (m_1 \cdot H_1 + m_2 \cdot H_2 + m_3 \cdot H_3)$$

$$Q = -11055 \text{ BTU}$$

Ans.

(b) First step:

$m_1 := 40 \cdot \text{lb}$	$x_1 := 1$	$H_1 := 14 \cdot \frac{\text{BTU}}{\text{lb}_m}$
$m_2 := 75 \cdot \text{lb}$	$x_2 := 0.25$	$H_2 := -7 \cdot \frac{\text{BTU}}{\text{lb}_m}$

$$m_3 := m_1 + m_2 \quad x_3 := \frac{x_1 \cdot m_1 + x_2 \cdot m_2}{m_3} \quad H_3 := \frac{Q + m_1 \cdot H_1 + m_2 \cdot H_2}{m_3}$$

$x_3 = 0.511$	$H_3 = -95.8 \frac{\text{BTU}}{\text{lb}_m}$	
---------------	--	--

From Fig. 12.17 at this enthalpy and wt % the temperature is about 100 degF.

**12.59 BASIS: 1 mol NaOH neutralized.**

For following reaction; data from Table C.4:

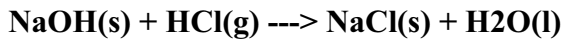

$$\Delta H_{298} := [-411153 - 285830 - (-425609 - 92307)] \cdot \text{J}$$

$$\Delta H_{298} = -1.791 \times 10^5 \text{ J}$$

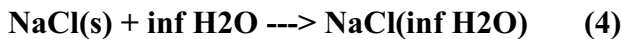
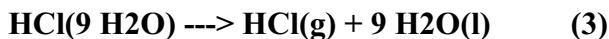

$$\Delta H_1 := \Delta H_{298}$$

$$\Delta H_2 := 44.50 \cdot \text{kJ}$$

$$\Delta H_3 := 68.50 \cdot \text{kJ}$$

$$\Delta H_4 := 3.88 \cdot \text{kJ}$$

$$\Delta H := \Delta H_1 + \Delta H_2 + \Delta H_3 + \Delta H_4$$

$$Q := \Delta H$$

$$Q = -62187 \text{ J} \quad \text{Ans.}$$

**12.60 First, find heat of solution of 1 mole of NaOH in 9 moles of H<sub>2</sub>O at 25 degC (77 degF).**

**Weight % of 10 mol-% NaOH soln:**

$$x_1 := \frac{1 \cdot 40.00}{1 \cdot 40.00 + 9 \cdot 18.015}$$

$$x_1 = 19.789\%$$

$$H_{\text{H}_2\text{O}} := 45 \cdot \frac{\text{BTU}}{\text{lb}_m}$$

(Table F.3, sat. liq. at 77 degF)

$$H_{\text{soln}} := 35 \cdot \frac{\text{BTU}}{\text{lb}_m}$$

(Fig. 12.19 at  $x_1$  and 77 degF)

$$H_{\text{NaOH}} := 478.7 \cdot \frac{\text{BTU}}{\text{lb}_m}$$

[Ex. 12.8 (p. 468 at 68 degF)]

**Correct NaOH enthalpy to 77 degF with heat capacity at 72.5 degF (295.65 K); Table C.2:**

$$T := 295.65 \cdot \text{K}$$

$$\text{molwt} := 40.00 \cdot \frac{\text{gm}}{\text{mol}}$$

$$C_p := \frac{R}{\text{molwt}} \cdot \left( 0.121 + \frac{16.316 \cdot 10^{-3}}{\text{K}} \cdot T \right)$$

$$C_p = 0.245 \frac{\text{BTU}}{\text{lb}_m \cdot \text{rankine}}$$

$$H_{\text{NaOH}} := H_{\text{NaOH}} + C_p \cdot (77 - 68) \cdot \text{rankine}$$

$$H_{\text{NaOH}} := 480.91 \cdot \frac{\text{BTU}}{\text{lb}_m}$$

$$\Delta H := H_{\text{soln}} - [x_1 \cdot H_{\text{NaOH}} + (1 - x_1) \cdot H_{\text{H}_2\text{O}}]$$

$$\Delta H = -0.224 \frac{\text{kJ}}{\text{gm}}$$

**This is for 1 gm of SOLUTION.**

**However, for 1 mol of NaOH, it becomes:**

$$\Delta H := \frac{\Delta H}{x_1} \cdot \text{molwt}$$

$$\Delta H = -45.259 \frac{\text{kJ}}{\text{mol}}$$

Now, on the BASIS of 1 mol of HCl neutralized:

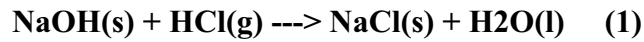

$$\Delta H_1 := -179067 \cdot \text{J} \quad (\text{Pb. 12.59})$$

$$\Delta H_2 := 74.5 \cdot \text{kJ} \quad (\text{Fig. 12.14 with sign change})$$

$$\Delta H_3 := 45.259 \cdot \text{kJ} \quad (\text{See above; note sign change})$$

$$\Delta H_4 := 3.88 \cdot \text{kJ} \quad (\text{given})$$

$$\Delta H := \Delta H_1 + \Delta H_2 + \Delta H_3 + \Delta H_4 \quad Q := \Delta H \quad Q = -14049 \text{ J} \quad \text{Ans.}$$

12.61 Note: The derivation of the equations in part a) can be found in Section B of this manual.

$$\begin{array}{c}
 x_1 := \begin{pmatrix} 0.1 \\ 0.2 \\ 0.3 \\ 0.4 \\ 0.5 \\ 0.6 \\ 0.7 \\ 0.8 \\ 0.85 \\ 0.9 \\ 0.95 \end{pmatrix}
 \end{array}
 \quad
 \begin{array}{c}
 \text{HE} := - \begin{pmatrix} 73.27 \\ 144.21 \\ 208.64 \\ 262.83 \\ 302.84 \\ 323.31 \\ 320.98 \\ 279.58 \\ 237.25 \\ 178.87 \\ 100.71 \end{pmatrix} \frac{\text{kJ}}{\text{kg}}
 \end{array}
 \quad
 \begin{array}{c}
 x_2 := \begin{pmatrix} 1 \\ -x_1 \end{pmatrix}
 \end{array}
 \quad
 \begin{array}{c}
 \text{H} := \frac{\text{HE}}{x_1 \cdot x_2}
 \end{array}$$

In order to take the necessary derivatives of  $H$ , we will fit the data to a third order polynomial of the form  $\left( H = \frac{HE}{x_1 \cdot x_2} = a + b \cdot x_1 + c \cdot x_1^2 + d \cdot x_1^3 \right)$ .

Use the Mathcad regress function to find the parameters  $a$ ,  $b$ ,  $c$  and  $d$ .

$$\begin{pmatrix} w \\ w \\ n \\ a \\ b \\ c \\ d \end{pmatrix} := \text{regress} \left[ x_1, \frac{H}{\left( \frac{\text{kJ}}{\text{kg}} \right)}, 3 \right] \quad \begin{pmatrix} w \\ w \\ n \\ a \\ b \\ c \\ d \end{pmatrix} = \begin{pmatrix} 3 \\ 3 \\ 3 \\ -735.28 \\ -824.518 \\ 195.199 \\ -914.579 \end{pmatrix}$$

$$H(x_1) := \left( a + b \cdot x_1 + c \cdot x_1^2 + d \cdot x_1^3 \right) \cdot \frac{\text{kJ}}{\text{kg}}$$

Using the equations given in the problem statement and taking the derivatives of the polynomial analytically:

$$HEbar_1(x_1) := \left[ (1 - x_1)^2 \cdot \left[ H(x_1) + x_1 \cdot \left[ b + 2 \cdot c \cdot x_1 + 3 \cdot d \cdot x_1^2 \cdot \frac{\text{kJ}}{\text{kg}} \right] \right] \right]$$

$$HEbar_2(x_1) := \left[ x_1^2 \cdot \left[ H(x_1) - (1 - x_1) \cdot \left[ b + 2 \cdot c \cdot x_1 + 3 \cdot d \cdot x_1^2 \cdot \frac{\text{kJ}}{\text{kg}} \right] \right] \right]$$



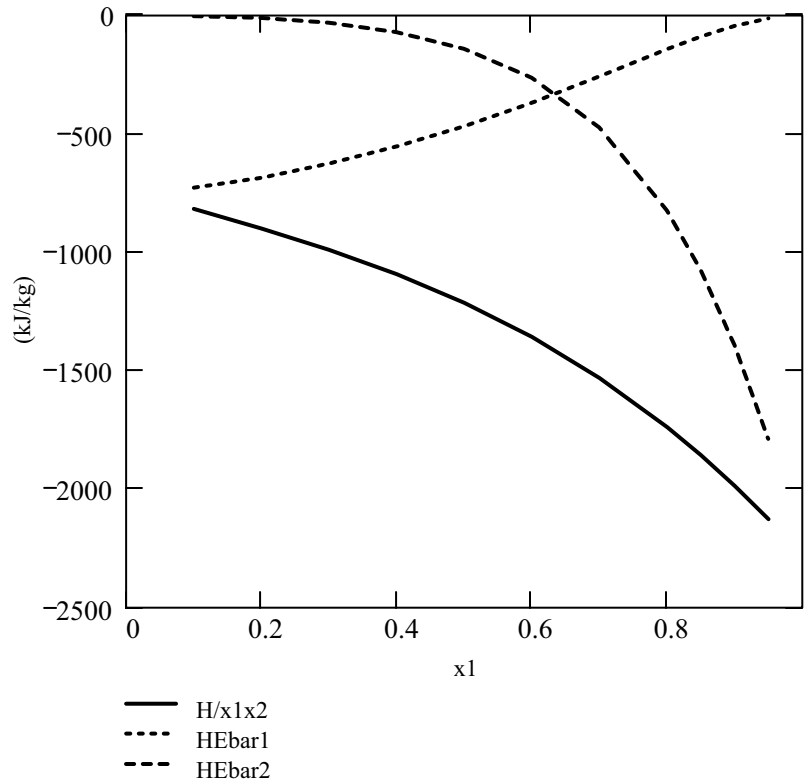

**12.62 Note: This problem uses data from problem 12.61**

$x_1 :=$	$\begin{pmatrix} 0.1 \\ 0.2 \\ 0.3 \\ 0.4 \\ 0.5 \\ 0.6 \\ 0.7 \\ 0.8 \\ 0.85 \\ 0.9 \\ 0.95 \end{pmatrix}$	$HE :=$	$\begin{pmatrix} 73.27 \\ 144.21 \\ 208.64 \\ 262.83 \\ 302.84 \\ 323.31 \\ 320.98 \\ 279.58 \\ 237.25 \\ 178.87 \\ 100.71 \end{pmatrix} \frac{\text{kJ}}{\text{kg}}$	$x_2 :=$	$\begin{pmatrix} 1 \\ 0 \end{pmatrix} - x_1$	$H :=$	$\frac{HE}{x_1 \cdot x_2}$
----------	---	---------	---	----------	--	--------	----------------------------

Fit a third order polynomial of the form  $\left( \frac{HE}{x_1 \cdot x_2} = a + b \cdot x_1 + c \cdot x_1^2 + d \cdot x_1^3 \right)$ .

Use the Mathcad regress function to find the parameters a, b, c and d.

$$\begin{pmatrix} w \\ w \\ n \\ a \\ b \\ c \\ d \end{pmatrix} := \text{regress} \left[ x_1, \frac{H}{\left( \frac{\text{kJ}}{\text{kg}} \right)}, 3 \right]$$

$$\begin{pmatrix} w \\ w \\ n \\ a \\ b \\ c \\ d \end{pmatrix} = \begin{pmatrix} 3 \\ 3 \\ 3 \\ -735.28 \\ -824.518 \\ 195.199 \\ -914.579 \end{pmatrix}$$

By the equations given in problem 12.61

$$H(x_1) := \left( a + b \cdot x_1 + c \cdot x_1^2 + d \cdot x_1^3 \right) \cdot \frac{\text{kJ}}{\text{kg}}$$

$$H(x_1) := H(x_1) \cdot x_1 \cdot (1 - x_1)$$

$$Hbar_1(x_1) := (1 - x_1)^2 \cdot \left[ H(x_1) + x_1 \cdot \left( b + 2 \cdot c \cdot x_1 + 3 \cdot d \cdot x_1^2 \right) \cdot \frac{\text{kJ}}{\text{kg}} \right]$$

$$Hbar_2(x_1) := x_1^2 \cdot \left[ H(x_1) - (1 - x_1) \cdot \left( b + 2 \cdot c \cdot x_1 + 3 \cdot d \cdot x_1^2 \right) \cdot \frac{\text{kJ}}{\text{kg}} \right]$$

At time  $\theta$ , let:

$x_1$  = mass fraction of H<sub>2</sub>SO<sub>4</sub> in tank

$m$  = total mass of 90% H<sub>2</sub>SO<sub>4</sub> added up to time  $\theta$

$H$  = enthalpy of H<sub>2</sub>SO<sub>4</sub> solution in tank at 25 C

$H_2$  = enthalpy of pure H<sub>2</sub>O at 25 C

$H_1$  = enthalpy of pure H<sub>2</sub>SO<sub>4</sub> at 25 C

$H_3$  = enthalpy of 90% H<sub>2</sub>SO<sub>4</sub> at 25 C

Material and energy balances are then written as:

$$x_1 \cdot (4000 + m) = 0.9m \quad \text{Solving for } m: \quad m(x_1) := \frac{(4000\text{kg})x_1}{0.9 - x_1} \quad \text{Eq. (A)}$$

$$Q = \Delta Ht = (4000 + m) \cdot H - 4000H_2 - m \cdot H_3$$

Since  $\Delta H = H - x_1 \cdot H_1 - x_2 \cdot H_2$  and since  $T$  is constant at  $25\text{ C}$ , we set  $H_1 = H_2 = 0$  at this  $T$ , making  $H = \Delta H$ . The energy balance then becomes:

$$Q = (4000 + m) \cdot \Delta H - m \cdot H_3 \quad \text{Eq. (B)}$$

Applying these equations to the overall process, for which:

$$\theta := 6\text{hr} \quad x_1 := 0.5 \quad H_3 := H(0.9) \quad H_3 = -178.737 \frac{\text{kJ}}{\text{kg}}$$

$$\Delta H := H(0.5) \quad \Delta H = -303.265 \frac{\text{kJ}}{\text{kg}}$$

Define quantities as a function of  $x_1$

$$Q(x_1) := [(4000\text{kg} + m(x_1)) \cdot H(x_1) - m(x_1) \cdot H_3]$$

$$m(x_1) := \frac{(4000\text{kg})x_1}{0.9 - x_1} \quad m(0.5) = 5000\text{kg}$$

$$Qt(x_1) := (4000\text{kg} + m(x_1)) \cdot \Delta H - m(x_1) \cdot H_3 \quad Qt(0.5) = -1.836 \times 10^6 \text{kJ}$$

Since the heat transfer rate  $q$  is constant:

$$q := \frac{Qt(x_1)}{\theta}$$

$$\text{and } \Theta(x_1) := \frac{Q(x_1)}{q} \quad \text{Eq. (C)}$$

The following is probably the most elegant solution to this problem, and it leads to the direct calculation of the required rates,

$$r = \frac{dm}{d\theta}$$

When 90% acid is added to the tank it undergoes an enthalpy change equal to:  $0.9H_{\text{bar}1} + 0.1H_{\text{bar}2} - H_3$ , where  $H_{\text{bar}1}$  and  $H_{\text{bar}2}$  are the partial enthalpies of  $\text{H}_2\text{SO}_4$  and  $\text{H}_2\text{O}$  in the solution of mass fraction  $x_1$  existing in the tank at the instant of addition. This enthalpy change equals the heat required per kg of 90% acid to keep the temperature at  $25\text{ C}$ . Thus,

$$r(x_1) := \frac{q}{0.9H_{\text{bar}1}(x_1) + 0.1H_{\text{bar}2}(x_1) - H_3}$$

Plot the rate as a function of time  $x_1 := 0, 0.01 \dots 0.5$

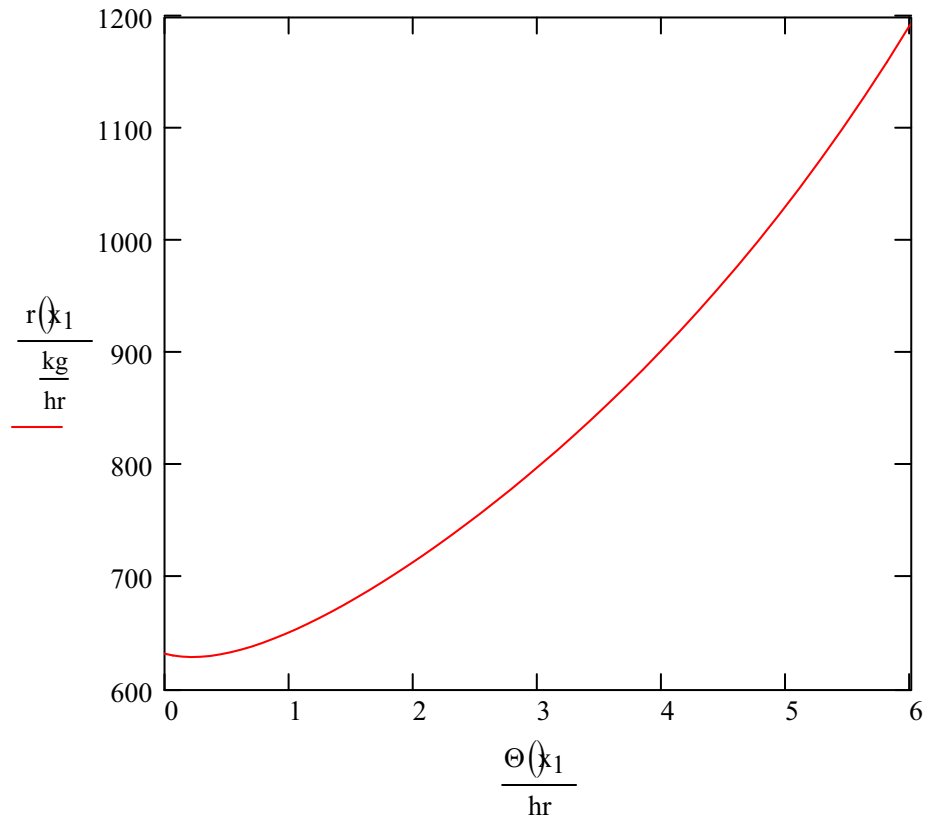

12.64  $\dot{m}_1 := 20000 \frac{\text{lb}}{\text{hr}}$        $x_1 := 0.8$        $T_1 := 120\text{degF}$        $H_1 := -92 \frac{\text{BTU}}{\text{lb}}$

Enthalpies from Fig. 12.17  $x_2 := 0.0$        $T_2 := 40\text{degF}$        $H_2 := 7 \frac{\text{BTU}}{\text{lb}}$

$x_3 := 0.5$        $T_3 := 140\text{degF}$        $H_3 := -70 \frac{\text{BTU}}{\text{lb}}$

a) Use mass balances to find feed rate of cold water and product rate.

**Guess:**       $\dot{m}_2 := \dot{m}_1$        $\dot{m}_3 := 2\dot{m}_1$

Given       $\dot{m}_1 + \dot{m}_2 = \dot{m}_3$       **Total balance**

$\dot{m}_1 \cdot x_1 + \dot{m}_2 \cdot x_2 = \dot{m}_3 \cdot x_3$       **H<sub>2</sub>SO<sub>4</sub> balance**

$$\begin{pmatrix} \dot{m}_2 \\ \dot{m}_3 \end{pmatrix} := \text{Find}(\dot{m}_2, \dot{m}_3) \quad \dot{m}_2 = 12000 \frac{\text{lb}}{\text{hr}} \quad \dot{m}_3 = 32000 \frac{\text{lb}}{\text{hr}} \quad \text{Ans.}$$

b) Apply an energy balance on the mixer

$$\dot{Q} := \dot{m}_3 \cdot H_3 - (\dot{m}_1 \cdot H_1 + \dot{m}_2 \cdot H_2) \quad \dot{Q} = -484000 \frac{\text{BTU}}{\text{hr}}$$

Since  $\dot{Q}$  is negative, heat is removed from the mixer.

c) For an adiabatic process,  $\dot{Q}$  is zero. Solve the energy balance to find  $H_3$

$$H_3 := \frac{\dot{m}_1 \cdot H_1 + \dot{m}_2 \cdot H_2}{\dot{m}_3} \quad H_3 = -54.875 \frac{\text{BTU}}{\text{lb}}$$

From Fig. 12.17, this corresponds to a temperature of about 165 F

12.65 Let  $L$  = total moles of liquid at any point in time and  $\dot{V}$  = rate at which liquid boils and leaves the system as vapor.

An unsteady state mole balance yields:  $\frac{dL}{dt} = -\dot{V}$

An unsteady state species balance on water yields:  $\frac{d(L \cdot x_1)}{dt} = -y_1 \cdot \dot{V}$

Expanding the derivative gives:  $L \cdot \frac{dx_1}{dt} + x_1 \cdot \frac{dL}{dt} = -\dot{V} \cdot y_1$

Substituting  $-\dot{V}$  for  $dL/dt$ :  $L \cdot \frac{dx_1}{dt} + x_1 \cdot (-\dot{V}) = -y_1 \cdot \dot{V}$

Rearranging this equation gives:  $L \cdot \frac{dx_1}{dt} = (x_1 - y_1) \cdot \dot{V}$

Substituting  $-dL/dt$  for  $\dot{V}$ :  $L \cdot \frac{dx_1}{dt} = (y_1 - x_1) \cdot \frac{dL}{dt}$

Eliminating  $dt$  and rearranging:  $\frac{dx_1}{y_1 - x_1} = \frac{dL}{L}$

At low concentrations  $y_1$  and  $x_1$  can be related by:

$$y_1 = \left( \gamma_{\text{infl}} \cdot \frac{P_{\text{sat}1}}{P} \cdot x_1 \right) = K_1 \cdot x_1 \quad \text{where:} \quad K_1 = \gamma_{\text{infl}} \cdot \frac{P_{\text{sat}1}}{P}$$

Substituting gives: 
$$\frac{dx_1}{(K_1 - 1) x_1} = \frac{dL}{L}$$

Integrating this equation yields: 
$$\ln\left(\frac{L_f}{L_0}\right) = \frac{1}{(K_1 - 1)} \cdot \ln\left(\frac{x_{1f}}{x_{10}}\right)$$

where  $L_0$  and  $x_{10}$  are the initial conditions of the system

For this problem the following values apply:

$$L_0 := 1 \text{ mol}$$

$$x_{10} := \frac{600}{10^6}$$

$$x_{1f} := \frac{50}{10^6}$$

$$T := 130 \text{ degC}$$

$$P := 1 \text{ atm}$$

$$\gamma_{\text{infl}} := 5.8$$

$$P_{\text{sat}1} := \exp\left(16.3872 - \frac{3885.70}{\frac{T}{\text{degC}} + 230.170}\right) \cdot \text{kPa} \quad P_{\text{sat}1} = 270.071 \text{ kPa}$$

$$K_1 := \gamma_{\text{infl}} \cdot \frac{P_{\text{sat}1}}{P} \quad K_1 = 15.459$$

$$L_f := L_0 \cdot \exp\left[\frac{1}{(K_1 - 1)} \cdot \ln\left(\frac{x_{1f}}{x_{10}}\right)\right] \quad L_f = 0.842 \text{ mole}$$

$$n_{\text{org}0} := L_0 \cdot (1 - x_{10}) \quad n_{\text{org}f} := L_f \cdot (1 - x_{1f})$$

$$n_{\text{org}0} = 0.999 \text{ mole} \quad n_{\text{org}f} = 0.842 \text{ mole}$$

$$\% \text{loss}_{\text{org}} := \frac{n_{\text{org}0} - n_{\text{org}f}}{n_{\text{org}0}} \quad \% \text{loss}_{\text{org}} = 15.744\% \quad \text{Ans.}$$

The water can be removed but almost 16% of the organic liquid will be removed with the water.

12.69 1 - Acetone 2- Methanol  $T := (50 + 273.15)K$

For Wilson equation

$$a_{12} := -161.88 \frac{\text{cal}}{\text{mol}} \quad a_{21} := 583.11 \frac{\text{cal}}{\text{mol}} \quad V_1 := 74.05 \frac{\text{cm}^3}{\text{mol}} \quad V_2 := 40.73 \frac{\text{cm}^3}{\text{mol}}$$

$$\Lambda_{12} := \frac{V_2}{V_1} \cdot \exp\left(\frac{-a_{12}}{R \cdot T}\right) \quad \Lambda_{12} = 0.708 \quad \Lambda_{21} := \frac{V_1}{V_2} \cdot \exp\left(\frac{-a_{21}}{R \cdot T}\right) \quad \Lambda_{21} = 0.733$$

From p. 445  $\ln \gamma_{inf1} := \left( \frac{1}{2} \right) \ln(\Lambda_{12} + \Lambda_{21} - 1) \quad \ln \gamma_{inf1} = 0.613 \quad \text{Ans.}$

$$\ln \gamma_{inf2} := \left( \frac{1}{2} \right) \ln(\Lambda_{21} + \Lambda_{12} - 1) \quad \ln \gamma_{inf2} = 0.603 \quad \text{Ans.}$$

From Fig. 12.9(b)  $\ln \gamma_{inf1} = 0.62 \quad \ln \gamma_{inf2} = 0.61$

For NRTL equation

$$b_{12} := 184.70 \frac{\text{cal}}{\text{mol}} \quad b_{21} := 222.64 \frac{\text{cal}}{\text{mol}} \quad \alpha := 0.3048$$

$$\tau_{12} := \frac{b_{12}}{R \cdot T} \quad \tau_{12} = 0.288 \quad \tau_{21} := \frac{b_{21}}{R \cdot T} \quad \tau_{21} = 0.347$$

$$G_{12} := \exp(-\alpha \cdot \tau_{12}) \quad G_{12} = 0.916 \quad G_{21} := \exp(-\alpha \cdot \tau_{21}) \quad G_{21} = 0.9$$

From p. 446  $\ln \gamma_{inf1} := \tau_{21} + \tau_{12} \cdot \exp(-\alpha \cdot \tau_{12}) \quad \ln \gamma_{inf1} = 0.611$

$$\ln \gamma_{inf2} := \tau_{12} + \tau_{21} \cdot \exp(-\alpha \cdot \tau_{21}) \quad \ln \gamma_{inf2} = 0.600$$

Both estimates are in close agreement with the values from Fig. 12.9 (b)

12.71  $P_{sat1} := 183.4 \text{ kPa}$        $P_{sat2} := 96.7 \text{ kPa}$

$x_1 := 0.253$

$y_1 := 0.456$

$P := 139.1 \text{ kPa}$

Check whether or not the system is ideal using Raoult's Law (RL)

$P_{RL} := x_1 \cdot P_{sat1} + (1 - x_1) \cdot P_{sat2}$        $P_{RL} = 118.635 \text{ kPa}$

Since  $P_{RL} < P$ ,  $\gamma_1$  and  $\gamma_2$  are not equal to 1. Therefore, we need a model for  $GE/RT$ . A two parameter model will work.

From Margules Equation:  $\frac{GE}{RT} = x_1 \cdot x_2 \cdot (A_{21} \cdot x_1 + A_{12} \cdot x_2)$

$\ln(\gamma_1) = x_2^2 \cdot [A_{12} + 2 \cdot (A_{21} - A_{12}) \cdot x_1]$       Eq. (12.10a)

$\ln(\gamma_2) = x_1^2 \cdot [A_{21} + 2 \cdot (A_{12} - A_{21}) \cdot x_2]$       Eq. (12.10b)

Find  $\gamma_1$  and  $\gamma_2$  at  $x_1=0.253$  from the given data.

$\gamma_1 := \frac{y_1 \cdot P}{x_1 \cdot P_{sat1}}$        $\gamma_1 = 1.367$        $\gamma_2 := \frac{(1 - y_1) \cdot P}{(1 - x_1) \cdot P_{sat2}}$        $\gamma_2 = 1.048$

Use the values of  $\gamma_1$  and  $\gamma_2$  at  $x_1=0.253$  and Eqs. (12.10a) and (12.10b) to find  $A_{12}$  and  $A_{21}$ .

Guess:       $A_{12} := 0.5$        $A_{21} := 0.5$

Given       $\ln(\gamma_1) = (1 - x_1)^2 \cdot [A_{12} + 2 \cdot (A_{21} - A_{12}) \cdot x_1]$       Eq. (12.10a)

$\ln(\gamma_2) = x_1^2 \cdot [A_{21} + 2 \cdot (A_{12} - A_{21}) \cdot (1 - x_1)]$       Eq. (12.10b)

$\begin{pmatrix} A_{12} \\ A_{21} \end{pmatrix} := \text{Find}(A_{12}, A_{21})$        $A_{12} = 0.644$        $A_{21} = 0.478$

$\gamma_1(x_1) := \exp\left[(1 - x_1)^2 \cdot [A_{12} + 2 \cdot (A_{21} - A_{12}) \cdot x_1]\right]$

$\gamma_2(x_1) := \exp\left[x_1^2 \cdot [A_{21} + 2 \cdot (A_{12} - A_{21}) \cdot (1 - x_1)]\right]$



$$\text{a) } x_1 := 0.5 \quad y_1 := \frac{x_1 \cdot \gamma_1(x_1) \cdot P_{\text{sat}1}}{P} \quad y_1 = 0.743 \quad \text{Ans.}$$

$$P := x_1 \cdot \gamma_1(x_1) \cdot P_{\text{sat}1} + (1 - x_1) \cdot \gamma_2(x_1) \cdot P_{\text{sat}2} \quad P = 160.148 \text{ kPa} \quad \text{Ans.}$$

$$\text{b) } \gamma_{1\text{inf}} := \exp(A_{12}) \quad \gamma_{1\text{inf}} = 1.904 \quad \gamma_{2\text{inf}} := \exp(A_{21}) \quad \gamma_{2\text{inf}} = 1.614$$

$$\alpha_{12_0} := \frac{\gamma_{1\text{inf}} \cdot P_{\text{sat}1}}{P_{\text{sat}2}} \quad \alpha_{12_0} = 3.612 \quad \alpha_{12_1} := \frac{P_{\text{sat}1}}{\gamma_{2\text{inf}} \cdot P_{\text{sat}2}} \quad \alpha_{12_1} = 1.175$$

Since  $\alpha_{12}$  remains above a value of 1, an azeotrope is unlikely based on the assumption that the model of  $G^E/RT$  is reliable.

$$12.72 \quad P := 108.6 \text{ kPa} \quad x_1 := 0.389$$

$$T := (35 + 273.15) \text{ K} \quad P_{\text{sat}1} := 120.2 \text{ kPa} \quad P_{\text{sat}2} := 73.9 \text{ kPa}$$

Check whether or not the system is ideal using Raoult's Law (RL)

$$P_{\text{RL}} := x_1 \cdot P_{\text{sat}1} + (1 - x_1) \cdot P_{\text{sat}2} \quad P_{\text{RL}} = 91.911 \text{ kPa}$$

Since  $P_{\text{RL}} < P$ ,  $\gamma_1$  and  $\gamma_2$  are not equal to 1. Therefore, we need a model for  $G^E/RT$ . A one parameter model will work.

$$\text{Assume a model of the form: } \frac{G^E}{RT} = A \cdot x_1 \cdot x_2$$

$$\gamma_1 = \exp(A \cdot x_2^2)$$

$$\gamma_2 = \exp(A \cdot x_1^2)$$

Since we have no  $y_1$  value, we must use the following equation to find A:

$$P = x_1 \cdot \gamma_1 \cdot P_{\text{sat}1} + x_2 \cdot \gamma_2 \cdot P_{\text{sat}2}$$

Use the data to find the value of A

Guess:  $A := 1$

$$\text{Given } P = x_1 \cdot \exp\left[A \cdot (1 - x_1)^2\right] \cdot P_{\text{sat}1} + (1 - x_1) \cdot \exp\left[A \cdot x_1^2\right] \cdot P_{\text{sat}2}$$

$$A := \text{Find}(A) \quad A = 0.677$$

$$\gamma_1(x_1) := \exp\left[A \cdot (1 - x_1)^2\right] \quad \gamma_2(x_1) := \exp\left[A \cdot x_1^2\right]$$

$$\text{a) } y_1 := x_1 \cdot \gamma_1(x_1) \cdot \frac{P_{\text{sat}1}}{P} \quad y_1 = 0.554 \quad \text{Ans.}$$

$$\text{b) } P := x_1 \cdot \gamma_1(x_1) \cdot P_{\text{sat}1} + (1 - x_1) \cdot \gamma_2(x_1) \cdot P_{\text{sat}2} \quad P = 110.228 \text{ kPa} \quad \text{Ans.}$$

$$\text{c) } \gamma_{1\text{inf}} := \exp(A) \quad \gamma_{1\text{inf}} = 1.968 \quad \gamma_{2\text{inf}} := \exp(A) \quad \gamma_{2\text{inf}} = 1.968$$

$$\alpha_{12_0} := \frac{\gamma_{1\text{inf}} \cdot P_{\text{sat}1}}{P_{\text{sat}2}} \quad \alpha_{12_0} = 3.201 \quad \alpha_{12_1} := \frac{P_{\text{sat}1}}{\gamma_{2\text{inf}} \cdot P_{\text{sat}2}} \quad \alpha_{12_1} = 0.826$$

Since  $\alpha_{12}$  ranges from less than 1 to greater than 1 an azeotrope is likely based on the assumption that our model is reliable.

## Chapter 13 - Section A - Mathcad Solutions

**Note:** For the following problems the variable kelvin is used for the SI unit of absolute temperature so as not to conflict with the variable K used for the equilibrium constant

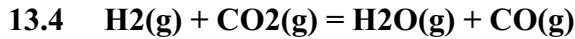

$$v = \sum_i v_i = -1 - 1 + 1 + 1 = 0 \qquad n_0 = 1 + 1 = 2$$

By Eq. (13.5).  $y_{\text{H}_2} = y_{\text{CO}_2} = \frac{1 - \varepsilon}{2} \qquad y_{\text{H}_2\text{O}} = y_{\text{CO}} = \frac{\varepsilon}{2}$

By Eq. (A) and with data from Example 13.13 at 1000 K:

$T := 1000 \cdot \text{kelvin}$

$$G(\varepsilon) := \left( \frac{1 - \varepsilon}{2} \right) \cdot (-395790) \cdot \frac{\text{J}}{\text{mol}} + \frac{\varepsilon}{2} \cdot (-192420 - 200240) \cdot \frac{\text{J}}{\text{mol}} \dots$$

$$+ R \cdot T \cdot \left( 2 \cdot \frac{1 - \varepsilon}{2} \cdot \ln \left( \frac{1 - \varepsilon}{2} \right) + 2 \cdot \frac{\varepsilon}{2} \cdot \ln \left( \frac{\varepsilon}{2} \right) \right)$$

**Guess:**  $\varepsilon_e := 0.5$

Given  $\frac{d}{d\varepsilon} G(\varepsilon_e) = 0 \cdot \frac{\text{J}}{\text{mol}} \qquad \varepsilon_e := \text{Find}(\varepsilon_e) \qquad \varepsilon_e = 0.45308$

$\varepsilon := 0.3, 0.31 \dots 0.6$

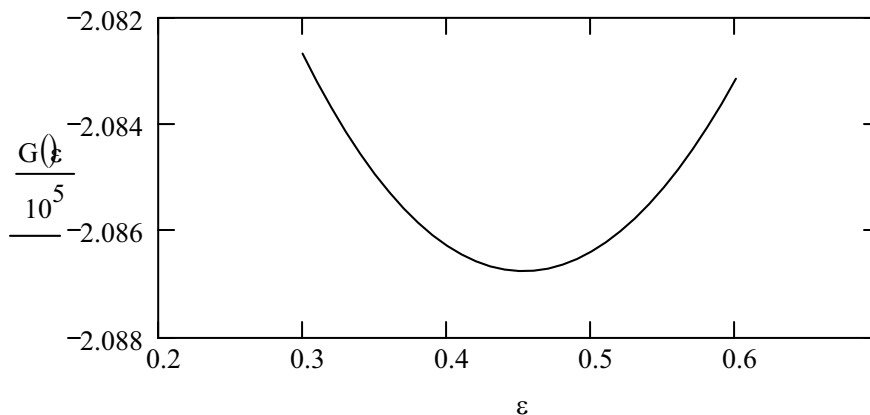

13.5 (a)  $\text{H}_2(\text{g}) + \text{CO}_2(\text{g}) = \text{H}_2\text{O}(\text{g}) + \text{CO}(\text{g})$

$$v = \sum_i v_i = -1 - 1 + 1 + 1 = 0 \quad n_0 = 1 + 1 = 2$$

By Eq. (13.5).  $y_{\text{H}_2} = y_{\text{CO}_2} = \frac{1 - \varepsilon}{2} \quad y_{\text{H}_2\text{O}} = y_{\text{CO}} = \frac{\varepsilon}{2}$

By Eq. (A) and with data from Example 13.13 at 1100 K:

$T := 1100 \cdot \text{kelvin}$

$$G(\varepsilon) := \left(\frac{1 - \varepsilon}{2}\right) \cdot (-395960) \cdot \frac{\text{J}}{\text{mol}} + \frac{\varepsilon}{2} \cdot (-187000 - 209110) \cdot \frac{\text{J}}{\text{mol}} \dots$$

$$+ R \cdot T \cdot \left( 2 \cdot \frac{1 - \varepsilon}{2} \cdot \ln\left(\frac{1 - \varepsilon}{2}\right) + 2 \cdot \frac{\varepsilon}{2} \cdot \ln\left(\frac{\varepsilon}{2}\right) \right)$$

**Guess:**  $\varepsilon_e := 0.5$

Given  $\frac{d}{d\varepsilon_e} G(\varepsilon_e) = 0 \cdot \frac{\text{J}}{\text{mol}} \quad \varepsilon_e := \text{Find}(\varepsilon_e) \quad \varepsilon_e = 0.502 \quad \text{Ans.}$

$\varepsilon := 0.35, 0.36 \dots 0.65$

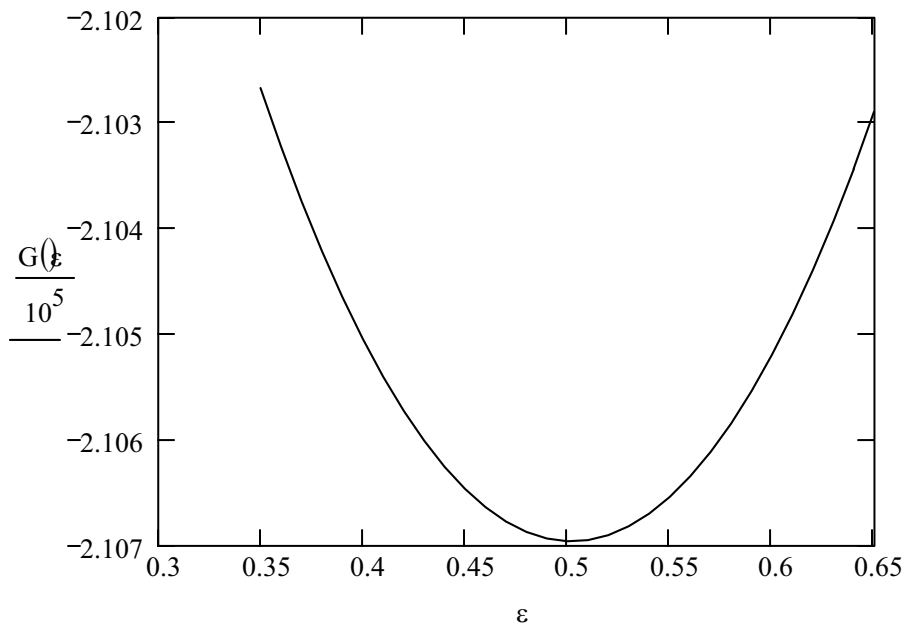

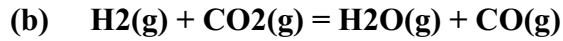

$$v = \sum_i v_i = -1 - 1 + 1 + 1 = 0 \qquad n_0 = 1 + 1 = 2$$

By Eq. (13.5),  $y_{\text{H}_2} = y_{\text{CO}_2} = \frac{1 - \varepsilon}{2}$   $y_{\text{H}_2\text{O}} = y_{\text{CO}} = \frac{\varepsilon}{2}$

By Eq. (A) and with data from Example 13.13 at 1200 K:

$T := 1200 \cdot \text{kelvin}$

$$G(\xi) := \left(\frac{1 - \varepsilon}{2}\right) \cdot (-396020) \cdot \frac{\text{J}}{\text{mol}} + \frac{\varepsilon}{2} \cdot (-181380 - 217830) \cdot \frac{\text{J}}{\text{mol}} \dots$$

$$+ R \cdot T \cdot \left( 2 \cdot \frac{1 - \varepsilon}{2} \cdot \ln\left(\frac{1 - \varepsilon}{2}\right) + 2 \cdot \frac{\varepsilon}{2} \cdot \ln\left(\frac{\varepsilon}{2}\right) \right)$$

**Guess:**  $\varepsilon_e := 0.1$

Given  $\frac{d}{d\varepsilon_e} G(\xi_e) = 0 \cdot \frac{\text{J}}{\text{mol}}$   $\varepsilon_e := \text{Find}(\xi_e)$   $\varepsilon_e = 0.53988$  **Ans.**

$\varepsilon := 0.4, 0.41 .. 0.7$

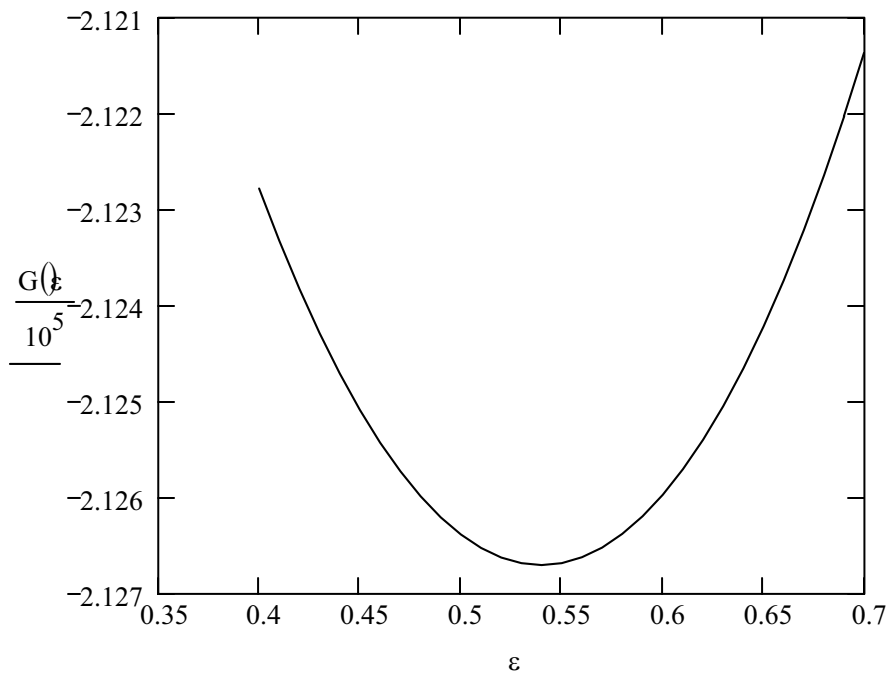

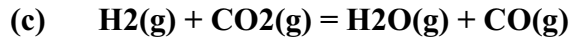

$$v = \sum_i v_i = -1 - 1 + 1 + 1 = 0 \qquad n_0 = 1 + 1 = 2$$

By Eq. (13.5),  $y_{\text{H}_2} = y_{\text{CO}_2} = \frac{1 - \varepsilon}{2} \qquad y_{\text{H}_2\text{O}} = y_{\text{CO}} = \frac{\varepsilon}{2}$

By Eq. (A) and with data from Example 13.13 at 1300 K:

$T := 1300 \cdot \text{kelvin}$

$$G(\varepsilon) := \left(\frac{1 - \varepsilon}{2}\right) \cdot (-396080) \cdot \frac{\text{J}}{\text{mol}} + \frac{\varepsilon}{2} \cdot (-175720 - 226530) \cdot \frac{\text{J}}{\text{mol}} \dots$$

$$+ R \cdot T \cdot \left( 2 \cdot \frac{1 - \varepsilon}{2} \cdot \ln\left(\frac{1 - \varepsilon}{2}\right) + 2 \cdot \frac{\varepsilon}{2} \cdot \ln\left(\frac{\varepsilon}{2}\right) \right)$$

Guess:  $\varepsilon_e := 0.6$

Given  $\frac{d}{d\varepsilon_e} G(\varepsilon_e) = 0 \cdot \frac{\text{J}}{\text{mol}} \quad \varepsilon_e := \text{Find}(\varepsilon_e) \quad \varepsilon_e = 0.57088 \quad \text{Ans.}$

$\varepsilon := 0.4, 0.41 \dots 0.7$

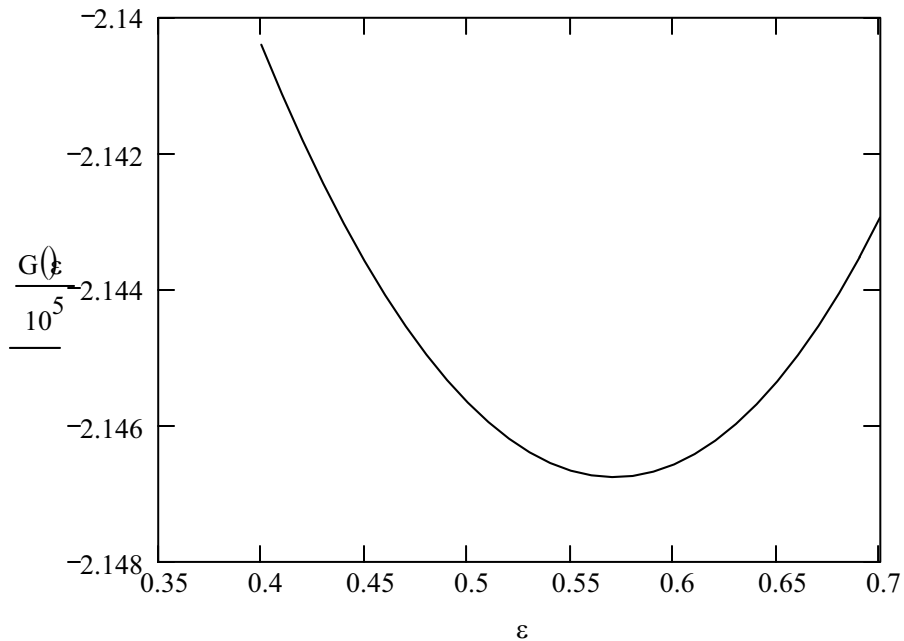

**13.6 H<sub>2</sub>(g) + CO<sub>2</sub>(g) = H<sub>2</sub>O(g) + CO(g)**

$$v = \sum_i v_i = -1 - 1 + 1 + 1 = 0 \qquad n_0 = 1 + 1 = 2$$

By Eq. (13.5),  $y_{H_2} = y_{CO_2} = \frac{1-\varepsilon}{2}$   $y_{H_2O} = y_{CO} = \frac{\varepsilon}{2}$

With data from Example 13.13, the following vectors represent values for Parts (a) through (d):

$$T := \begin{pmatrix} 1000 \\ 1100 \\ 1200 \\ 1300 \end{pmatrix} \cdot \text{kelvin}$$

$$\Delta G := \begin{pmatrix} 3130 \\ -150 \\ -3190 \\ -6170 \end{pmatrix} \cdot \frac{\text{J}}{\text{mol}}$$

Combining Eqs. (13.5), (13.11a), and (13.28) gives

$$\frac{\left(\frac{\varepsilon}{2}\right) \cdot \left(\frac{\varepsilon}{2}\right)}{\left(\frac{1-\varepsilon}{2}\right) \cdot \left(\frac{1-\varepsilon}{2}\right)} = \frac{\varepsilon^2}{(1-\varepsilon)^2} = K = \exp\left(\frac{-\Delta G}{R \cdot T}\right)$$

$$\xi := \sqrt{\exp\left(\frac{-\Delta G}{R \cdot T}\right)}$$

$$\varepsilon := \frac{\xi}{1 + \xi}$$

$$\varepsilon = \begin{pmatrix} 0.4531 \\ 0.5021 \\ 0.5399 \\ 0.5709 \end{pmatrix}$$

**Ans.**

**13.11 4HCl(g) + O<sub>2</sub>(g) = 2H<sub>2</sub>O(g) + 2Cl<sub>2</sub>(g)**

$$v = -1 \qquad n_0 = 6$$

$$T := 773.15 \cdot \text{kelvin}$$

$$T_0 := 298.15 \cdot \text{kelvin}$$

$$\Delta H_{298} := -114408 \cdot \frac{\text{J}}{\text{mol}}$$

$$\Delta G_{298} := -75948 \cdot \frac{\text{J}}{\text{mol}}$$

The following vectors represent the species of the reaction in the order in which they appear:

$$v := \begin{pmatrix} -4 \\ -1 \\ 2 \\ 2 \end{pmatrix} \quad A := \begin{pmatrix} 3.156 \\ 3.639 \\ 3.470 \\ 4.442 \end{pmatrix} \quad B := \begin{pmatrix} 0.623 \\ 0.506 \\ 1.450 \\ 0.089 \end{pmatrix} \cdot 10^{-3} \quad D := \begin{pmatrix} 0.151 \\ -0.227 \\ 0.121 \\ -0.344 \end{pmatrix} \cdot 10^5$$

$$\text{end} := \text{rows}(A) \quad i := 1.. \text{end}$$

$$\Delta A := \sum_i (v_i \cdot A_i) \quad \Delta B := \sum_i (v_i \cdot B_i) \quad \Delta D := \sum_i (v_i \cdot D_i)$$

$$\Delta A = -0.439$$

$$\Delta B = 8 \times 10^{-5}$$

$$\Delta C := 0$$

$$\Delta D = -8.23 \times 10^4$$

$$\begin{aligned} \Delta G := & \Delta H_{298} - \frac{T}{T_0} \cdot (\Delta H_{298} - \Delta G_{298}) \dots \\ & + R \cdot \text{IDCPH}(T_0, T, \Delta A, \Delta B, \Delta C, D) \dots \\ & + -R \cdot T \cdot \text{IDCPS}(T_0, T, \Delta A, \Delta B, \Delta C, D) \end{aligned}$$

$$\Delta G = -1.267 \times 10^4 \frac{\text{J}}{\text{mol}}$$

$$K := \exp\left(\frac{-\Delta G}{R \cdot T}\right) \quad K = 7.18041$$

By Eq. (13.5)  $y_{\text{HCl}} = \frac{5 - 4 \cdot \varepsilon}{6 - \varepsilon}$

$$y_{\text{O}_2} = \frac{1 - \varepsilon}{6 - \varepsilon} \quad y_{\text{H}_2\text{O}} = \frac{2 \cdot \varepsilon}{6 - \varepsilon} \quad y_{\text{Cl}_2} = \frac{2 \cdot \varepsilon}{6 - \varepsilon}$$

Apply Eq. (13.28);  $\varepsilon := 0.5$  (guess)

Given  $\left(\frac{2 \cdot \varepsilon}{5 - 4 \cdot \varepsilon}\right)^4 \cdot \left(\frac{6 - \varepsilon}{1 - \varepsilon}\right) = 2 \cdot K$   $\varepsilon := \text{Find}(\varepsilon)$   $\varepsilon = 0.793$

$$y_{\text{HCl}} := \frac{5 - 4 \cdot \varepsilon}{6 - \varepsilon} \quad y_{\text{O}_2} := \frac{1 - \varepsilon}{6 - \varepsilon} \quad y_{\text{H}_2\text{O}} := \frac{2 \cdot \varepsilon}{6 - \varepsilon} \quad y_{\text{Cl}_2} := \frac{2 \cdot \varepsilon}{6 - \varepsilon}$$

$$y_{\text{HCl}} = 0.3508 \quad y_{\text{O}_2} = 0.0397 \quad y_{\text{H}_2\text{O}} = 0.3048 \quad y_{\text{Cl}_2} = 0.3048 \quad \text{Ans.}$$





This is the reaction of Pb. 4.21(x). From the answers for Pbs. 4.21(x), 4.22(x), and 13.7(x), find the following values:

$$\Delta H_{298} := 42720 \cdot \frac{\text{J}}{\text{mol}}$$

$$\Delta G_{298} := 39430 \cdot \frac{\text{J}}{\text{mol}}$$

$$\Delta A := 0.060$$

$$\Delta B := 0.173 \cdot 10^{-3}$$

$$\Delta C := 0$$

$$\Delta D := -0.191 \cdot 10^5$$

$$T := 923.15 \cdot \text{kelvin}$$

$$T_0 := 298.15 \cdot \text{kelvin}$$

$$\begin{aligned} \Delta G := & \Delta H_{298} - \frac{T}{T_0} \cdot (\Delta H_{298} - \Delta G_{298}) \dots \\ & + R \cdot \text{IDCPH}(T_0, T, \Delta A, \Delta B, \Delta C, D) \dots \\ & + -R \cdot T \cdot \text{IDCPS}(T_0, T, \Delta A, \Delta B, \Delta C, D) \end{aligned}$$

$$\Delta G = 3.242 \times 10^4 \frac{\text{J}}{\text{mol}}$$

$$K := \exp\left(\frac{-\Delta G}{R \cdot T}\right)$$

$$K = 0.01464$$

By Eq. (13.5),

$$y_{\text{N}_2} = \frac{1 - \varepsilon}{2}$$

$$y_{\text{C}_2\text{H}_2} = \frac{1 - \varepsilon}{2}$$

$$y_{\text{HCN}} = \frac{2\varepsilon}{2} = \varepsilon$$

By Eq. (13.28),  $\varepsilon := 0.5$  (guess)

$$\text{Given } \left(\frac{2 \cdot \varepsilon}{1 - \varepsilon}\right)^2 = K$$

$$\varepsilon := \text{Find}(\varepsilon)$$

$$\varepsilon = 0.057$$

$$y_{\text{N}_2} := \frac{1 - \varepsilon}{2}$$

$$y_{\text{C}_2\text{H}_2} := \frac{1 - \varepsilon}{2}$$

$$y_{\text{HCN}} := \varepsilon$$

$$y_{\text{N}_2} = 0.4715$$

$$y_{\text{C}_2\text{H}_2} = 0.4715$$

$$y_{\text{HCN}} = 0.057 \text{ Ans.}$$

Given the assumption of ideal gases, P has no effect on the equilibrium composition.



This is the reaction of Pb. 4.21(r). From the answers for Pbs. 4.21(r), 4.22(r), and 13.7(r), find the following values:

$$\Delta H_{298} := -68910 \cdot \frac{\text{J}}{\text{mol}}$$

$$\Delta G_{298} := -39630 \cdot \frac{\text{J}}{\text{mol}}$$

$$\Delta A := -1.424 \quad \Delta B := 1.601 \cdot 10^{-3} \quad \Delta C := 0.156 \cdot 10^{-6} \quad \Delta D := -0.083 \cdot 10^5$$

$$T := 623.15 \cdot \text{kelvin} \quad T_0 := 298.15 \cdot \text{kelvin}$$

$$\begin{aligned} \Delta G := & \Delta H_{298} - \frac{T}{T_0} \cdot (\Delta H_{298} - \Delta G_{298}) \dots \\ & + R \cdot \text{IDCPH}(T_0, T, \Delta A, \Delta B, \Delta C, D) \dots \\ & + -R \cdot T \cdot \text{IDCPS}(T_0, T, \Delta A, \Delta B, \Delta C, D) \end{aligned}$$

$$\Delta G = -6.787 \times 10^3 \frac{\text{J}}{\text{mol}}$$

$$K := \exp\left(\frac{-\Delta G}{R \cdot T}\right)$$

$$K = 3.7064$$

By Eq. (13.5),  $y_{\text{CH}_3\text{CHO}} = \frac{1 - \varepsilon}{2.5 - \varepsilon}$   $y_{\text{H}_2} = \frac{1.5 - \varepsilon}{2.5 - \varepsilon}$   $y_{\text{C}_2\text{H}_5\text{OH}} = \frac{\varepsilon}{2.5 - \varepsilon}$

By Eq. (13.28),  $\varepsilon := 0.5$  (guess)

Given  $\frac{\varepsilon \cdot (2.5 - \varepsilon)}{(1 - \varepsilon) \cdot (1.5 - \varepsilon)} = 3 \cdot K$   $\varepsilon := \text{Find}(\varepsilon)$   $\varepsilon = 0.818$

$$y_{\text{CH}_3\text{CHO}} := \frac{1 - \varepsilon}{2.5 - \varepsilon} \quad y_{\text{H}_2} := \frac{1.5 - \varepsilon}{2.5 - \varepsilon} \quad y_{\text{C}_2\text{H}_5\text{OH}} := \frac{\varepsilon}{2.5 - \varepsilon}$$

$$y_{\text{CH}_3\text{CHO}} = 0.108$$

$$y_{\text{H}_2} = 0.4053$$

$$y_{\text{C}_2\text{H}_5\text{OH}} = 0.4867 \quad \text{Ans.}$$

If the pressure is reduced to 1 bar,

Given  $\frac{\varepsilon \cdot (2.5 - \varepsilon)}{(1 - \varepsilon) \cdot (1.5 - \varepsilon)} = 1 \cdot K$   $\varepsilon := \text{Find}(\varepsilon)$   $\varepsilon = 0.633$

$$y_{\text{CH}_3\text{CHO}} := \frac{1 - \varepsilon}{2.5 - \varepsilon} \quad y_{\text{H}_2} := \frac{1.5 - \varepsilon}{2.5 - \varepsilon} \quad y_{\text{C}_2\text{H}_5\text{OH}} := \frac{\varepsilon}{2.5 - \varepsilon}$$

$$y_{\text{CH}_3\text{CHO}} = 0.1968$$

$$y_{\text{H}_2} = 0.4645$$

$$y_{\text{C}_2\text{H}_5\text{OH}} = 0.3387 \quad \text{Ans.}$$



This is the REVERSE reaction of Pb. 4.21(y). From the answers for Pbs. 4.21(y), 4.22(y), and 13.7(y) WITH OPPOSITE SIGNS, find the following values:

$$\Delta H_{298} := -117440 \cdot \frac{\text{J}}{\text{mol}}$$

$$\Delta G_{298} := -83010 \cdot \frac{\text{J}}{\text{mol}}$$

$$\Delta A := -4.175 \quad \Delta B := 4.766 \cdot 10^{-3} \quad \Delta C := -1.814 \cdot 10^{-6} \quad \Delta D := -0.083 \cdot 10^5$$

$$T := 923.15 \cdot \text{kelvin}$$

$$T_0 := 298.15 \cdot \text{kelvin}$$

$$\begin{aligned} \Delta G := & \Delta H_{298} - \frac{T}{T_0} \cdot (\Delta H_{298} - \Delta G_{298}) \dots \\ & + R \cdot \text{IDCPH}(T_0, T, \Delta A, \Delta B, \Delta C, D) \dots \\ & + -R \cdot T \cdot \text{IDCPS}(T_0, T, \Delta A, \Delta B, \Delta C, D) \end{aligned}$$

$$\Delta G = -2.398 \times 10^3 \frac{\text{J}}{\text{mol}}$$

$$K := \exp\left(\frac{-\Delta G}{R \cdot T}\right)$$

$$K = 1.36672$$

By Eq. (13.5),

$$y_{\text{C}_6\text{H}_5\text{CHCH}_2} = \frac{1 - \varepsilon}{2.5 - \varepsilon}$$

$$y_{\text{H}_2} = \frac{1.5 - \varepsilon}{2.5 - \varepsilon}$$

$$y_{\text{C}_6\text{H}_5\text{C}_2\text{H}_5} = \frac{\varepsilon}{2.5 - \varepsilon}$$

By Eq. (13.28),

$$\varepsilon := 0.5 \quad (\text{guess})$$

$$\text{Given} \quad \frac{\varepsilon \cdot (2.5 - \varepsilon)}{(1 - \varepsilon) \cdot (1.5 - \varepsilon)} = 1.0133 \cdot K \quad \varepsilon := \text{Find}(\varepsilon) \quad \varepsilon = 0.418$$

$$y_{\text{C}_6\text{H}_5\text{CHCH}_2} := \frac{1 - \varepsilon}{2.5 - \varepsilon} \quad y_{\text{H}_2} := \frac{1.5 - \varepsilon}{2.5 - \varepsilon} \quad y_{\text{C}_6\text{H}_5\text{C}_2\text{H}_5} := \frac{\varepsilon}{2.5 - \varepsilon}$$

$$y_{\text{C}_6\text{H}_5\text{CHCH}_2} = 0.2794$$

$$y_{\text{H}_2} = 0.5196$$

$$y_{\text{C}_6\text{H}_5\text{C}_2\text{H}_5} = 0.201 \quad \text{Ans.}$$

**13.15 Basis: 1 mole of gas entering, containing 0.15 mol SO<sub>2</sub>, 0.20 mol O<sub>2</sub>, and 0.65 mol N<sub>2</sub>.**

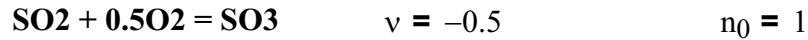

By Eq. (13.5),

$$y_{\text{SO}_2} = \frac{0.15 - \varepsilon}{1 - 0.5 \cdot \varepsilon} \quad y_{\text{O}_2} = \frac{0.20 - 0.5 \cdot \varepsilon}{1 - 0.5 \cdot \varepsilon} \quad y_{\text{SO}_3} = \frac{\varepsilon}{1 - 0.5 \cdot \varepsilon}$$

From data in Table C.4,

$$\Delta H_{298} := -98890 \cdot \frac{\text{J}}{\text{mol}} \quad \Delta G_{298} := -70866 \cdot \frac{\text{J}}{\text{mol}}$$

The following vectors represent the species of the reaction in the order in which they appear:

$$v := \begin{pmatrix} -1 \\ -0.5 \\ 1 \end{pmatrix} \quad A := \begin{pmatrix} 5.699 \\ 3.639 \\ 8.060 \end{pmatrix} \quad B := \begin{pmatrix} 0.801 \\ 0.506 \\ 1.056 \end{pmatrix} \cdot 10^{-3} \quad D := \begin{pmatrix} -1.015 \\ -0.227 \\ -2.028 \end{pmatrix} \cdot 10^5$$

$$\text{end} := \text{rows}(A) \quad i := 1.. \text{end}$$

$$\Delta A := \sum_i (v_i \cdot A_i) \quad \Delta B := \sum_i (v_i \cdot B_i) \quad \Delta D := \sum_i (v_i \cdot D_i)$$

$$\Delta A = 0.5415 \quad \Delta B = 2 \times 10^{-6} \quad \Delta C := 0 \quad \Delta D = -8.995 \times 10^4$$

$$T := 753.15 \cdot \text{kelvin} \quad T_0 := 298.15 \cdot \text{kelvin}$$

$$\begin{aligned} \Delta G := & \Delta H_{298} - \frac{T}{T_0} \cdot (\Delta H_{298} - \Delta G_{298}) \dots \\ & + R \cdot \text{IDCPH}(T_0, T, \Delta A, \Delta B, \Delta C, D) \dots \\ & + -R \cdot T \cdot \text{IDCPS}(T_0, T, \Delta A, \Delta B, \Delta C, D) \end{aligned}$$

$$\Delta G = -2.804 \times 10^4 \frac{\text{J}}{\text{mol}} \quad K := \exp\left(\frac{-\Delta G}{R \cdot T}\right) \quad K = 88.03675$$

By Eq. (13.28),  $\varepsilon := 0.1$  (guess)

$$\text{Given} \quad \frac{\varepsilon \cdot (1 - 0.5 \cdot \varepsilon)^{0.5}}{(0.15 - \varepsilon) \cdot (0.2 - 0.5 \cdot \varepsilon)^{0.5}} = K \quad \varepsilon := \text{Find}(\varepsilon) \quad \varepsilon = 0.1455$$

By Eq. (13.4),  $n_{\text{SO}_3} = \varepsilon = 0.1455$

By Eq. (4.18),  $\Delta H_{753} := \Delta H_{298} + R \cdot \text{IDCPH}(T_0, T, \Delta A, \Delta B, \Delta C, D)$

$\Delta H_{753} = -98353 \frac{\text{J}}{\text{mol}}$        $Q := \varepsilon \Delta H_{753}$        $Q = -14314 \frac{\text{J}}{\text{mol}}$       **Ans.**

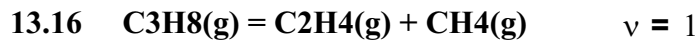

Basis: 1 mole  $\text{C}_3\text{H}_8$  feed. By Eq. (13.4)       $n_{\text{C}_3\text{H}_8} = 1 - \varepsilon$

Fractional conversion of  $\text{C}_3\text{H}_8 = \frac{n_0 - n_{\text{C}_3\text{H}_8}}{n_0} = \frac{1 - (1 - \varepsilon)}{1} = \varepsilon$

By Eq. (13.5),       $y_{\text{C}_3\text{H}_8} = \frac{1 - \varepsilon}{1 + \varepsilon}$        $y_{\text{C}_2\text{H}_4} = \frac{\varepsilon}{1 + \varepsilon}$        $y_{\text{CH}_4} = \frac{\varepsilon}{1 + \varepsilon}$

From data in Table C.4,

$\Delta H_{298} := 82670 \cdot \frac{\text{J}}{\text{mol}}$

$\Delta G_{298} := 42290 \cdot \frac{\text{J}}{\text{mol}}$

The following vectors represent the species of the reaction in the order in which they appear:

$\nu := \begin{pmatrix} -1 \\ 1 \\ 1 \end{pmatrix}$        $A := \begin{pmatrix} 1.213 \\ 1.424 \\ 1.702 \end{pmatrix}$        $B := \begin{pmatrix} 28.785 \\ 14.394 \\ 9.081 \end{pmatrix} \cdot 10^{-3}$        $C := \begin{pmatrix} -8.824 \\ -4.392 \\ -2.164 \end{pmatrix} \cdot 10^{-6}$

$\text{end} := \text{rows}(A)$        $i := 1.. \text{end}$

$\Delta A := \sum_i (\nu_i \cdot A_i)$        $\Delta B := \sum_i (\nu_i \cdot B_i)$        $\Delta C := \sum_i (\nu_i \cdot C_i)$

$\Delta A = 1.913$        $\Delta B = -5.31 \times 10^{-3}$        $\Delta C = 2.268 \times 10^{-6}$        $\Delta D := 0$

(a)  $T := 625 \cdot \text{kelvin}$        $T_0 := 298.15 \cdot \text{kelvin}$

$$\Delta G := \Delta H_{298} - \frac{T}{T_0} \cdot (\Delta H_{298} - \Delta G_{298}) \dots$$

$$+ R \cdot \text{IDCPH}(T_0, T, \Delta A, \Delta B, \Delta C, D) \dots$$

$$+ -R \cdot T \cdot \text{IDCPS}(T_0, T, \Delta A, \Delta B, \Delta C, D)$$

$$\Delta G = -2187.9 \frac{\text{J}}{\text{mol}} \quad K := \exp\left(\frac{-\Delta G}{R \cdot T}\right) \quad K = 1.52356$$

By Eq. (13.28),  $\varepsilon := 0.5$  (guess)

$$\text{Given } \frac{\varepsilon^2}{(1 + \varepsilon) \cdot (1 - \varepsilon)} = K \quad \varepsilon := \text{Find}(\varepsilon)$$

$\varepsilon = 0.777$  This value of epsilon IS the fractional conversion. Ans.

$$\text{(b) } \varepsilon := 0.85 \quad K := \frac{\varepsilon^2}{(1 + \varepsilon) \cdot (1 - \varepsilon)} \quad K = 2.604$$

$$\Delta G := R \cdot T \cdot \ln(K) \quad \Delta G = 4972.3 \frac{\text{J}}{\text{mol}} \quad \text{Ans.}$$

The problem now is to find the T which generates this value.  
It is not difficult to find T by trial. This leads to the value:

$T = 646.8 \text{ K}$  Ans.

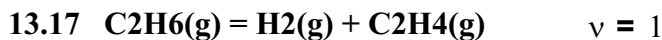

Basis: 1 mole entering  $\text{C}_2\text{H}_6$  + 0.5 mol  $\text{H}_2\text{O}$ .

$n_0 = 1.5$  By Eq. (13.5),

$$y_{\text{C}_2\text{H}_6} = \frac{1 - \varepsilon}{1.5 + \varepsilon} \quad y_{\text{H}_2} = \frac{\varepsilon}{1.5 + \varepsilon} \quad y_{\text{C}_2\text{H}_4} = \frac{\varepsilon}{1.5 + \varepsilon}$$

From data in Table C.4,

$$\Delta H_{298} := 136330 \cdot \frac{\text{J}}{\text{mol}} \quad \Delta G_{298} := 100315 \cdot \frac{\text{J}}{\text{mol}}$$

The following vectors represent the species of the reaction in the order in which they appear:

$$v := \begin{pmatrix} -1 \\ 1 \\ 1 \end{pmatrix}$$

$$A := \begin{pmatrix} 1.131 \\ 3.249 \\ 1.424 \end{pmatrix}$$

$$B := \begin{pmatrix} 19.225 \\ 0.422 \\ 14.394 \end{pmatrix} \cdot 10^{-3}$$

$$C := \begin{pmatrix} -5.561 \\ 0.0 \\ -4.392 \end{pmatrix} \cdot 10^{-6}$$

$$D := \begin{pmatrix} 0.0 \\ 0.083 \\ 0.0 \end{pmatrix} \cdot 10^5$$

end := rows(A)      i := 1..end

$$\Delta A := \sum_i (v_i \cdot A_i) \quad \Delta B := \sum_i (v_i \cdot B_i) \quad \Delta C := \sum_i (v_i \cdot C_i) \quad \Delta D := \sum_i (v_i \cdot D_i)$$

$$\Delta A = 3.542 \quad \Delta B = -4.409 \times 10^{-3} \quad \Delta C = 1.169 \times 10^{-6} \quad \Delta D = 8.3 \times 10^3$$

T := 1100·kelvin      T<sub>0</sub> := 298.15·kelvin

$$\begin{aligned} \Delta G := & \Delta H_{298} - \frac{T}{T_0} \cdot (\Delta H_{298} - \Delta G_{298}) \dots \\ & + R \cdot \text{IDCPH}(T_0, T, \Delta A, \Delta B, \Delta C, D) \dots \\ & + -R \cdot T \cdot \text{IDCPS}(T_0, T, \Delta A, \Delta B, \Delta C, D) \end{aligned}$$

$$\Delta G = -5.429 \times 10^3 \frac{\text{J}}{\text{mol}}$$

$$K := \exp\left(\frac{-\Delta G}{R \cdot T}\right)$$

$$K = 1.81048$$

By Eq. (13.28),       $\varepsilon := 0.5$  (guess)

Given  $\frac{\varepsilon^2}{(1.5 + \varepsilon) \cdot (1 - \varepsilon)} = K$        $\varepsilon := \text{Find}(\varepsilon)$        $\varepsilon = 0.83505$

By Eq. (13.4),       $n_{\text{C}_2\text{H}_6} = 1 - \varepsilon$        $n_{\text{H}_2} = n_{\text{C}_2\text{H}_4} = \varepsilon$        $n = 1 + \varepsilon$

$$y_{\text{C}_2\text{H}_6} := \frac{1 - \varepsilon}{1 + \varepsilon}$$

$$y_{\text{H}_2} := \frac{\varepsilon}{1 + \varepsilon}$$

$$y_{\text{C}_2\text{H}_4} := \frac{\varepsilon}{1 + \varepsilon}$$

$$y_{\text{C}_2\text{H}_6} = 0.0899$$

$$y_{\text{C}_2\text{H}_4} = 0.4551$$

$$y_{\text{H}_2} = 0.4551$$

Ans.

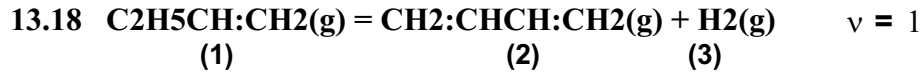

Number the species as shown. Basis is 1 mol species 1 + x mol steam.

$$n_0 = 1 + x$$

By Eq. (13.5),  $y_1 = \frac{1 - \varepsilon}{1 + \varepsilon x + \dots}$   $y_2 = y_3 = \frac{\varepsilon}{1 + \varepsilon x + \dots} = 0.10$

From data in Table C.4,

$$\Delta H_{298} := 109780 \cdot \frac{\text{J}}{\text{mol}}$$

$$\Delta G_{298} := 79455 \cdot \frac{\text{J}}{\text{mol}}$$

The following vectors represent the species of the reaction in the order in which they appear:

$$\mathbf{v} := \begin{pmatrix} -1 \\ 1 \\ 1 \end{pmatrix}$$

$$\mathbf{A} := \begin{pmatrix} 1.967 \\ 2.734 \\ 3.249 \end{pmatrix}$$

$$\mathbf{B} := \begin{pmatrix} 31.630 \\ 26.786 \\ 0.422 \end{pmatrix} \cdot 10^{-3}$$

$$\mathbf{C} := \begin{pmatrix} -9.873 \\ -8.882 \\ 0.0 \end{pmatrix} \cdot 10^{-6}$$

$$\mathbf{D} := \begin{pmatrix} 0.0 \\ 0.0 \\ 0.083 \end{pmatrix} \cdot 10^5$$

$$\text{end} := \text{rows}(\mathbf{A}) \quad i := 1.. \text{end}$$

$$\Delta A := \sum_i (\nu_i \cdot A_i) \quad \Delta B := \sum_i (\nu_i \cdot B_i) \quad \Delta C := \sum_i (\nu_i \cdot C_i) \quad \Delta D := \sum_i (\nu_i \cdot D_i)$$

$$\Delta A = 4.016 \quad \Delta B = -4.422 \times 10^{-3} \quad \Delta C = 9.91 \times 10^{-7} \quad \Delta D = 8.3 \times 10^3$$

$$T := 950 \cdot \text{kelvin}$$

$$T_0 := 298.15 \cdot \text{kelvin}$$

$$\begin{aligned} \Delta G := & \Delta H_{298} - \frac{T}{T_0} \cdot (\Delta H_{298} - \Delta G_{298}) \dots \\ & + R \cdot \text{IDCPH}(T_0, T, \Delta A, \Delta B, \Delta C, D) \dots \\ & + -R \cdot T \cdot \text{IDCPS}(T_0, T, \Delta A, \Delta B, \Delta C, D) \end{aligned}$$



$$\Delta G = 4.896 \times 10^3 \frac{\text{J}}{\text{mol}}$$

$$K := \exp\left(\frac{-\Delta G}{R \cdot T}\right) \quad K = 0.53802$$

By Eq. (13.28),

$$\frac{(0.1) \cdot (0.1) \cdot (1 + \varepsilon x)}{1 - \varepsilon} = K$$

Since  $0.10 \cdot (1 + \varepsilon x) =$   $\varepsilon := \frac{K}{K + 0.10}$   $\varepsilon = 0.843$

$$x := \frac{\varepsilon}{0.10} - \varepsilon = 6.5894$$

(a)  $y_1 := \frac{1 - \varepsilon}{1 + \varepsilon x}$   $y_{\text{H}_2\text{O}} := 1 - 0.2 - y_1$

$y_1 = 0.0186$   $y_{\text{H}_2\text{O}} = 0.7814$  **Ans.**

(b)  $y_{\text{steam}} := \frac{6.5894}{7.5894}$   $y_{\text{steam}} = 0.8682$  **Ans.**



Number the species as shown. Basis is 1 mol species 1 + x mol steam entering.  $n_0 = 1 + x$

By Eq. (13.5),  $y_1 = \frac{1 - \varepsilon}{1 + x + 2 \cdot \varepsilon}$   $y_2 = \frac{\varepsilon}{1 + x + 2 \cdot \varepsilon} = 0.12$

$$y_3 = 2 \cdot y_2 = 0.24$$

From data in Table C.4,

$$\Delta H_{298} := 235030 \cdot \frac{\text{J}}{\text{mol}}$$

$$\Delta G_{298} := 166365 \cdot \frac{\text{J}}{\text{mol}}$$

The following vectors represent the species of the reaction in the order in which they appear:

$$\mathbf{v} := \begin{pmatrix} -1 \\ 1 \\ 2 \end{pmatrix}$$

$$\mathbf{A} := \begin{pmatrix} 1.935 \\ 2.734 \\ 3.249 \end{pmatrix}$$

$$\mathbf{B} := \begin{pmatrix} 36.915 \\ 26.786 \\ 0.422 \end{pmatrix} \cdot 10^{-3}$$

$$C := \begin{pmatrix} -11.402 \\ -8.882 \\ 0.0 \end{pmatrix} \cdot 10^{-6}$$

$$D := \begin{pmatrix} 0.0 \\ 0.0 \\ 0.083 \end{pmatrix} \cdot 10^5$$

$$\text{end} := \text{rows}(A) \quad i := 1.. \text{end}$$

$$\Delta A := \sum_i (v_i \cdot A_i) \quad \Delta B := \sum_i (v_i \cdot B_i) \quad \Delta C := \sum_i (v_i \cdot C_i) \quad \Delta D := \sum_i (v_i \cdot D_i)$$

$$\Delta A = 7.297 \quad \Delta B = -9.285 \times 10^{-3} \quad \Delta C = 2.52 \times 10^{-6} \quad \Delta D = 1.66 \times 10^4$$

$$T := 925 \cdot \text{kelvin}$$

$$T_0 := 298.15 \cdot \text{kelvin}$$

$$\begin{aligned} \Delta G := & \Delta H_{298} - \frac{T}{T_0} \cdot (\Delta H_{298} - \Delta G_{298}) \dots \\ & + R \cdot \text{IDCPH}(T_0, T, \Delta A, \Delta B, \Delta C, D) \dots \\ & + -R \cdot T \cdot \text{IDCPS}(T_0, T, \Delta A, \Delta B, \Delta C, D) \end{aligned}$$

$$\Delta G = 9.242 \times 10^3 \frac{\text{J}}{\text{mol}}$$

$$K := \exp\left(\frac{-\Delta G}{R \cdot T}\right)$$

$$K = 0.30066$$

By Eq. (13.28),

$$\frac{(0.12) \cdot (0.24)^2 \cdot (1 + x + 2 \cdot \varepsilon)}{1 - \varepsilon} = K$$

Because

$$0.12 \cdot (1 + x + 2 \cdot \varepsilon) = \varepsilon \cdot \frac{K}{K + (0.24)^2}$$

$$x := \frac{\varepsilon}{0.12} - 1 - 2 \cdot \varepsilon$$

$$x = 4.3151$$

$$\varepsilon = 0.839$$

(a)  $y_1 := \frac{1 - \varepsilon}{1 + x + 2 \cdot \varepsilon}$

$$y_{\text{H}_2\text{O}} := 1 - 0.36 - y_1$$

$$y_1 = 0.023$$

$$y_{\text{H}_2\text{O}} = 0.617 \quad \text{Ans.}$$

(b)  $y_{\text{steam}} := \frac{4.3151}{5.3151}$

$$y_{\text{steam}} = 0.812 \quad \text{Ans.}$$

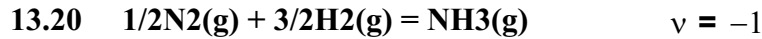

Basis: 1/2 mol N<sub>2</sub>, 3/2 mol H<sub>2</sub> feed  $n_0 = 2$

This is the reaction of Pb. 4.21(a) with all stoichiometric coefficients divided by two. From the answers to Pbs. 4.21(a), 4.22(a), and 13.7(a) ALL DIVIDED BY 2, find the following values:

$$\Delta H_{298} := -46110 \cdot \frac{\text{J}}{\text{mol}}$$

$$\Delta G_{298} := -16450 \cdot \frac{\text{J}}{\text{mol}}$$

$$\Delta A := -2.9355$$

$$\Delta B := 2.0905 \cdot 10^{-3}$$

$$\Delta C := 0$$

$$\Delta D := -0.3305 \cdot 10^{-5}$$

(a)  $T := 300 \cdot \text{kelvin}$

$$T_0 := 298.15 \cdot \text{kelvin}$$

$$\begin{aligned} \Delta G := & \Delta H_{298} - \frac{T}{T_0} \cdot (\Delta H_{298} - \Delta G_{298}) \dots \\ & + R \cdot \text{IDCPH}(T_0, T, \Delta A, \Delta B, \Delta C, D) \dots \\ & + -R \cdot T \cdot \text{IDCPS}(T_0, T, \Delta A, \Delta B, \Delta C, D) \end{aligned}$$

$$\Delta G = -1.627 \times 10^4 \frac{\text{J}}{\text{mol}}$$

$$K := \exp\left(\frac{-\Delta G}{R \cdot T}\right)$$

$$K = 679.57$$

$$P := 1$$

$$P_0 := 1$$

From Pb. 13.9 for ideal gases:

$$\varepsilon := 1 - \left(1 + 1.299 \cdot K \cdot \frac{P}{P_0}\right)^{-0.5} \quad \varepsilon = 0.9664$$

$$y_{\text{NH}_3} := \frac{\varepsilon}{2 - \varepsilon}$$

$$y_{\text{NH}_3} = 0.9349 \quad \text{Ans.}$$

(b) For  $y_{\text{NH}_3} = 0.5$  by the preceding equation

$$\varepsilon := \frac{2}{3}$$

Solving the next-to-last equation for K with  $P = P_0$  gives:

$$K := \frac{\left(\frac{1}{1 - \varepsilon}\right)^2 - 1}{1.299}$$

$$K = 6.1586$$

Find by trial the value of T for which this is correct. It turns out to be

$$T = 399.5 \cdot \text{kelvin} \quad \text{Ans.}$$

(c) For  $P = 100$ , the preceding equation becomes

$$K := \frac{\left(\frac{1}{1-\varepsilon}\right)^2 - 1}{129.9} \quad K = 0.06159$$

Another solution by trial for T yields  $T = 577.6 \cdot \text{kelvin}$  Ans.

(d) Eq. (13.27) applies, and requires fugacity coefficients, which can be evaluated by the generalized second-virial correlation. Since iteration will be necessary, we assume a starting T of 583 K for which:

$$T := 583 \text{kelvin} \quad P := 100 \text{bar}$$

$$\text{For NH}_3(1): \quad T_{c1} := 405.7 \text{kelvin} \quad P_{c1} := 112.8 \text{bar} \quad \omega_1 := 0.253$$

$$T_{r1} := \frac{T}{T_{c1}} \quad T_{r1} = 1.437 \quad P_{r1} := \frac{P}{P_{c1}} \quad P_{r1} = 0.887$$

$$\text{For N}_2(2): \quad T_{c2} := 126.2 \text{kelvin} \quad P_{c2} := 34.0 \text{bar} \quad \omega_2 := 0.038$$

$$T_{r2} := \frac{583}{126.2} \quad T_{r2} = 4.62 \quad P_{r2} := \frac{100}{34.0} \quad P_{r2} = 2.941$$

For H<sub>2</sub>(3), estimate critical constants using Eqns. (3.58) and (3.59)

$$T_{c3} := \left( \frac{43.6}{1 + \frac{21.8}{2.016 \frac{T}{\text{kelvin}}}} \right) \text{kelvin} \quad T_{c3} = 42.806 \text{K}$$

$$T_{r3} := \frac{T}{T_{c3}} \quad T_{r3} = 13.62$$

$$P_{c3} := \frac{20.5}{1 + \frac{44.2}{2.016 \frac{T}{\text{kelvin}}}} \cdot \text{bar} \quad P_{c3} = 19.757 \text{bar}$$

$$P_{r3} := \frac{P}{P_{c3}} \quad P_{r3} = 5.061$$

$$\omega_3 := 0$$

Therefore,  $i := 1..3$

$$\phi := \begin{pmatrix} \text{PHIB}(\Gamma_{r1}, \mathcal{B}_{r1}, 1) \\ \text{PHIB}(\Gamma_{r2}, \mathcal{B}_{r2}, 2) \\ \text{PHIB}(\Gamma_{r3}, \mathcal{B}_{r3}, 3) \end{pmatrix}$$

$$\phi = \begin{pmatrix} 0.924 \\ 1.034 \\ 1.029 \end{pmatrix}$$

$$v := \begin{pmatrix} 1 \\ -0.5 \\ -1.5 \end{pmatrix}$$

$$\prod_i \phi_i^{v_i} = 1.184$$

The expression used for K in Part (c) now becomes:

$$K := \frac{\left(\frac{1}{1-\varepsilon}\right)^2 - 1}{\left(\frac{129.9}{1.184}\right)}$$

$$K = 0.07292$$

Another solution by trial for T yields  $T = 568.6 \cdot \text{K}$  Ans.

Of course, the INITIAL assumption made for T was not so close to the final T as is shown here, and several trials were in fact made, but not shown here. The trials are made by simply changing numbers in the given expressions, without reproducing them.



$$v = -2$$

Basis: 1 mol CO, 2 mol H<sub>2</sub> feed

$$n_0 = 3$$

From the data of Table C.4,

$$\Delta H_{298} := -90135 \cdot \frac{\text{J}}{\text{mol}}$$

$$\Delta G_{298} := -24791 \cdot \frac{\text{J}}{\text{mol}}$$

This is the reaction of Ex. 4.6, Pg. 142 from which:

$$\Delta A := -7.663 \quad \Delta B := 10.815 \cdot 10^{-3} \quad \Delta C := -3.45 \cdot 10^{-6} \quad \Delta D := -0.135 \cdot 10^5$$

(a)  $T := 300 \cdot \text{kelvin}$

$$T_0 := 298.15 \cdot \text{kelvin}$$

$$\Delta G := \Delta H_{298} - \frac{T}{T_0} \cdot (\Delta H_{298} - \Delta G_{298}) \dots$$

$$+ R \cdot \text{IDCPH}(T_0, T, \Delta A, \Delta B, \Delta C, D) \dots$$

$$+ -R \cdot T \cdot \text{IDCPS}(T_0, T, \Delta A, \Delta B, \Delta C, D)$$

$$\Delta G = -2.439 \times 10^4 \frac{\text{J}}{\text{mol}}$$

$$K := \exp\left(\frac{-\Delta G}{R \cdot T}\right)$$

$$K = 1.762 \times 10^4$$

$$P := 1$$

$$P_0 := 1$$

By Eq. (13.5), with the species numbered in the order in which they appear in the reaction,

$$y_1 = \frac{1 - \varepsilon}{3 - 2 \cdot \varepsilon} \quad y_2 = \frac{2 - 2 \cdot \varepsilon}{3 - 2 \cdot \varepsilon} \quad y_3 = \frac{\varepsilon}{3 - 2 \cdot \varepsilon}$$

By Eq. (13.28),  $\varepsilon := 0.8$  (guess)

$$\text{Given} \quad \frac{\varepsilon \cdot (3 - 2 \cdot \varepsilon)^2}{4 \cdot (1 - \varepsilon)^3} = \left(\frac{P}{P_0}\right)^2 \cdot K \quad \varepsilon := \text{Find}(\varepsilon)$$

$$\varepsilon = 0.9752$$

$$y_3 := \frac{\varepsilon}{3 - 2 \cdot \varepsilon}$$

$$y_3 = 0.9291 \text{ Ans.}$$

(b)  $y_3 := 0.5$

By the preceding equation

$$\varepsilon := \frac{3 \cdot y_3}{2 \cdot y_3 + 1}$$

$$\varepsilon = 0.75$$

Solution of the equilibrium equation for K gives

$$K := \frac{\varepsilon \cdot (3 - 2 \cdot \varepsilon)^2}{4 \cdot (1 - \varepsilon)^3}$$

$$K = 27$$

Find by trial the value of T for which this is correct. It turns out to be:

$$T = 364.47 \cdot \text{kelvin} \text{ Ans.}$$

(c) For  $P = 100$  bar, the preceding equation becomes

$$K := \frac{\varepsilon \cdot (\beta - 2 \cdot \varepsilon)^2}{4 \cdot (1 - \varepsilon)^3} \cdot 100^{-2} \quad K = 2.7 \times 10^{-3}$$

Another solution by trial for  $T$  yields  $T = 516.48$  kelvin Ans.

(d) Eq. (13.27) applies, and requires fugacity coefficients. Since iteration will be necessary, assume a starting  $T$  of 528 K, for which:

$$T := 528 \text{ kelvin} \quad P := 100 \text{ bar}$$

$$\text{For CO(1): } T_{c1} := 132.9 \text{ kelvin} \quad P_{c1} := 34.99 \text{ bar} \quad \omega_1 := 0.048$$

$$T_{r1} := \frac{T}{T_{c1}} \quad T_{r1} = 3.973 \quad P_{r1} := \frac{P}{P_{c1}} \quad P_{r1} = 2.858$$

$$\text{For CH}_3\text{OH(3): } T_{c3} := 512.6 \text{ kelvin} \quad P_{c3} := 80.97 \text{ bar} \quad \omega_3 := 0.564$$

$$T_r := \frac{T}{T_{c3}} \quad T_r = 1.03 \quad P_r := \frac{P}{P_{c3}} \quad P_r = 1.235$$

By Eq. (11.67) and data from Tables E.15 & E.16.

$$\phi_3 := 0.6206 \cdot 0.9763^{\omega_3} \quad \phi_3 = 0.612$$

For  $\text{H}_2(2)$ , the reduced temperature is so large that it may be assumed ideal:  $\phi = 1$ .

Therefore:  $i := 1..3$

$$\phi := \begin{pmatrix} \text{PHIB}(T_{r1}, P_{r1}, 1) \\ 1.0 \\ 0.612 \end{pmatrix} \quad \phi = \begin{pmatrix} 1.032 \\ 1 \\ 0.612 \end{pmatrix}$$

$$v := \begin{pmatrix} -1 \\ -2 \\ 1 \end{pmatrix} \quad \prod_i \phi_i^{v_i} = 0.5933$$

The expression used for K in Part (c) now becomes:

$$K := \frac{\varepsilon \cdot (3 - 2 \cdot \varepsilon)^2}{4 \cdot (1 - \varepsilon)^3} \cdot 100^{-2} \cdot 0.593 \quad K = 1.6011 \times 10^{-3}$$

Another solution by trial for T yields:  $T = 528.7 \cdot \text{kelvin}$  Ans.

### 13.22 $\text{CaCO}_3(\text{s}) = \text{CaO}(\text{s}) + \text{CO}_2(\text{g})$

Each species exists PURE as an individual phase, for which the activity is  $f/f_0$ . For the two species existing as solid phases,  $f$  and  $f_0$  are for practical purposes the same, and the activity is unity. If the pure  $\text{CO}_2$  is assumed an ideal gas at 1(atm), then for  $\text{CO}_2$  the activity is  $f/f_0 = P/P_0 = P$  (in bar). As a result, Eq. (13.10) becomes  $K = P = 1.0133$ , and we must find the T for which K has this value.

From the data of Table C.4,

$$\Delta H_{298} := 178321 \cdot \frac{\text{J}}{\text{mol}}$$

$$\Delta G_{298} := 130401 \cdot \frac{\text{J}}{\text{mol}}$$

The following vectors represent the species of the reaction in the order in which they appear:

$$v := \begin{pmatrix} -1 \\ 1 \\ 1 \end{pmatrix}$$

$$A := \begin{pmatrix} 12.572 \\ 6.104 \\ 5.457 \end{pmatrix}$$

$$B := \begin{pmatrix} 2.637 \\ 0.443 \cdot 10^{-3} \\ 1.045 \end{pmatrix}$$

$$D := \begin{pmatrix} -3.120 \\ -1.047 \cdot 10^5 \\ -1.157 \end{pmatrix}$$

$$i := 1..3 \quad \Delta A := \sum_i (v_i \cdot A_i) \quad \Delta B := \sum_i (v_i \cdot B_i) \quad \Delta D := \sum_i (v_i \cdot D_i)$$

$$\Delta A = -1.011 \quad \Delta B = -1.149 \times 10^{-3} \quad \Delta C := 0 \quad \Delta D = 9.16 \times 10^4$$

$$T := 1151.83 \cdot \text{kelvin}$$

$$T_0 := 298.15 \cdot \text{kelvin}$$

$$\begin{aligned} \Delta G := & \Delta H_{298} - \frac{T}{T_0} \cdot (\Delta H_{298} - \Delta G_{298}) \dots \\ & + R \cdot \text{IDCPH}(T_0, T, \Delta A, \Delta B, \Delta C, D) \dots \\ & + -R \cdot T \cdot \text{IDCPS}(T_0, T, \Delta A, \Delta B, \Delta C, D) \end{aligned}$$



$$\Delta G = -126.324 \frac{\text{J}}{\text{mol}}$$

$$K := \exp\left(\frac{-\Delta G}{R \cdot T}\right)$$

$$K = 1.0133$$

Thus  $T = 1151.83 \cdot \text{kelvin}$  Ans.

Although a number of trials were required to reach this result, only the final trial is shown. A handbook value for this temperature is 1171 K.

### 13.23 $\text{NH}_4\text{Cl}(\text{s}) = \text{NH}_3(\text{g}) + \text{HCl}(\text{g})$

The  $\text{NH}_4\text{Cl}$  exists PURE as a solid phase, for which the activity is  $f/f_0$ . Since  $f$  and  $f_0$  are for practical purposes the same, the activity is unity. If the equimolar mixture of  $\text{NH}_3$  and  $\text{HCl}$  is assumed an ideal gas mixture at 1.5 bar, then with  $f_0 = 1$  bar the activity of each gas species is its partial pressure,  $(0.5)(1.5) = 0.75$ . As a result, Eq. (13.10) becomes  $K = (0.75)(0.75) = 0.5625$ , and we must find the  $T$  for which  $K$  has this value.

From the given data and the data of Table C.4,

$$\Delta H_{298} := 176013 \cdot \frac{\text{J}}{\text{mol}}$$

$$\Delta G_{298} := 91121 \cdot \frac{\text{J}}{\text{mol}}$$

The following vectors represent the species of the reaction in the order in which they appear:

$$v := \begin{pmatrix} -1 \\ 1 \\ 1 \end{pmatrix}$$

$$A := \begin{pmatrix} 5.939 \\ 3.578 \\ 3.156 \end{pmatrix}$$

$$B := \begin{pmatrix} 16.105 \\ 3.020 \cdot 10^{-3} \\ 0.623 \end{pmatrix}$$

$$D := \begin{pmatrix} 0.0 \\ -0.186 \cdot 10^5 \\ 0.151 \end{pmatrix}$$

$$i := 1..3$$

$$\Delta A := \sum_i (v_i \cdot A_i) \quad \Delta B := \sum_i (v_i \cdot B_i) \quad \Delta D := \sum_i (v_i \cdot D_i)$$

$$\Delta A = 0.795$$

$$\Delta B = -0.012462$$

$$\Delta C := 0$$

$$\Delta D = -3.5 \times 10^3$$

$$T := 623.97 \cdot \text{kelvin}$$

$$T_0 := 298.15 \cdot \text{kelvin}$$

$$\begin{aligned} \Delta G := & \Delta H_{298} - \frac{T}{T_0} \cdot (\Delta H_{298} - \Delta G_{298}) \dots \\ & + R \cdot \text{IDCPH}(T_0, T, \Delta A, \Delta B, \Delta C, D) \dots \\ & + -R \cdot T \cdot \text{IDCPS}(T_0, T, \Delta A, \Delta B, \Delta C, D) \end{aligned}$$

$$\Delta G = 2.986 \times 10^3 \frac{\text{J}}{\text{mol}}$$

$$K := \exp\left(\frac{-\Delta G}{R \cdot T}\right)$$

$$K = 0.5624$$

Thus  $T = 623.97 \cdot \text{K}$  Ans.

Although a number of trials were required to reach this result, only the final trial is shown.



$$\frac{y_{\text{NO}_2}}{y_{\text{NO}} \cdot (y_{\text{O}_2})^{0.5}} = \frac{y_{\text{NO}_2}}{y_{\text{NO}} \cdot (0.21)^{0.5}} = K$$

$$T := 298.15 \cdot \text{kelvin}$$

From the data of Table C.4,

$$\Delta G_{298} := -35240 \cdot \frac{\text{J}}{\text{mol}}$$

$$K := \exp\left(\frac{-\Delta G_{298}}{R \cdot T}\right)$$

$$K = 1.493 \times 10^6$$

$$y_{\text{NO}} := 10^{-12} \quad y_{\text{NO}_2} := 10^{-6} \quad (\text{guesses})$$

$$\text{Given } y_{\text{NO}_2} = (0.21)^{0.5} \cdot K \cdot y_{\text{NO}} \quad y_{\text{NO}_2} + y_{\text{NO}} = 5 \cdot 10^{-6}$$

$$\begin{pmatrix} y_{\text{NO}} \\ y_{\text{NO}_2} \end{pmatrix} := \text{Find}(y_{\text{NO}}, y_{\text{NO}_2})$$

$$y_{\text{NO}} = 7.307 \times 10^{-12}$$

This is about  $7 \cdot 10^{-6}$  ppm (a negligible concentration) Ans.

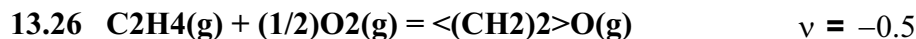

See Example 13.9, Pg. 508-510 From Table C.4,

$$\Delta H_{298} := -105140 \cdot \frac{\text{J}}{\text{mol}}$$

$$\Delta G_{298} := -81470 \cdot \frac{\text{J}}{\text{mol}}$$

Basis: 1 mol  $\text{C}_2\text{H}_4$  entering reactor.

Moles  $\text{O}_2$  entering:

$$n_{\text{O}_2} := 1.25 \cdot 0.5$$

Moles  $\text{N}_2$  entering:

$$n_{\text{N}_2} := n_{\text{O}_2} \cdot \frac{79}{21}$$

$$n_0 := 1 + n_{O_2} + n_{N_2}$$

$$n_0 = 3.976$$

Index the product species with the numbers:

1 = ethylene

2 = oxygen

3 = ethylene oxide

4 = nitrogen

The numbers of moles in the product stream are given by Eq. (13.5).

For the product stream, data from Table C.1:

Guess:  $\varepsilon := 0.8$

$$n(\varepsilon) := \begin{pmatrix} 1 - \varepsilon \\ n_{O_2} - 0.5 \cdot \varepsilon \\ \varepsilon \\ n_{N_2} \end{pmatrix}$$

$$A := \begin{pmatrix} 1.424 \\ 3.639 \\ -0.385 \\ 3.280 \end{pmatrix}$$

$$B := \begin{pmatrix} 14.394 \\ 0.506 \\ 23.463 \\ 0.593 \end{pmatrix} \cdot \frac{10^{-3}}{\text{kelvin}}$$

$$C := \begin{pmatrix} -4.392 \\ 0.0 \\ -9.296 \\ 0.0 \end{pmatrix} \cdot \frac{10^{-6}}{\text{kelvin}^2}$$

$$D := \begin{pmatrix} 0.0 \\ -0.227 \\ 0.0 \\ 0.040 \end{pmatrix} \cdot 10^5 \cdot \text{kelvin}^2$$

$$v := \begin{pmatrix} -1 \\ -0.5 \\ 1 \\ 0 \end{pmatrix}$$

$$i := 1..4 \quad A(\varepsilon) := \sum_i (n(\varepsilon)_i \cdot A_i) \quad B(\varepsilon) := \sum_i (n(\varepsilon)_i \cdot B_i)$$

$$C(\varepsilon) := \sum_i (n(\varepsilon)_i \cdot C_i) \quad D(\varepsilon) := \sum_i (n(\varepsilon)_i \cdot D_i)$$

$$y(\varepsilon) := \frac{n(\varepsilon)}{n_0 - 0.5 \cdot \varepsilon} \quad K(\varepsilon) := \prod_i (y(\varepsilon)_i)^{v_i} \quad K(\varepsilon) = 15.947$$

The energy balance for the adiabatic reactor is:

$$\Delta H_{298} + \Delta H_P = 0 \quad \text{For the second term, we combine Eqs. (4.3) \& (4.7).}$$

The three equations together provide the energy balance.

For the equilibrium state, apply a combination of Eqs. (13.11a) & (13.18). The reaction considered here is that of Pb. 4.21(g), for which the following values are given in Pb. 4.23(g):

$$\Delta A := -3.629 \quad \Delta B := 8.816 \cdot \frac{10^{-3}}{\text{kelvin}} \quad \Delta C := -4.904 \cdot \frac{10^{-6}}{\text{kelvin}^2}$$

$$\Delta D := 0.114 \cdot 10^5 \cdot \text{kelvin}^2 \quad T_0 := 298.15 \cdot \text{kelvin}$$

Guess:  $\tau := 3$

$$\text{idcph} := \left[ \begin{array}{l} \Delta A \cdot T_0 \cdot () - 1 + \frac{\Delta B}{2} \cdot T_0^2 \cdot ()^2 - 1 \dots \\ + \frac{\Delta C}{3} \cdot T_0^3 \cdot ()^3 - 1 + \frac{\Delta D}{T_0} \cdot \left( \frac{\tau - 1}{\tau} \right) \end{array} \right]$$

$$\text{idcps} := \Delta A \cdot \ln() + \left[ B \cdot T_0 + \left[ \begin{array}{l} C \cdot T_0^2 \dots \\ + \frac{\Delta D}{() \cdot T_0^2} \end{array} \right] \cdot \left( \frac{\tau + 1}{2} \right) \right] \cdot () - 1$$

$$\text{idcph} = -130.182 \text{ kelvin}$$

$$\text{idcps} = -0.417$$

Given

$$-\Delta H_{298} = R \cdot \left[ \begin{array}{l} A \cdot () \cdot T_0 \cdot () - 1 + \frac{B \cdot ()}{2} \cdot T_0^2 \cdot ()^2 - 1 \dots \\ + \frac{C \cdot ()}{3} \cdot T_0^3 \cdot ()^3 - 1 + \frac{D \cdot ()}{T_0} \cdot \left( \frac{\tau - 1}{\tau} \right) \end{array} \right]$$

$$K \cdot () = \exp \left[ \left( \frac{\Delta H_{298} - \Delta G_{298}}{R \cdot T_0} - \frac{\Delta H_{298}}{R \cdot T_0 \cdot ()} \right) + \text{idcps} - \frac{1}{T_0 \cdot \tau} \cdot \text{idcph} \right]$$

$$\begin{pmatrix} \varepsilon \\ \tau \end{pmatrix} := \text{Find} \cdot () \tau$$

$$\begin{pmatrix} \varepsilon \\ \tau \end{pmatrix} = \begin{pmatrix} 0.88244 \\ 3.18374 \end{pmatrix}$$

$$y(0.88244) = \begin{pmatrix} 0.0333 \\ 0.052 \\ 0.2496 \\ 0.6651 \end{pmatrix} \quad \text{Ans.}$$

$$T := \tau \cdot T_0 \quad T = 949.23 \text{ kelvin} \quad \text{Ans.}$$

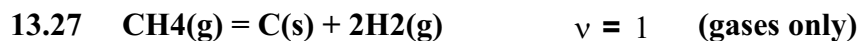

The carbon exists PURE as an individual phase, for which the activity is unity. Thus we leave it out of consideration.

From the data of Table C.4,

$$\Delta H_{298} := 74520 \cdot \frac{\text{J}}{\text{mol}}$$

$$\Delta G_{298} := 50460 \cdot \frac{\text{J}}{\text{mol}}$$

The following vectors represent the species of the reaction in the order in which they appear:

$$\nu := \begin{pmatrix} -1 \\ 1 \\ 2 \end{pmatrix}$$

$$A := \begin{pmatrix} 1.702 \\ 1.771 \\ 3.249 \end{pmatrix}$$

$$B := \begin{pmatrix} 9.081 \\ 0.771 \\ 0.422 \end{pmatrix} \cdot 10^{-3}$$

$$i := 1..3$$

$$C := \begin{pmatrix} -2.164 \\ 0.0 \\ -0.0 \end{pmatrix} \cdot 10^{-6}$$

$$D := \begin{pmatrix} 0.0 \\ -0.867 \\ 0.083 \end{pmatrix} \cdot 10^5$$

$$\Delta A := \sum_i (\nu_i \cdot A_i) \quad \Delta B := \sum_i (\nu_i \cdot B_i) \quad \Delta C := \sum_i (\nu_i \cdot C_i) \quad \Delta D := \sum_i (\nu_i \cdot D_i)$$

$$\Delta A = 6.567 \quad \Delta B = -7.466 \times 10^{-3} \quad \Delta C = 2.164 \times 10^{-6} \quad \Delta D = -7.01 \times 10^4$$

$$T := 923.15 \cdot \text{kelvin}$$

$$T_0 := 298.15 \cdot \text{kelvin}$$

$$\Delta G := \Delta H_{298} - \frac{T}{T_0} \cdot (\Delta H_{298} - \Delta G_{298}) \dots$$

$$+ R \cdot \text{IDCPH}(T_0, T, \Delta A, \Delta B, \Delta C, D) \dots$$

$$+ -R \cdot T \cdot \text{IDCPS}(T_0, T, \Delta A, \Delta B, \Delta C, D)$$

$$\Delta G = -1.109 \times 10^4 \frac{\text{J}}{\text{mol}} \quad K := \exp\left(\frac{-\Delta G}{R \cdot T}\right) \quad K = 4.2392$$

By Eq. (13.5),  $n_0 = 1$   $y_{\text{CH}_4} = \frac{1 - \varepsilon}{1 + \varepsilon}$   $y_{\text{H}_2} = \frac{2 \cdot \varepsilon}{1 + \varepsilon}$

(a) By Eq. (13.28),  $\frac{(2 \cdot \varepsilon)^2}{(1 + \varepsilon) \cdot (1 - \varepsilon)} = \frac{4 \cdot \varepsilon^2}{1 - \varepsilon^2} = K$

$$\varepsilon := \sqrt{\frac{K}{4 + K}} \quad \varepsilon = 0.7173 \quad (\text{fraction decomposed})$$

$$y_{\text{CH}_4} := \frac{1 - \varepsilon}{1 + \varepsilon} \quad y_{\text{H}_2} := \frac{2 \cdot \varepsilon}{1 + \varepsilon} \quad y_{\text{CH}_4} = 0.1646$$

$$y_{\text{H}_2} = 0.8354 \quad \text{Ans.}$$

(b) For a feed of 1 mol CH<sub>4</sub> and 1 mol N<sub>2</sub>,  $n_0 = 2$

By Eq. (13.28),  $\varepsilon := .8$  (guess)

Given  $\frac{(2 \cdot \varepsilon)^2}{(2 + \varepsilon) \cdot (1 - \varepsilon)} = K$   $\varepsilon := \text{Find}(\varepsilon)$

$$\varepsilon = 0.7893 \quad (\text{fraction decomposed})$$

$$y_{\text{CH}_4} := \frac{1 - \varepsilon}{2 + \varepsilon} \quad y_{\text{H}_2} := \frac{2 \cdot \varepsilon}{2 + \varepsilon} \quad y_{\text{N}_2} := 1 - y_{\text{CH}_4} - y_{\text{H}_2}$$

$$y_{\text{H}_2} = 0.5659 \quad y_{\text{CH}_4} = 0.0756 \quad y_{\text{N}_2} = 0.3585 \quad \text{Ans.}$$



This is the reaction of Pb. 4.21(n) with all stoichiometric coefficients divided by two. From the answers to Pbs. 4.21(n), 4.22(n), and 13.7(n) ALL DIVIDED BY 2, find the following values:

$$\Delta H_{298} := 90250 \cdot \frac{\text{J}}{\text{mol}}$$

$$\Delta G_{298} := 86550 \cdot \frac{\text{J}}{\text{mol}}$$

$$\Delta A := -0.0725$$

$$\Delta B := 0.0795 \cdot 10^{-3}$$

$$\Delta C := 0$$

$$\Delta D := 0.1075 \cdot 10^{-5}$$

$$T := 2000 \cdot \text{kelvin}$$

$$T_0 := 298.15 \cdot \text{kelvin}$$

$$\begin{aligned} \Delta G := & \Delta H_{298} - \frac{T}{T_0} \cdot (\Delta H_{298} - \Delta G_{298}) \dots \\ & + R \cdot \text{IDCPH}(T_0, T, \Delta A, \Delta B, \Delta C, D) \dots \\ & + -R \cdot T \cdot \text{IDCPS}(T_0, T, \Delta A, \Delta B, \Delta C, D) \end{aligned}$$

$$\Delta G = 6.501 \times 10^4 \frac{\text{J}}{\text{mol}}$$

$$K_1 := \exp\left(\frac{-\Delta G}{R \cdot T}\right)$$

$$K_1 = 0.02004$$



From the data of Table C.4,

$$\Delta H_{298} := 33180 \cdot \frac{\text{J}}{\text{mol}}$$

$$\Delta G_{298} := 51310 \cdot \frac{\text{J}}{\text{mol}}$$

The following vectors represent the species of the reaction in the order in which they appear:

$$\nu := \begin{pmatrix} -0.5 \\ -1 \\ 1 \end{pmatrix}$$

$$A := \begin{pmatrix} 3.280 \\ 3.639 \\ 4.982 \end{pmatrix}$$

$$B := \begin{pmatrix} 0.593 \\ 0.506 \cdot 10^{-3} \\ 1.195 \end{pmatrix}$$

$$D := \begin{pmatrix} 0.040 \\ -0.227 \cdot 10^5 \\ -0.792 \end{pmatrix}$$

$$i := 1..3 \quad \Delta A := \sum_i (\nu_i \cdot A_i) \quad \Delta B := \sum_i (\nu_i \cdot B_i) \quad \Delta D := \sum_i (\nu_i \cdot D_i)$$

$$\Delta A = -0.297$$

$$\Delta B = 3.925 \times 10^{-4}$$

$$\Delta C := 0$$

$$\Delta D = -5.85 \times 10^4$$

$$T := 2000 \cdot \text{kelvin}$$

$$T_0 := 298.15 \cdot \text{kelvin}$$

$$\Delta G := \Delta H_{298} - \frac{T}{T_0} \cdot (\Delta H_{298} - \Delta G_{298}) \dots$$

$$+ R \cdot \text{IDCPH}(T_0, T, \Delta A, \Delta B, \Delta C, D) \dots$$

$$+ -R \cdot T \cdot \text{IDCPS}(T_0, T, \Delta A, \Delta B, \Delta C, D)$$

$$\Delta G = 1.592 \times 10^5 \frac{\text{J}}{\text{mol}} \quad K_2 := \exp\left(\frac{-\Delta G}{R \cdot T}\right) \quad K_2 = 6.9373 \times 10^{-5}$$

With the assumption of ideal gases, we apply Eq. (13.28):

$$(1) \quad \frac{y_{\text{NO}}}{(y_{\text{N}_2})^{0.5} \cdot (y_{\text{O}_2})^{0.5}} = \frac{y_{\text{NO}}}{(0.7)^{0.5} \cdot (0.05)^{0.5}} = K_1$$

$$y_{\text{NO}} := K_1 \cdot (0.7)^{0.5} \cdot (0.05)^{0.5} \quad y_{\text{NO}} = 3.74962 \times 10^{-3} \quad \text{Ans.}$$

$$(2) \quad P_0 := 1 \quad P := 200$$

$$\frac{y_{\text{NO}_2}}{(y_{\text{N}_2})^{0.5} \cdot y_{\text{O}_2}} = \frac{y_{\text{NO}_2}}{(0.7)^{0.5} \cdot (0.05)} = \left(\frac{P}{P_0}\right)^{0.5} \cdot K_2$$

$$y_{\text{NO}_2} := \left(\frac{P}{P_0}\right)^{0.5} \cdot K_2 \cdot (0.7)^{0.5} \cdot (0.05) \quad y_{\text{NO}_2} = 4.104 \times 10^{-5} \quad \text{Ans.}$$

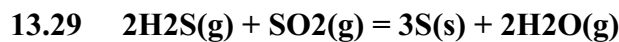

The sulfur exists PURE as a solid phase, for which the activity is  $f/f_0$ . Since  $f$  and  $f_0$  are for practical purposes the same, the activity is unity, and it is omitted from the equilibrium equation. Thus for the gases only,

$$\nu = -1$$

From the given data and the data of Table C.4,

$$\Delta H_{298} := -145546 \cdot \frac{\text{J}}{\text{mol}}$$

$$\Delta G_{298} := -89830 \cdot \frac{\text{J}}{\text{mol}}$$



The following vectors represent the species of the reaction in the order in which they appear:

$$v := \begin{pmatrix} -2 \\ -1 \\ 3 \\ 2 \end{pmatrix} \quad A := \begin{pmatrix} 3.931 \\ 5.699 \\ 4.114 \\ 3.470 \end{pmatrix} \quad B := \begin{pmatrix} 1.490 \\ 0.801 \\ -1.728 \\ 1.450 \end{pmatrix} \cdot 10^{-3} \quad D := \begin{pmatrix} -0.232 \\ -1.015 \\ -0.783 \\ 0.121 \end{pmatrix} \cdot 10^5$$

$$i := 1..4 \quad \Delta A := \sum_i (v_i \cdot A_i) \quad \Delta B := \sum_i (v_i \cdot B_i) \quad \Delta D := \sum_i (v_i \cdot D_i)$$

$$\Delta A = 5.721 \quad \Delta B = -6.065 \times 10^{-3} \quad \Delta C := 0 \quad \Delta D = -6.28 \times 10^4$$

$$T := 723.15 \cdot \text{kelvin} \quad T_0 := 298.15 \cdot \text{kelvin}$$

$$\Delta G := \Delta H_{298} - \frac{T}{T_0} \cdot (\Delta H_{298} - \Delta G_{298}) \dots \\ + R \cdot \text{IDCPH}(T_0, T, \Delta A, \Delta B, \Delta C, D) \dots \\ + -R \cdot T \cdot \text{IDCPS}(T_0, T, \Delta A, \Delta B, \Delta C, D)$$

$$\Delta G = -1.538 \times 10^4 \frac{\text{J}}{\text{mol}} \quad K := \exp\left(\frac{-\Delta G}{R \cdot T}\right) \quad K = 12.9169$$

By Eq. (13.5), gases only:  $n_0 = 3$  (basis)

$$y_{\text{H}_2\text{S}} = \frac{2 - 2 \cdot \varepsilon}{3 - \varepsilon} \quad y_{\text{SO}_2} = \frac{1 - \varepsilon}{3 - \varepsilon} \quad y_{\text{H}_2\text{O}} = \frac{2 \cdot \varepsilon}{3 - \varepsilon}$$

By Eq. (13.28),  $\varepsilon := 0.5$  (guess)

$$\text{Given } \frac{(2 - 2 \cdot \varepsilon)^2 \cdot (1 - \varepsilon)}{(2 - 2 \cdot \varepsilon)^2 \cdot (1 - \varepsilon)} = 8 \cdot K \quad \varepsilon := \text{Find}(\varepsilon) \quad \varepsilon = 0.767$$

Percent conversion of reactants = PC

$$\text{PC} = \frac{n_{i0} - n_i}{n_{i0}} \cdot 100 = \frac{-\nu_i}{n_{i0}} \cdot 100 \quad [\text{By Eq. (13.4)}]$$

Since the reactants are present in the stoichiometric proportions, for each reactant,

$$n_{i0} = -v_i \quad \text{Whence} \quad PC := \varepsilon \cdot 100 \quad PC = 76.667 \quad \text{Ans.}$$

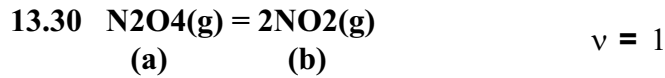

Data from Tables C.4 and C.1 provide the following values:

$$\Delta H_{298} := 57200 \cdot \frac{\text{J}}{\text{mol}}$$

$$\Delta G_{298} := 5080 \cdot \frac{\text{J}}{\text{mol}}$$

$$T_0 := 298.15 \cdot \text{kelvin}$$

$$T := 350 \cdot \text{kelvin}$$

$$\Delta A := -1.696$$

$$\Delta B := 0.133 \cdot 10^{-3}$$

$$\Delta C := 0$$

$$\Delta D := 1.203 \cdot 10^{-5}$$

$$\begin{aligned} \Delta G &:= \Delta H_{298} - \frac{T}{T_0} \cdot (\Delta H_{298} - \Delta G_{298}) \dots \\ &+ R \cdot \text{IDCPH}(T_0, T, \Delta A, \Delta B, \Delta C, D) \dots \\ &+ -R \cdot T \cdot \text{IDCPS}(T_0, T, \Delta A, \Delta B, \Delta C, D) \end{aligned}$$

$$\Delta G = -3.968 \times 10^3 \frac{\text{J}}{\text{mol}}$$

$$K := \exp\left(\frac{-\Delta G}{R \cdot T}\right)$$

$$K = 3.911$$

Basis: 1 mol species (a) initially. Then

$$y_a = \frac{1 - \varepsilon}{1 + \varepsilon} \quad y_b = \frac{2 \cdot \varepsilon}{1 + \varepsilon} \quad \frac{(2 \cdot \varepsilon)^2}{(1 - \varepsilon) \cdot (1 + \varepsilon)} = \left(\frac{P}{P_0}\right)^{-1} \cdot K$$

(a)  $P := 5$   $P_0 := 1$   $\varepsilon := \sqrt{\frac{K}{4 \cdot P + K}}$   $\varepsilon = 0.4044$

$$y_a := \frac{1 - \varepsilon}{1 + \varepsilon} \quad y_a = 0.4241 \quad \text{Ans.}$$

(b)  $P := 1$   $P_0 := 1$   $\varepsilon := \sqrt{\frac{K}{4 \cdot P + K}}$   $\varepsilon = 0.7031$

By Eq. (4.18), at 350 K:

$$\Delta H := \Delta H_{298} + R \cdot \text{IDCPH}(T_0, T, \Delta A, \Delta B, \Delta C, D)$$

$$\Delta H = 56984 \frac{\text{J}}{\text{mol}}$$

This is Q per mol of reaction, which is

$$\Delta \varepsilon := 0.7031 - 0.4044$$

$$\Delta \varepsilon = 0.299$$

Whence  $Q := \Delta H \cdot \Delta \varepsilon$

$$Q = 17021 \frac{\text{J}}{\text{mol}} \quad \text{Ans.}$$

13.31 By Eq. (13.32),

$$K = \frac{x_B \cdot \gamma_B}{x_A \cdot \gamma_A} = \frac{(1 - x_A) \cdot \gamma_B}{x_A \cdot \gamma_A}$$

$$\ln(\gamma_a) = 0.1 \cdot x_B^2 \quad \ln(\gamma_b) = 0.1 \cdot x_A^2 \quad \text{Whence}$$

$$K = \left( \frac{1 - x_A}{x_A} \right) \cdot \frac{\exp(0.1 \cdot x_A^2)}{\exp(0.1 \cdot x_B^2)} = \frac{1 - x_A}{x_A} \cdot \exp[0.1 \cdot (x_A^2 - x_B^2)]$$

$$K = \frac{1 - x_A}{x_A} \cdot \exp[0.1 \cdot (2 \cdot x_A - 1)] \quad K = \exp\left(\frac{-\Delta G}{R \cdot T}\right)$$

$$\Delta G := -1000 \cdot \frac{\text{J}}{\text{mol}}$$

$$T := 298.15 \cdot \text{kelvin}$$

$$x_A := .5 \quad (\text{guess})$$

$$\text{Given } \frac{1 - x_A}{x_A} \cdot \exp[0.1 \cdot (2 \cdot x_A - 1)] = \exp\left(\frac{-\Delta G}{R \cdot T}\right) \quad x_A := \text{Find}(x_A)$$

$$x_A = 0.3955 \quad \text{Ans.}$$

For an ideal solution, the exponential term is unity:

$$\text{Given } \frac{1 - x_A}{x_A} = \exp\left(\frac{-\Delta G}{R \cdot T}\right) \quad x_A := \text{Find}(x_A) \quad x_A = 0.4005$$

This result is high by 0.0050. Ans.

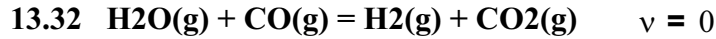

From the data of Table C.4,

$$\Delta H_{298} := -41166 \cdot \frac{\text{J}}{\text{mol}}$$

$$\Delta G_{298} := -28618 \cdot \frac{\text{J}}{\text{mol}}$$

$$T_0 := 298.15 \cdot \text{kelvin}$$

$$T := 800 \cdot \text{kelvin}$$

$$\Delta A := 1.860$$

$$\Delta B := -0.540 \cdot 10^{-3}$$

$$\Delta C := 0$$

$$\Delta D := -1.164 \cdot 10^5$$

$$\begin{aligned} \Delta G := & \Delta H_{298} - \frac{T}{T_0} \cdot (\Delta H_{298} - \Delta G_{298}) \dots \\ & + R \cdot \text{IDCPH}(T_0, T, \Delta A, \Delta B, \Delta C, D) \dots \\ & + -R \cdot T \cdot \text{IDCPS}(T_0, T, \Delta A, \Delta B, \Delta C, D) \end{aligned}$$

$$\Delta G = -9.668 \times 10^3 \frac{\text{J}}{\text{mol}}$$

$$K := \exp\left(\frac{-\Delta G}{R \cdot T}\right)$$

$$K = 4.27837$$

(a) No. Since  $\nu = 0$ , at low pressures  $P$  has no effect

(b) No.  $K$  decreases with increasing  $T$ . (The standard heat of reaction is negative.)

(c) Basis: 1 mol CO, 1 mol H<sub>2</sub>, w mol H<sub>2</sub>O feed.

From the problem statement,

$$\frac{n_{\text{CO}}}{n_{\text{CO}} + n_{\text{H}_2} + n_{\text{CO}_2}} = 0.02$$

By Eq. (13.4),  $n_{\text{CO}} = 1 - \varepsilon \quad n_{\text{H}_2} = 1 + \varepsilon \quad n_{\text{CO}_2} = \varepsilon$

$$\frac{1 - \varepsilon}{1 - \varepsilon + \varepsilon + \varepsilon + 1 + \varepsilon} = \frac{1 - \varepsilon}{2 + \varepsilon} = 0.02 \quad \varepsilon := \frac{0.96}{1.02} \quad \varepsilon = 0.941$$

Let  $z = w/2 =$  moles H<sub>2</sub>O/mole "Water gas".

By Eq. (13.5),

$$y_{\text{H}_2\text{O}} = \frac{w - \varepsilon}{2 + w} = \frac{2 \cdot z - \varepsilon}{2 + 2 \cdot z} \quad y_{\text{CO}} = \frac{1 - \varepsilon}{2 + 2 \cdot z} \quad y_{\text{H}_2} = \frac{1 + \varepsilon}{2 + 2 \cdot z}$$

$$y_{\text{CO}_2} = \frac{\varepsilon}{2 + 2 \cdot z} \quad \text{By Eq. (13.28)} \quad z := 2 \quad (\text{guess})$$

$$\text{Given } \frac{\varepsilon \cdot (1 + \varepsilon)}{(2 \cdot z - \varepsilon) \cdot (1 - \varepsilon)} = K \quad z := \text{Find}(z) \quad z = 4.1 \quad \text{Ans.}$$

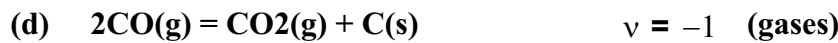

Data from Tables C.4 and C.1:

$$\Delta H_{298} := -172459 \cdot \frac{\text{J}}{\text{mol}}$$

$$\Delta G_{298} := -120021 \cdot \frac{\text{J}}{\text{mol}}$$

$$\Delta A := 0.476$$

$$\Delta B := 0.702 \cdot 10^{-3}$$

$$\Delta C := 0$$

$$\Delta D := -1.962 \cdot 10^5$$

$$\begin{aligned} \Delta G := & \Delta H_{298} - \frac{T}{T_0} \cdot (\Delta H_{298} - \Delta G_{298}) \dots \\ & + R \cdot \text{IDCPH}(T_0, T, \Delta A, \Delta B, \Delta C, D) \dots \\ & + -R \cdot T \cdot \text{IDCPS}(T_0, T, \Delta A, \Delta B, \Delta C, D) \end{aligned}$$

$$\Delta G = -3.074 \times 10^4 \cdot \frac{\text{J}}{\text{mol}}$$

$$K := \exp\left(\frac{-\Delta G}{R \cdot T}\right)$$

$$K = 101.7$$

By Eq. (13.28), gases only, with  $P = P_0 = 1 \text{ bar}$

$$\frac{y_{\text{CO}_2}}{(y_{\text{CO}})^2} = K = 101.7 \quad \text{for the reaction AT EQUILIBRIUM.}$$

If the ACTUAL value of this ratio is GREATER than this value, the reaction tries to shift left to reduce the ratio. But if no carbon is present, no reaction is possible, and certainly no carbon is formed. The actual value of the ratio in the equilibrium mixture of Part (c) is

$$y_{\text{CO}_2} := \frac{\varepsilon}{2 + 2 \cdot z}$$

$$y_{\text{CO}} := \frac{1 - \varepsilon}{2 + 2 \cdot z}$$

$$y_{\text{CO}_2} = 0.092$$

$$y_{\text{CO}} = 5.767 \times 10^{-3}$$

$$\text{RATIO} := \frac{y_{\text{CO}_2}}{(y_{\text{CO}})^2}$$

$$\text{RATIO} = 2.775 \times 10^3$$

No carbon can deposit from the equilibrium mixture.



This is the reaction of Pb. 13.21, where the following parameter values are given:

$$\Delta H_{298} := -90135 \cdot \frac{\text{J}}{\text{mol}}$$

$$\Delta G_{298} := -24791 \cdot \frac{\text{J}}{\text{mol}}$$

$$T := 550 \cdot \text{kelvin}$$

$$T_0 := 298.15 \cdot \text{kelvin}$$

$$\Delta A := -7.663 \quad \Delta B := 10.815 \cdot 10^{-3} \quad \Delta C := -3.45 \cdot 10^{-6} \quad \Delta D := -0.135 \cdot 10^5$$

$$\begin{aligned} \Delta G := & \Delta H_{298} - \frac{T}{T_0} \cdot (\Delta H_{298} - \Delta G_{298}) \dots \\ & + R \cdot \text{IDCPH}(T_0, T, \Delta A, \Delta B, \Delta C, D) \dots \\ & + -R \cdot T \cdot \text{IDCPS}(T_0, T, \Delta A, \Delta B, \Delta C, D) \end{aligned}$$

$$\Delta G = 3.339 \times 10^4 \cdot \frac{\text{J}}{\text{mol}}$$

$$K_1 := \exp\left(\frac{-\Delta G}{R \cdot T}\right)$$

$$K_1 = 6.749 \times 10^{-4}$$



From the data of Table C.4,

$$\Delta H_{298} := 41166 \cdot \frac{\text{J}}{\text{mol}}$$

$$\Delta G_{298} := 28618 \cdot \frac{\text{J}}{\text{mol}}$$

$$T := 550 \cdot \text{kelvin}$$

$$T_0 := 298.15 \cdot \text{kelvin}$$

The following vectors represent the species of the reaction in the order in which they appear:

$$\nu := \begin{pmatrix} -1 \\ -1 \\ 1 \\ 1 \end{pmatrix}$$

$$A := \begin{pmatrix} 3.249 \\ 5.457 \\ 3.376 \\ 3.470 \end{pmatrix}$$

$$B := \begin{pmatrix} 0.422 \\ 1.045 \\ 0.557 \\ 1.450 \end{pmatrix} \cdot 10^{-3}$$

$$D := \begin{pmatrix} 0.083 \\ -1.157 \\ -0.031 \\ 0.121 \end{pmatrix} \cdot 10^5$$

$$i := 1..4 \quad \Delta A := \sum_i (\nu_i \cdot A_i) \quad \Delta B := \sum_i (\nu_i \cdot B_i) \quad \Delta D := \sum_i (\nu_i \cdot D_i)$$

$$\Delta A = -1.86$$

$$\Delta B = 5.4 \times 10^{-4}$$

$$\Delta C := 0$$

$$\Delta D = 1.164 \times 10^5$$

$$\Delta G := \Delta H_{298} - \frac{T}{T_0} \cdot (\Delta H_{298} - \Delta G_{298}) \dots$$

$$+ R \cdot \text{IDCPH}(T_0, T, \Delta A, \Delta B, \Delta C, D) \dots$$

$$+ -R \cdot T \cdot \text{IDCPS}(T_0, T, \Delta A, \Delta B, \Delta C, D)$$

$$\Delta G = 1.856 \times 10^4 \frac{\text{J}}{\text{mol}}$$

$$K_2 := \exp\left(\frac{-\Delta G}{R \cdot T}\right)$$

$$K_2 = 0.01726$$

**Basis: 1 mole of feed gas containing 0.75 mol H<sub>2</sub>, 0.15 mol CO, 0.05 mol CO<sub>2</sub>, and 0.05 mol N<sub>2</sub>.**

**Stoichiometric numbers,  $v_{i,j}$**

i =	H <sub>2</sub>	CO	CO <sub>2</sub>	CH <sub>3</sub> OH	H <sub>2</sub> O
j					
1	-2	-1	0	1	0
2	-1	1	-1	0	1

**By Eq. (13.7)**

$$y_{\text{H}_2} = \frac{0.75 - 2 \cdot \varepsilon_1 - 2}{1 - 2 \cdot \varepsilon_1} \quad y_{\text{CO}} = \frac{0.15 - \varepsilon_1 + 2}{1 - 2 \cdot \varepsilon_1}$$

$$y_{\text{CO}_2} = \frac{0.05 - \varepsilon_2}{1 - 2 \cdot \varepsilon_1} \quad y_{\text{CH}_3\text{OH}} = \frac{\varepsilon_1}{1 - 2 \cdot \varepsilon_1} \quad y_{\text{H}_2\text{O}} = \frac{\varepsilon_2}{1 - 2 \cdot \varepsilon_1}$$

$$P := 100$$

$$P_0 := 1$$

**By Eq. (13.40),**  $\varepsilon_1 := 0.1$   $\varepsilon_2 := 0.1$  **(guesses)**

Given

$$\frac{\varepsilon_1 \cdot (1 - 2 \cdot \varepsilon_1)^2}{(0.75 - 2 \cdot \varepsilon_1 - 2)^2 \cdot (0.15 - \varepsilon_1 + 2)} = \left(\frac{P}{P_0}\right)^2 \cdot K_1$$

$$\frac{(0.15 - \varepsilon_1 + 2) \cdot \varepsilon_2}{(0.75 - 2 \cdot \varepsilon_1 - 2) \cdot (0.05 - \varepsilon_2)} = K_2 \quad \begin{pmatrix} \varepsilon_1 \\ \varepsilon_2 \end{pmatrix} := \text{Find}(\varepsilon_1, \varepsilon_2)$$

$$\varepsilon_1 = 0.1186$$

$$\varepsilon_2 = 8.8812 \times 10^{-3}$$

$$y_{H_2} := \frac{0.75 - 2 \cdot \varepsilon_1 - 2}{1 - 2 \cdot \varepsilon_1} \quad y_{CO} := \frac{0.15 - \varepsilon_1 + 2}{1 - 2 \cdot \varepsilon_1}$$

$$y_{CO_2} := \frac{0.05 - \varepsilon_2}{1 - 2 \cdot \varepsilon_1} \quad y_{CH_3OH} := \frac{\varepsilon_1}{1 - 2 \cdot \varepsilon_1} \quad y_{H_2O} := \frac{\varepsilon_2}{1 - 2 \cdot \varepsilon_1}$$

$$y_{N_2} := 1 - y_{H_2} - y_{CO} - y_{CO_2} - y_{CH_3OH} - y_{H_2O}$$

$$y_{H_2} = 0.6606$$

$$y_{CO} = 0.0528$$

$$y_{CO_2} = 0.0539$$

Ans.

$$y_{CH_3OH} = 0.1555$$

$$y_{H_2O} = 0.0116$$

$$y_{N_2} = 0.0655$$

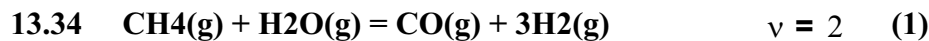

From the data of Table C.4,

$$\Delta H_{298} := 205813 \cdot \frac{J}{mol}$$

$$\Delta G_{298} := 141863 \cdot \frac{J}{mol}$$

The following vectors represent the species of the reaction in the order in which they appear:

$$v := \begin{pmatrix} -1 \\ -1 \\ 1 \\ 3 \end{pmatrix}$$

$$A := \begin{pmatrix} 1.702 \\ 3.470 \\ 3.376 \\ 3.249 \end{pmatrix}$$

$$B := \begin{pmatrix} 9.081 \\ 1.450 \\ 0.557 \\ 0.422 \end{pmatrix} \cdot 10^{-3}$$

$$C := \begin{pmatrix} -2.164 \\ 0.0 \\ 0.0 \\ 0.0 \end{pmatrix} \cdot 10^{-6}$$

$$D := \begin{pmatrix} 0.0 \\ 0.121 \\ -0.031 \\ 0.083 \end{pmatrix} \cdot 10^5$$

$$i := 1..4$$

$$\Delta A := \sum_i (v_i \cdot A_i) \quad \Delta B := \sum_i (v_i \cdot B_i) \quad \Delta C := \sum_i (v_i \cdot C_i) \quad \Delta D := \sum_i (v_i \cdot D_i)$$

$$\Delta A = 7.951$$

$$\Delta B = -8.708 \times 10^{-3}$$

$$\Delta C = 2.164 \times 10^{-6}$$

$$\Delta D = 9.7 \times 10^3$$



$$T := 1300 \cdot \text{kelvin}$$

$$T_0 := 298.15 \cdot \text{kelvin}$$

$$\begin{aligned} \Delta G := & \Delta H_{298} - \frac{T}{T_0} \cdot (\Delta H_{298} - \Delta G_{298}) \dots \\ & + R \cdot \text{IDCPH}(T_0, T, \Delta A, \Delta B, \Delta C, D) \dots \\ & + -R \cdot T \cdot \text{IDCPS}(T_0, T, \Delta A, \Delta B, \Delta C, D) \end{aligned}$$

$$\Delta G = -1.031 \times 10^5 \frac{\text{J}}{\text{mol}}$$

$$K_1 := \exp\left(\frac{-\Delta G}{R \cdot T}\right)$$

$$K_1 = 13845$$



This is the reaction of Pb. 13.32, where parameter values are given:

$$\Delta H_{298} := -41166 \cdot \frac{\text{J}}{\text{mol}}$$

$$\Delta G_{298} := -28618 \cdot \frac{\text{J}}{\text{mol}}$$

$$\Delta A := 1.860$$

$$\Delta B := -0.540 \cdot 10^{-3}$$

$$\Delta C := 0.0$$

$$\Delta D := -1.164 \cdot 10^5$$

$$\begin{aligned} \Delta G := & \Delta H_{298} - \frac{T}{T_0} \cdot (\Delta H_{298} - \Delta G_{298}) \dots \\ & + R \cdot \text{IDCPH}(T_0, T, \Delta A, \Delta B, \Delta C, D) \dots \\ & + -R \cdot T \cdot \text{IDCPS}(T_0, T, \Delta A, \Delta B, \Delta C, D) \end{aligned}$$

$$\Delta G = 5.892 \times 10^3 \frac{\text{J}}{\text{mol}}$$

$$K_2 := \exp\left(\frac{-\Delta G}{R \cdot T}\right)$$

$$K_2 = 0.5798$$

(a) No. Primary reaction (1) shifts left with increasing P.

(b) No. Primary reaction (1) shifts left with increasing T.

(c) The value of K1 is so large compared with the value of K2 that for all practical purposes reaction (1) may be considered to go to completion. With a feed equimolar in CH4 and H2O, no H2O then remains for reaction (2). In this event the ratio, moles H2/moles CO is very nearly equal to 3.0.

(d) With H<sub>2</sub>O present in an amount greater than the stoichiometric ratio, reaction (2) becomes important. However, reaction (1) for all practical purposes still goes to completion, and may be considered to provide the feed for reaction (2). On the basis of 1 mol CH<sub>4</sub> and 2 mol H<sub>2</sub>O initially, what is left as feed for reaction (2) is: 1 mol H<sub>2</sub>O, 1 mol CO, and 3 mol H<sub>2</sub>; n<sub>0</sub> = 5. Thus, for reaction (2) at equilibrium by Eq. (13.5):

$$y_{\text{CO}} = y_{\text{H}_2\text{O}} = \frac{1 - \varepsilon}{5} \quad y_{\text{CO}_2} = \frac{\varepsilon}{5} \quad y_{\text{H}_2} = \frac{3 + \varepsilon}{5}$$

By Eq. (13.28),  $\varepsilon := 0.5$  (guess)

Given  $\frac{\varepsilon \cdot (3 + \varepsilon)}{(1 - \varepsilon)^2} = K_2$   $\varepsilon := \text{Find}(\varepsilon)$   $\varepsilon = 0.1375$

Ratio =  $\frac{y_{\text{H}_2}}{y_{\text{CO}}}$  Ratio :=  $\frac{3 + \varepsilon}{1 - \varepsilon}$  Ratio = 3.638 Ans.

(e) One practical way is to add CO<sub>2</sub> to the feed. Some H<sub>2</sub> then reacts with the CO<sub>2</sub> by reaction (2) to form additional CO and to lower the H<sub>2</sub>/CO ratio.

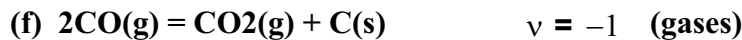

This reaction is considered in the preceding problem, Part (d), from which we get the necessary parameter values:

$\Delta H_{298} := -172459 \cdot \frac{\text{J}}{\text{mol}}$

$\Delta G_{298} := -120021 \cdot \frac{\text{J}}{\text{mol}}$

For T = 1300 K,

T := 1300 · kelvin

T<sub>0</sub> := 298.15 · kelvin

$\Delta A := 0.476$

$\Delta B := 0.702 \cdot 10^{-3}$

$\Delta C := 0.0$

$\Delta D := -1.962 \cdot 10^5$

$$\Delta G := \Delta H_{298} - \frac{T}{T_0} \cdot (\Delta H_{298} - \Delta G_{298}) \dots$$

$$+ R \cdot \text{IDCPH}(T_0, T, \Delta A, \Delta B, \Delta C, D) \dots$$

$$+ -R \cdot T \cdot \text{IDCPS}(T_0, T, \Delta A, \Delta B, \Delta C, D)$$

$$\Delta G = 5.673 \times 10^4 \frac{\text{J}}{\text{mol}}$$

$$K := \exp\left(\frac{-\Delta G}{R \cdot T}\right)$$

$$K = 5.255685 \times 10^{-3}$$

As explained in Problem 13.32(d), the question of carbon deposition depends on:

$$\text{RATIO} = \frac{y_{\text{CO}_2}}{(y_{\text{CO}})^2}$$

When for ACTUAL compositions the value of this ratio is greater than the equilibrium value as given by K, there can be no carbon deposition. Thus in Part (c), where the CO<sub>2</sub> mole fraction approaches zero, there is danger of carbon deposition. However, in Part (d) there can be no carbon deposition, because Ratio > K:

$$\text{Ratio} := \frac{\varepsilon \cdot 5}{(1 - \varepsilon)^2}$$

$$\text{Ratio} = 0.924$$

### 13.37 Formation reactions:

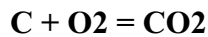
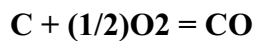
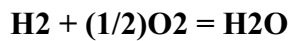

Elimination first of C and then of O<sub>2</sub> leads to a pair of reactions:

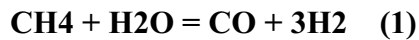

There are alternative equivalent pairs, but for these:

Stoichiometric numbers,  $v_{i,j}$

i =	CH <sub>4</sub>	H <sub>2</sub> O	CO	CO <sub>2</sub>	H <sub>2</sub>	v <sub>j</sub>
j						
1	-1	-1	1	0	3	2
2	0	-1	-1	1	1	0

For initial amounts: 2 mol CH<sub>4</sub> and 3 mol H<sub>2</sub>O, n<sub>0</sub> = 5, and by Eq. (13.7):

$$y_{\text{CH}_4} = \frac{2 - \varepsilon_1}{5 + 2 \cdot \varepsilon_1} \quad y_{\text{H}_2\text{O}} = \frac{3 - \varepsilon_1 - 2}{5 + 2 \cdot \varepsilon_1} \quad y_{\text{CO}} = \frac{\varepsilon_1 - \varepsilon_2}{5 + 2 \cdot \varepsilon_1}$$

$$y_{\text{CO}_2} = \frac{\varepsilon_2}{5 + 2 \cdot \varepsilon_1} \quad y_{\text{H}_2} = \frac{3 \cdot \varepsilon_1 + 2}{5 + 2 \cdot \varepsilon_1}$$

By Eq. (13.40), with P = P<sub>0</sub> = 1 bar

$$\frac{y_{\text{CO}} \cdot (y_{\text{H}_2})^3}{y_{\text{CH}_4} \cdot y_{\text{H}_2\text{O}}} = k_1 \quad \frac{y_{\text{CO}_2} \cdot y_{\text{H}_2}}{y_{\text{CO}} \cdot y_{\text{H}_2\text{O}}} = k_2$$

From the data given in Example 13.14,

$$\Delta G_1 := -27540 \cdot \frac{\text{J}}{\text{mol}}$$

$$\Delta G_2 := -3130 \cdot \frac{\text{J}}{\text{mol}}$$

$$T := 1000 \cdot \text{kelvin}$$

$$K_1 := \exp\left(\frac{-\Delta G_1}{R \cdot T}\right)$$

$$K_2 := \exp\left(\frac{-\Delta G_2}{R \cdot T}\right)$$

$$K_1 = 27.453$$

$$K_2 = 1.457$$

$$\varepsilon_1 := 1.5 \quad \varepsilon_2 := 1 \quad (\text{guesses})$$

$$\text{Given} \quad \frac{(\varepsilon_1 - \varepsilon_2) \cdot (3 \cdot \varepsilon_1 + 2)^3}{(2 - \varepsilon_1) \cdot (3 - \varepsilon_1 - 2) \cdot (5 + 2 \cdot \varepsilon_1)^2} = K_1$$

$$\frac{\varepsilon_2 \cdot (3 \cdot \varepsilon_1 + 2)}{(\varepsilon_1 - \varepsilon_2) \cdot (3 - \varepsilon_1 - 2)} = K_2$$

$$\begin{pmatrix} \varepsilon_1 \\ \varepsilon_2 \end{pmatrix} := \text{Find}(\varepsilon_1, \varepsilon_2)$$

$$\varepsilon_1 = 1.8304$$

$$\varepsilon_2 = 0.3211$$

$$y_{\text{CH}_4} := \frac{2 - \varepsilon_1}{5 + 2 \cdot \varepsilon_1}$$

$$y_{\text{H}_2\text{O}} := \frac{3 - \varepsilon_1 - 2}{5 + 2 \cdot \varepsilon_1}$$

$$y_{\text{CO}} := \frac{\varepsilon_1 - \varepsilon_2}{5 + 2 \cdot \varepsilon_1}$$

$$y_{\text{CO}_2} := \frac{\varepsilon_2}{5 + 2 \cdot \varepsilon_1} \quad y_{\text{H}_2} := \frac{3 \cdot \varepsilon_1 + 2}{5 + 2 \cdot \varepsilon_1}$$

$$y_{\text{CH}_4} = 0.0196$$

$$y_{\text{H}_2\text{O}} = 0.098$$

$$y_{\text{CO}} = 0.1743$$

$$y_{\text{CO}_2} = 0.0371$$

$$y_{\text{H}_2} = 0.6711$$

These results are in agreement with those of Example 13.14.

### 13.39 Phase-equilibrium equations:

**Ethylene oxide(1):**  $p_1 = y_1 \cdot P = 415 \cdot x_1$   $P := 101.33 \cdot \text{kPa}$   $x_1 = \frac{y_1 \cdot P}{415 \cdot \text{kPa}}$

**Water(2):**  $x_2 \cdot P_{\text{sat}_2} = y_2 \cdot P$   $P_{\text{sat}_2} := 3.166 \cdot \text{kPa}$   $x_2 = \frac{y_2 \cdot P}{P_{\text{sat}_2}}$   
(steam tables)

**Ethylene glycol(3):**  $P_{\text{sat}_3} = 0.0$   $y_3 = 0.0$

Therefore,  $y_2 = 1 - y_1$  and  $x_3 = 1 - x_2 - x_1$

For the specified standard states:

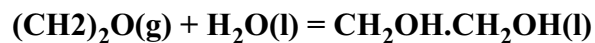

By Eq. (13.40) and the stated assumptions,

$$k = \frac{\gamma_3 \cdot x_3}{\left(y_1 \cdot \frac{P}{P_0}\right) \cdot \left(y_2 \cdot x_2\right)} = \frac{x_3}{y_1 \cdot x_2}$$

$$T := 298.15 \cdot \text{kelvin}$$

Data from Table C.4:

$$\Delta G_{298} := -72941 \cdot \frac{\text{J}}{\text{mol}}$$

$$k := \exp\left(\frac{-\Delta G_{298}}{R \cdot T}\right)$$

$$k = 6.018 \times 10^{12} \quad \text{Ans.}$$

So large a value of  $k$  requires either  $y_1$  or  $x_2$  to approach zero. If  $y_1$  approaches zero,  $y_2$  approaches unity, and the phase-equilibrium expression for water(2) makes  $x_2 = 32$ , which is impossible. Thus  $x_2$  must approach zero, and the phase-equilibrium equation requires  $y_2$  also to approach zero. This means that for all practical purposes the reaction goes to completion. For initial amounts of 3 moles of ethylene oxide and 1 mole of water, the water present is entirely reacted along with 1 mole of the ethylene oxide. Conversion of the oxide is therefore 33.3 %.

13.41

a) Stoichiometric coefficients:  $v := \begin{pmatrix} -1 & -1 \\ -1 & 0 \\ 1 & -1 \\ 0 & 1 \end{pmatrix}$  Initial numbers of moles  $n_0 := \begin{pmatrix} 50 \\ 50 \\ 0 \\ 0 \end{pmatrix} \frac{\text{kmol}}{\text{hr}}$

Number of components:  $i := 1..4$  Number of reactions:  $j := 1..2$

$v_j := \sum_i v_{i,j}$   $v = \begin{pmatrix} -1 \\ -1 \end{pmatrix}$   $n_0 := \sum_i n_{0i}$   $n_0 = 100 \frac{\text{kmol}}{\text{hr}}$

Given values:  $y_A := 0.05$   $y_B := 0.10$

Guess:  $y_C := 0.4$   $y_D := 0.4$   $\varepsilon_1 := 1 \frac{\text{kmol}}{\text{hr}}$   $\varepsilon_2 := 1 \frac{\text{kmol}}{\text{hr}}$

Given

$$y_A = \frac{n_{01} - \varepsilon_1 - 2}{n_0 - \varepsilon_1 - 2} \quad y_B = \frac{n_{02} - \varepsilon_1}{n_0 - \varepsilon_1 - 2}$$

Eqn. (13.7)

$$y_C = \frac{n_{03} + \varepsilon_1 - 2}{n_0 - \varepsilon_1 - 2} \quad y_D = \frac{n_{04} + \varepsilon_2}{n_0 - \varepsilon_1 - 2}$$

$\begin{pmatrix} y_C \\ y_D \\ \varepsilon_1 \\ \varepsilon_2 \end{pmatrix} := \text{Find}(y_C, y_D, \varepsilon_1, \varepsilon_2)$   $\varepsilon_1 = 44.737 \frac{\text{kmol}}{\text{hr}}$   $\varepsilon_2 = 2.632 \frac{\text{kmol}}{\text{hr}}$

(i) $n_A := n_{01} - \varepsilon_1 - 2$	$n_A = 2.632 \frac{\text{kmol}}{\text{hr}}$	
$n_B := n_{02} - \varepsilon_1$	$n_B = 5.263 \frac{\text{kmol}}{\text{hr}}$	
$n_C := n_{03} + \varepsilon_1 - 2$	$n_C = 42.105 \frac{\text{kmol}}{\text{hr}}$	
$n_D := n_{04} + \varepsilon_2$	$n_D = 2.632 \frac{\text{kmol}}{\text{hr}}$	
$n := n_A + n_B + n_C + n_D$	$n = 52.632 \frac{\text{kmol}}{\text{hr}}$	<b>Ans.</b>

(ii) $y_C = 0.8$	$y_D = 0.05$	<b>Ans.</b>
------------------	--------------	-------------

b) Stoichiometric coefficients:  $v := \begin{pmatrix} -1 & -1 \\ -1 & -2 \\ 1 & 0 \\ 0 & 1 \end{pmatrix}$       Initial numbers of moles  $n_0 := \begin{pmatrix} 40 \\ 40 \\ 0 \\ 0 \end{pmatrix} \frac{\text{kmol}}{\text{hr}}$

Number of components:  $i := 1..4$       Number of reactions:  $j := 1..2$

$v_j := \sum_i v_{i,j}$        $v = \begin{pmatrix} -1 \\ -2 \end{pmatrix}$        $n_0 := \sum_i n_{0i}$        $n_0 = 80 \frac{\text{kmol}}{\text{hr}}$

Given values:  $y_C := 0.52$        $y_D := 0.04$

Guess:  $y_A := 0.4$        $y_B := 0.4$        $\varepsilon_1 := 1 \frac{\text{kmol}}{\text{hr}}$        $\varepsilon_2 := 1 \frac{\text{kmol}}{\text{hr}}$

Given

$$y_A = \frac{n_{01} - \varepsilon_1 - 2}{n_0 - \varepsilon_1 - 2\varepsilon_2} \qquad y_B = \frac{n_{02} - \varepsilon_1 - 2\varepsilon_2}{n_0 - \varepsilon_1 - 2\varepsilon_2} \qquad \text{Eqn. (13.7)}$$

$$y_C = \frac{n_{03} + \varepsilon_1}{n_0 - \varepsilon_1 - 2\varepsilon_2} \qquad y_D = \frac{n_{04} + \varepsilon_2}{n_0 - \varepsilon_1 - 2\varepsilon_2}$$

$$\begin{pmatrix} y_A \\ y_B \\ \varepsilon_1 \\ \varepsilon_2 \end{pmatrix} := \text{Find}(y_A, y_B, \varepsilon_1, \varepsilon_2)$$

$$\varepsilon_1 = 26 \frac{\text{kmol}}{\text{hr}} \quad \varepsilon_2 = 2 \frac{\text{kmol}}{\text{hr}}$$

$$y_A = 0.24 \quad y_B = 0.2$$

$$n_A := n_{01} - \varepsilon_1 - 2\varepsilon_2 \quad n_A = 12 \frac{\text{kmol}}{\text{hr}}$$

$$n_B := n_{02} - \varepsilon_1 - 2\varepsilon_2 \quad n_B = 10 \frac{\text{kmol}}{\text{hr}}$$

$$n_C := n_{03} + \varepsilon_1 \quad n_C = 26 \frac{\text{kmol}}{\text{hr}}$$

$$n_D := n_{04} + \varepsilon_2 \quad n_D = 2 \frac{\text{kmol}}{\text{hr}}$$

**Ans.**

c) Stoichiometric coefficients:  $v := \begin{pmatrix} -1 & -1 \\ 1 & -1 \\ 1 & 0 \\ 0 & 1 \end{pmatrix}$  **Initial numbers of moles**  $n_0 := \begin{pmatrix} 100 \\ 0 \\ 0 \\ 0 \end{pmatrix} \frac{\text{kmol}}{\text{hr}}$

**Number of components:**  $i := 1..4$       **Number of reactions:**  $j := 1..2$

$$v_j := \sum_i v_{i,j} \quad v = \begin{pmatrix} 1 \\ -1 \end{pmatrix} \quad n_0 := \sum_i n_{0i} \quad n_0 = 100 \frac{\text{kmol}}{\text{hr}}$$

**Given values:**  $y_C := 0.3$        $y_D := 0.1$

**Guess:**  $y_A := 0.4$        $y_B := 0.4$        $\varepsilon_1 := 1 \frac{\text{kmol}}{\text{hr}}$        $\varepsilon_2 := 1 \frac{\text{kmol}}{\text{hr}}$

Given

$$y_A = \frac{n_{01} - \varepsilon_1 - 2\varepsilon_2}{n_0 + \varepsilon_1 - 2\varepsilon_2} = 0 \quad y_B = \frac{n_{02} + \varepsilon_1 - 2\varepsilon_2}{n_0 + \varepsilon_1 - 2\varepsilon_2}$$

**Eqn. (13.7)**

$$y_C = \frac{n_{03} + \varepsilon_1}{n_0 + \varepsilon_1 - 2\varepsilon_2} \quad y_D = \frac{n_{04} + \varepsilon_2}{n_0 + \varepsilon_1 - 2\varepsilon_2}$$



$$\begin{pmatrix} y_A \\ y_B \\ \varepsilon_1 \\ \varepsilon_2 \end{pmatrix} := \text{Find}(y_A, y_B, \varepsilon_1, \varepsilon_2)$$

$$\varepsilon_1 = 37.5 \frac{\text{kmol}}{\text{hr}} \quad \varepsilon_2 = 12.5 \frac{\text{kmol}}{\text{hr}}$$

$$y_A = 0.4 \quad y_B = 0.2$$

$$n_A := n_{01} - \varepsilon_1 - \varepsilon_2 \quad n_A = 50 \frac{\text{kmol}}{\text{hr}}$$

$$n_B := n_{02} + \varepsilon_1 - \varepsilon_2 \quad n_B = 25 \frac{\text{kmol}}{\text{hr}} \quad \text{Ans.}$$

$$n_C := n_{03} + \varepsilon_1 \quad n_C = 37.5 \frac{\text{kmol}}{\text{hr}}$$

$$n_D := n_{04} + \varepsilon_2 \quad n_D = 12.5 \frac{\text{kmol}}{\text{hr}}$$

d) Stoichiometric coefficients:  $v := \begin{pmatrix} -1 & -1 \\ -1 & -1 \\ 1 & 0 \\ 0 & 1 \\ 0 & 1 \end{pmatrix}$  Initial numbers of moles  $n_0 := \begin{pmatrix} 40 \\ 60 \\ 0 \\ 0 \\ 0 \end{pmatrix} \frac{\text{kmol}}{\text{hr}}$

Number of components:  $i := 1..5$  Number of reactions:  $j := 1..2$

$$v_j := \sum_i v_{i,j} \quad v = \begin{pmatrix} -1 \\ 0 \end{pmatrix} \quad n_0 := \sum_i n_{0i} \quad n_0 = 100 \frac{\text{kmol}}{\text{hr}}$$

Given values:  $y_C := 0.25$   $y_D := 0.20$

Guess:  $y_A := 0.2$   $y_B := 0.4$   $y_E := 0.1$   $\varepsilon_1 := 1 \frac{\text{kmol}}{\text{hr}}$   $\varepsilon_2 := 1 \frac{\text{kmol}}{\text{hr}}$

Given

$$y_A = \frac{n_{01} - \varepsilon_1 - 2}{n_0 - \varepsilon_1} \quad y_B = \frac{n_{02} - \varepsilon_1 - 2}{n_0 - \varepsilon_1} \quad \text{Eqn. (13.7)}$$

$$y_C = \frac{n_{03} + \varepsilon_1}{n_0 - \varepsilon_1} \quad y_D = \frac{n_{04} + \varepsilon_2}{n_0 - \varepsilon_1} \quad y_E = \frac{n_{05} + \varepsilon_2}{n_0 - \varepsilon_1}$$

$$\begin{pmatrix} y_A \\ y_B \\ y_E \\ \varepsilon_1 \\ \varepsilon_2 \end{pmatrix} := \text{Find}(y_A, y_B, y_E, \varepsilon_1, \varepsilon_2)$$

$$\varepsilon_1 = 20 \frac{\text{kmol}}{\text{hr}} \quad \varepsilon_2 = 16 \frac{\text{kmol}}{\text{hr}}$$

	(i)	(ii)
$n_A := n_{01} - \varepsilon_1 - 2$	$n_A = 4 \frac{\text{kmol}}{\text{hr}}$	$y_A = 0.05$
$n_B := n_{02} - \varepsilon_1 - 2$	$n_B = 24 \frac{\text{kmol}}{\text{hr}}$	$y_B = 0.3$
$n_C := n_{03} + \varepsilon_1$	$n_C = 20 \frac{\text{kmol}}{\text{hr}}$	$y_C = 0.25$
$n_D := n_{04} + \varepsilon_2$	$n_D = 16 \frac{\text{kmol}}{\text{hr}}$	$y_D = 0.2$
$n_E := n_{05} + \varepsilon_2$	$n_E = 16 \frac{\text{kmol}}{\text{hr}}$	$y_E = 0.2$

**Ans.**

**13.45**  $\text{C}_2\text{H}_4(\text{g}) + \text{H}_2\text{O}(\text{g}) \rightarrow \text{C}_2\text{H}_5\text{OH}(\text{g})$

$T_0 := 298.15 \text{kelvin}$	$P_0 := 1 \text{bar}$	$T := 400 \text{kelvin}$	$P := 2 \text{bar}$
$1 = \text{C}_2\text{H}_4(\text{g})$	$\Delta H_{0f1} := 52500 \frac{\text{J}}{\text{mol}}$	$\Delta G_{0f1} := 68460 \frac{\text{J}}{\text{mol}}$	
$2 = \text{H}_2\text{O}(\text{g})$	$\Delta H_{0f2} := -241818 \frac{\text{J}}{\text{mol}}$	$\Delta G_{0f2} := -228572 \frac{\text{J}}{\text{mol}}$	
$3 = \text{C}_2\text{H}_5\text{OH}(\text{g})$	$\Delta H_{0f3} := -235100 \frac{\text{J}}{\text{mol}}$	$\Delta G_{0f3} := -168490 \frac{\text{J}}{\text{mol}}$	

$$\Delta H_0 := -\Delta H_{0f1} - \Delta H_{0f2} + H_{0f3} \quad \Delta H_0 = -45.782 \frac{\text{kJ}}{\text{mol}}$$

$$\Delta G_0 := -\Delta G_{0f1} - \Delta G_{0f2} + G_{0f3} \quad \Delta G_0 = -8.378 \frac{\text{kJ}}{\text{mol}}$$

$$\Delta A := -(1.424) - (3.470) + (3.518)$$

$$\Delta A = -1.376$$

$$\Delta B := [-(14.394) - (1.450) + (20.001)] \cdot 10^{-3}$$

$$\Delta B = 4.157 \times 10^{-3}$$

$$\Delta C := [-(4.392) - (0) + (-6.002)] \cdot 10^{-6}$$

$$\Delta C = -1.61 \times 10^{-6}$$

$$\Delta D := [-(0) - (0.121) + (0)] \cdot 10^5$$

$$\Delta D = -1.21 \times 10^4$$

a)  $K_0 := \exp\left(\frac{-\Delta G_0}{R \cdot T_0}\right)$  **Eqn. (13.21)**  $K_{298} := K_0$   $K_{298} = 29.366$  **Ans.**

b)  $K_1 := \exp\left[\frac{\Delta H_0}{R \cdot T_0} \cdot \left(1 - \frac{T_0}{T}\right)\right]$  **Eqn. (13.22)**  $K_1 = 9.07 \times 10^{-3}$

$K_2 := \exp\left(\frac{-1}{T} \text{IDCPH}(T_0, T, \Delta A, \Delta B, \Delta C, D \dots) + \text{IDCPS}(T_0, T, \Delta A, \Delta B, \Delta C, D)\right)$   $K_2 = 0.989$  **Eqn. (13.23)**

$K_{400} := K_0 \cdot K_1 \cdot K_2$  **Eqn. (13.20)**  $K_{400} = 0.263$  **Ans.**

c) Assume as a basis there is initially 1 mol of C<sub>2</sub>H<sub>4</sub> and 1 mol of H<sub>2</sub>O

$$y_1 = \frac{1 - \varepsilon_e}{2 - \varepsilon_e} \quad y_2 = \frac{1 - \varepsilon_e}{2 - \varepsilon_e} \quad y_3 = \frac{\varepsilon_e}{2 - \varepsilon_e}$$

Assuming ideal gas behavior  $\frac{y_3}{y_1 \cdot y_2} = K \cdot \frac{P}{P_0}$

Substituting results in the following expression:  $\frac{\frac{\varepsilon_e}{2 - \varepsilon_e}}{\frac{1 - \varepsilon_e}{2 - \varepsilon_e} \cdot \frac{1 - \varepsilon_e}{2 - \varepsilon_e}} = K_{400} \cdot \frac{P}{P_0}$

Solve for  $\varepsilon_e$  using a Mathcad solve block.

Guess:  $\varepsilon_e := 0.5$

$$\text{Given } \frac{\frac{\varepsilon_e}{2 - \varepsilon_e}}{\frac{1 - \varepsilon_e}{2 - \varepsilon_e} \cdot \frac{1 - \varepsilon_e}{2 - \varepsilon_e}} = K_{400} \cdot \frac{P}{P_0} \quad \varepsilon_e := \text{Find}(\varepsilon_e) \quad \varepsilon_e = 0.191$$

$$y_1 := \frac{1 - \varepsilon_e}{2 - \varepsilon_e} \quad y_2 := \frac{1 - \varepsilon_e}{2 - \varepsilon_e} \quad y_3 := \frac{\varepsilon_e}{2 - \varepsilon_e}$$

$$y_1 = 0.447$$

$$y_2 = 0.447$$

$$y_3 = 0.105$$

Ans.

d) Since  $\nu = -1 < 0$ , a decrease in pressure will cause a shift on the reaction to the left and the mole fraction of ethanol will decrease.

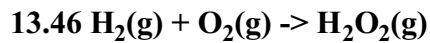

$$\Delta H_{\text{fH}_2\text{O}_2} := -136.1064 \frac{\text{kJ}}{\text{mol}}$$

$$T := 298.15 \text{ kelvin} \quad P := 1 \text{ bar}$$

$$S_{\text{O}_2} := 130.680 \frac{\text{J}}{\text{mol} \cdot \text{kelvin}}$$

$$S_{\text{O}_2} := 205.152 \frac{\text{J}}{\text{mol} \cdot \text{kelvin}}$$

$$S_{\text{H}_2\text{O}_2} := 232.95 \frac{\text{J}}{\text{mol} \cdot \text{kelvin}}$$

$$\Delta S_{\text{fH}_2\text{O}_2} := -S_{\text{H}_2} - S_{\text{O}_2} + S_{\text{H}_2\text{O}_2}$$

$$\Delta S_{\text{fH}_2\text{O}_2} = -102.882 \frac{\text{J}}{\text{mol} \cdot \text{kelvin}}$$

$$\Delta G_{\text{f}} := \Delta H_{\text{fH}_2\text{O}_2} - T \cdot \Delta S_{\text{fH}_2\text{O}_2}$$

$$\Delta G_{\text{f}} = -105.432 \frac{\text{kJ}}{\text{mol}} \quad \text{Ans.}$$

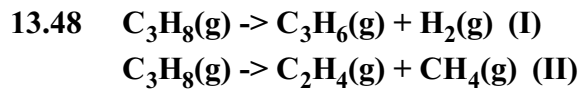

$T_0 := 298.15 \text{ kelvin}$	$P_0 := 1 \text{ bar}$	$T := 750 \text{ kelvin}$	$P := 1.2 \text{ bar}$
1 = $C_3H_8(g)$	$\Delta H_{f1} := -104680 \frac{\text{J}}{\text{mol}}$	$\Delta G_{f1} := -24290 \frac{\text{J}}{\text{mol}}$	
2 = $C_3H_6(g)$	$\Delta H_{f2} := 19710 \frac{\text{J}}{\text{mol}}$	$\Delta G_{f2} := 62205 \frac{\text{J}}{\text{mol}}$	
3 = $H_2(g)$	$\Delta H_{f3} := 0 \frac{\text{J}}{\text{mol}}$	$\Delta G_{f3} := 0 \frac{\text{J}}{\text{mol}}$	
4 = $C_2H_4(g)$	$\Delta H_{f4} := 52510 \frac{\text{J}}{\text{mol}}$	$\Delta G_{f4} := 68460 \frac{\text{J}}{\text{mol}}$	
5 = $CH_4(g)$	$\Delta H_{f5} := -74520 \frac{\text{J}}{\text{mol}}$	$\Delta G_{f5} := -50460 \frac{\text{J}}{\text{mol}}$	

Calculate equilibrium constant for reaction I:

$$\Delta H_{0I} := -\Delta H_{0f1} + \Delta H_{0f2} + H_{0f3} \quad \Delta H_{0I} = 124.39 \frac{\text{kJ}}{\text{mol}}$$

$$\Delta G_{0I} := -\Delta G_{0f1} + \Delta G_{0f2} + G_{0f3} \quad \Delta G_{0I} = 86.495 \frac{\text{kJ}}{\text{mol}}$$

$$\Delta A_I := -(1.213) + (1.637) + (3.249) \quad \Delta A_I = 3.673$$

$$\Delta B_I := [-(28.785) + (22.706) + (0.422)] \cdot 10^{-3} \quad \Delta B_I = -5.657 \times 10^{-3}$$

$$\Delta C_I := [-(8.824) + (-6.915) + (0)] \cdot 10^{-6} \quad \Delta C_I = 1.909 \times 10^{-6}$$

$$\Delta D_I := [-(0) + (0) + (0.083)] \cdot 10^5 \quad \Delta D_I = 8.3 \times 10^3$$

$$K_{I0} := \exp\left(\frac{-\Delta G_{0I}}{R \cdot T_0}\right) \quad \text{Eqn. (13.21)} \quad K_{I0} = 0$$

$$K_{I1} := \exp\left[\frac{\Delta H_{0I}}{R \cdot T_0} \cdot \left(1 - \frac{T_0}{T}\right)\right] \quad \text{Eqn. (13.22)} \quad K_{I1} = 1.348 \times 10^{13}$$

$$K_{I2} := \exp\left(\frac{-1}{T} \text{IDCPH}(T_0, T, \Delta A_I, \Delta B_I, \Delta C_I, D_I \dots) + \text{IDCPS}(T_0, T, \Delta A_I, \Delta B_I, \Delta C_I, D_I) \right) \quad \text{Eqn. (13.23)} \quad K_{I2} = 1.714$$

$$K_I := K_{I0} \cdot K_{I1} \cdot K_{I2} \quad \text{Eqn. (13.20)}$$

$$K_I = 0.016$$

Calculate equilibrium constant for reaction II:

$$\Delta H_{0II} := -\Delta H_{0f1} + \Delta H_{0f4} + H_{0f5} \quad \Delta H_{0II} = 82.67 \frac{\text{kJ}}{\text{mol}}$$

$$\Delta G_{0II} := -\Delta G_{0f1} + \Delta G_{0f4} + G_{0f5} \quad \Delta G_{0II} = 42.29 \frac{\text{kJ}}{\text{mol}}$$

$$\Delta A_{II} := -(1.213) + (1.424) + (1.702)$$

$$\Delta A_{II} = 1.913$$

$$\Delta B_{II} := [-(28.785) + (14.394) + (9.081)] \cdot 10^{-3}$$

$$\Delta B_{II} = -5.31 \times 10^{-3}$$

$$\Delta C_{II} := [ -(-8.824) + (-4.392) + (-2.164) ] \cdot 10^{-6}$$

$$\Delta C_{II} = 2.268 \times 10^{-6}$$

$$\Delta D_{II} := [-(0) + (0) + (0)] \cdot 10^5$$

$$\Delta D_{II} = 0$$

$$K_{II0} := \exp\left(\frac{-\Delta G_{0II}}{R \cdot T_0}\right) \quad \text{Eqn. (13.21)}$$

$$K_{II0} = 3.897 \times 10^{-8}$$

$$K_{II1} := \exp\left[\frac{\Delta H_{0II}}{R \cdot T_0} \cdot \left(1 - \frac{T_0}{T}\right)\right] \quad \text{Eqn. (13.22)}$$

$$K_{II1} = 5.322 \times 10^8$$

$$K_{II2} := \exp\left(\frac{-1}{T} \text{IDCPH}(T_0, T, \Delta A_{II}, \Delta B_{II}, \Delta C_{II}, D_{II} \dots) + \text{IDCPS}(T_0, T, \Delta A_{II}, \Delta B_{II}, \Delta C_{II}, D_{II})\right) \quad \text{Eqn. (13.23)}$$

$$K_{II2} = 1.028$$

$$K_{II} := K_{II0} \cdot K_{II1} \cdot K_{II2} \quad \text{Eqn. (13.20)}$$

$$K_{II} = 21.328$$

Assume an ideal gas and 1 mol of  $C_3H_8$  initially.

$$y_1 = \frac{1 - \varepsilon_I - \varepsilon_{II}}{1 + \varepsilon_I + \varepsilon_{II}} \quad y_2 = \frac{\varepsilon_I}{1 + \varepsilon_I + \varepsilon_{II}} \quad y_3 = \frac{\varepsilon_I}{1 + \varepsilon_I + \varepsilon_{II}}$$

$$y_4 = \frac{\varepsilon_{II}}{1 + \varepsilon_I + \varepsilon_{II}} \quad y_5 = \frac{\varepsilon_{II}}{1 + \varepsilon_I + \varepsilon_{II}} \quad \text{Eqn. (13.7)}$$

The equilibrium relationships are:

$$\frac{y_2 \cdot y_3}{y_1} = K_I \cdot \left(\frac{P_0}{P}\right) \quad \frac{y_4 \cdot y_5}{y_1} = K_{II} \cdot \left(\frac{P_0}{P}\right) \quad \text{Eqn. (13.28)}$$

Substitution yields the following equations:

$$\frac{\left(\frac{\varepsilon_I}{1+\varepsilon_I+\Pi}\right) \cdot \left(\frac{\varepsilon_I}{1+\varepsilon_I+\Pi}\right)}{\left(\frac{1-\varepsilon_I-\Pi}{1+\varepsilon_I+\Pi}\right)} = KI \cdot \left(\frac{P_0}{P}\right)$$

$$\frac{\left(\frac{\varepsilon_{II}}{1+\varepsilon_I+\Pi}\right) \cdot \left(\frac{\varepsilon_{II}}{1+\varepsilon_I+\Pi}\right)}{\left(\frac{1-\varepsilon_I-\Pi}{1+\varepsilon_I+\Pi}\right)} = KII \cdot \left(\frac{P_0}{P}\right)$$

Use a Mathcad solve block to solve these two equations for  $\varepsilon_I$  and  $\varepsilon_{II}$ . Note that the equations have been rearranged to facilitate the numerical solution.

Guess:  $\varepsilon_I := 0.5$        $\varepsilon_{II} := 0.5$

Given

$$\frac{\varepsilon_I}{1+\varepsilon_I+\Pi} \cdot \frac{\varepsilon_I}{1+\varepsilon_I+\Pi} = KI \cdot \left(\frac{P_0}{P}\right) \cdot \left(\frac{1-\varepsilon_I-\Pi}{1+\varepsilon_I+\Pi}\right)$$

$$\frac{\varepsilon_{II}}{1+\varepsilon_I+\Pi} \cdot \frac{\varepsilon_{II}}{1+\varepsilon_I+\Pi} = KII \cdot \left(\frac{P_0}{P}\right) \cdot \frac{1-\varepsilon_I-\Pi}{1+\varepsilon_I+\Pi}$$

$$\begin{pmatrix} \varepsilon_I \\ \varepsilon_{II} \end{pmatrix} := \text{Find}(\varepsilon_I, \varepsilon_{II}) \quad \varepsilon_I = 0.026 \quad \varepsilon_{II} = 0.948$$

$$y_1 := \frac{1-\varepsilon_I-\Pi}{1+\varepsilon_I+\Pi} \quad y_2 := \frac{\varepsilon_I}{1+\varepsilon_I+\Pi} \quad y_3 := \frac{\varepsilon_I}{1+\varepsilon_I+\Pi}$$

$$y_4 := \frac{\varepsilon_{II}}{1+\varepsilon_I+\Pi} \quad y_5 := \frac{\varepsilon_{II}}{1+\varepsilon_I+\Pi}$$

$$y_1 = 0.01298 \quad y_2 = 0.0132 \quad y_3 = 0.0132 \quad y_4 = 0.4803 \quad y_5 = 0.4803$$

A summary of the values for the other temperatures is given in the table below.

T =	750 K	1000 K	1250 K
y <sub>1</sub>	0.0130	0.00047	0.00006
y <sub>2</sub>	0.0132	0.034	0.0593
y <sub>3</sub>	0.0132	0.034	0.0593
y <sub>4</sub>	0.4803	0.4658	0.4407
y <sub>5</sub>	0.4803	0.4658	0.4407

13.49 n-C<sub>4</sub>H<sub>10</sub>(g) → iso-C<sub>4</sub>H<sub>10</sub>(g)

$$T_0 := 298.15 \text{ kelvin}$$

$$P_0 := 1 \text{ bar}$$

$$T := 425 \text{ kelvin}$$

$$P := 15 \text{ bar}$$

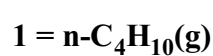

$$\Delta H_{0f1} := -125790 \frac{\text{J}}{\text{mol}}$$

$$\Delta G_{0f1} := -16570 \frac{\text{J}}{\text{mol}}$$

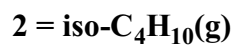

$$\Delta H_{0f2} := -134180 \frac{\text{J}}{\text{mol}}$$

$$\Delta G_{0f2} := -20760 \frac{\text{J}}{\text{mol}}$$

$$\Delta H_0 := -\Delta H_{0f1} + H_{0f2}$$

$$\Delta H_0 = -8.39 \frac{\text{kJ}}{\text{mol}}$$

$$\Delta G_0 := -\Delta G_{0f1} + G_{0f2}$$

$$\Delta G_0 = -4.19 \frac{\text{kJ}}{\text{mol}}$$

$$\Delta A := -(1.935) + (1.677)$$

$$\Delta A = -0.258$$

$$\Delta B := [-(36.915) + (37.853)] \cdot 10^{-3}$$

$$\Delta B = 9.38 \times 10^{-4}$$

$$\Delta C := [(11.402) + (-11.945)] \cdot 10^{-6}$$

$$\Delta C = -5.43 \times 10^{-7}$$

$$\Delta D := [-(0) + (0)] \cdot 10^5$$

$$\Delta D = 0$$

$$\text{a) } K_0 := \exp\left(\frac{-\Delta G_0}{R \cdot T_0}\right) \quad \text{Eqn. (13.21)}$$

$$K_0 = 5.421$$

Ans.

$$\text{b) } K_1 := \exp\left[\frac{\Delta H_0}{R \cdot T_0} \cdot \left(1 - \frac{T_0}{T}\right)\right] \quad \text{Eqn. (13.22)}$$

$$K_1 = 0.364$$

$$K_2 := \exp\left(\frac{-1}{T} \text{IDCPH}(T_0, T, \Delta A, \Delta B, \Delta C, D \dots) + \text{IDCPS}(T_0, T, \Delta A, \Delta B, \Delta C, D)\right) \quad K_2 = 1 \quad \text{Eqn. (13.23)}$$



$$K_e := K_0 \cdot K_1 \cdot K_2 \quad \text{Eqn. (13.20)} \quad K_e = 1.974 \quad \text{Ans.}$$

Assume as a basis there is initially 1 mol of n-C<sub>4</sub>H<sub>10</sub>(g)

$$y_1 = 1 - \varepsilon_e \quad y_2 = \varepsilon_e$$

a) Assuming ideal gas behavior  $\frac{y_2}{y_1} = K_e$

Substitution results in the following expression:  $\frac{\varepsilon_e}{1 - \varepsilon_e} = K_e$

Solving for K<sub>e</sub> yields the following analytical expression for ε<sub>e</sub>

$$\varepsilon_e := \frac{1}{1 + K_e} \quad \varepsilon_e = 0.336$$

$$y_1 := 1 - \varepsilon_e \quad y_1 = 0.664 \quad y_2 := \varepsilon_e \quad y_2 = 0.336 \quad \text{Ans.}$$

b) Assume the gas is an ideal solution. In this case Eqn. (13.27) applies.

$$\prod_i \left[ y_i \cdot \phi_i = \left( \frac{P}{P_0} \right)^{-v} \cdot K \right] \quad \text{Eqn. (13.27)}$$

Substituting for y<sub>i</sub> yields:  $\frac{1 - \varepsilon_e \cdot \phi_2}{\varepsilon_e \cdot \phi_1} = K$

This can be solved analytically for ε<sub>e</sub> to get:  $\varepsilon_e = \frac{\phi_2}{\phi_2 + K_e \cdot \phi_1}$

Calculate φ<sub>i</sub> for each pure component using the PHIB function.

For n-C<sub>4</sub>H<sub>10</sub>:  $\omega_1 := 0.200$   $T_{c1} := 425.1 \text{ kelvin}$   $P_{c1} := 37.96 \text{ bar}$

$$T_{r1} := \frac{T}{T_{c1}} \quad T_{r1} = 1 \quad P_{r1} := \frac{P}{P_{c1}} \quad P_{r1} = 0.395$$

$$\phi_1 := \text{PHIB}(T_{r1}, P_{r1}, \omega_1) \quad \phi_1 = 0.872$$

For iso-C<sub>4</sub>H<sub>10</sub>:  $\omega_2 := 0.181$   $T_{c2} := 408.1 \text{ kelvin}$   $P_{c2} := 36.48 \text{ bar}$

$$T_{r2} := \frac{T}{T_{c2}} \quad T_{r2} = 1.041 \quad P_{r2} := \frac{P}{P_{c2}} \quad P_{r2} = 0.411$$

$$\phi_2 := \text{PHIB}(\Gamma_{r2}, \mathbf{B}_{r2}, 2) \quad \phi_2 = 0.884$$

**Solving for  $\varepsilon_e$  yields:**  $\varepsilon_e := \frac{\phi_2}{\phi_2 + K_e \cdot \phi_1} \quad \varepsilon_e = 0.339$

$$y_1 := 1 - \varepsilon_e \quad y_1 = 0.661 \quad y_2 := \varepsilon_e \quad y_2 = 0.339 \quad \text{Ans.}$$

**The values of  $y_1$  and  $y_2$  calculated in parts a) and b) differ by less than 1%. Therefore, the effects of vapor-phase nonidealities is here minimal.**

## Chapter 14 - Section A - Mathcad Solutions

14.1  $A_{12} := 0.59$        $A_{21} := 1.42$        $T := (55 + 273.15) \cdot K$

**Margules equations:**

$$\gamma_1(x_1) := \exp\left[(1 - x_1)^2 \cdot [A_{12} + 2 \cdot (A_{21} - A_{12}) \cdot x_1]\right]$$

$$\gamma_2(x_1) := \exp\left[x_1^2 \cdot [A_{21} + 2 \cdot (A_{12} - A_{21}) \cdot (1 - x_1)]\right]$$

$Psat_1 := 82.37 \cdot kPa$

$Psat_2 := 37.31 \cdot kPa$

(a) **BUBL P calculations based on Eq. (10.5):**

$$P_{bubl}(x_1) := x_1 \cdot \gamma_1(x_1) \cdot Psat_1 + (1 - x_1) \cdot \gamma_2(x_1) \cdot Psat_2$$

$$y_1(x_1) := \frac{x_1 \cdot \gamma_1(x_1) \cdot Psat_1}{P_{bubl}(x_1)}$$

$x_1 := 0.25$

$P_{bubl}(x_1) = 64.533 \text{ kPa}$

$y_1(x_1) = 0.562$

$x_1 := 0.50$

$P_{bubl}(x_1) = 80.357 \text{ kPa}$

$y_1(x_1) = 0.731$

$x_1 := 0.75$

$P_{bubl}(x_1) = 85.701 \text{ kPa}$

$y_1(x_1) = 0.808$

(b) **BUBL P calculations with virial coefficients:**

$B_{11} := -963 \cdot \frac{\text{cm}^3}{\text{mol}}$

$B_{22} := -1523 \cdot \frac{\text{cm}^3}{\text{mol}}$

$B_{12} := 52 \cdot \frac{\text{cm}^3}{\text{mol}}$

$$\delta_{12} := 2 \cdot B_{12} - B_{11} - B_{22}$$

$$\Phi_1(P, T, y_1, y_2) := \exp\left[\frac{B_{11} \cdot (P - Psat_1) + P \cdot y_2^2 \cdot \delta_{12}}{R \cdot T}\right]$$

$$\Phi_2(P, T, y_1, y_2) := \exp\left[\frac{B_{22} \cdot (P - Psat_2) + P \cdot y_1^2 \cdot \delta_{12}}{R \cdot T}\right]$$

**Guess:**  $P := \frac{P_{\text{sat}1} + P_{\text{sat}2}}{2}$        $y_1 := 0.5$        $y_2 := 1 - y_1$

$x_1 := 0.25$       Given

$$y_1 \cdot \Phi_1(P, T, y_1, y_2) \cdot P = x_1 \cdot \gamma_1(x_1) \cdot P_{\text{sat}1}$$

$$y_2 \cdot \Phi_2(P, T, y_1, y_2) \cdot P = (1 - x_1) \cdot \gamma_2(x_1) \cdot P_{\text{sat}2}$$

$$y_2 = 1 - y_1$$

$$\begin{pmatrix} y_1 \\ y_2 \\ P \end{pmatrix} := \text{Find}(y_1, y_2, P)$$

$$\begin{pmatrix} y_1 \\ y_2 \\ \frac{P}{\text{kPa}} \end{pmatrix} = \begin{pmatrix} 0.558 \\ 0.442 \\ 63.757 \end{pmatrix}$$

$x_1 := 0.50$       Given

$$y_1 \cdot \Phi_1(P, T, y_1, y_2) \cdot P = x_1 \cdot \gamma_1(x_1) \cdot P_{\text{sat}1}$$

$$y_2 \cdot \Phi_2(P, T, y_1, y_2) \cdot P = (1 - x_1) \cdot \gamma_2(x_1) \cdot P_{\text{sat}2}$$

$$y_2 = 1 - y_1$$

$$\begin{pmatrix} y_1 \\ y_2 \\ P \end{pmatrix} := \text{Find}(y_1, y_2, P)$$

$$\begin{pmatrix} y_1 \\ y_2 \\ \frac{P}{\text{kPa}} \end{pmatrix} = \begin{pmatrix} 0.733 \\ 0.267 \\ 79.621 \end{pmatrix}$$

$x_1 := 0.75$       Given

$$y_1 \cdot \Phi_1(P, T, y_1, y_2) \cdot P = x_1 \cdot \gamma_1(x_1) \cdot P_{\text{sat}1}$$

$$y_2 \cdot \Phi_2(P, T, y_1, y_2) \cdot P = (1 - x_1) \cdot \gamma_2(x_1) \cdot P_{\text{sat}2}$$

$$y_2 = 1 - y_1$$

$$\begin{pmatrix} y_1 \\ y_2 \\ P \end{pmatrix} := \text{Find}(y_1, y_2, P)$$

$$\begin{pmatrix} y_1 \\ y_2 \\ \frac{P}{\text{kPa}} \end{pmatrix} = \begin{pmatrix} 0.812 \\ 0.188 \\ 85.14 \end{pmatrix}$$

14.3  $T := 200 \cdot \text{K}$        $P := 30 \cdot \text{bar}$        $y_1 := 0.95$

$H_1 := 200 \cdot \text{bar}$        $B := -105 \cdot \frac{\text{cm}^3}{\text{mol}}$

Assume Henry's law applies to methane(1) in the liquid phase, and that the Lewis/Randall rule applies to the methane in the vapor:

$$f_{\text{hat}_1}^{\text{l}} = H_1 \cdot x_1 \qquad f_{\text{hat}_1}^{\text{v}} = y_1 \cdot \phi_1 \cdot P$$

By Eq. (11.36):  $\phi_1 := \exp\left(\frac{B \cdot P}{R \cdot T}\right)$        $\phi_1 = 0.827$

Equate the liquid- and vapor-phase fugacities and solve for  $x_1$ :

$$x_1 := \frac{y_1 \cdot \phi_1 \cdot P}{H_1} \qquad x_1 = 0.118 \quad \text{Ans.}$$

#### 14.4 Pressures in kPa

Data:

$x_1 :=$	0.000		12.30		0.000
	0.0895		15.51		0.2716
	0.1981		18.61		0.4565
	0.3193		21.63		0.5934
	0.4232		24.01		0.6815
	0.5119		25.92		0.7440
	0.6096		27.96		0.8050
	0.7135		30.12		0.8639

$$i := 2 \dots \text{rows}(P) \qquad x_2 := 1 - x_1 \qquad P_{\text{sat}_2} := P_1$$

(a) It follows immediately from Eq. (12.10a) that:

$$\ln(\gamma_1^\infty) = A_{12}$$

Combining this with Eq. (12.10a) yields the required expression

(b) Henry's constant will be found as part of the solution to Part (c)

(c) BARKER'S METHOD by non-linear least squares.  
Margules equation.

The most satisfactory procedure for reduction of this set of data is to find the value of Henry's constant by regression along with the Margules parameters.

$$\gamma_1(x_1, x_2, A_{12}, A_{21}) := \exp\left[(x_2)^2 \cdot [A_{12} + 2 \cdot (A_{21} - A_{12}) \cdot x_1]\right]$$

$$\gamma_2(x_1, x_2, A_{12}, A_{21}) := \exp\left[(x_1)^2 \cdot [A_{21} + 2 \cdot (A_{12} - A_{21}) \cdot x_2]\right]$$

Guesses:  $H_1 := 50$        $A_{21} := 0.2$        $A_{12} := 0.4$

Minimize the sums of the squared errors by setting sums of derivatives equal to zero.

$$\text{Given } 0 = \sum_i \left[ \frac{d}{dA_{12}} \left[ P_i - \left( x_{1_i} \cdot \gamma_1(x_{1_i}, x_{2_i}, A_{12}, A_{21}) \cdot \frac{H_1}{\exp(A_{12})} \dots \right) \right] \right]^2$$

$$0 = \sum_i \left[ \frac{d}{dA_{21}} \left[ P_i - \left( x_{1_i} \cdot \gamma_1(x_{1_i}, x_{2_i}, A_{12}, A_{21}) \cdot \frac{H_1}{\exp(A_{12})} \dots \right) \right] \right]^2$$

$$0 = \sum_i \left[ \frac{d}{dH_1} \left[ P_i - \left( x_{1_i} \cdot \gamma_1(x_{1_i}, x_{2_i}, A_{12}, A_{21}) \cdot \frac{H_1}{\exp(A_{12})} \dots \right) \right] \right]^2$$

$$\begin{pmatrix} A_{12} \\ A_{21} \\ H_1 \end{pmatrix} := \text{Find}(A_{12}, A_{21}, H_1) \qquad \begin{pmatrix} A_{12} \\ A_{21} \\ H_1 \end{pmatrix} = \begin{pmatrix} 0.348 \\ 0.178 \\ 51.337 \end{pmatrix} \quad \text{Ans.}$$

$$\begin{aligned}
 \text{(d)} \quad \gamma_1(x_1, x_2) &:= \exp\left[ x_2^2 \cdot [A_{12} + 2 \cdot (A_{21} - A_{12}) \cdot x_1] \right] \\
 \gamma_2(x_1, x_2) &:= \exp\left[ x_1^2 \cdot [A_{21} + 2 \cdot (A_{12} - A_{21}) \cdot x_2] \right] \\
 P_{\text{calc}_i} &:= x_{1_i} \cdot \gamma_1(x_{1_i}, x_{2_i}) \cdot \frac{H_1}{\exp(A_{12})} + x_{2_i} \cdot \gamma_2(x_{1_i}, x_{2_i}) \cdot P_{\text{sat}_2} \\
 y_{1\text{calc}_i} &:= \frac{x_{1_i} \cdot \gamma_1(x_{1_i}, x_{2_i}) \cdot \frac{H_1}{\exp(A_{12})}}{P_{\text{calc}_i}}
 \end{aligned}$$

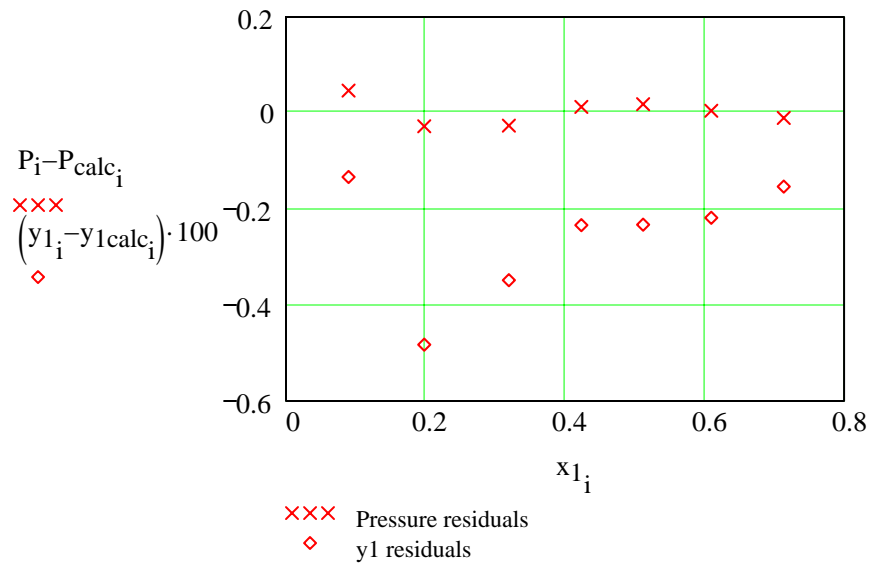

**Fit GE/RT data to Margules eqn. by least squares:**

$$i := 2 \dots \text{rows}(P) \qquad y_2 := 1 - y_1$$

Given

$$0 = \sum_i \frac{d}{dA_{12}} \left[ \left( x_{1_i} \cdot \ln \left( \frac{y_{1_i} \cdot P_i}{x_{1_i} \cdot \frac{H_1}{\exp(A_{12})}} \right) \right) \dots - \left( A_{21} \cdot x_{1_i} \dots \right) \cdot x_{1_i} \cdot x_{2_i} \right]^2$$

$$0 = \sum_i \frac{d}{dA_{21}} \left[ \left( x_{1_i} \cdot \ln \left( \frac{y_{1_i} \cdot P_i}{H_1} \right) \dots - \left( A_{21} \cdot x_{1_i} \dots \right) \cdot x_{1_i} \cdot x_{2_i} \right) \right. \\ \left. + x_{2_i} \cdot \ln \left( \frac{y_{2_i} \cdot P_i}{x_{2_i} \cdot P_{\text{sat}2}} \right) \right]^2$$

$$0 = \sum_i \frac{d}{dH_1} \left[ \left( x_{1_i} \cdot \ln \left( \frac{y_{1_i} \cdot P_i}{H_1} \right) \dots - \left( A_{21} \cdot x_{1_i} \dots \right) \cdot x_{1_i} \cdot x_{2_i} \right) \right. \\ \left. + x_{2_i} \cdot \ln \left( \frac{y_{2_i} \cdot P_i}{x_{2_i} \cdot P_{\text{sat}2}} \right) \right]^2$$

$$\begin{pmatrix} A_{12} \\ A_{21} \\ H_1 \end{pmatrix} := \text{Find}(A_{12}, A_{21}, H_1) \quad \begin{pmatrix} A_{12} \\ A_{21} \\ H_1 \end{pmatrix} = \begin{pmatrix} 0.375 \\ 0.148 \\ 53.078 \end{pmatrix} \quad \text{Ans.}$$

$$\gamma_1(x_1, x_2) := \exp \left[ x_2^2 \cdot \left[ A_{12} + 2 \cdot (A_{21} - A_{12}) \cdot x_1 \right] \right]$$

$$\gamma_2(x_1, x_2) := \exp \left[ x_1^2 \cdot \left[ A_{21} + 2 \cdot (A_{12} - A_{21}) \cdot x_2 \right] \right]$$

$$P_{\text{calc}_i} := x_{1_i} \cdot \gamma_1(x_{1_i}, x_{2_i}) \cdot \frac{H_1}{\exp(A_{12})} + x_{2_i} \cdot \gamma_2(x_{1_i}, x_{2_i}) \cdot P_{\text{sat}2}$$

$$y_{1\text{calc}_i} := \frac{x_{1_i} \cdot \gamma_1(x_{1_i}, x_{2_i}) \cdot \frac{H_1}{\exp(A_{12})}}{P_{\text{calc}_i}}$$



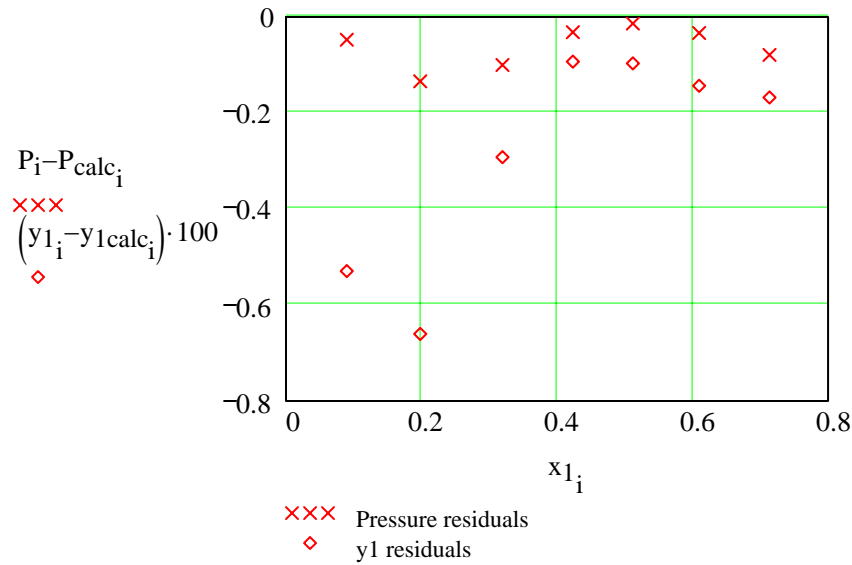

#### 14.5 Pressures in kPa

<b>Data:</b>	$x_1 := \begin{pmatrix} 0.3193 \\ 0.4232 \\ 0.5119 \\ 0.6096 \\ 0.7135 \\ 0.7934 \\ 0.9102 \\ 1.000 \end{pmatrix}$	$P := \begin{pmatrix} 21.63 \\ 24.01 \\ 25.92 \\ 27.96 \\ 30.12 \\ 31.75 \\ 34.15 \\ 36.09 \end{pmatrix}$	$y_1 := \begin{pmatrix} 0.5934 \\ 0.6815 \\ 0.7440 \\ 0.8050 \\ 0.8639 \\ 0.9048 \\ 0.9590 \\ 1.000 \end{pmatrix}$
--------------	--	---	--

$$i := 1..7$$

$$x_2 := 1 - x_1$$

$$P_{\text{sat}_1} := P_8$$

(a) It follows immediately from Eq. (12.10a) that:

$$\ln(\gamma_2^\infty) = A_{21}$$

Combining this with Eq. (12.10a) yields the required expression.

(b) Henry's constant will be found as part of the solution to Part (c).

(c) **BARKER'S METHOD** by non-linear least squares.  
**Margules equation.**

The most satisfactory procedure for reduction of this set of data is to find the value of Henry's constant by regression along with the Margules parameters.

$$\gamma_1(x_1, x_2, A_{12}, A_{21}) := \exp\left[ (x_2)^2 \cdot [A_{12} + 2 \cdot (A_{21} - A_{12}) \cdot x_1] \right]$$

$$\gamma_2(x_1, x_2, A_{12}, A_{21}) := \exp\left[ (x_1)^2 \cdot [A_{21} + 2 \cdot (A_{12} - A_{21}) \cdot x_2] \right]$$

**Guesses:**       $H_2 := 14$        $A_{21} := 0.148$        $A_{12} := 0.375$

**Minimize the sums of the squared errors by setting sums of derivatives equal to zero.**

$$\text{Given } 0 = \sum_i \left[ \frac{d}{dA_{12}} \left[ P_i - \left( x_{1_i} \cdot \gamma_1(x_{1_i}, x_{2_i}, A_{12}, A_{21}) \cdot P_{\text{sat}1} \dots \right) \cdot \frac{H_2}{\exp(A_{21})} \right] \right]^2$$

$$0 = \sum_i \left[ \frac{d}{dA_{21}} \left[ P_i - \left( x_{1_i} \cdot \gamma_1(x_{1_i}, x_{2_i}, A_{12}, A_{21}) \cdot P_{\text{sat}1} \dots \right) \cdot \frac{H_2}{\exp(A_{21})} \right] \right]^2$$

$$0 = \sum_i \left[ \frac{d}{dH_2} \left[ P_i - \left( x_{1_i} \cdot \gamma_1(x_{1_i}, x_{2_i}, A_{12}, A_{21}) \cdot P_{\text{sat}1} \dots \right) \cdot \frac{H_2}{\exp(A_{21})} \right] \right]^2$$

$$\begin{pmatrix} A_{12} \\ A_{21} \\ H_2 \end{pmatrix} := \text{Find}(A_{12}, A_{21}, H_2) \qquad \begin{pmatrix} A_{12} \\ A_{21} \\ H_2 \end{pmatrix} = \begin{pmatrix} 0.469 \\ 0.279 \\ 14.87 \end{pmatrix} \qquad \text{Ans.}$$

(d)  $\gamma_1(x_1, x_2) := \exp\left[ x_2^2 \cdot [A_{12} + 2 \cdot (A_{21} - A_{12}) \cdot x_1] \right]$

$\gamma_2(x_1, x_2) := \exp\left[ x_1^2 \cdot [A_{21} + 2 \cdot (A_{12} - A_{21}) \cdot x_2] \right]$

$$P_{\text{calc}_i} := x_{1_i} \cdot \gamma_1(x_{1_i}, x_{2_i}) \cdot P_{\text{sat}_1} + x_{2_i} \cdot \gamma_2(x_{1_i}, x_{2_i}) \cdot \frac{H_2}{\exp(A_{21})}$$

$$y_{1\text{calc}_i} := \frac{x_{1_i} \cdot \gamma_1(x_{1_i}, x_{2_i}) \cdot P_{\text{sat}_1}}{P_{\text{calc}_i}}$$

The plot of residuals below shows that the procedure used (Barker's method with regression for H2) is not in this case very satisfactory, no doubt because the data do not extend close enough to  $x_1 = 0$ .

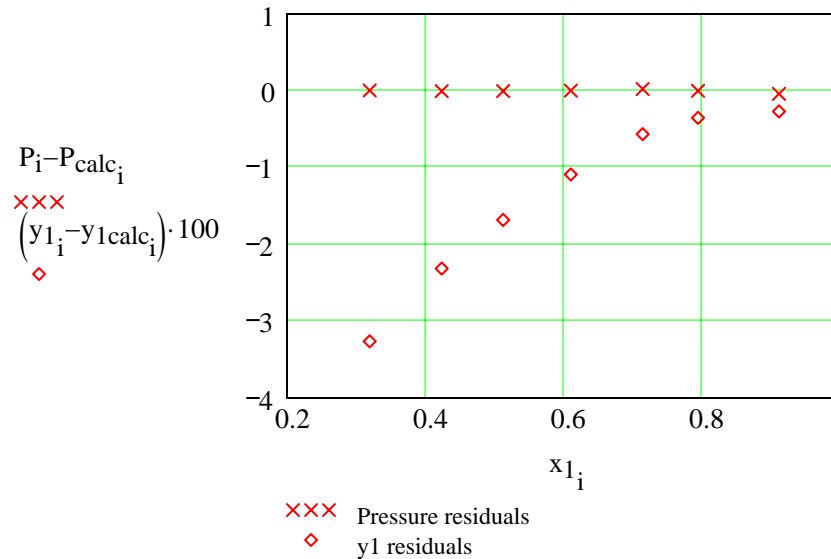

**Fit GE/RT data to Margules eqn. by least squares:**

$$i := 1..7$$

$$y_2 := 1 - y_1$$

Given

$$0 = \sum_i \frac{d}{dA_{12}} \left[ \left( \begin{array}{c} x_{1_i} \cdot \ln \left( \frac{y_{1_i} \cdot P_i}{x_{1_i} \cdot P_{\text{sat}_1}} \right) \dots \\ + x_{2_i} \cdot \ln \left( \frac{y_{2_i} \cdot P_i}{x_{2_i} \cdot \frac{H_2}{\exp(A_{21})}} \right) \end{array} \right) - \left( \begin{array}{c} A_{21} \cdot x_{1_i} \dots \\ + A_{12} \cdot x_{2_i} \end{array} \right) \cdot x_{1_i} \cdot x_{2_i} \right]^2$$

$$0 = \sum_i \frac{d}{dA_{21}} \left[ \left( x_{1_i} \cdot \ln \left( \frac{y_{1_i} \cdot P_i}{x_{1_i} \cdot P_{sat1}} \right) \dots \right) - \left( A_{21} \cdot x_{1_i} \dots \right) \cdot x_{1_i} \cdot x_{2_i} \right]^2$$

$$+ x_{2_i} \cdot \ln \left( \frac{y_{2_i} \cdot P_i}{x_{2_i} \cdot \exp(A_{21})} \right) \left( + A_{12} \cdot x_{2_i} \right)$$

$$0 = \sum_i \frac{d}{dH_2} \left[ \left( x_{1_i} \cdot \ln \left( \frac{y_{1_i} \cdot P_i}{x_{1_i} \cdot P_{sat1}} \right) \dots \right) - \left( A_{21} \cdot x_{1_i} \dots \right) \cdot x_{1_i} \cdot x_{2_i} \right]^2$$

$$+ x_{2_i} \cdot \ln \left( \frac{y_{2_i} \cdot P_i}{x_{2_i} \cdot \exp(A_{21})} \right) \left( + A_{12} \cdot x_{2_i} \right)$$

$$\begin{pmatrix} A_{12} \\ A_{21} \\ H_2 \end{pmatrix} := \text{Find}(A_{12}, A_{21}, H_2) \quad \begin{pmatrix} A_{12} \\ A_{21} \\ H_2 \end{pmatrix} = \begin{pmatrix} 0.37 \\ 0.204 \\ 15.065 \end{pmatrix} \quad \text{Ans.}$$

$$\gamma_1(x_1, x_2) := \exp \left[ x_2^2 \cdot \left[ A_{12} + 2 \cdot (A_{21} - A_{12}) \cdot x_1 \right] \right]$$

$$\gamma_2(x_1, x_2) := \exp \left[ x_1^2 \cdot \left[ A_{21} + 2 \cdot (A_{12} - A_{21}) \cdot x_2 \right] \right]$$

$$P_{calc_i} := x_{1_i} \cdot \gamma_1(x_{1_i}, x_{2_i}) \cdot P_{sat1} + x_{2_i} \cdot \gamma_2(x_{1_i}, x_{2_i}) \cdot \frac{H_2}{\exp(A_{21})}$$

$$y_{1calc_i} := \frac{x_{1_i} \cdot \gamma_1(x_{1_i}, x_{2_i}) \cdot P_{sat1}}{P_{calc_i}}$$

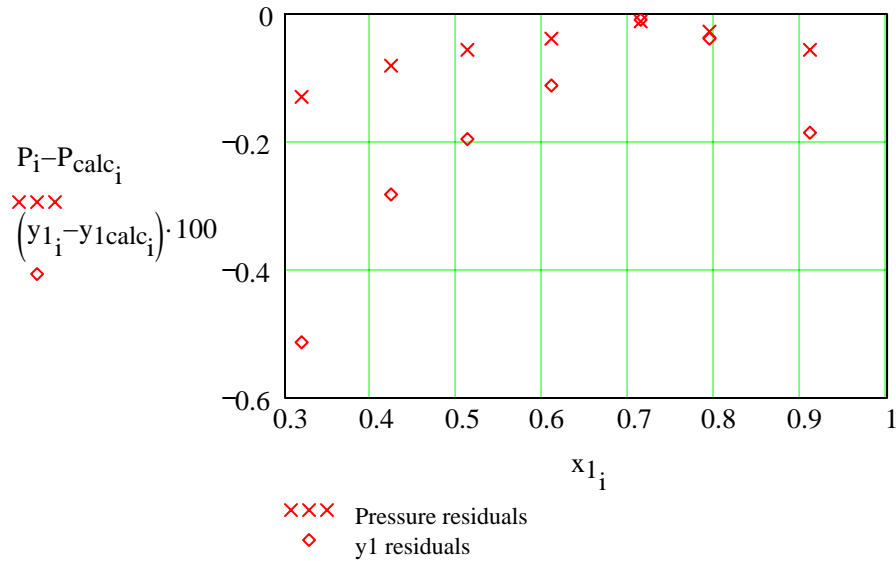

This result is considerably improved over that obtained with Barker's method.

#### 14.6 Pressures in kPa

Data:

$P :=$	$\begin{pmatrix} 15.79 \\ 17.51 \\ 18.15 \\ 19.30 \\ 19.89 \\ 21.37 \\ 24.95 \\ 29.82 \\ 34.80 \\ 42.10 \end{pmatrix}$	$x_1 :=$	$\begin{pmatrix} 0.0 \\ 0.0932 \\ 0.1248 \\ 0.1757 \\ 0.2000 \\ 0.2626 \\ 0.3615 \\ 0.4750 \\ 0.5555 \\ 0.6718 \end{pmatrix}$	$y_1 :=$	$\begin{pmatrix} 0.0 \\ 0.1794 \\ 0.2383 \\ 0.3302 \\ 0.3691 \\ 0.4628 \\ 0.6184 \\ 0.7552 \\ 0.8378 \\ 0.9137 \end{pmatrix}$
--------	--	----------	---	----------	---

$$i := 2 \dots \text{rows}(P)$$

$$x_2 := 1 - x_1$$

$$P_{\text{sat}2} := P_1$$

(a) It follows immediately from Eq. (12.10a) that:

$$\ln(\gamma_1^\infty) = A_{12}$$

Combining this with Eq. (12.10a) yields the required expression

(b) Henry's constant will be found as part of the solution to Part (c)

(c) **BARKER'S METHOD** by non-linear least squares.  
**Margules equation.**

The most satisfactory procedure for reduction of this set of data is to find the value of Henry's constant by regression along with the Margules parameters.

$$\gamma_1(x_1, x_2, A_{12}, A_{21}) := \exp\left[(x_2)^2 \cdot [A_{12} + 2 \cdot (A_{21} - A_{12}) \cdot x_1]\right]$$

$$\gamma_2(x_1, x_2, A_{12}, A_{21}) := \exp\left[(x_1)^2 \cdot [A_{21} + 2 \cdot (A_{12} - A_{21}) \cdot x_2]\right]$$

**Guesses:**       $H_1 := 35$        $A_{21} := -1.27$        $A_{12} := -0.70$

**Minimize the sums of the squared errors by setting sums of derivatives equal to zero.**

Given

$$0 = \sum_i \left[ \frac{d}{dA_{12}} \left[ P_i - \left( \begin{array}{l} x_{1_i} \cdot \gamma_1(x_{1_i}, x_{2_i}, A_{12}, A_{21}) \cdot \frac{H_1}{\exp(A_{12})} \dots \\ + x_{2_i} \cdot \gamma_2(x_{1_i}, x_{2_i}, A_{12}, A_{21}) \cdot P_{sat2} \end{array} \right) \right]^2 \right]$$

$$0 = \sum_i \left[ \frac{d}{dA_{21}} \left[ P_i - \left( \begin{array}{l} x_{1_i} \cdot \gamma_1(x_{1_i}, x_{2_i}, A_{12}, A_{21}) \cdot \frac{H_1}{\exp(A_{12})} \dots \\ + x_{2_i} \cdot \gamma_2(x_{1_i}, x_{2_i}, A_{12}, A_{21}) \cdot P_{sat2} \end{array} \right) \right]^2 \right]$$

$$0 = \sum_i \left[ \frac{d}{dH_1} \left[ P_i - \left( \begin{array}{l} x_{1_i} \cdot \gamma_1(x_{1_i}, x_{2_i}, A_{12}, A_{21}) \cdot \frac{H_1}{\exp(A_{12})} \dots \\ + x_{2_i} \cdot \gamma_2(x_{1_i}, x_{2_i}, A_{12}, A_{21}) \cdot P_{sat2} \end{array} \right) \right]^2 \right]$$

$$\begin{pmatrix} A_{12} \\ A_{21} \\ H_1 \end{pmatrix} := \text{Find}(A_{12}, A_{21}, H_1) \quad \begin{pmatrix} A_{12} \\ A_{21} \\ H_1 \end{pmatrix} = \begin{pmatrix} -0.731 \\ -1.187 \\ 32.065 \end{pmatrix} \quad \text{Ans.}$$

$$\begin{aligned}
 \text{(d)} \quad \gamma_1(x_1, x_2) &:= \exp\left[x_2^2 \cdot [A_{12} + 2 \cdot (A_{21} - A_{12}) \cdot x_1]\right] \\
 \gamma_2(x_1, x_2) &:= \exp\left[x_1^2 \cdot [A_{21} + 2 \cdot (A_{12} - A_{21}) \cdot x_2]\right] \\
 P_{\text{calc}_i} &:= x_{1_i} \cdot \gamma_1(x_{1_i}, x_{2_i}) \cdot \frac{H_1}{\exp(A_{12})} + x_{2_i} \cdot \gamma_2(x_{1_i}, x_{2_i}) \cdot P_{\text{sat}_2} \\
 y_{1\text{calc}_i} &:= \frac{x_{1_i} \cdot \gamma_1(x_{1_i}, x_{2_i}) \cdot \frac{H_1}{\exp(A_{12})}}{P_{\text{calc}_i}}
 \end{aligned}$$

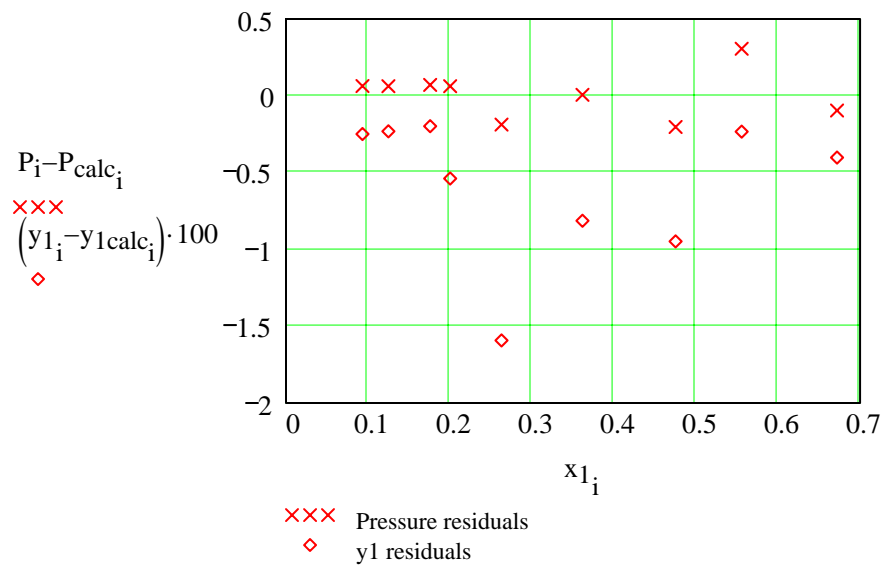

**Fit GE/RT data to Margules eqn. by least squares:**

$$i := 2 \dots \text{rows}(P) \quad y_2 := 1 - y_1$$

Given

$$0 = \sum_i \frac{d}{dA_{12}} \left[ \left( \begin{array}{c} x_{1_i} \cdot \ln \left( \frac{y_{1_i} \cdot P_i}{H_1} \right) \dots \\ \left( \frac{x_{1_i} \cdot \exp(A_{12})}{x_{2_i} \cdot P_{\text{sat}_2}} \right) \\ + x_{2_i} \cdot \ln \left( \frac{y_{2_i} \cdot P_i}{x_{2_i} \cdot P_{\text{sat}_2}} \right) \end{array} \right) - \left( \begin{array}{c} A_{21} \cdot x_{1_i} \dots \\ + A_{12} \cdot x_{2_i} \end{array} \right) \cdot x_{1_i} \cdot x_{2_i} \right]^2$$

$$0 = \sum_i \frac{d}{dA_{21}} \left[ \left( x_{1_i} \cdot \ln \left( \frac{y_{1_i} \cdot P_i}{H_1} \right) \right) \dots - \left( A_{21} \cdot x_{1_i} \dots \right) \cdot x_{1_i} \cdot x_{2_i} \right]^2$$

$$+ x_{2_i} \cdot \ln \left( \frac{y_{2_i} \cdot P_i}{x_{2_i} \cdot P_{sat2}} \right)$$

$$0 = \sum_i \frac{d}{dH_1} \left[ \left( x_{1_i} \cdot \ln \left( \frac{y_{1_i} \cdot P_i}{H_1} \right) \right) \dots - \left( A_{21} \cdot x_{1_i} \dots \right) \cdot x_{1_i} \cdot x_{2_i} \right]^2$$

$$+ x_{2_i} \cdot \ln \left( \frac{y_{2_i} \cdot P_i}{x_{2_i} \cdot P_{sat2}} \right)$$

$$\begin{pmatrix} A_{12} \\ A_{21} \\ H_1 \end{pmatrix} := \text{Find}(A_{12}, A_{21}, H_1) \quad \begin{pmatrix} A_{12} \\ A_{21} \\ H_1 \end{pmatrix} = \begin{pmatrix} -0.707 \\ -1.192 \\ 33.356 \end{pmatrix} \quad \text{Ans.}$$

$$\gamma_1(x_1, x_2) := \exp \left[ x_2^2 \cdot \left[ A_{12} + 2 \cdot (A_{21} - A_{12}) \cdot x_1 \right] \right]$$

$$\gamma_2(x_1, x_2) := \exp \left[ x_1^2 \cdot \left[ A_{21} + 2 \cdot (A_{12} - A_{21}) \cdot x_2 \right] \right]$$

$$P_{calc_i} := x_{1_i} \cdot \gamma_1(x_{1_i}, x_{2_i}) \cdot \frac{H_1}{\exp(A_{12})} + x_{2_i} \cdot \gamma_2(x_{1_i}, x_{2_i}) \cdot P_{sat2}$$

$$y_{1calc_i} := \frac{x_{1_i} \cdot \gamma_1(x_{1_i}, x_{2_i}) \cdot \frac{H_1}{\exp(A_{12})}}{P_{calc_i}}$$



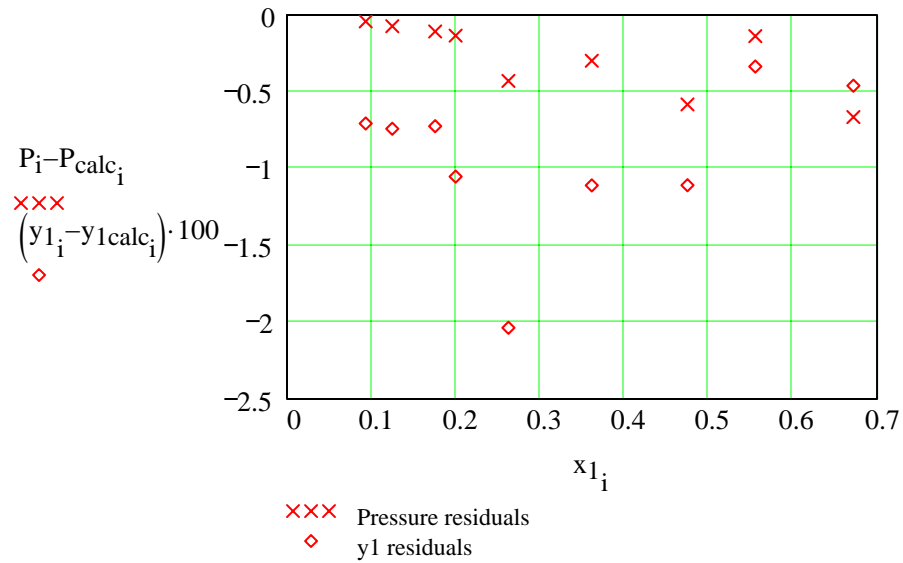

### 14.7 Pressures in kPa

<b>Data:</b>	$x_1 := \begin{pmatrix} 0.1757 \\ 0.2000 \\ 0.2626 \\ 0.3615 \\ 0.4750 \\ 0.5555 \\ 0.6718 \\ 0.8780 \\ 0.9398 \\ 1.0000 \end{pmatrix}$	$P := \begin{pmatrix} 19.30 \\ 19.89 \\ 21.37 \\ 24.95 \\ 29.82 \\ 34.80 \\ 42.10 \\ 60.38 \\ 65.39 \\ 69.36 \end{pmatrix}$	$y_1 := \begin{pmatrix} 0.3302 \\ 0.3691 \\ 0.4628 \\ 0.6184 \\ 0.7552 \\ 0.8378 \\ 0.9137 \\ 0.9860 \\ 0.9945 \\ 1.0000 \end{pmatrix}$
	$x_2 := 1 - x_1$		$P_{sat1} := P_{10}$

(a) It follows immediately from Eq. (12.10a) that:

$$\ln(\gamma_2^\infty) = A_{21}$$

Combining this with Eq. (12.10a) yields the required expression.

(b) Henry's constant will be found as part of the solution to Part (c).

- (c) **BARKER'S METHOD** by non-linear least squares.  
**Margules equation.**

The most satisfactory procedure for reduction of this set of data is to find the value of Henry's constant by regression along with the Margules parameters.

$$\gamma_1(x_1, x_2, A_{12}, A_{21}) := \exp\left[(x_2)^2 \cdot [A_{12} + 2 \cdot (A_{21} - A_{12}) \cdot x_1]\right]$$

$$\gamma_2(x_1, x_2, A_{12}, A_{21}) := \exp\left[(x_1)^2 \cdot [A_{21} + 2 \cdot (A_{12} - A_{21}) \cdot x_2]\right]$$

**Guesses:**       $H_2 := 4$        $A_{21} := -1.37$        $A_{12} := -0.68$

**Minimize the sums of the squared errors by setting sums of derivatives equal to zero.**

Given

$$0 = \sum_i \left[ \frac{d}{dA_{12}} \left[ P_i - \left( x_{1_i} \cdot \gamma_1(x_{1_i}, x_{2_i}, A_{12}, A_{21}) \cdot P_{\text{sat}1} \dots \right) \right]^2 \right]$$

$$0 = \sum_i \left[ \frac{d}{dA_{21}} \left[ P_i - \left( x_{1_i} \cdot \gamma_1(x_{1_i}, x_{2_i}, A_{12}, A_{21}) \cdot P_{\text{sat}1} \dots \right) \right]^2 \right]$$

$$0 = \sum_i \left[ \frac{d}{dH_2} \left[ P_i - \left( x_{1_i} \cdot \gamma_1(x_{1_i}, x_{2_i}, A_{12}, A_{21}) \cdot P_{\text{sat}1} \dots \right) \right]^2 \right]$$

$$\begin{pmatrix} A_{12} \\ A_{21} \\ H_2 \end{pmatrix} := \text{Find}(A_{12}, A_{21}, H_2)$$

$$\begin{pmatrix} A_{12} \\ A_{21} \\ H_2 \end{pmatrix} = \begin{pmatrix} -0.679 \\ -1.367 \\ 3.969 \end{pmatrix} \quad \text{Ans.}$$

$$(d) \quad \gamma_1(x_1, x_2) := \exp\left[x_2^2 \cdot [A_{12} + 2 \cdot (A_{21} - A_{12}) \cdot x_1]\right]$$

$$\gamma_2(x_1, x_2) := \exp\left[x_1^2 \cdot [A_{21} + 2 \cdot (A_{12} - A_{21}) \cdot x_2]\right]$$

$$P_{\text{calc}_i} := x_{1_i} \cdot \gamma_1(x_{1_i}, x_{2_i}) \cdot P_{\text{sat}_1} + x_{2_i} \cdot \gamma_2(x_{1_i}, x_{2_i}) \cdot \frac{H_2}{\exp(A_{21})}$$

$$y_{1\text{calc}_i} := \frac{x_{1_i} \cdot \gamma_1(x_{1_i}, x_{2_i}) \cdot P_{\text{sat}_1}}{P_{\text{calc}_i}}$$

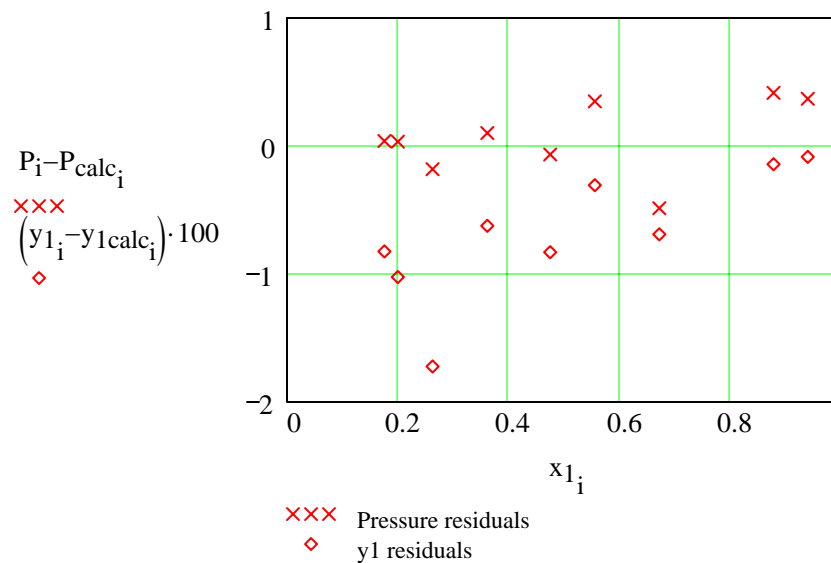

**Fit GE/RT data to Margules eqn. by least squares:**

$$i := 1..9$$

$$y_2 := 1 - y_1$$

$$\text{Given} \quad 0 = \sum_i \frac{d}{dA_{12}} \left[ \left( \begin{array}{c} x_{1_i} \cdot \ln \left( \frac{y_{1_i} \cdot P_i}{x_{1_i} \cdot P_{\text{sat}_1}} \right) \dots \\ + x_{2_i} \cdot \ln \left( \frac{y_{2_i} \cdot P_i}{\frac{H_2}{x_{2_i} \cdot \exp(A_{21})}} \right) \end{array} \right) - \left( \begin{array}{c} A_{21} \cdot x_{1_i} \dots \\ + A_{12} \cdot x_{2_i} \end{array} \right) \cdot x_{1_i} \cdot x_{2_i} \right]^2$$

$$0 = \sum_i \frac{d}{dA_{21}} \left[ \left( x_{1_i} \cdot \ln \left( \frac{y_{1_i} \cdot P_i}{x_{1_i} \cdot P_{sat1}} \right) \dots \right) - \left( A_{21} \cdot x_{1_i} \dots \right) \cdot x_{1_i} \cdot x_{2_i} \right]^2$$

$$+ x_{2_i} \cdot \ln \left( \frac{y_{2_i} \cdot P_i}{H_2} \right) \left( x_{2_i} \cdot \frac{H_2}{\exp(A_{21})} \right) + A_{12} \cdot x_{2_i}$$

$$0 = \sum_i \frac{d}{dH_2} \left[ \left( x_{1_i} \cdot \ln \left( \frac{y_{1_i} \cdot P_i}{x_{1_i} \cdot P_{sat1}} \right) \dots \right) - \left( A_{21} \cdot x_{1_i} \dots \right) \cdot x_{1_i} \cdot x_{2_i} \right]^2$$

$$+ x_{2_i} \cdot \ln \left( \frac{y_{2_i} \cdot P_i}{H_2} \right) \left( x_{2_i} \cdot \frac{H_2}{\exp(A_{21})} \right) + A_{12} \cdot x_{2_i}$$

$$\begin{pmatrix} A_{12} \\ A_{21} \\ H_2 \end{pmatrix} := \text{Find}(A_{12}, A_{21}, H_2) \quad \begin{pmatrix} A_{12} \\ A_{21} \\ H_2 \end{pmatrix} = \begin{pmatrix} -0.845 \\ -1.229 \\ 4.703 \end{pmatrix} \quad \text{Ans.}$$

$$\gamma_1(x_1, x_2) := \exp \left[ x_2^2 \cdot \left[ A_{12} + 2 \cdot (A_{21} - A_{12}) \cdot x_1 \right] \right]$$

$$\gamma_2(x_1, x_2) := \exp \left[ x_1^2 \cdot \left[ A_{21} + 2 \cdot (A_{12} - A_{21}) \cdot x_2 \right] \right]$$

$$P_{calc_i} := x_{1_i} \cdot \gamma_1(x_{1_i}, x_{2_i}) \cdot P_{sat1} + x_{2_i} \cdot \gamma_2(x_{1_i}, x_{2_i}) \cdot \frac{H_2}{\exp(A_{21})}$$

$$y_{1calc_i} := \frac{x_{1_i} \cdot \gamma_1(x_{1_i}, x_{2_i}) \cdot P_{sat1}}{P_{calc_i}}$$

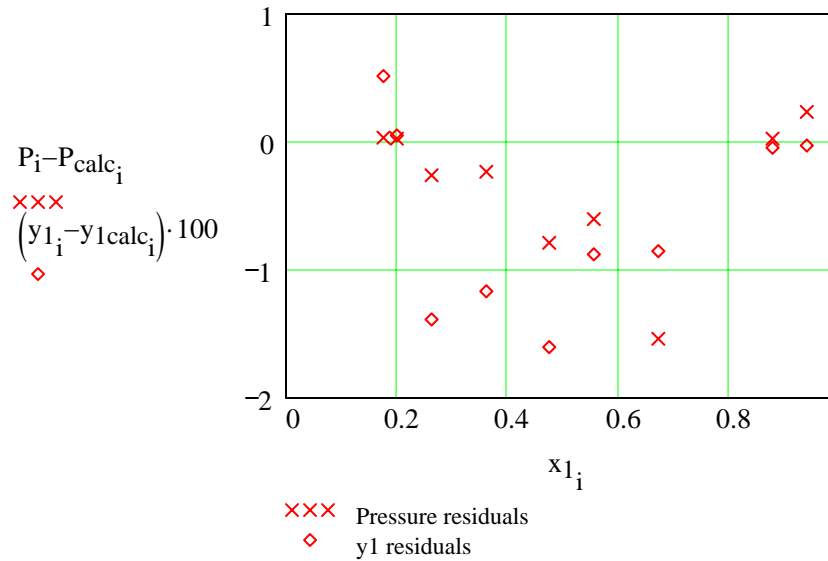

**14.8 (a) Data from Table 12.1**

$P := \begin{pmatrix} 15.51 \\ 18.61 \\ 21.63 \\ 24.01 \\ 25.92 \\ 27.96 \\ 30.12 \\ 31.75 \\ 34.15 \end{pmatrix} \text{ kPa}$	$x_1 := \begin{pmatrix} 0.0895 \\ 0.1981 \\ 0.3193 \\ 0.4232 \\ 0.5119 \\ 0.6096 \\ 0.7135 \\ 0.7934 \\ 0.9102 \end{pmatrix}$	$y_1 := \begin{pmatrix} 0.2716 \\ 0.4565 \\ 0.5934 \\ 0.6815 \\ 0.7440 \\ 0.8050 \\ 0.8639 \\ 0.9048 \\ 0.9590 \end{pmatrix}$	$\gamma_1 := \begin{pmatrix} 1.304 \\ 1.188 \\ 1.114 \\ 1.071 \\ 1.044 \\ 1.023 \\ 1.010 \\ 1.003 \\ 0.997 \end{pmatrix}$	$\gamma_2 := \begin{pmatrix} 1.009 \\ 1.026 \\ 1.050 \\ 1.078 \\ 1.105 \\ 1.135 \\ 1.163 \\ 1.189 \\ 1.268 \end{pmatrix}$
--	---	---	---	---

$n := \text{rows}(P) \quad n = 9 \quad i := 1..n \quad x_{2_i} := 1 - x_{1_i} \quad y_{2_i} := 1 - y_{1_i}$   
 $\text{Psat}_1 := 36.09 \text{ kPa} \quad \text{Psat}_2 := 12.30 \text{ kPa} \quad T := (50 + 273.15) \text{ K}$

**Data reduction with the Margules equation and Eq. (10.5):**

$$\gamma_{1_i} := \frac{y_{1_i} \cdot P_i}{x_{1_i} \cdot \text{Psat}_1} \quad \gamma_{2_i} := \frac{y_{2_i} \cdot P_i}{x_{2_i} \cdot \text{Psat}_2}$$

$$i := 1..n \quad \text{GERT}_i := x_{1_i} \cdot \ln(\gamma_{1_i}) + x_{2_i} \cdot \ln(\gamma_{2_i})$$

**Guess:**  $A_{12} := 0.1 \quad A_{21} := 0.3$

$$f(A_{12}, A_{21}) := \sum_{i=1}^n \left[ \text{GERT}_i - (A_{21} \cdot x_{1_i} + A_{12} \cdot x_{2_i}) \cdot x_{1_i} \cdot x_{2_i} \right]^2$$

$$\begin{pmatrix} A_{12} \\ A_{21} \end{pmatrix} := \text{Minimize}(f, A_{12}, A_{21}) \quad \boxed{A_{12} = 0.374} \quad \boxed{A_{21} = 0.197} \quad \text{Ans.}$$

**RMS Error:**  $\text{RMS} := \sqrt{\frac{\sum_{i=1}^n \left[ \text{GERT}_i - (A_{21} \cdot x_{1_i} + A_{12} \cdot x_{2_i}) \cdot x_{1_i} \cdot x_{2_i} \right]^2}{n}}$

$\boxed{\text{RMS} = 1.033 \times 10^{-3}}$   $x_1 := 0, 0.01..1$

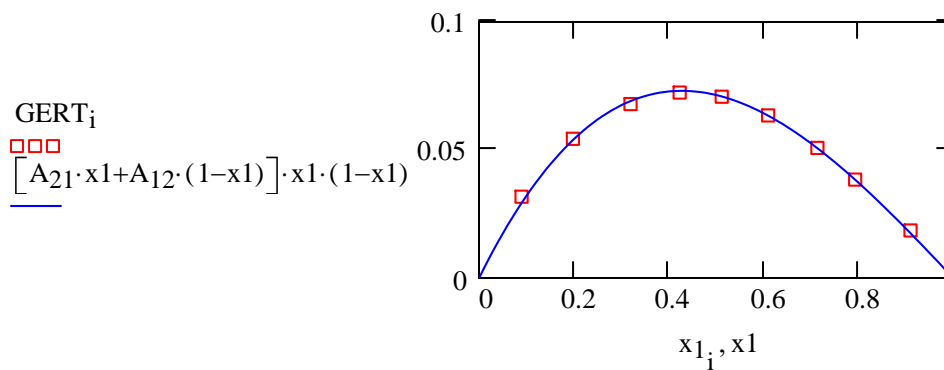

**Data reduction with the Margules equation and Eq. (14.1):**

$$\boxed{B_{11} := -1840 \frac{\text{cm}^3}{\text{mol}}}$$

$$\boxed{B_{22} := -1800 \frac{\text{cm}^3}{\text{mol}}}$$

$$\boxed{B_{12} := -1150 \frac{\text{cm}^3}{\text{mol}}}$$

$$\delta_{12} := 2 \cdot B_{12} - B_{11} - B_{22}$$

$$\Phi_{1_i} := \exp \left[ \frac{[B_{11} \cdot (P_i - P_{\text{sat}_1}) + P_i \cdot (y_{2_i})^2 \cdot \delta_{12}]}{R \cdot T} \right] \quad \gamma_{1_i} := \frac{y_{1_i} \cdot \Phi_{1_i} \cdot P_i}{x_{1_i} \cdot P_{\text{sat}_1}}$$

$$\Phi_{2_i} := \exp\left[\frac{B_{22} \cdot (P_i - P_{\text{sat}2}) + P_i \cdot (y_{1_i})^2 \cdot \delta_{12}}{R \cdot T}\right] \quad \gamma_{2_i} := \frac{y_{2_i} \cdot \Phi_{2_i} \cdot P_i}{x_{2_i} \cdot P_{\text{sat}2}}$$

$$i := 1..n \quad \text{GERT}_i := x_{1_i} \cdot \ln(\gamma_{1_i}) + x_{2_i} \cdot \ln(\gamma_{2_i})$$

**Guess:**  $A_{12} := 0.1 \quad A_{21} := 0.3$

$$f(A_{12}, A_{21}) := \sum_{i=1}^n \left[ \text{GERT}_i - (A_{21} \cdot x_{1_i} + A_{12} \cdot x_{2_i}) \cdot x_{1_i} \cdot x_{2_i} \right]^2$$

$$\begin{pmatrix} A_{12} \\ A_{21} \end{pmatrix} := \text{Minimize}(f, A_{12}, A_{21}) \quad \mathbf{A_{12} = 0.379} \quad \mathbf{A_{21} = 0.216} \quad \text{Ans.}$$

**RMS Error:**  $\text{RMS} := \sqrt{\frac{\sum_{i=1}^n \left[ \text{GERT}_i - (A_{21} \cdot x_{1_i} + A_{12} \cdot x_{2_i}) \cdot x_{1_i} \cdot x_{2_i} \right]^2}{n}}$

$\mathbf{\text{RMS} = 9.187 \times 10^{-4}}$   $x_1 := 0, 0.01..1$

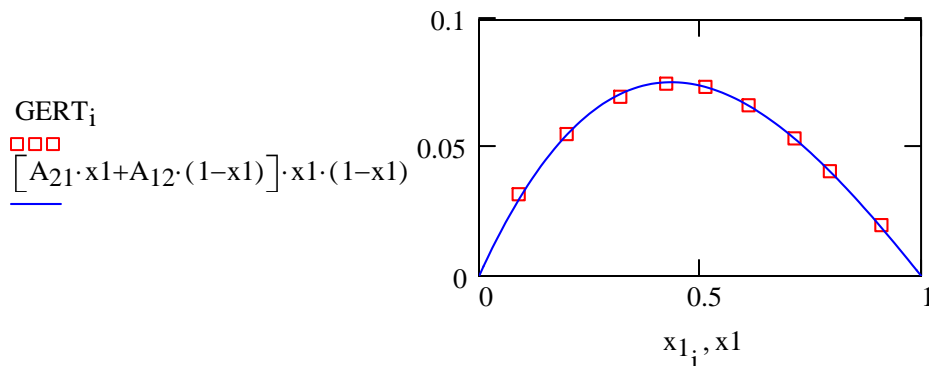

The RMS error with Eqn. (14.1) is about 11% lower than the RMS error with Eqn. (10.5).

**Note:** The following problem was solved with the temperature (T) set at the normal boiling point. To solve for another temperature, simply change T to the appropriate value.

14.9 (a) Acetylene:  $T_c := 308.3\text{K}$   $P_c := 61.39\text{bar}$   $T_n := 189.4\text{K}$

$$T := T_n \quad T_r := \frac{T}{T_c} \quad T_r = 0.614$$

For Redlich/Kwong EOS:

$$\sigma := 1 \quad \varepsilon := 0 \quad \Omega := 0.08664 \quad \Psi := 0.42748 \quad \text{Table 3.1}$$

$$\alpha(T_r) := T_r^{-1} \quad \text{Table 3.1} \quad a(T_r) := \Psi \cdot \frac{\alpha(T_r) \cdot R^2 \cdot T_c^2}{P_c} \quad \text{Eq. (3.45)}$$

$$q(T_r) := \frac{\Psi \cdot \alpha(T_r)}{\Omega \cdot T_r} \quad \text{Eq. (3.54)} \quad \beta(T_r, P_r) := \frac{\Omega \cdot P_r}{T_r} \quad \text{Eq. (3.53)}$$

Define Z for the vapor (Zv)      Guess:       $z_v := 0.9$

Given      Eq. (3.52)

$$z_v = 1 + \beta(T_r, P_r) - q(T_r) \cdot \beta(T_r, P_r) \cdot \frac{z_v - \beta(T_r, P_r)}{(z_v + \varepsilon \cdot \beta(T_r, P_r)) \cdot (z_v + \sigma \cdot \beta(T_r, P_r))}$$

$$Z_v(T_r, P_r) := \text{Find}(z_v)$$

Define Z for the liquid (Zl)      Guess:       $z_l := 0.01$

Given      Eq. (3.56)

$$z_l = \beta(T_r, P_r) + (z_l + \varepsilon \cdot \beta(T_r, P_r)) \cdot (z_l + \sigma \cdot \beta(T_r, P_r)) \cdot \left( \frac{1 + \beta(T_r, P_r) - z_l}{q(T_r) \cdot \beta(T_r, P_r)} \right)$$

To find liquid root, restrict search for zl to values less than 0.2,  $z_l < 0.2$

$$Z_l(T_r, P_r) := \text{Find}(z_l)$$

Define I for liquid (Il) and vapor (Iv)

$$I_l(T_r, P_r) := \frac{1}{\sigma - \varepsilon} \cdot \ln \left( \frac{Z_l(T_r, P_r) + \sigma \cdot \beta(T_r, P_r)}{Z_l(T_r, P_r) + \varepsilon \cdot \beta(T_r, P_r)} \right)$$

$$I_v(T_r, P_r) := \frac{1}{\sigma - \varepsilon} \cdot \ln \left( \frac{Z_v(T_r, P_r) + \sigma \cdot \beta(T_r, P_r)}{Z_v(T_r, P_r) + \varepsilon \cdot \beta(T_r, P_r)} \right) \quad \text{Eq. (6.65b)}$$



$$\ln\phi(T_r, P_r) := Z_l(T_r, P_r) - 1 - \ln(Z_l(T_r, P_r) - \beta(T_r, P_r)) - q(T_r) \cdot \Pi(T_r, P_r) \quad \text{Eq. (11.37)}$$

$$\ln\phi_v(T_r, P_r) := Z_v(T_r, P_r) - 1 - \ln(Z_v(T_r, P_r) - \beta(T_r, P_r)) - q(T_r) \cdot I_v(T_r, P_r)$$

**Guess Psat:**  $P_{\text{sat}_r} := \frac{1 \text{ bar}}{P_c}$

Given  $\ln\phi(T_r, P_{\text{sat}_r}) = \ln\phi_v(T_r, P_{\text{sat}_r})$   $P_{\text{sat}_r} := \text{Find}(P_{\text{sat}_r})$

$P_{\text{sat}_r} = 0.026$   $Z_l(T_r, P_{\text{sat}_r}) = 4.742 \times 10^{-3}$   $Z_v(T_r, P_{\text{sat}_r}) = 0.965$

$P_{\text{sat}} := P_{\text{sat}_r} \cdot P_c$   $P_{\text{sat}} = 1.6 \text{ bar}$  **Ans.**

The following table lists answers for all parts. Literature values are interpolated from tables in Perry's Chemical Engineers' Handbook, 6th ed. The last column shows the percent difference between calculated and literature values at 0.85T<sub>c</sub>. These range from 0.1 to 27%. For the normal boiling point (T<sub>n</sub>), P<sub>sat</sub> should be 1.013 bar. Tabulated results for P<sub>sat</sub> do not agree well with this value. Differences range from 3 to > 100%.

	T <sub>n</sub> (K)	P <sub>sat</sub> (bar)	0.85 T <sub>c</sub> (K)	P <sub>sat</sub> (bar)	P <sub>sat</sub> (bar)	% Difference
		@ T <sub>n</sub>		@ 0.85 T <sub>c</sub>	Lit. Values	
Acetylene	189.4	1.60	262.1	20.27	19.78	2.5%
Argon	87.3	0.68	128.3	20.23	18.70	8.2%
Benzene	353.2	1.60	477.9	16.028	15.52	3.2%
n-Butane	272.7	1.52	361.3	14.35	12.07	18.9%
Carbon Monoxide	81.7	0.92	113.0	15.2	12.91	17.7%
n-Decane	447.3	2.44	525.0	6.633	5.21	27.3%
Ethylene	169.4	1.03	240.0	17.71	17.69	0.1%
n-Heptane	371.6	2.06	459.2	7.691	7.59	1.3%
Methane	111.4	0.71	162.0	19.39	17.33	11.9%
Nitrogen	77.3	0.86	107.3	14.67	12.57	16.7%

14.10 (a) Acetylene:  $\omega := 0.187$   $T_c := 308.3\text{K}$   $P_c := 61.39\text{bar}$   $T_n := 189.4\text{K}$

$T := T_n$  **Note: For solution at 0.85T<sub>c</sub>, set T := 0.85T<sub>c</sub>.**  $T_r := \frac{T}{T_c}$

For SRK EOS:

$T_r = 0.614$

$\sigma := 1$   $\varepsilon := 0$   $\Omega := 0.08664$   $\Psi := 0.42748$  **Table 3.1**

$$\alpha(T_r, \omega) := \left[ 1 + (0.480 + 1.574\omega - 0.176\omega^2) \cdot \left( 1 - T_r^{\frac{1}{2}} \right) \right]^2 \quad \text{Table 3.1}$$

$$a(T_r) := \Psi \cdot \frac{\alpha(T_r, \omega) \cdot R^2 \cdot T_c^2}{P_c} \quad \text{Eq. (3.45)}$$

$$q(T_r) := \frac{\Psi \cdot \alpha(T_r, \omega)}{\Omega \cdot T_r} \quad \text{Eq. (3.54)} \quad \beta(T_r, P_r) := \frac{\Omega \cdot P_r}{T_r} \quad \text{Eq. (3.53)}$$

**Define Z for the vapor (Zv)**      **Guess:**       $z_v := 0.9$

Given      **Eq. (3.52)**

$$z_v = 1 + \beta(T_r, P_r) - q(T_r) \cdot \beta(T_r, P_r) \cdot \frac{z_v - \beta(T_r, P_r)}{(z_v + \varepsilon \cdot \beta(T_r, P_r)) \cdot (z_v + \sigma \cdot \beta(T_r, P_r))}$$

$$Z_v(T_r, P_r) := \text{Find}(z_v)$$

**Define Z for the liquid (Zl)**      **Guess:**       $z_l := 0.01$

Given      **Eq. (3.56)**

$$z_l = \beta(T_r, P_r) + (z_l + \varepsilon \cdot \beta(T_r, P_r)) \cdot (z_l + \sigma \cdot \beta(T_r, P_r)) \cdot \left( \frac{1 + \beta(T_r, P_r) - z_l}{q(T_r) \cdot \beta(T_r, P_r)} \right)$$

**To find liquid root, restrict search for zl to values less than 0.2,  $z_l < 0.2$**

$$Z_l(T_r, P_r) := \text{Find}(z_l)$$

**Define I for liquid (Il) and vapor (Iv)**

$$I_l(T_r, P_r) := \frac{1}{\sigma - \varepsilon} \cdot \ln \left( \frac{Z_l(T_r, P_r) + \sigma \cdot \beta(T_r, P_r)}{Z_l(T_r, P_r) + \varepsilon \cdot \beta(T_r, P_r)} \right)$$

**Eq. (6.65b)**

$$I_v(T_r, P_r) := \frac{1}{\sigma - \varepsilon} \cdot \ln \left( \frac{Z_v(T_r, P_r) + \sigma \cdot \beta(T_r, P_r)}{Z_v(T_r, P_r) + \varepsilon \cdot \beta(T_r, P_r)} \right)$$

$$\ln\phi(T_r, P_r) := Z_l(T_r, P_r) - 1 - \ln(Z_l(T_r, P_r) - \beta(T_r, P_r)) - q(T_r) \cdot \Pi(T_r, P_r) \quad \text{Eq. (11.37)}$$

$$\ln\phi_v(T_r, P_r) := Z_v(T_r, P_r) - 1 - \ln(Z_v(T_r, P_r) - \beta(T_r, P_r)) - q(T_r) \cdot \text{Iv}(T_r, P_r)$$

**Guess Psat:**  $P_{\text{sat}_r} := \frac{2\text{bar}}{P_c}$

Given  $\ln\phi(T_r, P_{\text{sat}_r}) = \ln\phi_v(T_r, P_{\text{sat}_r})$   $P_{\text{sat}_r} := \text{Find}(P_{\text{sat}_r})$

$P_{\text{sat}_r} = 0.017$      $Z_l(T_r, P_{\text{sat}_r}) = 3.108 \times 10^{-3}$      $Z_v(T_r, P_{\text{sat}_r}) = 0.975$

$P_{\text{sat}} := P_{\text{sat}_r} \cdot P_c$      $P_{\text{sat}} = 1.073 \text{ bar}$     **Ans.**

The following table lists answers for all parts. Literature values are interpolated from tables in Perry's Chemical Engineers' Handbook, 6th ed. The last column shows the percent difference between calculated and literature values at 0.85T<sub>c</sub>. These range from less than 0.1 to 2.5%. For the normal boiling point (T<sub>n</sub>), P<sub>sat</sub> should be 1.013 bar. Tabulated results for P<sub>sat</sub> agree well with this value. Differences range from near 0 to 6%.

	T <sub>n</sub> (K)	P <sub>sat</sub> (bar) @ T <sub>n</sub>	0.85 T <sub>c</sub> (K)	P <sub>sat</sub> (bar) @ 0.85 T <sub>c</sub>	P <sub>sat</sub> (bar) Lit. Values	% Difference
Acetylene	189.4	1.073	262.1	20.016	19.78	1.2%
Argon	87.3	0.976	128.3	18.79	18.70	0.5%
Benzene	353.2	1.007	477.9	15.658	15.52	0.9%
n-Butane	272.7	1.008	361.3	12.239	12.07	1.4%
Carbon Monoxide	81.7	1.019	113.0	12.871	12.91	-0.3%
n-Decane	447.3	1.014	525.0	5.324	5.21	2.1%
Ethylene	169.4	1.004	240.0	17.918	17.69	1.3%
n-Heptane	371.6	1.011	459.2	7.779	7.59	2.5%
Methane	111.4	0.959	162.0	17.46	17.33	0.8%
Nitrogen	77.3	0.992	107.3	12.617	12.57	0.3%

14.10 (b) Acetylene:  $\omega := 0.187$      $T_c := 308.3\text{K}$      $P_c := 61.39\text{bar}$      $T_n := 189.4\text{K}$

$T := T_n$     Note: For solution at 0.85T<sub>c</sub>, set  $T := 0.85T_c$      $T_r := \frac{T}{T_c}$

For PR EOS:

$T_r = 0.614$

$\sigma := 1 + \sqrt{2}$      $\varepsilon := 1 - \sqrt{2}$      $\Omega := 0.07779$      $\Psi := 0.45724$     **Table 3.1**

$$\alpha(T_r, \omega) := \left[ 1 + \left( 0.37464 + 1.54226\omega - 0.26992\omega^2 \right) \cdot \left( 1 - T_r^{\frac{1}{2}} \right) \right]^2 \quad \text{Table 3.1}$$

$$a(T_r) := \Psi \cdot \frac{\alpha(T_r, \omega) \cdot R^2 \cdot T_c^2}{P_c} \quad \text{Eq. (3.45)}$$

$$q(T_r) := \frac{\Psi \cdot \alpha(T_r, \omega)}{\Omega \cdot T_r} \quad \text{Eq. (3.54)} \quad \beta(T_r, P_r) := \frac{\Omega \cdot P_r}{T_r} \quad \text{Eq. (3.53)}$$

**Define Z for the vapor (Zv)      Guess:**       $z_v := 0.9$

Given    **Eq. (3.52)**

$$z_v = 1 + \beta(T_r, P_r) - q(T_r) \cdot \beta(T_r, P_r) \cdot \frac{z_v - \beta(T_r, P_r)}{\left( z_v + \varepsilon \cdot \beta(T_r, P_r) \right) \cdot \left( z_v + \sigma \cdot \beta(T_r, P_r) \right)}$$

$$Z_v(T_r, P_r) := \text{Find}(z_v)$$

**Define Z for the liquid (Zl)      Guess:**       $z_l := 0.01$

Given    **Eq. (3.56)**

$$z_l = \beta(T_r, P_r) + \left( z_l + \varepsilon \cdot \beta(T_r, P_r) \right) \cdot \left( z_l + \sigma \cdot \beta(T_r, P_r) \right) \cdot \left( \frac{1 + \beta(T_r, P_r) - z_l}{q(T_r) \cdot \beta(T_r, P_r)} \right)$$

**To find liquid root, restrict search for zl to values less than 0.2**  $z_l < 0.2$

$$Z_l(T_r, P_r) := \text{Find}(z_l)$$

**Define I for liquid (Il) and vapor (Iv)**

$$I_l(T_r, P_r) := \frac{1}{\sigma - \varepsilon} \cdot \ln \left( \frac{Z_l(T_r, P_r) + \sigma \cdot \beta(T_r, P_r)}{Z_l(T_r, P_r) + \varepsilon \cdot \beta(T_r, P_r)} \right)$$

**Eq. (6.65b)**

$$I_v(T_r, P_r) := \frac{1}{\sigma - \varepsilon} \cdot \ln \left( \frac{Z_v(T_r, P_r) + \sigma \cdot \beta(T_r, P_r)}{Z_v(T_r, P_r) + \varepsilon \cdot \beta(T_r, P_r)} \right)$$

$$\ln\phi(T_r, P_r) := Z_l(T_r, P_r) - 1 - \ln(Z_l(T_r, P_r) - \beta(T_r, P_r)) - q(T_r) \cdot \Pi(T_r, P_r) \quad \text{Eq. (11.37)}$$

$$\ln\phi_v(T_r, P_r) := Z_v(T_r, P_r) - 1 - \ln(Z_v(T_r, P_r) - \beta(T_r, P_r)) - q(T_r) \cdot \text{Iv}(T_r, P_r)$$

**Guess Psat:**  $P_{\text{sat}_r} := \frac{2\text{bar}}{P_c}$

Given  $\ln\phi(T_r, P_{\text{sat}_r}) = \ln\phi_v(T_r, P_{\text{sat}_r})$   $P_{\text{sat}_r} := \text{Find}(P_{\text{sat}_r})$

$P_{\text{sat}_r} = 0.018$

$Z_l(T_r, P_{\text{sat}_r}) = 2.795 \times 10^{-3}$

$Z_v(T_r, P_{\text{sat}_r}) = 0.974$

$P_{\text{sat}} := P_{\text{sat}_r} \cdot P_c$   $P_{\text{sat}} = 1.09 \text{ bar}$  **Ans.**

The following table lists answers for all parts. Literature values are interpolated from tables in Perry's Chemical Engineers' Handbook, 6th ed. The last column shows the percent difference between calculated and literature values at 0.85Tc. These range from less than 0.1 to 1.2%. For the normal boiling point (Tn), Psat should be 1.013 bar. Tabulated results for Psat agree well with this value. Differences range from near 0 to 7.6%.

	Tn (K)	Psat (bar) @ Tn	0.85 Tc (K)	Psat (bar) @ 0.85 Tc	Psat (bar) Lit. Values	% Difference
Acetylene	189.4	1.090	262.1	19.768	19.78	-0.1%
Argon	87.3	1.015	128.3	18.676	18.70	-0.1%
Benzene	353.2	1.019	477.9	15.457	15.52	-0.4%
n-Butane	272.7	1.016	361.3	12.084	12.07	0.1%
Carbon Monoxide	81.7	1.041	113.0	12.764	12.91	-1.2%
n-Decane	447.3	1.016	525.0	5.259	5.21	0.9%
Ethylene	169.4	1.028	240.0	17.744	17.69	0.3%
n-Heptane	371.6	1.012	459.2	7.671	7.59	1.1%
Methane	111.4	0.994	162.0	17.342	17.33	0.1%
Nitrogen	77.3	1.016	107.3	12.517	12.57	-0.4%

14.12 (a) van der Waals Eqn.  $Tr := 0.7$

$$\sigma := 0 \quad \varepsilon := 0 \quad \Omega := \frac{1}{8} \quad \Psi := \frac{27}{64} \quad \alpha(Tr) := 1$$

$$q(Tr) := \frac{\Psi \cdot \alpha(Tr)}{\Omega \cdot Tr} \quad \beta(Tr, Pr) := \frac{\Omega \cdot Pr}{Tr} \quad z_v := 0.9 \text{ (guess)}$$

Given  $z_v = 1 + \beta(Tr, Pr) - q(Tr) \cdot \beta(Tr, Pr) \cdot \frac{z_v - \beta(Tr, Pr)}{(z_v)^2}$  **Eq. (3.52)**

$$Zv(\text{Tr}, \text{Pr}) := \text{Find}(zv)$$

$$zl := .01 \quad (\text{guess})$$

$$\text{Given} \quad zl = \beta(\text{Tr}, \text{Pr}) + (zl)^2 \cdot \frac{1 + \beta(\text{Tr}, \text{Pr}) - zl}{q(\text{Tr}) \cdot \beta(\text{Tr}, \text{Pr})} \quad \text{Eq. (3.56)} \quad zl < 0.2$$

$$Zl(\text{Tr}, \text{Pr}) := \text{Find}(zl)$$

$$Iv(\text{Tr}, \text{Pr}) := \frac{\beta(\text{Tr}, \text{Pr})}{Zv(\text{Tr}, \text{Pr})} \quad \text{Il}(\text{Tr}, \text{Pr}) := \frac{\beta(\text{Tr}, \text{Pr})}{Zl(\text{Tr}, \text{Pr})} \quad \text{Case II, pg. 218.}$$

**By Eq. (11.39):**

$$\ln\phi_v(\text{Tr}, \text{Pr}) := Zv(\text{Tr}, \text{Pr}) - 1 - \ln(Zv(\text{Tr}, \text{Pr}) - \beta(\text{Tr}, \text{Pr})) - q(\text{Tr}) \cdot Iv(\text{Tr}, \text{Pr})$$

$$\ln\phi_l(\text{Tr}, \text{Pr}) := Zl(\text{Tr}, \text{Pr}) - 1 - \ln(Zl(\text{Tr}, \text{Pr}) - \beta(\text{Tr}, \text{Pr})) - q(\text{Tr}) \cdot \text{Il}(\text{Tr}, \text{Pr})$$

$$\text{Psatr} := .1$$

$$\text{Given} \quad \ln\phi_l(\text{Tr}, \text{Psatr}) - \ln\phi_v(\text{Tr}, \text{Psatr}) = 0 \quad \text{Psatr} := \text{Find}(\text{Psatr})$$

$$Zv(\text{Tr}, \text{Psatr}) = 0.839 \quad Zl(\text{Tr}, \text{Psatr}) = 0.05 \quad \text{Psatr} = 0.2$$

$$\ln\phi_l(\text{Tr}, \text{Psatr}) = -0.148 \quad \ln\phi_v(\text{Tr}, \text{Psatr}) = -0.148 \quad \beta(\text{Tr}, \text{Psatr}) = 0.036$$

$$\omega := -1 - \log(\text{Psatr}) \quad \omega = -0.302 \quad \text{Ans.}$$

**(b) Redlich/Kwong Eqn.**  $\text{Tr} := 0.7$

$$\sigma := 1 \quad \varepsilon := 0 \quad \Omega := 0.08664 \quad \Psi := 0.42748$$

$$\alpha(\text{Tr}) := \text{Tr}^{-.5}$$

$$q(\text{Tr}) := \frac{\Psi \cdot \alpha(\text{Tr})}{\Omega \cdot \text{Tr}} \quad \beta(\text{Tr}, \text{Pr}) := \frac{\Omega \cdot \text{Pr}}{\text{Tr}} \quad \text{Guess:} \quad zv := 0.9$$

$$\text{Given} \quad zv = 1 + \beta(\text{Tr}, \text{Pr}) - q(\text{Tr}) \cdot \beta(\text{Tr}, \text{Pr}) \cdot \frac{zv - \beta(\text{Tr}, \text{Pr})}{zv \cdot (zv + \beta(\text{Tr}, \text{Pr}))} \quad \text{Eq. (3.52)}$$

$$Zv(\text{Tr}, \text{Pr}) := \text{Find}(zv)$$

$$\text{Guess:} \quad zl := .01$$

$$\text{Given } z_l = \beta(\text{Tr}, \text{Pr}) + z_l \cdot (z_l + \beta(\text{Tr}, \text{Pr})) \cdot \frac{1 + \beta(\text{Tr}, \text{Pr}) - z_l}{q(\text{Tr}) \cdot \beta(\text{Tr}, \text{Pr})} \quad \text{Eq. (3.55)}$$

$$z_l < 0.2 \quad Z_l(\text{Tr}, \text{Pr}) := \text{Find}(z_l)$$

$$I_v(\text{Tr}, \text{Pr}) := \ln\left(\frac{Z_v(\text{Tr}, \text{Pr}) + \beta(\text{Tr}, \text{Pr})}{Z_v(\text{Tr}, \text{Pr})}\right) \quad I_l(\text{Tr}, \text{Pr}) := \ln\left(\frac{Z_l(\text{Tr}, \text{Pr}) + \beta(\text{Tr}, \text{Pr})}{Z_l(\text{Tr}, \text{Pr})}\right)$$

**By Eq. (11.39):**

$$\ln\phi_v(\text{Tr}, \text{Pr}) := Z_v(\text{Tr}, \text{Pr}) - 1 - \ln(Z_v(\text{Tr}, \text{Pr}) - \beta(\text{Tr}, \text{Pr})) - q(\text{Tr}) \cdot I_v(\text{Tr}, \text{Pr})$$

$$\ln\phi_l(\text{Tr}, \text{Pr}) := Z_l(\text{Tr}, \text{Pr}) - 1 - \ln(Z_l(\text{Tr}, \text{Pr}) - \beta(\text{Tr}, \text{Pr})) - q(\text{Tr}) \cdot I_l(\text{Tr}, \text{Pr})$$

$$P_{\text{satr}} := .1$$

$$\text{Given } \ln\phi_l(\text{Tr}, P_{\text{satr}}) = \ln\phi_v(\text{Tr}, P_{\text{satr}}) \quad P_{\text{satr}} := \text{Find}(P_{\text{satr}})$$

$$Z_v(\text{Tr}, P_{\text{satr}}) = 0.913$$

$$Z_l(\text{Tr}, P_{\text{satr}}) = 0.015$$

$$P_{\text{satr}} = 0.087$$

$$\ln\phi_v(\text{Tr}, P_{\text{satr}}) = -0.083$$

$$\ln\phi_l(\text{Tr}, P_{\text{satr}}) = -0.083$$

$$\beta(\text{Tr}, P_{\text{satr}}) = 0.011$$

$$\omega := -1 - \log(P_{\text{satr}})$$

$$\omega = 0.058$$

**Ans.**

$$14.15 \quad (\text{a}) \quad x_{1\alpha} := 0.1 \quad x_{2\alpha} := 1 - x_{1\alpha} \quad x_{1\beta} := 0.9 \quad x_{2\beta} := 1 - x_{1\beta}$$

**Guess:**

$$A_{12} := 2$$

$$A_{21} := 2$$

$$\gamma_{1\alpha}(A_{21}, A_{12}) := \exp\left[x_{2\alpha}^2 \cdot [A_{12} + 2 \cdot (A_{21} - A_{12}) \cdot x_{1\alpha}]\right]$$

$$\gamma_{1\beta}(A_{21}, A_{12}) := \exp\left[x_{2\beta}^2 \cdot [A_{12} + 2 \cdot (A_{21} - A_{12}) \cdot x_{1\beta}]\right]$$

$$\gamma_{2\alpha}(A_{21}, A_{12}) := \exp\left[x_{1\alpha}^2 \cdot [A_{21} + 2 \cdot (A_{12} - A_{21}) \cdot x_{2\alpha}]\right]$$

$$\gamma_{2\beta}(A_{21}, A_{12}) := \exp\left[x_{1\beta}^2 \cdot [A_{21} + 2 \cdot (A_{12} - A_{21}) \cdot x_{2\beta}]\right]$$

Given  $x_{1\alpha} \cdot \gamma_{1\alpha}(A_{21}, A_{12}) = x_{1\beta} \cdot \gamma_{1\beta}(A_{21}, A_{12})$

$x_{2\alpha} \cdot \gamma_{2\alpha}(A_{21}, A_{12}) = x_{2\beta} \cdot \gamma_{2\beta}(A_{21}, A_{12})$

$\begin{pmatrix} A_{12} \\ A_{21} \end{pmatrix} := \text{Find}(A_{12}, A_{21})$        $A_{21} = 2.747$        $A_{12} = 2.747$       **Ans.**

(b)  $x_{1\alpha} := 0.2$        $x_{2\alpha} := 1 - x_{1\alpha}$        $x_{1\beta} := 0.9$        $x_{2\beta} := 1 - x_{1\beta}$

**Guess:**       $A_{12} := 2$        $A_{21} := 2$

$\gamma_{1\alpha}(A_{21}, A_{12}) := \exp\left[x_{2\alpha}^2 \cdot [A_{12} + 2 \cdot (A_{21} - A_{12}) \cdot x_{1\alpha}]\right]$

$\gamma_{1\beta}(A_{21}, A_{12}) := \exp\left[x_{2\beta}^2 \cdot [A_{12} + 2 \cdot (A_{21} - A_{12}) \cdot x_{1\beta}]\right]$

$\gamma_{2\alpha}(A_{21}, A_{12}) := \exp\left[x_{1\alpha}^2 \cdot [A_{21} + 2 \cdot (A_{12} - A_{21}) \cdot x_{2\alpha}]\right]$

$\gamma_{2\beta}(A_{21}, A_{12}) := \exp\left[x_{1\beta}^2 \cdot [A_{21} + 2 \cdot (A_{12} - A_{21}) \cdot x_{2\beta}]\right]$

Given  $x_{1\alpha} \cdot \gamma_{1\alpha}(A_{21}, A_{12}) = x_{1\beta} \cdot \gamma_{1\beta}(A_{21}, A_{12})$

$x_{2\alpha} \cdot \gamma_{2\alpha}(A_{21}, A_{12}) = x_{2\beta} \cdot \gamma_{2\beta}(A_{21}, A_{12})$

$\begin{pmatrix} A_{12} \\ A_{21} \end{pmatrix} := \text{Find}(A_{12}, A_{21})$        $A_{12} = 2.148$        $A_{21} = 2.781$       **Ans.**

(c)  $x_{1\alpha} := 0.1$        $x_{2\alpha} := 1 - x_{1\alpha}$        $x_{1\beta} := 0.8$        $x_{2\beta} := 1 - x_{1\beta}$

**Guess:**       $A_{12} := 2$        $A_{21} := 2$

$\gamma_{1\alpha}(A_{21}, A_{12}) := \exp\left[x_{2\alpha}^2 \cdot [A_{12} + 2 \cdot (A_{21} - A_{12}) \cdot x_{1\alpha}]\right]$

$\gamma_{1\beta}(A_{21}, A_{12}) := \exp\left[x_{2\beta}^2 \cdot [A_{12} + 2 \cdot (A_{21} - A_{12}) \cdot x_{1\beta}]\right]$

$\gamma_{2\alpha}(A_{21}, A_{12}) := \exp\left[x_{1\alpha}^2 \cdot [A_{21} + 2 \cdot (A_{12} - A_{21}) \cdot x_{2\alpha}]\right]$

$\gamma_{2\beta}(A_{21}, A_{12}) := \exp\left[x_{1\beta}^2 \cdot [A_{21} + 2 \cdot (A_{12} - A_{21}) \cdot x_{2\beta}]\right]$



$$\text{Given } x_{1\alpha} \cdot \gamma_{1\alpha}(A_{21}, A_{12}) = x_{1\beta} \cdot \gamma_{1\beta}(A_{21}, A_{12})$$

$$x_{2\alpha} \cdot \gamma_{2\alpha}(A_{21}, A_{12}) = x_{2\beta} \cdot \gamma_{2\beta}(A_{21}, A_{12})$$

$$\begin{pmatrix} A_{12} \\ A_{21} \end{pmatrix} := \text{Find}(A_{12}, A_{21}) \quad A_{12} = 2.781 \quad A_{21} = 2.148 \quad \text{Ans.}$$

$$14.16 \text{ (a) } x_{1\alpha} := 0.1 \quad x_{2\alpha} := 1 - x_{1\alpha} \quad x_{1\beta} := 0.9 \quad x_{2\beta} := 1 - x_{1\beta}$$

$$\text{Guess: } a_{12} := 2 \quad a_{21} := 2$$

$$\text{Given } \exp \left[ a_{12} \cdot \left( 1 + \frac{a_{12} \cdot x_{1\alpha}}{a_{21} \cdot x_{2\alpha}} \right)^{-2} \right] \cdot x_{1\alpha} = \exp \left[ a_{12} \cdot \left( 1 + \frac{a_{12} \cdot x_{1\beta}}{a_{21} \cdot x_{2\beta}} \right)^{-2} \right] \cdot x_{1\beta}$$

$$\exp \left[ a_{21} \cdot \left( 1 + \frac{a_{21} \cdot x_{2\alpha}}{a_{12} \cdot x_{1\alpha}} \right)^{-2} \right] \cdot x_{2\alpha} = \exp \left[ a_{21} \cdot \left( 1 + \frac{a_{21} \cdot x_{2\beta}}{a_{12} \cdot x_{1\beta}} \right)^{-2} \right] \cdot x_{2\beta}$$

$$\begin{pmatrix} a_{12} \\ a_{21} \end{pmatrix} := \text{Find}(a_{12}, a_{21}) \quad a_{12} = 2.747 \quad a_{21} = 2.747 \quad \text{Ans.}$$

$$\text{(b) } x_{1\alpha} := 0.2 \quad x_{2\alpha} := 1 - x_{1\alpha} \quad x_{1\beta} := 0.9 \quad x_{2\beta} := 1 - x_{1\beta}$$

$$\text{Guess: } a_{12} := 2 \quad a_{21} := 2$$

$$\text{Given } \exp \left[ a_{12} \cdot \left( 1 + \frac{a_{12} \cdot x_{1\alpha}}{a_{21} \cdot x_{2\alpha}} \right)^{-2} \right] \cdot x_{1\alpha} = \exp \left[ a_{12} \cdot \left( 1 + \frac{a_{12} \cdot x_{1\beta}}{a_{21} \cdot x_{2\beta}} \right)^{-2} \right] \cdot x_{1\beta}$$

$$\exp \left[ a_{21} \cdot \left( 1 + \frac{a_{21} \cdot x_{2\alpha}}{a_{12} \cdot x_{1\alpha}} \right)^{-2} \right] \cdot x_{2\alpha} = \exp \left[ a_{21} \cdot \left( 1 + \frac{a_{21} \cdot x_{2\beta}}{a_{12} \cdot x_{1\beta}} \right)^{-2} \right] \cdot x_{2\beta}$$

$$\begin{pmatrix} a_{12} \\ a_{21} \end{pmatrix} := \text{Find}(a_{12}, a_{21}) \quad a_{12} = 2.199 \quad a_{21} = 2.81 \quad \text{Ans.}$$

(c)  $x_{1\alpha} := 0.1$      $x_{2\alpha} := 1 - x_{1\alpha}$      $x_{1\beta} := 0.8$      $x_{2\beta} := 1 - x_{1\beta}$

**Guess:**     $a_{12} := 2$      $a_{21} := 2$

Given 
$$\exp \left[ a_{12} \cdot \left( 1 + \frac{a_{12} \cdot x_{1\alpha}}{a_{21} \cdot x_{2\alpha}} \right)^{-2} \right] \cdot x_{1\alpha} = \exp \left[ a_{12} \cdot \left( 1 + \frac{a_{12} \cdot x_{1\beta}}{a_{21} \cdot x_{2\beta}} \right)^{-2} \right] \cdot x_{1\beta}$$

$$\exp \left[ a_{21} \cdot \left( 1 + \frac{a_{21} \cdot x_{2\alpha}}{a_{12} \cdot x_{1\alpha}} \right)^{-2} \right] \cdot x_{2\alpha} = \exp \left[ a_{21} \cdot \left( 1 + \frac{a_{21} \cdot x_{2\beta}}{a_{12} \cdot x_{1\beta}} \right)^{-2} \right] \cdot x_{2\beta}$$

$\begin{pmatrix} a_{12} \\ a_{21} \end{pmatrix} := \text{Find}(a_{12}, a_{21})$      $a_{12} = 2.81$      $a_{21} = 2.199$     **Ans.**

**14.18 (a)**     $a := 975$      $b := -18.4$      $c := -3$

$T := 250..450$      $A(T) := \frac{a}{T} + b - c \cdot \ln(T)$

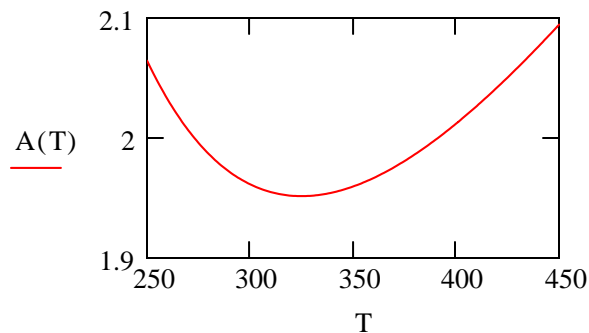

**Parameter A = 2 at two temperatures. The lower one is an UCST, because A decreases to 2 as T increases. The higher one is a LCST, because A decreases to 2 as T decreases.**

**Guess:**     $x := 0.25$

Given 
$$A(T) \cdot (1 - 2 \cdot x) = \ln \left( \frac{1 - x}{x} \right)$$
    **Eq. (E), Ex. 14.5**

$x \geq 0$      $x \leq 0.5$      $x_1(T) := \text{Find}(x)$      $x_2(T) := 1 - x_1(T)$

UCST := 300 (guess)

Given  $A(\text{UCST}) = 2$  UCST := Find(UCST) UCST = 272.93

LCST := 400 (guess)

Given  $A(\text{LCST}) = 2$  LCST := Find(LCST) LCST = 391.21

Plot phase diagram as a function of T

T1 := 225, 225.1 .. UCST T2 := LCST .. 450

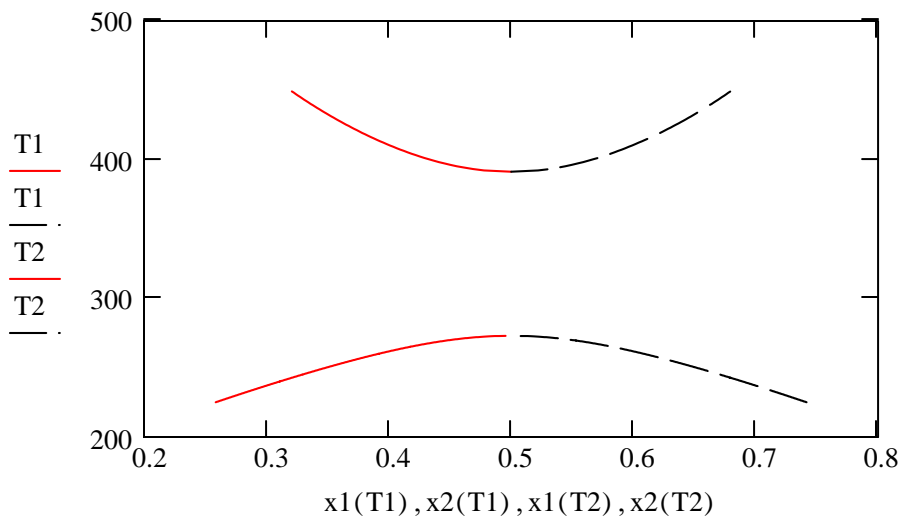

(b)  $a := 540$   $b := -17.1$   $c := -3$

T := 250 .. 450  $A(T) := \frac{a}{T} + b - c \cdot \ln(T)$

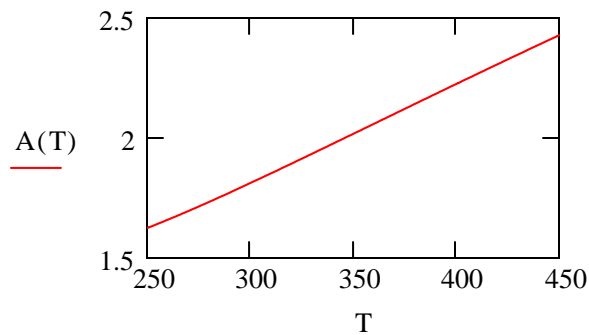

Parameter  $A = 2$  at a single temperature. It is a LCST, because A decreases to 2 as T decreases.

**Guess:**  $x := 0.25$

**Given**  $A(T) \cdot (1 - 2 \cdot x) = \ln\left(\frac{1-x}{x}\right)$  **Eq. (E), Ex. 14.5**

$x \geq 0$   $x \leq 0.5$   $x1(T) := \text{Find}(x)$

LCST := 350 (guess)

**Given**  $A(\text{LCST}) = 2$   $\text{LCST} := \text{Find}(\text{LCST})$  **LCST = 346**

**Plot phase diagram as a function of T**  $T := \text{LCST}..450$

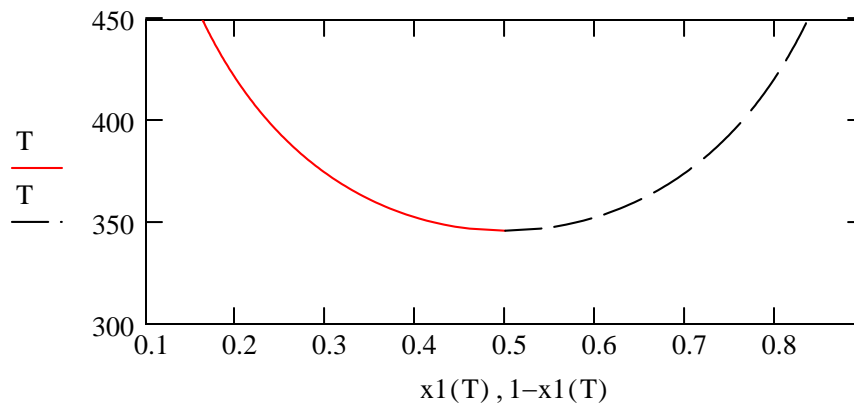

(c) **a := 1500** **b := -19.9** **c := -3**

$T := 250..450$   $A(T) := \frac{a}{T} + b - c \cdot \ln(T)$

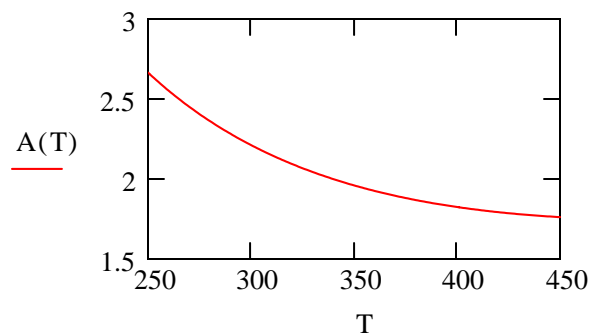

**Parameter A = 2 at a single temperature. It is an UCST, because A decreases to 2 as T increases.**

**Guess:**  $x := 0.25$

**Given**  $A(T) \cdot (1 - 2 \cdot x) = \ln\left(\frac{1-x}{x}\right)$  **Eq. (E), Ex. 14.5**

$x \geq 0$   $x \leq 0.5$   $x1(T) := \text{Find}(x)$

UCST := 350 **(guess)**

**Given**  $A(\text{UCST}) = 2$   $\text{UCST} := \text{Find}(\text{UCST})$  **UCST = 339.66**

**Plot phase diagram as a function of T**  $T := \text{UCST} .. 250$

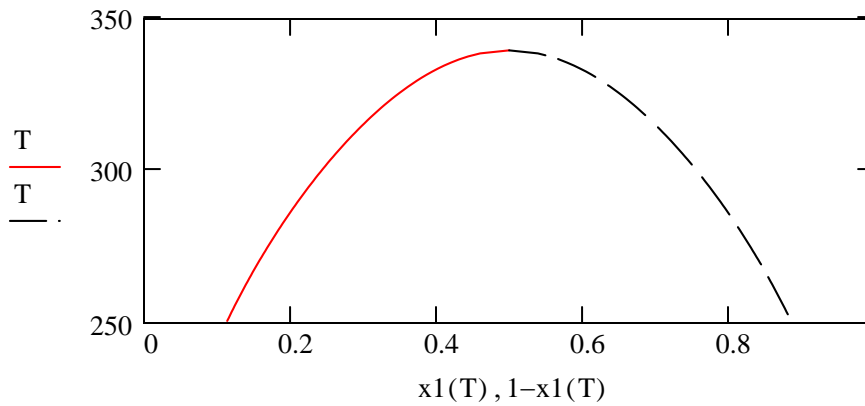

**14.20 Guess:**  $x1\alpha := 0.5$   $x1\beta := 0.5$

**Given** **Write Eq. (14.74) for species 1:**

$$x1\alpha \cdot \exp\left[0.4 \cdot (1 - x1\alpha)^2\right] = x1\beta \cdot \exp\left[0.8 \cdot (1 - x1\beta)^2\right]$$

$$\frac{x1\alpha}{1 - x1\alpha} + \frac{x1\beta}{1 - x1\beta} = 1 \quad \text{(Material balance)}$$

$$\begin{pmatrix} x1\alpha \\ x1\beta \end{pmatrix} := \text{Find}(x1\alpha, x1\beta) \quad x1\alpha = 0.371 \quad x1\beta = 0.291 \quad \text{Ans.}$$

**14.22 Temperatures in kelvins; pressures in kPa.**

$$P_{1\text{sat}}(T) := \exp\left(19.1478 - \frac{5363.7}{T}\right) \quad \text{water}$$

$$P_{2\text{sat}}(T) := \exp\left(14.6511 - \frac{2048.97}{T}\right) \quad \text{SF6}$$

$P := 1600$

**Find 3-phase equilibrium temperature and vapor-phase composition (pp. 594-5 of text):**

**Guess:**  $T := 300$

Given  $P = P_{1\text{sat}}(T) + P_{2\text{sat}}(T)$        $T_{\text{star}} := \text{Find}(T)$        $T_{\text{star}} = 281.68$

$$y_{1\text{star}} := \frac{P_{1\text{sat}}(T_{\text{star}})}{P} \quad y_{1\text{star}} \cdot 10^6 = 695$$

**Find saturation temperatures of pure species 2:**

**Guess:**  $T := 300$

Given  $P_{2\text{sat}}(T) = P$        $T_2 := \text{Find}(T)$        $T_2 = 281.71$

$$T_{\text{II}} := T_{\text{star}}, T_{\text{star}} + 0.0001 \dots T_2 \quad y_{1\text{II}}(T) := 1 - \frac{P_{2\text{sat}}(T)}{P}$$

$$T_{\text{I}} := T_{\text{star}}, T_{\text{star}} + 0.01 \dots T_{\text{star}} + 6 \quad y_{1\text{I}}(T) := \frac{P_{1\text{sat}}(T)}{P}$$

**Because of the very large difference in scales appropriate to regions I and II [Fig. 14.21(a)], the txy diagram is presented on the following page in two parts, showing regions I and II separately.**

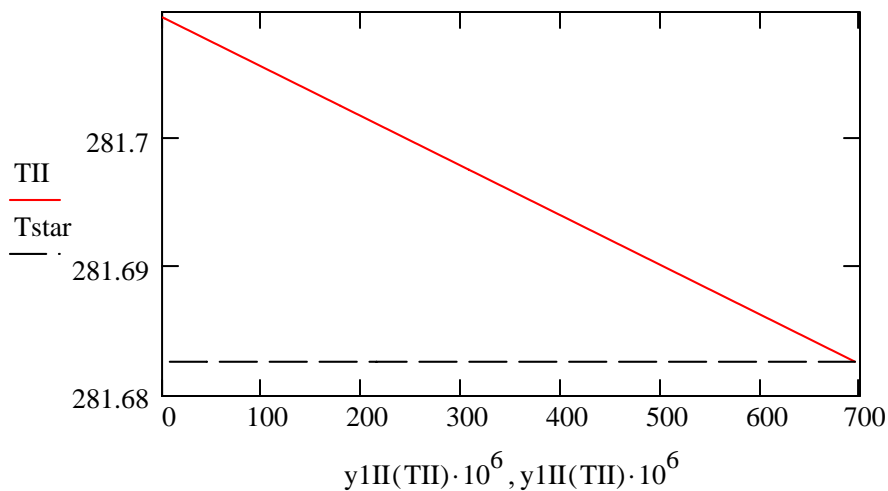

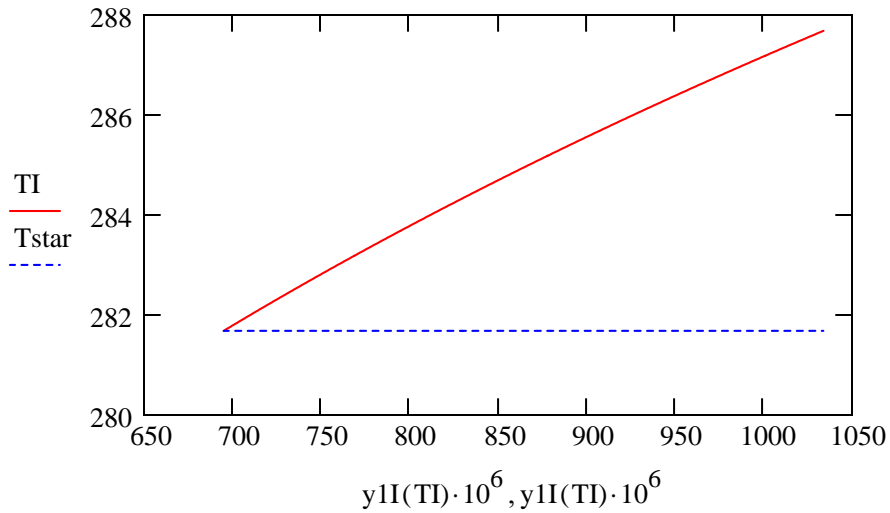

**14.24 Temperatures in deg. C; pressures in kPa**

$$P_{1sat}(T) := \exp\left(13.9320 - \frac{3056.96}{T + 217.625}\right) \quad \text{Toluene}$$

$$P_{2sat}(T) := \exp\left(16.3872 - \frac{3885.70}{T + 230.170}\right) \quad \text{Water}$$

**P := 101.33**

**Find the three-phase equilibrium T and y:**

**Guess:**  $T := 25$

**Given**  $P = P_{1sat}(T) + P_{2sat}(T)$   $Tstar := \text{Find}(T)$

**Tstar = 84.3**

$$y_{1star} := \frac{P_{1sat}(Tstar)}{P} \quad \text{y1star = 0.444}$$

**For  $z_1 < y_{1*}$ , first liquid is pure species 2.**

**y1 := 0.2** **Guess:**  $Tdew := Tstar$

**Given**  $y_1 = 1 - \frac{P_{2sat}(Tdew)}{P}$   $Tdew := \text{Find}(Tdew)$

**Tdew = 93.855** **Ans.**

**For  $z_1 > y_{1*}$ , first liquid is pure species 1.**

$y_1 := 0.7$       **Guess:**       $T_{dew} := T_{star}$

Given       $y_1 = \frac{P_{1sat}(T_{dew})}{P}$        $T_{dew} := \text{Find}(T_{dew})$

$T_{dew} = 98.494$       **Ans.**

**In both cases the bubblepoint temperature is  $T^*$ , and the mole fraction of the last vapor is  $y_1^*$ .**

#### 14.25 Temperatures in deg. C; pressures in kPa.

$P_{1sat}(T) := \exp\left(13.8622 - \frac{2910.26}{T + 216.432}\right)$       **n-heptane**

$P := 101.33$

$P_{2sat}(T) := \exp\left(16.3872 - \frac{3885.70}{T + 230.170}\right)$       **water**

**Find the three-phase equilibrium T and y:**

**Guess:**       $T := 50$

Given       $P = P_{1sat}(T) + P_{2sat}(T)$        $T_{star} := \text{Find}(T)$        $T_{star} = 79.15$

$y_{1star} := \frac{P_{1sat}(T_{star})}{P}$        $y_{1star} = 0.548$

**Since  $0.35 < y_1^*$ , first liquid is pure species 2.**

$y_1(T) := 1 - \frac{P_{2sat}(T)}{P}$

**Find temperature of initial condensation at  $y_1=0.35$ :**

$y_{10} := 0.35$       **Guess:**       $T_{dew} := T_{star}$

Given       $y_1(T_{dew}) = y_{10}$        $T_{dew} := \text{Find}(T_{dew})$        $T_{dew} = 88.34$

**Define the path of vapor mole fraction above and below the dew point.**

$y_{1path}(T) := \text{if}(T > T_{dew}, y_{10}, y_1(T))$        $T := 100, 99.9 .. T_{star}$

**Path of mole fraction heptane in residual vapor as temperature is decreased. No vapor exists below  $T_{star}$ .**



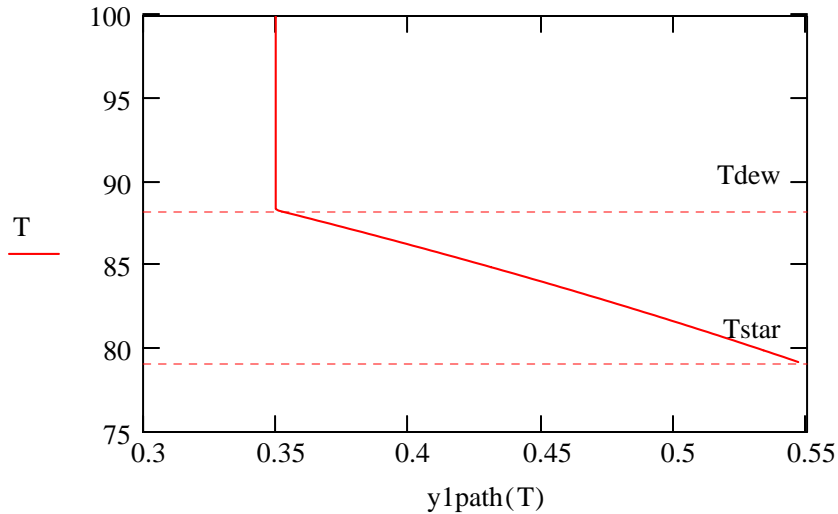

14.26 Pressures in kPa.  $P1_{sat} := 75$   $P2_{sat} := 110$   $A := 2.25$

$$\gamma_1(x_1) := \exp\left[A \cdot (1 - x_1)^2\right] \quad \gamma_2(x_1) := \exp\left(A \cdot x_1^2\right)$$

Find the solubility limits:

Guess:  $x_{1\alpha} := 0.1$

Given  $A \cdot (1 - 2 \cdot x_{1\alpha}) = \ln\left(\frac{1 - x_{1\alpha}}{x_{1\alpha}}\right)$   $x_{1\alpha} := \text{Find}(x_{1\alpha})$

$x_{1\alpha} = 0.224$

$x_{1\beta} := 1 - x_{1\alpha}$

$x_{1\beta} = 0.776$

Find the conditions for VLLE:

Guess:  $P_{star} := P1_{sat}$   $y_{1star} := 0.5$

Given  $P_{star} = x_{1\beta} \cdot \gamma_1(x_{1\beta}) \cdot P1_{sat} + (1 - x_{1\alpha}) \cdot \gamma_2(x_{1\alpha}) \cdot P2_{sat}$

$y_{1star} \cdot P_{star} = x_{1\alpha} \cdot \gamma_1(x_{1\alpha}) \cdot P1_{sat}$

$\begin{pmatrix} P_{star} \\ y_{1star} \end{pmatrix} := \text{Find}(P_{star}, y_{1star})$   $P_{star} = 160.699$   $y_{1star} = 0.405$

Calculate VLE in two-phase region.

Modified Raoult's law; vapor an ideal gas.

Guess:  $x_1 := 0.1$   $P := 50$

Given  $P = x_1 \cdot \gamma_1(x_1) \cdot P_{1sat} + (1 - x_1) \cdot \gamma_2(x_1) \cdot P_{2sat}$

$P(x_1) := \text{Find}(P)$   $y_1(x_1) := \frac{x_1 \cdot \gamma_1(x_1) \cdot P_{1sat}}{P(x_1)}$

**Plot the phase diagram.**

**Define liquid equilibrium line:**

$PL(x_1) := \text{if}(P(x_1) < P_{star}, P(x_1), P_{star})$

**Define vapor equilibrium line:**

$PV(x_1) := \text{if}(P(x_1) < P_{star}, P(x_1), P_{star})$

**Define pressures for liquid phases above Pstar:**

$P_{liq} := P_{star} .. P_{star} + 10$

$x_1 := 0, 0.01 .. 1$

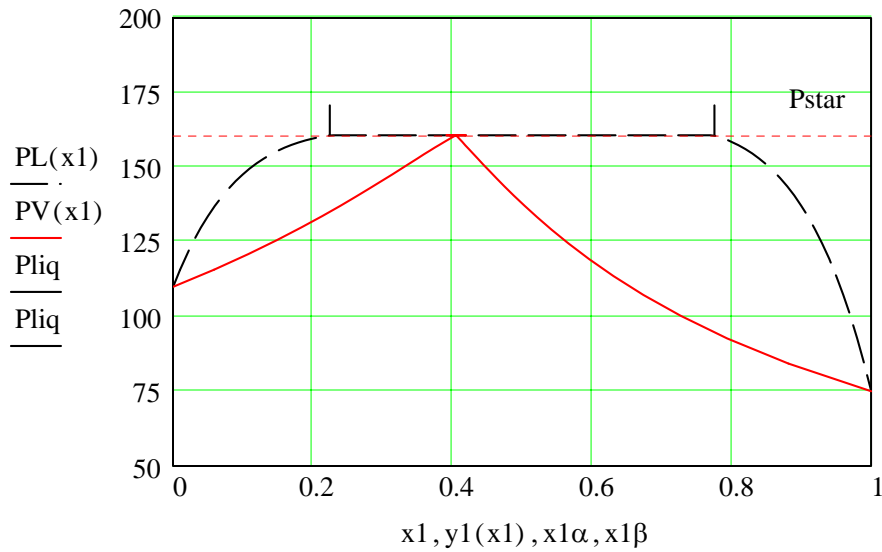

$x_1 := 0, 0.05 .. 0.2$

$x_1 =$
0
0.05
0.1
0.15
0.2

$PL(x_1) =$
110
133.66
147.658
155.523
159.598

$y_1(x_1) =$
0
0.214
0.314
0.368
0.397

$$x1 := 1, 0.95 .. 0.8$$

<b>x1 =</b>	<b>PL(x1) =</b>	<b>y1(x1) =</b>
1	75	1
0.95	113.556	0.631
0.9	137.096	0.504
0.85	150.907	0.444
0.8	158.506	0.414
<b>x1<math>\alpha</math> = 0.224</b>	<b>x1<math>\beta</math> = 0.776</b>	<b>y1star = 0.405</b>

#### 14.27 Temperatures in deg. C; pressures in kPa.

**Water:**  $P_{1sat}(T) := \exp\left(16.3872 - \frac{3885.70}{T + 230.170}\right)$

**n-Pentane:**  $P_{2sat}(T) := \exp\left(13.7667 - \frac{2451.88}{T + 232.014}\right)$

**n-Heptane:**  $P_{3sat}(T) := \exp\left(13.8622 - \frac{2910.26}{T + 216.432}\right)$

**P := 101.33**    **z1 := 0.45**    **z2 := 0.30**     $z3 := 1 - z1 - z2$

(a) Calculate dew point T and liquid composition assuming the hydrocarbon layer forms first:

**Guess:**  $T_{dew1} := 100$      $x_{2\alpha} := z2$      $x_{3\alpha} := 1 - x_{2\alpha}$

Given  $P = x_{2\alpha} \cdot P_{2sat}(T_{dew1}) + x_{3\alpha} \cdot P_{3sat}(T_{dew1})$

$$z3 \cdot P = x_{3\alpha} \cdot P_{3sat}(T_{dew1})$$

$$x_{2\alpha} + x_{3\alpha} = 1$$

$$\begin{pmatrix} x_{2\alpha} \\ x_{3\alpha} \\ T_{dew1} \end{pmatrix} := \text{Find}(x_{2\alpha}, x_{3\alpha}, T_{dew1})$$

**Tdew1 = 66.602**    **x3 $\alpha$  = 0.706**    **x2 $\alpha$  = 0.294**

Calculate dew point temperature assuming the water layer forms first:

$$x1\beta := 1 \quad \text{Guess:} \quad Tdew2 := 100$$

$$\text{Given} \quad x1\beta \cdot P1sat(Tdew2) = z1 \cdot P \quad Tdew2 := \text{Find}(Tdew2)$$

$$Tdew2 = 79.021$$

Since  $Tdew2 > Tdew1$ , the water layer forms first

(b) Calculate the temperature at which the second layer forms:

$$\text{Guess:} \quad Tdew3 := 100 \quad x2\alpha := z2 \quad x3\alpha := 1 - x2\alpha$$

$$y1 := z1 \quad y2 := z2 \quad y3 := z3$$

$$\text{Given} \quad P = P1sat(Tdew3) + x2\alpha \cdot P2sat(Tdew3) + x3\alpha \cdot P3sat(Tdew3)$$

$$y1 \cdot P = P1sat(Tdew3)$$

$$\frac{y2}{y3} = \frac{z2}{z3} \quad y1 + y2 + y3 = 1$$

$$y2 \cdot P = x2\alpha \cdot P2sat(Tdew3) \quad x2\alpha + x3\alpha = 1$$

$$\begin{pmatrix} y1 \\ y2 \\ y3 \\ Tdew3 \\ x2\alpha \\ x3\alpha \end{pmatrix} := \text{Find}(y1, y2, y3, Tdew3, x2\alpha, x3\alpha)$$

$$y1 = 0.288$$

$$y2 = 0.388$$

$$y3 = 0.324$$

$$Tdew3 = 68.437$$

$$x2\alpha = 0.1446$$

$$x3\alpha = 0.8554$$

(c) Calculate the bubble point given the total molar composition of the two phases

$$Tbubble := Tdew3$$

$$x2\alpha := \frac{z2}{z2 + z3}$$

$$x3\alpha := \frac{z3}{z2 + z3}$$

$$x2\alpha = 0.545$$

$$x3\alpha = 0.455$$

Given

$$P = P1\text{sat}(T_{\text{bubble}}) + x2\alpha \cdot P2\text{sat}(T_{\text{bubble}}) + x3\alpha \cdot P3\text{sat}(T_{\text{bubble}})$$

$$T_{\text{bubble}} := \text{Find}(T_{\text{bubble}}) \quad T_{\text{bubble}} = 48.113$$

$$y1 := \frac{P1\text{sat}(T_{\text{bubble}})}{P} \quad y1 = 0.111$$

$$y2 := \frac{x2\alpha \cdot P2\text{sat}(T_{\text{bubble}})}{P} \quad y2 = 0.81$$

$$y3 := \frac{x3\alpha \cdot P3\text{sat}(T_{\text{bubble}})}{P} \quad y3 = 0.078$$

#### 14.28 Temperatures in deg. C; pressures in kPa.

$$\text{Water:} \quad P1\text{sat}(T) := \exp\left(16.3872 - \frac{3885.70}{T + 230.170}\right)$$

$$\text{n-Pentane:} \quad P2\text{sat}(T) := \exp\left(13.7667 - \frac{2451.88}{T + 232.014}\right)$$

$$\text{n-Heptane:} \quad P3\text{sat}(T) := \exp\left(13.8622 - \frac{2910.26}{T + 216.432}\right)$$

$$P := 101.33$$

$$z1 := 0.32$$

$$z2 := 0.45$$

$$z3 := 1 - z1 - z2$$

(a) Calculate dew point T and liquid composition assuming the hydrocarbon layer forms first:

$$\text{Guess:} \quad T_{\text{dew1}} := 70 \quad x2\alpha := z2 \quad x3\alpha := 1 - x2\alpha$$

$$\text{Given} \quad P = x2\alpha \cdot P2\text{sat}(T_{\text{dew1}}) + x3\alpha \cdot P3\text{sat}(T_{\text{dew1}})$$

$$z3 \cdot P = x3\alpha \cdot P3\text{sat}(T_{\text{dew1}}) \quad x2\alpha + x3\alpha = 1$$

$$\begin{pmatrix} x2\alpha \\ x3\alpha \\ T_{\text{dew1}} \end{pmatrix} := \text{Find}(x2\alpha, x3\alpha, T_{\text{dew1}})$$

$$T_{\text{dew1}} = 65.122$$

$$x3\alpha = 0.686$$

$$x2\alpha = 0.314$$

Calculate dew point temperature assuming the water layer forms first:

$$x_{1\beta} := 1 \quad \text{Guess:} \quad T_{\text{dew}2} := 70$$

$$\text{Given} \quad x_{1\beta} \cdot P_{1\text{sat}}(T_{\text{dew}2}) = z_1 \cdot P \quad T_{\text{dew}2} := \text{Find}(T_{\text{dew}2})$$

$$T_{\text{dew}2} = 70.854$$

Since  $T_{\text{dew}1} > T_{\text{dew}2}$ , a hydrocarbon layer forms first

(b) Calculate the temperature at which the second layer forms:

$$\text{Guess:} \quad T_{\text{dew}3} := 100 \quad x_{2\alpha} := z_2 \quad x_{3\alpha} := 1 - x_{2\alpha}$$

$$y_1 := z_1 \quad y_2 := z_2 \quad y_3 := z_3$$

$$\text{Given} \quad P = P_{1\text{sat}}(T_{\text{dew}3}) + x_{2\alpha} \cdot P_{2\text{sat}}(T_{\text{dew}3}) + x_{3\alpha} \cdot P_{3\text{sat}}(T_{\text{dew}3})$$

$$y_1 \cdot P = P_{1\text{sat}}(T_{\text{dew}3}) \quad \frac{y_2}{y_3} = \frac{z_2}{z_3} \quad y_1 + y_2 + y_3 = 1$$

$$y_2 \cdot P = x_{2\alpha} \cdot P_{2\text{sat}}(T_{\text{dew}3}) \quad x_{2\alpha} + x_{3\alpha} = 1$$

$$\begin{pmatrix} y_1 \\ y_2 \\ y_3 \\ T_{\text{dew}3} \\ x_{2\alpha} \\ x_{3\alpha} \end{pmatrix} := \text{Find}(y_1, y_2, y_3, T_{\text{dew}3}, x_{2\alpha}, x_{3\alpha})$$

$$y_1 = 0.24$$

$$y_2 = 0.503$$

$$y_3 = 0.257$$

$$T_{\text{dew}3} = 64.298$$

$$x_{2\alpha} = 0.2099$$

$$x_{3\alpha} = 0.7901$$

(c) Calculate the bubble point given the total molar composition of the two phases

$$T_{\text{bubble}} := T_{\text{dew}3} \quad x_{2\alpha} := \frac{z_2}{z_2 + z_3} \quad x_{3\alpha} := \frac{z_3}{z_2 + z_3}$$

$$x_{2\alpha} = 0.662$$

$$x_{3\alpha} = 0.338$$

Given  $P = P1\text{sat}(T\text{bubble}) + x2\alpha \cdot P2\text{sat}(T\text{bubble}) + x3\alpha \cdot P3\text{sat}(T\text{bubble})$

$T\text{bubble} := \text{Find}(T\text{bubble})$        $T\text{bubble} = 43.939$

$y1 := \frac{P1\text{sat}(T\text{bubble})}{P}$        $y1 = 0.09$

$y2 := \frac{x2\alpha \cdot P2\text{sat}(T\text{bubble})}{P}$        $y2 = 0.861$

$y3 := \frac{x3\alpha \cdot P3\text{sat}(T\text{bubble})}{P}$        $y3 = 0.049$

**14.32**       $\omega := \begin{pmatrix} 0.302 \\ 0.224 \end{pmatrix}$        $T_c := \begin{pmatrix} 748.4 \\ 304.2 \end{pmatrix} \text{K}$        $P_c := \begin{pmatrix} 40.51 \\ 73.83 \end{pmatrix} \text{bar}$

$P := 10\text{bar}, 20\text{bar}.. 300\text{bar}$

$T := 353.15\text{K}$        $Tr := \frac{T}{T_c}$

Use SRK EOS

From Table 3.1, p. 98 of text:

$\sigma := 1$        $\varepsilon := 0$        $\Omega := 0.08664$        $\Psi := 0.42748$

$\alpha := \left[ 1 + \left( 0.480 + 1.574 \cdot \omega - 0.176 \cdot \omega^2 \right) \cdot \left( 1 - Tr^{0.5} \right) \right]^2$

$a := \frac{\Psi \cdot \alpha \cdot R^2 \cdot T_c^2}{P_c}$       Eq. (14.31)

$b := \frac{\Omega \cdot R \cdot T_c}{P_c}$       Eq. (14.32)

$a = \begin{pmatrix} 6.842 \\ 0.325 \end{pmatrix} \frac{\text{kg m}^5}{\text{s}^2 \text{mol}^2}$

$b = \begin{pmatrix} 1.331 \times 10^{-4} \\ 2.968 \times 10^{-5} \end{pmatrix} \frac{\text{m}^3}{\text{mol}}$

$\beta_2(P) := \frac{b_2 \cdot P}{R \cdot T}$       Eq. (14.33)

$q_2 := \frac{a_2}{b_2 \cdot R \cdot T}$       Eq. (14.34)

$z_2 := 1$       (guess)

Given

$$z_2 = 1 + \beta_2(P) - q_2 \cdot \beta_2(P) \cdot \frac{z_2 - \beta_2(P)}{(z_2 + \varepsilon \cdot \beta_2(P)) \cdot (z_2 + \sigma \cdot \beta_2(P))} \quad \text{Eq. (14.36)}$$

$$Z_2(P) := \text{Find}(z_2)$$

$$I_2(P) := \ln\left(\frac{Z_2(P) + \beta_2(P)}{Z_2(P)}\right) \quad \text{Eq. (6.65b)}$$

For simplicity, let  $\phi_1$  represent the infinite-dilution value of the fugacity coefficient of species 1 in solution.

$$\text{Eq. (14.103):} \quad I_{12} := 0.088$$

$$\phi_1(P) := \exp\left[\left[\left[\frac{b_1}{b_2} \cdot (Z_2(P) - 1) - \ln(Z_2(P) - \beta_2(P))\right] \dots\right] + -q_2 \cdot \left[2 \cdot (1 - I_{12}) \cdot \left(\frac{a_1}{a_2}\right)^{0.5} - \frac{b_1}{b_2}\right] \cdot I_2(P)\right]$$

$$P_{\text{sat}1} := 0.0102 \text{ bar} \quad V_1 := 124.5 \frac{\text{cm}^3}{\text{mol}}$$

Eqs. (14.98) and (14.99), with  $\phi_{\text{sat}1} = 1$  and  $(P - P_{\text{sat}1}) = P$ , combine to give:

$$y_1(P) := \frac{P_{\text{sat}1}}{P \cdot \phi_1(P)} \cdot \exp\left(\frac{P \cdot V_1}{R \cdot T}\right)$$

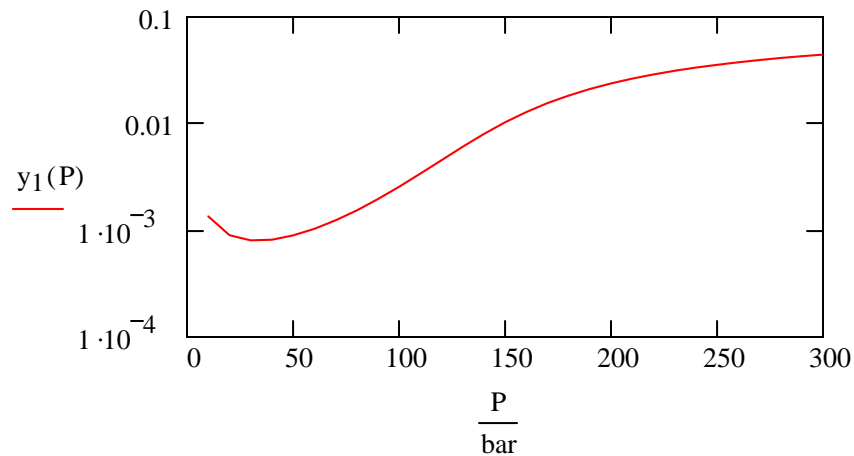



$$14.33 \quad \omega := \begin{pmatrix} 0.302 \\ 0.038 \end{pmatrix} \quad T_c := \begin{pmatrix} 748.4 \\ 126.2 \end{pmatrix} \text{K} \quad P_c := \begin{pmatrix} 40.51 \\ 34.00 \end{pmatrix} \text{bar}$$

$$P := 10 \text{bar}, 20 \text{bar}.. 300 \text{bar}$$

$$T := 308.15 \text{K (K)} \quad T_r := \frac{T}{T_c}$$

Use SRK EOS

From Table 3.1, p. 98 of text:

$$\sigma := 1 \quad \varepsilon := 0 \quad \Omega := 0.08664 \quad \Psi := 0.42748$$

$$\alpha := \left[ 1 + \left( 0.480 + 1.574 \cdot \omega - 0.176 \cdot \omega^2 \right) \cdot \left( 1 - T_r^{0.5} \right) \right]^2$$

$$a := \frac{\Psi \cdot \alpha \cdot R^2 \cdot T_c^2}{P_c} \quad \text{Eq. (14.31)} \quad b := \frac{\Omega \cdot R \cdot T_c}{P_c} \quad \text{Eq. (14.32)}$$

$$a = \begin{pmatrix} 7.298 \\ 0.067 \end{pmatrix} \frac{\text{kg m}^5}{\text{s}^2 \text{mol}^2}$$

$$b = \begin{pmatrix} 1.331 \times 10^{-4} \\ 2.674 \times 10^{-5} \end{pmatrix} \frac{\text{m}^3}{\text{mol}}$$

$$\beta_2(P) := \frac{b_2 \cdot P}{R \cdot T} \quad \text{Eq. (14.33)}$$

$$q_2 := \frac{a_2}{b_2 \cdot R \cdot T} \quad \text{Eq. (14.34)}$$

$$z_2 := 1 \quad (\text{guess})$$

Given

$$z_2 = 1 + \beta_2(P) - q_2 \cdot \beta_2(P) \cdot \frac{z_2 - \beta_2(P)}{\left( z_2 + \varepsilon \cdot \beta_2(P) \right) \cdot \left( z_2 + \sigma \cdot \beta_2(P) \right)} \quad \text{Eq. (14.36)}$$

$$Z_2(P) := \text{Find}(z_2)$$

$$I_2(P) := \ln \left( \frac{Z_2(P) + \beta_2(P)}{Z_2(P)} \right) \quad \text{Eq. (6.65b)}$$

For simplicity, let  $\phi_1$  represent the infinite-dilution value of the fugacity coefficient of species 1 in solution.

$l_{12} := 0.0$  Eq. (14.103):

$$\phi_1(P) := \exp \left[ \left[ \left[ \frac{b_1}{b_2} \cdot (Z_2(P) - 1) - \ln(Z_2(P) - \beta_2(P)) \right] \dots \right] \right. \\ \left. + -q_2 \cdot \left[ 2 \cdot (1 - l_{12}) \cdot \left( \frac{a_1}{a_2} \right)^{0.5} - \frac{b_1}{b_2} \right] \cdot I_2(P) \right]$$

$P_{\text{sat}1} := 2.9 \cdot 10^{-4} \text{ bar}$

$V_1 := 125 \frac{\text{cm}^3}{\text{mol}}$

Eqs. (14.98) and (14.99), with  $\phi_{\text{sat}1} = 1$  and  $(P - P_{\text{sat}1}) = P$ , combine to give:

$$y_1(P) := \frac{P_{\text{sat}1}}{P \cdot \phi_1(P)} \cdot \exp\left(\frac{P \cdot V_1}{R \cdot T}\right)$$

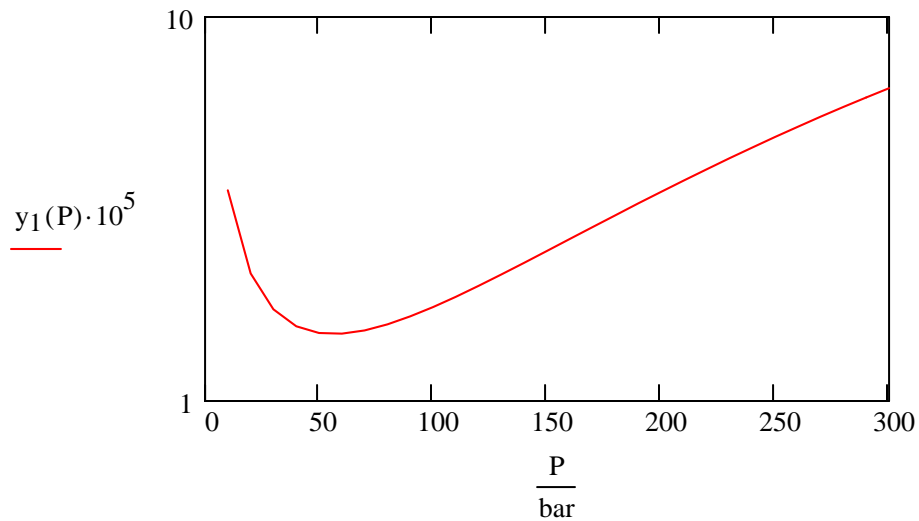

Note: y axis is log scale.

14.45 A labeled diagram of the process is given below. The feed stream is taken as the  $\alpha$  phase and the solvent stream is taken as the  $\beta$  phase.

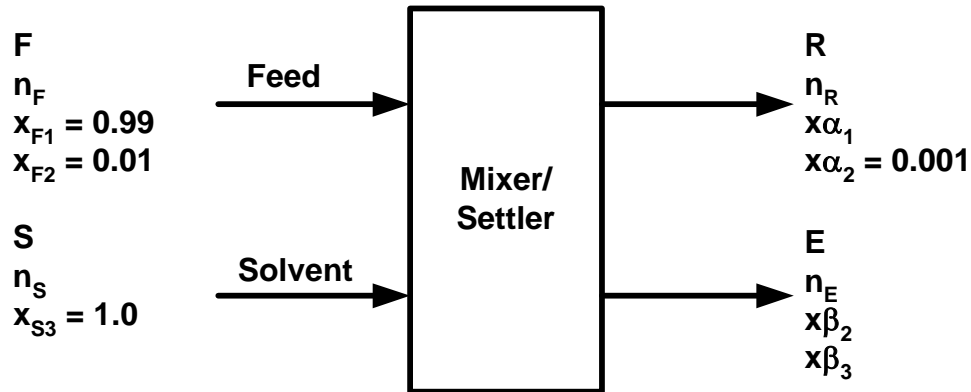

Define the values given in the problem statement. Assume as a basis a feed rate  $n_F = 1 \text{ mol/s}$ .

$$n_F := 1 \frac{\text{mol}}{\text{s}} \quad x_{F1} := 0.99 \quad x_{F2} := 0.01 \quad x_{S3} := 1$$

$$x_{\alpha_2} := 0.001 \quad x_{\alpha_1} := 1 - x_{\alpha_2}$$

Apply mole balances around the process as well as an equilibrium relationship

From p. 585  $A_{12} := 1.5$   $A_{23} := -0.8$

$$\gamma_{\alpha_2}(x_2) := \exp\left[A_{12} \cdot (1 - x_2)^2\right] \quad \gamma_{\beta_2}(x_2) := \exp\left[A_{23} \cdot (1 - x_2)^2\right]$$

**Material Balances**

$$n_S + n_F = n_E + n_R \quad (\text{Total})$$

$$n_S = x_{\beta_3} \cdot n_E \quad (\text{Species 3})$$

$$x_{F1} \cdot n_F = x_{\alpha_1} \cdot n_R \quad (\text{Species 1})$$

Substituting the species balances into the total balance yields

$$n_S + n_F = \frac{1}{x_{\beta_3}} \cdot n_S + \frac{x_{F1}}{x_{\alpha_1}} \cdot n_F$$

Solving for the ratio of solvent to feed ( $n_S/n_F$ ) gives

$$\frac{n_S}{n_F} = \left( \frac{x_{\alpha_1} - x_{F1}}{1 - x_{\beta_3}} \right) \cdot \left( \frac{x_{\beta_3}}{x_{\alpha_1}} \right)$$

We need  $x\beta_3$ . Assume exiting streams are at equilibrium. Here, the only distributing species is 2. Then

$$x\alpha_2 \cdot \gamma\alpha_2 = x\beta_2 \cdot \gamma\beta_2$$

Substituting for  $\gamma\alpha_2$  and  $\gamma\beta_2$

$$x\alpha_2 \cdot \exp\left[A_{12} \cdot (1 - x\alpha_2)^2\right] = x\beta_2 \cdot \exp\left[A_{23} \cdot (1 - x\beta_2)^2\right]$$

Solve for  $x\beta_2$  using Mathcad Solve Block

**Guess:**  $x\beta_2 := 0.5$

Given

$$x\alpha_2 \cdot \exp\left[A_{12} \cdot (1 - x\alpha_2)^2\right] = x\beta_2 \cdot \exp\left[A_{23} \cdot (1 - x\beta_2)^2\right]$$

$$x\beta_2 := \text{Find}(x\beta_2) \quad x\beta_2 = 0.00979 \quad x\beta_3 := 1 - x\beta_2 \quad x\beta_3 = 0.9902$$

From above, the equation for the ratio  $nS/nF$  is:

$$nS/nF := \left(\frac{x\alpha_1 - x_{F1}}{1 - x\beta_3}\right) \cdot \left(\frac{x\beta_3}{x\alpha_1}\right)$$

- a)  $nS/nF = 0.9112$       **Ans.**
- b)  $x\beta_2 = 0.00979$       **Ans.**
- c) "Good chemistry" here means that species 2 and 3 "like" each other, as evidenced by the negative  $G_{23}^E$ . "Bad chemistry" would be reflected in a positive  $G_{23}^E$ , with values less than (essential) but perhaps near to  $G_{12}^E$ .

#### 14.46 1 - n-hexane

2 - water

Since this is a dilute system in both phases, Eqns. (C) and (D) from Example 14.4 on p. 584 can be used to find  $\gamma_1^\alpha$  and  $\gamma_2^\beta$ .

$$x\alpha_1 := \frac{520}{10^6} \quad x\alpha_2 := 1 - x\alpha_1 \quad x\beta_2 := \frac{2}{10^6} \quad x\beta_1 := 1 - x\beta_2$$

$$\gamma\alpha_1 := \frac{x\beta_1}{x\alpha_1} \quad \gamma\alpha_1 = 1.923 \times 10^3 \quad \text{Ans.}$$

$$\gamma\beta_2 := \frac{1 - x\alpha_1}{1 - x\beta_1} \quad \gamma\beta_2 = 4.997 \times 10^5 \quad \text{Ans.}$$

14.50 1 - butanenitrile

$$P_{\text{sat}1} := 0.07287 \text{ bar}$$

$$V_1 := 90 \frac{\text{cm}^3}{\text{mol}}$$

2- benzene

$$P_{\text{sat}2} := 0.29871 \text{ bar}$$

$$V_2 := 92 \frac{\text{cm}^3}{\text{mol}}$$

$$B_{1,1} := -7993 \frac{\text{cm}^3}{\text{mol}}$$

$$B_{2,2} := -1247 \frac{\text{cm}^3}{\text{mol}}$$

$$B_{1,2} := -2089 \frac{\text{cm}^3}{\text{mol}}$$

$$B_{2,1} := B_{1,2}$$

$$T := 318.15 \text{ K}$$

$$P := 0.20941 \text{ bar}$$

$$x_1 := 0.4819$$

$$y_1 := 0.1813$$

$$i := 1..2$$

$$j := 1..2$$

$$k := 1..2$$

$$x_2 := 1 - x_1$$

$$y_2 := 1 - y_1$$

Term A is calculated using the given data.

$$\text{term\_A}_i := \frac{y_i \cdot P}{x_i \cdot P_{\text{sat}i}}$$

Term B is calculated using Eqns. (14.4) and (14.5)

$$\delta_{j,i} := 2 \cdot B_{j,i} - B_{j,j} - B_{i,i}$$

$$\phi_{\text{hat}i} := \exp \left[ \frac{P}{R \cdot T} \cdot \left[ B_{i,i} + \frac{1}{2} \cdot \left[ \sum_j \left[ \sum_k [y_j \cdot y_k \cdot (2\delta_{j,i} - \delta_{j,k})] \right] \right] \right] \right]$$

$$\phi_{\text{sat}i} := \exp \left( \frac{B_{i,i} \cdot P_{\text{sat}i}}{R \cdot T} \right)$$

$$\text{term\_B}_i := \frac{\phi_{\text{hat}i}}{\phi_{\text{sat}i}}$$

Term C is calculated using Eqn. (11.44)

$$f_{\text{sat}i} := \phi_{\text{sat}i} \cdot P_{\text{sat}i} \quad f_i := \phi_{\text{sat}i} \cdot P_{\text{sat}i} \cdot \exp \left[ \frac{V_i \cdot (P - P_{\text{sat}i})}{R \cdot T} \right] \quad \text{term\_C}_i := \frac{f_{\text{sat}i}}{f_i}$$

$$\text{term\_A} = \begin{pmatrix} 1.081 \\ 1.108 \end{pmatrix}$$

$$\text{term\_B} = \begin{pmatrix} 0.986 \\ 1.006 \end{pmatrix}$$

$$\text{term\_C} = \begin{pmatrix} 1 \\ 1 \end{pmatrix}$$

Ans.

**14.51 a)** Equivalent to  $d^2(\Delta G/RT)/dx_1^2 = 0$ , use  $d^2(G^E/RT)/dx_1^2 = -1/x_1x_2$

For  $G^E/RT = Ax_1x_2 = A(x_1-x_1^2)$

$$d(G^E/RT)/dx_1 = A(1-2x_1)$$

$$d^2(G^E/RT)/dx_1^2 = -2A$$

Thus,  $-2A = -1/x_1x_2$  or  $2Ax_1x_2 = 1$ .

Substituting for  $x_2$ :  $x_1-x_1^2 = 1/(2A)$  or  $x_1^2-x_1+1/(2A) = 0$ .

The solution to this equation yields two roots:  $x_1 = \frac{1 + \sqrt{1 - \frac{2}{A}}}{2}$

and  $x_1 = \frac{1 - \sqrt{1 - \frac{2}{A}}}{2}$

The two roots are symmetrical around  $x_1 = 1/2$

Note that for:

**A < 2:** No real roots

**A = 2:** One root,  $x_1 = 1/3$  (consolute point)

**A > 2:** Two real roots,  $x_1 > 0$  and  $x_1 < 1$

**b) Plot the spinodal curve along with the solubility curve**

From Fig. 14.15:  $A(T) := \frac{-540K}{T} + 21.1 - 3 \ln\left(\frac{T}{K}\right)$

Both curves are symmetrical around  $x_1 = 1/2$ . Create functions to represent the left and right halves of the curves.

From above, the equations for the spinodal curves are:

$$x_{spr1}(T) := \frac{1}{2} + \frac{1}{2} \cdot \sqrt{\frac{A(T) - 2}{A(T)}} \quad x_{spl1}(T) := \frac{1}{2} - \frac{1}{2} \cdot \sqrt{\frac{A(T) - 2}{A(T)}}$$

$x_r := 0.7 \quad x_l := 0.3$

From Eq. (E) in Example 14.5, the solubility curves are solved using a Solve Block:

$$\text{Given } A(T) \cdot (1 - 2x_r) = \ln\left(\frac{1 - x_r}{x_r}\right) \quad x_r > 0.5 \quad x_{r1}(T) := \text{Find}(x_r)$$

$$\text{Given } A(T) \cdot (1 - 2x_l) = \ln\left(\frac{1 - x_l}{x_l}\right) \quad x_l < 0.5 \quad x_{l1}(T) := \text{Find}(x_l)$$

**Find the temperature of the upper consolute point.**

$$T := 300\text{K} \quad \text{Given } A(T) = 2 \quad T_u := \text{Find}(T) \quad T_u = 345.998\text{K}$$

$$T := 250\text{K} .. 346\text{K}$$

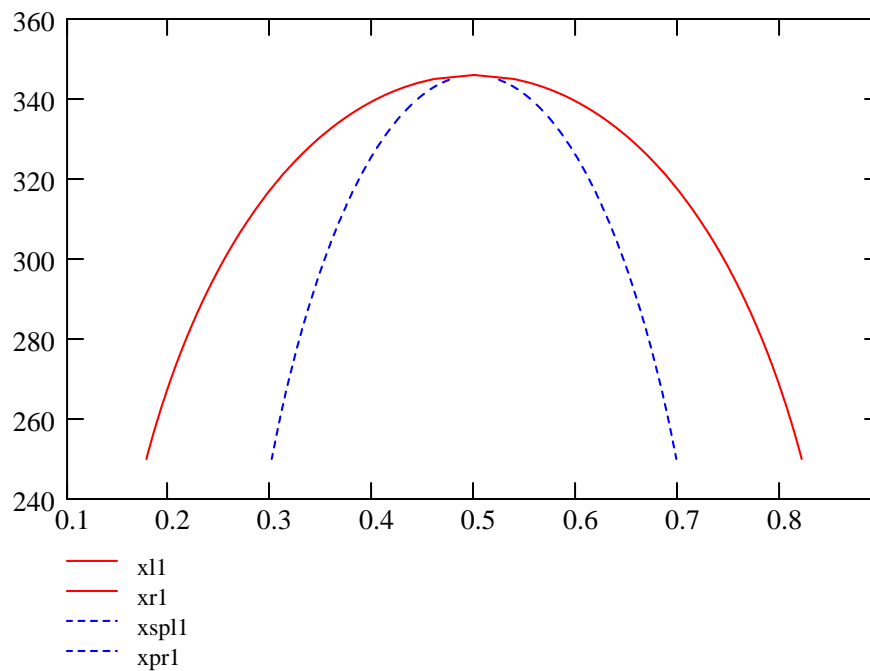

**14.54** The solution is presented for one of the systems given. The solutions for the other systems follow in the same manner.

f) 1- Carbon tetrachloride

$$\omega_1 := 0.193$$

$$T_{c1} := 556.4\text{K}$$

$$P_{c1} := 45.60\text{bar}$$

$$A_1 := 14.0572$$

$$B_1 := 2914.23$$

$$C_1 := 232.148$$

$$P_{\text{sat}1}(T) := \exp\left[ A_1 - \frac{B_1}{\left(\frac{T}{\text{K}} - 273.15\right) + C_1} \right] \text{kPa}$$

## 2 - n-heptane

$$\omega_2 := 0.350$$

$$T_{c2} := 540.2\text{K}$$

$$P_{c2} := 27.40\text{bar}$$

$$A_2 := 13.8622$$

$$B_2 := 2910.26$$

$$C_2 := 216.432$$

$$P_{\text{sat}2}(T) := \exp\left[ A_2 - \frac{B_2}{\left(\frac{T}{\text{K}} - 273.15\right) + C_2} \right] \text{kPa}$$

$$T := (100 + 273.15)\text{K}$$

$$T_{r1} := \frac{T}{T_{c1}}$$

$$T_{r1} = 0.671$$

$$P_{\text{sat}1r} := \frac{P_{\text{sat}1}(T)}{P_{c1}}$$

$$P_{\text{sat}1r} = 0.043$$

$$T_{r2} := \frac{T}{T_{c2}}$$

$$T_{r2} = 0.691$$

$$P_{\text{sat}2r} := \frac{P_{\text{sat}2}(T)}{P_{c2}}$$

$$P_{\text{sat}2r} = 0.039$$

### Using Wilson's equation

$$\Lambda_{12} := 1.5410$$

$$\Lambda_{21} := 0.5197$$

$$\gamma_1(x_1) := \exp\left[ -\ln\left[ x_1 + (1 - x_1) \cdot \Lambda_{12} \right] \dots \right. \\ \left. + (1 - x_1) \cdot \left[ \frac{\Lambda_{12}}{x_1 + (1 - x_1) \cdot \Lambda_{12}} - \frac{\Lambda_{21}}{(1 - x_1) + x_1 \cdot \Lambda_{21}} \right] \right]$$

$$\gamma_2(x_1) := \exp\left[ -\ln\left[ (1 - x_1) + x_1 \cdot \Lambda_{21} \right] \dots \right. \\ \left. + (-x_1) \cdot \left[ \frac{\Lambda_{12}}{x_1 + (1 - x_1) \cdot \Lambda_{12}} - \frac{\Lambda_{21}}{(1 - x_1) + x_1 \cdot \Lambda_{21}} \right] \right]$$

For part i, use the modified Raoult's Law. Define the pressure and vapor mole fraction  $y_1$  as functions of the liquid mole fraction,  $x_1$ .

$$P_i(x_1) := x_1 \cdot \gamma_1(x_1) \cdot P_{\text{sat}1}(T) + (1 - x_1) \cdot \gamma_2(x_1) \cdot P_{\text{sat}2}(T)$$

$$y_{i1}(x_1) := \frac{x_1 \cdot \gamma_1(x_1) \cdot P_{\text{sat}1}(T)}{P_i(x_1)}$$

Modified Raoult's Law: Eqn. (10.5)



**For part ii, assume the vapor phase is an ideal solution. Use Eqn. (11.68) and the PHIB function to calculate  $\phi_{\text{hat}}$  and  $\phi_{\text{sat}}$ .**

$$\phi_{\text{sat}1} := \text{PHIB}(T_{r1}, P_{\text{sat}1r}, \omega_1) \quad \phi_{\text{sat}1} = 0.946$$

$$\phi_{\text{hat}1}(P) := \text{PHIB}\left(T_{r1}, \frac{P}{P_{c1}}, \omega_1\right) \quad \phi_1(P) := \frac{\phi_{\text{hat}1}(P)}{\phi_{\text{sat}1}}$$

$$\phi_{\text{sat}2} := \text{PHIB}(T_{r2}, P_{\text{sat}2r}, \omega_2) \quad \phi_{\text{sat}2} = 0.95$$

$$\phi_{\text{hat}2}(P) := \text{PHIB}\left(T_{r2}, \frac{P}{P_{c2}}, \omega_2\right) \quad \phi_2(P) := \frac{\phi_{\text{hat}2}(P)}{\phi_{\text{sat}2}}$$

**Solve Eqn. (14.1) for  $y_1$  and  $P$  given  $x_1$ .**

**Guess:**  $y_1 := 0.5 \quad P := 1\text{bar}$

Given

$$y_1 \cdot \phi_1(P) \cdot P = x_1 \cdot \gamma_1(x_1) \cdot P_{\text{sat}1}(T) \quad \text{Eqn. (14.1)}$$

$$(1 - y_1) \cdot \phi_2(P) \cdot P = (1 - x_1) \cdot \gamma_2(x_1) \cdot P_{\text{sat}2}(T)$$

$$\text{fii}(x_1) := \text{Find}(P, y_1)$$

**fii is a vector containing the values of  $P$  and  $y_1$ . Extract the pressure,  $P$  and vapor mole fraction,  $y_1$  as functions of the liquid mole fraction.**

$$P_{\text{ii}}(x_1) := \text{fii}(x_1)_0 \quad y_{\text{ii}1}(x_1) := \text{fii}(x_1)_1$$

**Plot the results in Mathcad**  $x_1 := 0, 0.1 \dots 1.0$

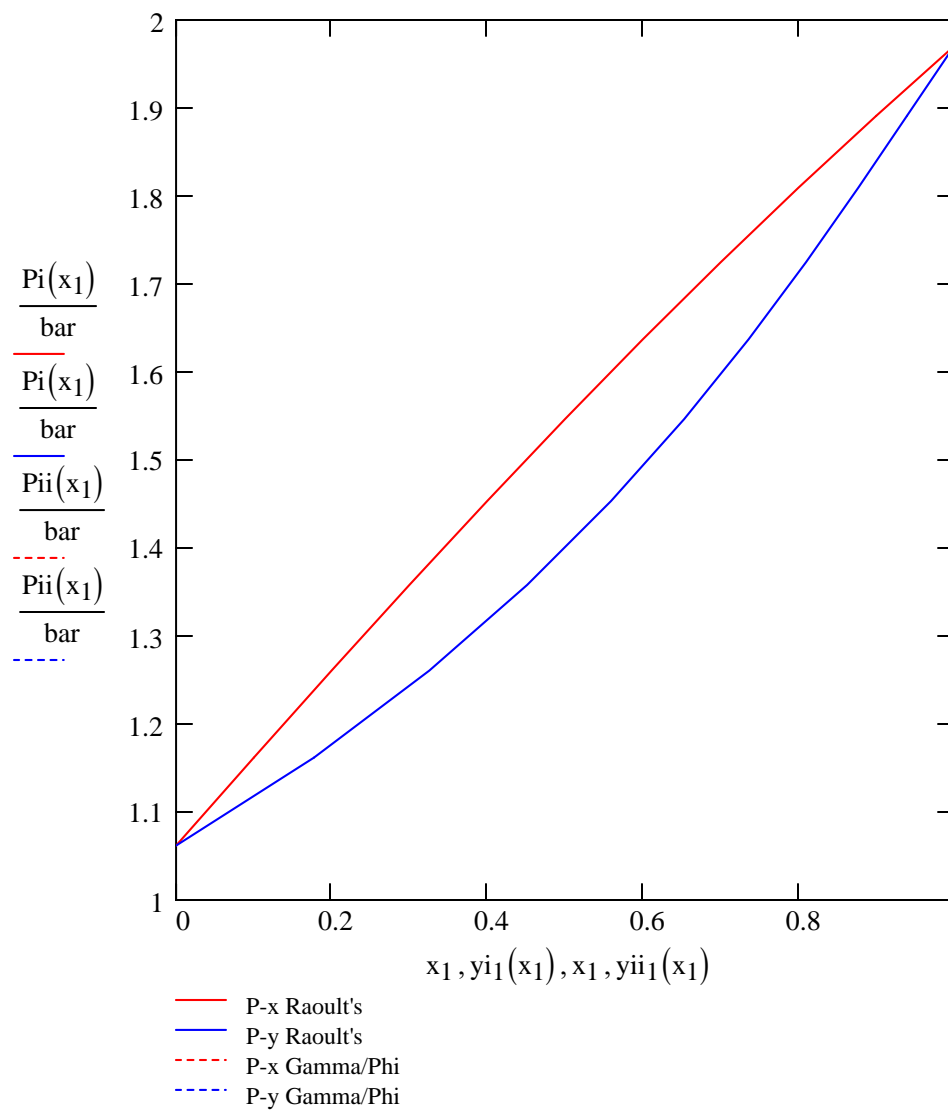

## Chapter 15 - Section A - Mathcad Solutions

15.1 Initial state: Liquid water at 70 degF.

$$H_1 := 38.05 \cdot \frac{\text{BTU}}{\text{lb}_m}$$

$$S_1 := 0.0745 \cdot \frac{\text{BTU}}{\text{lb}_m \cdot \text{rankine}} \quad (\text{Table F.3})$$

Final state: Ice at 32 degF.

$$H_2 := (-0.02 - 143.3) \cdot \frac{\text{BTU}}{\text{lb}_m}$$

$$S_2 := \left( 0.0 - \frac{143.3}{491.67} \right) \cdot \frac{\text{BTU}}{\text{lb}_m \cdot \text{rankine}}$$

$$T_\sigma := (70 + 459.67) \cdot \text{rankine}$$

(a)

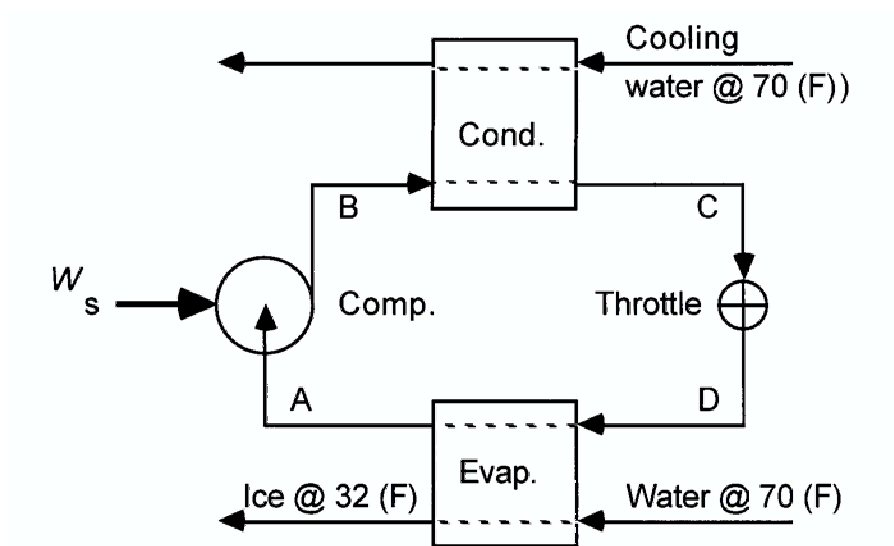

Point A: sat. vapor at 32 degF.

Point C: sat. liquid at 70 degF.  $P = 85.79(\text{psia})$ .

Point D: Mix of sat. liq. & sat. vapor at 32 degF with the enthalpy of Point C.

Point B: Superheated vapor at 85.79(psia) and the entropy of Point A.

Data for Points A, C, & D from Table 9.1. Data for Point B from Fig. G.2.

$$W_{\text{ideal}} := H_2 - H_1 - T_{\sigma} \cdot (S_2 - S_1)$$

$$W_{\text{ideal}} = 12.466 \frac{\text{BTU}}{\text{lb}_m}$$

$$\dot{m} := 1 \cdot \frac{\text{lb}_m}{\text{sec}}$$

$$\dot{W}_{\text{ideal}} := \dot{m} \cdot W_{\text{ideal}}$$

$$\dot{W}_{\text{ideal}} = 13.15 \text{ kW} \quad \text{Ans.}$$

(b) For the Carnot heat pump, heat equal to the enthalpy change of the water is extracted from a cold reservoir at 32 degF, with heat rejection to the surroundings at 70 degF.

$$T_C := 491.67 \cdot \text{rankine} \quad T_H := T_{\sigma} \quad Q_C := H_2 - H_1 \quad Q_C = -181.37 \frac{\text{BTU}}{\text{lb}_m}$$

$$\text{Work} := |Q_C| \cdot \left( \frac{T_H - T_C}{T_C} \right)$$

$$\text{Work} = 14.018 \frac{\text{BTU}}{\text{lb}_m}$$

$$\dot{W} := \dot{m} \cdot \text{Work}$$

$$\dot{W} = 14.79 \text{ kW} \quad \text{Ans.}$$

$$\eta_t := \frac{\dot{W}_{\text{ideal}}}{\dot{W}}$$

$$\eta_t = 0.889 \quad \text{Ans.}$$

The only irreversibility is the transfer of heat from the water as it cools from 70 to 32 degF to the cold reservoir of the Carnot heat pump at 70 degF.

(c) Conventional refrigeration cycle under ideal conditions of operation: Isentropic compression, infinite flow rate of cooling water, & minimum temp. difference for heat transfer = 0.

For sat. liquid and vapor at 32 degF, by interpolation in the table:

$$H_A := 107.60 \cdot \frac{\text{BTU}}{\text{lb}_m}$$

$$S_A := 0.2223 \cdot \frac{\text{BTU}}{\text{lb}_m \cdot \text{rankine}}$$

For sat. liquid at 70 degF:

$$H_C := 34.58 \cdot \frac{\text{BTU}}{\text{lb}_m}$$

$$H_D := H_C$$

For superheated vapor at 85.79(psia) and S = 0.2223:

$$H_B := 114 \cdot \frac{\text{BTU}}{\text{lb}_m}$$

**Refrigerent circulation rate:**

$$\dot{m} := \frac{-(H_2 - H_1) \cdot 1 \cdot \frac{\text{lb}_m}{\text{sec}}}{H_A - H_D}$$

$$\dot{m} = 2.484 \frac{\text{lb}_m}{\text{sec}}$$

$$\dot{W} := \dot{m} \cdot (H_B - H_A)$$

$$\dot{W} = 16.77 \text{ kW}$$

**Ans.**

$$\eta_t := \frac{\dot{W}_{\text{ideal}}}{\dot{W}}$$

$$\eta_t = 0.784$$

**Ans.**

The irreversibilities are in the throttling process and in heat transfer in both the condenser and evaporator, where there are finite temperature differences.

(d) Practical cycle.

$$\eta := 0.75$$

Point A: Sat. vapor at 24 degF.

Point B: Superheated vapor at 134.75(psia).

Point D: Mix of sat. liq. and sat. vapor at 24 degF with H of point C,

Point C: Sat. Liquid at 98 degF.

(Note that minimum temp. diff. is not at end of condenser, but it is not practical to base design on 8-degF temp. diff. at pinch. See sketch.)

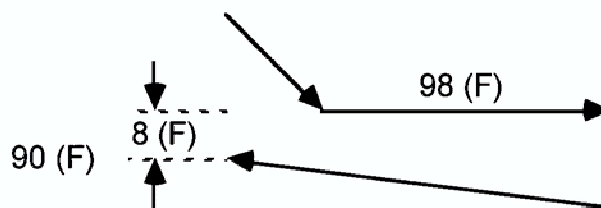

For sat. liquid and vapor at 24 degF:

$$H_{\text{liq}} := 19.58 \cdot \frac{\text{BTU}}{\text{lb}_m}$$

$$H_{\text{vap}} := 106.48 \cdot \frac{\text{BTU}}{\text{lb}_m}$$

$$H_A := H_{\text{vap}}$$

$$S_{\text{liq}} := 0.0433 \cdot \frac{\text{BTU}}{\text{lb}_m \cdot \text{rankine}}$$

$$S_{\text{vap}} := 0.2229 \cdot \frac{\text{BTU}}{\text{lb}_m \cdot \text{rankine}}$$

$$S_A := S_{\text{vap}}$$

For sat. liquid at 98 degF, P=134.75(psia):

$$H_C := 44.24 \cdot \frac{\text{BTU}}{\text{lb}_m}$$

$$S_C := 0.0902 \cdot \frac{\text{BTU}}{\text{lb}_m \cdot \text{rankine}}$$

For isentropic compression, the entropy of Point B is 0.2229 at P=134.75(psia). From Fig. G.2,

$$H'_B := 118 \cdot \frac{\text{BTU}}{\text{lb}_m}$$

$$H_B := H_A + \frac{H'_B - H_A}{\eta}$$

$$H_B = 121.84 \cdot \frac{\text{BTU}}{\text{lb}_m}$$

The entropy at this H is read from Fig. G.2 at P=134.75(psia)

$$S_B := 0.228 \cdot \frac{\text{BTU}}{\text{lb}_m \cdot \text{rankine}}$$

$$H_D := H_C$$

$$x_D := \frac{H_D - H_{\text{liq}}}{H_{\text{vap}} - H_{\text{liq}}}$$

$$x_D = 0.284$$

$$S_D := S_{\text{liq}} + x_D \cdot (S_{\text{vap}} - S_{\text{liq}})$$

$$S_D = 0.094 \cdot \frac{\text{BTU}}{\text{lb}_m \cdot \text{rankine}}$$

Refrigerent circulation rate:

$$\dot{m} := \frac{-(H_2 - H_1) \cdot 1 \cdot \frac{\text{lb}_m}{\text{sec}}}{H_A - H_D}$$

$$\dot{m} = 2.914 \cdot \frac{\text{lb}_m}{\text{sec}}$$

$$\dot{W} := \dot{m} \cdot (H_B - H_A)$$

$$\dot{W} = 47.22 \text{ kW} \quad \text{Ans.}$$

$$\eta_t := \frac{\dot{W}_{\text{ideal}}}{\dot{W}}$$

$$\eta_t = 0.279 \quad \text{Ans.}$$

THERMODYNAMIC ANALYSIS

$$T_\sigma := (70 + 459.67) \cdot \text{rankine}$$

$$\dot{W}_{\text{lost.compressor}} := \dot{m} \cdot T_\sigma \cdot (S_B - S_A)$$

$$\dot{Q}_{\text{condenser}} := \dot{m} \cdot (H_C - H_B)$$

$$\dot{W}_{\text{lost.condenser}} := \dot{m} \cdot T_\sigma \cdot (S_C - S_B) - \dot{Q}_{\text{condenser}}$$

$$\dot{W}_{\text{lost,throttle}} := \dot{m} \cdot T_{\sigma} \cdot (\mathcal{S}_D - \mathcal{S}_C)$$

$$\dot{W}_{\text{lost,evaporator}} := T_{\sigma} \cdot \left[ \dot{m} \cdot (\mathcal{S}_A - \mathcal{S}_D) \dots \right. \\ \left. + 1 \cdot \frac{\text{lb}_m}{\text{sec}} \cdot (\mathcal{S}_2 - \mathcal{S}_1) \right]$$

$$\dot{W}_{\text{ideal}} = 13.152 \text{ kW} \quad \mathbf{27.85\%}$$

$$\dot{W}_{\text{lost,compressor}} = 8.305 \text{ kW} \quad \mathbf{17.59\%}$$

$$\dot{W}_{\text{lost,condenser}} = 14.178 \text{ kW} \quad \mathbf{30.02\%}$$

$$\dot{W}_{\text{lost,throttle}} = 6.621 \text{ kW} \quad \mathbf{14.02\%}$$

$$\dot{W}_{\text{lost,evaporator}} = 4.968 \text{ kW} \quad \mathbf{10.52\%}$$

The percent values above express each quantity as a percentage of the actual work, to which the quantities sum.

## 15.2 Assume ideal gases. Data from Table C.4

$$\Delta H_{298} := -282984 \cdot \text{J}$$

$$\Delta G_{298} := -257190 \cdot \text{J}$$

$$\Delta S_{298} := \frac{\Delta H_{298} - \Delta G_{298}}{298.15 \cdot \text{K}}$$

$$\Delta S_{298} = -86.513 \frac{\text{J}}{\text{K}}$$

**BASIS: 1 mol CO and 1/2 mol O2 entering with accompanying N2=(1/2)(79/21)=1.881 mol**

$$n_{\text{CO}} := 1 \cdot \text{mol}$$

$$n_{\text{air}} := 2.381 \cdot \text{mol}$$

$$n_{\text{CO}_2} := 1 \cdot \text{mol}$$

$$n_{\text{N}_2} := 1.881 \cdot \text{mol}$$

(a) Isothermal process at 298.15 K:

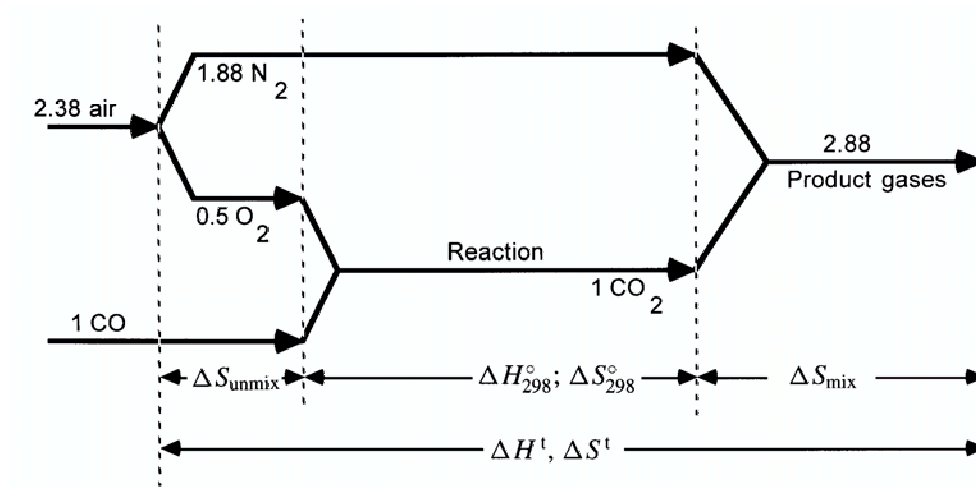

Since the enthalpy change of mixing for ideal gases is zero, the overall enthalpy change for the process is

$\Delta H := \Delta H_{298}$       For unmixing the air, define

$$y_1 := \frac{n_{N_2}}{n_{air}} \quad y_1 = 0.79 \quad y_2 := 1 - y_1$$

By Eq. (12.35) with no minus sign:

$$\Delta S_{unmixing} := n_{air} \cdot R \cdot (y_1 \cdot \ln(y_1) + y_2 \cdot \ln(y_2))$$

$$\Delta S_{unmixing} = -10.174 \frac{J}{K}$$

For mixing the products of reaction, define

$$y_1 := \frac{n_{CO_2}}{n_{N_2} + n_{CO_2}} \quad y_1 = 0.347 \quad y_2 := 1 - y_1$$

$$\Delta S_{mixing} := -(n_{CO_2} + n_{N_2}) \cdot R \cdot (y_1 \cdot \ln(y_1) + y_2 \cdot \ln(y_2)) \quad \Delta S_{mixing} = 15.465 \frac{J}{K}$$

$$\Delta S := \Delta S_{unmixing} + \Delta S_{298} + S_{mixing} \quad \Delta S = -81.223 \frac{J}{K}$$

$$T_\sigma := 300 \cdot K \quad W_{ideal} := \Delta H - T_\sigma \cdot \Delta S \quad W_{ideal} = -259 \text{ kJ} \quad \text{Ans.}$$



(b) Adiabatic combustion:

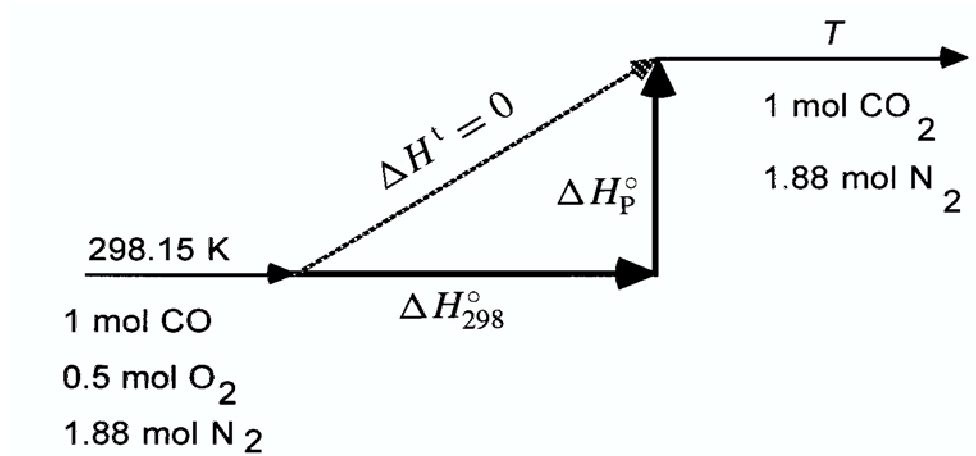

Heat-capacity data for the product gases from Table C.1:

$$A := \frac{n_{\text{CO}_2} \cdot 5.457 + n_{\text{N}_2} \cdot 3.280}{\text{mol}} \quad A = 11.627$$

$$B := \frac{n_{\text{CO}_2} \cdot 1.045 + n_{\text{N}_2} \cdot 0.593}{\text{mol}} \cdot 10^{-3} \quad B = 2.16 \times 10^{-3}$$

$$D := \frac{n_{\text{CO}_2} \cdot -1.157 + n_{\text{N}_2} \cdot 0.040}{\text{mol}} \cdot 10^5 \quad D = -1.082 \times 10^5$$

For the products, 
$$\Delta H_P = R \cdot \int_{T_0}^T \frac{C_P}{R} dT \quad T_0 := 298.15 \cdot \text{K}$$

The integral is given by Eq. (4.7). Moreover, by an energy balance,

$$\Delta H_{298} + \Delta H_P = 0$$

**Guess**  $\tau := 2 \quad A := 11.627 \quad B := \frac{2.160 \cdot 10^{-3}}{\text{K}} \quad D := -1.082 \cdot 10^5 \cdot \text{K}^2$

Given

$$\Delta H_{298} = -R \cdot \text{mol} \cdot \left[ A \cdot T_0 \cdot \left( \frac{T}{T_0} \right) - 1 + \frac{B}{2} \cdot \left( \frac{T}{T_0} \right)^2 - 1 + \frac{D}{T_0} \cdot \left( \frac{\tau - 1}{\tau} \right) \right]$$

$\tau := \text{Find}(\tau) \quad \tau = 8.796 \quad T := T_0 \cdot \tau \quad T = 2622.603 \text{ K}$

For the cooling process from this temperature to the final temperature of 298.15 K, the entropy change is calculated by

$$\text{ICPS} \left( 2622.6, 298.15, 11.627, 2.160 \cdot 10^{-3}, 0.0, -1.082 \cdot 10^5 \right) = -29.701$$

$$\text{ICPS} := -29.701$$

$$\Delta S := R \cdot \text{mol} \cdot \text{ICPS}$$

$$\Delta S = -246.934 \frac{\text{J}}{\text{K}}$$

$$\Delta H := \Delta H_{298}$$

$$W_{\text{ideal,cooling}} := \Delta H - T_{\sigma} \cdot \Delta S$$

$$\Delta H = -2.83 \times 10^5 \text{ J}$$

$$W_{\text{ideal,cooling}} = -208904 \text{ J} \quad \text{Ans.}$$

$$\eta_t := \frac{W_{\text{ideal,cooling}}}{W_{\text{ideal}}}$$

$$\eta_t = 0.8078 \quad \text{Ans.}$$

The surroundings increase in entropy in the amount:

$$Q_{\sigma} := -(\Delta H_{298} - W_{\text{ideal,cooling}})$$

$$\Delta S_{\sigma} := \frac{Q_{\sigma}}{T_{\sigma}}$$

$$\Delta S_{\sigma} = 246.93 \frac{\text{J}}{\text{K}}$$

The irreversibility is in the combustion reaction. Ans.

15.3

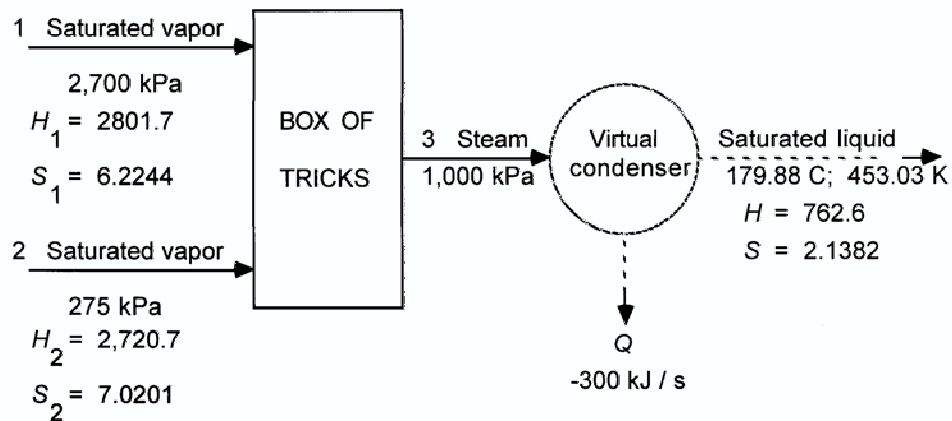

For the sat. steam at 2700 kPa, Table F.2:

$$H_1 := 2801.7 \cdot \frac{\text{kJ}}{\text{kg}}$$

$$S_1 := 6.2244 \cdot \frac{\text{kJ}}{\text{kg} \cdot \text{K}}$$

For the sat. steam at 275 kPa, Table F.2:

$$H_2 := 2720.7 \cdot \frac{\text{kJ}}{\text{kg}}$$

$$S_2 := 7.0201 \cdot \frac{\text{kJ}}{\text{kg} \cdot \text{K}}$$

For sat. liquid and vapor at 1000 kPa, Table F.2:

$$H_{\text{liq}} := 762.6 \frac{\text{kJ}}{\text{kg}}$$

$$S_{\text{liq}} := 2.1382 \frac{\text{kJ}}{\text{kg} \cdot \text{K}}$$

$$H_{\text{vap}} := 2776.2 \frac{\text{kJ}}{\text{kg}}$$

$$S_{\text{vap}} := 6.5828 \frac{\text{kJ}}{\text{kg} \cdot \text{K}}$$

$$T_{\text{sat}} := 453.03 \text{K}$$

(a) Assume no heat losses, no shaft work, and negligible changes in kinetic and potential energy. Then by Eqs. (2.30) and (5.22) for a completely reversible process:

$$\Delta_{\text{fs}}(H \cdot \dot{m}) = 0 \quad \Delta_{\text{fs}}(S \cdot \dot{m}) = 0$$

We can also write a material balance, a quantity requirement, and relation between H3 and S3 which assumes wet steam at point 3.

The five equations (in 5 unknowns) are as follows:

**Guesses:**  $\dot{m}_1 := 0.1 \frac{\text{kg}}{\text{s}}$      $\dot{m}_2 := \dot{m}_1$      $\dot{m}_3 := \dot{m}_1 + \dot{m}_2$

$$H_3 := \frac{H_1 + H_2}{2} \quad S_3 := S_{\text{liq}} + \frac{H_3 - H_{\text{liq}}}{T_{\text{sat}}}$$

Given

$$H_3 \cdot \dot{m}_3 - H_1 \cdot \dot{m}_1 - H_2 \cdot \dot{m}_2 = 0 \frac{\text{kJ}}{\text{s}}$$

$$S_3 \cdot \dot{m}_3 - S_1 \cdot \dot{m}_1 - S_2 \cdot \dot{m}_2 = 0 \frac{\text{kJ}}{\text{s} \cdot \text{K}}$$

$$\dot{m}_3 = \dot{m}_1 + \dot{m}_2 \quad (H_3 - H_{\text{liq}}) \cdot \dot{m}_3 = 300 \frac{\text{kJ}}{\text{s}}$$

$$S_3 = S_{\text{liq}} + \frac{H_3 - H_{\text{liq}}}{T_{\text{sat}}}$$

$$\begin{pmatrix} \dot{m}_1 \\ \dot{m}_2 \\ \dot{m}_3 \\ H_3 \\ S_3 \end{pmatrix} := \text{Find}(\dot{m}_1, \dot{m}_2, \dot{m}_3, H_3, S_3)$$

$$\dot{m}_1 = 0.086 \frac{\text{kg}}{\text{s}}$$

$$\dot{m}_2 = 0.064 \frac{\text{kg}}{\text{s}}$$

$$\dot{m}_3 = 0.15 \frac{\text{kg}}{\text{s}}$$

$$H_3 = 2.767 \times 10^3 \frac{\text{kJ}}{\text{kg}}$$

$$S_3 = 6.563 \frac{\text{kJ}}{\text{kg}\cdot\text{K}}$$

Ans.

Steam at Point 3 is indeed wet.

**(b) Turbine: Constant-S expansion of steam from Point 1 to 1000 kPa results in wet steam of quality**

$$x'_{\text{turb}} := \frac{S_1 - S_{\text{liq}}}{S_{\text{vap}} - S_{\text{liq}}}$$

$$x'_{\text{turb}} = 0.919$$

$$\eta_{\text{turb}} := 0.78$$

$$x_{\text{turb}} := \frac{H_{\text{turb}} - H_{\text{liq}}}{H_{\text{vap}} - H_{\text{liq}}}$$

$$x_{\text{turb}} = 0.94$$

$$H'_{\text{turb}} := H_{\text{liq}} + x'_{\text{turb}} \cdot (H_{\text{vap}} - H_{\text{liq}})$$

$$H'_{\text{turb}} = 2.614 \times 10^3 \frac{\text{kJ}}{\text{kg}}$$

$$H_{\text{turb}} := H_1 + \eta_{\text{turb}} \cdot (H'_{\text{turb}} - H_1)$$

$$H_{\text{turb}} = 2.655 \times 10^3 \frac{\text{kJ}}{\text{kg}}$$

$$S_{\text{turb}} := S_{\text{liq}} + x_{\text{turb}} \cdot (S_{\text{vap}} - S_{\text{liq}})$$

$$S_{\text{turb}} = 6.316 \frac{\text{kJ}}{\text{kg}\cdot\text{K}}$$

**Compressor: Constant-S compression of steam from Point 2 to 1000 kPa results in superheated steam. Interpolation in Table F.2 yields**

$$H'_{\text{comp}} := 2993.5 \frac{\text{kJ}}{\text{kg}}$$

$$\eta_{\text{comp}} := 0.75$$

$$H_{\text{comp}} := H_2 + \left( \frac{H'_{\text{comp}} - H_2}{\eta_{\text{comp}}} \right)$$

$$H_{\text{comp}} = 3084.4 \frac{\text{kJ}}{\text{kg}}$$

By interpolation:

$$S_{\text{comp}} := 7.1803 \frac{\text{kJ}}{\text{kg}\cdot\text{K}}$$

The energy balance, mass balance, and quantity requirement equations of Part (a) are still valid. In addition, The work output of the turbine equals the work input of the compressor. Thus we have 4 equations (in 4 unknowns):

Guesses:  $\dot{m}_1 := 0.086 \frac{\text{kg}}{\text{s}}$        $\dot{m}_2 := 0.064 \frac{\text{kg}}{\text{s}}$   
 $\dot{m}_3 := 0.15 \frac{\text{kg}}{\text{s}}$        $H_3 := 2770. \frac{\text{kJ}}{\text{kg}}$

Given

$$\dot{H}_{\text{comp}} - H_2 \cdot \dot{m}_2 = -(\dot{H}_{\text{turb}} - H_1 \cdot \dot{m}_1)$$

$$H_3 \cdot \dot{m}_3 - H_1 \cdot \dot{m}_1 - H_2 \cdot \dot{m}_2 = 0 \frac{\text{kJ}}{\text{s}}$$

$$\dot{m}_3 = \dot{m}_1 + \dot{m}_2 \quad (H_3 - H_{\text{liq}}) \cdot \dot{m}_3 = 300 \frac{\text{kJ}}{\text{s}}$$

$$\begin{pmatrix} \dot{m}_1 \\ \dot{m}_2 \\ \dot{m}_3 \\ H_3 \end{pmatrix} := \text{Find}(\dot{m}_1, \dot{m}_2, \dot{m}_3, H_3)$$

$$\dot{m}_1 = 0.10608 \frac{\text{kg}}{\text{s}}$$

$$\dot{m}_2 = 0.04274 \frac{\text{kg}}{\text{s}}$$

$$\dot{m}_3 = 0.14882 \frac{\text{kg}}{\text{s}}$$

$$H_3 = 2.77844 \times 10^3 \frac{\text{kJ}}{\text{kg}}$$

Ans.

Steam at Point 3 is slightly superheated.

By interpolation,

$$S_3 := 6.5876 \frac{\text{kJ}}{\text{kg} \cdot \text{K}}$$

THERMODYNAMIC ANALYSIS

$$T_\sigma := 300\text{K}$$

(assumed)

By Eq. (5.25), with the enthalpy term equal to zero:

$$\dot{W}_{\text{ideal}} := T_\sigma \cdot (\dot{m}_3 \cdot S_3 - \dot{m}_1 \cdot S_1 - \dot{m}_2 \cdot S_2)$$

$$\dot{W}_{\text{ideal}} = 6.014 \text{ kW}$$

$$\dot{W}_{\text{lost.turb}} := T_{\sigma} \cdot \dot{m}_1 \cdot (\phi_{\text{turb}} - S_1)$$

$$\dot{W}_{\text{lost.comp}} := T_{\sigma} \cdot \dot{m}_2 \cdot (\phi_{\text{comp}} - S_2)$$

$$\dot{W}_{\text{lost.mixing}} := T_{\sigma} \cdot [\dot{m}_3 \cdot S_3 - \dot{m}_1 \cdot S_{\text{turb}} - \dot{m}_2 \cdot S_{\text{comp}}]$$

$$\dot{W}_{\text{lost.turb}} = 2.9034 \text{ kW} \quad 48.2815\%$$

$$\dot{W}_{\text{lost.comp}} = 2.054 \text{ kW} \quad 34.1565\%$$

$$\dot{W}_{\text{lost.mixing}} = 1.0561 \text{ kW} \quad 17.5620\%$$

The percent values above express each quantity as a percentage of the absolute value of the ideal work, to which the quantities sum.

**15.4** Some property values with reference to Fig. 9.1 are given in Example 9.1. Others come from Table 9.1 or Fig. G.2.

For sat. liquid and vapor at the evaporator temperature of 0 degF:

$$H_{\text{liq}} := 12.090 \frac{\text{BTU}}{\text{lb}_m}$$

$$H_{\text{vap}} := 103.015 \frac{\text{BTU}}{\text{lb}_m}$$

$$S_{\text{vap}} := 0.22525 \frac{\text{BTU}}{\text{lb}_m \cdot \text{rankine}}$$

$$S_{\text{liq}} := 0.02744 \frac{\text{BTU}}{\text{lb}_m \cdot \text{rankine}}$$

For sat. liquid at the condenser outlet temperature of 80 degF:

$$H_4 := 37.978 \frac{\text{BTU}}{\text{lb}_m}$$

$$S_4 := 0.07892 \frac{\text{BTU}}{\text{lb}_m \cdot \text{rankine}}$$

$$H_2 := H_{\text{vap}} \quad S_2 := S_{\text{vap}} \quad H_1 := H_4$$

$$x_1 := \frac{H_1 - H_{\text{liq}}}{H_{\text{vap}} - H_{\text{liq}}}$$

$$S_1 := S_{\text{liq}} + x_1 \cdot (\phi_{\text{vap}} - S_{\text{liq}})$$

$$x_1 = 0.285$$

$$S_1 = 0.084 \frac{\text{BTU}}{\text{lb}_m \cdot \text{rankine}}$$

From Example 9.1(b) for the compression step:

$$\Delta H := 17.48 \cdot \frac{\text{BTU}}{\text{lb}_m}$$

$$H_3 := H_2 + \Delta H$$

$$H_3 = 120.5 \frac{\text{BTU}}{\text{lb}_m}$$

From Fig. G.2 at  $H_3$  and  $P = 101.37(\text{psia})$ :

$$S_3 := 0.231 \cdot \frac{\text{BTU}}{\text{lb}_m \cdot \text{rankine}}$$

$$\dot{m} := 1845.1 \cdot \frac{\text{lb}_m}{\text{hr}}$$

$$\dot{W} := \dot{m} \cdot \Delta H$$

$$\dot{W} = 3.225 \times 10^4 \frac{\text{BTU}}{\text{hr}}$$

The purpose of the condenser is to transfer heat to the surroundings. Thus the heat transferred in the condenser is  $Q$  in the sense of Chapter 15; i.e., it is heat transfer to the SURROUNDINGS, taken here to be at a temperature of 70 degF.

Internal heat transfer (within the system) is not  $Q$ . The heat transferred in the evaporator comes from a space maintained at 10 degF, which is part of the system, and is treated as an internal heat reservoir.

The ideal work of the process is that of a Carnot engine operating between the temperature of the refrigerated space and the temperature of the surroundings.

$$T_\sigma := (70 + 459.67) \cdot \text{rankine}$$

$$T_H := T_\sigma$$

$$\dot{Q}_C := -120000 \frac{\text{BTU}}{\text{hr}}$$

$$T_C := (10 + 459.67) \cdot \text{rankine}$$

$$\dot{W}_{\text{ideal}} := |\dot{Q}_C| \cdot \frac{T_H - T_C}{T_C}$$

$$\dot{W}_{\text{ideal}} = 1.533 \times 10^4 \frac{\text{BTU}}{\text{hr}}$$

$$\dot{W}_{\text{lost,comp}} := T_\sigma \cdot \dot{m} \cdot (s_3 - s_2)$$

$$\dot{Q} := (H_4 - H_3) \cdot \dot{m}$$

$$\dot{Q} = -1.523 \times 10^5 \frac{\text{BTU}}{\text{hr}}$$

$$\dot{W}_{\text{lost,cond}} := T_\sigma \cdot \dot{m} \cdot (s_4 - s_3) - \dot{Q}$$

$$\dot{W}_{\text{lost,throttle}} := T_\sigma \cdot \dot{m} \cdot (s_1 - s_4)$$

$$\dot{W}_{\text{lost, evap}} := T_{\sigma} \cdot \dot{m} \cdot (s_2 - s_1) \dots$$

$$+ T_{\sigma} \cdot \frac{H_1 - H_2}{T_C} \cdot \dot{m}$$

The final term accounts for the entropy change of the refrigerated space (an internal heat reservoir).

$$\dot{W}_{\text{ideal}} = 15329.9 \frac{\text{BTU}}{\text{hr}} \quad 47.53\%$$

$$\dot{W}_{\text{lost, comp}} = 5619.4 \frac{\text{BTU}}{\text{hr}} \quad 17.42\%$$

$$\dot{W}_{\text{lost, cond}} = 3625.2 \frac{\text{BTU}}{\text{hr}} \quad 11.24\%$$

$$\dot{W}_{\text{lost, throttle}} = 4730.2 \frac{\text{BTU}}{\text{hr}} \quad 14.67\%$$

$$\dot{W}_{\text{lost, evap}} = 2947.6 \frac{\text{BTU}}{\text{hr}} \quad 9.14\%$$

The percent values above express each quantity as a percentage of the actual work, to which they sum:

$$\dot{W} = 32252.3 \frac{\text{BTU}}{\text{hr}}$$

15.5 The discussion at the top of the second page of the solution to the preceding problem applies equally here. In each case,

$$T_{\sigma} := (70 + 459.67) \cdot \text{rankine} \quad T_H := T_{\sigma}$$

The following vectors refer to Parts (a)-(e):

$$t_C := \begin{pmatrix} 40 \\ 30 \\ 20 \\ 10 \\ 0 \end{pmatrix}$$

$$\dot{Q}_{\text{dot } C} := - \begin{pmatrix} 600 \\ 500 \\ 400 \\ 300 \\ 200 \end{pmatrix} \cdot \frac{\text{BTU}}{\text{sec}}$$



$$T_C := ( )_C + 459.67 \cdot \text{rankine} \quad \dot{W}_{\text{ideal}} := \left( \overrightarrow{\left[ |\dot{Q}_C| \cdot \frac{T_H - T_C}{T_C} \right]} \right)$$

**For sat. liquid and vapor at the evaporator temperature, Table 9.1:**

$$H_{\text{liq}} := \begin{pmatrix} 21.486 \\ 18.318 \\ 15.187 \\ 12.090 \\ 9.026 \end{pmatrix} \cdot \frac{\text{BTU}}{\text{lb}_m} \quad H_{\text{vap}} := \begin{pmatrix} 107.320 \\ 105.907 \\ 104.471 \\ 103.015 \\ 101.542 \end{pmatrix} \cdot \frac{\text{BTU}}{\text{lb}_m} \quad H_2 := H_{\text{vap}}$$

$$S_{\text{liq}} := \begin{pmatrix} 0.04715 \\ 0.04065 \\ 0.03408 \\ 0.02744 \\ 0.02073 \end{pmatrix} \cdot \frac{\text{BTU}}{\text{lb}_m \cdot \text{rankine}} \quad S_{\text{vap}} := \begin{pmatrix} 0.22244 \\ 0.22325 \\ 0.22418 \\ 0.22525 \\ 0.22647 \end{pmatrix} \cdot \frac{\text{BTU}}{\text{lb}_m \cdot \text{rankine}} \quad S_2 := S_{\text{vap}}$$

**For sat. liquid at the condenser temperature:**

$$H_4 := 37.978 \cdot \frac{\text{BTU}}{\text{lb}_m} \quad S_4 := 0.07892 \cdot \frac{\text{BTU}}{\text{lb}_m \cdot \text{rankine}} \quad H_1 := H_4$$

$$x_1 := \frac{\overrightarrow{H_1 - H_{\text{liq}}}}{H_{\text{vap}} - H_{\text{liq}}} \quad S_1 := \left[ S_{\text{liq}} + x_1 \cdot \left( S_{\text{vap}} - S_{\text{liq}} \right) \right]$$

**From the results of Pb. 9.9, we find:**

$$H_3 := \begin{pmatrix} 117.7 \\ 118.9 \\ 120.1 \\ 121.7 \\ 123.4 \end{pmatrix} \cdot \frac{\text{BTU}}{\text{lb}_m}$$

**From these values we must find the corresponding entropies from Fig. G.2. They are read at the vapor pressure for 80 degF of 101.37 kPa. The flow rates come from Problem 9.9:**

$$S_3 := \begin{pmatrix} 0.227 \\ 0.229 \\ 0.231 \\ 0.234 \\ 0.237 \end{pmatrix} \cdot \frac{\text{BTU}}{\text{lb}_m \cdot \text{rankine}}$$

$$\dot{m} := \begin{pmatrix} 8.653 \\ 7.361 \\ 6.016 \\ 4.613 \\ 3.146 \end{pmatrix} \cdot \frac{\text{lb}_m}{\text{sec}}$$

$$\dot{W}_{\text{lost,comp}} := \overrightarrow{[T_\sigma \cdot \dot{m} \cdot (S_3 - S_2)]}$$

$$\dot{Q} := \overrightarrow{[(H_4 - H_3) \cdot \dot{m}]}$$

$$\dot{W}_{\text{lost,cond}} := \overrightarrow{[T_\sigma \cdot \dot{m} \cdot (S_4 - S_3)]} - \dot{Q}$$

$$\dot{W}_{\text{lost,throttle}} := \overrightarrow{[T_\sigma \cdot \dot{m} \cdot (S_1 - S_4)]}$$

$$\dot{W}_{\text{lost,evap}} := \overrightarrow{[T_\sigma \cdot \dot{m} \cdot (S_2 - S_1)]} \dots \\ + \overrightarrow{\left[ \left( T_\sigma \cdot \frac{H_1 - H_2}{T_C} \right) \cdot \dot{m} \right]}$$

**The final term accounts for the entropy change of the refrigerated space (an internal heat reservoir).**

$$\dot{W}_{\text{dot}} := \overrightarrow{[\dot{m} \cdot (H_3 - H_2)]}$$

$$\dot{W}_{\text{dot,ideal}} = \begin{pmatrix} 36.024 \\ 40.844 \\ 41.695 \\ 38.325 \\ 30.457 \end{pmatrix} \frac{\text{BTU}}{\text{sec}}$$

$$\dot{W}_{\text{lost,comp}} = \begin{pmatrix} 20.9 \\ 22.419 \\ 21.732 \\ 21.379 \\ 17.547 \end{pmatrix} \frac{\text{BTU}}{\text{sec}}$$

$$\dot{W}_{\text{lost.cond}} = \begin{pmatrix} 11.149 \\ 10.52 \\ 9.444 \\ 7.292 \\ 5.322 \end{pmatrix} \frac{\text{BTU}}{\text{sec}}$$

$$\dot{W}_{\text{lost.throttle}} = \begin{pmatrix} 8.754 \\ 10.589 \\ 11.744 \\ 11.826 \\ 10.322 \end{pmatrix} \frac{\text{BTU}}{\text{sec}}$$

$$\dot{W}_{\text{lost.evap}} = \begin{pmatrix} 12.991 \\ 11.268 \\ 9.406 \\ 7.369 \\ 5.122 \end{pmatrix} \frac{\text{BTU}}{\text{sec}}$$

$$\dot{W} = \begin{pmatrix} 89.818 \\ 95.641 \\ 94.024 \\ 86.194 \\ 68.765 \end{pmatrix} \frac{\text{BTU}}{\text{sec}}$$

In each case the ideal work and the lost work terms sum to give the actual work, and each term may be expressed as a percentage of the actual work.

15.6 The discussion at the top of the second page of the solution to Problem 15.4 applies equally here.

$$T_{\sigma} := (70 + 459.67) \cdot \text{rankine}$$

$$T_H := T_{\sigma}$$

$$T_C := (30 + 459.67) \cdot \text{rankine}$$

$$\dot{Q}_{\text{dot}_C} := -2000 \cdot \frac{\text{BTU}}{\text{sec}}$$

$$\dot{W}_{\text{dot}_{\text{ideal}}} := \left( \left| \dot{Q}_{\text{dot}_C} \right| \cdot \frac{T_H - T_C}{T_C} \right)$$

$$\dot{W}_{\text{dot}_{\text{ideal}}} = 163.375 \frac{\text{BTU}}{\text{sec}}$$

For sat. liquid and vapor at the evaporator temperature, Table 9.1:

$$H_{\text{liq}} := 18.318 \cdot \frac{\text{BTU}}{\text{lb}_m}$$

$$S_{\text{liq}} := 0.04065 \cdot \frac{\text{BTU}}{\text{lb}_m \cdot \text{rankine}}$$

$$H_{\text{vap}} := 105.907 \cdot \frac{\text{BTU}}{\text{lb}_m}$$

$$S_{\text{vap}} := 0.22325 \cdot \frac{\text{BTU}}{\text{lb}_m \cdot \text{rankine}}$$

$$H_2 := H_{\text{vap}}$$

$$S_2 := S_{\text{vap}}$$

**For sat. liquid at the condenser temperature:**

$$H_4 := 37.978 \cdot \frac{\text{BTU}}{\text{lb}_m}$$

$$S_4 := 0.07892 \cdot \frac{\text{BTU}}{\text{lb}_m \cdot \text{rankine}}$$

**From Problem 9.12,**

$$H_{2A} := 116. \cdot \frac{\text{BTU}}{\text{lb}_m}$$

$$S_{2A} := 0.2435 \cdot \frac{\text{BTU}}{\text{lb}_m \cdot \text{rankine}}$$

$$H_3 := H_{2A} + 14.667 \cdot \frac{\text{BTU}}{\text{lb}_m}$$

$$H_3 = 130.67 \frac{\text{BTU}}{\text{lb}_m}$$

**From Fig. G.2 at this enthalpy and 33.11(psia):**

$$S_3 := 0.2475 \cdot \frac{\text{BTU}}{\text{lb}_m \cdot \text{rankine}}$$

**Energy balance on heat exchanger:**

$$H_1 := H_4 - H_{2A} + H_2$$

$$H_1 = 27.885 \frac{\text{BTU}}{\text{lb}_m}$$

$$x_1 := \frac{H_1 - H_{\text{liq}}}{H_{\text{vap}} - H_{\text{liq}}}$$

$$S_1 := S_{\text{liq}} + x_1 \cdot (S_{\text{vap}} - S_{\text{liq}})$$

$$x_1 = 0.109$$

$$S_1 = 0.061 \frac{\text{BTU}}{\text{lb}_m \cdot \text{rankine}}$$

**Upstream from the throttle (Point 4A) the state is subcooled liquid with the enthalpy:**

$$H_{4A} := H_1$$

**The entropy at this point is essentially that of sat. liquid with this enthalpy; by interpolation in Table 9.1:**

$$S_{4A} := 0.05986 \cdot \frac{\text{BTU}}{\text{lb}_m \cdot \text{rankine}}$$

**From Problem 9.12:**

$$\dot{m} := 25.634 \cdot \frac{\text{lb}_m}{\text{sec}}$$

$$\dot{W}_{\text{lost,comp}} := T_{\sigma} \cdot \dot{m} \cdot (\mathfrak{S}_3 - S_{2A})$$

$$\dot{Q} := (H_4 - H_3) \cdot \dot{m}$$

$$\dot{W}_{\text{lost,cond}} := T_{\sigma} \cdot \dot{m} \cdot (\mathfrak{S}_4 - S_3 - \dot{Q}/T_C)$$

$$\dot{W}_{\text{lost,throttle}} := T_{\sigma} \cdot \dot{m} \cdot (\mathfrak{S}_1 - S_{4A})$$

$$\begin{aligned} \dot{W}_{\text{lost,evap}} := & T_{\sigma} \cdot \dot{m} \cdot (\mathfrak{S}_2 - S_1) \dots \\ & + \left( T_{\sigma} \cdot \frac{H_1 - H_2}{T_C} \right) \cdot \dot{m} \end{aligned}$$

**The final term accounts for the entropy change of the refrigerated space (an internal heat reservoir).**

$$\dot{W}_{\text{lost,exchanger}} := T_{\sigma} \cdot \dot{m} \cdot (\mathfrak{S}_{2A} - S_2 + S_{4A} - S_4)$$

$$\dot{W} := \dot{m} \cdot (H_3 - H_{2A})$$

$$\dot{W}_{\text{ideal}} = 163.38 \frac{\text{BTU}}{\text{sec}} \quad \mathbf{43.45\%}$$

$$\dot{W}_{\text{lost,comp}} = 54.31 \frac{\text{BTU}}{\text{sec}} \quad \mathbf{14.45\%}$$

$$\dot{W}_{\text{lost,cond}} = 87.08 \frac{\text{BTU}}{\text{sec}} \quad \mathbf{23.16\%}$$

$$\dot{W}_{\text{lost,throttle}} = 9.98 \frac{\text{BTU}}{\text{sec}} \quad \mathbf{2.65\%}$$

$$\dot{W}_{\text{lost,evap}} = 45.07 \frac{\text{BTU}}{\text{sec}} \quad \mathbf{11.99\%}$$

$$\dot{W}_{\text{lost,exchanger}} = 16.16 \frac{\text{BTU}}{\text{sec}} \quad \mathbf{4.30\%}$$

$$\dot{W} = 375.97 \frac{\text{BTU}}{\text{sec}}$$

**The figures on the right are percentages of the actual work, to which the terms sum.**

15.7

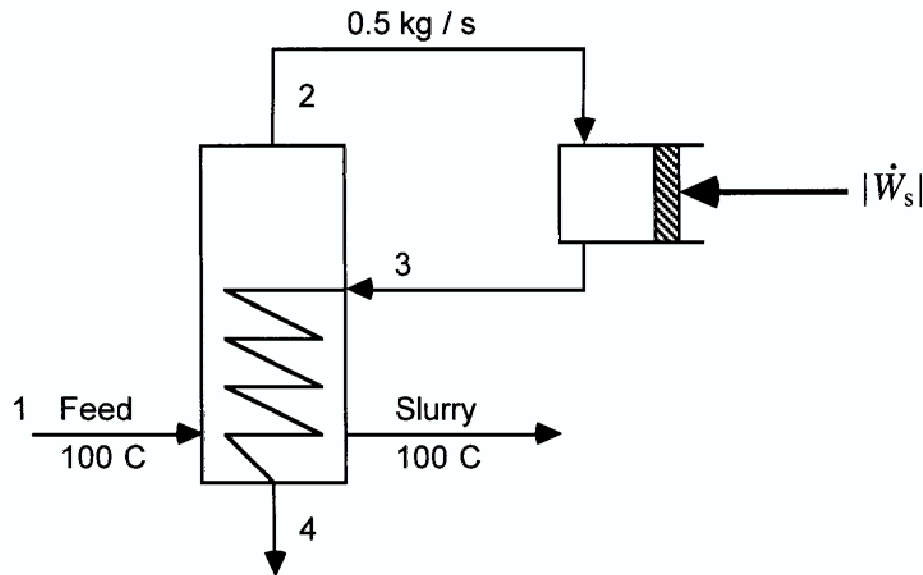

Compression to a pressure at which condensation in coils occurs at 110 degC. Table F.1 gives this sat. pressure as 143.27 kPa

$$\eta_{\text{comp}} := 0.75$$

$$H_1 := 419.1 \cdot \frac{\text{kJ}}{\text{kg}}$$

$$S_1 := 1.3069 \cdot \frac{\text{kJ}}{\text{kg} \cdot \text{K}} \quad (\text{sat. liquid})$$

$$H_2 := 2676.0 \cdot \frac{\text{kJ}}{\text{kg}}$$

$$S_2 := 7.3554 \cdot \frac{\text{kJ}}{\text{kg} \cdot \text{K}} \quad (\text{sat. vapor})$$

For isentropic compression to 143.27 kPa, we find by double interpolation in Table F.2:

$$H'_3 := 2737.0 \cdot \frac{\text{kJ}}{\text{kg}}$$

$$H_3 := H_2 + \frac{H'_3 - H_2}{\eta_{\text{comp}}}$$

$$H_3 = 2757.3 \cdot \frac{\text{kJ}}{\text{kg}}$$

By more double interpolation in Table F.2 at 143.27 kPa,

$$S_3 := 7.4048 \cdot \frac{\text{kJ}}{\text{kg} \cdot \text{K}}$$

By an energy balance, assuming the slurry passes through unchanged,

$$H_4 := H_1 + H_3 - H_2$$

$$H_4 = 500.4 \cdot \frac{\text{kJ}}{\text{kg}}$$

This enthalpy is a bit larger than that of sat. liquid at 110 degC; find quality and then the entropy:

$$H_{liq} := 461.3 \cdot \frac{\text{kJ}}{\text{kg}}$$

$$H_{lv} := 2230.0 \cdot \frac{\text{kJ}}{\text{kg}}$$

$$S_{liq} := 1.4185 \cdot \frac{\text{kJ}}{\text{kg} \cdot \text{K}}$$

$$S_{lv} := 5.8203 \cdot \frac{\text{kJ}}{\text{kg} \cdot \text{K}}$$

$$x_4 := \frac{H_4 - H_{liq}}{H_{lv}}$$

$$x_4 = 0.018$$

$$S_4 := S_{liq} + x_4 \cdot S_{lv}$$

$$S_4 = 1.5206 \cdot \frac{\text{kJ}}{\text{kg} \cdot \text{K}}$$

$$\dot{m} := 0.5 \cdot \frac{\text{kg}}{\text{sec}}$$

$$T_\sigma := 300 \cdot \text{K}$$

$$\dot{W}_{\text{ideal}} := \dot{m} \cdot \left[ H_4 - H_1 - T_\sigma \cdot (S_4 - S_1) \right]$$

$$\dot{W}_{\text{lost, evap}} := \dot{m} \cdot T_\sigma \cdot (S_4 - S_3 + S_2 - S_1)$$

$$\dot{W}_{\text{lost, comp}} := \dot{m} \cdot T_\sigma \cdot (S_3 - S_2)$$

$$\dot{W}_{\text{dot}} := \dot{m} \cdot (H_3 - H_2)$$

$$\dot{W}_{\text{ideal}} = 8.606 \text{ kW} \quad 21.16\%$$

$$\dot{W}_{\text{lost, evap}} = 24.651 \text{ kW} \quad 60.62\%$$

$$\dot{W}_{\text{lost, comp}} = 7.41 \text{ kW} \quad 18.22\%$$

$$\dot{W}_{\text{dot}} = 40.667 \text{ kW}$$

The figures on the right are percentages of the actual work, to which the terms sum.

**15.8** A thermodynamic analysis requires an exact definition of the overall process considered, and in this case we must therefore specify the source of the heat transferred to the boiler.

Since steam leaves the boiler at 900 degF, the heat source may be considered a heat reservoir at some higher temperature. We assume in the following that this temperature is 950 degF.

The assumption of a different temperature would provide a variation in the solution.

The ideal work of the process in this case is given by a Carnot engine operating between this temperature and that of the surroundings, here specified to be 80 degF.

We take as a basis 1 lbm of H<sub>2</sub>O passing through the boiler. Required property values come from Pb. 8.8.

$$T_H := (459.67 + 950) \cdot \text{rankine} \quad T_C := (459.67 + 80) \cdot \text{rankine} \quad T_\sigma := T_C$$

Subscripts below correspond to points on figure of Pb. 8.7.

$$\begin{pmatrix} H_1 \\ H_2 \\ H_3 \\ H_4 \\ H_5 \\ H_7 \end{pmatrix} := \begin{pmatrix} 257.6 \\ 1461.2 \\ 1242.2 \\ 1047.8 \\ 69.7 \\ 250.2 \end{pmatrix} \cdot \frac{\text{BTU}}{\text{lb}_m}$$

$$\begin{pmatrix} S_1 \\ S_2 \\ S_3 \\ S_4 \\ S_5 \\ S_7 \end{pmatrix} := \begin{pmatrix} 0.3970 \\ 1.6671 \\ 1.7431 \\ 1.8748 \\ 0.1326 \\ 0.4112 \end{pmatrix} \cdot \frac{\text{BTU}}{\text{lb}_m \cdot \text{rankine}}$$

$$Q_H := (H_2 - H_1) \cdot 1 \cdot \text{lb}_m \quad W_{\text{ideal}} := Q_H \cdot \left( 1 - \frac{T_C}{T_H} \right)$$

For purposes of thermodynamic analysis, we consider the following 4 parts of the process:

The boiler/heat reservoir combination

The turbine

The condenser and throttle valve

The pump and feedwater heater

$$W_{\text{lost.boiler.reservoir}} := T_\sigma \cdot \left[ (S_2 - S_1) \cdot 1 \cdot \text{lb}_m - \frac{Q_H}{T_H} \right]$$

$$m := 0.18688 \cdot \text{lb}_m \quad (\text{From Pb. 8.8})$$

$$W_{\text{lost.turbine}} := T_\sigma \cdot \left[ m \cdot (S_3 - S_2) + (1 \cdot \text{lb}_m - m) \cdot (S_4 - S_2) \right]$$

The purpose of the condenser is to transfer heat to the surroundings. The amount of heat is

$$Q := 1 \cdot \text{lb}_m \cdot H_5 - (1 \cdot \text{lb}_m - m) \cdot H_4 - m \cdot H_7$$

$$Q = -829.045 \text{ BTU}$$



$$W_{\text{lost.cond.valve}} := T_{\sigma} \cdot [1 \cdot \text{lb}_m \cdot S_5 - (1 \cdot \text{lb}_m - m) \cdot S_4 - m \cdot S_7] - Q$$

$$W_{\text{lost.pump.heater}} := T_{\sigma} \cdot [1 \cdot \text{lb}_m \cdot (S_1 - S_5) + m \cdot (S_7 - S_3)]$$

**The absolute value of the actual work comes from Pb. 8.8:**

$$W_{\text{abs.value}} = 374.61 \cdot \text{BTU} \quad 50.43\%$$

$$W_{\text{lost.boiler.reservoir}} = 224.66 \text{ BTU} \quad 30.24\%$$

$$W_{\text{lost.turbine}} = 98.81 \text{ BTU} \quad 13.30\%$$

$$W_{\text{lost.cond.valve}} = 36.44 \text{ BTU} \quad 4.90\%$$

$$W_{\text{lost.pump.heater}} = 8.36 \text{ BTU} \quad 1.13\%$$

$W_{\text{ideal}} = 742.82 \text{ BTU}$  (absolute value) **The numbers on the right are percentages of the absolute value of the ideal work, to which they sum.**

**15.9 Refer to Figure 9.7, page 330 The analysis presented here is for the liquefaction section to the right of the dashed line. Enthalpy and entropy values are those given in Ex. 9.3 plus additional values from the reference cited on page 331 at conditions given in Ex. 9.3.**

**Property values:**

$$H_4 := 1140.0 \cdot \frac{\text{kJ}}{\text{kg}}$$

$$S_4 := 9.359 \cdot \frac{\text{kJ}}{\text{kg} \cdot \text{K}}$$

$$H_5 := 1009.7 \cdot \frac{\text{kJ}}{\text{kg}}$$

$$S_5 := 8.894 \cdot \frac{\text{kJ}}{\text{kg} \cdot \text{K}}$$

$$H_7 := 719.8 \cdot \frac{\text{kJ}}{\text{kg}}$$

$$S_7 := 7.544 \cdot \frac{\text{kJ}}{\text{kg} \cdot \text{K}}$$

$$H_9 := 285.4 \cdot \frac{\text{kJ}}{\text{kg}}$$

$$S_9 := 4.928 \cdot \frac{\text{kJ}}{\text{kg} \cdot \text{K}}$$

$$H_{10} := 796.9 \cdot \frac{\text{kJ}}{\text{kg}}$$

$$S_{10} := 9.521 \cdot \frac{\text{kJ}}{\text{kg} \cdot \text{K}}$$

$$H_{14} := 1042.1 \cdot \frac{\text{kJ}}{\text{kg}}$$

$$S_{14} := 11.015 \cdot \frac{\text{kJ}}{\text{kg} \cdot \text{K}}$$

$$H_{15} := 1188.9 \cdot \frac{\text{kJ}}{\text{kg}}$$

$$S_{15} := 11.589 \cdot \frac{\text{kJ}}{\text{kg} \cdot \text{K}}$$

$$H_6 := H_5 \quad S_6 := S_5$$

$$H_{11} := H_5 \quad S_{11} := S_5$$

$$H_{12} := H_{10} \quad S_{12} := S_{10}$$

$$H_{13} := H_{10} \quad S_{13} := S_{10}$$

$$T_\sigma := 295\text{K}$$

The basis for all calculations is 1 kg of methane entering at point 4. All work quantities are in kJ. Results given in Ex. 9.3 on this basis are:

Fraction of entering methane that is liquefied:

Fraction of entering methane passing through the expander:

On this basis also Eq. (5.26) for Ideal Work, Eq. (5.33) for Entropy Generation, and Eq. (5.34) for Lost Work can be written:

$$z := 0.113$$

$$x := 0.25$$

$$W_{\text{ideal}} = \Delta(H \cdot m)_{\text{fs}} - T_\sigma \cdot \Delta(S \cdot m)_{\text{fs}} \quad S_G = \Delta(S \cdot m)_{\text{fs}} - \frac{Q}{T_\sigma} \quad W_{\text{lost}} = T_\sigma \cdot S_G$$

$$W_{\text{ideal}} := [H_{15} \cdot (1 - z) + H_9 \cdot z - H_4] - T_\sigma \cdot [S_{15} \cdot (1 - z) + S_9 \cdot z - S_4]$$

$$W_{\text{ideal}} = -489.001 \frac{\text{kJ}}{\text{kg}}$$

$$W_{\text{out}} := (H_{12} - H_{11}) \cdot x \quad W_{\text{out}} := \frac{\text{kJ}}{\text{kg}}$$

$$\text{(a) Heat Exchanger I: } S_{G,a} := [ (S_5 - S_4) + (S_{15} - S_{14}) \cdot (1 - z) ]$$

$$S_{G,a} = 0.044 \frac{\text{kJ}}{\text{kg} \cdot \text{K}}$$

$$W_{\text{lost},a} := T_\sigma \cdot S_{G,a}$$

$$W_{\text{lost},a} = 13.021 \frac{\text{kJ}}{\text{kg}}$$

$$\text{(b) Heat Exchanger II: } S_{G,b} := [ (S_7 - S_6) \cdot (1 - x) + (S_{14} - S_{13}) \cdot (1 - z) ]$$

$$S_{G,b} = 0.313 \frac{\text{kJ}}{\text{kg} \cdot \text{K}}$$

$$W_{\text{lost},b} := T_\sigma \cdot S_{G,b}$$

$$W_{\text{lost},b} = 92.24 \frac{\text{kJ}}{\text{kg}}$$

**(c) Expander:**  $S_{G,c} := (s_{12} - s_{11}) \cdot x$

$$S_{G,c} = 0.157 \frac{\text{kJ}}{\text{kg} \cdot \text{K}}$$

$$W_{\text{lost},c} := T_{\sigma} \cdot S_{G,c}$$

$$W_{\text{lost},c} = 46.241 \frac{\text{kJ}}{\text{kg}}$$

**(d) Throttle:**  $S_{G,d} := [s_9 \cdot z + s_{10} \cdot (1 - z - x) - s_7 \cdot (1 - x)]$

$$S_{G,d} = 0.964 \frac{\text{kJ}}{\text{kg} \cdot \text{K}}$$

$$W_{\text{lost},d} := T_{\sigma} \cdot S_{G,d}$$

$$W_{\text{lost},d} = 284.304 \frac{\text{kJ}}{\text{kg}}$$

**Entropy-generation analysis:**

	<b>kJ/kg-K</b>	<b>Percent of <math>\Sigma</math></b>
$S_{G,a}$	<b>0.044</b>	<b>2.98%</b>
$S_{G,b}$	<b>0.313</b>	<b>21.18%</b>
$S_{G,c}$	<b>0.157</b>	<b>10.62%</b>
$S_{G,d}$	<b>0.964</b>	<b>65.22%</b>
$\Sigma$	<b>1.478</b>	<b>100.00%</b>

**Work analysis, Eq. (15.3):**

	<b>kJ/kg</b>	<b>Percent of <math>\Sigma</math></b>
$ W_{\text{out}} $	<b>53.20</b>	<b>10.88%</b>
$W_{\text{lost},a}$	<b>13.02</b>	<b>2.66%</b>
$W_{\text{lost},b}$	<b>92.24</b>	<b>18.86%</b>
$W_{\text{lost},c}$	<b>46.24</b>	<b>9.46%</b>
$W_{\text{lost},d}$	<b>284.30</b>	<b>58.14%</b>
$\Sigma$	<b>489.00</b>	<b>100.00%</b>

**Note that:**  $\Sigma = |W_{\text{ideal}}|$

## Chapter 16 - Section A - Mathcad Solutions

16.10 (Planck's constant)

$$h := 6.626 \cdot 10^{-34} \text{ J}\cdot\text{s}$$

(Boltzmann's constant)

$$k := 1.381 \cdot 10^{-23} \frac{\text{J}}{\text{K}}$$

(Avagadro's number)

$$N_A := 6.023 \cdot 10^{23} \text{ mol}^{-1}$$

$$P := 1 \text{ bar}$$

$$T := 298.15 \text{ K}$$

$$V := \frac{R \cdot T}{P}$$

$$V = 0.025 \frac{\text{m}^3}{\text{mol}}$$

a) For Argon:

$$M := \frac{39.948 \frac{\text{gm}}{\text{mol}}}{N_A}$$

$$\text{Sig} := R \cdot \ln \left[ \left( \frac{2 \cdot \pi \cdot M \cdot k \cdot T}{h^2} \right)^{\frac{3}{2}} \cdot \frac{V \cdot e^{\frac{5}{2}}}{N_A} \right]$$

$$\text{Sig} = 154.84 \frac{\text{J}}{\text{mol}\cdot\text{K}}$$

Ans.

NIST value:

$$154.84 \frac{\text{J}}{\text{mol}\cdot\text{K}}$$

b) For Krypton:

$$M := \frac{83.800 \frac{\text{gm}}{\text{mol}}}{N_A}$$

$$\text{Sig} := R \cdot \ln \left[ \left( \frac{2 \cdot \pi \cdot M \cdot k \cdot T}{h^2} \right)^{\frac{3}{2}} \cdot \frac{V \cdot e^{\frac{5}{2}}}{N_A} \right]$$

$$\text{Sig} = 164.08 \frac{\text{J}}{\text{mol}\cdot\text{K}}$$

Ans.

NIST value:

$$164.05 \frac{\text{J}}{\text{mol}\cdot\text{K}}$$

c) For Xenon

$$M := \frac{131.30 \frac{\text{gm}}{\text{mol}}}{N_A}$$

$$\text{Sig} := R \cdot \ln \left[ \left( \frac{2 \cdot \pi \cdot M \cdot k \cdot T}{h^2} \right)^{\frac{3}{2}} \cdot \frac{V \cdot e^{\frac{5}{2}}}{N_A} \right]$$

$$\text{Sig} = 164.08 \frac{\text{J}}{\text{mol}\cdot\text{K}}$$

Ans.

NIST value:

$$169.68 \frac{\text{J}}{\text{mol}\cdot\text{K}}$$

## Chapter 1 - Section B - Non-Numerical Solutions

1.1 This system of units is the English-system equivalent of SI. Thus,

$$g_c = 1(\text{lb}_m)(\text{ft})(\text{poundal})^{-1}(\text{s})^{-2}$$

1.2 (a) Power is *power*, electrical included. Thus,

$$\text{Power} [=] \frac{\text{energy}}{\text{time}} [=] \frac{\text{N}\cdot\text{m}}{\text{s}} [=] \frac{\text{kg}\cdot\text{m}^2}{\text{s}^3}$$

(b) Electric current is by definition the time rate of transfer of electrical charge. Thus

$$\text{Charge} [=] (\text{electric current})(\text{time}) [=] \text{A}\cdot\text{s}$$

(c) Since power is given by the product of current and electric potential, then

$$\text{Electric potential} [=] \frac{\text{power}}{\text{current}} [=] \frac{\text{kg}\cdot\text{m}^2}{\text{A}\cdot\text{s}^3}$$

(d) Since (by Ohm's Law) current is electric potential divided by resistance,

$$\text{Resistance} [=] \frac{\text{electric potential}}{\text{current}} [=] \frac{\text{kg}\cdot\text{m}^2}{\text{A}^2\cdot\text{s}^3}$$

(e) Since electric potential is electric charge divided by electric capacitance,

$$\text{Capacitance} [=] \frac{\text{charge}}{\text{electric potential}} [=] \frac{\text{A}^2\cdot\text{s}^4}{\text{kg}\cdot\text{m}^2}$$

1.3 The following are general:

$$\ln x = \ln 10 \times \log_{10} x \quad (A)$$

$$P^{\text{sat}}/\text{kPa} = P^{\text{sat}}/\text{torr} \times \frac{100 \text{ kPa}}{750.061 \text{ torr}} \quad (B)$$

$$t/^{\circ}\text{C} = T/\text{K} - 273.15 \quad (C)$$

By Eqs. (B) and (A),

$$\ln P^{\text{sat}}/\text{kPa} = \ln 10 \times \log_{10} P^{\text{sat}}/\text{torr} + \ln \frac{100}{750.061}$$

The given equation for  $\log_{10} P^{\text{sat}}/\text{torr}$  is:

$$\log_{10} P^{\text{sat}}/\text{torr} = a - \frac{b}{t/^{\circ}\text{C} + c}$$

Combining these last two equations with Eq. (C) gives:

$$\begin{aligned} \ln P^{\text{sat}}/\text{kPa} &= \ln 10 \left[ a - \frac{b}{T/\text{K} - 273.15 + c} \right] + \ln \frac{100}{750.061} \\ &= 2.3026 \left[ a - \frac{b}{T/\text{K} - 273.15 + c} \right] - 2.0150 \end{aligned}$$

Comparing this equation with the given equation for  $\ln P^{\text{sat}}/\text{kPa}$  shows that:

$$A = 2.3026 a - 2.0150 \quad B = 2.3026 b \quad C = c - 273.15$$

**1.9** Reasons result from the fact that a spherical container has the minimum surface area for a given interior volume. Therefore:

- (a) A minimum quantity of metal is required for tank construction.
- (b) The tensile stress within the tank wall is everywhere uniform, with no sites of stress concentration. Moreover, the maximum stress within the tank wall is kept to a minimum.
- (c) The surface area that must be insulated against heat transfer by solar radiation is minimized.

**1.17** Kinetic energy as given by Eq. (1.5) has units of mass·velocity<sup>2</sup>. Its fundamental units are therefore:

$$E_K [=] \text{kg}\cdot\text{m}^2\cdot\text{s}^{-2} [=] \text{N}\cdot\text{m} [=] \text{J}$$

Potential energy as given by Eq. (1.7) has units of mass·length·acceleration. Its fundamental units are therefore:

$$E_P [=] \text{kg}\cdot\text{m}\cdot\text{m}\cdot\text{s}^{-2} [=] \text{N}\cdot\text{m} [=] \text{J}$$

**1.20** See Table A.1, p. 678, of text.

- 1(atm)  $\approx$  1 bar = 1/0.986923 = 1.01325 bar
- 1(Btu)  $\approx$  1 kJ = 1/0.947831 = 1.05504 kJ
- 1(hp)  $\approx$  0.75 kW = 1/1.34102 = 0.745701 kW
- 1(in)  $\approx$  2.5 cm = 2.54 cm exactly, by definition (see p. 651 of text)
- 1(lb<sub>m</sub>)  $\approx$  0.5 kg = 0.45359237 kg exactly, by definition (see p. 651 of text)
- 1(mile)  $\approx$  1.6 km = 5280/3280.84 = 1.60934 km
- 1(quart)  $\approx$  1 liter = 1000/(264.172 × 4) = 0.94635 liter (1 liter  $\equiv$  1000 cm<sup>3</sup>)
- 1(yard)  $\approx$  1 m = (0.0254)(36) = 0.9144 m exactly, by definition of the (in) and the (yard)

An additional item could be:

- 1(mile)(hr)<sup>-1</sup>  $\approx$  0.5 m s<sup>-1</sup> = (5280/3.28084)(1/3600) = 0.44704 m s<sup>-1</sup>

**1.21** One procedure here, which gives results that are internally consistent, though not exact, is to assume:

$$1 \text{ Year} [=] 1 \text{ Yr} [=] 364 \text{ Days}$$

This makes 1 Year equivalent to exactly 52 7-Day Weeks. Then the *average* Month contains 30 $\frac{1}{3}$  Days and 4 $\frac{1}{3}$  Weeks. With this understanding,

$$1 \text{ Year} [=] 1 \text{ Yr} [=] 364 \text{ Days} [=] (364)(24)(3600) = 31,449,600 \text{ Seconds}$$

Whence,

- |                           |   |
|---------------------------|---|
| • 1 Sc [=] 31.4496 Second | 1 Second [=] 0.031797 Sc  |
| • 1 Mn [=] 314.496 Second | 1 Minute [=] 60 Second [=] 0.19078 Mn                             |
| • 1 Hr [=] 3144.96 Second | 1 Hour [=] 3600 Second [=] 1.14469 Hr                             |
| • 1 Dy [=] 31449.6 Second | 1 Day [=] (24)(3600) Second [=] 2.74725 Dy                        |
| • 1 Wk [=] 314496. Second | 1 Week [=] (7)(24)(3600) Second [=] 1.92308 Wk                    |
| • 1 Mo [=] 3144960 Second | 1 Month [=] (4 $\frac{1}{3}$ )(7)(24)(3600) Second [=] 0.83333 Mo |

The final item is obviously also the ratio 10/12.

## Chapter 2 - Section B - Non-Numerical Solutions

**2.3** Equation (2.2) is here written:  $\partial U^t + \partial E_P + \partial E_K = Q + W$

- (a) In this equation  $W$  does not include work done by the force of gravity on the system. This is accounted for by the  $\partial E_K$  term. Thus,  $W = 0$ .
- (b) Since the elevation of the egg decreases,  $\text{sign}(\partial E_P)$  is  $(-)$ .
- (c) The egg is at rest both in its initial and final states; whence  $\partial E_K = 0$ .
- (d) Assuming the egg does not get scrambled, its internal energy does not change; thus  $\partial U^t = 0$ .
- (e) The given equation, with  $\partial U^t = \partial E_K = W = 0$ , shows that  $\text{sign}(Q)$  is  $(-)$ . A detailed examination of the process indicates that the kinetic energy of the egg just before it strikes the surface appears instantly as internal energy of the egg, thus raising its temperature. Heat transfer to the surroundings then returns the internal energy of the egg to its initial value.

**2.6** If the refrigerator is entirely contained within the kitchen, then the electrical energy entering the refrigerator must inevitably appear in the kitchen. The only mechanism is by heat transfer (from the condenser of the refrigerator, usually located behind the unit or in its walls). This raises, rather than lowers, the temperature of the kitchen. The only way to make the refrigerator double as an air conditioner is to place the condenser of the refrigerator outside the kitchen (outdoors).

**2.7** According to the phase rule [Eq. (2.7)],  $F = 2 - \kappa + N$ . According to the laboratory report a pure material ( $N = 1$ ) is in 4-phase ( $\kappa = 4$ ) equilibrium. If this is true, then  $F = 2 - 4 + 1 = -1$ . This is not possible; the claim is invalid.

**2.8** The phase rule [Eq. (2.7)] yields:  $F = 2 - \kappa + N = 2 - 2 + 2 = 2$ . Specification of  $T$  and  $P$  fixes the intensive state, and thus the phase compositions, of the system. Since the liquid phase is pure species 1, addition of species 2 to the system increases its amount in the vapor phase. If the composition of the vapor phase is to be unchanged, some of species 1 must evaporate from the liquid phase, thus *decreasing* the moles of liquid present.

**2.9** The phase rule [Eq. (2.7)] yields:  $F = 2 - \kappa + N = 2 - 2 + 3 = 3$ . With only  $T$  and  $P$  fixed, one degree of freedom remains. Thus changes in the phase compositions are possible for the given  $T$  and  $P$ . If ethanol is added in a quantity that allows  $T$  and  $P$  to be restored to their initial values, the ethanol distributes itself between the phases so as to form new equilibrium phase compositions and altered amounts of the vapor and liquid phases. Nothing remains the same except  $T$  and  $P$ .

**2.10** (a) Since  $F = 3$ , fixing  $T$  and  $P$  leaves a single additional phase-rule variable to be chosen.

- (b) Adding or removing liquid having the composition of the liquid phase or adding or removing vapor having the composition of the vapor phase does not change the phase compositions, and does not alter the intensive state of the system. However, such additions or removals do alter the *overall* composition of the system, except for the unusual case where the two phase compositions are the same. The overall composition, depending on the relative amounts of the two phases, can range from the composition of the liquid phase to that of the vapor phase.

**2.14** If the fluid density is constant, then the compression becomes a constant- $V$  process for which the work is zero. Since the cylinder is insulated, we presume that no heat is transferred. Equation (2.10) then shows that  $\partial U = 0$  for the compression process.

**2.16** Electrical and mechanical irreversibilities cause an increase in the internal energy of the motor, manifested by an elevated temperature of the motor. The temperature of the motor rises until a dynamic equilibrium is established such that heat transfer from the motor to the surroundings exactly compensates for the irreversibilities. Insulating the motor does nothing to decrease the irreversibilities in the motor and merely causes the temperature of the motor to rise until heat-transfer equilibrium is reestablished with the surroundings. The motor temperature could rise to a level high enough to cause damage.

**2.19** Let symbols without subscripts refer to the solid and symbols with subscript  $w$  refer to the water. Heat transfer from the solid to the water is manifested by changes in internal energy. Since energy is conserved,  $\Delta U^t = -\Delta U_w^t$ . If total heat capacity of the solid is  $C^t (= mC)$  and total heat capacity of the water is  $C_w^t (= m_w C_w)$ , then:

$$C^t(T - T_0) = -C_w^t(T_w - T_{w_0})$$

or

$$T_w = T_{w_0} - \frac{C^t}{C_w^t}(T - T_0) \quad (A)$$

This equation relates instantaneous values of  $T_w$  and  $T$ . It can be written in the alternative form:

$$TC^t - T_0C^t = T_{w_0}C_w^t - T_wC_w^t$$

or

$$T_{w_0}C_w^t + T_0C^t = T_wC_w^t + TC^t \quad (B)$$

The heat-transfer rate from the solid to the water is given as  $\dot{Q} = K(T_w - T)$ . [This equation implies that the solid is the system.] It may also be written:

$$C^t \frac{dT}{d\tau} = K(T_w - T) \quad (C)$$

In combination with Eq. (A) this becomes:

$$C^t \frac{dT}{d\tau} = K \left[ T_{w_0} - \frac{C^t}{C_w^t}(T - T_0) - T \right]$$

or

$$\frac{dT}{d\tau} = K \left( \frac{T_{w_0} - T}{C^t} - \frac{T - T_0}{C_w^t} \right) = -TK \left( \frac{1}{C^t} + \frac{1}{C_w^t} \right) + K \left( \frac{T_{w_0}}{C^t} + \frac{T_0}{C_w^t} \right)$$

Define:

$$\beta \equiv K \left( \frac{1}{C^t} + \frac{1}{C_w^t} \right) \quad \alpha \equiv K \left( \frac{T_{w_0}}{C^t} + \frac{T_0}{C_w^t} \right)$$

where both  $\alpha$  and  $\beta$  are constants. The preceding equation may now be written:

$$\frac{dT}{d\tau} = \alpha - \beta T$$

Rearrangement yields:

$$\frac{dT}{\alpha - \beta T} = -\frac{1}{\beta} \frac{d(\alpha - \beta T)}{\alpha - \beta T} = d\tau$$

Integration from  $T_0$  to  $T$  and from 0 to  $\tau$  gives:

$$-\frac{1}{\beta} \ln \left( \frac{\alpha - \beta T}{\alpha - \beta T_0} \right) = \tau$$



which may be written:

$$\frac{\alpha - \beta T}{\alpha - \beta T_0} = \exp(-\beta\tau)$$

When solved for  $T$  and rearranged, this becomes:

$$T = \frac{\alpha}{\beta} + \left(T_0 - \frac{\alpha}{\beta}\right) \exp(-\beta\tau)$$

where by the definitions of  $\alpha$  and  $\beta$ ,

$$\frac{\alpha}{\beta} = \frac{T_{w0}C_w^t + T_0C^t}{C_w^t + C^t}$$

When  $\tau = 0$ , the preceding equation reduces to  $T = T_0$ , as it should. When  $\tau = \infty$ , it reduces to  $T = \alpha/\beta$ . Another form of the equation for  $\alpha/\beta$  is found when the numerator on the right is replaced by Eq. (B):

$$\frac{\alpha}{\beta} = \frac{T_w C_w^t + T C^t}{C_w^t + C^t}$$

By inspection,  $T = \alpha/\beta$  when  $T_w = T$ , the expected result.

**2.20** The general equation applicable here is Eq. (2.30):

$$\Delta \left[ \left( H + \frac{1}{2}u^2 + zg \right) \dot{m} \right]_{fs} = \dot{Q} + \dot{W}_s$$

(a) Write this equation for the single stream flowing within the pipe, neglect potential- and kinetic-energy changes, and set the work term equal to zero. This yields:

$$(\Delta H)\dot{m} = \dot{Q}$$

(b) The equation is here written for the two streams (I and II) flowing in the two pipes, again neglecting any potential- and kinetic-energy changes. There is no work, and the the heat transfer is internal, between the two streams, making  $\dot{Q} = 0$ . Thus,

$$(\Delta H)_I \dot{m}_I + (\Delta H)_{II} \dot{m}_{II} = 0$$

(c) For a pump operating on a single liquid stream, the assumption of negligible potential- and kinetic-energy changes is reasonable, as is the assumption of negligible heat transfer to the surroundings. Whence,

$$(\Delta H)\dot{m} = \dot{W}$$

(d) For a properly designed gas compressor the result is the same as in Part (c).

(e) For a properly designed turbine the result is the same as in Part (c).

(f) The purpose of a throttle is to reduce the pressure on a flowing stream. One usually assumes adiabatic operation with negligible potential- and kinetic-energy changes. Since there is no work, the equation is:

$$\Delta H = 0$$

(g) The sole purpose of the nozzle is to produce a stream of high velocity. The kinetic-energy change must therefore be taken into account. However, one usually assumes negligible potential-energy change. Then, for a single stream, adiabatic operation, and no work:

$$\Delta \left[ \left( H + \frac{1}{2}u^2 \right) \dot{m} \right] = 0$$

The usual case is for a negligible inlet velocity. The equation then reduces to:

$$\Delta H + \frac{1}{2}u_2^2 = 0$$

**2.21** We reformulate the definition of Reynolds number, with mass flowrate  $\dot{m}$  replacing velocity  $u$ :

$$\dot{m} = uA\rho = u \frac{\pi}{4} D^2 \rho$$

Solution for  $u$  gives:

$$u = \frac{4}{\pi} \frac{\dot{m}}{D^2 \rho}$$

Whence,

$$\text{Re} \equiv \frac{u\rho D}{\mu} = \frac{4}{\pi} \frac{\dot{m}}{D^2 \rho} \frac{\rho D}{\mu} = \frac{4}{\pi} \frac{\dot{m}}{D\mu}$$

(a) Clearly, an increase in  $\dot{m}$  results in an increase in Re.

(b) Clearly, an increase in  $D$  results in a decrease in Re.

**2.24** With the tank as control volume, Eqs. (2.25) and (2.29) become:

$$\frac{dm}{dt} + \dot{m}' = 0 \quad \text{and} \quad \frac{d(mU)}{dt} + H'\dot{m}' = 0$$

Expanding the derivative in the second equation, and eliminating  $\dot{m}'$  by the first equation yields:

$$m \frac{dU}{dt} + U \frac{dm}{dt} - H' \frac{dm}{dt} = 0$$

Multiply by  $dt$  and rearrange:

$$\boxed{\frac{dU}{H' - U} = \frac{dm}{m}}$$

Substitution of  $H'$  for  $H$  requires the assumption of uniform (though not constant) conditions throughout the tank. This requires the absence of any pressure or temperature gradients in the gas in the tank.

**2.32** From the given equation:  $P = \frac{RT}{V - b}$

By Eq. (1.3), 
$$W = - \int_{V_1}^{V_2} P dV = - \int_{V_1}^{V_2} \frac{RT}{V - b} d(V - b)$$

Whence,

$$\boxed{W = RT \ln \left( \frac{V_1 - b}{V_2 - b} \right)}$$

**2.35** Recall:  $d(PV) = P dV + V dP$  and  $dW = -P dV$

Whence,  $dW = V dP - d(PV)$  and 
$$\boxed{W = \int V dP - \Delta(PV)}$$

By Eq. (2.4),  $dQ = dU - dW$

By Eq. (2.11),  $U = H - PV$  and  $dU = dH - P dV - V dP$

With  $dW = -P dV$  the preceding equation becomes  $dQ = dH - V dP$

Whence, 
$$\boxed{Q = \Delta H - \int V dP}$$

**2.38** (a) By Eq. (2.24a),  $\dot{m} = uA\rho$  With  $\dot{m}$ ,  $A$ , and  $\rho$  all constant,  $u$  must also be constant. With  $q = uA$ ,  $q$  is also constant.

(b) Because mass is conserved,  $\dot{m}$  must be constant. But  $\dot{n} = \mathcal{M}/\dot{m}$  may change, because  $\mathcal{M}$  may change. At the very least,  $\rho$  depends on  $T$  and  $P$ . Hence  $u$  and  $q$  can both change.

**2.40** In accord with the phase rule, the system has 2 degrees of freedom. Once  $T$  and  $P$  are specified, the intensive state of the system is fixed. Provided the two phases are still present, their compositions cannot change.

**2.41** In accord with the phase rule, the system has 6 degrees of freedom. Once  $T$  and  $P$  are specified, 4 remain. One can add liquid with the liquid-phase composition or vapor with the vapor-phase composition or both. In other words, simply change the quantities of the phases.

**2.43** Let  $\dot{n}'$  represent the moles of air leaving the home. By an energy balance,

$$\dot{Q} = \dot{n}'H + \frac{d(nU)}{dt} = \dot{n}'H + n\frac{dU}{dt} + U\frac{dn}{dt}$$

But a material balance yields  $\dot{n}' = -\frac{dn}{dt}$

Then  $\dot{Q} = -(H - U)\frac{dn}{dt} + n\frac{dU}{dt}$

or  $\dot{Q} = -PV\frac{dn}{dt} + n\frac{dU}{dt}$

**2.44** (a) By Eq. (2.32a):  $H_2 - H_1 + \frac{1}{2}(u_2^2 - u_1^2) = 0$

By Eq. (2.24a):  $u = \frac{\dot{m}}{A\rho} = \frac{4}{\pi} \frac{\dot{m}}{\rho D^2}$

Then  $u_2^2 - u_1^2 = \left(\frac{4}{\pi}\right)^2 \frac{\dot{m}^2}{\rho^2} \left(\frac{1}{D_2^4} - \frac{1}{D_1^4}\right)$  and given  $H_2 - H_1 = \frac{1}{\rho}(P_2 - P_1)$

$$\frac{1}{\rho}(P_2 - P_1) + \frac{1}{2} \left(\frac{4}{\pi}\right)^2 \frac{\dot{m}^2}{\rho^2} \left(\frac{D_1^4 - D_2^4}{D_1^4 D_2^4}\right) = 0$$

Solve for  $\dot{m}$ :  $\dot{m} = \left[2\rho(P_1 - P_2) \left(\frac{\pi}{4}\right)^2 \left(\frac{D_1^4 D_2^4}{D_1^4 - D_2^4}\right)\right]^{1/2}$

(b) Proceed as in part (a) with an extra term, Here solution for  $\dot{m}$  yields:

$$\dot{m} = \left[2[\rho(P_1 - P_2) - \rho^2 C(T_2 - T_1)] \left(\frac{\pi}{4}\right)^2 \left(\frac{D_1^4 D_2^4}{D_1^4 - D_2^4}\right)\right]^{1/2}$$

Because the quantity in the smaller square brackets is smaller than the leading term of the preceding result, the effect is to decrease the mass flowrate.

## Chapter 3 - Section B - Non-Numerical Solutions

**3.2** Differentiate Eq. (3.2) with respect to  $P$  and Eq. (3.3) with respect to  $T$ :

$$\left(\frac{\pi\xi}{\pi P}\right)_T = -\frac{1}{V^2}\left(\frac{\pi V}{\pi P}\right)_T\left(\frac{\pi V}{\pi T}\right)_P + \frac{1}{V}\left(\frac{\pi^2 V}{\pi P \pi T}\right) = \xi\epsilon + \left(\frac{\pi^2 V}{\pi P \pi T}\right)$$

$$\left(\frac{\pi\epsilon}{\pi T}\right)_P = \frac{1}{V^2}\left(\frac{\pi V}{\pi T}\right)_P\left(\frac{\pi V}{\pi P}\right)_T - \frac{1}{V}\left(\frac{\pi^2 V}{\pi T \pi P}\right) = -\xi\epsilon - \left(\frac{\pi^2 V}{\pi P \pi T}\right)$$

Addition of these two equations leads immediately to the given equation.

One could of course start with Eq. (3.4) and apply the condition for an exact differential, but this topic is not covered until Chapter 6.

**3.3** The Tait equation is given as: 
$$V = V_0 \left(1 - \frac{AP}{B + P}\right)$$

where  $V_0$ ,  $A$ , and  $B$  are constants. Application of Eq. (3.3), the definition of  $\epsilon$ , requires the derivative of this equation:

$$\left(\frac{\pi V}{\pi P}\right)_T = V_0 \left[-\frac{A}{B + P} + \frac{AP}{(B + P)^2}\right] = \frac{AV_0}{B + P} \left(-1 + \frac{P}{B + P}\right)$$

Multiplication by  $-1/V$  in accord with Eq. (3.3), followed by substitution for  $V_0/V$  by the Tait equation leads to:

$$\boxed{\epsilon = \frac{AB}{(B + P)[B + (1 - A)P]}}$$

**3.7 (a)** For constant  $T$ , Eq. (3.4) becomes: 
$$\frac{dV}{V} = -\epsilon dP$$

Integration from the initial state  $(P_1, V_1)$  to an intermediate state  $(P, V)$  for constant  $\epsilon$  gives:

$$\ln \frac{V}{V_1} = -\epsilon(P - P_1)$$

Whence, 
$$V = V_1 \exp[-\epsilon(P - P_1)] = V_1 \exp(-\epsilon P) \exp(\epsilon P_1)$$

If the given equation applies to the process, it must be valid for the initial state; then,  $A(T) = V_1 \exp(\epsilon P_1)$ , and

$$\boxed{V = A(T) \exp(-\epsilon P)}$$

**(b)** Differentiate the preceding equation: 
$$dV = -\epsilon A(T) \exp(-\epsilon P) dP$$

Therefore,

$$\begin{aligned} W &= -\int_{V_1}^{V_2} P dV = \epsilon A(T) \int_{P_1}^{P_2} P \exp(-\epsilon P) dP \\ &= \frac{A(T)}{\epsilon} [(\epsilon P_1 + 1) \exp(-\epsilon P_1) - (\epsilon P_2 + 1) \exp(-\epsilon P_2)] \end{aligned}$$

With  $V_1 = A(T) \exp(-\kappa P_1)$  and  $V_2 = A(T) \exp(-\kappa P_2)$ , this becomes:

$$W = \frac{1}{\kappa} [(\kappa P_1 + 1)V_1 - (\kappa P_2 + 1)V_2]$$

or

$$W = P_1 V_1 - P_2 V_2 + \frac{V_1 - V_2}{\kappa}$$

**3.11** Differentiate Eq. (3.35c) with respect to  $T$ :

$$T \left( \frac{1 - \delta}{\delta} \right) P^{[(1-\delta)/\delta]-1} \frac{dP}{dz} + P^{(1-\delta)/\delta} \frac{dT}{dz} = T \left( \frac{1 - \delta}{\delta} \right) \frac{P^{(1-\delta)/\delta}}{P} \frac{dP}{dz} + P^{(1-\delta)/\delta} \frac{dT}{dz} = 0$$

Algebraic reduction and substitution for  $dP/dz$  by the given equation yields:

$$\frac{T}{P} \left( \frac{1 - \delta}{\delta} \right) (-\mathcal{M}\rho g) + \frac{dT}{dz} = 0$$

For an ideal gas  $T\rho/P = 1/R$ . This substitution reduces the preceding equation to:

$$\frac{dT}{dz} = -\frac{\mathcal{M}g}{R} \left( \frac{\delta - 1}{\delta} \right)$$

**3.12** Example 2.13 shows that  $U_2 = H'$ . If the gas is ideal,

$$H' = U' + P'V' = U' + RT' \quad \text{and} \quad U_2 - U' = RT'$$

$$\text{For constant } C_V, \quad U_2 - U' = C_V(T_2 - T') \quad \text{and} \quad C_V(T_2 - T') = RT'$$

$$\text{Whence,} \quad \frac{T_2 - T'}{T'} = \frac{R}{C_V} = \frac{C_P - C_V}{C_V}$$

$$\text{When } C_P/C_V \text{ is set equal to } \gamma, \text{ this reduces to:} \quad T_2 = \gamma T'$$

This result indicates that the final temperature is independent of the amount of gas admitted to the tank, a result strongly conditioned by the assumption of no heat transfer between gas and tank.

**3.13 Isobaric case** ( $\delta = 0$ ). Here, Eqs. (3.36) and (3.37) reduce to:

$$W = -RT_1(1^\infty - 1) \quad \text{and} \quad Q = \frac{\gamma RT_1}{\gamma - 1}(1^\infty - 1)$$

Both are indeterminate. The easiest resolution is to write Eq. (3.36) and (3.37) in the alternative but equivalent forms:

$$W = \frac{RT_1}{\delta - 1} \left( \frac{T_2}{T_1} - 1 \right) \quad \text{and} \quad Q = \frac{(\delta - \gamma)RT_1}{(\delta - 1)(\gamma - 1)} \left( \frac{T_2}{T_1} - 1 \right)$$

from which we find immediately for  $\delta = 0$  that:

$$W = -R(T_2 - T_1) \quad \text{and} \quad Q = \frac{\gamma R}{\gamma - 1}(T_2 - T_1) = C_P(T_2 - T_1)$$

**Isothermal case** ( $\delta = 1$ ). Equations (3.36) and (3.37) are both indeterminate of form 0/0. Application of l'Hôpital's rule yields the appropriate results:

$$W = RT_1 \ln \frac{P_2}{P_1} \quad \text{and} \quad Q = -RT_1 \ln \frac{P_2}{P_1}$$

Note that if  $y \equiv \left(\frac{P_2}{P_1}\right)^{(\delta-1)/\delta}$  then  $\frac{dy}{d\delta} = \frac{1}{\delta^2} \left(\frac{P_2}{P_1}\right)^{(\delta-1)/\delta} \ln \frac{P_2}{P_1}$

**Adiabatic case** ( $\delta = \gamma$ ). In this case simple substitution yields:

$$W = \frac{RT_1}{\gamma - 1} \left[ \left(\frac{P_2}{P_1}\right)^{(\gamma-1)/\gamma} - 1 \right] \quad \text{and} \quad Q = 0$$

**Isochoric case** ( $\delta = \infty$ ). Here, simple substitution yields:

$$W = 0 \quad \text{and} \quad Q = \frac{RT_1}{\gamma - 1} \left(\frac{P_2}{P_1} - 1\right) = \frac{RT_1}{\gamma - 1} \left(\frac{T_2}{T_1} - 1\right) = C_V(T_2 - T_1)$$

**3.14** What is needed here is an equation relating the heat transfer to the quantity of air admitted to the tank and to its temperature change. For an ideal gas in a tank of total volume  $V^t$  at temperature  $T$ ,

$$n_1 = \frac{P_1 V^t}{RT} \quad \text{and} \quad n_2 = \frac{P_2 V^t}{RT}$$

The quantity of air admitted to the tank is therefore:

$$n' = \frac{V^t(P_2 - P_1)}{RT} \quad (\text{A})$$

The appropriate energy balance is given by Eq. (2.29), which here becomes:

$$\frac{d(nU)_{\text{tank}}}{dt} - \dot{n}'H' = \dot{Q}$$

where the prime (') identifies the entrance stream of constant properties. Multiplying by  $dt$  and integrating over the time of the process yields:

$$n_2 U_2 - n_1 U_1 - n' H' = Q$$

With  $n' = n_2 - n_1$ ,  $n_2(U_2 - H') - n_1(U_1 - H') = Q$

Because  $U_2 = H_2 - RT$  and  $U_1 = H_1 - RT$ , this becomes:

$$n_2(H_2 - H' - RT) - n_1(U_1 - H' - RT) = Q$$

or  $n_2[C_P(T - T') - RT] - n_1[C_P(T - T') - RT] = Q$

Because  $n' = n_2 - n_1$ , this reduces to:

$$\boxed{Q = n'[C_P(T - T') - RT]}$$

Given:  $V^t = 100,000 \text{ cm}^3$   $T = 298.15 \text{ K}$   $T' = 318.15 \text{ K}$   $P_1 = 101.33 \text{ kPa}$   $P_2 = 1500 \text{ kPa}$

By Eq. (A) with  $R = 8,314 \text{ cm}^3 \text{ kPa mol}^{-1} \text{ K}^{-1}$ ,

$$n' = \frac{(100,000)(1500 - 101.33)}{(8,314)(298.15)} = 56.425 \text{ mol}$$

With  $R = 8.314 \text{ J mol}^{-1} \text{ K}^{-1}$  and  $C_p = (7/2)R$ , the energy equation gives:

$$Q = (56.425)(8.314) \left[ \frac{7}{2}(298.15 - 318.15) - 298.15 \right] = -172,705.6 \text{ J}$$

or

$$Q = -172.71 \text{ kJ}$$

**3.15 (a)** The appropriate energy balance is given by Eq. (2.29), here written:

$$\frac{d(nU)_{\text{tank}}}{dt} - \dot{n}'H' = \dot{Q}$$

where the prime (') identifies the entrance stream of constant properties. Multiplying by  $dt$  and integrating over the time of the process yields:

$$n_2U_2 - n_1U_1 - n'H' = Q$$

Since  $n' = n_2 - n_1$ , rearrangement gives:

$$n_2(U_2 - H') - n_1(U_1 - H') = Q$$

(b) If the gas is ideal,  $H' = U' + P'V' = U' + RT'$

Whence for an ideal gas with constant heat capacities,

$$U_2 - H' = U_2 - U' - RT' = C_V(T_2 - T') - RT'$$

Substitute  $R = C_p - C_V$ :  $U_2 - H' = C_VT_2 - C_VT' - C_pT' + C_VT' = C_VT_2 - C_pT'$

Similarly,  $U_1 - H' = C_VT_1 - C_pT'$

and

$$n_2(C_VT_2 - C_pT') - n_1(C_VT_1 - C_pT') = Q$$

Note also:

$$n_2 = \frac{P_2V_{\text{tank}}}{RT_2} \quad n_1 = \frac{P_1V_{\text{tank}}}{RT_1}$$

(c) If  $n_1 = 0$ ,

$$n_2(C_VT_2 - C_pT') = Q$$

(d) If in addition  $Q = 0$ ,  $C_VT_2 = C_pT'$  and  $T_2 = \frac{C_p}{C_V}T'$

Whence,

$$T_2 = \gamma T'$$

(e) 1. Apply the result of Part (d), with  $\gamma = 1.4$  and  $T' = 298.15 \text{ K}$ :

$$T_2 = (1.4)(298.15) = 417.41 \text{ K}$$

Then, with  $R = 83.14 \text{ bar cm}^3 \text{ mol}^{-1} \text{ K}^{-1}$ :

$$n_2 = \frac{P_2 V_{\text{tank}}}{RT_2} = \frac{(3)(4 \times 10^6)}{(83.14)(417.41)} = 345.8 \text{ mol}$$

2. Heat transfer between gas and tank is:  $Q = -m_{\text{tank}}C(T_2 - T')$

where  $C$  is the specific heat of the tank. The equation of Part (c) now becomes:

$$n_2(C_V T_2 - C_P T') = -m_{\text{tank}}C(T_2 - T')$$

Moreover 
$$n_2 = \frac{P_2 V_{\text{tank}}}{RT_2}$$

These two equations combine to give:

$$\frac{P_2 V_{\text{tank}}}{RT_2}(C_V T_2 - C_P T') = -m_{\text{tank}}C(T_2 - T')$$

With  $C_P = (7/2)R$  and  $C_V = C_P - R = (7/2)R - R = (5/2)R$ , this equation becomes:

$$\frac{P_2 V_{\text{tank}}}{RT_2}(5T_2 - 7T')\frac{R}{2} = -m_{\text{tank}}C(T_2 - T')$$

Note:  $R$  in the denominator has the units of  $PV$ ;  $R$  in the numerator has energy units.

Given values in the appropriate units are:

$$m_{\text{tank}} = 400 \text{ kg} \quad C = 460 \text{ J mol}^{-1} \text{ kg}^{-1} \quad T' = 298.15 \text{ K}$$

$$P_2 = 3 \text{ bar} \quad V_{\text{tank}} = 4 \times 10^6 \text{ cm}^3$$

Appropriate values for  $R$  are therefore:

$$R(\text{denominator}) = 83.14 \text{ bar cm}^3 \text{ mol}^{-1} \text{ K}^{-1} \quad R(\text{numerator}) = 8.314 \text{ J mol}^{-1} \text{ K}^{-1}$$

Numerically,

$$\frac{(3)(4 \times 10^6)}{(83.14)(T_2)}[(5)(T_2) - (7)(298.15)]\frac{8.314}{2} = -(400)(460)(T_2 - 298.15)$$

Solution for  $T_2$  is by trial, by an iteration scheme, or by the solve routine of a software package.

The result is  $T_2 = 304.217 \text{ K}$ . Then,

$$n_2 = \frac{P_2 V_{\text{tank}}}{RT_2} = \frac{(3)(4 \times 10^6)}{(83.14)(304.217)} = 474.45 \text{ mol}$$

**3.16** The assumption made in solving this problem is that the gas is ideal with constant heat capacities.

The appropriate energy balance is given by Eq. (2.29), here written:

$$\frac{d(nU)_{\text{tank}}}{dt} + H'\dot{n}' = \dot{Q}$$

Multiplied by  $dt$  it becomes:  $d(nU) + H'dn' = dQ$



where  $n$  and  $U$  refer to the contents of the tank, and  $H^{\equiv}$  and  $n^{\equiv}$  refer to the exit stream. Since the stream bled from the tank is merely throttled,  $H^{\equiv} = H$ , where  $H$  is the enthalpy of the contents of the tank. By material balance,  $dn^{\equiv} = -dn$ . Thus,

$$n dU + U dn - H dn = Q \quad \text{or} \quad n dU - (H - U)dn = dQ$$

$$\text{Also,} \quad dU = C_V dT \quad H - U = PV = RT \quad dQ = -mC dT$$

where  $m$  is the mass of the tank, and  $C$  is its specific heat.

$$\text{Thus,} \quad nC_V dT - RT dn = -mC dT$$

$$\text{or} \quad \frac{dT}{T} = \frac{R}{nC_V + mC} dn = \frac{R}{C_V} \frac{d(nC_V)}{nC_V + mC} = \frac{R}{C_V} \frac{d(nC_V + mC)}{nC_V + mC}$$

$$\text{Integration yields:} \quad \ln\left(\frac{T_2}{T_1}\right) = \frac{R}{C_V} \ln\left(\frac{n_2 C_V + mC}{n_1 C_V + mC}\right)$$

$$\text{or} \quad \boxed{\frac{T_2}{T_1} = \left(\frac{n_2 C_V + mC}{n_1 C_V + mC}\right)^{R/C_V}}$$

$$\text{In addition,} \quad n_1 = \frac{P_1 V_{\text{tank}}}{RT_1} \quad \text{and} \quad n_2 = \frac{P_2 V_{\text{tank}}}{RT_2}$$

These equations may be solved for  $T_2$  and  $n_2$ . If  $mC \gg nC_V$ , then  $T_2 = T_1$ . If  $mC = 0$ , then we recover the isentropic expansion formulas.

$$\mathbf{3.27} \quad \text{For an ideal gas,} \quad \Delta U = C_V \Delta T \quad PV = RT \quad \Delta(PV) = R \Delta T$$

$$\text{Whence,} \quad \Delta U = \frac{C_V}{R} \Delta(PV)$$

$$\text{But} \quad \frac{C_V}{R} = \frac{C_V}{C_P - C_V} = \frac{1}{\gamma - 1} \quad \text{Therefore:} \quad \boxed{\Delta U = \frac{1}{\gamma - 1} \Delta(PV)}$$

$$\mathbf{3.28} \quad \text{Since } Z = PV/RT \text{ the given equation can be written:} \quad V = \frac{RT}{P} + B^{\equiv} RT$$

$$\text{Differentiate at constant } T: \quad dV = -\frac{RT}{P^2} dP$$

$$\text{The isothermal work is then:} \quad W = -\int_{V_1}^{V_2} P dV = RT \int_{P_1}^{P_2} \frac{1}{P} dP$$

$$\text{Whence,} \quad \boxed{W = RT \ln \frac{P_2}{P_1}} \quad \text{Compared with Eq. (3.27)}$$

$$\mathbf{3.29} \quad \text{Solve the given equation of state for } V: \quad V = \frac{RT}{P} + b - \frac{\theta}{RT}$$

Whence, 
$$\left(\frac{\partial V}{\partial P}\right)_T = -\frac{RT}{P^2}$$

By definition [Eq. (3.3)]: 
$$\kappa \equiv \frac{-1}{V} \left(\frac{\partial V}{\partial P}\right)_T$$

Substitution for both  $V$  and the derivative yields:

$$\kappa = \frac{RT}{P^2 \left(\frac{RT}{P} + b - \frac{\theta}{RT}\right)}$$

Solve the given equation of state for  $P$ : 
$$P = \frac{RT}{V - b + \frac{\theta}{RT}}$$

Differentiate: 
$$\left(\frac{\partial P}{\partial T}\right)_V = \frac{R}{\left(V - b + \frac{\theta}{RT}\right)} + \frac{\left(\frac{\theta}{T} - \frac{d\theta}{dT}\right)}{\left(V - b + \frac{\theta}{RT}\right)^2}$$

By the equation of state, the quantity in parentheses is  $RT/P$ ; substitution leads to:

$$\left(\frac{\partial P}{\partial T}\right)_V = \frac{P}{T} + \left(\frac{P}{RT}\right)^2 \left(\frac{\theta}{T} - \frac{d\theta}{dT}\right)$$

**3.31** When multiplied by  $V/RT$ , Eq. (3.42) becomes:

$$Z = \frac{V}{V - b} - \frac{a(T)V/RT}{(V + \epsilon b)(V + \sigma b)} = \frac{V}{V - b} - \frac{a(T)V/RT}{V^2 + (\epsilon + \sigma)bV + \epsilon\sigma b^2}$$

Substitute  $V = 1/\rho$ : 
$$Z = \frac{1}{1 - b\rho} - \frac{a(T)\rho}{RT} \frac{1}{1 + (\epsilon + \sigma)b\rho + \epsilon\sigma(b\rho)^2}$$

Expressed in series form, the first term on the right becomes: 
$$\frac{1}{1 - b\rho} = 1 + b\rho + (b\rho)^2 + \dots$$

The final fraction of the second term becomes:

$$\frac{1}{1 + (\epsilon + \sigma)b\rho + \epsilon\sigma(b\rho)^2} = 1 - (\epsilon + \sigma)b\rho + [(\epsilon + \sigma)^2 - \epsilon\sigma](b\rho)^2 + \dots$$

Combining the last three equations gives, after reduction:

$$Z = 1 + \left(b - \frac{a(T)}{RT}\right)\rho + \left[b^2 + \frac{(\epsilon + \sigma)a(T)b}{RT}\right]\rho^2 + \dots$$

Equation (3.12) may be written: 
$$Z = 1 + B\rho + C\rho^2 + \dots$$

Comparison shows: 
$$B = b - \frac{a(T)}{RT} \quad \text{and} \quad C = b^2 + \frac{(\epsilon + \sigma)ba(T)}{RT}$$

For the Redlich/Kwong equation, the second equation becomes:

$$C = b^2 + \frac{ba(T)}{RT} = b \left( b + \frac{a(T)}{RT} \right)$$

Values for  $a(T)$  and  $b$  are found from Eqs. (3.45) and (3.46), with numerical values from Table 3.1:

$$b = \frac{0.08664RT_c}{P_c} \quad \frac{a(T)}{RT} = \frac{0.42748RT_c}{T_r^{1.5}P_c}$$

The numerical comparison is an open-ended problem, the scope of which must be decided by the instructor.

**3.36** Differentiate Eq. (3.11):  $\left( \frac{\partial Z}{\partial P} \right)_T = B' + 2C'P + 3D'P^2 + \dots$

Whence,

$$\left( \frac{\partial Z}{\partial P} \right)_{T, P=0} = B'$$

Equation (3.12) with  $V = 1/\rho$ :  $Z = 1 + B\rho + C\rho^2 + D\rho^3 + \dots$

Differentiate:  $\left( \frac{\partial Z}{\partial \rho} \right)_T = B + 2C\rho + 3D\rho^2 + \dots$

Whence,

$$\left( \frac{\partial Z}{\partial \rho} \right)_{T, \rho=0} = B$$

**3.56** The compressibility factor is related to the measured quantities by:

$$Z = \frac{PV^t}{nRT} = \frac{MPV^t}{mRT} \quad (A)$$

By Eq. (3.39),  $B = (Z - 1)V = \frac{(Z - 1)MV^t}{m} \quad (B)$

(a) By Eq. (A),  $\frac{dZ}{Z} = \frac{dM}{M} + \frac{dP}{P} + \frac{dV^t}{V^t} - \frac{dm}{m} - \frac{dT}{T} \quad (C)$

Thus  $\text{Max } |\% \delta Z| \approx |\% \delta M| + |\% \delta P| + |\% \delta V^t| + |\% \delta m| + |\% \delta T|$

Assuming approximately equal error in the five variables, a  $\pm 1\%$  maximum error in  $Z$  requires errors in the variables of  $< 0.2\%$ .

(b) By Eq. (B),  $\frac{dB}{B} = \frac{Z}{Z - 1} \frac{dZ}{Z} + \frac{dV^t}{V^t} + \frac{dM}{M} - \frac{dm}{m}$

By Eq. (C),  $\frac{dB}{B} = \frac{Z}{Z - 1} \left( \frac{dP}{P} - \frac{dT}{T} \right) + \frac{2Z - 1}{Z - 1} \left( \frac{dV^t}{V^t} + \frac{dM}{M} - \frac{dm}{m} \right)$

Therefore

$$\begin{aligned} \text{Max } |\% \delta B| &\approx \left| \frac{Z}{Z-1} \right| (|\% \delta P| + |\% \delta T|) \\ &+ \left| \frac{2Z-1}{Z-1} \right| (|\% \delta V^t| + |\% \delta M| + |\% \delta m|) \end{aligned}$$

For  $Z \approx 0.9$  and for approximately equal error in the five variables, a  $\pm 1\%$  maximum error in  $B$  requires errors in the variables of less than about  $0.02\%$ . This is because the divisor  $Z - 1 \approx 0.1$ . In the limit as  $Z \rightarrow 1$ , the error in  $B$  approaches infinity.

**3.57** The Redlich/Kwong equation has the following equivalent forms, where  $a$  and  $b$  are constants:

$$Z = \frac{V}{V-b} - \frac{a}{RT^{3/2}(V+b)} \quad P = \frac{RT}{V-b} - \frac{a}{T^{1/2}V(V+b)}$$

From these by differentiation,

$$\left( \frac{\partial Z}{\partial V} \right)_T = \frac{a(V-b)^2 - bRT^{3/2}(V+b)^2}{RT^{3/2}(V-b)^2(V+b)^2} \quad (A)$$

$$\left( \frac{\partial P}{\partial V} \right)_T = \frac{a(2V+b)(V-b)^2 - RT^{3/2}V^2(V+b)^2}{T^{1/2}V^2(V-b)^2(V+b)^2} \quad (B)$$

In addition, we have the mathematical relation:

$$\left( \frac{\partial Z}{\partial P} \right)_T = \frac{(\partial Z/\partial V)_T}{(\partial P/\partial V)_T} \quad (C)$$

Combining these three equations gives

$$\left( \frac{\partial Z}{\partial P} \right)_T = \frac{aV^2(V-b)^2 - bRT^{3/2}V^2(V+b)^2}{aRT(2V+b)(V-b)^2 - R^2T^{5/2}V^2(V+b)^2} \quad (D)$$

For  $P \rightarrow 0$ ,  $V \rightarrow \infty$ , and Eq. (D) becomes:

$$\lim_{P \rightarrow 0} \left( \frac{\partial Z}{\partial P} \right)_T = \frac{b - a/RT^{3/2}}{RT}$$

For  $P \rightarrow \infty$ ,  $V \rightarrow b$ , and Eq. (D) becomes:

$$\lim_{P \rightarrow \infty} \left( \frac{\partial Z}{\partial P} \right)_T = \frac{b}{RT}$$

**3.60** (a) Differentiation of Eq. (3.11) gives:

$$\left( \frac{\partial Z}{\partial P} \right)_T = B' + 2C'P + 3D'P^2 + \dots \quad \text{whence} \quad \lim_{P \rightarrow 0} \left( \frac{\partial Z}{\partial P} \right)_T = B'$$

If the limiting value of the derivative is zero, then  $B' = 0$ , and

$$B = B'RT = 0$$

(b) For simple fluids,  $\omega = 0$ , and Eqs. (3.52) and (3.53) combine to give  $B^0 = BP_c/RT_c$ . If  $B = 0$ , then by Eq. (3.65),

$$B^0 = 0.083 - \frac{0.422}{T_r^{1.6}} = 0$$

and

$$T_r = \left( \frac{0.422}{0.083} \right)^{(1/1.6)} = 2.763$$

**3.63** Linear isochores require that  $(\gamma P/\gamma T)_V = \text{Constant}$ .

(a) By Eq. (3.4) applied to a constant- $V$  process:  $\left( \frac{\gamma P}{\gamma T} \right)_V = \frac{\beta}{\kappa}$

(b) For an ideal gas  $PV = RT$ , and  $\left( \frac{\gamma P}{\gamma T} \right)_V = \frac{R}{V}$

(c) Because  $a$  and  $b$  are constants, differentiation of Eq. (3.42) yields:  $\left( \frac{\gamma P}{\gamma T} \right)_V = \frac{R}{V-b}$

In each case the quantities on the right are constant, and so therefore is the derivative.

**3.64** (a) Ideal gas: Low  $P$ , or low  $\rho$ , or large  $V$  and/or high  $T$ . See Fig. 3.15 for quantitative guidance.

(b) Two-term virial equation: Low to modest  $P$ . See Fig. 3.14 for guidance.

(c) Cubic EOS: Gases at (in principle) any conditions.

(d) Lee/Kesler correlation: Same as (c), but often more accurate. Note that corresponding states correlations are strictly valid for non-polar fluids.

(e) Incompressible liquids: Liquids at normal  $T$ s and  $P$ s. Inappropriate where *changes* in  $V$  are required.

(f) Rackett equation: Saturated liquids; a corresponding states application.

(g) Constant  $\beta$ ,  $\kappa$  liquids: Useful where changes in  $V$  are required. For absolute values of  $V$ , a reference volume is required.

(h) Lydersen correlation for liquids: a corresponding-states method applicable to liquids at extreme conditions.

**3.66** Write Eq. (3.12) with  $1/\rho$  substituted everywhere for  $V$ . Subtract 1 from each side of the equation and divide by  $\rho$ . Take the limit as  $\rho \rightarrow 0$ .

**3.68** Follow the procedure laid out on p. 93 with respect to the van der Waals equation to obtain from Eq. (3.42) the following three more-general equations:

$$1 + (1 - \epsilon - \sigma)\Omega = 3Z_c$$

$$\epsilon\sigma\Omega^2 - (\epsilon + \sigma)\Omega(\Omega + 1) + \Psi = 3Z_c^2$$

$$\epsilon\sigma\Omega^2(\Omega + 1) + \Psi\Omega = Z_c^3$$

where by definition [see Eqs. (3.45) and (3.46)]:

$$\Omega \equiv \frac{bP_c}{RT_c} \quad \text{and} \quad \Psi \equiv \frac{a_c P_c}{R^2 T_c^2}$$

For a given EOS,  $\epsilon$  and  $\sigma$  are fixed, and the above set represents 3 equations in 3 unknowns,  $\Omega$ ,  $\Psi$ , and  $Z_c$ . Thus, for a given EOS the value of  $Z_c$  is *preordained*, unrelated to experimental values of  $Z_c$ .

(a, b) For the Redlich/Kwong and Soave/Redlich/Kwong equations,  $\epsilon = 0$  and  $\sigma = 1$ . Substitution of these values into the 3-equation set allows their solution to yield:

$$Z_c = \frac{1}{3} \quad \Omega = 0.086640 \quad \Psi = 0.427480$$

(c) For the Peng/Robinson equation,  $\epsilon = 1 - \sqrt{2}$  and  $\sigma = 1 + \sqrt{2}$ . As for the Soave and SRK equations the 3-equation set can be solved (with considerably greater difficulty) to yield:

$$Z_c = 0.30740 \quad \Omega = 0.077796 \quad \Psi = 0.457236$$

**3.69** Equation (3.12):  $Z = 1 + B\rho + C\rho^2 + \dots$  where  $\rho = P/ZRT$

Eliminate  $\rho$ : 
$$Z = 1 + \frac{BP}{ZRT} + \frac{CP^2}{Z^2R^2T^2} + \dots$$

$$Z = 1 + \frac{BP_c}{RT_c} \cdot \frac{P_r}{ZT_r} + \frac{CP_c^2}{R^2T_c^2} \cdot \frac{P_r^2}{Z^2T_r^2} + \dots = 1 + \hat{B} \cdot \frac{P_r}{ZT_r} + \hat{C} \cdot \frac{P_r^2}{Z^2T_r^2} + \dots$$

Rearrange: 
$$\frac{(Z-1)ZT_r}{P_r} = \hat{B} + \hat{C} \cdot \frac{P_r}{ZT_r} + \dots$$

$$\hat{B} = \lim_{P_r \rightarrow 0} (Z-1)ZT_r/P_r$$

**3.74** In a cylinder filled with 1 mole of an ideal gas, the molecules have kinetic energy only, and for a given  $T$  and  $P$  occupy a volume  $V^{ig}$ .

- (a) For 1 mole of a gas with molecules having kinetic energy *and* purely attractive interactions at the same  $T$  and  $P$ , the intermolecular separations are smaller, and  $V < V^{ig}$ . In this case  $Z < 1$ .
- (b) For 1 mole of a gas with molecules having kinetic energy *and* purely repulsive interactions at the same  $T$  and  $P$ , the intermolecular separations are larger, and  $V > V^{ig}$ . In this case  $Z > 1$ .
- (c) If attractive and repulsive interactions are both present, they tend to cancel each other. If in balance, then the average separation is the same as for an ideal gas, and  $V = V^{ig}$ . In this case  $Z = 1$ .

**3.75** van der Waals EOS: 
$$P = \frac{RT}{V-b} - \frac{a}{V^2} \quad Z = \frac{V}{V-b} - \frac{a}{VRT}$$

Set  $V = 1/\rho$ : 
$$Z = \frac{1}{1-b\rho} - \frac{a\rho}{RT} = 1 + \frac{b\rho}{1-b\rho} - \frac{a\rho}{RT}$$

whence 
$$Z_{rep} = \frac{b\rho}{1-b\rho} \quad Z_{attr} = \frac{a\rho}{RT}$$

**3.76** Write each modification in “Z-form,”

$$(a) \quad Z = \frac{V}{V-b} - \frac{a}{RT} \quad \lim_{V \rightarrow \infty} Z = 1 - \frac{a}{RT}$$

The *required* behavior is:  $\lim_{V \rightarrow \infty} Z = 1$

$$(b) \quad Z = \frac{V}{(V-b)^2} - \frac{a}{RT} \quad \lim_{V \rightarrow \infty} Z = -\frac{a}{RT}$$

The *required* behavior is:  $\lim_{V \rightarrow \infty} Z = 1$

$$(c) \quad Z = \frac{1}{V-b} - \frac{a}{VRT} \quad \lim_{V \rightarrow \infty} Z = 0$$

The *required* behavior is:  $\lim_{V \rightarrow \infty} Z = 1$

$$(d) \quad Z = 1 - \frac{a}{VRT} = 1 - \frac{a\rho}{RT}$$

Although  $\lim_{V \rightarrow \infty} Z = 1$  as required, the equation makes  $Z$  linear in  $\rho$ ; i.e., a 2-term virial EOS in  $\rho$ . Such an equation is quite inappropriate at higher densities.

**3.77** Refer to Pb. 2.43, where the general equation was developed;  $\dot{Q} = -PV \frac{dn}{dt} + n \frac{dU}{dt}$

For an ideal gas,  $n = \frac{PV^t}{RT}$  and  $\frac{dn}{dt} = -\left(\frac{PV^t}{RT^2}\right) \frac{dT}{dt}$  Note that  $PV^t/R = \text{const.}$

Also for an ideal gas,  $dU = C_V dT$  whence  $\frac{dU}{dt} = C_V \frac{dT}{dt}$

$$\dot{Q} = -RT \left(-\frac{PV^t}{RT^2}\right) \frac{dT}{dt} + \frac{PV^t}{RT} C_V \frac{dT}{dt} = C_P \frac{PV^t}{RT} \frac{dT}{dt}$$

Integration yields:

$$\ln \frac{T_2}{T_1} = \frac{R}{C_P PV^t} \int_{t_1}^{t_2} \dot{Q} dt$$

**3.78** By Eq. (3.4),  $\frac{dV}{V} = \beta dT - \kappa dP$  where  $\beta$  and  $\kappa$  are average values

Integrate:  $\ln \frac{V_2}{V_1} = \ln \frac{V_2'}{V_1'} = \ln \frac{D_2^2}{D_1^2} = \ln \left(\frac{D_1 + \delta D}{D_1}\right)^2 = \ln \left(1 + \frac{\delta D}{D_1}\right)^2 = \beta(T_2 - T_1) - \kappa(P_2 - P_1)$

$$\ln(1.0035)^2 = 250 \times 10^{-6}(40 - 10) - 45 \times 10^{-6}(P_2 - 6)$$

Solution for  $P_2$  yields:  $P_2 = 17.4 \text{ bar}$

## Chapter 4 - Section B - Non-Numerical Solutions

4.5 For consistency with the problem statement, we rewrite Eq. (4.8) as:

$$\langle C_P \rangle = A + \frac{B}{2}T_1(\nu + 1) + \frac{C}{3}T_1^2(\nu^2 + \nu + 1)$$

where  $\nu \equiv T_2/T_1$ . Define  $C_{P_{am}}$  as the value of  $C_P$  evaluated at the arithmetic mean temperature  $T_{am}$ . Then:

$$C_{P_{am}} = A + BT_{am} + CT_{am}^2$$

where  $T_{am} \equiv \frac{T_2 + T_1}{2} = \frac{T_1\nu + T_1}{2} = \frac{T_1(\nu + 1)}{2}$  and  $T_{am}^2 = \frac{T_1^2}{4}(\nu^2 + 2\nu + 1)$

Whence, 
$$C_{P_{am}} = A + \frac{B}{2}T_1(\nu + 1) + \frac{C}{4}T_1^2(\nu^2 + 2\nu + 1)$$

Define  $\varepsilon$  as the difference between the two heat capacities:

$$\varepsilon \equiv \langle C_P \rangle - C_{P_{am}} = CT_1^2 \left[ \frac{\nu^2 + \nu + 1}{3} - \frac{\nu^2 + 2\nu + 1}{4} \right]$$

This readily reduces to: 
$$\varepsilon = \frac{CT_1^2}{12}(\nu - 1)^2$$

Making the substitution  $\nu = T_2/T_1$  yields the required answer.

4.6 For consistency with the problem statement, we rewrite Eq. (4.8) as

$$\langle C_P \rangle = A + \frac{B}{2}T_1(\nu + 1) + \frac{D}{\nu T_1^2}$$

where  $\nu \equiv T_2/T_1$ . Define  $C_{P_{am}}$  as the value of  $C_P$  evaluated at the arithmetic mean temperature  $T_{am}$ . Then:

$$C_{P_{am}} = A + BT_{am} + \frac{D}{T_{am}^2}$$

As in the preceding problem,

$$T_{am} = \frac{T_1(\nu + 1)}{2} \quad \text{and} \quad T_{am}^2 = \frac{T_1^2}{4}(\nu^2 + 2\nu + 1)$$

Whence, 
$$C_{P_{am}} = A + \frac{B}{2}T_1(\nu + 1) + \frac{4D}{T_1^2(\nu^2 + 2\nu + 1)}$$

Define  $\varepsilon$  as the difference between the two heat capacities:

$$\varepsilon \equiv \langle C_P \rangle - C_{P_{am}} = \frac{D}{T_1^2} \left[ \frac{1}{\nu} - \frac{4}{\nu^2 + 2\nu + 1} \right]$$

This readily reduces to: 
$$\varepsilon = \frac{D}{T_1^2\nu} \left[ \frac{\nu - 1}{\nu + 1} \right]^2$$

Making the substitution  $\nu = T_2/T_1$  yields the required answer.



4.8 Except for the noble gases [Fig. (4.1)],  $C_p$  increases with increasing  $T$ . Therefore, the estimate is likely to be low.

4.27 (a) When the water formed as the result of combustion is condensed to a liquid product, the resulting latent-heat release adds to the heat given off as a result of the combustion reaction, thus yielding a higher heating value than the lower heating value obtained when the water is not condensed.

(b) Combustion of methane(g) with  $H_2O(g)$  as product (LHV):

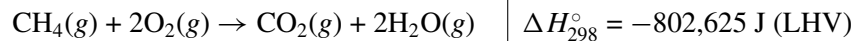
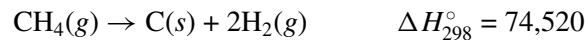

Combustion of methane(g) with  $H_2O(l)$  as product (HHV):

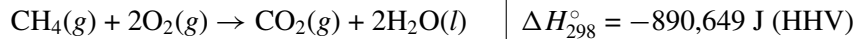
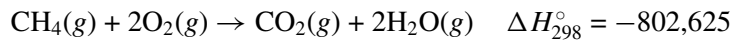

(c) Combustion of  $n$ -decane(l) with  $H_2O(g)$  as product (LHV):

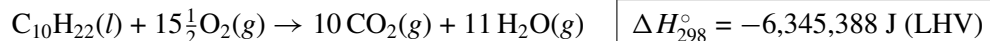
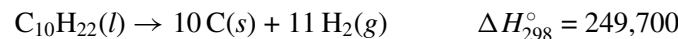
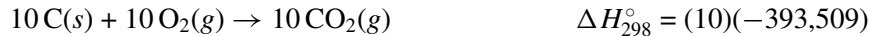

Combustion of  $n$ -decane(l) with  $H_2O(l)$  as product (HHV):

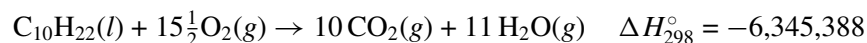

4.49 *Saturated* because the large  $\Delta H^{lv}$  overwhelms the sensible heat associated with superheat.

*Water* because it is cheap, available, non-toxic, and has a large  $\Delta H^{lv}$ .

The lower energy content is a result of the decrease in  $\Delta H^{lv}$  with increasing  $T$ , and hence  $P$ . However, higher pressures allow higher temperature levels.

## Chapter 5 - Section B - Non-Numerical Solutions

**5.1** Shown to the right is a  $PV$  diagram with two adiabatic lines  $1 \infty 2$  and  $2 \infty 3$ , assumed to intersect at point 2. A cycle is formed by an isothermal line from  $3 \infty 1$ . An engine traversing this cycle would produce work. For the cycle  $\pi U = 0$ , and therefore by the first law,  $Q + W = 0$ . Since  $W$  is negative,  $Q$  must be positive, indicating that heat is absorbed by the system. The net result is therefore a complete conversion of heat taken in by a cyclic process into work, in violation of **Statement 1a** of the second law (Pg. 160). The assumption of intersecting adiabatic lines is therefore false.

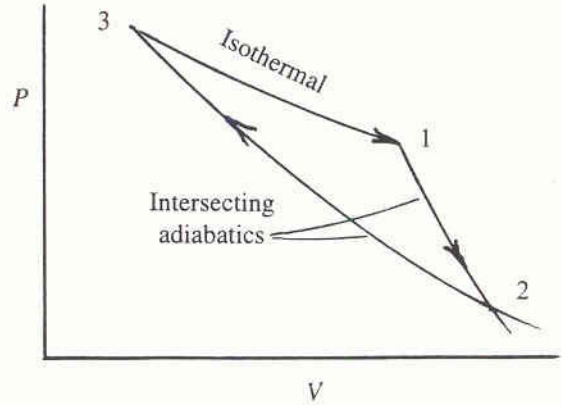

**5.5** The energy balance for the over-all process is written:  $Q = \pi U' + \pi E_K + \pi E_P$

Assuming the egg is not scrambled in the process, its internal-energy change after it returns to its initial temperature is zero. So too is its change in kinetic energy. The potential-energy change, however, is negative, and by the preceding equation, so is  $Q$ . Thus heat is transferred to the surroundings.

The total entropy change of the process is:  $\pi S_{\text{total}} = \pi S' + \pi S'_{\text{surr}}$

Just as  $\pi U'$  for the egg is zero, so is  $\pi S'$ . Therefore,

$$\pi S_{\text{total}} = \pi S'_{\text{surr}} = \frac{Q_{\text{surr}}}{T_{\xi}} = \frac{-Q}{T_{\xi}}$$

Since  $Q$  is negative,  $\pi S_{\text{total}}$  is positive, and the process is irreversible.

**5.6** By Eq. (5.8) the thermal efficiency of a Carnot engine is:  $\epsilon = 1 - \frac{T_C}{T_H}$

Differentiate:  $\left[ \frac{\epsilon}{T_C} \left( \frac{1}{T_H} \right) = -\frac{1}{T_H^2} \right]$  and  $\left[ \frac{\epsilon}{T_H} \left( \frac{1}{T_C} \right) = \frac{T_C}{T_H^2} = \frac{T_C}{T_H} \frac{1}{T_H} \right]$

Since  $T_C/T_H$  is less unity, the efficiency changes more rapidly with  $T_C$  than with  $T_H$ . So in theory it is more effective to decrease  $T_C$ . In practice, however,  $T_C$  is fixed by the environment, and is not subject to control. The *practical* way to increase  $\epsilon$  is to increase  $T_H$ . Of course, there are limits to this too.

**5.11** For an ideal gas with constant heat capacities, and for the changes  $T_1 \infty T_2$  and  $P_1 \infty P_2$ , Eq. (5.14) can be rewritten as:

$$\pi S = C_P \ln \left[ \frac{T_2}{T_1} \right] - R \ln \left[ \frac{P_2}{P_1} \right]$$

(a) If  $P_2 = P_1$ ,  $\pi S_P = C_P \ln \left[ \frac{T_2}{T_1} \right]$  If  $V_2 = V_1$ ,  $\frac{P_2}{P_1} = \frac{T_2}{T_1}$

Whence,  $\pi S_V = C_P \ln \left[ \frac{T_2}{T_1} \right] - R \ln \left[ \frac{T_2}{T_1} \right] = C_V \ln \left[ \frac{T_2}{T_1} \right]$

Since  $C_P > C_V$ , this demonstrates that  $\Delta S_P > \Delta S_V$ .

(b) If  $T_2 = T_1$ ,  $\Delta S_T = -R \ln \left( \frac{P_2}{P_1} \right)$       If  $V_2 = V_1$ ,  $\frac{T_2}{T_1} = \frac{P_2}{P_1}$

Whence,  $\Delta S_V = C_P \ln \left( \frac{P_2}{P_1} \right) - R \ln \left( \frac{P_2}{P_1} \right) = C_V \ln \left( \frac{P_2}{P_1} \right)$

This demonstrates that the signs for  $\Delta S_T$  and  $\Delta S_V$  are opposite.

**5.12** Start with the equation just preceding Eq. (5.14) on p. 170:

$$\frac{dS}{R} = \frac{C_P^{ig}}{R} \frac{dT}{T} - d \ln P = \frac{C_P^{ig}}{R} \frac{dT}{T} - \frac{dP}{P}$$

For an ideal gas  $PV = RT$ , and  $\ln P + \ln V = \ln R + \ln T$ . Therefore,

$$\frac{dP}{P} + \frac{dV}{V} = \frac{dT}{T} \quad \text{or} \quad \frac{dP}{P} = \frac{dT}{T} - \frac{dV}{V}$$

Whence,  $\frac{dS}{R} = \frac{C_P^{ig}}{R} \frac{dT}{T} - \frac{dT}{T} + \frac{dV}{V} = \left( \frac{C_P^{ig}}{R} - 1 \right) \frac{dT}{T} + d \ln V$

Because  $(C_P^{ig}/R) - 1 = C_V^{ig}/R$ , this reduces to:

$$\frac{dS}{R} = \frac{C_V^{ig}}{R} \frac{dT}{T} + d \ln V$$

Integration yields:

$$\frac{\Delta S}{R} = \int_{T_0}^T \frac{C_V^{ig}}{R} \frac{dT}{T} + \ln \frac{V}{V_0}$$

\*\*\*\*\*

As an additional part of the problem, one could ask for the following proof, valid for *constant* heat capacities. Return to the original equation and substitute  $dT/T = dP/P + dV/V$ :

$$\frac{dS}{R} = \frac{C_P^{ig}}{R} \frac{dP}{P} + \frac{C_P^{ig}}{R} \frac{dV}{V} - \frac{dP}{P} = \frac{C_V^{ig}}{R} \frac{dP}{P} + \frac{C_P^{ig}}{R} \frac{dV}{V}$$

Integration yields:

$$\frac{\Delta S}{R} = \frac{C_V^{ig}}{R} \ln \frac{P}{P_0} + \frac{C_P^{ig}}{R} \ln \frac{V}{V_0}$$

**5.13** As indicated in the problem statement the basic differential equations are:

$$dW - dQ_H - dQ_C = 0 \quad (A)$$

$$\frac{dQ_H}{dQ_C} = -\frac{T_H}{T_C} \quad (B)$$

where  $Q_C$  and  $Q_H$  refer to the *reservoirs*.

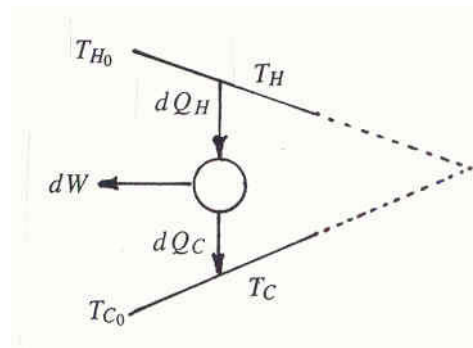

(a) With  $dQ_H = C_H^t dT_H$  and  $dQ_C = C_C^t dT_C$ , Eq. (B) becomes:

$$\frac{C_H^t dT_H}{C_C^t dT_C} = -\frac{T_H}{T_C} \quad \text{or} \quad \frac{dT_C}{T_C} = -\frac{C_H^t}{C_C^t} \frac{dT_H}{T_H}$$

Whence,  $d \ln T_C = -\Psi d \ln T_H$  where  $\Psi \equiv \frac{C_H^t}{C_C^t}$

Integration from  $T_{H_0}$  and  $T_{C_0}$  to  $T_H$  and  $T_C$  yields:

$$\frac{T_C}{T_{C_0}} = \left(\frac{T_H}{T_{H_0}}\right)^{-\Psi} \quad \text{or} \quad \boxed{T_C = T_{C_0} \left(\frac{T_H}{T_{H_0}}\right)^{-\Psi}}$$

(b) With  $dQ_H = C_H^t dT_H$  and  $dQ_C = C_C^t dT_C$ , Eq. (A) becomes:

$$dW = C_H^t dT_H + C_C^t dT_C$$

Integration yields:  $W = C_H^t (T_H - T_{H_0}) + C_C^t (T_C - T_{C_0})$

Eliminate  $T_C$  by the boxed equation of Part (a) and rearrange slightly:

$$\boxed{W = C_H^t T_{H_0} \left(\frac{T_H}{T_{H_0}} - 1\right) + C_C^t T_{C_0} \left[\left(\frac{T_H}{T_{H_0}}\right)^{-\Psi} - 1\right]}$$

(c) For infinite time,  $T_H = T_C \equiv T$ , and the boxed equation of Part (a) becomes:

$$T = T_{C_0} \left(\frac{T}{T_{H_0}}\right)^{-\Psi} = T_{C_0} \left(\frac{T_{H_0}}{T}\right)^{\Psi}$$

From which:  $T^{\Psi+1} = T_{C_0} (T_{H_0})^{\Psi}$

$$T = (T_{C_0})^{1/(\Psi+1)} (T_{H_0})^{\Psi/(\Psi+1)} \quad \text{and} \quad \frac{T}{T_{H_0}} = (T_{C_0})^{1/(\Psi+1)} (T_{H_0})^{\Psi/(\Psi+1)-1}$$

Because  $\Psi/(\Psi+1) - 1 = -1/(\Psi+1)$ , then:

$$\frac{T}{T_{H_0}} = \left(\frac{T_{C_0}}{T_{H_0}}\right)^{1/(\Psi+1)} \quad \text{and} \quad \left(\frac{T}{T_{H_0}}\right)^{-\Psi} = \left(\frac{T_{C_0}}{T_{H_0}}\right)^{-\Psi/(\Psi+1)}$$

Because  $T_H = T$ , substitution of these quantities in the boxed equation of Part (b) yields:

$$\boxed{W = C_H^t T_{H_0} \left[\left(\frac{T_{C_0}}{T_{H_0}}\right)^{1/(\Psi+1)} - 1\right] + C_C^t T_{C_0} \left[\left(\frac{T_{C_0}}{T_{H_0}}\right)^{-\Psi/(\Psi+1)} - 1\right]}$$

**5.14** As indicated in the problem statement the basic differential equations are:

$$dW - dQ_H - dQ_C = 0 \quad (A)$$

$$\frac{dQ_H}{dQ_C} = -\frac{T_H}{T_C} \quad (B)$$

where  $Q_C$  and  $Q_H$  refer to the *reservoirs*.

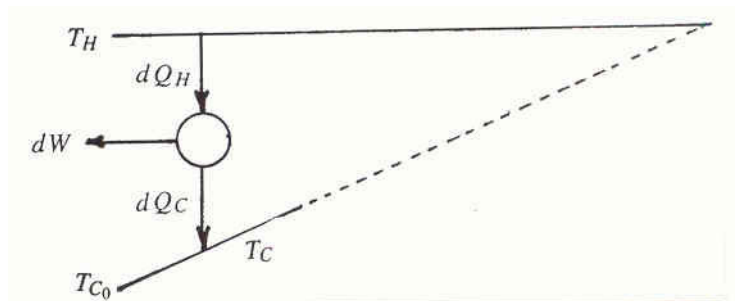

(a) With  $dQ_C = C_C^t dT_C$ , Eq. (B) becomes:

$$\frac{dQ_H}{C_C^t dT_C} = -\frac{T_H}{T_C} \quad \text{or} \quad dQ_H = -C_C^t \frac{T_H}{T_C} dT_C$$

Substitute for  $dQ_H$  and  $dQ_C$  in Eq. (A):

$$dW = -C_C^t T_H \frac{dT_C}{T_C} + C_C^t dT_C$$

Integrate from  $T_{C_0}$  to  $T_C$ :

$$W = -C_C^t T_H \ln \frac{T_C}{T_{C_0}} + C_C^t (T_C - T_{C_0}) \quad \text{or} \quad \boxed{W = C_C^t \left( T_H \ln \frac{T_{C_0}}{T_C} + T_C - T_{C_0} \right)}$$

(b) For infinite time,  $T_C = T_H$ , and the boxed equation above becomes:

$$\boxed{W = C_C^t \left( T_H \ln \frac{T_{C_0}}{T_H} + T_H - T_{C_0} \right)}$$

**5.15** Write Eqs. (5.8) and (5.1) in rate form and combine to eliminate  $|\dot{Q}_H|$ :

$$\frac{|\dot{W}|}{|\dot{W}| + |\dot{Q}_C|} = 1 - \frac{T_C}{T_H} = 1 - r \quad \text{or} \quad \frac{|\dot{W}|}{1 - r} = |\dot{W}| + |\dot{Q}_C| \quad \text{where} \quad r \equiv \frac{T_C}{T_H}$$

With  $|\dot{Q}_C| = kA(T_C)^4 = kA(rT_H)^4$ , this becomes:

$$|\dot{W}| \left( \frac{1}{1 - r} - 1 \right) = |\dot{W}| \left( \frac{r}{1 - r} \right) = kAr^4 (T_H)^4 \quad \text{or} \quad A = \left[ \frac{|\dot{W}|}{k(T_H)^4} \right] \frac{1}{(1 - r)r^3}$$

Differentiate, noting that the quantity in square brackets is constant:

$$\frac{dA}{dr} = \left[ \frac{|\dot{W}|}{k(T_H)^4} \right] \left[ \frac{-3}{(1 - r)r^4} + \frac{1}{(1 - r)^2 r^3} \right] = \left[ \frac{|\dot{W}|}{k(T_H)^4} \right] \left[ \frac{4r - 3}{(1 - r)^2 r^4} \right]$$

Equating this equation to zero, leads immediately to:  $4r = 3$  or  $\boxed{r = 0.75}$

**5.20** Because  $W = 0$ , Eq. (2.3) here becomes:

$$Q = \Delta U^t = mC_V \Delta T$$

A necessary condition for  $\Delta T$  to be zero when  $Q$  is non-zero is that  $m = \infty$ . This is the reason that natural bodies (air and water) that serve as heat reservoirs must be massive (oceans) or continually renewed (rivers).

**5.22** An appropriate energy balance here is:  $Q = \Delta H^t = 0$

Applied to the process described, with  $T$  as the final temperature, this becomes:

$$m_1 C_P (T - T_1) + m_2 C_P (T - T_2) = 0 \quad \text{whence} \quad T = \frac{m_1 T_1 + m_2 T_2}{m_1 + m_2} \quad (1)$$

If  $m_1 = m_2$ ,  $T = (T_1 + T_2)/2$

The total entropy change as a result of temperature changes of the two masses of water:

$$\Delta S^t = m_1 C_P \ln \frac{T}{T_1} + m_2 C_P \ln \frac{T}{T_2} \quad (2)$$

Equations (1) and (2) represent the general case. If  $m_1 = m_2 = m$ ,

$$\Delta S^t = m C_P \ln \frac{T^2}{T_1 T_2} \quad \text{or} \quad \boxed{\Delta S^t = 2m C_P \ln \frac{T}{\sqrt{T_1 T_2}}}$$

Because  $T = (T_1 + T_2)/2 > \sqrt{T_1 T_2}$ ,  $\Delta S^t$  is positive.

**5.23** Isentropic processes are **not** necessarily reversible and adiabatic. The term *isentropic* denotes a process for which the *system* does not change in entropy. There are two causes for entropy changes in a system: The process may be internally irreversible, causing the entropy to increase; heat may be transferred between system and surroundings, causing the entropy of the system to increase or decrease. For processes that are internally irreversible, it is possible for heat to be transferred **out** of the system in an amount such that the entropy changes from the two causes exactly compensate each other. One can imagine irreversible processes for which the state of the system is the same at the end as at the beginning of the process. The process is then necessarily isentropic, but neither reversible nor adiabatic. More generally, the system conditions may change in such a way that entropy changes resulting from temperature and pressure changes compensate each other. Such a process is isentropic, but not necessarily reversible. Expansion of gas in a piston/cylinder arrangement is a case in point. It may be reversible and adiabatic, and hence isentropic. But the same change of state may be irreversible with heat transfer to the surroundings. The process is still isentropic, but neither reversible nor adiabatic. An isentropic process must be either reversible *and* adiabatic or irreversible *and* non-adiabatic.

**5.24** By definition,

$$\langle C_P \rangle_H = \frac{\int_{T_0}^T C_P dT}{T - T_0} = \frac{\int_T^{T_0} C_P dT}{T_0 - T}$$

By inspection, one sees that for both  $T > T_0$  and  $T_0 > T$  the numerators and denominators of the above fractions have the same sign. Thus, for both cases  $\langle C_P \rangle_H$  is positive.

Similarly,

$$\langle C_P \rangle_S = \frac{\int_{T_0}^T C_P \frac{dT}{T}}{\ln(T/T_0)} = \frac{\int_T^{T_0} C_P \frac{dT}{T}}{\ln(T_0/T)}$$

By inspection, one sees that for both  $T > T_0$  and  $T_0 > T$  the numerators and denominators of the above fractions have the same sign. Thus, for both cases  $\langle C_P \rangle_S$  is positive.

When  $T = T_0$ , both the numerators and denominators of the above fractions become zero, and the fractions are indeterminate. Application of l'Hôpital's rule leads to the result:  $\langle C_P \rangle_H = \langle C_P \rangle_S = C_P$ .

**5.31** The process involves three heat reservoirs: the house, a heat sink; the furnace, a heat source; and the surroundings, a heat source. Notation is as follows:

- $|Q|$  Heat transfer **to** the house at temperature  $T$
- $|Q_F|$  Heat transfer **from** the furnace at  $T_F$
- $|Q_\sigma|$  Heat transfer **from** the surroundings at  $T_\sigma$

The first and second laws provide the two equations:

$$|Q| = |Q_F| + |Q_\sigma| \quad \text{and} \quad \frac{|Q|}{T} - \frac{|Q_F|}{T_F} - \frac{|Q_\sigma|}{T_\sigma} = 0$$

Combine these equations to eliminate  $|Q_\sigma|$ , and solve for  $|Q_F|$ :

$$|Q_F| = |Q| \left( \frac{T - T_\sigma}{T_F - T_\sigma} \right) \frac{T_F}{T}$$

With  $T = 295 \text{ K}$   $T_F = 810 \text{ K}$   $T_\sigma = 265 \text{ K}$  and  $|Q| = 1000 \text{ kJ}$

The result is:  $|Q_F| = 151.14 \text{ kJ}$

Shown to the right is a scheme designed to accomplish this result. A Carnot heat engine operates with the furnace as heat source and the house as heat sink. The work produced by the engine drives a Carnot refrigerator (reverse Carnot engine) which extracts heat from the surroundings and discharges heat to the house. Thus the heat rejected by the Carnot engine ( $|Q_1|$ ) and by the Carnot refrigerator ( $|Q_2|$ ) together provide the heat  $|Q|$  for the house. The energy balances for the engine and refrigerator are:

$$|W|_{\text{engine}} = |Q_F| - |Q_1|$$

$$|W|_{\text{refrig}} = |Q_2| - |Q_\sigma|$$

Equation (5.7) may be applied to both the engine and the refrigerator:

$$\frac{|Q_F|}{|Q_1|} = \frac{T_F}{T} \quad \frac{|Q_\sigma|}{|Q_2|} = \frac{T_\sigma}{T}$$

Combine the two pairs of equations:

$$|W|_{\text{engine}} = |Q_1| \left( \frac{T_F}{T} - 1 \right) = |Q_1| \frac{T_F - T}{T} \quad |W|_{\text{refrig}} = |Q_2| \left( 1 - \frac{T_\sigma}{T} \right) = |Q_2| \frac{T - T_\sigma}{T}$$

Since these two quantities are equal,

$$|Q_1| \frac{T_F - T}{T} = |Q_2| \frac{T - T_\sigma}{T} \quad \text{or} \quad |Q_2| = |Q_1| \frac{T_F - T}{T - T_\sigma}$$

Because the total heat transferred to the house is  $|Q| = |Q_1| + |Q_2|$ ,

$$|Q| = |Q_1| + |Q_1| \frac{T_F - T}{T - T_\sigma} = |Q_1| \left( 1 + \frac{T_F - T}{T - T_\sigma} \right) = |Q_1| \frac{T_F - T_\sigma}{T - T_\sigma}$$

But  $|Q_1| = |Q_F| \frac{T}{T_F}$  whence  $|Q| = |Q_F| \frac{T}{T_F} \left( \frac{T_F - T_\sigma}{T - T_\sigma} \right)$

Solution for  $|Q_F|$  yields the same equation obtained more easily by direct application of the two laws of thermodynamics to the overall result of the process.

**5.32** The process involves three heat reservoirs: the house, a heat source; the tank, a heat source; and the surroundings, a heat sink. Notation is as follows:

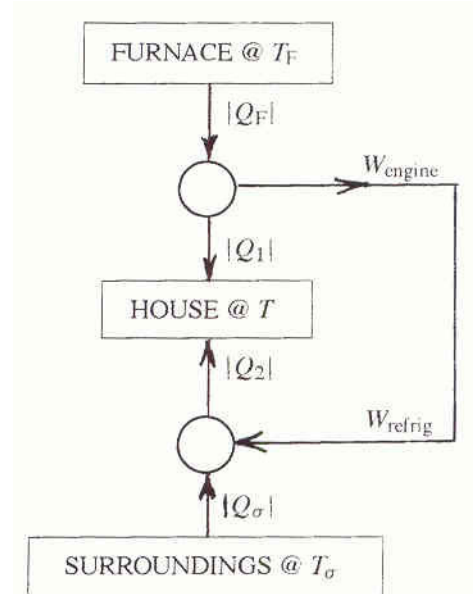

- $|Q|$  Heat transfer **from** the tank at temperature  $T$
- $|Q'|$  Heat transfer **from** the house at  $T'$
- $|Q_\sigma|$  Heat transfer **to** the surroundings at  $T_\sigma$

The first and second laws provide the two equations:

$$|Q| + |Q'| = |Q_\sigma| \quad \text{and} \quad \frac{|Q_\sigma|}{T_\sigma} - \frac{|Q|}{T} - \frac{|Q'|}{T'} = 0$$

Combine these equations to eliminate  $|Q_\sigma|$ , and solve for  $|Q|$ :

$$|Q| = |Q'| \left( \frac{T_\sigma - T'}{T - T_\sigma} \right) \frac{T}{T'}$$

With  $T = 448.15 \text{ K}$     $T' = 297.15 \text{ K}$     $T_\sigma = 306.15 \text{ K}$    and  $|Q'| = 1500 \text{ kJ}$

The result is:

$$|Q| = 143.38 \text{ kJ}$$

Shown to the right is a scheme designed to accomplish this result. A Carnot heat engine operates with the tank as heat source and the surroundings as heat sink. The work produced by the engine drives a Carnot refrigerator (reverse Carnot engine) which extracts heat  $|Q'|$  from the house and discharges heat to the surroundings. The energy balances for the engine and refrigerator are:

$$|W|_{\text{engine}} = |Q| - |Q_{\sigma 1}|$$

$$|W|_{\text{refrig}} = |Q_{\sigma 2}| - |Q'|$$

Equation (5.7) may be applied to both the engine and the refrigerator:

$$\frac{|Q_{\sigma 1}|}{|Q|} = \frac{T_\sigma}{T} \quad \frac{|Q_{\sigma 2}|}{|Q'|} = \frac{T_\sigma}{T'}$$

Combine the two pairs of equations:

$$|W|_{\text{engine}} = |Q| \left( 1 - \frac{T_\sigma}{T} \right) = |Q| \frac{T - T_\sigma}{T} \quad |W|_{\text{refrig}} = |Q'| \left( \frac{T_\sigma}{T'} \right) = |Q'| \frac{T_\sigma - T'}{T'}$$

Since these two quantities are equal,

$$|Q| \frac{T - T_\sigma}{T} = |Q'| \frac{T_\sigma - T'}{T'} \quad \text{or} \quad |Q| = |Q'| \left( \frac{T_\sigma - T'}{T - T_\sigma} \right) \frac{T}{T'}$$

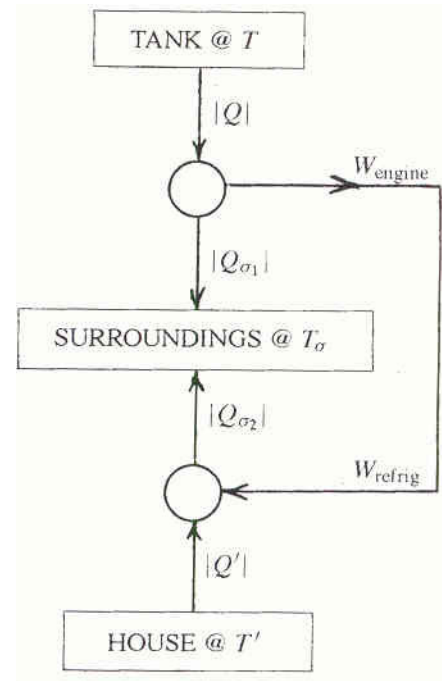

**5.36** For a closed system the first term of Eq. (5.21) is zero, and it becomes:

$$\frac{d(mS)_{\text{cv}}}{dt} + \sum_j \frac{\dot{Q}_j}{T_{\sigma,j}} = \dot{S}_G \geq 0$$



where  $\dot{Q}_j$  is here redefined to refer to the system rather than to the surroundings. Nevertheless, the second term accounts for the entropy changes of the surroundings, and can be written simply as  $dS_{\text{surr}}^t/dt$ :

$$\frac{d(mS)_{\text{cv}}}{dt} - \frac{dS_{\text{surr}}^t}{dt} = \dot{S}_G \geq 0 \quad \text{or} \quad \frac{dS_{\text{cv}}^t}{dt} - \frac{dS_{\text{surr}}^T}{dt} = \dot{S}_G \geq 0$$

Multiplication by  $dt$  and integration over finite time yields:

$$\Delta S_{\text{cv}}^t + \Delta S_{\text{surr}}^t \geq 0 \quad \text{or} \quad \boxed{\Delta S_{\text{total}} \geq 0}$$

**5.37** The general equation applicable here is Eq. (5.22):

$$\boxed{\Delta(S\dot{m})_{\text{fs}} - \sum_j \frac{\dot{Q}_j}{T_{\sigma,j}} = \dot{S}_G \geq 0}$$

(a) For a single stream flowing within the pipe and with a single heat source in the surroundings, this becomes:

$$(\Delta S)\dot{m} - \frac{\dot{Q}}{T_\sigma} = \dot{S}_G \geq 0$$

(b) The equation is here written for two streams (I and II) flowing in two pipes. Heat transfer is internal, between the two streams, making  $\dot{Q} = 0$ . Thus,

$$(\Delta S)_I \dot{m}_I + (\Delta S)_{II} \dot{m}_{II} = \dot{S}_G \geq 0$$

(c) For a pump operating on a single stream and with the assumption of negligible heat transfer to the surroundings:

$$(\Delta S)\dot{m} = \dot{S}_G \geq 0$$

(d) For an adiabatic gas compressor the result is the same as for Part (c).

(e) For an adiabatic turbine the result is the same as for Part (c).

(f) For an adiabatic throttle valve the result is the same as for Part (c).

(g) For an adiabatic nozzle the result is the same as for Part (c).

**5.40** The figure on the left below indicates the direct, irreversible transfer of heat  $|Q|$  from a reservoir at  $T_1$  to a reservoir at  $T_2$ . The figure on the right depicts a completely reversible process to accomplish the same changes in the heat reservoirs at  $T_1$  and  $T_2$ .

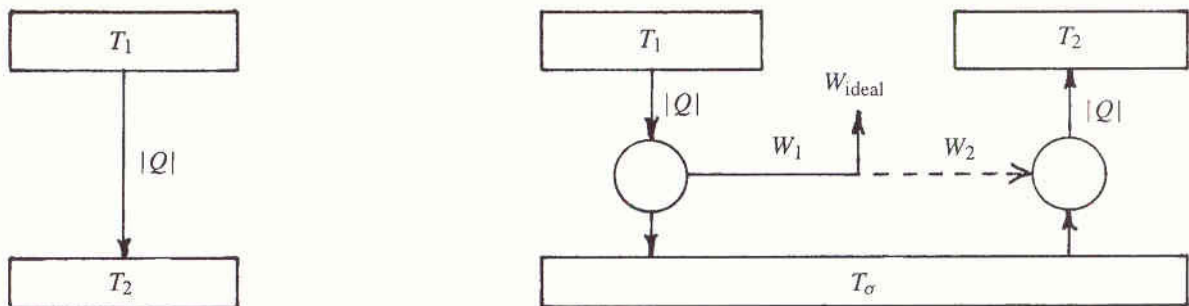

The entropy generation for the direct heat-transfer process is:

$$S_G = |Q| \left( \frac{1}{T_2} - \frac{1}{T_1} \right) = |Q| \left( \frac{T_1 - T_2}{T_1 T_2} \right)$$

For the completely reversible process the net work produced is  $W_{\text{ideal}}$ :

$$|W_1| = |Q| \left( \frac{T_1 - T_\sigma}{T_1} \right) \quad \text{and} \quad |W_2| = |Q| \left( \frac{T_2 - T_\sigma}{T_2} \right)$$

$$W_{\text{ideal}} = |W_1| - |W_2| = T_\sigma |Q| \left( \frac{T_1 - T_2}{T_1 T_2} \right)$$

This is the work that is lost,  $W_{\text{lost}}$ , in the direct, irreversible transfer of heat  $|Q|$ . Therefore,

$$W_{\text{lost}} = T_\sigma |Q| \frac{T_1 - T_2}{T_1 T_2} = T_\sigma S_G$$

Note that a Carnot engine operating between  $T_1$  and  $T_2$  would not give the correct  $W_{\text{ideal}}$  or  $W_{\text{lost}}$ , because the heat it transfers to the reservoir at  $T_2$  is not  $Q$ .

**5.45** Equation (5.14) can be written for both the reversible and irreversible processes:

$$\Delta S_{\text{irrev}} = \int_{T_0}^{T_{\text{irrev}}} C_P^{ig} \frac{dT}{T} - \ln \frac{P}{P^\circ} \quad \Delta S_{\text{rev}} = \int_{T_0}^{T_{\text{rev}}} C_P^{ig} \frac{dT}{T} - \ln \frac{P}{P^\circ}$$

By difference, with  $\Delta S_{\text{rev}} = 0$ : 
$$\Delta S_{\text{irrev}} = \int_{T_{\text{rev}}}^{T_{\text{irrev}}} C_P^{ig} \frac{dT}{T}$$

Since  $\Delta S_{\text{irrev}}$  must be greater than zero,  $T_{\text{irrev}}$  must be greater than  $T_{\text{rev}}$ .

## Chapter 6 - Section B - Non-Numerical Solutions

6.1 By Eq. (6.8),  $\boxed{\left(\frac{\nu H}{\nu S}\right)_P = T}$  and isobars have positive slope

Differentiate the preceding equation:  $\left(\frac{\nu^2 H}{\nu S^2}\right)_P = \left(\frac{\nu T}{\nu S}\right)_P$

Combine with Eq. (6.17):  $\boxed{\left(\frac{\nu^2 H}{\nu S^2}\right)_P = \frac{T}{C_P}}$  and isobars have positive curvature.

6.2 (a) Application of Eq. (6.12) to Eq. (6.20) yields:

$$\left(\frac{\nu C_P}{\nu P}\right)_T = \left[ \frac{\nu\{V - T(\nu V/\nu T)_P\}}{\nu T} \right]_P$$

or  $\left(\frac{\nu C_P}{\nu P}\right)_T = \left(\frac{\nu V}{\nu T}\right)_P - T \left(\frac{\nu^2 V}{\nu T^2}\right)_P - \left(\frac{\nu V}{\nu T}\right)_P$

Whence,  $\boxed{\left(\frac{\nu C_P}{\nu P}\right)_T = -T \left(\frac{\nu^2 V}{\nu T^2}\right)_P}$

For an ideal gas:  $\left(\frac{\nu V}{\nu T}\right)_P = \frac{R}{P}$  and  $\left(\frac{\nu^2 V}{\nu T^2}\right)_P = 0$

(b) Equations (6.21) and (6.33) are both general expressions for  $dS$ , and for a given change of state both must give the same value of  $dS$ . They may therefore be equated to yield:

$$(C_P - C_V) \frac{dT}{T} = \left(\frac{\nu P}{\nu T}\right)_V dV + \left(\frac{\nu V}{\nu T}\right)_P dP$$

Restrict to constant  $P$ :  $\boxed{C_P = C_V + T \left(\frac{\nu P}{\nu T}\right)_V \left(\frac{\nu V}{\nu T}\right)_P}$

By Eqs. (3.2) and (6.34):  $\left(\frac{\nu V}{\nu T}\right)_P = \varepsilon V$  and  $\left(\frac{\nu P}{\nu T}\right)_V = \frac{\varepsilon}{\rho}$

Combine with the boxed equation:  $\boxed{C_P - C_V = \varepsilon T V \left(\frac{\varepsilon}{\rho}\right)}$

6.3 By the definition of  $H$ ,  $U = H - PV$ . Differentiate:

$$\left(\frac{\nu U}{\nu T}\right)_P = \left(\frac{\nu H}{\nu T}\right)_P - P \left(\frac{\nu V}{\nu T}\right)_P \quad \text{or} \quad \boxed{\left(\frac{\nu U}{\nu T}\right)_P = C_P - P \left(\frac{\nu V}{\nu T}\right)_P}$$

Substitute for the final derivative by Eq. (3.2), the definition of  $\beta$ :

$$\left(\frac{\partial U}{\partial T}\right)_P = C_P - \beta PV$$

Divide Eq. (6.32) by  $dT$  and restrict to constant  $P$ . The immediate result is:

$$\left(\frac{\partial U}{\partial T}\right)_P = C_V + \left[T\left(\frac{\partial P}{\partial T}\right)_V - P\right]\left(\frac{\partial V}{\partial T}\right)_P$$

Solve for the two derivatives by Eqs. (6.34) and (3.2); substitution gives:

$$\left(\frac{\partial U}{\partial T}\right)_P = C_V + \frac{\beta}{\kappa}(\beta T - \kappa P)V$$

**6.4 (a)** In general, 
$$dU = C_V dT + \left[T\left(\frac{\partial P}{\partial T}\right)_V - P\right]dV \quad (6.32)$$

By the equation of state,  $P = \frac{RT}{V-b}$  whence  $\left(\frac{\partial P}{\partial T}\right)_V = \frac{R}{V-b} = \frac{P}{T}$

Substituting this derivative into Eq. (6.32) yields  $dU = C_V dT$ , indicating that  $U = f(T)$  only.

(b) From the definition of  $H$ ,  $dH = dU + d(PV)$

From the equation of state,  $d(PV) = R dT + b dP$

Combining these two equations and the definition of part (a) gives:

$$dH = C_V dT + R dT + b dP = (C_V + R)dT + b dP$$

Then, 
$$\left(\frac{\partial H}{\partial T}\right)_P = C_V + R$$

By definition, this derivative is  $C_P$ . Therefore  $C_P = C_V + R$ . Given that  $C_V$  is constant, then so is  $C_P$  and so is  $\gamma \equiv C_P/C_V$ .

(c) For a mechanically reversible adiabatic process,  $dU = dW$ . Whence, by the equation of state,

$$C_V dT = -P dV = -\frac{RT}{V-b} dV = -RT \frac{d(V-b)}{V-b}$$

or 
$$\frac{dT}{T} = -\frac{R}{C_V} d \ln(V-b)$$

But from part (b),  $R/C_V = (C_P - C_V)/C_V = \gamma - 1$ . Then

$$d \ln T = -(\gamma - 1)d \ln(V-b) \quad \text{or} \quad d \ln T + d \ln(V-b)^{\gamma-1} = 0$$

From which:  $T(V-b)^{\gamma-1} = \text{const.}$

Substitution for  $T$  by the equation of state gives

$$\frac{P(V-b)(V-b)^{\gamma-1}}{R} = \text{const.} \quad \text{or} \quad \boxed{P(V-b)^\gamma = \text{const.}}$$

**6.5** It follows immediately from Eq. (6.10) that:

$$V = \left( \frac{\partial G}{\partial P} \right)_T \quad \text{and} \quad S = - \left( \frac{\partial G}{\partial T} \right)_P$$

Differentiation of the given equation of state yields:

$$V = \frac{RT}{P} \quad \text{and} \quad S = - \frac{d\Gamma(T)}{dT} - R \ln P$$

Once  $V$  and  $S$  (as well as  $G$ ) are known, we can apply the equations:

$$H = G + TS \quad \text{and} \quad U = H - PV = H - RT$$

These become:

$$H = \Gamma(T) - T \frac{d\Gamma(T)}{dT} \quad \text{and} \quad U = \Gamma(T) - T \frac{d\Gamma(T)}{dT} - RT$$

By Eqs. (2.16) and (2.20),

$$C_P = \left( \frac{\partial H}{\partial T} \right)_P \quad \text{and} \quad C_V = \left( \frac{\partial U}{\partial T} \right)_V$$

Because  $\Gamma$  is a function of temperature only, these become:

$$C_P = -T \frac{d^2\Gamma}{dT^2} \quad \text{and} \quad C_V = -T \frac{d^2\Gamma}{dT^2} - R = C_P - R$$

The equation for  $V$  gives the ideal-gas value. The equations for  $H$  and  $U$  show these properties to be functions of  $T$  only, which conforms to ideal-gas behavior. The equation for  $S$  shows its relation to  $P$  to be that of an ideal gas. The equations for  $C_P$  and  $C_V$  show these properties to be functions of  $T$  only, which conforms to ideal-gas behavior, as does the result,  $C_P = C_V + R$ . We conclude that the given equation of state is consistent with the model of ideal-gas behavior.

**6.6** It follows immediately from Eq. (6.10) that:

$$V = \left( \frac{\partial G}{\partial P} \right)_T \quad \text{and} \quad S = - \left( \frac{\partial G}{\partial T} \right)_P$$

Differentiation of the given equation of state yields:

$$V = K \quad \text{and} \quad S = - \frac{dF(T)}{dT}$$

Once  $V$  and  $S$  (as well as  $G$ ) are known, we can apply the equations:

$$H = G + TS \quad \text{and} \quad U = H - PV = H - PK$$

These become:

$$H = F(T) + KP - T \frac{dF(T)}{dT} \quad \text{and} \quad U = F(T) - T \frac{dF(T)}{dT}$$

By Eqs. (2.16) and (2.20),

$$C_P = \left( \frac{\partial H}{\partial T} \right)_P \quad \text{and} \quad C_V = \left( \frac{\partial U}{\partial T} \right)_V$$

Because  $F$  is a function of temperature only, these become:

$$C_P = -T \frac{d^2 F}{dT^2} \quad \text{and} \quad C_V = -T \frac{d^2 F}{dT^2} = C_P$$

The equation for  $V$  shows it to be constant, independent of both  $T$  and  $P$ . This is the definition of an incompressible fluid.  $H$  is seen to be a function of both  $T$  and  $P$ , whereas  $U$ ,  $S$ ,  $C_P$ , and  $C_V$  are functions of  $T$  only. We also have the result that  $C_P = C_V$ . All of this is consistent with the model of an incompressible fluid, as discussed in Ex. 6.2.

**6.11** Results for this problem are given in the text on page 217 by Eqs. (6.61), (6.62) and (6.63) for  $G^R$ ,  $H^R$ , and  $S^R$  respectively.

**6.12** Parameter values for the van der Waals equation are given by the first line of Table 3.1, page 98. At the bottom of page 215, it is shown that  $I = \partial/Z$ . Equation (6.66b) therefore becomes:

$$\boxed{\frac{G^R}{RT} = Z - 1 - \ln(Z - \partial) - \frac{q\partial}{Z}}$$

For given  $T$  and  $P$ ,  $Z$  is found by solution of Eq. (3.52) for a vapor phase or Eq. (3.56) for a liquid phase with  $\sigma = \delta = 0$ . Equations (3.53) and (3.54) for the van der Waals equation are:

$$\partial = \frac{P_r}{8T_r} \quad \text{and} \quad q = \frac{27}{8T_r}$$

With appropriate substitutions, Eqs. (6.67) and (6.68) become:

$$\boxed{\frac{H^R}{RT} = Z - 1 - \frac{q\partial}{Z}} \quad \text{and} \quad \boxed{\frac{S^R}{R} = \ln(Z - \partial)}$$

**6.13** This equation does not fall within the compass of the generic cubic, Eq. (3.42); so we start anew. First, multiply the given equation of state by  $V/RT$ :

$$\frac{PV}{RT} = \frac{V}{V-b} \exp\left(\frac{-a}{VRT}\right)$$

Substitute:  $Z \equiv \frac{PV}{RT}$        $V = \frac{1}{\rho}$        $\frac{a}{bRT} \equiv q$

Then,  $Z = \frac{1}{1-b\rho} \exp(-qb\rho)$

With the definition,  $\xi \equiv b\rho$ , this becomes:

$$Z = \frac{1}{1-\xi} \exp(-q\xi) \tag{A}$$

Because  $\rho = P/ZRT$ ,  $\xi = \frac{bP}{ZRT}$

Given  $T$  and  $P$ , these two equations may be solved iteratively for  $Z$  and  $\xi$ .

Because  $b$  is a constant, Eqs. (6.58) and (6.59) may be rewritten as:

$$\frac{G^R}{RT} = \int_0^\xi (Z - 1) \frac{d\xi}{\xi} + Z - 1 - \ln Z \quad (B)$$

$$\frac{H^R}{RT} = \int_0^\xi \left( \frac{\partial Z}{\partial T} \right)_\xi \frac{d\xi}{\xi} + Z - 1 \quad (C)$$

In these equations,  $Z$  is given by Eq. (A), from which is also obtained:

$$\ln Z = -\ln(1 - \xi) - q\xi \quad \text{and} \quad \left( \frac{\partial Z}{\partial T} \right)_\xi = \frac{q\xi}{T(1 - \xi)} \exp(-q\xi)$$

The integrals in Eqs. (B) and (C) must be evaluated through the *exponential integral*,  $E(x)$ , a special function whose values are tabulated in handbooks and are also found from such software packages as MAPLE<sup>®</sup>. The necessary equations, as found from MAPLE<sup>®</sup>, are:

$$\int_0^\xi (Z - 1) \frac{d\xi}{\xi} = \exp(-q) \{E[-q(1 - \xi)] - E(-q)\} - E(q\xi) - \ln(q\xi) - \gamma$$

where  $\gamma$  is Euler's constant, equal to 0.57721566....

and 
$$-T \int_0^\xi \left( \frac{\partial Z}{\partial T} \right)_\xi \frac{s\xi}{\xi} = q \exp(-q) \{E[-q(1 - \xi)] - E(-q)\}$$

Once values for  $G^R/RT$  and  $H^R/RT$  are known, values for  $S^R/R$  come from Eq. (6.47). The difficulties of integration here are one reason that cubic equations have found greater favor.

**6.18** Assume the validity for purposes of interpolation of Eq. (6.75), and write it for  $T_2$ ,  $T$ , and  $T_1$ :

$$\ln P_2^{\text{sat}} = A - \frac{B}{T_2} \quad (A)$$

$$\ln P^{\text{sat}} = A - \frac{B}{T} \quad (B)$$

$$\ln P_1^{\text{sat}} = A - \frac{B}{T_1} \quad (C)$$

Subtract (C) from (A): 
$$\ln \frac{P_2^{\text{sat}}}{P_1^{\text{sat}}} = B \left( \frac{1}{T_1} - \frac{1}{T_2} \right) = B \frac{(T_2 - T_1)}{T_1 T_2}$$

Subtract (C) from (B): 
$$\ln \frac{P^{\text{sat}}}{P_1^{\text{sat}}} = B \left( \frac{1}{T_1} - \frac{1}{T} \right) = B \frac{(T - T_1)}{T_1 T}$$

The ratio of these two equations, upon rearrangement, yields the required result.

**6.19** Write Eq. (6.75) in  $\log_{10}$  form: 
$$\log P^{\text{sat}} = A - \frac{B}{T} \quad (A)$$

Apply at the critical point: 
$$\log P_c = A - \frac{B}{T_c} \quad (B)$$

By difference, 
$$\log P_r^{\text{sat}} = B \left( \frac{1}{T_c} - \frac{1}{T} \right) = B \left( \frac{T_r - 1}{T} \right) \quad (C)$$

If  $P^{\text{sat}}$  is in (atm), then application of (A) at the normal boiling point yields:

$$\log 1 = A - \frac{B}{T_n} \quad \text{or} \quad A = \frac{B}{T_n}$$

With  $\theta \equiv T_n/T_c$ , Eq. (B) can now be written:

$$\log P_c = B \left( \frac{1}{T_n} - \frac{1}{T_c} \right) = B \left( \frac{T_c - T_n}{T_n T_c} \right) = B \left( \frac{1 - \theta}{T_n} \right)$$

Whence, 
$$B = \left( \frac{T_n}{1 - \theta} \right) \log P_c$$

Equation (C) then becomes:

$$\log P_r^{\text{sat}} = \left( \frac{T_n}{1 - \theta} \right) \left( \frac{T_r - 1}{T} \right) \log P_c = \left( \frac{\theta}{1 - \theta} \right) \left( \frac{T_r - 1}{T_r} \right) \log P_c$$

Apply at  $T_r = 0.7$ : 
$$\log(P_r^{\text{sat}})_{T_r=0.7} = -\frac{3}{7} \left( \frac{\theta}{1 - \theta} \right) \log P_c$$

By Eq. (3.48), 
$$\omega = -1.0 - \log(P_r^{\text{sat}})_{T_r=0.7}$$

Whence, 
$$\omega = \frac{3}{7} \left( \frac{\theta}{1 - \theta} \right) \log P_c - 1$$

**6.83** The slopes of isobars and isochores on a  $TS$  diagram are given by Eqs. (6.17) and (6.30):

$$\left( \frac{\partial T}{\partial S} \right)_P = \frac{T}{C_P} \quad \text{and} \quad \left( \frac{\partial T}{\partial S} \right)_V = \frac{T}{C_V}$$

Both slopes are necessarily positive. With  $C_P > C_V$ , isochores are steeper.

An expression for the curvature of isobars results from differentiation of the first equation above:

$$\left( \frac{\partial^2 T}{\partial S^2} \right)_P = \frac{1}{C_P} \left( \frac{\partial T}{\partial S} \right)_P - \frac{T}{C_P^2} \left( \frac{\partial C_P}{\partial S} \right)_P = \frac{T}{C_P^2} - \frac{T}{C_P^2} \left( \frac{\partial C_P}{\partial T} \right)_P \left( \frac{\partial T}{\partial S} \right)_P = \frac{T}{C_P^2} \left[ 1 - \frac{T}{C_P} \left( \frac{\partial C_P}{\partial T} \right)_P \right]$$

With  $C_P = a + bT$ , 
$$\left( \frac{\partial C_P}{\partial T} \right)_P = b \quad \text{and} \quad 1 - \frac{T}{C_P} \left( \frac{\partial C_P}{\partial T} \right)_P = 1 - \frac{bT}{a + bT} = \frac{a}{a + bT}$$

Because this quantity is positive, so then is the curvature of an isobar.

**6.84** Division of Eq. (6.8) by  $dS$  and restriction to constant  $T$  yields:

$$\left( \frac{\partial H}{\partial S} \right)_T = T + V \left( \frac{\partial P}{\partial S} \right)_T \quad \text{By Eq. (6.25),} \quad \left( \frac{\partial P}{\partial S} \right)_T = \frac{-1}{\beta V}$$

Therefore, 
$$\left( \frac{\partial H}{\partial S} \right)_T = T - \frac{1}{\beta} = \frac{1}{\beta}(\beta T - 1)$$



Also, 
$$\left(\frac{\partial^2 H}{\partial S^2}\right)_T = \frac{1}{\beta^2} \left(\frac{\partial \beta}{\partial S}\right)_T = \frac{1}{\beta^2} \left(\frac{\partial \beta}{\partial P}\right)_T \left(\frac{\partial P}{\partial S}\right)_T = \frac{1}{\beta^2} \left(\frac{\partial \beta}{\partial P}\right)_T \left(\frac{-1}{\beta V}\right)$$

Whence, 
$$\boxed{\left(\frac{\partial^2 H}{\partial S^2}\right)_T = -\frac{1}{\beta^3 V} \left(\frac{\partial \beta}{\partial P}\right)_T}$$

By Eqs. (3.2) and (3.38): 
$$\beta = \frac{1}{V} \left(\frac{\partial V}{\partial T}\right)_P \quad \text{and} \quad V = \frac{RT}{P} + B$$

Whence, 
$$\left(\frac{\partial V}{\partial T}\right)_P = \frac{R}{P} + \frac{dB}{dT} \quad \text{and} \quad \beta = \frac{1}{V} \left(\frac{R}{P} + \frac{dB}{dT}\right)$$

Differentiation of the second preceding equation yields:

$$\left(\frac{\partial \beta}{\partial P}\right)_T = -\frac{R}{VP^2} - \left(\frac{R}{P} + \frac{dB}{dT}\right) \frac{1}{V^2} \left(\frac{\partial V}{\partial P}\right)_T = -\frac{R}{VP^2} - (\beta V) \frac{1}{V^2} \left(\frac{\partial V}{\partial P}\right)_T$$

From the equation of state, 
$$\left(\frac{\partial V}{\partial P}\right)_T = -\frac{RT}{P^2}$$

Whence, 
$$\left(\frac{\partial \beta}{\partial P}\right)_T = -\frac{R}{VP^2} + \frac{\beta RT}{VP^2} = \frac{R}{VP^2}(\beta T - 1)$$

Clearly, the signs of quantity  $(\beta T - 1)$  and the derivative on the left are the same. The sign is determined from the relation of  $\beta$  and  $V$  to  $B$  and  $dB/dT$ :

$$\beta T - 1 = \frac{T}{V} \left(\frac{R}{P} + \frac{dB}{dT}\right) - 1 = \frac{\frac{RT}{P} + T \frac{dB}{dT}}{\frac{RT}{P} + B} - 1 = \frac{T \frac{dB}{dT} - B}{\frac{RT}{P} + B}$$

In this equation  $dB/dT$  is positive and  $B$  is negative. Because  $RT/P$  is greater than  $|B|$ , the quantity  $\beta T - 1$  is positive. This makes the derivative in the first boxed equation positive, and the second derivative in the second boxed equation negative.

**6.85** Since a reduced temperature of  $T_r = 2.7$  is well above "normal" temperatures for most gases, we expect on the basis of Fig. 3.10 that  $B$  is  $(-)$  and that  $dB/dT$  is  $(+)$ . Moreover,  $d^2B/dT^2$  is  $(-)$ .

By Eqs. (6.54) and (6.56), 
$$G^R = BP \quad \text{and} \quad S^R = -P(dB/dT)$$

Whence, both  $G^R$  and  $S^R$  are  $(-)$ . From the definition of  $G^R$ ,  $H^R = G^R + TS^R$ , and  $H^R$  is  $(-)$ .

By Eqs. (3.38) and (6.40), 
$$V^R = B, \quad \text{and} \quad V^R \text{ is } (-).$$

Combine the equations above for  $G^R$ ,  $S^R$ , and  $H^R$ :

$$H^R = P \left( B - T \frac{dB}{dT} \right) \quad \text{Whence,} \quad \left(\frac{\partial H^R}{\partial T}\right)_P = P \left( \frac{dB}{dT} - T \frac{d^2B}{dT^2} - \frac{dB}{dT} \right) = -PT \frac{d^2B}{dT^2}$$

Therefore,  $C_P^R \left(\frac{\partial H^R}{\partial T}\right)_P$  is  $(+)$ . (See Fig. 6.5.)

**6.89** By Eq. (3.5) at constant  $T$ : 
$$-P = \frac{1}{\kappa} \ln \frac{V}{V_1} - P_1 \quad (A)$$

(a) **Work** 
$$dW = -P dV = \left( \frac{1}{\kappa} \ln \frac{V}{V_1} - P_1 \right) dV = \frac{1}{\kappa} \ln V dV - \left( P_1 + \frac{1}{\kappa} \ln V_1 \right) dV$$

$$W = \frac{1}{\kappa} \int_{V_1}^{V_2} \ln V dV - \left( P_1 + \frac{1}{\kappa} \ln V_1 \right) (V_2 - V_1)$$

$$W = \frac{1}{\kappa} [(V_2 \ln V_2 - V_2) - (V_1 \ln V_1 - V_1)] - P_1 (V_2 - V_1) - \frac{1}{\kappa} (V_2 \ln V_1 - V_1 \ln V_1)$$

$$= \frac{1}{\kappa} \left[ V_2 \ln \frac{V_2}{V_1} + V_1 - V_2 \right] - P_1 (V_2 - V_1)$$

By Eq. (3.5),  $\ln \frac{V_2}{V_1} = -\kappa(P_2 - P_1)$     whence 
$$W = P_1 V_1 - P_2 V_2 - \frac{V_2 - V_1}{\kappa}$$

(b) **Entropy**    By Eq. (6.29), 
$$dS = -\beta V dP$$

By Eq. (A), 
$$-P = \frac{\ln V}{\kappa} - \frac{\ln V_1}{\kappa} - P_1 \quad \text{and} \quad -dP = \frac{1}{\kappa} d \ln V$$

$$dS = \frac{\beta V}{\kappa} d \ln V = \frac{\beta}{\kappa} dV \quad \text{and} \quad \Delta S = \frac{\beta}{\kappa} (V_2 - V_1)$$

(c) **Enthalpy**    By Eq. (6.28), 
$$dH = (1 - \beta T) V dP$$

Substitute for  $dP$ : 
$$dH = -(1 - \beta T) V \cdot \frac{1}{\kappa} d \ln V = -\frac{1 - \beta T}{\kappa} dV$$

$$\Delta H = \frac{1 - \beta T}{\kappa} (V_1 - V_2)$$

These equations are so simple that little is gained through use of an average  $V$ . For the conditions given in Pb. 6.9, calculations give:

$$W = 4.855 \text{ kJ kg}^{-1} \quad \Delta S = -0.036348 \text{ kJ kg}^{-1} \text{ K}^{-1} \quad \Delta H = 134.55 \text{ kJ kg}^{-1}$$

**6.90** The given equation will be true if and only if 
$$\left( \frac{\partial M}{\partial P} \right)_T dP = 0$$

The two circumstances for which this condition holds are when  $(\partial M / \partial P)_T = 0$  or when  $dP = 0$ . The former is a property feature and the latter is a process feature.

**6.91** 
$$\left( \frac{\partial H^{ig}}{\partial P} \right)_V = \left( \frac{\partial H^{ig}}{\partial P} \right)_T + \left( \frac{\partial H^{ig}}{\partial T} \right)_P \left( \frac{\partial T}{\partial P} \right)_V = C_P^{ig} \left( \frac{\partial T}{\partial P} \right)_V$$

Neither  $C_P^{ig}$  nor  $(\partial T / \partial P)_V$  is in general zero for an ideal gas.

$$\left( \frac{\partial H^{ig}}{\partial P} \right)_S = \left( \frac{\partial H^{ig}}{\partial P} \right)_T + \left( \frac{\partial H^{ig}}{\partial T} \right)_P \left( \frac{\partial T}{\partial P} \right)_S = C_P^{ig} \left( \frac{\partial T}{\partial P} \right)_S$$

$$\left(\frac{\partial T}{\partial P}\right)_S = -\left(\frac{\partial T}{\partial S^{ig}}\right)_P \left(\frac{\partial S^{ig}}{\partial P}\right)_T = \frac{T}{C_P^{ig}} \left(\frac{\partial S^{ig}}{\partial P}\right)_T$$

$$\left(\frac{\partial H^{ig}}{\partial P}\right)_S = T \left(\frac{\partial S^{ig}}{\partial P}\right)_T$$

Neither  $T$  nor  $(\partial S^{ig}/\partial P)_T$  is in general zero for an ideal gas. The difficulty here is that the expression *independent of pressure* is imprecise.

**6.92** For  $S = S(P, V)$ : 
$$dS = \left(\frac{\partial S}{\partial P}\right)_V dP + \left(\frac{\partial S}{\partial V}\right)_P dV$$

By the chain rule for partial derivatives,

$$dS = \left(\frac{\partial S}{\partial T}\right)_V \left(\frac{\partial T}{\partial P}\right)_V dP + \left(\frac{\partial S}{\partial T}\right)_P \left(\frac{\partial T}{\partial V}\right)_P dV$$

With Eqs. (6.30) and (6.17), this becomes:

$$dS = \frac{C_V}{T} \left(\frac{\partial T}{\partial P}\right)_V dP + \frac{C_P}{T} \left(\frac{\partial T}{\partial V}\right)_P dV$$

**6.93** By Eq. (6.31), 
$$P = T \left(\frac{\partial P}{\partial T}\right)_V - \left(\frac{\partial U}{\partial V}\right)_T$$

(a) For an ideal gas, 
$$P = \frac{RT}{V} \quad \text{and} \quad \left(\frac{\partial P}{\partial T}\right)_V = \frac{R}{V}$$

Therefore 
$$\frac{RT}{V} = \frac{RT}{V} - \left(\frac{\partial U}{\partial V}\right)_T \quad \text{and} \quad \left(\frac{\partial U}{\partial V}\right)_T = 0$$

(b) For a van der Waals gas, 
$$P = \frac{RT}{V-b} - \frac{a}{V^2} \quad \text{and} \quad \left(\frac{\partial P}{\partial T}\right)_V = \frac{R}{V-b}$$

Therefore 
$$\frac{RT}{V-b} - \frac{a}{V^2} = \frac{RT}{V-b} - \left(\frac{\partial U}{\partial V}\right)_T \quad \text{and} \quad \left(\frac{\partial U}{\partial V}\right)_T = \frac{a}{V^2}$$

(c) Similarly, for a Redlich/Kwong fluid find: 
$$\left(\frac{\partial U}{\partial V}\right)_T = \frac{(3/2)A}{T^{1/2}V(V+b)}$$

where 
$$A = a(T_c) \cdot T_c^{1/2}$$

**6.94** (a) The derivatives of  $G$  with respect to  $T$  and  $P$  follow from Eq. (6.10):

$$-S = \left(\frac{\partial G}{\partial T}\right)_P \quad \text{and} \quad V = \left(\frac{\partial G}{\partial P}\right)_T$$

Combining the definition of  $Z$  with the second of these gives:

$$Z \equiv \frac{PV}{RT} = \frac{P}{RT} \left(\frac{\partial G}{\partial P}\right)_T$$

Combining Eqs. (2.11) and (3.63) and solving for  $U$  gives  $U = G + TS - PV$ .

Replacing  $S$  and  $V$  by their derivatives gives:

$$U = G - T \left( \frac{\partial G}{\partial T} \right)_P - P \left( \frac{\partial G}{\partial P} \right)_T$$

Developing an equation for  $C_V$  is much less direct. First differentiate the above equation for  $U$  with respect to  $T$  and then with respect to  $P$ : The two resulting equations are:

$$\left( \frac{\partial U}{\partial T} \right)_P = -T \left( \frac{\partial^2 G}{\partial T^2} \right)_P - P \left( \frac{\partial^2 G}{\partial T \partial P} \right)$$

$$\left( \frac{\partial U}{\partial P} \right)_T = -T \left( \frac{\partial^2 G}{\partial T \partial P} \right) - P \left( \frac{\partial^2 G}{\partial P^2} \right)_T$$

From the definition of  $C_V$  and an equation relating partial derivatives:

$$C_V \left( \frac{\partial U}{\partial T} \right)_V = \left( \frac{\partial U}{\partial T} \right)_P + \left( \frac{\partial U}{\partial P} \right)_T \left( \frac{\partial P}{\partial T} \right)_V$$

Combining the three equations yields:

$$C_V = -T \left( \frac{\partial^2 G}{\partial T^2} \right)_P - P \left( \frac{\partial^2 G}{\partial T \partial P} \right) - \left[ T \left( \frac{\partial^2 G}{\partial T \partial P} \right) + P \left( \frac{\partial^2 G}{\partial P^2} \right)_T \right] \left( \frac{\partial P}{\partial T} \right)_V$$

Evaluate  $(\partial P/\partial T)_V$  through use of the chain rule:

$$\left( \frac{\partial P}{\partial T} \right)_V = - \left( \frac{\partial P}{\partial V} \right)_T \left( \frac{\partial V}{\partial T} \right)_P = \frac{-(\partial V/\partial T)_P}{(\partial V/\partial P)_T}$$

The two derivatives of the final term come from differentiation of  $V = (\partial G/\partial P)_T$ :

$$\left( \frac{\partial V}{\partial T} \right)_P = \left( \frac{\partial^2 G}{\partial P \partial T} \right) \quad \text{and} \quad \left( \frac{\partial V}{\partial P} \right)_T = \left( \frac{\partial^2 G}{\partial P^2} \right)_T$$

Then

$$\left( \frac{\partial P}{\partial T} \right)_V = \frac{-(\partial^2 G/\partial T)_P}{(\partial^2 G/\partial P^2)_T}$$

and

$$C_V = -T \left( \frac{\partial^2 G}{\partial T^2} \right)_P - P \left( \frac{\partial^2 G}{\partial T \partial P} \right) + \left[ T \left( \frac{\partial^2 G}{\partial T \partial P} \right) + P \left( \frac{\partial^2 G}{\partial P^2} \right)_T \right] \frac{(\partial^2 G/\partial P \partial T)}{(\partial^2 G/\partial P^2)_T}$$

Some algebra transforms this equation into a more compact form:

$$C_V = -T \left( \frac{\partial^2 G}{\partial T^2} \right)_P + T \frac{(\partial^2 G/\partial T \partial P)^2}{(\partial^2 G/\partial P^2)_T}$$

(b) The solution here is analogous to that of part (a), but starting with the derivatives inherent in Eq. (6.9).

**6.97** Equation (6.74) is exact:

$$\frac{d \ln P^{\text{sat}}}{d(1/T)} = - \frac{\Delta H^{lv}}{R \Delta Z^{lv}}$$

The right side is *approximately* constant owing to the qualitatively similar behavior of  $\Delta H^{lv}$  and  $\Delta Z^{lv}$ . Both decrease monotonically as  $T$  increases, becoming zero at the critical point.

**6.98** By the Clapeyron equation: 
$$\frac{dP^{\text{sat}}}{dT} = \frac{\Delta S^{sl}}{\Delta V^{sl}} = \frac{\Delta H^{sl}}{T \Delta V^{sl}}$$

If the ratio  $\Delta S^{sl}$  to  $\Delta V^{sl}$  is assumed approximately constant, then

$$P^{\text{sat}} = A + BT$$

If the ratio  $\Delta H^{sl}$  to  $\Delta V^{sl}$  is assumed approximately constant, then

$$P^{\text{sat}} = A + B \ln T$$

**6.99** By Eq. (6.73) and its analog for  $sv$  equilibrium:

$$\begin{aligned} \left( \frac{dP_{sv}^{\text{sat}}}{dT} \right)_t &= \frac{P_t \Delta H_t^{sv}}{RT_t^2 \Delta Z_t^{sv}} \approx \frac{P_t \Delta H_t^{sv}}{RT_t^2} \\ \left( \frac{dP_{lv}^{\text{sat}}}{dT} \right)_t &= \frac{P_t \Delta H_t^{lv}}{RT_t^2 \Delta Z_t^{lv}} \approx \frac{P_t \Delta H_t^{lv}}{RT_t^2} \\ \left( \frac{dP_{sv}^{\text{sat}}}{dT} \right)_t - \left( \frac{dP_{lv}^{\text{sat}}}{dT} \right)_t &\approx \frac{P_t}{RT_t^2} (\Delta H_t^{sv} - \Delta H_t^{lv}) \end{aligned}$$

Because  $(\Delta H_t^{sv} - \Delta H_t^{lv}) = \Delta H_t^{sl}$  is positive, then so is the left side of the preceding equation.

**6.100** By Eq. (6.72): 
$$\frac{dP^{\text{sat}}}{dT} = \frac{\Delta H^{lv}}{T \Delta V^{lv}}$$

But  $\Delta V^{lv} = \frac{RT}{P^{\text{sat}}} \Delta Z^{lv}$  whence 
$$\frac{d \ln P^{\text{sat}}}{dT} = \frac{\Delta H^{lv}}{RT^2 \Delta Z^{lv}} \quad (6.73)$$

$$\frac{d \ln P_r^{\text{sat}}}{dT_r} = \frac{T_c \Delta H^{lv}}{RT_c^2 \Delta Z^{lv}} = \frac{\Delta H^{lv}}{RT_c} \cdot \frac{1}{T_r^2 \Delta Z^{lv}} = \boxed{\frac{\widehat{\Delta H}^{lv}}{T_r^2 \Delta Z^{lv}}}$$

**6.102** Convert  $\alpha_c$  to reduced conditions:

$$\alpha_c \equiv \left[ \frac{d \ln P^{\text{sat}}}{d \ln T} \right]_{T=T_c} = \left[ \frac{d \ln P_r^{\text{sat}}}{d \ln T_r} \right]_{T_r=1} = T_r \left[ \frac{d \ln P_r^{\text{sat}}}{dT_r} \right]_{T_r=1} = \boxed{\left[ \frac{d \ln P_r^{\text{sat}}}{dT_r} \right]_{T_r=1}}$$

From the Lee/Kesler equation, find that

$$\left[ \frac{d \ln P_r^{\text{sat}}}{dT_r} \right]_{T_r=1} = 5.8239 + 4.8300 \omega$$

Thus,  $\alpha_c(\text{L/K}) = 5.82$  for  $\omega = 0$ , and increases with increasing molecular complexity as quantified by  $\omega$ .

## Chapter 7 - Section B - Non-Numerical Solutions

7.2 (a) Apply the general equation given in the footnote on page 266 to the particular derivative of interest here:

$$\left(\frac{\partial T}{\partial P}\right)_S = -\left(\frac{\partial T}{\partial S}\right)_P \left(\frac{\partial S}{\partial P}\right)_T$$

The two partial derivatives on the right are found from Eqs. (6.17) and (6.16); thus,

$$\boxed{\left(\frac{\partial T}{\partial P}\right)_S = \frac{T}{C_P} \left(\frac{\partial V}{\partial T}\right)_P}$$

For gases, this derivative is positive. It applies to reversible adiabatic expansions and compressions in turbines and compressors.

(b) Application of the same general relation (page 266) yields:

$$\left(\frac{\partial T}{\partial V}\right)_U = -\left(\frac{\partial T}{\partial U}\right)_V \left(\frac{\partial U}{\partial V}\right)_T$$

The two partial derivatives on the right are found from Eqs. (2.16) and (6.31); thus,

$$\boxed{\left(\frac{\partial T}{\partial V}\right)_U = \frac{1}{C_V} \left[ P - T \left(\frac{\partial P}{\partial T}\right)_V \right]}$$

For gases, this may be positive or negative, depending on conditions. Note that it is zero for an ideal gas. It applies directly to the *Joule expansion*, an adiabatic expansion of gas confined in a portion of a container to fill the entire container.

7.3 The equation giving the thermodynamic sound speed appears in the middle of page 257. As written, it implicitly requires that  $V$  represent *specific* volume. This is easily confirmed by a dimensional analysis. If  $V$  is to be *molar* volume, then the right side must be divided by molar mass:

$$c^2 = -\frac{V^2}{\mathcal{M}} \left(\frac{\partial P}{\partial V}\right)_S \tag{A}$$

Applying the equation given in the footnote on page 266 to the derivative yields:

$$\left(\frac{\partial P}{\partial V}\right)_S = -\left(\frac{\partial P}{\partial S}\right)_V \left(\frac{\partial S}{\partial V}\right)_P$$

This can also be written:

$$\left(\frac{\partial P}{\partial V}\right)_S = -\left[\left(\frac{\partial P}{\partial T}\right)_V \left(\frac{\partial T}{\partial S}\right)_V\right] \left[\left(\frac{\partial S}{\partial T}\right)_P \left(\frac{\partial T}{\partial V}\right)_P\right] = -\left[\left(\frac{\partial T}{\partial S}\right)_V \left(\frac{\partial S}{\partial T}\right)_P\right] \left[\left(\frac{\partial P}{\partial T}\right)_V \left(\frac{\partial T}{\partial V}\right)_P\right]$$

Division of Eq. (6.17) by Eq. (6.30) shows that the first product in square brackets on the far right is the ratio  $C_P/C_V$ . Reference again to the equation of the footnote on page 266 shows that the second product in square brackets on the far right is  $-(\partial P/\partial V)_T$ , which is given by Eq. (3.3).

Therefore,

$$\left(\frac{\partial P}{\partial V}\right)_S = \frac{C_P}{C_V} \left(\frac{\partial P}{\partial V}\right)_T = \frac{C_P}{C_V} \left(\frac{-1}{\kappa V}\right)$$

Substitute into Eq. (A):  $c^2 = \frac{VC_P}{\mathcal{M}C_V\kappa}$  or

$$c = \sqrt{\frac{VC_P}{\mathcal{M}C_V\kappa}}$$

(a) For an ideal gas,  $V = RT/P$  and  $\kappa = 1/P$ . Therefore,  $c^{ig} = \sqrt{\frac{RT C_P}{\mathcal{M} C_V}}$

(b) For an incompressible liquid,  $V$  is constant, and  $\kappa = 0$ , leading to the result:  $c = \infty$ . This of course leads to the conclusion that the sound speed in liquids is much greater than in gases.

## 7.6

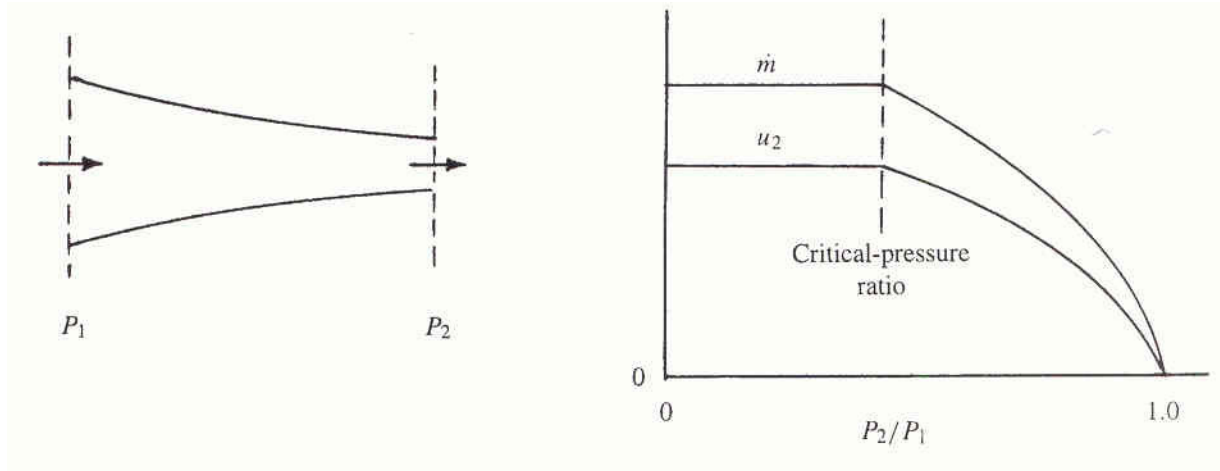

As  $P_2$  decreases from an initial value of  $P_2 = P_1$ , both  $u_2$  and  $\dot{m}$  steadily increase until the critical-pressure ratio is reached. At this value of  $P_2$ ,  $u_2$  equals the speed of sound in the gas, and further reduction in  $P_2$  does not affect  $u_2$  or  $\dot{m}$ .

**7.7** The mass-flow rate  $\dot{m}$  is of course constant throughout the nozzle from entrance to exit.

The velocity  $u$  rises monotonically from nozzle entrance ( $P/P_1 = 1$ ) to nozzle exit as  $P$  and  $P/P_1$  decrease.

The area ratio decreases from  $A/A_1 = 1$  at the nozzle entrance to a minimum value at the throat and thereafter increases to the nozzle exit.

**7.8** Substitution of Eq. (7.12) into (7.11), with  $u_1 = 0$  gives:

$$u_{\text{throat}}^2 = \frac{2\gamma P_1 V_1}{\gamma - 1} \left(1 - \frac{2}{\gamma + 1}\right) = \gamma P_1 V_1 \left(\frac{2}{\gamma + 1}\right)$$

where  $V_1$  is *specific volume* in  $\text{m}^3 \cdot \text{kg}^{-1}$  and  $P_1$  is in Pa. The units of  $u_{\text{throat}}^2$  are then:

$$\text{Pa} \cdot \text{m}^3 \cdot \text{kg}^{-1} = \frac{\text{N}}{\text{m}^2} \cdot \text{m}^3 \cdot \text{kg}^{-1} = \text{N} \cdot \text{m} \cdot \text{kg}^{-1} = \text{kg} \cdot \text{m} \cdot \text{s}^{-2} \cdot \text{m} \cdot \text{kg}^{-1} = \text{m}^2 \cdot \text{s}^{-2}$$

With respect to the final term in the preceding equation, note that  $P_1 V_1$  has the units of energy per unit mass. Because  $1 \text{ N} \cdot \text{m} = 1 \text{ J}$ , equivalent units are  $\text{J} \cdot \text{kg}^{-1}$ . Moreover,  $P_1 V_1 = RT_1/M$ ; whence

$$u_{\text{throat}}^2 = \frac{\gamma RT_1}{M} \left(\frac{2}{\gamma + 1}\right)$$

With  $R$  in units of  $\text{J} \cdot (\text{kg mol})^{-1} \cdot \text{K}^{-1}$ ,  $RT_1/M$  has units of  $\text{J} \cdot \text{kg}^{-1}$  or  $\text{m}^2 \cdot \text{s}^{-2}$ .

**7.16** It is shown at the end of Ex. 7.5 that the Joule/Thomson inversion curve is the locus of states for which  $(\partial Z/\partial T)_P = 0$ . We apply the following general equation of differential calculus:

$$\left(\frac{\partial x}{\partial y}\right)_z = \left(\frac{\partial x}{\partial y}\right)_w + \left(\frac{\partial x}{\partial w}\right)_y \left(\frac{\partial w}{\partial y}\right)_z$$

$$\left(\frac{\partial Z}{\partial T}\right)_P = \left(\frac{\partial Z}{\partial T}\right)_\rho + \left(\frac{\partial Z}{\partial \rho}\right)_T \left(\frac{\partial \rho}{\partial T}\right)_P$$

Whence,

$$\left(\frac{\partial Z}{\partial T}\right)_\rho = \left(\frac{\partial Z}{\partial T}\right)_P - \left(\frac{\partial Z}{\partial \rho}\right)_T \left(\frac{\partial \rho}{\partial T}\right)_P$$

Because  $P = \rho ZRT$ ,  $\rho = \frac{P}{ZRT}$  and  $\left(\frac{\partial \rho}{\partial T}\right)_P = \frac{P}{R} \left\{ \frac{-1}{(ZT)^2} \left[ Z + T \left(\frac{\partial Z}{\partial T}\right)_P \right] \right\}$

Setting  $(\partial Z/\partial T)_P = 0$  in each of the two preceding equations reduces them to:

$$\left(\frac{\partial Z}{\partial T}\right)_\rho = - \left(\frac{\partial Z}{\partial \rho}\right)_T \left(\frac{\partial \rho}{\partial T}\right)_P \quad \text{and} \quad \left(\frac{\partial \rho}{\partial T}\right)_P = - \frac{P}{ZRT^2} = - \frac{\rho}{T}$$

Combining these two equations yields:

$$\boxed{T \left(\frac{\partial Z}{\partial T}\right)_\rho = \rho \left(\frac{\partial Z}{\partial \rho}\right)_T}$$

(a) Equation (3.42) with van der Waals parameters becomes:

$$P = \frac{RT}{V-b} - \frac{a}{V^2}$$

Multiply through by  $V/RT$ , substitute  $Z = PV/RT$ ,  $V = 1/\rho$ , and rearrange:

$$Z = \frac{1}{1-b\rho} - \frac{a\rho}{RT}$$

In accord with Eq. (3.51), define  $q \equiv a/bRT$ . In addition, define  $\xi \equiv b\rho$ . Then,

$$Z = \frac{1}{1-\xi} - q\xi \tag{A}$$

Differentiate:

$$\left(\frac{\partial Z}{\partial T}\right)_\rho = \left(\frac{\partial Z}{\partial T}\right)_\xi = -\xi \frac{dq}{dT}$$

By Eq. (3.54) with  $\alpha(T_r) = 1$  for the van der Waals equation,  $q = \Psi/\Omega T_r$ . Whence,

$$\frac{dq}{dT} = \frac{\Psi}{\Omega} \left(\frac{-1}{T_r^2}\right) \frac{dT_r}{dT} = -\frac{\Psi}{\Omega} \frac{1}{T_r^2 T_c} = -\frac{\Psi}{\Omega} \frac{1}{T T_r} = -\frac{q}{T}$$

Then,

$$\left(\frac{\partial Z}{\partial T}\right)_\rho = (-\xi) \left(-\frac{q}{T}\right) = \frac{q\xi}{T}$$

In addition,

$$\left(\frac{\partial Z}{\partial \rho}\right)_T = b \left(\frac{\partial Z}{\partial \xi}\right)_T = \frac{b}{(1-\xi)^2} - qb$$



Substitute for the two partial derivatives in the boxed equation:

$$T \frac{q\xi}{T} = \frac{b\rho}{(1-\xi)^2} - qb\rho \quad \text{or} \quad q\xi = \frac{\xi}{(1-\xi)^2} - q\xi$$

Whence, 
$$\xi = 1 - \frac{1}{\sqrt{2q}} \quad (B)$$

By Eq. (3.46),  $P_c = \Omega RT_c/b$ . Moreover,  $P = Z\rho RT$ . Division of the second equation by the first gives  $P_r = Z\rho bT/\Omega T_c$ . Whence

$$P_r = \frac{Z\xi T_r}{\Omega} \quad (C)$$

These equations allow construction of a  $T_r$  vs.  $P_r$  inversion curve as in Fig. 7.2. For a given value of  $T_r$ , calculate  $q$ . Equation (B) then gives  $\xi$ , Eq. (A) gives  $Z$ , and Eq. (C) gives  $P_r$ .

(b) Proceed exactly as in Part (a), with exactly the same definitions. This leads to a new Eq. (A):

$$Z = \frac{1}{1-\xi} - \frac{q\xi}{1+\xi} \quad (A)$$

By Eq. (3.54) with  $\alpha(T_r) = T_r^{-0.5}$  for the Redlich/Kwong equation,  $q = \Psi/\Omega T_r^{1.5}$ . This leads to:

$$\frac{dq}{dT} = -\frac{1.5q}{T} \quad \text{and} \quad \left(\frac{\partial Z}{\partial T}\right)_\rho = \frac{1.5q\xi}{T(1+\xi)}$$

Moreover, 
$$\left(\frac{\partial Z}{\partial \rho}\right)_T = \frac{b}{(1-\xi)^2} - \frac{bq}{(1+\xi)^2}$$

Substitution of the two derivatives into the boxed equation leads to a new Eq. (B):

$$q = \left(\frac{1+\xi}{1-\xi}\right)^2 \left(\frac{1}{2.5+1.5\xi}\right) \quad (B)$$

As in Part (a), for a given  $T_r$ , calculate  $q$ , and solve Eq. (B) for  $\xi$ , by trial or a by a computer routine. As before, Eq. (A) then gives  $Z$ , and Eq. (C) of Part (a) gives  $P_r$ .

**7.17** (a) Equal to. (b) Less than. (c) Less than. (d) Equal to. (e) Equal to.

**7.28** When a saturated liquid is expanded in a turbine some of the liquid vaporizes. A turbine properly designed for expansion of liquids cannot handle the much larger volumes resulting from the formation of vapor. For example, if saturated liquid at 5 bar expands isentropically to 1 bar, the fraction of the original liquid that vaporizes is found as follows:

$$S_2 = S_2^l + x_2^v(S_2^v - S_2^l) = S_1$$

or 
$$x_2^v = \frac{S_1 - S_2^l}{S_2^v - S_2^l} = \frac{1.8604 - 1.3027}{7.3598 - 1.3027} = 0.0921$$

Were the expansion irreversible, the fraction of liquid vaporized would be even greater.

**7.33** Apply Eq. (2.29) to this non-steady-state process, with  $n$  replacing  $m$ , with the tank as control volume, and with a single inlet stream. Since the process is adiabatic and the only work is shaft work, this equation may be multiplied by  $dt$  to give:

$$d(nU)_{\text{tank}} - H dn = dW_s$$

Because the inlet stream has constant properties, integration from beginning to end of the process yields:

$$W_s = n_2 U_2 - n_1 U_1 - nH$$

where the subscripted quantities refer to the contents of the tank and  $n$  and  $H$  refer to the inlet stream. Substitute  $n = n_2 - n_1$  and  $H = U + PV = U + RT$ :

$$W_s = n_2 U_2 - n_1 U_1 - (n_2 - n_1)(U + RT) = n_2(U_2 - U - RT) - n_1(U_1 - U - RT)$$

With  $\Delta U = C_V \Delta T$  for an ideal gas with constant heat capacities, this becomes:

$$W_s = n_2[C_V(T_2 - T) - RT] - n_1[C_V(T_1 - T) - RT]$$

However,  $T = T_1$ , and therefore:

$$W_s = n_2[C_V(T_2 - T_1) - RT_1] + n_1 RT_1$$

By Eq. (3.30b),  $T_2 = \left(\frac{P_2}{P_1}\right)^{(\gamma-1)/\gamma}$

Moreover,  $n_1 = \frac{P_1 V_{\text{tank}}}{RT_1}$  and  $n_2 = \frac{P_2 V_{\text{tank}}}{RT_2}$

With  $\gamma = 1.4$ ,  $T_2 = 573.47$  K. Then, with  $R = 8.314 \text{ m}^3 \text{ kPa kmol}^{-1} \text{ K}^{-1}$ ,

$$n_1 = \frac{(101.33)(20)}{(8.314)(298.15)} = 0.8176 \text{ kmol} \quad \text{and} \quad n_2 = \frac{(1000)(20)}{(8.314)(573.47)} = 4.1948 \text{ kmol}$$

Substitution of numerical values into the boxed equation, with  $R = 8.314 \text{ kJ kmol}^{-1} \text{ K}^{-1}$ , gives:

$$W_s = 15,633 \text{ kJ}$$

**7.40** Combine Eqs. (7.13) and (7.17):

$$\dot{W}_s = \dot{n} \Delta H = \dot{n} \frac{(\Delta H)_S}{\eta}$$

By Eq. (6.8),  $(\Delta H)_S = \int V dP = \langle V \rangle \Delta P$

Assume now that  $\Delta P$  is small enough that  $\langle V \rangle$ , an average value, can be approximated by  $V_1 = RT_1/P_1$ . Then

$$(\Delta H)_S = \frac{RT_1}{P_1} \Delta P \quad \text{and} \quad \dot{W}_s = \dot{n} \frac{RT_1}{\eta P_1} \Delta P$$

Equation (7.22) is the usual equation for isentropic compression of an ideal gas with constant heat capacities. For irreversible compression it can be rewritten:

$$\dot{W}_s = \frac{\dot{n} C_P T_1}{\eta} \left[ \left(\frac{P_2}{P_1}\right)^{R/C_P} - 1 \right]$$

For  $\Delta P$  sufficiently small, the quantity in square brackets becomes:

$$\left(\frac{P_2}{P_1}\right)^{R/C_P} - 1 = \left(1 + \frac{\Delta P}{P_1}\right)^{R/C_P} - 1 \cong \left(1 + \frac{R}{C_P} \frac{\Delta P}{P_1}\right) - 1$$

The boxed equation is immediately recovered from this result.

**7.41** The equation immediately preceding Eq. (7.22) page 276 gives  $T_2' = T_1\pi$ . With this substitution, Eq. (7.23) becomes:

$$T_2 = T_1 + \frac{T_1\pi - T_1}{\eta} = T_1 \left( 1 + \frac{\pi - 1}{\eta} \right)$$

The entropy generation  $S_G$  is simply  $\Delta S$  for the compression process, for which Eq. (5.14) may be rewritten:

$$\frac{\Delta S}{R} = \frac{C_P}{R} \ln \frac{T_2}{T_1} - \ln \frac{P_2}{P_1} = \frac{C_P}{R} \ln \frac{T_2}{T_1} - \frac{C_P}{R} \ln \left( \frac{P_2}{P_1} \right)^{R/C_P}$$

Combine the two preceding equations:

$$\frac{\Delta S}{R} = \frac{C_P}{R} \left[ \ln \left( 1 + \frac{\pi - 1}{\eta} \right) - \ln \pi \right] = \frac{C_P}{R} \ln \frac{1 + \frac{\pi - 1}{\eta}}{\pi}$$

Whence,

$$\boxed{\frac{S_G}{R} = \frac{C_P}{R} \ln \left( \frac{\eta + \pi - 1}{\eta\pi} \right)}$$

**7.43** The relevant fact here is that  $C_P$  increases with increasing molecular complexity. Isentropic compression work on a mole basis is given by Eq. (7.22), which can be written:

$$W_s = C_P T_1 (\pi - 1) \quad \text{where} \quad \pi \equiv \left( \frac{P_2}{P_1} \right)^{R/C_P}$$

This equation is a proper basis, because compressor efficiency  $\eta$  and flowrate  $\dot{n}$  are fixed. With all other variables constant, differentiation yields:

$$\frac{dW_s}{dC_P} = T_1 \left[ (\pi - 1) + C_P \frac{d\pi}{dC_P} \right]$$

From the definition of  $\pi$ ,

$$\ln \pi = \frac{R}{C_P} \ln \frac{P_2}{P_1} \quad \text{whence} \quad \frac{d \ln \pi}{dC_P} = \frac{1}{\pi} \frac{d\pi}{dC_P} = -\frac{R}{C_P^2} \ln \frac{P_2}{P_1}$$

Then,

$$\frac{d\pi}{dC_P} = -\frac{\pi R}{C_P^2} \ln \frac{P_2}{P_1}$$

and

$$\frac{dW_s}{dC_P} = T_1 \left( \pi - 1 - \frac{\pi R}{C_P} \ln \frac{P_2}{P_1} \right) = T_1 (\pi - 1 - \pi \ln \pi)$$

When  $\pi = 1$ , the derivative is zero; for  $\pi > 1$ , the derivative is negative (try some values). Thus, the work of compression decreases as  $C_P$  increases and as the molecular complexity of the gas increases.

**7.45** The appropriate energy balance can be written:  $W = \Delta H - Q$ . Since  $Q$  is negative (heat transfer is *out* of the system), the work of non-adiabatic compression is greater than for adiabatic compression. Note that in order to have the *same change in state of the air*, i.e., the *same*  $\Delta H$ , the irreversibilities of operation would have to be quite different for the two cases.

**7.46** There is in fact no cause for concern, as adiabatic compression sends the steam further into the superheat region.

- 7.49** (a) This result follows immediately from the last equation on page 267 of the text.  
 (b) This result follows immediately from the middle equation on page 267 of the text.  
 (c) This result follows immediately from Eq. (6.19) on page 267 of the text.

(d)  $\left(\frac{\partial Z}{\partial V}\right)_P = \left(\frac{\partial Z}{\partial T}\right)_P \left(\frac{\partial T}{\partial V}\right)_P$  but by (a), this is zero.

(e) Rearrange the given equation:  $\frac{V}{T} = -\frac{(\partial P/\partial T)_V}{(\partial P/\partial V)_T} = -\left(\frac{\partial V}{\partial P}\right)_T \left(\frac{\partial P}{\partial T}\right)_V = \left(\frac{\partial V}{\partial T}\right)_P$

For the final equality see footnote on p. 266. This result is the equation of (c).

**7.50** From the result of Pb. 7.3:  $c = \sqrt{\frac{V}{\mathcal{M}} \cdot \frac{C_P}{C_V} \cdot \frac{1}{\kappa}}$  where  $\kappa = -\frac{1}{V} \left(\frac{\partial V}{\partial P}\right)_T$

With  $V = \frac{RT}{P} + B$  then  $\left(\frac{\partial V}{\partial P}\right)_T = -\frac{RT}{P^2}$  Also, let  $\gamma = \frac{C_P}{C_V}$

Then  $c = PV \sqrt{\frac{\gamma}{\mathcal{M}RT}} = (RT + BP) \sqrt{\frac{\gamma}{\mathcal{M}RT}} = \left(1 + \frac{BP}{RT}\right) \sqrt{\frac{\gamma RT}{\mathcal{M}}}$

$$c = \sqrt{\frac{\gamma RT}{\mathcal{M}}} + \frac{B}{RT} \sqrt{\frac{\gamma RT}{\mathcal{M}}} \cdot P$$

A value for  $B$  at temperature  $T$  may be extracted from a linear fit of  $c$  vs.  $P$ .

- 7.51** (a) On the basis of Eq. (6.8), write:

$$\Delta H_S^{ig} = \int V^{ig} dP = \int \frac{RT}{P} dP \quad (\text{const } S)$$

$$\Delta H_S = \int V dP = \int \frac{ZRT}{P} dP \quad (\text{const } S)$$

$$\frac{\Delta H_S}{\Delta H_S^{ig}} = \frac{\int \frac{ZRT}{P} dP \quad (\text{const } S)}{\int \frac{RT}{P} dP \quad (\text{const } S)} \equiv \langle Z \rangle$$

By extension, and with equal turbine efficiencies,

$$\frac{\Delta H}{\Delta H^{ig}} = \frac{\dot{W}}{\dot{W}^{ig}} = \langle Z \rangle$$

- 7.52** By Eq. (7.16),  $\Delta H = \eta(\Delta H)_S$  For  $C_P = \text{constant}$ ,  $T_2 - T_1 = \eta[(T_2)_S - T_1]$

For an ideal gas with constant  $C_P$ ,  $(T_2)_S$  is related to  $T_1$  by (see p. 77):  $(T_2)_S = T_1 \left(\frac{P_2}{P_1}\right)^{R/C_P}$

Combine the last two equations, and solve for  $T_2$ :  $T_2 = T_1 \left\{ 1 + \eta \left[ \left(\frac{P_2}{P_1}\right)^{R/C_P} - 1 \right] \right\}$

From which 
$$\eta = \frac{\frac{T_2}{T_1} - 1}{\left(\frac{P_2}{P_1}\right)^{R/C_p} - 1}$$
 Note that  $\eta < 1$

*Results:* For  $T_2 = 318$  K,  $\eta = 1.123$ ; For  $T_2 = 348$  K,  $\eta = 1.004$ ; For  $T_2 = 398$  K,  $\eta = 0.805$ .  
Only  $T_2 = 398$  K is possible.

- 7.55** The proposal of Pb. 7.53, i.e., pumping of liquid followed by vaporization. The reason is that pumping a liquid is much less expensive than vapor compression.
- 7.56** What is required here is the lowest saturated steam temperature that satisfies the  $\Delta T$  constraint. Data from Tables F.2 and B.2 lead to the following:  
Benzene/4.5 bar; *n*-Decane/17 bar; Ethylene glycol/33 bar; *o*-Xylene/9 bar

## Chapter 8 - Section B - Non-Numerical Solutions

**8.12** (a) Because Eq. (8.7) for the efficiency  $\eta_{\text{Diesel}}$  includes the *expansion ratio*,  $r_e \equiv V_B/V_A$ , we relate this quantity to the *compression ratio*,  $r \equiv V_C/V_D$ , and the *Diesel cutoff ratio*,  $r_c \equiv V_A/V_D$ . Since  $V_C = V_B$ ,  $r_e = V_C/V_A$ . Whence,

$$\frac{r}{r_e} = \frac{V_C/V_D}{V_C/V_A} = \frac{V_A}{V_D} = r_c \quad \text{or} \quad \frac{1}{r_e} = \frac{r_c}{r}$$

Equation (8.7) can therefore be written:

$$\eta_{\text{Diesel}} = 1 - \frac{1}{\gamma} \left[ \frac{(r_c/r)^\gamma - (1/r)^\gamma}{r_c/r - 1/r} \right] = 1 - \frac{1}{\gamma} \frac{(1/r)^\gamma}{1/r} \left( \frac{r_c^\gamma - 1}{r_c - 1} \right)$$

or 
$$\eta_{\text{Diesel}} = 1 - \left(\frac{1}{r}\right)^{\gamma-1} \frac{r_c^\gamma - 1}{\gamma(r_c - 1)}$$

(b) We wish to show that:

$$\frac{r_c^\gamma - 1}{\gamma(r_c - 1)} > 1 \quad \text{or more simply} \quad \frac{x^a - 1}{a(x - 1)} > 1$$

Taylor's theorem with remainder, taken to the 1st derivative, is written:

$$g = g(1) + g'(1) \cdot (x - 1) + \mathcal{R}$$

where, 
$$\mathcal{R} \equiv \frac{g''[1 + \theta(x - 1)]}{2!} \cdot (x - 1)^2 \quad (0 < \theta < 1)$$

Then, 
$$x^a = 1 + a \cdot (x - 1) + \frac{1}{2}a \cdot (a - 1) \cdot [1 + \theta(x - 1)]^{a-2} \cdot (x - 1)^2$$

Note that the final term is  $\mathcal{R}$ . For  $a > 1$  and  $x > 1$ ,  $\mathcal{R} > 0$ . Therefore:

$$x^a > 1 + a \cdot (x - 1) \quad x^a - 1 > a \cdot (x - 1)$$

and 
$$\frac{r_c^\gamma - 1}{\gamma(r_c - 1)} > 1$$

(c) If  $\gamma = 1.4$  and  $r = 8$ , then by Eq. (8.6):

$$\eta_{\text{Otto}} = 1 - \left(\frac{1}{8}\right)^{0.4} \quad \text{and} \quad \boxed{\eta_{\text{Otto}} = 0.5647}$$

•  $r_c = 2$       $\eta_{\text{Diesel}} = 1 - \left(\frac{1}{8}\right)^{0.4} \frac{2^{1.4} - 1}{1.4(2 - 1)}$      and      $\eta_{\text{Diesel}} = 0.4904$

•  $r_c = 3$       $\eta_{\text{Diesel}} = 1 - \left(\frac{1}{8}\right)^{0.4} \frac{3^{1.4} - 1}{1.4(3 - 1)}$      and      $\eta_{\text{Diesel}} = 0.4317$

**8.15** See the figure below. In the regenerative heat exchanger, the air temperature is raised in step  $B \rightarrow B^*$ , while the air temperature decreases in step  $D \rightarrow D^*$ . Heat addition (replacing combustion) is in step  $B^* \rightarrow C$ .

By definition, 
$$\eta \equiv \frac{-W_{AB} - W_{CD}}{Q_{B^*C}}$$

where, 
$$W_{AB} = (H_B - H_A) = C_P(T_B - T_A)$$

$$W_{CD} = (H_D - H_C) = C_P(T_D - T_C)$$

$$Q_{B^*C} = C_P(T_C - T_{B^*}) = C_P(T_C - T_D)$$

Whence, 
$$\eta = \frac{T_A - T_B + T_C - T_D}{T_C - T_D} = 1 - \frac{T_B - T_A}{T_C - T_D}$$

By Eq. (3.30b),

$$T_B = T_A \left( \frac{P_B}{P_A} \right)^{(\gamma-1)/\gamma} \quad \text{and} \quad T_D = T_C \left( \frac{P_D}{P_C} \right)^{(\gamma-1)/\gamma} = T_C \left( \frac{P_A}{P_B} \right)^{(\gamma-1)/\gamma}$$

Then, 
$$\eta = 1 - \frac{T_A \left[ \left( \frac{P_B}{P_A} \right)^{(\gamma-1)/\gamma} - 1 \right]}{T_C \left[ 1 - \left( \frac{P_A}{P_B} \right)^{(\gamma-1)/\gamma} \right]}$$

Multiplication of numerator and denominator by  $(P_B/P_A)^{(\gamma-1)/\gamma}$  gives:

$$\eta = 1 - \frac{T_A}{T_C} \left( \frac{P_B}{P_A} \right)^{(\gamma-1)/\gamma}$$

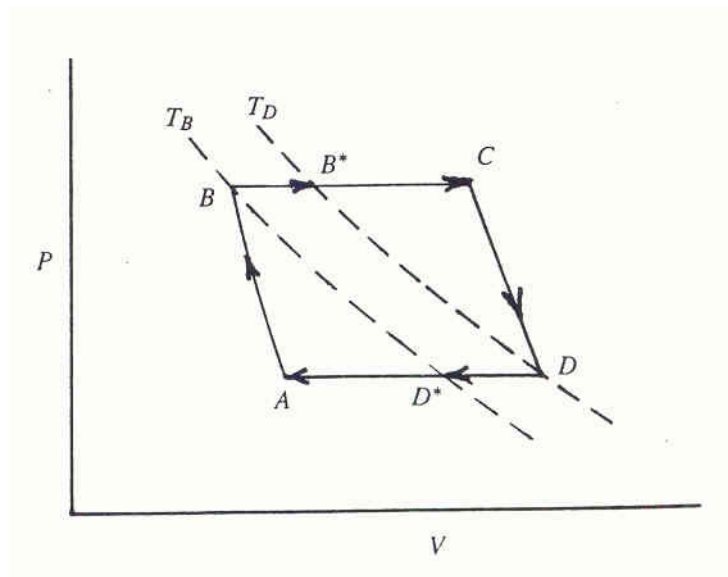

**8.21** We give first a general treatment of paths on a  $PT$  diagram for an ideal gas with constant heat capacities undergoing reversible polytropic processes. Equation (3.35c), p. 78, may be rewritten as

$$P = KT^{\delta/(\delta-1)} \quad \ln P = \ln K + \frac{\delta}{\delta-1} \ln T \quad \frac{dP}{P} = \frac{\delta}{\delta-1} \frac{dT}{T}$$

$$\boxed{\frac{dP}{dT} = \frac{\delta}{\delta-1} \frac{P}{T}} \quad (A)$$

Sign of  $dP/dT$  is that of  $\delta - 1$ , i.e., +

$$\text{Special cases } \begin{cases} \delta = 0 \longrightarrow dP/dT = 0 & \text{Constant } P \\ \delta = 1 \longrightarrow dP/dT = \infty & \text{Constant } T \end{cases}$$

By Eq. (A), 
$$\frac{d^2P}{dT^2} = \frac{\delta}{\delta-1} \left( \frac{1}{T} \frac{dP}{dT} - \frac{P}{T^2} \right) = \frac{\delta}{\delta-1} \frac{1}{T} \left( \frac{\delta}{\delta-1} \frac{P}{T} - \frac{P}{T} \right)$$

$$\boxed{\frac{d^2P}{dT^2} = \frac{\delta}{(\delta-1)^2} \frac{P}{T^2}} \quad (B)$$

Sign of  $d^2P/dT^2$  is that of  $\delta$ , i.e., +

For a constant- $V$  process,  $P$  varies with  $T$  in accord with the ideal-gas law:  $P = RT/V$  or  $P = KT$ . With respect to the initial equation,  $P = KT^{\delta/(\delta-1)}$ , this requires  $\delta = \infty$ . Moreover,  $dP/dT = K$  and  $d^2P/dT^2 = 0$ . Thus a constant- $V$  process is represented on a  $PT$  diagram as part of a straight line passing through the origin. The slope  $K$  is determined by the initial  $PT$  coordinates.

For a reversible adiabatic process (an isentropic process),  $\delta = \gamma$ . In this case Eqs. (A) and (B) become:

$$\frac{dP}{dT} = \frac{\gamma}{\gamma-1} \frac{P}{T} \quad \frac{d^2P}{dT^2} = \frac{\gamma}{(\gamma-1)^2} \frac{P}{T^2}$$

We note here that  $\gamma/(\gamma-1)$  and  $\gamma/(\gamma-1)^2$  are both  $> 1$ . Thus in relation to a constant- $V$  process the isentropic process is represented by a line of greater slope and greater curvature for the same  $T$  and  $P$ . Lines characteristic of the various processes are shown on the following diagram.

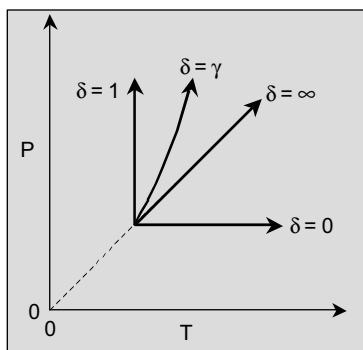

The required sketches appear on the following page. (Courtesy of Prof. Mark T. Swihart, State University of New York at Buffalo.)



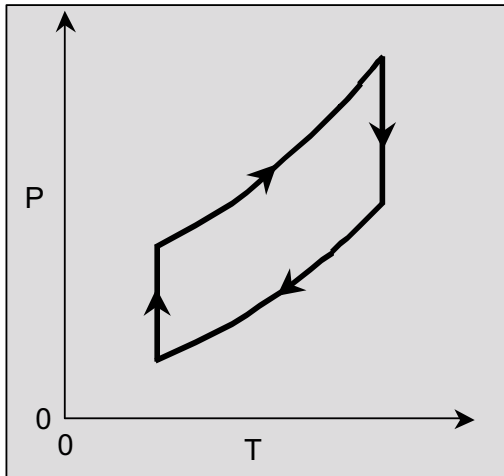

Figure 1: The Carnot cycle

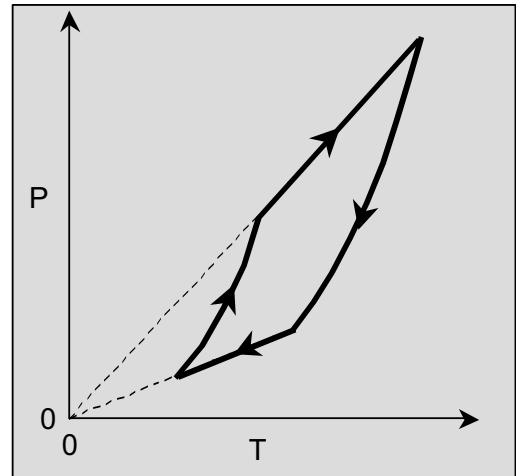

Figure 2: The Otto cycle

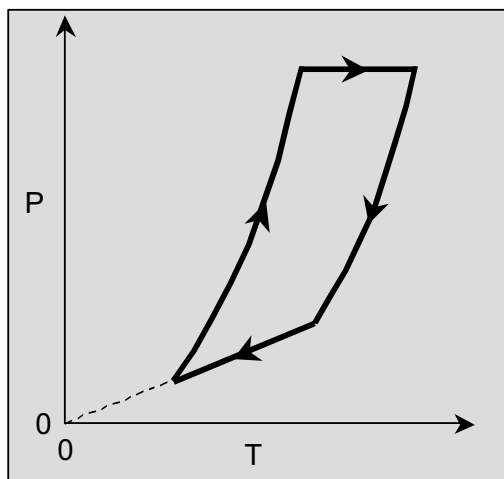

Figure 3: The Diesel cycle

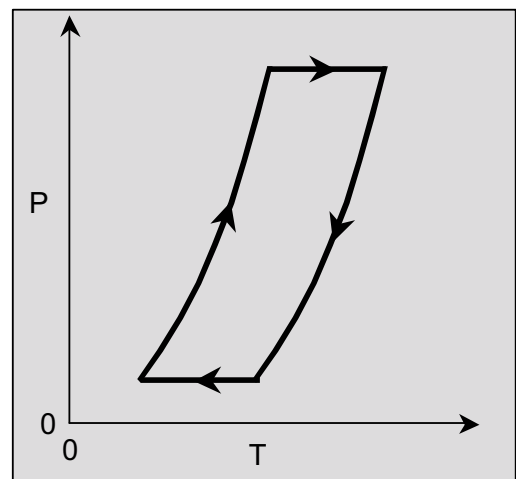

Figure 4: The Brayton cycle

**8.23** This is a challenging and open-ended problem for which we offer no solution. Problem 8.21 may offer some insight.

## Chapter 9 - Section B - Non-Numerical Solutions

**9.1** Since the object of doing work  $|W|$  on a heat pump is to transfer heat  $|Q_H|$  to a heat sink, then:

$$\begin{aligned} \text{What you get} &= |Q_H| \\ \text{What you pay for} &= |W| \\ \text{Whence } \nu &< \frac{|Q_H|}{|W|} \end{aligned}$$

For a Carnot heat pump,

$$\nu = \frac{|Q_H|}{|Q_H| - |Q_C|} = \frac{T_H}{T_H - T_C}$$

**9.3** Because the temperature of the finite cold reservoir (contents of the refrigerator) is a variable, use differential forms of Carnot's equations, Eqs. (5.7) and (5.8):

$$\frac{dQ_H}{dQ_C} = -\frac{T_H}{T_C} \quad \text{and} \quad dW = \left[ 1 - \frac{T_C}{T_H} \right] dQ_H$$

In these equations  $Q_C$  and  $Q_H$  refer to the *reservoirs*. With  $dQ_H = C^t dT_C$ , the first of Carnot's equations becomes:

$$dQ_H = -C^t T_H \frac{dT_C}{T_C}$$

Combine this equation with the second of Carnot's equations:

$$dW = -C^t T_H \frac{dT_C}{T_C} + C^t dT_C$$

Integration from  $T_C = T_H$  to  $T_C = T_C$  yields:

$$W = -C^t T_H \ln \frac{T_C}{T_H} + C^t (T_C - T_H) \quad \text{or} \quad \boxed{W = C^t T_H \left[ \ln \frac{T_H}{T_C} + \frac{T_C}{T_H} - 1 \right]}$$

**9.5** Differentiation of Eq. (9.3) yields:

$$\left[ \frac{\varepsilon \rho}{\varepsilon T_C} \right]_{T_H} = \frac{1}{T_H - T_C} + \frac{T_C}{(T_H - T_C)^2} = \frac{T_H}{(T_H - T_C)^2} \quad \text{and} \quad \left[ \frac{\varepsilon \rho}{\varepsilon T_H} \right]_{T_C} = -\frac{T_C}{(T_H - T_C)^2}$$

Because  $T_H > T_C$ , the more effective procedure is to increase  $T_C$ .

For a real refrigeration system, increasing  $T_C$  is hardly an option if refrigeration is required at a particular value of  $T_C$ . Decreasing  $T_H$  is no more realistic, because for all practical purposes,  $T_H$  is fixed by environmental conditions, and not subject to control.

**9.6** For a Carnot refrigerator,  $\rho$  is given by Eq. (9.3). Write this equation for the two cases:

$$\rho = \frac{T_C}{T_H - T_C} \quad \text{and} \quad \rho_\sigma = \frac{T_{\sigma C}}{T_{\sigma H} - T_{\sigma C}}$$

Because the directions of heat transfer require that  $T_H > T_{\sigma H}$  and  $T_C < T_{\sigma C}$ , a comparison shows that  $\rho < \rho_\sigma$  and therefore that  $\rho$  is the more conservative value.

**9.20** On average, the coefficient of performance will increase, thus providing savings on electric casts. On the other hand, installation casts would be higher. The proposed arrangement would result in cooling of the kitchen, as the refrigerator would act as an air conditioner. This would be detrimental in the winter, but beneficial in the summer, at least in temperate climates.

**9.21**

$$\Delta = 0.6 \Delta_{\text{Carnot}} = 0.6 \left( \frac{T_C}{T_H - T_C} \right)$$

If  $\Delta < 1$ , then  $T_C < T_H/1.6$ . For  $T_H = 300$  K, then  $T_C < 187.5$  K, which is most unlikely.

## Chapter 10 - Section B - Non-Numerical Solutions

**10.5** For a binary system, the next equation following Eq. (10.2) shows that  $P$  is linear in  $x_1$ . Thus no maximum or minimum can exist in this relation. Since such an extremum is required for the existence of an azeotrope, no azeotrope is possible.

**10.6 (a)** Because benzene and toluene are chemically similar and the pressure is only 1(atm), this system can be modeled by Raoult's law to a good approximation.

(b) Although  $n$ -hexane and  $n$ -heptane are chemically similar, a pressure of 25 bar is too high for modeling this system by Raoult's law.

(c) At 200 K, hydrogen is supercritical, and modeling the hydrogen/propane system at this temperature by Raoult's law is out of the question, because no value of  $P^{\text{sat}}$  for hydrogen is known.

(d) Because isooctane and  $n$ -octane are chemically similar and at a temperature (373.15 K) close to their normal boiling points, this system can be modeled by Raoult's law to a good approximation.

(e) Water and  $n$ -decane are much too dissimilar to be modeled by Raoult's law, and are in fact only slightly soluble in one another at 300 K.

**10.12** For a total volume  $V^t$  of an ideal gas,  $PV^t = nRT$ . Multiply both sides by  $y_i$ , the mole fraction of species  $i$  in the mixture:

$$y_i PV^t = n_i RT \quad \text{or} \quad p_i V^t = \frac{m_i}{\mathcal{M}_i} RT$$

where  $m_i$  is the mass of species  $i$ ,  $\mathcal{M}_i$  is its molar mass, and  $p_i$  is its partial pressure, defined as  $p_i \equiv y_i P$ . Solve for  $m_i$ :

$$m_i = \frac{\mathcal{M}_i p_i V^t}{RT}$$

Applied to moist air, considered a binary mixture of air and water vapor, this gives:

$$m_{\text{H}_2\text{O}} = \frac{\mathcal{M}_{\text{H}_2\text{O}} p_{\text{H}_2\text{O}} V^t}{RT} \quad \text{and} \quad m_{\text{air}} = \frac{\mathcal{M}_{\text{air}} p_{\text{air}} V^t}{RT}$$

(a) By definition,

$$h \equiv \frac{m_{\text{H}_2\text{O}}}{m_{\text{air}}} \quad \text{or} \quad h = \frac{\mathcal{M}_{\text{H}_2\text{O}}}{\mathcal{M}_{\text{air}}} \frac{p_{\text{H}_2\text{O}}}{p_{\text{air}}}$$

Since the partial pressures must sum to the total pressure,  $p_{\text{air}} = P - p_{\text{H}_2\text{O}}$ ; whence,

$$h = \frac{\mathcal{M}_{\text{H}_2\text{O}}}{\mathcal{M}_{\text{air}}} \frac{p_{\text{H}_2\text{O}}}{P - p_{\text{H}_2\text{O}}}$$

(b) If air is in equilibrium with liquid water, then the partial pressure of water vapor in the air equals the vapor pressure of the water, and the preceding equation becomes:

$$h^{\text{sat}} = \frac{\mathcal{M}_{\text{H}_2\text{O}}}{\mathcal{M}_{\text{air}}} \frac{P_{\text{H}_2\text{O}}^{\text{sat}}}{P - P_{\text{H}_2\text{O}}^{\text{sat}}}$$

(c) Percentage humidity and relative humidity are defined as follows:

$$h_{\text{pc}} \equiv \frac{h}{h^{\text{sat}}} = \frac{p_{\text{H}_2\text{O}}}{P_{\text{H}_2\text{O}}^{\text{sat}}} \frac{P - P_{\text{H}_2\text{O}}^{\text{sat}}}{P - p_{\text{H}_2\text{O}}} (100) \quad \text{and} \quad h_{\text{rel}} \equiv \frac{p_{\text{H}_2\text{O}}}{P_{\text{H}_2\text{O}}^{\text{sat}}} (100)$$

Combining these two definitions to eliminate  $p_{\text{H}_2\text{O}}$  gives:

$$h_{\text{pc}} = h_{\text{rel}} \frac{P - P_{\text{H}_2\text{O}}^{\text{sat}}}{P - P_{\text{H}_2\text{O}}^{\text{sat}} (h_{\text{rel}}/100)}$$

**10.14** Because the vapor space above the liquid phase is nearly pure gas, Eq. (10.4) becomes  $P = x_i \mathcal{H}_i$ . For the same mole fraction of gas dissolved in the liquid phase,  $P$  is then proportional to  $\mathcal{H}_i$ . Values given in Table 10.1 indicate that were air used rather than  $\text{CO}_2$ ,  $P$  would be about 44 times greater, much too high a pressure to be practical.

**10.15** Because Henry's constant for helium is very high, very little of this gas dissolves in the blood streams of divers at approximately atmospheric pressure.

**10.21** By Eq. (10.5) and the given equations for  $\ln \gamma_1$  and  $\ln \gamma_2$ ,

$$y_1 P = x_1 \exp(Ax_2^2) P_1^{\text{sat}} \quad \text{and} \quad y_2 P = x_2 \exp(Ax_1^2) P_2^{\text{sat}}$$

These equations sum to give:

$$P = x_1 \exp(Ax_2^2) P_1^{\text{sat}} + x_2 \exp(Ax_1^2) P_2^{\text{sat}}$$

Dividing the equation for  $y_1 P$  by the preceding equation yields:

$$y_1 = \frac{x_1 \exp(Ax_2^2) P_1^{\text{sat}}}{x_1 \exp(Ax_2^2) P_1^{\text{sat}} + x_2 \exp(Ax_1^2) P_2^{\text{sat}}}$$

For  $x_1 = x_2$  this equation obviously reduces to:

$$P = \frac{P_1^{\text{sat}}}{P_1^{\text{sat}} + P_2^{\text{sat}}}$$

**10.23** A little reflection should convince anyone that there is no other way that BOTH the liquid-phase and vapor-phase mole fractions can sum to unity.

**10.24** By the definition of a  $K$ -value,  $y_1 = K_1 x_1$  and  $y_2 = K_2 x_2$ . Moreover,  $y_1 + y_2 = 1$ . These equations combine to yield:

$$K_1 x_1 + K_2 x_2 = 1 \quad \text{or} \quad K_1 x_1 + K_2 (1 - x_1) = 1$$

Solve for  $x_1$ :

$$x_1 = \frac{1 - K_2}{K_1 - K_2}$$

Substitute for  $x_1$  in the equation  $y_1 = K_1 x_1$ :

$$y_1 = \frac{K_1 (1 - K_2)}{K_1 - K_2}$$

Note that when two phases exist both  $x_1$  and  $y_1$  are independent of  $z_1$ .

By a material balance on the basis of 1 mole of feed,

$$x_1\mathcal{L} + y_1\mathcal{V} = z_1 \quad \text{or} \quad x_1(1 - \mathcal{V}) + y_1\mathcal{V} = z_1$$

Substitute for both  $x_1$  and  $y_1$  by the equations derived above:

$$\frac{1 - K_2}{K_1 - K_2}(1 - \mathcal{V}) + \frac{K_1(1 - K_2)}{K_1 - K_2}\mathcal{V} = z_1$$

Solve this equation for  $\mathcal{V}$ :

$$\mathcal{V} = \frac{z_1(K_1 - K_2) - (1 - K_2)}{(K_1 - 1)(1 - K_2)}$$

Note that the relative amounts of liquid and vapor phases *do* depend on  $z_1$ .

**10.35** Molality  $\equiv \mathcal{M}_i = \frac{n_i}{m_s} = \frac{x_i}{x_s M_s}$

where subscript  $s$  denotes the solvent and  $M_s$  is the molar mass of the solvent. The given equation may therefore be written:

$$\frac{x_i}{x_s M_s} = k_i y_i P \quad \text{or} \quad x_i \left( \frac{1}{x_s M_s k_i} \right) = y_i P$$

Comparison with Eq. (10.4) shows that

$$\mathcal{H}_i = \frac{1}{x_s M_s k_i} \quad \text{or for } x_i \rightarrow 0 \quad \mathcal{H}_i = \frac{1}{M_s k_i}$$

For water,  $M_s = 18.015 \text{ g mol}^{-1}$  or  $0.018015 \text{ kg mol}^{-1}$ .

Thus, 
$$\mathcal{H}_i = \frac{1}{(0.018015)(0.034)} = 1633 \text{ bar}$$

This is in comparison with the value of 1670 bar in Table 10.1.

## Chapter 11 - Section B - Non-Numerical Solutions

11.6 Apply Eq. (11.7):

$$\bar{T}_i \left( \left[ \frac{v(nT)}{vn_i} \right]_{P,T,n_j} = T \right) \frac{vn}{vn_i} = T \quad \bar{P}_i \left( \left[ \frac{v(nP)}{vn_i} \right]_{P,T,n_j} = P \right) \frac{vn}{vn_i} = P$$

11.7 (a) Let  $m$  be the mass of the solution, and define the partial molar mass by:  $\bar{m}_i \left( \left[ \frac{vm}{vn_i} \right]_{T,P,n_j} \right)$

Let  $\mathcal{M}_k$  be the molar mass of species  $k$ . Then

$$m = \sum_k n_k \mathcal{M}_k = n_i \mathcal{M}_i + \sum_{j \neq i} n_j \mathcal{M}_j \quad (j \neq i)$$

and  $\left( \left[ \frac{vm}{vn_i} \right]_{T,P,n_j} = \left[ \frac{v(n_i \mathcal{M}_i)}{vn_i} \right]_{T,P,n_j} = \mathcal{M}_i \right)$  Whence,  $\boxed{\bar{m}_i = \mathcal{M}_i}$

(b) Define a partial *specific* property as:  $\tilde{M}_i \left( \left[ \frac{vM^t}{vm_i} \right]_{T,P,m_j} = \left[ \frac{vM^t}{vn_i} \right]_{T,P,m_j} \right) \frac{vn_i}{vm_i}$

If  $\mathcal{M}_i$  is the molar mass of species  $i$ ,  $n_i = \frac{m_i}{\mathcal{M}_i}$  and  $\left( \left[ \frac{vn_i}{vm_i} \right]_{T,P,m_j} = \frac{1}{\mathcal{M}_i} \right)$

Because constant  $m_j$  implies constant  $n_j$ , the initial equation may be written:

$$\boxed{\tilde{M}_i = \frac{\bar{M}_i}{\mathcal{M}_i}}$$

11.8 By Eqs. (10.15) and (10.16),  $\bar{V}_1 = V + x_2 \frac{dV}{dx_1}$  and  $\bar{V}_2 = V - x_1 \frac{dV}{dx_1}$

Because  $V = \rho^{-1}$  then  $\frac{dV}{dx_1} = \frac{-1}{\rho^2} \frac{d\rho}{dx_1}$  whence

$$\bar{V}_1 = \frac{1}{\rho} - \frac{x_2}{\rho^2} \frac{d\rho}{dx_1} = \frac{1}{\rho} \left[ 1 - \frac{x_2}{\rho} \frac{d\rho}{dx_1} \right] = \frac{1}{\rho^2} \left[ \rho - x_2 \frac{d\rho}{dx_1} \right]$$

$$\bar{V}_2 = \frac{1}{\rho} + \frac{x_1}{\rho^2} \frac{d\rho}{dx_1} = \frac{1}{\rho} \left[ 1 + \frac{x_1}{\rho} \frac{d\rho}{dx_1} \right] = \frac{1}{\rho^2} \left[ \rho + x_1 \frac{d\rho}{dx_1} \right]$$

With  $\rho = a_0 + a_1 x_1 + a_2 x_1^2$  and  $\frac{d\rho}{dx_1} = a_1 + 2a_2 x_1$  these become:

$$\boxed{\bar{V}_1 = \frac{1}{\rho^2} [a_0 - a_1 + 2(a_1 - a_2)x_1 + 3a_2 x_1^2]} \quad \text{and} \quad \boxed{\bar{V}_2 = \frac{1}{\rho^2} (a_0 + 2a_1 x_1 + 3a_2 x_1^2)}$$

**11.9** For application of Eq. (11.7) all mole fractions must be eliminated from the given equation by the relation  $x_i = n_i/n$ :

$$nM = n_1M_1 + n_2M_2 + n_3M_3 + \frac{n_1n_2n_3}{n^2}C$$

For  $\bar{M}_1$ , 
$$\left[ \frac{\partial(nM)}{\partial n_1} \right]_{T,P,n_2,n_3} = M_1 + n_2n_3C \left[ \frac{1}{n^2} - \frac{2n_1}{n^3} \left( \frac{\partial n}{\partial n_1} \right)_{T,P,n_2,n_3} \right]$$

Because  $n = n_1 + n_2 + n_3$ , 
$$\left( \frac{\partial n}{\partial n_1} \right)_{T,P,n_2,n_3} = 1$$

Whence, 
$$\bar{M}_1 = M_1 + \frac{n_2n_3}{n^2} \left[ 1 - 2\frac{n_1}{n} \right] C \quad \text{and} \quad \boxed{\bar{M}_1 = M_1 + x_2x_3[1 - 2x_1]C}$$

Similarly, 
$$\boxed{\bar{M}_2 = M_2 + x_1x_3[1 - 2x_2]C} \quad \text{and} \quad \boxed{\bar{M}_3 = M_3 + x_1x_2[1 - 2x_3]C}$$

One can readily show that application of Eq. (11.11) regenerates the original equation for  $M$ . The infinite dilution values are given by:

$$\boxed{\bar{M}_i^\infty = M_i + x_jx_kC \quad (j, k \neq i)}$$

Here  $x_j$  and  $x_k$  are mole fractions on an  $i$ -free basis.

**11.10** With the given equation and the Dalton's-law requirement that  $P = \sum_i p_i$ , then:

$$P = \frac{RT}{V} \sum_i y_i Z_i$$

For the mixture,  $P = ZRT/V$ . These two equations combine to give  $Z = \sum_i y_i Z_i$ .

**11.11** The general principle is simple enough:

*Given equations that represent partial properties  $\bar{M}_i$ ,  $\bar{M}_i^R$ , or  $\bar{M}_i^E$  as functions of composition, one may combine them by the summability relation to yield a mixture property. Application of the defining (or equivalent) equations for partial properties then regenerates the given equations if and only if the given equations obey the Gibbs/Duhem equation.*

**11.12** (a) Multiply Eq. (A) of Ex. 11.4 by  $n$  ( $= n_1 + n_2$ ) and eliminate  $x_1$  by  $x_1 = n_1/(n_1 + n_2)$ :

$$nH = 600(n_1 + n_2) - 180n_1 - 20\frac{n_1^3}{(n_1 + n_2)^2}$$

Form the partial derivative of  $nH$  with respect to  $n_1$  at constant  $n_2$ :

$$\bar{H}_1 = 600 - 180 - 20 \left[ \frac{3n_1^2}{(n_1 + n_2)^2} - \frac{2n_1^3}{(n_1 + n_2)^3} \right] = 420 - 60\frac{n_1^2}{(n_1 + n_2)^2} + 40\frac{n_1^3}{(n_1 + n_2)^3}$$

Whence,

$$\boxed{\bar{H}_1 = 420 - 60x_1^2 + 40x_1^3}$$

Form the partial derivative of  $nH$  with respect to  $n_2$  at constant  $n_1$ :

$$\bar{H}_2 = 600 + 20\frac{2n_1^3}{(n_1 + n_2)^3} \quad \text{or} \quad \boxed{\bar{H}_2 = 600 + 40x_1^3}$$



(b) In accord with Eq. (11.11),

$$H = x_1(420 - 60x_1^2 + 40x_1^3) + (1 - x_2)(600 + 40x_1^3)$$

Whence,

$$H = 600 - 180x_1 - 20x_1^3$$

(c) Write Eq. (11.14) for a binary system and divide by  $dx_1$ :  $x_1 \frac{d\bar{H}_1}{dx_1} + x_2 \frac{d\bar{H}_2}{dx_1} = 0$

Differentiate the boxed equations of part (a):

$$\frac{d\bar{H}_1}{dx_1} = -120x_1 + 120x_1^2 = -120x_1x_2 \quad \text{and} \quad \frac{d\bar{H}_2}{dx_1} = 120x_1^2$$

Multiply each derivative by the appropriate mole fraction and add:

$$-120x_1^2x_2 + 120x_1^2x_2 = 0$$

(d) Substitute  $x_1 = 1$  and  $x_2 = 0$  in the first derivative expression of part (c) and substitute  $x_1 = 0$  in the second derivative expression of part (c). The results are:

$$\left(\frac{d\bar{H}_1}{dx_1}\right)_{x_1=1} = \left(\frac{d\bar{H}_2}{dx_1}\right)_{x_1=0} = 0$$

(e)

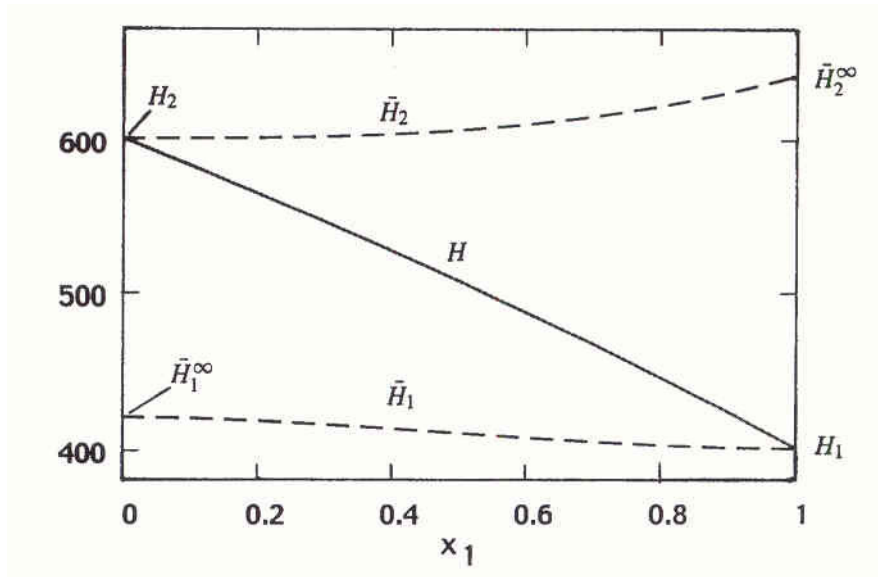

**11.13** (a) Substitute  $x_2 = 1 - x_1$  in the given equation for  $V$  and reduce:

$$V = 70 + 58x_1 - x_1^2 - 7x_1^3$$

Apply Eqs. (11.15) and (11.16) to find expressions for  $\bar{V}_1$  and  $\bar{V}_2$ . First,

$$\frac{dV}{dx_1} = 58 - 2x_1 - 21x_1^2$$

Then,

$$\bar{V}_1 = 128 - 2x_1 - 20x_1^2 + 14x_1^3$$

and

$$\bar{V}_2 = 70 + x_1^2 + 14x_1^3$$

(b) In accord with Eq. (11.11),

$$V = x_1(128 - 2x_1 - 20x_1^2 + 14x_1^3) + (1 - x_1)(70 + x_1^2 + 14x_1^3)$$

Whence,

$$V = 70 + 58x_1 - x_1^2 - 7x_1^3$$

which is the first equation developed in part (a).

(c) Write Eq. (11.14) for a binary system and divide by  $dx_1$ :  $x_1 \frac{d\bar{V}_1}{dx_1} + x_2 \frac{d\bar{V}_2}{dx_1} = 0$

Differentiate the the boxed equations of part (a):

$$\frac{d\bar{V}_1}{dx_1} = -2 - 40x_1 + 42x_1^2 \quad \text{and} \quad \frac{d\bar{V}_2}{dx_1} = 2x_1 + 42x_1^2$$

Multiply each derivative by the appropriate mole fraction and add:

$$x_1(-2 - 40x_1 + 42x_1^2) + (1 - x_1)(2x_1 + 42x_1^2) = 0$$

The validity of this equation is readily confirmed.

(d) Substitute  $x_1 = 1$  in the first derivative expression of part (c) and substitute  $x_1 = 0$  in the second derivative expression of part (c). The results are:

$$\left(\frac{d\bar{V}_1}{dx_1}\right)_{x_1=1} = \left(\frac{d\bar{V}_2}{dx_1}\right)_{x_1=0} = 0$$

(e)

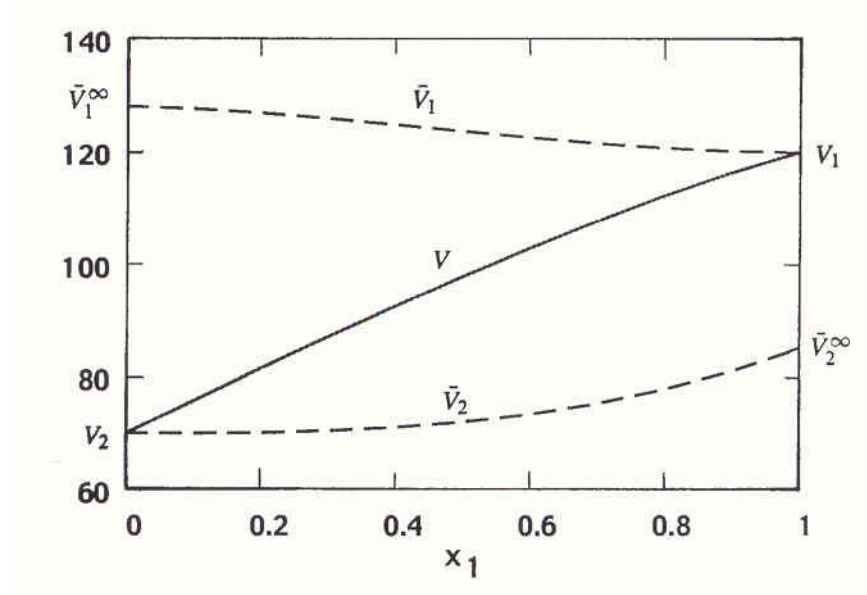

**11.14** By Eqs. (11.15) and (11.16):

$$\bar{H}_1 = H + x_2 \frac{dH}{dx_1} \quad \text{and} \quad \bar{H}_2 = H - x_1 \frac{dH}{dx_1}$$

Given that:  $H = x_1(a_1 + b_1x_1) + x_2(a_2 + b_2x_2)$

Then, after simplification,  $\frac{dH}{dx_1} = a_1 + 2b_1x_1 - (a_2 + 2b_2x_2)$

Combining these equations gives after reduction:

$$\bar{H}_1 = a_1 + b_1x_1 + x_2(x_1b_1 - x_2b_2) \quad \text{and} \quad \bar{H}_2 = a_2 + b_2x_2 - x_1(x_1b_1 - x_2b_2)$$

These clearly are not the same as the suggested expressions, which are therefore not correct. Note that application of the summability equation to the *derived* partial-property expressions reproduces the original equation for  $H$ . Note further that differentiation of these same expressions yields results that satisfy the Gibbs/Duhem equation, Eq. (11.14), written:

$$x_1 \frac{d\bar{H}_1}{dx_1} + x_2 \frac{d\bar{H}_2}{dx_1} = 0$$

The suggested expressions do not obey this equation, further evidence that they cannot be valid.

**11.15** Apply the following general equation of differential calculus:

$$\left(\frac{\partial x}{\partial y}\right)_z = \left(\frac{\partial x}{\partial y}\right)_w + \left(\frac{\partial x}{\partial w}\right)_y \left(\frac{\partial w}{\partial y}\right)_z$$

$$\left[\frac{\partial(nM)}{\partial n_i}\right]_{T,P,n_j} = \left[\frac{\partial(nM)}{\partial n_i}\right]_{T,V,n_j} + \left[\frac{\partial(nM)}{\partial V}\right]_{T,n} \left(\frac{\partial V}{\partial n_i}\right)_{T,P,n_j}$$

Whence,

$$\bar{M}_i = \tilde{M}_i + n \left(\frac{\partial M}{\partial V}\right)_{T,n} \left(\frac{\partial V}{\partial n_i}\right)_{T,P,n_j} \quad \text{or} \quad \tilde{M}_i = \bar{M}_i - n \left(\frac{\partial M}{\partial V}\right)_{T,n} \left(\frac{\partial V}{\partial n_i}\right)_{T,P,n_j}$$

By definition,

$$\bar{V}_i \equiv \left[\frac{\partial(nV)}{\partial n_i}\right]_{T,P,n_j} = n \left(\frac{\partial V}{\partial n_i}\right)_{T,P,n_j} + V \quad \text{or} \quad n \left(\frac{\partial V}{\partial n_i}\right)_{T,P,n_j} = \bar{V}_i - V$$

Therefore,

$$\tilde{M}_i = \bar{M}_i + (V - \bar{V}_i) \left(\frac{\partial M}{\partial V}\right)_{T,x}$$

**11.20** Equation (11.59) demonstrates that  $\ln \hat{\phi}_i$  is a partial property with respect to  $G^R/RT$ . Thus  $\ln \hat{\phi}_i = \bar{G}_i^R/RT$ . The partial-property analogs of Eqs. (11.57) and (11.58) are:

$$\left(\frac{\partial \ln \hat{\phi}_i}{\partial P}\right)_{T,x} = \frac{\bar{V}_i^R}{RT} \quad \text{and} \quad \left(\frac{\partial \ln \hat{\phi}_i}{\partial T}\right)_{P,x} = -\frac{\bar{H}_i^R}{RT^2}$$

The summability and Gibbs/Duhem equations take on the following forms:

$$\frac{G^R}{RT} = \sum_i x_i \ln \hat{\phi}_i \quad \text{and} \quad \sum_i x_i d \ln \hat{\phi}_i = 0 \quad (\text{const } T, P)$$

**11.26** For a pressure low enough that  $Z$  and  $\ln \phi$  are given approximately by Eqs. (3.38) and (11.36):

$$Z = 1 + \frac{BP}{RT} \quad \text{and} \quad \ln \phi = \frac{BP}{RT}$$

then:

$$\boxed{\ln \phi \approx Z - 1}$$

**11.28** (a) Because Eq. (11.96) shows that  $\ln \gamma_i$  is a partial property with respect to  $G^E/RT$ , Eqs. (11.15) and (11.16) may be written for  $M \equiv G^E/RT$ :

$$\ln \gamma_1 = \frac{G^E}{RT} + x_2 \frac{d(G^E/RT)}{dx_1} \quad \ln \gamma_2 = \frac{G^E}{RT} - x_1 \frac{d(G^E/RT)}{dx_1}$$

Substitute  $x_2 = 1 - x_1$  in the given equation for  $G^E/RT$  and reduce:

$$\frac{G^E}{RT} = -1.8x_1 + x_1^2 + 0.8x_1^3 \quad \text{whence} \quad \frac{d(G^E/RT)}{dx_1} = -1.8 + 2x_1 + 2.4x_1^2$$

Then,

$$\boxed{\ln \gamma_1 = -1.8 + 2x_1 + 1.4x_1^2 - 1.6x_1^3}$$

and

$$\boxed{\ln \gamma_2 = -x_1^2 - 1.6x_1^3}$$

(b) In accord with Eq. (11.11),

$$\frac{G^E}{RT} = x_1 \ln \gamma_1 + x_2 \ln \gamma_2 = x_1(-1.8 + 2x_1 + 1.4x_1^2 - 1.6x_1^3) + (1 - x_1)(-x_1^2 - 1.6x_1^3)$$

Whence,

$$\boxed{\frac{G^E}{RT} = -1.8x_1 + x_1^2 + 0.8x_1^3}$$

which is the first equation developed in part (a).

(c) Write Eq. (11.14) for a binary system with  $\bar{M}_i = \ln \gamma_i$  and divide by  $dx_1$ :

$$x_1 \frac{d \ln \gamma_1}{dx_1} + x_2 \frac{d \ln \gamma_2}{dx_1} = 0$$

Differentiate the boxed equations of part (a):

$$\frac{d \ln \gamma_1}{dx_1} = 2 + 2.8x_1 - 4.8x_1^2 \quad \text{and} \quad \frac{d \ln \gamma_2}{dx_1} = -2x_1 - 4.8x_1^2$$

Multiply each derivative by the appropriate mole fraction and add:

$$x_1(2 + 2.8x_1 - 4.8x_1^2) + (1 - x_1)(-2x_1 - 4.8x_1^2) = 0$$

The validity of this equation is readily confirmed.

(d) Substitute  $x_1 = 1$  in the first derivative expression of part (c) and substitute  $x_1 = 0$  in the second derivative expression of part (c). The results are:

$$\boxed{\left(\frac{d \ln \gamma_1}{dx_1}\right)_{x_1=1} = \left(\frac{d \ln \gamma_2}{dx_1}\right)_{x_1=0} = 0}$$

(e)

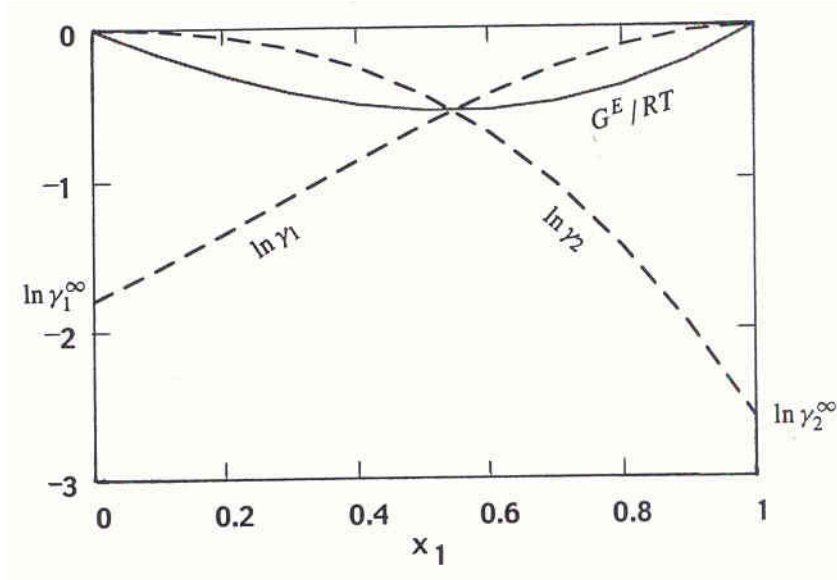

11.29 Combine definitions of the activity coefficient and the fugacity coefficients:

$$\gamma_i \equiv \frac{\hat{f}_i/x_i P}{f_i/P} \quad \text{or} \quad \boxed{\gamma_i = \frac{\hat{\phi}_i}{\phi_i}}$$

Note: See Eq. (14.54).

11.30 For  $C_p^E = \text{const.}$ , the following equations are readily developed from those given in the last column of Table 11.1 (page 415):

$$\Delta H^E = C_p^E \Delta T \quad \text{and} \quad \Delta S^E = -\Delta \left( \frac{\partial G^E}{\partial T} \right)_{P,x} = C_p^E \frac{\Delta T}{\langle T \rangle}$$

Working equations are then:

$$S_1^E = \frac{H_1^E - G_1^E}{T_1} \quad \text{and} \quad S_2^E = S_1^E + C_p^E \frac{\Delta T}{\langle T \rangle}$$

$$H_2^E = H_1^E + C_p^E \Delta T \quad \text{and} \quad G_2^E = H_2^E - T_2 S_2^E$$

For  $T_1 = 298.15$ ,  $T_2 = 328.15$ ,  $\langle T \rangle = 313.15$  and  $\Delta T = 30$ , results for all parts of the problem are given in the following table:

	$G_1^E$	$H_1^E$	$S_1^E$	$C_p^E$	I.			II. For $C_p^E = 0$		
					$S_2^E$	$H_2^E$	$G_2^E$	$S_2^E$	$H_2^E$	$G_2^E$
(a)	-622	-1920	-4.354	4.2	-3.951	-1794	-497.4	-4.354	-1920	-491.4
(b)	1095	1595	1.677	3.3	1.993	1694	1039.9	1.677	1595	1044.7
(c)	407	984	1.935	-2.7	1.677	903	352.8	1.935	984	348.9
(d)	632	-208	-2.817	23.0	-0.614	482	683.5	-2.817	-208	716.5
(e)	1445	605	-2.817	11.0	-1.764	935	1513.7	-2.817	605	1529.5
(f)	734	-416	-3.857	11.0	-2.803	-86	833.9	-3.857	-416	849.7
(g)	759	1465	2.368	-8.0	1.602	1225	699.5	2.368	1465	688.0

**11.31** (a) Multiply the given equation by  $n$  ( $= n_1 + n_2$ ), and convert remaining mole fractions to ratios of mole numbers:

$$\frac{nG^E}{RT} = A_{12} \frac{n_1 n_2}{n} + A_{13} \frac{n_1 n_3}{n} + A_{23} \frac{n_2 n_3}{n}$$

Differentiation with respect to  $n_1$  in accord with Eq. (11.96) yields  $[(\partial n/\partial n_1)_{n_2, n_3} = 1]$ :

$$\begin{aligned} \ln \gamma_1 &= A_{12} n_2 \left( \frac{1}{n} - \frac{n_1}{n^2} \right) + A_{13} n_3 \left( \frac{1}{n} - \frac{n_1}{n^2} \right) - A_{23} \frac{n_2 n_3}{n^2} \\ &= A_{12} x_2 (1 - x_1) + A_{13} x_3 (1 - x_1) - A_{23} x_2 x_3 \end{aligned}$$

Similarly,

$$\begin{aligned} \ln \gamma_2 &= A_{12} x_1 (1 - x_2) - A_{13} x_1 x_3 + A_{23} x_3 (1 - x_2) \\ \ln \gamma_3 &= -A_{12} x_1 x_2 + A_{13} x_1 (1 - x_3) + A_{23} x_2 (1 - x_3) \end{aligned}$$

(b) Each  $\ln \gamma_i$  is multiplied by  $x_i$ , and the terms are summed. Consider the first terms on the right of each expression for  $\ln \gamma_i$ . Multiplying each of these terms by the appropriate  $x_i$  and adding gives:

$$\begin{aligned} A_{12}(x_1 x_2 - x_1^2 x_2 + x_2 x_1 - x_2^2 x_1 - x_1 x_2 x_3) &= A_{12} x_1 x_2 (1 - x_1 + 1 - x_2 - x_3) \\ &= A_{12} x_1 x_2 [2 - (x_1 + x_2 + x_3)] = A_{12} x_1 x_2 \end{aligned}$$

An analogous result is obtained for the second and third terms on the right, and adding them yields the given equation for  $G^E/RT$ .

(c) For infinite dilution of species 1,  $x_1 = 0$ :  $\ln \gamma_1(x_1 = 0) = A_{12} x_2 + A_{13} x_3 - A_{23} x_2 x_3$   
 For pure species 1,  $x_1 = 1$ :  $\ln \gamma_1(x_1 = 1) = 0$   
 For infinite dilution of species 2,  $x_2 = 0$ :  $\ln \gamma_1(x_2 = 0) = A_{13} x_3^2$   
 For infinite dilution of species 3,  $x_3 = 0$ :  $\ln \gamma_1(x_3 = 0) = A_{12} x_2^2$

**11.35** By Eq. (11.87), written with  $M \equiv G$  and with  $x$  replaced by  $y$ :  $G^E = G^R - \sum_i y_i G_i^R$

Equations (11.33) and (11.36) together give  $G_i^R = B_{ii} P$ . Then for a binary mixture:

$$G^E = B P - y_1 B_{11} P - y_2 B_{22} P \quad \text{or} \quad G^E = P(B - y_1 B_{11} - y_2 B_{22})$$

Combine this equation with the last equation on Pg. 402:

$$G^E = \delta_{12} P y_1 y_2$$

From the last column of Table 11.1 (page 415):  $S^E = - \left( \frac{\partial G^E}{\partial T} \right)_{P, x}$

Because  $\delta_{12}$  is a function of  $T$  only:  $S^E = - \frac{d\delta_{12}}{dT} P y_1 y_2$

By the definition of  $G^E$ ,  $H^E = G^E + T S^E$ ; whence,  $H^E = \left( \delta_{12} - T \frac{d\delta_{12}}{dT} \right) P y_1 y_2$

Again from the last column of Table 11.1:  $C_P^E = \left( \frac{\partial H^E}{\partial T} \right)_{P, x}$

This equation and the preceding one lead directly to:  $C_P^E = -T \frac{d^2 \delta_{12}}{dT^2} P y_1 y_2$

**11.41** From Eq. (11.95):  $\left(\frac{\partial(G^E/RT)}{\partial T}\right)_P = \frac{-H^E}{RT^2}$  or  $\left(\frac{\partial(G^E/T)}{\partial T}\right)_P = \frac{-H^E}{T^2}$

To an excellent approximation, write:  $\left(\frac{\partial(G^E/T)}{\partial T}\right)_P \approx \frac{\Delta(G^E/T)}{\Delta T} \approx \frac{-H^E}{T_{\text{mean}}^2}$

From the given data:  $\frac{\Delta(G^E/T)}{\Delta T} = \frac{785/323 - 805/298}{323 - 298} = \frac{-0.271}{25} = -0.01084$

and  $\frac{-H^E}{T_{\text{mean}}^2} = \frac{-1060}{313^2} = -0.01082$

The data are evidently thermodynamically consistent.

**11.42** By Eq. (11.14), the Gibbs/Duhem equation,  $x_1 \frac{d\bar{M}_1}{dx_1} + x_2 \frac{d\bar{M}_2}{dx_1} = 0$

Given that  $\bar{M}_1 = M_1 + Ax_2$  and  $\bar{M}_2 = M_2 + Ax_1$  then  $\frac{d\bar{M}_1}{dx_1} = -A$  and  $\frac{d\bar{M}_2}{dx_1} = A$

Then  $x_1 \frac{d\bar{M}_1}{dx_1} + x_2 \frac{d\bar{M}_2}{dx_1} = -x_1A + x_2A = A(x_2 - x_1) \neq 0$

The given expressions cannot be correct.

**11.45** (a) For  $M^E = Ax_1^2x_2^2$  find  $\bar{M}_1^E = Ax_1x_2^2(2 - 3x_1)$  and  $\bar{M}_2^E = Ax_1^2x_2(2 - 3x_2)$

Note that at both  $x_1 = 0$  ( $x_2 = 1$ ) and  $x_1 = 1$  ( $x_2 = 0$ ),  $\bar{M}_1^E = \bar{M}_2^E = 0$

In particular,  $(\bar{M}_1^E)^\infty = (\bar{M}_2^E)^\infty = 0$

Although  $M^E$  has the same sign over the whole composition range, both  $\bar{M}_1^E$  and  $\bar{M}_2^E$  change sign, which is unusual behavior. Find also that

$$\frac{d\bar{M}_1^E}{dx_1} = 2Ax_2(1 - 6x_1x_2) \quad \text{and} \quad \frac{d\bar{M}_2^E}{dx_1} = -2Ax_1(1 - 6x_1x_2)$$

The two slopes are thus of opposite sign, as required; they also change sign, which is unusual.

For  $x_1 = 0$   $\frac{d\bar{M}_1^E}{dx_1} = 2A$  and  $\frac{d\bar{M}_2^E}{dx_1} = 0$

For  $x_1 = 1$   $\frac{d\bar{M}_1^E}{dx_1} = 0$  and  $\frac{d\bar{M}_2^E}{dx_1} = -2A$

(b) For  $M^E = A \sin(\pi x_1)$  find:

$$\bar{M}_1^E = A \sin(\pi x_1) + A\pi x_2 \cos(\pi x_1) \quad \text{and} \quad \bar{M}_2^E = A \sin(\pi x_1) - A\pi x_1 \cos(\pi x_1)$$

$$\frac{d\bar{M}_1^E}{dx_1} = -A\pi^2 x_2 \sin(\pi x_1) \quad \text{and} \quad \frac{d\bar{M}_2^E}{dx_1} = A\pi^2 x_1 \sin(\pi x_1)$$

The two slopes are thus of opposite sign, as required. But note the following, which is unusual:

For  $x_1 = 0$  and  $x_1 = 1$   $\frac{d\bar{M}_1^E}{dx_1} = 0$  and  $\frac{d\bar{M}_2^E}{dx_1} = 0$

PLOTS OF THE FUNCTIONS ARE SHOWN ON THE FOLLOWING PAGE.

Pb. 11.45 (a)

$$A := 10 \quad i := 0..100 \quad x_i := .00001 + .01 \cdot i$$

$$ME_i := A \cdot (x_i)^2 \cdot (1 - x_i)^2 \quad MEbar1_i := A \cdot x_i \cdot (1 - x_i)^2 (2 - 3 \cdot x_i)$$

$$MEbar2_i := A \cdot x_i \cdot x_i \cdot (1 - x_i) \cdot [2 - 3 \cdot (1 - x_i)]$$

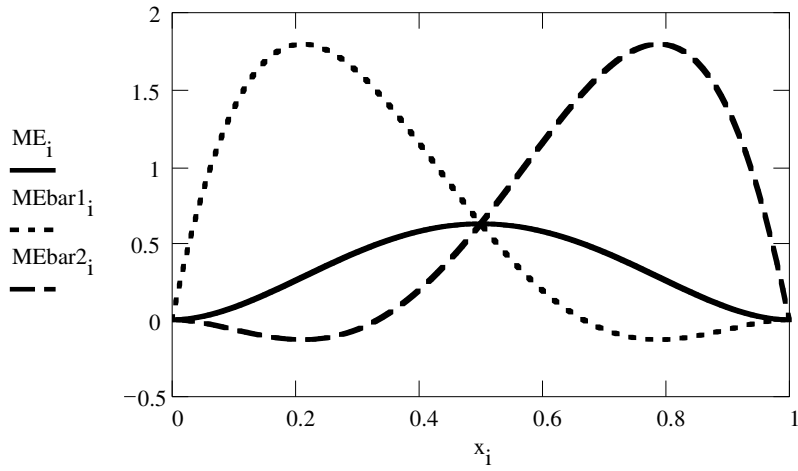

Pb. 11.45 (b)

$$ME_i := A \cdot \sin(\mathbf{p} \cdot x_i) \quad (\text{pi prints as bf p})$$

$$MEbar1_i := A \cdot \sin(\mathbf{p} \cdot x_i) + A \cdot \mathbf{p} \cdot (1 - x_i) \cdot \cos(\mathbf{p} \cdot x_i)$$

$$MEbar2_i := A \cdot \sin(\mathbf{p} \cdot x_i) - A \cdot \mathbf{p} \cdot (x_i) \cdot \cos(\mathbf{p} \cdot x_i)$$

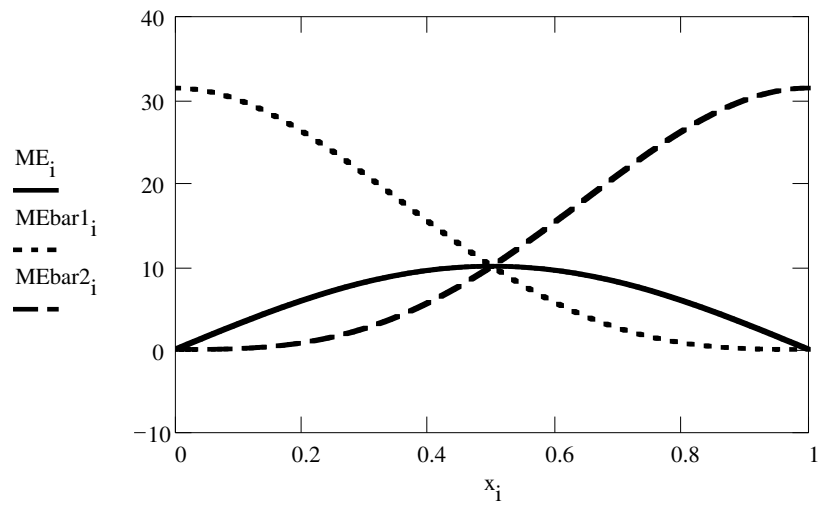



**11.46** By Eq. (11.7), 
$$\bar{M}_i = \left[ \frac{\partial(nM)}{\partial n_i} \right]_{T,P,n_j} = M + n \left( \frac{\partial M}{\partial n_i} \right)_{T,P,n_j}$$

At constant  $T$  and  $P$ , 
$$dM = \sum_k \left( \frac{\partial M}{\partial x_k} \right)_{T,P,x_j} dx_k$$

Divide by  $dn_i$  with restriction to constant  $n_j$  ( $j \neq i$ ):

$$\left( \frac{\partial M}{\partial n_i} \right)_{T,P,n_j} = \sum_k \left( \frac{\partial M}{\partial x_k} \right)_{T,P,x_j} \left( \frac{\partial x_k}{\partial n_i} \right)_{n_j}$$

With  $x_k = \frac{n_k}{n}$  
$$\left( \frac{\partial x_k}{\partial n_i} \right)_{n_j} = \begin{cases} -\frac{n_k}{n^2} & (k \neq i) \\ \frac{1}{n} - \frac{n_i}{n^2} & (k = i) \end{cases}$$

$$\begin{aligned} \left( \frac{\partial M}{\partial n_i} \right)_{T,P,n_j} &= -\frac{1}{n} \sum_{k \neq i} x_k \left( \frac{\partial M}{\partial x_k} \right)_{T,P,x_j} + \frac{1}{n} (1 - x_i) \left( \frac{\partial M}{\partial x_i} \right)_{T,P,x_j} \\ &= \frac{1}{n} \left( \frac{\partial M}{\partial x_i} \right)_{T,P,x_j} - \frac{1}{n} \sum_k x_k \left( \frac{\partial M}{\partial x_k} \right)_{T,P,x_j} \end{aligned}$$

$$\boxed{\bar{M}_i = M + \left( \frac{\partial M}{\partial x_i} \right)_{T,P,x_j} - \sum_k x_k \left( \frac{\partial M}{\partial x_k} \right)_{T,P,x_j}}$$

For species 1 of a binary mixture (all derivatives at constant  $T$  and  $P$ ):

$$\bar{M}_1 = M + \left( \frac{\partial M}{\partial x_1} \right)_{x_2} - x_1 \left( \frac{\partial M}{\partial x_1} \right)_{x_2} - x_2 \left( \frac{\partial M}{\partial x_2} \right)_{x_1} = M + x_2 \left[ \left( \frac{\partial M}{\partial x_1} \right)_{x_2} - \left( \frac{\partial M}{\partial x_2} \right)_{x_1} \right]$$

Because  $x_1 + x_2 = 1$ , the partial derivatives in this equation are physically unrealistic; however, they do have mathematical significance. Because  $M = \mathcal{M}(x_1, x_2)$ , we can quite properly write:

$$dM = \left( \frac{\partial M}{\partial x_1} \right)_{x_2} dx_1 + \left( \frac{\partial M}{\partial x_2} \right)_{x_1} dx_2$$

Division by  $dx_1$  yields:

$$\frac{dM}{dx_1} = \left( \frac{\partial M}{\partial x_1} \right)_{x_2} + \left( \frac{\partial M}{\partial x_2} \right)_{x_1} \frac{dx_2}{dx_1} = \left( \frac{\partial M}{\partial x_1} \right)_{x_2} - \left( \frac{\partial M}{\partial x_2} \right)_{x_1}$$

wherein the physical constraint on the mole fractions is recognized. Therefore

$$\boxed{\bar{M}_1 = M + x_2 \frac{dM}{dx_1}}$$

The expression for  $\bar{M}_2$  is found similarly.

**11.47** (a) Apply Eq. (11.7) to species 1:  $\bar{M}_1^E = \left[ \frac{\partial(nM^E)}{\partial n_1} \right]_{n_2}$

Multiply the given equation by  $n$  and eliminate the mole fractions in favor of mole numbers:

$$nM^E = An_1n_2 \left( \frac{1}{n_1 + Bn_2} + \frac{1}{n_2 + Bn_1} \right)$$

$$\bar{M}_1^E = An_2 \left\{ \left( \frac{1}{n_1 + Bn_2} + \frac{1}{n_2 + Bn_1} \right) + n_1 \left( \frac{-1}{(n_1 + Bn_2)^2} - \frac{B}{(n_2 + Bn_1)^2} \right) \right\}$$

Conversion back to mole fractions yields:

$$\bar{M}_1^E = Ax_2 \left\{ \left( \frac{1}{x_1 + Bx_2} + \frac{1}{x_2 + Bx_1} \right) - x_1 \left( \frac{1}{(x_1 + Bx_2)^2} + \frac{B}{(x_2 + Bx_1)^2} \right) \right\}$$

The first term in the first parentheses is combined with the first term in the second parentheses and the second terms are similarly combined:

$$\bar{M}_1^E = Ax_2 \left\{ \frac{1}{x_1 + Bx_2} \left( 1 - \frac{x_1}{x_1 + Bx_2} \right) + \frac{1}{x_2 + Bx_1} \left( 1 - \frac{Bx_1}{x_2 + Bx_1} \right) \right\}$$

Reduction yields:

$$\bar{M}_1^E = Ax_2^2 \left[ \frac{B}{(x_1 + Bx_2)^2} + \frac{1}{(x_2 + Bx_1)^2} \right]$$

Similarly,

$$\bar{M}_2^E = Ax_1^2 \left[ \frac{1}{(x_1 + Bx_2)^2} + \frac{B}{(x_2 + Bx_1)^2} \right]$$

(b) The excess partial properties should obey the Gibbs/Duhem equation, Eq. (11.14), when written for excess properties in a binary system at constant  $T$  and  $P$ :

$$x_1 \frac{d\bar{M}_1^E}{dx_1} + x_2 \frac{d\bar{M}_2^E}{dx_1} = 0$$

If the answers to part (a) are mathematically correct, this is inevitable, because they were derived from a proper expression for  $M^E$ . Furthermore, for each partial property  $\bar{M}_i^E$ , its value and derivative with respect to  $x_i$  become zero at  $x_i = 1$ .

(c)  $(\bar{M}_1^E)^\infty = A \left( \frac{1}{B} + 1 \right)$   $(\bar{M}_2^E)^\infty = A \left( 1 + \frac{1}{B} \right)$

**11.48** By Eqs. (11.15) and (11.16), written for excess properties, find:

$$\frac{d\bar{M}_1^E}{dx_1} = x_2 \frac{d^2M^E}{dx_1^2} \quad \frac{d\bar{M}_2^E}{dx_1} = -x_1 \frac{d^2M^E}{dx_1^2}$$

At  $x_1 = 1$ ,  $d\bar{M}_1^E/dx_1 = 0$ , and by continuity can only increase or decrease for  $x_1 < 1$ . Therefore the sign of  $d\bar{M}_1^E/dx_1$  is the same as the sign of  $d^2M^E/dx_1^2$ . Similarly, at  $x_1 = 0$ ,  $d\bar{M}_2^E/dx_1 = 0$ , and by the same argument the sign of  $d\bar{M}_2^E/dx_1$  is of opposite sign as the sign of  $d^2M^E/dx_1^2$ .

**11.49** The claim is *not* in general valid.

$$\beta \equiv \frac{1}{V} \left( \frac{\partial V}{\partial T} \right)_P \quad V^{id} = \sum_i x_i V_i$$
$$\beta^{id} = \frac{1}{\sum_i x_i V_i} \sum_i x_i \left( \frac{\partial V_i}{\partial T} \right)_P = \frac{1}{\sum_i x_i V_i} \sum_i x_i V_i \beta_i$$

The claim is valid only if all the  $V_i$  are *equal*.

## Chapter 12 - Section B - Non-Numerical Solutions

**12.2** Equation (12.1) may be written:  $y_i P = x_i \pi_i P_i^{\text{sat}}$ .

Summing for  $i = 1, 2$  gives:  $P = x_1 \pi_1 P_1^{\text{sat}} + x_2 \pi_2 P_2^{\text{sat}}$ .

Differentiate at constant  $T$ :  $\frac{dP}{dx_1} = P_1^{\text{sat}} \left[ x_1 \frac{d\pi_1}{dx_1} + \pi_1 \right] + P_2^{\text{sat}} \left[ x_2 \frac{d\pi_2}{dx_1} - \pi_2 \right]$

Apply this equation to the limiting conditions:

$$\text{For } x_1 = 0 : \quad x_2 = 1 \quad \pi_1 = \pi_1^\infty \quad \pi_2 = 1 \quad \frac{d\pi_2}{dx_1} = 0$$

$$\text{For } x_1 = 1 : \quad x_2 = 0 \quad \pi_1 = 1 \quad \pi_2 = \pi_2^\infty \quad \frac{d\pi_1}{dx_1} = 0$$

Then,

$$\begin{aligned} \left[ \frac{dP}{dx_1} \right]_{x_1=0} &= P_1^{\text{sat}} \pi_1^\infty - P_2^{\text{sat}} & \text{or} & \quad \left[ \frac{dP}{dx_1} \right]_{x_1=0} + P_2^{\text{sat}} = P_1^{\text{sat}} \pi_1^\infty \\ \left[ \frac{dP}{dx_1} \right]_{x_1=1} &= P_1^{\text{sat}} - P_2^{\text{sat}} \pi_2^\infty & \text{or} & \quad \left[ \frac{dP}{dx_1} \right]_{x_1=1} - P_1^{\text{sat}} = -P_2^{\text{sat}} \pi_2^\infty \end{aligned}$$

Since both  $P_i^{\text{sat}}$  and  $\pi_i^\infty$  are always positive definite, it follows that:

$$\left[ \frac{dP}{dx_1} \right]_{x_1=0} < -P_2^{\text{sat}} \quad \text{and} \quad \left[ \frac{dP}{dx_1} \right]_{x_1=1} > P_1^{\text{sat}}$$

**12.4** By Eqs. (12.15),  $\ln \pi_1 = Ax_2^2$  and  $\ln \pi_2 = Ax_1^2$

Therefore,  $\ln \frac{\pi_1}{\pi_2} = A(x_2^2 - x_1^2) = A(x_2 - x_1) = A(1 - 2x_1)$

By Eq. (12.1),  $\frac{\pi_1}{\pi_2} = \frac{y_1 x_2 P_2^{\text{sat}}}{y_2 x_1 P_1^{\text{sat}}} = \left[ \frac{y_1/x_1}{y_2/x_2} \right] \left[ \frac{P_2^{\text{sat}}}{P_1^{\text{sat}}} \right] = \xi_{12} r$

Whence,  $\ln(\xi_{12} r) = A(1 - 2x_1)$

If an azeotrope exists,  $\xi_{12} = 1$  at  $0 < x_1^{\text{az}} < 1$ . At this value of  $x_1$ ,  $\ln r = A(1 - 2x_1^{\text{az}})$

The quantity  $A(1 - 2x_1)$  is linear in  $x_1$ , and there are two possible relationships, depending on the sign of  $A$ . An azeotrope exists whenever  $|A| > |\ln r|$ . NO azeotrope can exist when  $|A| < |\ln r|$ .

**12.5** Perhaps the easiest way to proceed here is to note that an extremum in  $\ln \pi_1$  is accompanied by the opposite extremum in  $\ln \pi_2$ . Thus the difference  $\ln \pi_1 - \ln \pi_2$  is also an extremum, and Eq. (12.8) becomes useful:

$$\ln \pi_1 - \ln \pi_2 = \ln \frac{\pi_1}{\pi_2} = \frac{d(G^E/RT)}{dx_1}$$

Thus, given an expression for  $G^E/RT = g(x_1)$ , we locate an extremum through:

$$\frac{d^2(G^E/RT)}{dx_1^2} = \frac{d \ln(\pi_1/\pi_2)}{dx_1} = 0$$

**For the van Laar equation**, write Eq. (12.16), omitting the primes ( $\prime$ ):

$$\frac{G^E}{RT} = A_{12}A_{21}\frac{x_1x_2}{A} \quad \text{where} \quad A \equiv A_{12}x_1 + A_{21}x_2$$

Moreover, 
$$\frac{dA}{dx_1} = A_{12} - A_{21} \quad \text{and} \quad \frac{d^2A}{dx_1^2} = 0$$

Then, 
$$\frac{d(G^E/RT)}{dx_1} = A_{12}A_{21} \left[ \frac{x_2 - x_1}{A} - \frac{x_1x_2}{A^2} \frac{dA}{dx_1} \right]$$

$$\begin{aligned} \frac{d^2(G^E/RT)}{dx_1^2} &= A_{12}A_{21} \left[ -\frac{2}{A} - \frac{x_2 - x_1}{A^2} \frac{dA}{dx_1} - \frac{x_1x_2}{A^2} \frac{d^2A}{dx_1^2} - \frac{dA}{dx_1} \sum \frac{2x_1x_2}{A^3} \frac{dA}{dx_1} + \frac{x_2 - x_1}{A^2} \int \right] \\ &= A_{12}A_{21} \left[ -\frac{2}{A} - \frac{2(x_2 - x_1)}{A^2} \frac{dA}{dx_1} + \frac{2x_1x_2}{A^3} \int \frac{dA}{dx_1} \right] \\ &= \frac{2A_{12}A_{21}}{A^3} \left[ -A^2 - (x_2 - x_1)A \frac{dA}{dx_1} + x_1x_2 \int \frac{dA}{dx_1} \right] \\ &= \frac{2A_{12}A_{21}}{A^3} \left[ \sum A + x_2 \frac{dA}{dx_1} \int \sum x_1 \frac{dA}{dx_1} - A \int \right] \end{aligned}$$

This equation has a zero value if either  $A_{12}$  or  $A_{21}$  is zero. However, this makes  $G^E/RT$  everywhere zero, and no extremum is possible. If either quantity in parentheses is zero, substitution for  $A$  and  $dA/dx_1$  reduces the expression to  $A_{12} = 0$  or  $A_{21} = 0$ , again making  $G^E/RT$  everywhere zero. We conclude that no values of the parameters exist that provide for an extremum in  $\ln(\gamma_1/\gamma_2)$ .

**The Margules equation** is given by Eq. (12.9b), here written:

$$\frac{G^E}{RT} = Ax_1x_2 \quad \text{where} \quad A = A_{21}x_1 + A_{12}x_2 \quad \frac{dA}{dx_1} = A_{21} - A_{12} \quad \frac{d^2A}{dx_1^2} = 0$$

Then, 
$$\frac{d(G^E/RT)}{dx_1} = A(x_2 - x_1) + x_1x_2 \frac{dA}{dx_1}$$

$$\begin{aligned} \frac{d^2(G^E/RT)}{dx_1^2} &= -2A + (x_2 - x_1) \frac{dA}{dx_1} + (x_2 - x_1) \frac{dA}{dx_1} + x_1x_2 \frac{d^2A}{dx_1^2} \\ &= -2A + 2(x_2 - x_1) \frac{dA}{dx_1} = 2 \left[ (x_1 - x_2) \frac{dA}{dx_1} - A \right] \end{aligned}$$

This equation has a zero value when the quantity in square brackets is zero. Then:

$$(x_2 - x_1) \frac{dA}{dx_1} - A = (x_2 - x_1)(A_{21} - A_{12}) - A_{21}x_1 - A_{12}x_2 = A_{21}x_2 + A_{12}x_1 - 2(A_{21}x_1 + A_{12}x_2) = 0$$

Substituting  $x_2 = 1 - x_1$  and solving for  $x_1$  yields:

$$x_1 = \frac{A_{21} - 2A_{12}}{3(A_{21} - A_{12})} \quad \text{or} \quad x_1 = \frac{(r - 2)}{3(r - 1)} \quad r \equiv \frac{A_{21}}{A_{12}}$$

When  $r = 2$ ,  $x_1 = 0$ , and the extrema in  $\ln \gamma_1$  and  $\ln \gamma_2$  occur at the left edge of a diagram such as those of Fig. 12.9. For values of  $r > 2$ , the extrema shift to the right, reaching a limiting value for  $r = \infty$  at  $x_1 = 1/3$ . For positive values of the parameters, in all of these cases  $A_{21} > A_{12}$ , and the intercepts of the  $\ln \gamma_2$  curves at  $x_1 = 1$  are larger than the intercepts of the  $\ln \gamma_1$  curves at  $x_1 = 0$ .

When  $r = 1/2$ ,  $x_1 = 1$ , and the extrema in  $\ln \gamma_1$  and  $\ln \gamma_2$  occur at the right edge of a diagram such as those of Fig. 12.9. For values of  $r < 1/2$ , the extrema shift to the left, reaching a limiting value for  $r = 0$  at  $x_1 = 2/3$ . For positive values of the parameters, in all of these cases  $A_{21} < A_{12}$ , and the intercepts of the  $\ln \gamma_1$  curves at  $x_1 = 0$  are larger than the intercepts of the  $\ln \gamma_2$  curves at  $x_1 = 1$ .

No extrema exist for values of  $r$  between  $1/2$  and  $2$ .

**12.7** Equations (11.15) and (11.16) here become:

$$\ln \gamma_1 = \frac{G^E}{RT} + x_2 \frac{d(G^E/RT)}{dx_1} \quad \text{and} \quad \ln \gamma_2 = \frac{G^E}{RT} - x_1 \frac{d(G^E/RT)}{dx_1}$$

(a) For simplicity of notation, omit the primes that appear on the parameters in Eqs. (12.16) and (12.17), and write Eq. (12.16) as:

$$\frac{G^E}{RT} = A_{12}A_{21} \frac{x_1x_2}{D} \quad \text{where} \quad D \equiv A_{12}x_1 + A_{21}x_2$$

Then, 
$$\frac{d(G^E/RT)}{dx_1} = A_{12}A_{21} \left[ \frac{x_2 - x_1}{D} - \frac{x_1x_2}{D^2}(A_{12} - A_{21}) \right]$$

and 
$$\begin{aligned} \ln \gamma_1 &= A_{12}A_{21} \left[ \frac{x_1x_2}{D} + x_2 \left( \frac{x_2 - x_1}{D} - \frac{x_1x_2}{D^2}(A_{12} - A_{21}) \right) \right] \\ &= \frac{A_{12}A_{21}}{D} \left[ x_1x_2 + x_2^2 - x_1x_2 - \frac{x_1x_2^2}{D}(A_{12} - A_{21}) \right] \\ &= \frac{A_{12}A_{21}x_2^2}{D^2} (D - A_{12}x_1 + A_{21}x_1) = \frac{A_{12}A_{21}x_2^2}{D^2} (A_{21}x_2 + A_{21}x_1) \\ &= \frac{A_{12}A_{21}^2x_2^2}{D^2} = A_{12} \left( \frac{A_{21}x_2}{D} \right)^2 = A_{12} \left( \frac{D}{A_{21}x_2} \right)^{-2} = A_{12} \left( \frac{A_{12}x_1 + A_{21}x_2}{A_{21}x_2} \right)^{-2} \end{aligned}$$

$$\boxed{\ln \gamma_1 = A_{12} \left( 1 + \frac{A_{12}x_1}{A_{21}x_2} \right)^{-2}}$$

The equation for  $\ln \gamma_2$  is derived in analogous fashion.

(b) With the understanding that  $T$  and  $P$  are constant, 
$$\ln \gamma_1 = \left[ \frac{\partial(nG^E/RT)}{\partial n_1} \right]_{n_2}$$

and Eq. (12.16) may be written:

$$\frac{nG^E}{RT} = \frac{A_{12}A_{21}n_1n_2}{nD} \quad \text{where} \quad nD = A_{12}n_1 + A_{21}n_2$$

Differentiation in accord with the first equation gives:

$$\begin{aligned}\ln \gamma_1 &= A_{12}A_{21}n_2 \left[ \frac{1}{nD} - \frac{n_1}{(nD)^2} \left( \frac{\partial(nD)}{\partial n_1} \right)_{n_2} \right] \\ \ln \gamma_1 &= \frac{A_{12}A_{21}n_2}{nD} \left[ 1 - \frac{n_1}{nD} A_{12} \right] = \frac{A_{12}A_{21}x_2}{D} \left( 1 - \frac{A_{12}x_1}{D} \right) \\ &= \frac{A_{12}A_{21}x_2}{D^2} (D - A_{12}x_1) = \frac{A_{12}A_{21}x_2}{D^2} A_{21}x_2 = \frac{A_{12}A_{21}^2 x_2^2}{D^2}\end{aligned}$$

The remainder of the derivation is the same as in Part (a).

**12.10** This behavior requires positive deviations from Raoult's law over part of the composition range and negative deviations over the remainder. Thus a plot of  $G^E$  vs.  $x_1$  starts and ends with  $G^E = 0$  at  $x_1 = 0$  and  $x_1 = 1$  and shows positive values over part of the composition range and negative values over the remainder, with an intermediate crossing of the  $x_1$  axis. Because these deviations are usually quite small, the vapor pressures  $P_1^{\text{sat}}$  and  $P_2^{\text{sat}}$  must not be too different, otherwise the dewpoint and bubblepoint curves cannot exhibit extrema.

**12.11** Assume the Margules equation, Eq. (12.9b), applies:

$$\frac{G^E}{RT} = x_1x_2(A_{21}x_1 + A_{12}x_2) \quad \text{and} \quad \frac{G^E}{RT}(\text{equimolar}) = \frac{1}{8}(A_{12} + A_{21})$$

But [see page 438, just below Eq. (12.10b)]:  $A_{12} = \ln \gamma_1^\infty$      $A_{21} = \ln \gamma_2^\infty$

$$\frac{G^E}{RT}(\text{equimolar}) = \frac{1}{8}(\ln \gamma_1^\infty + \ln \gamma_2^\infty) \quad \text{or} \quad \boxed{\frac{G^E}{RT}(\text{equimolar}) = \frac{1}{8} \ln(\gamma_1^\infty \gamma_2^\infty)}$$

**12.24** (a) By Eq. (12.6):

$$\begin{aligned}\frac{G^E}{RT} &= x_1 \ln \gamma_1 + x_2 \ln \gamma_2 \\ &= x_1x_2^2(0.273 + 0.096x_1) + x_2x_1^2(0.273 - 0.096x_2) \\ &= x_1x_2(0.273x_2 + 0.096x_1x_2 + 0.273x_1 - 0.096x_1x_2) \\ &= x_1x_2(0.273)(x_1 + x_2)\end{aligned}$$

$$\boxed{\frac{G^E}{RT} = 0.273 x_1x_2}$$

(b) The preceding equation is of the form from which Eqs. (12.15) are derived. From these,

$$\boxed{\ln \gamma_1 = 0.273 x_2^2}$$

and

$$\boxed{\ln \gamma_2 = 0.273 x_1^2}$$

(c) The equations of part (b) are not the reported expressions, which therefore cannot be correct. See Problem 11.11.

**12.25** Write Eq. (11.100) for a binary system, and divide through by  $dx_1$ :

$$x_1 \frac{d \ln \gamma_1}{dx_1} + x_2 \frac{d \ln \gamma_2}{dx_1} = 0 \quad \text{whence} \quad \frac{d \ln \gamma_2}{dx_1} = -\frac{x_1}{x_2} \frac{d \ln \gamma_1}{dx_1} = \frac{x_1}{x_2} \frac{d \ln \gamma_1}{dx_2}$$

Integrate, recalling that  $\ln \gamma_2 = 1$  for  $x_1 = 0$ :

$$\ln \gamma_2 = \ln(1) + \int_0^{x_1} \frac{x_1}{x_2} \frac{d \ln \gamma_1}{dx_2} dx_1 = \int_0^{x_1} \frac{x_1}{x_2} \frac{d \ln \gamma_1}{dx_2} dx_1$$

(a) For  $\ln \gamma_1 = Ax_2^2$ , 
$$\frac{d \ln \gamma_1}{dx_2} = 2Ax_2$$

Whence 
$$\ln \gamma_2 = 2A \int_0^{x_1} x_1 dx_1 \quad \text{or} \quad \boxed{\ln \gamma_2 = Ax_1^2}$$

By Eq. (12.6), 
$$\boxed{\frac{G^E}{RT} = Ax_1x_2}$$

(b) For  $\ln \gamma_1 = x_2^2(A + Bx_2)$ ,

$$\frac{d \ln \gamma_1}{dx_2} = 2x_2(A + Bx_2) + x_2^2B = 2Ax_2 + 3Bx_2^2 = 2Ax_2 + 3Bx_2(1 - x_1)$$

Whence 
$$\ln \gamma_2 = 2A \int_0^{x_1} x_1 dx_1 + 3B \int_0^{x_1} x_1 dx_1 - 3B \int_0^{x_1} x_1^2 dx_1$$

$$\ln \gamma_2 = Ax_1^2 + \frac{3B}{2}x_1^2 - Bx_1^3 \quad \text{or} \quad \boxed{\ln \gamma_2 = x_1^2 \left( A + \frac{3B}{2} - Bx_1 \right) = x_1^2 \left[ A + \frac{B}{2}(1 + 2x_2) \right]}$$

Apply Eq. (12.6): 
$$\frac{G^E}{RT} = x_1x_2^2(A + Bx_2) + x_2x_1^2 \left( A + \frac{3B}{2} - Bx_1 \right)$$

Algebraic reduction can lead to various forms of this equation; e.g.,

$$\boxed{\frac{G^E}{RT} = x_1x_2 \left[ A + \frac{B}{2}(1 + x_2) \right]}$$

(c) For  $\ln \gamma_1 = x_2^2(A + Bx_2 + Cx_2^2)$ ,

$$\begin{aligned} \frac{d \ln \gamma_1}{dx_2} &= 2x_2(A + Bx_2 + Cx_2^2) + x_2^2(B + 2Cx_2) = 2Ax_2 + 3Bx_2^2 + 4Cx_2^3 \\ &= 2Ax_2 + 3Bx_2(1 - x_1) + 4Cx_2(1 - x_1)^2 \end{aligned}$$

Whence 
$$\ln \gamma_2 = 2A \int_0^{x_1} x_1 dx_1 + 3B \int_0^{x_1} x_1(1 - x_1) dx_1 + 4C \int_0^{x_1} x_1(1 - x_1)^2 dx_1$$

or 
$$\ln \gamma_2 = (2A + 3B + 4C) \int_0^{x_1} x_1 dx_1 - (3B + 8C) \int_0^{x_1} x_1^2 dx_1 + 4C \int_0^{x_1} x_1^3 dx_1$$

$$\ln \gamma_2 = \left( \frac{2A + 3B + 4C}{2} \right) x_1^2 - \left( \frac{3B + 8C}{3} \right) x_1^3 + Cx_1^4$$

$$\boxed{\ln \gamma_2 = x_1^2 \left[ A + \frac{3B}{2} + 2C - \left( B + \frac{8C}{3} \right) x_1 + Cx_1^2 \right]}$$



or

$$\ln \gamma_2 = x_1^2 \left[ A + \frac{B}{2}(1 + 2x_2) + \frac{C}{3}(1 + 2x_2 + 3x_2^2) \right]$$

The result of application of Eq. (12.6) reduces to equations of various forms; e.g.:

$$\frac{G^E}{RT} = x_1 x_2 \left[ A + \frac{B}{2}(1 + x_2) + \frac{C}{3}(1 + x_2 + x_2^2) \right]$$

**12.40 (a)** As shown on page 458,  $x_1 = \frac{1}{1 + \tilde{n}}$  and  $\tilde{\Delta H} = \Delta H(1 + \tilde{n})$

Eliminating  $1 + \tilde{n}$  gives: 
$$\tilde{\Delta H} = \frac{\Delta H}{x_1} \tag{A}$$

Differentiation yields: 
$$\frac{d\tilde{\Delta H}}{d\tilde{n}} = \frac{1}{x_1} \frac{d\Delta H}{d\tilde{n}} - \frac{\Delta H}{x_1^2} \frac{dx_1}{d\tilde{n}} = \left( \frac{1}{x_1} \frac{d\Delta H}{dx_1} - \frac{\Delta H}{x_1^2} \right) \frac{dx_1}{d\tilde{n}}$$

where 
$$\frac{dx_1}{d\tilde{n}} = \frac{-1}{(1 + \tilde{n})^2} = -x_1^2$$

Whence, 
$$\frac{d\tilde{\Delta H}}{d\tilde{n}} = \Delta H - x_1 \frac{d\Delta H}{dx_1} = H^E - x_1 \frac{dH^E}{dx_1}$$

Comparison with Eq. (11.16) written with  $M \equiv H^E$ ,  $\tilde{H}_2^E = H^E - x_1 \frac{dH^E}{dx_1}$

shows that

$$\frac{d\tilde{\Delta H}}{d\tilde{n}} = \tilde{H}_2^E$$

(b) By geometry, with reference to the following figure, 
$$\frac{d\tilde{\Delta H}}{d\tilde{n}} = \frac{\tilde{\Delta H} - I}{\tilde{n}}$$

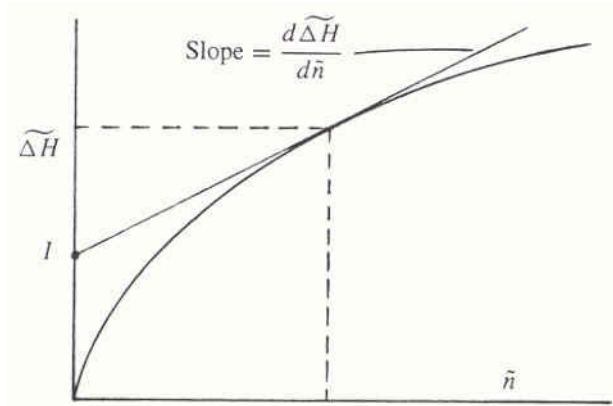

Combining this with the result of Part (a) gives: 
$$\tilde{H}_2^E = \frac{\tilde{\Delta H} - I}{\tilde{n}}$$

From which, 
$$I = \tilde{\Delta H} - \tilde{n} \tilde{H}_2^E$$

Substitute: 
$$\tilde{\Delta H} = \frac{\Delta H}{x_1} = \frac{H^E}{x_1} \quad \text{and} \quad \tilde{n} = \frac{x_2}{x_1}$$

Whence, 
$$I = \frac{H^E}{x_1} - \frac{x_2}{x_1} \bar{H}_2^E = \frac{H^E - x_2 \bar{H}_2^E}{x_1}$$

However, by the summability equation,  $H^E - x_2 \bar{H}_2^E = x_1 \bar{H}_1^E$

Then, 
$$I = \bar{H}_1^E$$

**12.41** Combine the given equation with Eq. (A) of the preceding problem:

$$\widetilde{\Delta H} = x_2(A_{21}x_1 + A_{12}x_2)$$

With  $x_2 = 1 - x_1$  and  $x_1 = 1/(1 + \tilde{n})$  (page 458):  $x_2 = \frac{\tilde{n}}{1 + \tilde{n}}$

The preceding equations combine to give:

$$\widetilde{\Delta H} = \frac{\tilde{n}}{1 + \tilde{n}} \left( \frac{A_{21}}{1 + \tilde{n}} + \frac{A_{12}\tilde{n}}{1 + \tilde{n}} \right)$$

(a) It follows immediately from the preceding equation that: 
$$\lim_{\tilde{n} \rightarrow 0} \widetilde{\Delta H} = 0$$

(b) Because  $\tilde{n}/(1 + \tilde{n}) \rightarrow 1$  for  $\tilde{n} \rightarrow \infty$ , it follows that: 
$$\lim_{\tilde{n} \rightarrow \infty} \widetilde{\Delta H} = A_{12}$$

(c) Analogous to Eq. (12.10b), page 438, we write:  $\bar{H}_2^E = x_1^2[A_{21} + 2(A_{12} - A_{21})x_2]$

Eliminate the mole fractions in favor of  $\tilde{n}$ :

$$\bar{H}_2^E = \left( \frac{1}{1 + \tilde{n}} \right)^2 \left[ A_{21} + 2(A_{12} - A_{21}) \frac{\tilde{n}}{1 + \tilde{n}} \right]$$

In the limit as  $\tilde{n} \rightarrow 0$ , this reduces to  $A_{21}$ . From the result of Part (a) of the preceding problem, it follows that

$$\lim_{\tilde{n} \rightarrow 0} \frac{d\widetilde{\Delta H}}{d\tilde{n}} = A_{21}$$

**12.42** By Eq. (12.29) with  $M \equiv H$ ,  $\Delta H = H - \sum_i x_i H_i$ . Differentiate:

$$\left( \frac{\partial \Delta H}{\partial t} \right)_{P,x} = \left( \frac{\partial H}{\partial t} \right)_{P,x} - \sum_i x_i \left( \frac{\partial H_i}{\partial t} \right)_{P,x}$$

With  $\left( \frac{\partial H}{\partial t} \right)_{P,x} \equiv C_P$ , this becomes  $\left( \frac{\partial \Delta H}{\partial t} \right)_{P,x} = C_P - \sum_i x_i C_{P_i} = \Delta C_P$

Therefore, 
$$\int_{\Delta H_0}^{\Delta H} d(\Delta H) = \int_{t_0}^t \Delta C_P dt$$
 
$$\Delta H = \Delta H_0 + \int_{t_0}^t \Delta C_P dt$$

**12.61** (a) From the definition of  $\mathcal{M}$ : 
$$M^E = x_1 x_2 \mathcal{M} \quad (A)$$

Differentiate: 
$$\frac{dM^E}{dx_1} = \mathcal{M}(x_2 - x_1) + x_1 x_2 \frac{d\mathcal{M}}{dx_1} \quad (B)$$

Substitution of Eqs. (A) & (B) into Eqs. (11.15) & (11.16), written for excess properties, yields the required result.

(b) The requested plots are found in Section A.

**12.63** In this application the microscopic “state” of a particle is its *species identity*, i.e., 1, 2, 3, . . . . By assumption, this label is the only thing distinguishing one particle from another. For mixing,

$$\Delta S^t = S^t_{\text{mixed}} - S^t_{\text{unmixed}} = S^t_{\text{mixed}} - \sum_i S^t_i$$

where the *total* entropies are given by Eq. (5.42). Thus, for an unmixed species  $i$ , and for the mixed system of particles,

$$S^t_i = k \ln \Omega_i = k \ln \frac{N_i!}{N_i!} = 0 \quad S^t_{\text{mixed}} = k \ln \frac{N!}{N_1! N_2! N_3! \dots}$$

Combining the last three equations gives: 
$$\Delta S^t = k \ln \frac{N!}{N_1! N_2! N_3! \dots}$$

From which: 
$$\frac{\Delta S}{R} = \frac{\Delta S^t}{R(N/N_A)} = \frac{\Delta S^t}{kN} = \frac{1}{N} \ln \frac{N!}{N_1! N_2! N_3! \dots} = \frac{1}{N} (\ln N! - \sum_i \ln N_i!)$$

$$\ln N! \approx N \ln N - N \quad \text{and} \quad \ln N_i! \approx N_i \ln N_i - N_i$$

$$\frac{\Delta S}{R} \approx \frac{1}{N} (N \ln N - N - \sum_i N_i \ln N_i + \sum_i N_i) = \frac{1}{N} (N \ln N - \sum_i x_i N \ln x_i N)$$

$$= \frac{1}{N} (N \ln N - \sum_i x_i N \ln x_i - \sum_i x_i N \ln N) = - \sum_i x_i \ln x_i$$

**12.66** Isobaric data reduction is complicated by the fact that both composition and temperature vary from point to point, whereas for isothermal data composition is the only significant variable. (The effect of pressure on liquid-phase properties is assumed negligible.) Because the activity coefficients are strong functions of both liquid composition and  $T$ , which are correlated, it is quite impossible without additional information to separate the effect of composition from that of  $T$ . Moreover, the  $P_i^{\text{sat}}$  values depend strongly on  $T$ , and one must have accurate vapor-pressure data over a temperature range.

**12.67** (a) Written for  $G^E$ , Eqs. (11.15) and (11.16) become:

$$\bar{G}_1^E = G^E + x_2 \frac{dG^E}{dx_1} \quad \text{and} \quad \bar{G}_2^E = G^E - x_1 \frac{dG^E}{dx_1}$$

Divide through by  $RT$ ; define  $\mathcal{G} \equiv \frac{G^E}{RT}$ ; note by Eq. (11.91) that  $\frac{\bar{G}_i^E}{RT} = \ln \gamma_i$

Then 
$$\ln \gamma_1 = \mathcal{G} + x_2 \frac{d\mathcal{G}}{dx_1} \quad \text{and} \quad \ln \gamma_2 = \mathcal{G} - x_1 \frac{d\mathcal{G}}{dx_1}$$

Given: 
$$\frac{G^E}{x_1 x_2 RT} = A^{1/k} \quad \text{with} \quad A \equiv x_1 A_{21}^k + x_2 A_{12}^k$$

Whence:  $\mathcal{G} = x_1 x_2 A^{1/k}$  and  $\frac{d\mathcal{G}}{dx_1} = x_1 x_2 \frac{dA^{1/k}}{dx_1} + A^{1/k}(x_2 - x_1)$

$$\frac{dA^{1/k}}{dx_1} = \frac{1}{k} A^{(1/k)-1} \frac{dA}{dx_1} = \frac{1}{k} \frac{A^{1/k}}{A} (A_{21}^k - A_{12}^k) \quad \text{and} \quad \frac{d\mathcal{G}}{dx_1} = x_1 x_2 \frac{A^{1/k}}{kA} (A_{21}^k - A_{12}^k) + A^{1/k}(x_2 - x_1)$$

Finally,

$$\ln \gamma_1 = x_2^2 A^{1/k} \left[ \frac{(A_{21}^k - A_{12}^k)x_1}{kA} + 1 \right]$$

Similarly,

$$\ln \gamma_2 = x_1^2 A^{1/k} \left[ 1 - \frac{(A_{21}^k - A_{12}^k)x_2}{kA} \right]$$

(b) Appropriate substitution in the preceding equations of  $x_1 = 1$  and  $x_1 = 0$  yields:

$$\ln \gamma_1^\infty = A^{1/k} = (A_{12}^k)^{1/k} = A_{12} \quad \ln \gamma_2^\infty = A^{1/k} = (A_{21}^k)^{1/k} = A_{21}$$

(c) Let  $g \equiv \frac{G^E}{x_1 x_2 RT} = A^{1/k} = (x_1 A_{21}^k + x_2 A_{12}^k)^{1/k}$

If  $k = 1$ ,  $g = x_1 A_{21} + x_2 A_{12}$  (Margules equation)

If  $k = -1$ ,  $g = (x_1 A_{21}^{-1} + x_2 A_{12}^{-1})^{-1} = \frac{A_{21} A_{12}}{x_1 A_{12} + x_2 A_{21}}$  (van Laar equation)

For  $k = 0, -\infty, +\infty$ , indeterminate forms appear, most easily resolved by working with the logarithm:

$$\ln g = \ln(x_1 A_{21}^k + x_2 A_{12}^k)^{1/k} = \frac{1}{k} \ln(x_1 A_{21}^k + x_2 A_{12}^k)$$

Apply l'Hôpital's rule to the final term:

$$\frac{d \ln(x_1 A_{21}^k + x_2 A_{12}^k)}{dk} = \frac{x_1 A_{21}^k \ln A_{21} + x_2 A_{12}^k \ln A_{12}}{x_1 A_{21}^k + x_2 A_{12}^k} \quad (A)$$

Consider the limits of the quantity on the right as  $k$  approaches several limiting values.

- For  $k \rightarrow 0$ ,  $\ln g \rightarrow x_1 \ln A_{21} + x_2 \ln A_{12} = \ln A_{21}^{x_1} + \ln A_{12}^{x_2}$  and  $g = A_{21}^{x_1} A_{12}^{x_2}$
- For  $k \rightarrow \pm\infty$ , Assume  $A_{12}/A_{21} > 1$ , and rewrite the right member of Eq. (A) as

$$\frac{x_1 \ln A_{21} + x_2 (A_{12}/A_{21})^k \ln A_{12}}{x_1 + x_2 (A_{12}/A_{21})^k}$$

- For  $k \rightarrow -\infty$ ,  $\lim_{k \rightarrow -\infty} (A_{12}/A_{21})^k \rightarrow 0$  and  $\lim_{k \rightarrow -\infty} \ln g = \ln A_{21}$

Whence  $g = A_{21}$  except at  $x_1 = 0$  where  $g = A_{12}$

- For  $k \rightarrow +\infty$ ,  $\lim_{k \rightarrow \infty} (A_{12}/A_{21})^k \rightarrow \infty$  and  $\lim_{k \rightarrow \infty} \ln g = \ln A_{12}$

Whence  $g = A_{12}$  except at  $x_1 = 1$  where  $g = A_{21}$

If  $A_{12}/A_{21} < 1$  rewrite Eq. (A) to display  $A_{21}/A_{12}$ .

**12.68** Assume that Eq. (12.1) is the appropriate equilibrium relation, written as

$$x_e \gamma_e P_e^{\text{sat}} = x_e \gamma_e^\infty P_e^{\text{sat}} = y_e P \quad e \equiv \text{EtOH}$$

Because  $P$  is low, we have assumed ideal gases, and for small  $x_e$  let  $\gamma_e \approx \gamma_e^\infty$ . For volume fraction  $\xi_e$  in the vapor, the ideal-gas assumption provides  $\xi_e^v \approx y_e$ , and for the liquid phase, with  $x_e$  small

$$\xi_e^l = \frac{x_e V_e^l}{x_e V_e^l + x_b V_b} \approx \frac{x_e V_e^l}{x_b V_b} \approx \frac{x_e V_e^l}{V_b} \quad b \equiv \text{blood}$$

Then  $\frac{V_b \xi_e^l \gamma_e^\infty P_e^{\text{sat}}}{V_e} \approx \xi_e^v P$  

$$\frac{\text{volume \% EtOH in blood}}{\text{volume \% EtOH in gas}} \approx \frac{V_e P}{V_b \gamma_e^\infty P_e^{\text{sat}}}$$

**12.70** By Eq. (11.95),  $\frac{H^E}{RT} = -T \left( \frac{\kappa(G^E/RT)}{\kappa T} \right)_{P,x}$

$$\frac{G^E}{RT} = -x_1 \ln(x_1 + x_2 \Lambda_{12}) - x_2 \ln(x_2 + x_1 \Lambda_{21}) \quad (12.18)$$

$$\left( \frac{\kappa(G^E/RT)}{\kappa T} \right)_x = -\frac{x_1 x_2 \frac{d\Lambda_{12}}{dT}}{x_1 + x_2 \Lambda_{12}} - \frac{x_2 x_1 \frac{d\Lambda_{21}}{dT}}{x_2 + x_1 \Lambda_{21}}$$

$$\frac{H^E}{RT} = x_1 x_2 T \left( \frac{\frac{d\Lambda_{12}}{dT}}{x_1 + x_2 \Lambda_{12}} + \frac{\frac{d\Lambda_{21}}{dT}}{x_2 + x_1 \Lambda_{21}} \right)$$

$$\Lambda_{ij} = \frac{V_j}{V_i} \exp \frac{-a_{ij}}{RT} \quad (i \neq j) \quad (12.24)$$

$$\frac{d\Lambda_{ij}}{dT} = \frac{V_j}{V_i} \left( \exp \frac{-a_{ij}}{RT} \right) \frac{a_{ij}}{RT^2} = \Lambda_{ij} \frac{a_{ij}}{RT^2}$$

$$H^E = x_1 x_2 \left( \frac{\Lambda_{12} a_{12}}{x_1 + x_2 \Lambda_{12}} + \frac{\Lambda_{21} a_{21}}{x_2 + x_1 \Lambda_{21}} \right)$$

Because  $C_P^E = dH^E/dT$ , differentiate the preceding expression and reduce to get:

$$\frac{C_P^E}{R} = x_1 x_2 \left[ \frac{x_1 \Lambda_{12} (a_{12}/RT)^2}{(x_1 + x_2 \Lambda_{12})^2} + \frac{x_2 \Lambda_{21} (a_{21}/RT)^2}{(x_2 + x_1 \Lambda_{21})^2} \right]$$

Because  $\Lambda_{12}$  and  $\Lambda_{21}$  must always be positive numbers,  $C_P^E$  must always be positive.

## Chapter 13 - Section B - Non-Numerical Solutions

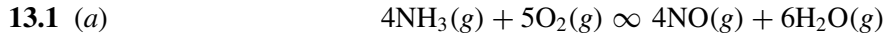

$$v = \left[ \begin{array}{c} v_i = -4 - 5 + 4 + 6 = 1 \\ i \end{array} \right] \quad n_0 = \left[ \begin{array}{c} = 2 + 5 = 7 \\ i_0 \end{array} \right]$$

By Eq. (13.5),

$$y_{\text{NH}_3} = \frac{2 - 4\varepsilon}{7 + \varepsilon} \quad y_{\text{O}_2} = \frac{5 - 5\varepsilon}{7 + \varepsilon} \quad y_{\text{NO}} = \frac{4\varepsilon}{7 + \varepsilon} \quad y_{\text{H}_2\text{O}} = \frac{6\varepsilon}{7 + \varepsilon}$$

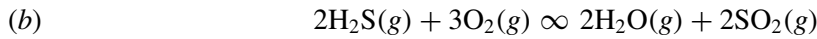

$$v = \left[ \begin{array}{c} v_i = -2 - 3 + 2 + 2 = -1 \\ i \end{array} \right] \quad n_0 = \left[ \begin{array}{c} = 3 + 5 = 8 \\ i_0 \end{array} \right]$$

By Eq. (13.5),

$$y_{\text{H}_2\text{S}} = \frac{3 - 2\varepsilon}{8 - \varepsilon} \quad y_{\text{O}_2} = \frac{5 - 3\varepsilon}{8 - \varepsilon} \quad y_{\text{H}_2\text{O}} = \frac{2\varepsilon}{8 - \varepsilon} \quad y_{\text{SO}_2} = \frac{2\varepsilon}{8 - \varepsilon}$$

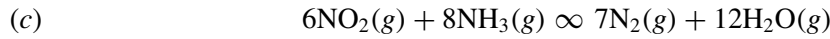

$$v = \left[ \begin{array}{c} v_i = -6 - 8 + 7 + 12 = 5 \\ i \end{array} \right] \quad n_0 = \left[ \begin{array}{c} = 3 + 4 + 1 = 8 \\ i_0 \end{array} \right]$$

By Eq. (13.5),

$$y_{\text{NO}_2} = \frac{3 - 6\varepsilon}{8 + 5\varepsilon} \quad y_{\text{NH}_3} = \frac{4 - 8\varepsilon}{8 + 5\varepsilon} \quad y_{\text{N}_2} = \frac{1 + 7\varepsilon}{8 + 5\varepsilon} \quad y_{\text{H}_2\text{O}} = \frac{12\varepsilon}{8 + 5\varepsilon}$$

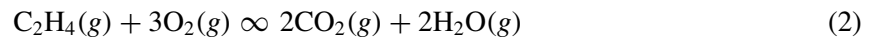
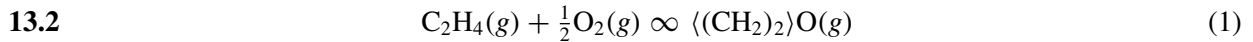

The stoichiometric numbers  $v_{i,j}$  are as follows:

$i =$	$\text{C}_2\text{H}_4$	$\text{O}_2$	$\langle(\text{CH}_2)_2\rangle\text{O}$	$\text{CO}_2$	$\text{H}_2\text{O}$	
$j$						$v_j$
1	-1	$-\frac{1}{2}$	1	0	0	$-\frac{1}{2}$
2	-1	-3	0	2	2	0

$$n_0 = \left[ \begin{array}{c} = 2 + 3 = 5 \\ i_0 \end{array} \right]$$

By Eq. (13.7),

$$y_{\text{C}_2\text{H}_4} = \frac{2 - \varepsilon_1 - \varepsilon_2}{5 - \frac{1}{2}\varepsilon_1} \quad y_{\text{O}_2} = \frac{3 - \frac{1}{2}\varepsilon_1 - 3\varepsilon_2}{5 - \frac{1}{2}\varepsilon_1} \quad y_{\langle(\text{CH}_2)_2\rangle\text{O}} = \frac{\varepsilon_1}{5 - \frac{1}{2}\varepsilon_1}$$

$$y_{\text{CO}_2} = \frac{2\varepsilon_2}{5 - \frac{1}{2}\varepsilon_1} \quad y_{\text{H}_2\text{O}} = \frac{2\varepsilon_2}{5 - \frac{1}{2}\varepsilon_1}$$

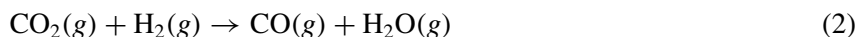
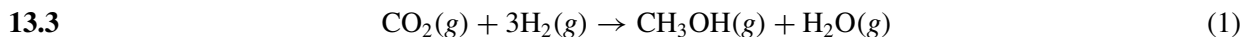

The stoichiometric numbers  $\nu_{i,j}$  are as follows:

$i =$	$\text{CO}_2$	$\text{H}_2$	$\text{CH}_3\text{OH}$	$\text{CO}$	$\text{H}_2\text{O}$	
$j$						$\nu_j$
1	-1	-3	1	0	1	-2
2	-1	-1	0	1	1	0

$$n_0 = \sum_{i_0} = 2 + 5 + 1 = 8$$

By Eq. (13.7),

$$y_{\text{CO}_2} = \frac{2 - \varepsilon_1 - \varepsilon_2}{8 - 2\varepsilon_1} \quad y_{\text{H}_2} = \frac{5 - 3\varepsilon_1 - \varepsilon_2}{8 - 2\varepsilon_1} \quad y_{\text{CH}_3\text{OH}} = \frac{\varepsilon_1}{8 - 2\varepsilon_1} \quad y_{\text{CO}} = \frac{1 + \varepsilon_2}{8 - 2\varepsilon_1} \quad y_{\text{H}_2\text{O}} = \frac{\varepsilon_1 + \varepsilon_2}{8 - 2\varepsilon_1}$$

13.7 The equation for  $\Delta G^\circ$ , appearing just above Eq. (13.18) is:

$$\Delta G^\circ = \Delta H_0^\circ - \frac{T}{T_0}(\Delta H_0^\circ - \Delta G_0^\circ) + R \int_{T_0}^T \frac{\Delta C_P^\circ}{R} dT - RT \int_{T_0}^T \frac{\Delta C_P^\circ}{R} \frac{dT}{T}$$

To calculate values of  $\Delta G^\circ$ , one combines this equation with Eqs. (4.19) and (13.19), and evaluates parameters. In each case the value of  $\Delta H_0^\circ = \Delta H_{298}^\circ$  is tabulated in the solution to Pb. 4.21. In addition, the values of  $\Delta A$ ,  $\Delta B$ ,  $\Delta C$ , and  $\Delta D$  are given in the solutions to Pb. 4.22. The required values of  $\Delta G_0^\circ = \Delta G_{298}^\circ$  in  $\text{J mol}^{-1}$  are:

(a) -32,900; (f) -2,919,124; (i) 113,245; (n) 173,100; (r) -39,630; (t) 79,455; (u) 166,365; (x) 39,430; (y) 83,010

13.8 The relation of  $K_y$  to  $P$  and  $K$  is given by Eq. (13.28), which may be concisely written:

$$K_y = \left[ \frac{P}{P^\circ} \right]^{-\nu} K$$

(a) Differentiate this equation with respect to  $T$  and combine with Eq. (13.14):

$$\left[ \frac{\partial K_y}{\partial T} \right]_P = \left[ \frac{P}{P^\circ} \right]^{-\nu} \frac{dK}{dT} = \frac{K_y}{K} \frac{dK}{dT} = K_y \frac{d \ln K}{dT} = \frac{K_y \Delta H^\circ}{RT^2}$$

Substitute into the given equation for  $(\partial \varepsilon_e / \partial T)_P$ :

$$\left[ \frac{\partial \varepsilon_e}{\partial T} \right]_P = \frac{K_y}{RT^2} \frac{d\varepsilon_e}{dK_y} \Delta H^\circ$$

(b) The derivative of  $K_y$  with respect to  $P$  is:

$$\left[ \frac{\partial K_y}{\partial P} \right]_T = -\nu \left[ \frac{P}{P^\circ} \right]^{-\nu-1} \frac{1}{P^\circ} K = -\nu K \left[ \frac{P}{P^\circ} \right]^{-\nu} \left[ \frac{P}{P^\circ} \right]^{-1} \frac{1}{P^\circ} = \frac{-\nu K_y}{P}$$

Substitute into the given equation for  $(\partial \varepsilon_e / \partial P)_T$ :

$$\left( \frac{\partial \varepsilon_e}{\partial P} \right)_T = \frac{K_y}{P} \frac{d\varepsilon_e}{dK_y} (-\nu)$$

(c) With  $K_y = \prod_i (y_i)^{\nu_i}$ ,  $\ln K_y = \sum_i \nu_i \ln y_i$ . Differentiation then yields:

$$\frac{1}{K_y} \frac{dK_y}{d\varepsilon_e} = \sum_i \frac{\nu_i}{y_i} \frac{dy_i}{d\varepsilon_e} \quad (A)$$

Because  $y_i = n_i/n$ ,  $\frac{dy_i}{d\varepsilon_e} = \frac{1}{n} \frac{dn_i}{d\varepsilon_e} - \frac{n_i}{n^2} \frac{dn}{d\varepsilon_e} = \frac{1}{n} \left( \frac{dn_i}{d\varepsilon_e} - y_i \frac{dn}{d\varepsilon_e} \right)$

But  $n_i = n_{i0} + \nu_i \varepsilon_e$  and  $n = n_0 + \nu \varepsilon_e$

Whence,  $\frac{dn_i}{d\varepsilon_e} = \nu_i$  and  $\frac{dn}{d\varepsilon_e} = \nu$

Therefore,  $\frac{dy_i}{d\varepsilon_e} = \frac{\nu_i - y_i \nu}{n_0 + \nu \varepsilon_e}$

Substitution into Eq. (A) gives

$$\begin{aligned} \frac{1}{K_y} \frac{dK_y}{d\varepsilon_e} &= \sum_i \frac{\nu_i}{y_i} \left( \frac{\nu_i - y_i \nu}{n_0 + \nu \varepsilon_e} \right) = \frac{1}{n_0 + \nu \varepsilon_e} \sum_i \left( \frac{\nu_i^2}{y_i} - \nu_i \nu \right) \\ &= \frac{1}{n_0 + \nu \varepsilon_e} \sum_{i=1}^m \left( \frac{\nu_i^2}{y_i} - \nu_i \sum_{k=1}^m \nu_k \right) \end{aligned}$$

In this equation, both  $K_y$  and  $n_0 + \nu \varepsilon_e (= n)$  are positive. It remains to show that the summation term is positive. If  $m = 2$ , this term becomes

$$\frac{\nu_1^2}{y_1} - \nu_1(\nu_1 + \nu_2) + \frac{\nu_2^2}{y_2} - \nu_2(\nu_1 + \nu_2) = \frac{(y_2 \nu_1 - y_1 \nu_2)^2}{y_1 y_2}$$

where the expression on the right is obtained by straight-forward algebraic manipulation. One can proceed by induction to find the general result, which is

$$\sum_{i=1}^m \left( \frac{\nu_i^2}{y_i} - \nu_i \sum_{k=1}^m \nu_k \right) = \sum_i \sum_k \frac{(y_k \nu_i - y_i \nu_k)^2}{y_i y_k} \quad (i < k)$$

All quantities in the sum are of course positive.

### 13.9

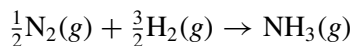

For the given reaction,  $\nu = -1$ , and for the given amounts of reactants,  $n_0 = 2$ .

By Eq. (13.5),  $y_{\text{N}_2} = \frac{\frac{1}{2}(1 - \varepsilon_e)}{2 - \varepsilon_e}$ ,  $y_{\text{H}_2} = \frac{\frac{3}{2}(1 - \varepsilon_e)}{2 - \varepsilon_e}$ ,  $y_{\text{NH}_3} = \frac{\varepsilon_e}{2 - \varepsilon_e}$

By Eq. (13.28),  $\frac{y_{\text{NH}_3}}{y_{\text{N}_2}^{1/2} y_{\text{H}_2}^{3/2}} = \frac{\varepsilon_e(2 - \varepsilon_e)}{[\frac{1}{2}(1 - \varepsilon_e)]^{1/2} [\frac{3}{2}(1 - \varepsilon_e)]^{3/2}} = K \frac{P}{P^\circ}$



Whence, 
$$\frac{\varepsilon_e(2 - \varepsilon_e)}{(1 - \varepsilon_e)^2} = \frac{1}{2}^{1/2} \frac{3}{2}^{3/2} K \frac{P}{P^\circ} = 1.299K \frac{P}{P^\circ}$$

This may be written: 
$$r\varepsilon_e^2 - 2r\varepsilon_e + (r - 1) = 0$$

where, 
$$r \equiv 1 + 1.299K \frac{P}{P^\circ}$$

The roots of the quadratic are: 
$$\varepsilon_e = 1 \pm \frac{1}{r^{1/2}} = 1 \pm r^{-1/2}$$

Because  $\varepsilon_e < 1$ ,  $\varepsilon_e = 1 - r^{-1/2}$ , 
$$\varepsilon_e = 1 - \left(1 + 1.299K \frac{P}{P^\circ}\right)^{-1/2}$$

**13.10** The reactions are written:

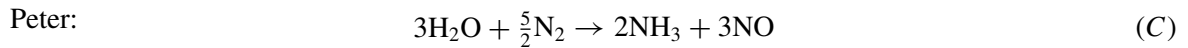
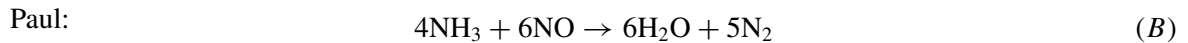
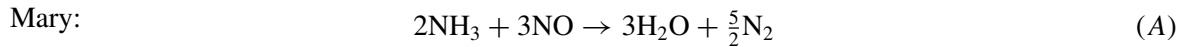

Each applied Eqs. (13.11b) and (13.25), here written:

$$\ln K = -\Delta G^\circ / RT \quad \text{and} \quad K = (P^\circ)^{-\nu} \prod_i (\hat{f}_i)^{\nu_i}$$

For reaction (A), 
$$\Delta G_A^\circ = 3\Delta G_{f\text{H}_2\text{O}}^\circ - 2\Delta G_{f\text{NH}_3}^\circ - 3\Delta G_{f\text{NO}}^\circ$$

For Mary's reaction  $\nu = \frac{1}{2}$ , and:

$$K_A = (P^\circ)^{-\frac{1}{2}} \frac{\hat{f}_{f\text{H}_2\text{O}}^3 \hat{f}_{f\text{N}_2}^{5/2}}{\hat{f}_{f\text{NH}_3}^2 \hat{f}_{f\text{NO}}^3} \quad \text{and} \quad \ln K_A = \frac{-\Delta G_A^\circ}{RT}$$

For Paul's reaction  $\nu = 1$ , and

$$K_B = (P^\circ)^{-1} \frac{\hat{f}_{f\text{H}_2\text{O}}^6 \hat{f}_{f\text{N}_2}^5}{\hat{f}_{f\text{NH}_3}^4 \hat{f}_{f\text{NO}}^6} \quad \text{and} \quad \ln K_B = \frac{-2\Delta G_A^\circ}{RT}$$

For Peter's reaction  $\nu = -\frac{1}{2}$ , and:

$$K_C = (P^\circ)^{\frac{1}{2}} \frac{\hat{f}_{f\text{NH}_3}^2 \hat{f}_{f\text{NO}}^3}{\hat{f}_{f\text{H}_2\text{O}}^3 \hat{f}_{f\text{N}_2}^{5/2}} \quad \text{and} \quad \ln K_C = \frac{\Delta G_A^\circ}{RT}$$

In each case the two equations are combined:

Mary: 
$$(P^\circ)^{-\frac{1}{2}} \frac{\hat{f}_{f\text{H}_2\text{O}}^3 \hat{f}_{f\text{N}_2}^{5/2}}{\hat{f}_{f\text{NH}_3}^2 \hat{f}_{f\text{NO}}^3} = \exp \frac{-\Delta G_A^\circ}{RT}$$

Paul: 
$$(P^\circ)^{-1} \frac{\hat{f}_{\text{H}_2\text{O}}^6 \hat{f}_{\text{N}_2}^5}{\hat{f}_{\text{NH}_3}^4 \hat{f}_{\text{NO}}^6} = \left[ \exp \frac{-\Delta G_A^\circ}{RT} \right]^2$$

Taking the square root yields Mary's equation.

Peter: 
$$(P^\circ)^{\frac{1}{2}} \frac{\hat{f}_{\text{NH}_3}^2 \hat{f}_{\text{NO}}^3}{\hat{f}_{\text{H}_2\text{O}}^3 \hat{f}_{\text{N}_2}^{5/2}} = \left[ \exp \frac{-\Delta G_A^\circ}{RT} \right]^{-1}$$

Taking the reciprocal yields Mary's equation.

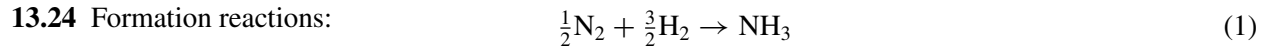

Combine Eq. (3) with Eq. (1) and with Eq. (2) to eliminate N<sub>2</sub>:



The set now comprises Eqs. (4), (5), and (6); combine Eq. (4) with Eq. (5) to eliminate H<sub>2</sub>:



Equations (6) and (7) represent a set of independent reactions for which  $r = 2$ . Other equivalent sets of two reactions may be obtained by different combination procedures. By the phase rule,

$$F = 2 - \pi + N - r - s = 2 - 1 + 5 - 2 - 0 \quad \boxed{F = 4}$$

**13.35** (a) Equation (13.28) here becomes: 
$$\frac{y_B}{y_A} = \left[ \frac{P}{P^\circ} \right]^0 K = K$$

Whence,

$$\boxed{\frac{y_B}{1 - y_B} = K(T)}$$

(b) The preceding equation indicates that the equilibrium composition depends on temperature only. However, application of the phase rule, Eq. (13.36), yields:

$$F = 2 + 2 - 1 - 1 = 2$$

This result means in general for single-reaction equilibrium between two species A and B that two degrees of freedom exist, and that pressure as well as temperature must be specified to fix the equilibrium state of the system. However, here, the specification that the gases are ideal removes the pressure dependence, which in the general case appears through the  $\hat{\phi}_i$ s.

**13.36** For the isomerization reaction in the gas phase at low pressure, assume ideal gases. Equation (13.28) then becomes:

$$\frac{y_B}{y_A} = \left[ \frac{P}{P^\circ} \right]^0 K = K \quad \text{whence} \quad \frac{1 - y_A}{y_A} = K(T)$$

Assume that vapor/liquid phase equilibrium can be represented by Raoult's law, because of the low pressure and the similarity of the species:

$$x_A P_A^{\text{sat}}(T) = y_A P \quad \text{and} \quad (1 - x_A) P_B^{\text{sat}}(T) = (1 - y_A) P$$

(a) Application of Eq. (13.36) yields: 
$$F = 2 - \pi + N - r = 2 - 2 + 2 - 1 = 1$$

(b) Given  $T$ , the reaction-equilibrium equation allows solution for  $y_A$ . The two phase-equilibrium equations can then be solved for  $x_A$  and  $P$ . The equilibrium state therefore depends solely on  $T$ .

**13.38** (a) For low pressure and a temperature of 500 K, the system is assumed to be a mixture of ideal gases, for which Eq. (13.28) is appropriate. Therefore,

$$\frac{y_{\text{MX}}}{y_{\text{OX}}} = \left(\frac{P}{P^\circ}\right)^0 K_{\text{I}} = K_{\text{I}} \quad \frac{y_{\text{PX}}}{y_{\text{OX}}} = \left(\frac{P}{P^\circ}\right)^0 K_{\text{II}} = K_{\text{II}} \quad \frac{y_{\text{EB}}}{y_{\text{OX}}} = \left(\frac{P}{P^\circ}\right)^0 K_{\text{III}} = K_{\text{III}}$$

(b) These equation equations lead to the following set:

$$\boxed{y_{\text{MX}} = K_{\text{I}} y_{\text{OX}}} \quad (1) \quad \boxed{y_{\text{PX}} = K_{\text{II}} y_{\text{OX}}} \quad (2) \quad \boxed{y_{\text{EB}} = K_{\text{III}} y_{\text{OX}}} \quad (3)$$

The mole fractions must sum to unity, and therefore:

$$y_{\text{OX}} + K_{\text{I}} y_{\text{OX}} + K_{\text{II}} y_{\text{OX}} + K_{\text{III}} y_{\text{OX}} = y_{\text{OX}}(1 + K_{\text{I}} + K_{\text{II}} + K_{\text{III}}) = 1$$

$$\boxed{y_{\text{OX}} = \frac{1}{1 + K_{\text{I}} + K_{\text{II}} + K_{\text{III}}}} \quad (4)$$

(c) With the assumption that  $\Delta C_p^\circ = 0$  and therefore that  $K_2 = 1$ , Eqs. (13.20), (13.21), and (13.22) combine to give:

$$K = K_0 K_1 = \exp\left(\frac{-\Delta G_{298}^\circ}{RT_0}\right) \exp\left[\frac{\Delta H_{298}^\circ}{RT_0} \left(1 - \frac{T_0}{T}\right)\right]$$

Whence,

$$K = \exp\left[\frac{\Delta H_{298}^\circ \left(1 - \frac{298.15}{500}\right) - \Delta G_{298}^\circ}{(8.314)(298.15)}\right]$$

The data provided lead to the following property changes of reaction and equilibrium constants at 500 K:

Reaction	$\Delta H_{298}^\circ$	$\Delta G_{298}^\circ$	$K$
I	-1,750	-3,300	2.8470
II	-1,040	-1,000	1.2637
III	10,920	8,690	0.1778

(d) Substitution of numerical values into Eqs. (1), (2), (3), and (4) yields the following values for the mole fractions:

$$y_{\text{OX}} = 0.1891 \quad y_{\text{MX}} = 0.5383 \quad y_{\text{PX}} = 0.2390 \quad y_{\text{EB}} = 0.0336$$

**13.40** For the given flowrates,  $n_{A_0} = 10$  and  $n_{B_0} = 15$ , with  $n_{A_0}$  the limiting reactant without (II)

$$\begin{aligned} n_A &= n_{A_0} - \varepsilon_I - \varepsilon_{II} \\ n_B &= n_{B_0} - \varepsilon_I \\ n_C &= \varepsilon_I - \varepsilon_{II} \\ n_D &= \varepsilon_{II} \\ \hline n &= n_0 - \varepsilon_I - \varepsilon_{II} \end{aligned}$$

Use given values of  $Y_C$  and  $S_{C/D}$  to find  $\varepsilon_I$  and  $\varepsilon_{II}$ :

$$Y_C = \frac{\varepsilon_I - \varepsilon_{II}}{n_{A_0}} \quad \text{and} \quad S_{C/D} = \frac{\varepsilon_I - \varepsilon_{II}}{\varepsilon_{II}}$$

Solve for  $\varepsilon_I$  and  $\varepsilon_{II}$ :

$$\varepsilon_I = \left( \frac{S_{C/D} + 1}{S_{C/D}} \right) n_{A_0} Y_C = \left( \frac{2 + 1}{2} \right) \times 10 \times 0.40 = 6$$

$$\varepsilon_{II} = \frac{n_{A_0} Y_C}{S_{C/D}} = \frac{10 \times 0.40}{2} = 2$$

$n_A$	$= 10 - 6 - 2$	$= 2$	$y_A$	$= 2/17$	$= 0.1176$
$n_B$	$= 15 - 6$	$= 9$	$y_B$	$= 9/17$	$= 0.5295$
$n_C$	$= 6 - 2$	$= 4$	$y_C$	$= 4/17$	$= 0.2353$
$n_D$	$= 2$	$= 2$	$y_D$	$= 2/17$	$= 0.1176$
$n$	$= 17$			$= 1$	

**13.42** A compound with large positive  $\Delta G_f^\circ$  has a disposition to decompose into its constituent elements. Moreover, large positive  $\Delta G_f^\circ$  often implies large positive  $\Delta H_f^\circ$ . Thus, if any decomposition product is a gas, high pressures can be generated in a closed system owing to temperature increases resulting from exothermic decomposition.

**13.44** By Eq. (13.12),  $\Delta G^\circ \equiv \sum_i \nu_i G_i^\circ$  and from Eq. (6.10),  $(\partial G_i^\circ / \partial P)_T = V_i^\circ$

$$\left( \frac{\partial \Delta G^\circ}{\partial P^\circ} \right)_T = \sum_i \nu_i \left( \frac{\partial G_i^\circ}{\partial P^\circ} \right)_T = \sum_i \nu_i V_i^\circ$$

For the ideal-gas standard state,  $V_i^\circ = RT/P^\circ$ . Therefore

$$\left( \frac{\partial \Delta G^\circ}{\partial P^\circ} \right)_T = \sum_i \nu_i \left( \frac{RT}{P^\circ} \right) = \frac{\nu RT}{P^\circ} \quad \text{and} \quad \Delta G^\circ(P_2^\circ) - \Delta G^\circ(P_1^\circ) = \nu RT \ln \frac{P_2^\circ}{P_1^\circ}$$

**13.47** (a) For isomers at low pressure Raoult's law should apply:

$$P = x_A P_A^{\text{sat}} + x_B P_B^{\text{sat}} = P_B^{\text{sat}} + x_A (P_A^{\text{sat}} - P_B^{\text{sat}})$$

For the given reaction with an ideal solution in the liquid phase, Eq. (13.33) becomes:

$$K^l = \frac{x_B}{x_A} = \frac{1 - x_A}{x_A} \quad \text{from which} \quad x_A = \frac{1}{K^l + 1}$$

The preceding equation now becomes,

$$P = \left[ 1 - \frac{1}{K^l + 1} \right] P_B^{\text{sat}} + \left[ \frac{1}{K^l + 1} \right] P_A^{\text{sat}}$$

$$P = \left[ \frac{K^l}{K^l + 1} \right] P_B^{\text{sat}} + \left[ \frac{1}{K^l + 1} \right] P_A^{\text{sat}} \quad (A)$$

For  $K^l = 0$   $P = P_A^{\text{sat}}$       For  $K^l = \infty$   $P = P_B^{\text{sat}}$

(b) Given Raoult's law:

$$1 = x_A + x_B = y_A \frac{P}{P_A^{\text{sat}}} + y_B \frac{P}{P_B^{\text{sat}}} = P \left[ \frac{y_A}{P_A^{\text{sat}}} + \frac{y_B}{P_B^{\text{sat}}} \right]$$

$$P = \frac{1}{y_A/P_A^{\text{sat}} + y_B/P_B^{\text{sat}}} = \frac{P_A^{\text{sat}} P_B^{\text{sat}}}{y_A P_B^{\text{sat}} + y_B P_A^{\text{sat}}} = \frac{P_A^{\text{sat}} P_B^{\text{sat}}}{P_A^{\text{sat}} + y_A (P_B^{\text{sat}} - P_A^{\text{sat}})}$$

For the given reaction with ideal gases in the vapor phase, Eq. (13.28) becomes:

$$\frac{y_B}{y_A} = K^v \quad \text{whence} \quad y_A = \frac{1}{K^v + 1}$$

Elimination of  $y_A$  from the preceding equation and reduction gives:

$$P = \frac{(K^v + 1) P_A^{\text{sat}} P_B^{\text{sat}}}{K^v P_A^{\text{sat}} + P_B^{\text{sat}}} \quad (B)$$

For  $K^v = 0$   $P = P_A^{\text{sat}}$       For  $K^v = \infty$   $P = P_B^{\text{sat}}$

(c) Equations (A) and (B) must yield the same  $P$ . Therefore

$$\left[ \frac{K^l}{K^l + 1} \right] P_B^{\text{sat}} + \left[ \frac{1}{K^l + 1} \right] P_A^{\text{sat}} = \frac{(K^v + 1) P_A^{\text{sat}} P_B^{\text{sat}}}{K^v P_A^{\text{sat}} + P_B^{\text{sat}}}$$

Some algebra reduces this to:

$$\frac{K^v}{K^l} = \frac{P_B^{\text{sat}}}{P_A^{\text{sat}}}$$

(d) As mentioned already, the species (isomers) are chemically similar, and the low pressure favors ideal-gas behavior.

(e)  $F = N + 2 - \pi - r = 2 + 2 - 2 - 1 = 1$  Thus fixing  $T$  should suffice.

## Chapter 14 - Section B - Non-Numerical Solutions

14.2 Start with the equation immediately following Eq. (14.49), which can be modified slightly to read:

$$\ln \hat{v}_i = \frac{\varepsilon(nG^R/RT)}{\varepsilon n_i} - \frac{\varepsilon(nZ)}{\varepsilon n_i} + n \frac{\varepsilon \ln Z}{\varepsilon n_i} + 1$$

where the partial derivatives written here and in the following development without subscripts are understood to be at constant  $T$ ,  $n/\rho$  (or  $\rho/n$ ), and  $n_j$ . Equation (6.61) after multiplication by  $n$  can be written:

$$\frac{nG^R}{RT} = 2n(nB) \left[ \frac{\rho}{n} \left( + \frac{3}{2} n^2(nC) \left[ \frac{\rho}{n} \left( ^2 - n \ln Z \right. \right. \right. \right.$$

Differentiate:

$$\frac{\varepsilon(nG^R/RT)}{\varepsilon n_i} = 2 \left[ \frac{\rho}{n} (nB + n\bar{B}_i) + \frac{3}{2} \left[ \frac{\rho}{n} \left( ^2 (2n^2C + n^2\bar{C}_i) - n \frac{\varepsilon \ln Z}{\varepsilon n_i} - \ln Z \right. \right. \right.$$

or

$$\frac{\varepsilon(nG^R/RT)}{\varepsilon n_i} = 2\rho(B + \bar{B}_i) + \frac{3}{2}\rho^2(2C + \bar{C}_i) - n \frac{\varepsilon \ln Z}{\varepsilon n_i} - \ln Z$$

By definition,  $\bar{B}_i \left( \frac{\varepsilon(nB)}{\varepsilon n_i} \right)_{T, n_j}$  and  $\bar{C}_i \left( \frac{\varepsilon(nC)}{\varepsilon n_i} \right)_{T, n_j}$

The equation of state, Eq. (3.40), can be written:

$$Z = 1 + B\rho + C\rho^2 \quad \text{or} \quad nZ = n + n(nB) \left[ \frac{\rho}{n} \left( + n^2(nC) \left[ \frac{\rho}{n} \left( ^2 \right. \right. \right. \right.$$

Differentiate:  $\frac{\varepsilon(nZ)}{\varepsilon n_i} = 1 + \left[ \frac{\rho}{n} (nB + n\bar{B}_i) + \left[ \frac{\rho}{n} \left( ^2 (2n^2C + n^2\bar{C}_i) \right. \right. \right.$

or

$$\frac{\varepsilon(nZ)}{\varepsilon n_i} = 1 + \rho(B + \bar{B}_i) + \rho^2(2C + \bar{C}_i)$$

When combined with the two underlined equations, the initial equation reduces to:

$$\ln \hat{v}_i = 1 + \rho(B + \bar{B}_i) + \frac{1}{2}\rho^2(2C + \bar{C}_i)$$

The two mixing rules are:

$$B = y_1^2 B_{11} + 2y_1 y_2 B_{12} + y_2^2 B_{22}$$

$$C = y_1^3 C_{111} + 3y_1^2 y_2 C_{112} + 3y_1 y_2^2 C_{122} + y_2^3 C_{222}$$

Application of the definitions of  $\bar{B}_i$  and  $\bar{C}_i$  to these mixing rules yields:

$$\bar{B}_1 = y_1(2 - y_1)B_{11} + 2y_2^2 B_{12} - y_2^2 B_{22}$$

$$\bar{C}_1 = y_1^2(3 - 2y_1)C_{111} + 6y_1 y_2^2 C_{112} + 3y_2^2(1 - 2y_1)C_{122} - 2y_2^3 C_{222}$$

$$\bar{B}_2 = -y_1^2 B_{11} + 2y_1^2 B_{12} + y_2(2 - y_2)B_{22}$$

$$\bar{C}_2 = -2y_1^3 C_{111} + 3y_1^2(1 - 2y_2)C_{112} + 6y_1 y_2^2 C_{122} + 2y_2^2(3 - 2y_2)C_{222}$$

In combination with the mixing rules, these give:

$$\begin{aligned} B + \bar{B}_1 &= 2(y_1 B_{11} + y_2 B_{12}) \\ 2C + \bar{C}_1 &= 3(y_1^2 C_{111} + 2y_1 y_2 C_{112} + y_2^2 C_{122}) \\ B + \bar{B}_2 &= 2(y_2 B_{22} + y_1 B_{12}) \\ 2C + \bar{C}_2 &= 3(y_2^2 C_{222} + 2y_1 y_2 C_{122} + y_1^2 C_{112}) \end{aligned}$$

In combination with the boxed equation these expressions along with Eq. (3.40) allow calculation of  $\ln \hat{\phi}_1$  and  $\ln \hat{\phi}_2$ .

**14.11** For the case described, Eqs. (14.1) and (14.2) combine to give:  $y_i P = x_i P_i^{\text{sat}} \frac{\phi_i^{\text{sat}}}{\hat{\phi}_i}$

If the vapor phase is assumed an ideal *solution*,  $\hat{\phi}_i = \phi_i$ , and  $y_i P = x_i P_i^{\text{sat}} \frac{\phi_i^{\text{sat}}}{\phi_i}$

When Eq. (3.38) is valid, the fugacity coefficient of pure species  $i$  is given by Eq. (11.36):

$$\ln \phi_i = \frac{B_{ii} P}{RT} \quad \text{and} \quad \phi_i^{\text{sat}} = \frac{B_{ii} P_i^{\text{sat}}}{RT}$$

Therefore,  $\ln \frac{\phi_i^{\text{sat}}}{\phi_i} = \ln \phi_i^{\text{sat}} - \ln \phi_i = \frac{B_{ii} P_i^{\text{sat}}}{RT} - \frac{B_{ii} P}{RT} = \frac{B_{ii}(P_i^{\text{sat}} - P)}{RT}$

For small values of the final term, this becomes approximately:

$$\frac{\phi_i^{\text{sat}}}{\phi_i} = 1 + \frac{B_{ii}(P_i^{\text{sat}} - P)}{RT}$$

Whence,  $y_i P = x_i P_i^{\text{sat}} \left[ 1 + \frac{B_{ii}(P_i^{\text{sat}} - P)}{RT} \right]$

or  $y_i P - x_i P_i^{\text{sat}} = \frac{x_i P_i^{\text{sat}} B_{ii}(P_i^{\text{sat}} - P)}{RT}$

Write this equation for species 1 and 2 of a binary mixture, and sum. This yields on the left the difference between the actual pressure and the pressure given by Raoult's law:

$$P - P(\text{RL}) = \frac{x_1 B_{11} P_1^{\text{sat}} (P_1^{\text{sat}} - P) + x_2 B_{22} P_2^{\text{sat}} (P_2^{\text{sat}} - P)}{RT}$$

Because deviations from Raoult's law are presumably small,  $P$  on the right side may be replaced by its Raoult's-law value. For the two terms,

$$P_1^{\text{sat}} - P = P_1^{\text{sat}} - x_1 P_1^{\text{sat}} - x_2 P_2^{\text{sat}} = P_1^{\text{sat}} - (1 - x_2) P_1^{\text{sat}} - x_2 P_2^{\text{sat}} = x_2 (P_1^{\text{sat}} - P_2^{\text{sat}})$$

$$P_2^{\text{sat}} - P = P_2^{\text{sat}} - x_1 P_1^{\text{sat}} - x_2 P_2^{\text{sat}} = P_2^{\text{sat}} - x_1 P_1^{\text{sat}} - (1 - x_1) P_2^{\text{sat}} = x_1 (P_2^{\text{sat}} - P_1^{\text{sat}})$$

Combine the three preceding equations:

$$\begin{aligned} P - P(\text{RL}) &= \frac{x_1 x_2 B_{11} (P_1^{\text{sat}} - P_2^{\text{sat}}) P_1^{\text{sat}} - x_1 x_2 B_{22} (P_1^{\text{sat}} - P_2^{\text{sat}}) P_2^{\text{sat}}}{RT} \\ &= \frac{x_1 x_2 (P_1^{\text{sat}} - P_2^{\text{sat}})}{RT} (B_{11} P_1^{\text{sat}} - B_{22} P_2^{\text{sat}}) \end{aligned}$$

Rearrangement yields the following:

$$\begin{aligned}
 P - P(\text{RL}) &= \frac{x_1 x_2 (P_1^{\text{sat}} - P_2^{\text{sat}})^2}{RT} \left( \frac{B_{11} P_1^{\text{sat}} - B_{22} P_2^{\text{sat}}}{P_1^{\text{sat}} - P_2^{\text{sat}}} \right) \\
 &= \frac{x_1 x_2 (P_1^{\text{sat}} - P_2^{\text{sat}})^2}{RT} \left[ B_{11} + \frac{(B_{11} - B_{22}) P_2^{\text{sat}}}{P_1^{\text{sat}} - P_2^{\text{sat}}} \right] \\
 &= \frac{x_1 x_2 (P_1^{\text{sat}} - P_2^{\text{sat}})^2}{RT} (B_{11}) \left[ 1 + \left( 1 - \frac{B_{22}}{B_{11}} \right) \frac{P_2^{\text{sat}}}{P_1^{\text{sat}} - P_2^{\text{sat}}} \right]
 \end{aligned}$$

Clearly, when  $B_{22} = B_{11}$ , the term in square brackets equals 1, and the pressure deviation from the Raoult's-law value has the sign of  $B_{11}$ ; this is normally negative. When the virial coefficients are not equal, a reasonable assumption is that species 2, taken here as the "heavier" species (the one with the smaller vapor pressure) has the more negative second virial coefficient. This has the effect of making the quantity in parentheses negative and the quantity in square brackets  $< 1$ . However, if this latter quantity remains positive (the most likely case), the sign of  $B_{11}$  still determines the sign of the deviations.

**14.13** By Eq. (11.90), the definition of  $\gamma_i$ ,  $\ln \gamma_i = \ln \hat{f}_i - \ln x_i - \ln f_i$

Whence, 
$$\frac{d \ln \gamma_i}{dx_i} = \frac{d \ln \hat{f}_i}{dx_i} - \frac{1}{x_i} = \frac{1}{\hat{f}_i} \frac{d \hat{f}_i}{dx_i} - \frac{1}{x_i}$$

Combination of this expression with Eq. (14.71) yields: 
$$\frac{1}{\hat{f}_i} \frac{d \hat{f}_i}{dx_i} > 0$$

Because  $\hat{f}_i \geq 0$ , 
$$\boxed{\frac{d \hat{f}_i}{dx_i} > 0 \quad (\text{const } T, P)}$$

By Eq. (11.46), the definition of  $\hat{f}_i$ , 
$$\frac{d \mu_i}{dx_i} = RT \frac{d \ln \hat{f}_i}{dx_i} = \frac{RT}{\hat{f}_i} \frac{d \hat{f}_i}{dx_i}$$

Combination with Eq. (14.72) yields: 
$$\boxed{\frac{d \mu_i}{dx_i} > 0 \quad (\text{const } T, P)}$$

**14.14** Stability requires that  $\Delta G < 0$  (see Pg. 575). The limiting case obtains when  $\Delta G = 0$ , in which event Eq. (12.30) becomes:

$$G^E = -RT \sum_i x_i \ln x_i$$

For an equimolar solution  $x_i = 1/N$  where  $N$  is the number of species. Therefore,

$$G^E(\text{max}) = -RT \sum_i \frac{1}{N} \ln \frac{1}{N} = RT \sum_i \frac{1}{N} \ln N = RT \ln N$$

For the special case of a binary solution,  $N = 2$ , and  $G^E(\text{max}) = RT \ln 2$



**14.17** According to Pb. 11.35,  $G^E = \delta_{12} P y_1 y_2$  or  $\frac{G^E}{RT} = \frac{\delta_{12} P}{RT} y_1 y_2$

This equation has the form:  $\frac{G^E}{RT} = A x_1 x_2$

for which it is shown in Examples 14.5 and 14.6 that phase-splitting occurs for  $A > 2$ . Thus, the formation of two immiscible vapor phases requires:  $\delta_{12} P / RT > 2$ .

Suppose  $T = 300$  K and  $P = 5$  bar. The preceding condition then requires:  $\delta_{12} > 9977 \text{ cm}^3 \text{ mol}^{-1}$  for vapor-phase immiscibility. Such large positive values for  $\delta_{12}$  are unknown for real mixtures. (Examples of gas/gas equilibria are known, but at conditions outside the range of applicability of the two-term virial EOS.)

**14.19** Consider a *quadratic mixture*, described by:  $\frac{G^E}{RT} = A x_1 x_2$

It is shown in Example 14.5 that phase splitting occurs for such a mixture if  $A > 2$ ; the value of  $A = 2$  corresponds to a consolute point, at  $x_1 = x_2 = 0.5$ . Thus, for a quadratic mixture, phase-splitting obtains if:

$$G^E > 2 \cdot \frac{1}{2} \cdot \frac{1}{2} \cdot RT = 0.5RT$$

This is a *model-dependent* result. Many liquid mixtures are known which are stable as single phases, even though  $G^E > 0.5RT$  for equimolar composition.

**14.21** Comparison of the Wilson equation, Eq. (12.18) with the modified Wilson equation shows that  $(G^E/RT)_m = C(G^E/RT)$ , where subscript m distinguishes the modified Wilson equation from the original Wilson equation. To simplify, define  $g \equiv (G^E/RT)$ ; then

$$g_m = Cg \quad ng_m = Cng \quad \frac{\partial (ng_m)}{\partial n_1} = C \frac{\partial (ng)}{\partial n_1} \quad \ln(\gamma_1)_m = C \ln \gamma_1$$

where the final equality follows from Eq. (11.96). Addition and subtraction of  $\ln x_1$  on the left side of this equation and of  $C \ln x_1$  on the right side yields:

$$\ln(x_1 \gamma_1)_m - \ln x_1 = C \ln(x_1 \gamma_1) - C \ln x_1$$

or 
$$\ln(x_1 \gamma_1)_m = C \ln(x_1 \gamma_1) - (C - 1) \ln x_1$$

Differentiate: 
$$\frac{d \ln(x_1 \gamma_1)_m}{dx_1} = C \frac{d \ln(x_1 \gamma_1)}{dx_1} - \frac{C - 1}{x_1}$$

As shown in Example 14.7, the derivative on the right side of this equation is always positive. However, for  $C$  sufficiently greater than unity, the contribution of the second term on the right can make

$$\frac{d \ln(x_1 \gamma_1)_M}{dx_1} < 0$$

over part of the composition range, thus violating the stability condition of Eq. (14.71) and implying the formation of two liquid phases.

**14.23** (a) Refer to the stability requirement of Eq. (14.70). For *instability*, i.e., for the formation of two liquid phases,

$$\frac{d^2(G^E/RT)}{dx_1^2} < -\frac{1}{x_1 x_2}$$

over part of the composition range. The second derivative of  $G^E$  must be sufficiently *negative* so as to satisfy this condition for some range of  $x_1$ . Negative curvature is the norm for mixtures for which  $G^E$  is positive; see, e.g., the sketches of  $G^E$  vs.  $x_1$  for systems (a), (b), (d), (e), and (f) in Fig. 11.4. Such systems are candidates for liquid/liquid phase splitting, although it does not in fact occur for the cases shown. Rather large values of  $G^E$  are usually required.

(b) Nothing in principle precludes phase-splitting in mixtures for which  $G^E < 0$ ; one merely requires that the curvature be sufficiently negative over part of the composition range. However, positive curvature is the norm for such mixtures. We know of no examples of liquid/liquid phase-splitting in systems exhibiting negative deviations from ideal-solution behavior.

**14.29** The analogy is Raoult's law, Eq. (10.1), applied at constant  $P$  (see Fig. 10.12):  $y_i P = x_i P_i^{\text{sat}}$ . If the vapor phase in VLE is ideal and the liquid molar volumes are negligible (assumptions inherent in Raoult's law), then the Clausius/Clapeyron equation applies (see Ex. 6.5):

$$\frac{d \ln P_i^{\text{sat}}}{dT} = \frac{\Delta H_i^{lv}}{RT^2}$$

Integration from the boiling temperature  $T_{b_i}$  at pressure  $P$  (where  $P_i^{\text{sat}} = P$ ) to the actual temperature  $T$  (where  $P_i^{\text{sat}} = P_i^{\text{sat}}$ ) gives:

$$\ln \frac{P_i^{\text{sat}}}{P} = \int_{T_{b_i}}^T \frac{\Delta H_i^{lv}}{RT^2} dT$$

Combination with Eq. (10.1) yields:

$$y_i = x_i \exp \int_{T_{b_i}}^T \frac{\Delta H_i^{lv}}{RT^2} dT$$

which is an analog of the Case I SLE equations.

**14.30** Consider binary (*two-species*) equilibrium between *two* phases of the same kind. Equation (14.74) applies:

$$x_i^\alpha \gamma_i^\alpha = x_i^\beta \gamma_i^\beta \quad (i = 1, 2)$$

If phase  $\beta$  is pure species 1 and phase  $\alpha$  is pure species 2, then  $x_1^\beta = \gamma_1^\beta = 1$  and  $x_2^\alpha = \gamma_2^\alpha = 1$ .

Hence,  $x_1^\alpha \gamma_1^\alpha = x_1^\beta \gamma_1^\beta = 1$  and  $x_2^\alpha \gamma_2^\alpha = x_2^\beta \gamma_2^\beta = 1$

The reasoning applies generally to (degenerate)  $N$ -phase equilibrium involving  $N$  mutually immiscible species. Whence the cited result for solids.

**14.31** The rules of thumb are based on Case II binary SLE behavior. For concreteness, let the solid be pure species 1 and the solvent be liquid species 2. Then Eqs. (14.93) and (14.92a) apply:

$$x_1 = \psi_1 = \exp \frac{\Delta H_1^{sl}}{RT_{m_1}} \left( \frac{T - T_{m_1}}{T} \right)$$

(a) Differentiate:  $\frac{dx_1}{dT} = \psi_1 \cdot \frac{\Delta H_1^{sl}}{RT^2}$

Thus  $dx_1/dT$  is necessarily positive: the solid solubility  $x_1$  increases with increasing  $T$ .

(b) Equation (14.92a) contains no information about species 2. Thus, to the extent that Eqs. (14.93) and (14.92a) are valid, the solid solubility  $x_1$  is independent of the identity of species 2.

(c) Denote the two solid phases by subscripts  $A$  and  $B$ . Then, by Eqs. (14.93) and (14.92a), the solubilities  $x_A$  and  $x_B$  are related by:

$$\frac{x_A}{x_B} = \exp \left[ \frac{\Delta H^{sl}(T_{m_B} - T_{m_A})}{RT_{m_A}T_{m_B}} \right]$$

where by assumption,  $\Delta H_A^{sl} = \Delta H_B^{sl} \equiv \Delta H^{sl}$

Accordingly,  $x_A/x_B > 1$  if and only if  $T_A < T_B$ , thus validating the rule of thumb.

(d) Identify the solid species as in Part (c). Then  $x_A$  and  $x_B$  are related by:

$$\frac{x_A}{x_B} = \exp \left[ \frac{(\Delta H_B^{sl} - \Delta H_A^{sl})(T_m - T)}{RT_m T} \right]$$

where by assumption,  $T_{m_A} = T_{m_B} \equiv T_m$

Notice that  $T_m > T$  (see Fig. 14.21b). Then  $x_A/x_B > 1$  if and only if  $\Delta H_A^{sl} < \Delta H_B^{sl}$ , in accord with the rule of thumb.

**14.34** The shape of the solubility curve is characterized in part by the behavior of the derivative  $dy_i/dP$  (constant  $T$ ). A general expression is found from Eq. (14.98),  $y_1 = P_1^{\text{sat}}P/F_1$ , where the enhancement factor  $F_1$  depends (at constant  $T$ ) on  $P$  and  $y_1$ . Thus,

$$\begin{aligned} \frac{dy_1}{dP} &= -\frac{P_1^{\text{sat}}}{P^2}F_1 + \frac{P_1^{\text{sat}}}{P} \left[ \left( \frac{\partial F_1}{\partial P} \right)_{y_1} + \left( \frac{\partial F_1}{\partial y_1} \right)_P \frac{dy_1}{dP} \right] \\ &= -\frac{y_1}{P} + y_1 \left[ \left( \frac{\partial \ln F_1}{\partial P} \right)_{y_1} + \left( \frac{\partial \ln F_1}{\partial y_1} \right)_P \frac{dy_1}{dP} \right] \end{aligned}$$

Whence,

$$\frac{dy_1}{dP} = \frac{y_1 \left[ \left( \frac{\partial \ln F_1}{\partial P} \right)_{y_1} - \frac{1}{P} \right]}{1 - y_1 \left( \frac{\partial \ln F_1}{\partial y_1} \right)_P} \quad (A)$$

This is a *general* result. An expression for  $F_1$  is given by Eq. (14.99):

$$F_1 \equiv \frac{\phi_1^{\text{sat}}}{\hat{\phi}_1} \exp \frac{V_1^s(P - P_1^{\text{sat}})}{RT}$$

From this, after some reduction:

$$\left( \frac{\partial \ln F_1}{\partial P} \right)_{y_1} = - \left( \frac{\partial \ln \hat{\phi}_1}{\partial P} \right)_{y_1} + \frac{V_1^s}{RT} \quad \text{and} \quad \left( \frac{\partial \ln F_1}{\partial y_1} \right)_P = - \left( \frac{\partial \ln \hat{\phi}_1}{\partial y_1} \right)_P$$

Whence, by Eq. (A),

$$\frac{dy_1}{dP} = \frac{y_1 \left[ - \left( \frac{\partial \ln \hat{\phi}_1}{\partial P} \right)_{y_1} + \frac{V_1^s}{RT} - \frac{1}{P} \right]}{1 + y_1 \left( \frac{\partial \ln \hat{\phi}_1}{\partial y_1} \right)_P} \quad (B)$$

This too is a *general* result. If the two-term virial equation in pressure applies, then  $\ln \hat{\phi}_1$  is given by Eq. (11.63a), from which:

$$\left(\frac{\partial \ln \hat{\phi}_1}{\partial P}\right)_{y_1} = \frac{1}{RT}(B_{11} + y_2^2 \delta_{12}) \quad \text{and} \quad \left(\frac{\partial \ln \hat{\phi}_1}{\partial y_1}\right)_P = -\frac{2y_2 \delta_{12} P}{RT}$$

Whence, by Eq. (B),

$$\frac{dy_1}{dP} = \frac{y_1 \left( \frac{V_1^s - B_{11} - y_2^2 \delta_{12}}{RT} - \frac{1}{P} \right)}{1 - \frac{2y_1 y_2 \delta_{12} P}{RT}}$$

The denominator of this equation is positive at any pressure level for which Eq. (3.38) is likely to be valid. Hence, the sign of  $dy_1/dP$  is determined by the sign of the group in parentheses. For very low pressures the  $1/P$  term dominates and  $dy_1/dP$  is negative. For very high pressures,  $1/P$  is small, and  $dy_1/dP$  can be positive. If this is the case, then  $dy_1/dP$  is zero for some intermediate pressure, and the solubility  $y_1$  exhibits a minimum with respect to pressure. Qualitatively, *these* features are consistent with the behavior illustrated by Fig. 14.23. However, the two-term virial equation is only valid for low to moderate pressures, and is unable to mimic the change in curvature and “flattening” of the  $y_1$  vs.  $P$  curve observed for high pressures for the naphthalene/ $\text{CO}_2$  system.

**14.35** (a) Rewrite the UNILAN equation:

$$n = \frac{m}{2s} [\ln(c + Pe^s) - \ln(c + Pe^{-s})] \quad (A)$$

As  $s \rightarrow 0$ , this expression becomes indeterminate. Application of l'Hôpital's rule gives:

$$\begin{aligned} \lim_{s \rightarrow 0} n &= \lim_{s \rightarrow 0} \frac{m}{2} \left( \frac{Pe^s}{c + Pe^s} + \frac{Pe^{-s}}{c + Pe^{-s}} \right) \\ &= \frac{m}{2} \left( \frac{P}{c + P} + \frac{P}{c + P} \right) \end{aligned}$$

or

$$\boxed{\lim_{s \rightarrow 0} n = \frac{mP}{c + P}}$$

which is the Langmuir isotherm.

(b) Henry's constant, by definition:  $k \equiv \lim_{P \rightarrow 0} \frac{dn}{dP}$

Differentiate Eq. (A):

$$\frac{dn}{dP} = \frac{m}{2s} \left( \frac{e^s}{c + Pe^s} - \frac{e^{-s}}{c + Pe^{-s}} \right)$$

Whence,  $k = \frac{m}{2s} \left( \frac{e^s}{c} - \frac{e^{-s}}{c} \right) = \frac{m}{cs} \left( \frac{e^s - e^{-s}}{2} \right)$  or  $\boxed{k = \frac{m}{cs} \sinh s}$

(c) All derivatives of  $n$  with respect to  $P$  are well-behaved in the zero-pressure limit:

$$\lim_{P \rightarrow 0} \frac{dn}{dP} = \frac{m}{cs} \sinh s$$

$$\lim_{P \rightarrow 0} \frac{d^2 n}{dP^2} = -\frac{m}{c^2 s} \sinh 2s$$

$$\lim_{P \rightarrow 0} \frac{d^3 n}{dP^3} = \frac{2m}{c^3 s} \sinh 3s$$

Etc.

Numerical studies show that the UNILAN equation, although providing excellent overall correlation of adsorption data at low-to-moderate surface coverage, tends to underestimate Henry's constant.

**14.36** Start with Eq. (14.109), written as:

$$\ln(P/n) = -\ln k + \int_0^n (z-1) \frac{dn}{n} + z - 1$$

With  $z = 1 + Bn + Cn^2 + \dots$ , this becomes:

$$\ln(P/n) = -\ln k + 2Bn + \frac{3}{2}Cn^2 + \dots$$

Thus a plot of  $\ln(P/n)$  vs.  $n$  produces  $-\ln k$  as the intercept and  $2B$  as the limiting slope (for  $n \rightarrow 0$ ). Alternatively, a polynomial curve fit of  $\ln(P/n)$  in  $n$  yields  $-\ln k$  and  $2B$  as the first two coefficients.

**14.37** For species  $i$  in a real-gas mixture, Eqs. (11.46) and (11.52) give:

$$\mu_i^g = \Gamma_i(T) + RT \ln y_i \hat{\phi}_i P$$

At constant temperature,

$$d\mu_i^g = RT d \ln y_i \hat{\phi}_i P$$

With  $d\mu_i = d\mu_i^g$ , Eq. (14.105) then becomes:

$$-\frac{a}{RT} d\Pi + d \ln P + \sum_i x_i d \ln y_i \hat{\phi}_i = 0 \quad (\text{const } T)$$

For *pure-gas* adsorption, this simplifies to:

$$\frac{a}{RT} d\Pi = d \ln P + d \ln \phi \quad (\text{const } T) \quad (A)$$

which is the real-gas analog of Eq. (14.107). On the left side of Eq. (A), introduce the adsorbate compressibility factor  $z$  through  $z \equiv \Pi a/RT = \Pi A/nRT$ :

$$\frac{a}{RT} d\Pi = dz + z \frac{dn}{n} \quad (B)$$

where  $n$  is moles adsorbed. On the right side of Eq. (A), make the substitution:

$$d \ln \phi = (Z-1) \frac{dP}{P} \quad (C)$$

which follows from Eq. (11.35). Combination of Eqs. (A), (B), and (C) gives on rearrangement (see Sec. 14.8):

$$d \ln \frac{n}{P} = (1-z) \frac{dn}{n} - dz + (Z-1) \frac{dP}{P}$$

which yields on integration and rearrangement:

$$n = kP \cdot \exp \int_0^P (Z-1) \frac{dP}{P} \cdot \exp \left[ \int_0^n (1-z) \frac{dn}{n} + 1 - z \right]$$

This equation is the real-gas analog of Eq. (14.109).

**14.39 & 14.40** Start with Eq. (14.109). With  $z = (1 - bm)^{-1}$ , one obtains the isotherm:

$$n = kP(1 - bn) \exp\left(-\frac{bn}{1 - bn}\right) \quad (A)$$

For  $bn$  sufficiently small, 
$$\exp\left(-\frac{bn}{1 - bn}\right) \approx 1 - \frac{bn}{1 - bn}$$

Whence, by Eq. (A),  $n \approx kP(1 - 2bn)$  or  $n \approx \frac{kP}{1 + 2bkP}$

which is the Langmuir isotherm.

With  $z = 1 + \beta n$ , the adsorption isotherm is:  $n = kP \exp(-2\beta n)$

from which, for  $\beta n$  sufficiently small, the Langmuir isotherm is again recovered.

**14.41** By Eq. (14.107) with  $a = A/n$ , 
$$\frac{Ad\Pi}{RT} = n \frac{dP}{P}$$

The definition of  $\psi$  and its derivative are:

$$\psi \equiv \frac{\Pi A}{RT} \quad \text{and} \quad d\psi = \frac{A d\Pi}{RT}$$

Whence, 
$$d\psi = n \frac{dP}{P} \quad (A)$$

By Eq. (14.128), the Raoult's law analogy,  $x_i = y_i P / P_i^\circ$ . Summation for given  $P$  yields:

$$\sum_i x_i = P \sum_i \frac{y_i}{P_i^\circ} \quad (B)$$

By general differentiation,

$$d \sum_i x_i = P d \sum_i \frac{y_i}{P_i^\circ} + \sum_i \frac{y_i}{P_i^\circ} dP \quad (C)$$

The equation,  $\sum_i x_i = 1$ , is an approximation that becomes increasingly accurate as the solution procedure converges. Thus, by rearrangement of Eq. (B),

$$\sum_i \frac{y_i}{P_i^\circ} = \frac{\sum_i x_i}{P} = \frac{1}{P}$$

With  $P$  fixed, Eq. (C) can now be written in the simple but approximate form:

$$d \sum_i x_i = \frac{dP}{P}$$

Equation (A) then becomes:

$$d\psi = n d \sum_i x_i \quad \text{or} \quad \delta\psi = n \delta \left( \sum_i x_i \right)$$

where we have replaced differentials by deviations. The deviation in  $\sum_i x_i$  is known, since the true value must be unity. Therefore,

$$\delta \sum_i x_i = P \sum_i \frac{y_i}{P_i^\circ} - 1$$

By Eq. (14.132),

$$n = \frac{1}{\sum_i (x_i/n_i^\circ)}$$

Combine the three preceding equations:

$$\delta\psi = \frac{P \sum_i \frac{y_i}{P_i^\circ} - 1}{\sum_i (x_i/n_i^\circ)}$$

When  $x_i = y_i P/P_i^\circ$ , the Raoult's law analogy, is substituted the required equation is reproduced:

$$\delta\psi = \frac{P \sum_i \frac{y_i}{P_i^\circ} - 1}{P \sum_i \frac{y_i}{P_i^\circ n_i^\circ}}$$

**14.42** Multiply the given equation for  $G^E/RT$  by  $n$  and convert all mole fractions to mole numbers:

$$\frac{nG^E}{RT} = A_{12} \frac{n_1 n_2}{n} + A_{13} \frac{n_1 n_3}{n} + A_{23} \frac{n_2 n_3}{n}$$

Apply Eq. (11.96) for  $i = 1$ :

$$\begin{aligned} \ln \gamma_1 &= A_{12} n_2 \left( \frac{1}{n} - \frac{n_1}{n^2} \right) + A_{13} n_3 \left( \frac{1}{n} - \frac{n_1}{n^2} \right) - A_{23} \frac{n_2 n_3}{n^2} \\ &= A_{12} x_2 (1 - x_1) + A_{13} x_3 (1 - x_1) - A_{23} x_2 x_3 \end{aligned}$$

Introduce solute-free mole fractions:

$$x'_2 \equiv \frac{x_2}{x_2 + x_3} = \frac{x_2}{1 - x_1} \quad \text{and} \quad x'_3 = \frac{x_3}{1 - x_1}$$

Whence,  $\ln \gamma_1 = A_{12} x'_2 (1 - x_1)^2 + A_{13} x'_3 (1 - x_1)^2 - A_{23} x'_2 x'_3 (1 - x_1)^2$

For  $x_1 \rightarrow 0$ ,  $\ln \gamma_1^\infty = A_{12} x'_2 + A_{13} x'_3 - A_{23} x'_2 x'_3$

Apply this equation to the special case of species 1 infinitely dilute in pure solvent 2. In this case,  $x'_2 = 1$ ,  $x'_3 = 0$ , and

$$\ln \gamma_{1,2}^\infty = A'_{12} \quad \text{Also} \quad \ln \gamma_{1,3}^\infty = A'_{13}$$

Whence,  $\ln \gamma_1^\infty = x'_2 \ln \gamma_{1,2}^\infty + x'_3 \ln \gamma_{1,3}^\infty - A_{23} x'_2 x'_3$

In logarithmic form the equation immediately following Eq. (14.24) on page 552 may be applied to the several infinite-dilution cases:

$$\ln \mathcal{H}_1 = \ln f_1 + \ln \gamma_1^\infty \quad \ln \mathcal{H}_{1,2} = \ln f_1 + \ln \gamma_{1,2}^\infty \quad \ln \mathcal{H}_{1,3} = \ln f_1 + \ln \gamma_{1,3}^\infty$$

Whence,  $\ln \mathcal{H}_1 - \ln f_1 = x'_2 (\ln \mathcal{H}_{1,2} - \ln f_1) + x'_3 (\ln \mathcal{H}_{1,3} - \ln f_1) - A_{23} x'_2 x'_3$

or

$$\ln \mathcal{H}_1 = x'_2 \ln \mathcal{H}_{1,2} + x'_3 \ln \mathcal{H}_{1,3} - A_{23} x'_2 x'_3$$

**14.43** For the situation described, Figure 14.12 would have *two* regions like the one shown from  $\alpha$  to  $\beta$ , probably one on either side of the minimum in curve II.

**14.44** By Eq. (14.136) with  $\bar{V}_2 = V_2$ : 
$$\frac{\Pi V_2}{RT} = -\ln(x_2\gamma_2)$$

Represent  $\ln \gamma_2$  by a Taylor series:

$$\ln \gamma_2 = \ln \gamma_2|_{x_1=0} + \left. \frac{d \ln \gamma_2}{dx_1} \right|_{x_1=0} x_1 + \frac{1}{2} \left. \frac{d^2 \ln \gamma_2}{dx_1^2} \right|_{x_1=0} x_1^2 + \dots$$

But at  $x_1 = 0$  ( $x_2 = 1$ ), both  $\ln \gamma_2$  and its first derivative are zero. Therefore,

$$\ln \gamma_2 = \frac{1}{2} \left( \left. \frac{d^2 \ln \gamma_2}{dx_1^2} \right)_{x_1=0} \right) x_1^2 + \dots$$

Also, 
$$\ln x_2 = \ln(1 - x_1) = -x_1 - \frac{x_1^2}{2} - \frac{x_1^3}{3} - \frac{x_1^4}{4} - \dots$$

Therefore, 
$$\ln(x_2\gamma_2) = +\ln x_2 + \ln \gamma_2 = -x_1 - \frac{1}{2} \left[ 1 - \frac{1}{2} \left( \left. \frac{d^2 \ln \gamma_2}{dx_1^2} \right)_{x_1=0} \right) \right] x_1^2 - \dots$$

and 
$$\frac{\Pi V_2}{x_1 RT} = 1 + \frac{1}{2} \left[ 1 - \frac{1}{2} \left( \left. \frac{d^2 \ln \gamma_2}{dx_1^2} \right)_{x_1=0} \right) \right] x_1 + \dots$$

Comparison with the given equation shows that: 
$$\mathcal{B} = \frac{1}{2} \left[ 1 - \frac{1}{2} \left( \left. \frac{d^2 \ln \gamma_2}{dx_1^2} \right)_{x_1=0} \right) \right]$$

**14.47** Equation (11.95) applies: 
$$\left( \frac{\partial(G^E/RT)}{\partial T} \right)_{P,x} = -\frac{H^E}{RT^2}$$

For the partially miscible system  $G^E/RT$  is necessarily "large," and if it is to decrease with increasing  $T$ , the derivative must be negative. This requires that  $H^E$  be positive.

**14.48** (a) In accord with Eqs. (14.1) and (14.2), 
$$y_i \frac{\hat{\phi}_i}{\phi_i^{\text{sat}}} P = x_i \gamma_i P_i^{\text{sat}} \implies K_i \equiv \frac{y_i}{x_i} = \frac{\gamma_i P_i^{\text{sat}}}{P} \cdot \frac{\phi_i^{\text{sat}}}{\hat{\phi}_i}$$

$$\alpha_{12} \equiv \frac{K_1}{K_2} = \frac{\gamma_1 P_1^{\text{sat}}}{\gamma_2 P_2^{\text{sat}}} \cdot \frac{\phi_1^{\text{sat}}}{\hat{\phi}_1} \cdot \frac{\hat{\phi}_2}{\phi_2^{\text{sat}}}$$

$$(b) \quad \alpha_{12}(x_1 = 0) = \frac{\gamma_1^\infty P_1^{\text{sat}}}{P_2^{\text{sat}}} \cdot \frac{\phi_1(P_1^{\text{sat}})}{\hat{\phi}_1^\infty(P_2^{\text{sat}})} \cdot \frac{\phi_2(P_2^{\text{sat}})}{\phi_2(P_2^{\text{sat}})} = \frac{\gamma_1^\infty P_1^{\text{sat}}}{P_2^{\text{sat}}} \cdot \frac{\phi_1(P_1^{\text{sat}})}{\hat{\phi}_1^\infty(P_2^{\text{sat}})}$$

$$\alpha_{12}(x_1 = 1) = \frac{P_1^{\text{sat}}}{\gamma_2^\infty P_2^{\text{sat}}} \cdot \frac{\phi_1(P_1^{\text{sat}})}{\phi_1(P_1^{\text{sat}})} \cdot \frac{\hat{\phi}_2^\infty(P_1^{\text{sat}})}{\phi_2(P_2^{\text{sat}})} = \frac{P_1^{\text{sat}}}{\gamma_2^\infty P_2^{\text{sat}}} \cdot \frac{\hat{\phi}_2^\infty(P_1^{\text{sat}})}{\phi_2(P_2^{\text{sat}})}$$

The final fractions represent corrections to modified Raoult's law for vapor nonidealities.



(c) If the vapor phase is an ideal solution of gases, then  $\hat{\phi}_i = \phi_i$  for all compositions.

**14.49** Equation (11.98) applies: 
$$\left(\frac{\partial \ln \gamma_i}{\partial T}\right)_{P,x} = -\frac{\bar{H}_i^E}{RT^2}$$

Assume that  $H^E$  and  $\bar{H}_i^E$  are functions of composition only. Then integration from  $T_k$  to  $T$  gives:

$$\ln \frac{\gamma_i(x, T)}{\gamma_i(x, T_k)} = \frac{\bar{H}_i^E}{R} \int_{T_k}^T \frac{dT}{T^2} = \frac{\bar{H}_i^E}{R} \left( \frac{1}{T} - \frac{1}{T_k} \right) = -\frac{\bar{H}_i^E}{RT} \left( \frac{T}{T_k} - 1 \right)$$

$$\boxed{\gamma_i(x, T) = \gamma_i(x, T_k) \cdot \exp \left[ -\frac{\bar{H}_i^E}{RT} \left( \frac{T}{T_k} - 1 \right) \right]}$$

**14.52** (a) From Table 11.1, p. 415, find: 
$$\left(\frac{\partial G^E}{\partial T}\right)_{P,x} = -S^E = 0 \quad \text{and} \quad G^E \text{ is independent of } T.$$

Therefore 
$$\frac{G^E}{RT} = \frac{F_R(x)}{RT}$$

(b) By Eq. (11.95), 
$$\left(\frac{\partial(G^E/RT)}{\partial T}\right)_{P,x} = -\frac{H^E}{RT^2} = 0 \quad \implies \quad \frac{G^E}{RT} = F_A(x)$$

(c) For solutions exhibiting LLE,  $G^E/RT$  is generally positive and large. Thus  $\alpha$  and  $\beta$  are positive for LLE. For symmetrical behavior, the magic number is  $A = 2$ :

$$A < 2 \quad \text{homogeneous}; \quad A = 2 \quad \text{consolute point}; \quad A > 2 \quad \text{LLE}$$

With respect to Eq. (A), increasing  $T$  makes  $G^E/RT$  smaller. thus, the consolute point is an *upper* consolute point. Its value follows from:

$$\frac{\alpha}{RT_U} = 2 \quad \implies \quad T_U = \frac{\alpha}{2R}$$

The shape of the solubility curve is as shown on Fig. 14.15.

**14.53** Why? Because they are both nontoxic, relatively inexpensive, and readily available. For  $\text{CO}_2$ , its  $T_c$  is near room temperature, making it a suitable solvent for temperature-sensitive materials. It is considerably more expensive than water, which is probably the cheapest possible solvent. However, both  $T_c$  and  $P_c$  for water are high, which increases heating and pumping costs.

## Chapter 16 - Section B - Non-Numerical Solutions

**16.1** The potential is displayed as follows. Note that  $K$  is used in place of  $k$  as a parameter to avoid confusion with Boltzmann's constant.

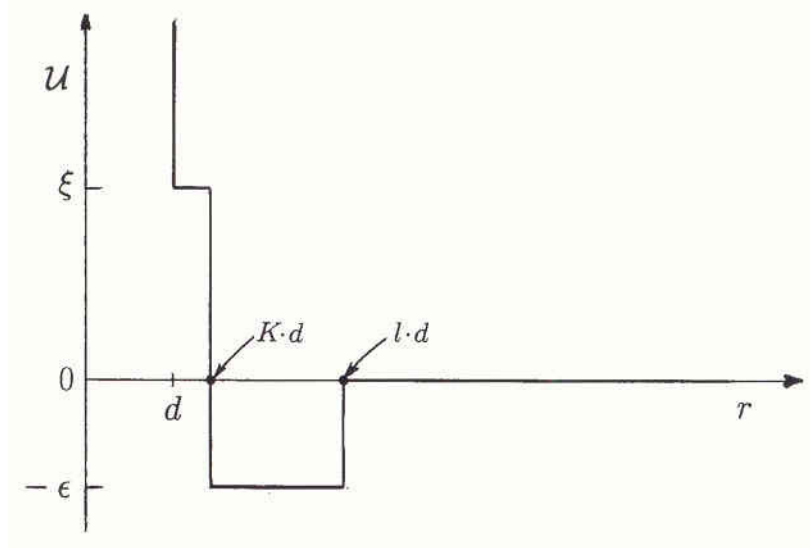

Combination of the potential with Eq. (16.10) yields on piecewise integration the following expression for  $B$ :

$$B = \frac{2}{3}\pi N_A d^3 \left[ 1 + (K^3 - 1)(1 - e^{-\xi/kT}) - (l^3 - K^3)(e^{\epsilon/kT} - 1) \right]$$

From this expression,  $\frac{dB}{dT} = \frac{1}{kT^2} [-(K^3 - 1)\xi e^{-\xi/kT} + (l^3 - K^3)\epsilon e^{\epsilon/kT}]$

according to which  $dB/dT = 0$  for  $T \propto \left( \frac{\epsilon + \xi}{\xi \frac{K^3 - 1}{\epsilon (l^3 - K^3)}} \right)$  and also for an intermediate temperature  $T_m$ :

$$T_m = \frac{\epsilon + \xi}{k \ln \frac{\xi}{\epsilon} \frac{K^3 - 1}{l^3 - K^3}}$$

That  $T_m$  corresponds to a *maximum* is readily shown by examination of the second derivative  $d^2B/dT^2$ .

**16.2** The table is shown below. Here, contributions to  $\mathcal{U}$  (long range) are found from Eq. (16.3) [for  $\mathcal{U}(\text{el})$ ], Eq. (16.4) [for  $\mathcal{U}(\text{ind})$ ], and Eq. (16.5) [for  $\mathcal{U}(\text{disp})$ ]. Note the following:

1. As also seen in Table 16.2, the *magnitude* of the dispersion interaction in all cases is substantial.
2.  $\mathcal{U}(\text{el})$ , hence  $f(\text{el})$ , is identically zero unless *both* species in a molecular pair have non-zero permanent dipole moments.
3. As seen for several of the examples, the *fractional* contribution of induction forces can be substantial for unlike molecular pairs. Roughly:  $f(\text{ind})$  is larger, the greater the difference in polarity of the interacting species.

Molecular Pair	$C_6/10^{-78} \text{ J m}^6$	$f(\text{el})$	$f(\text{ind})$	$f(\text{disp})$	$f(\text{el})/f(\text{disp})$
CH <sub>4</sub> /C <sub>7</sub> H <sub>16</sub>	49.8	0	0	1.000	0
CH <sub>4</sub> /CHCl <sub>3</sub>	34.3	0	0.008	0.992	0
CH <sub>4</sub> /(CH <sub>3</sub> ) <sub>2</sub> CO	24.9	0	0.088	0.912	0
CH <sub>4</sub> /CH <sub>3</sub> CN	22.1	0	0.188	0.812	0
C <sub>7</sub> H <sub>16</sub> /CHCl <sub>3</sub>	161.9	0	0.008	0.992	0
C <sub>7</sub> H <sub>16</sub> /(CH <sub>3</sub> ) <sub>2</sub> CO	119.1	0	0.096	0.904	0
C <sub>7</sub> H <sub>16</sub> /CH <sub>3</sub> CN	106.1	0	0.205	0.795	0
CHCl <sub>3</sub> /(CH <sub>3</sub> ) <sub>2</sub> CO	95.0	0.143	0.087	0.770	0.186
CHCl <sub>3</sub> /CH <sub>3</sub> CN	98.3	0.263	0.151	0.586	0.450
(CH <sub>3</sub> ) <sub>2</sub> CO/CH <sub>3</sub> CN	270.3	0.806	0.052	0.142	5.680

**16.3** Water (H<sub>2</sub>O), a highly polar hydrogen donor and acceptor, is the common species for all four systems; in all four cases, it experiences strong attractive interactions with the second species. Here, interactions between unlike molecular pairs are stronger than interactions between pairs of molecules of the same kind, and therefore  $\Delta H$  is negative. (See the discussion of signs for  $H^E$  in Sec. 16.7.)

**16.4** Of the eight potential combinations of signs, two are forbidden by Eq. (16.25). Suppose that  $H^E$  is negative and  $S^E$  is positive. Then, by Eq. (16.25),  $G^E$  must be negative: the sign combination  $G^E \oplus$ ,  $H^E \ominus$ , and  $S^E \oplus$  is outlawed. Similar reasoning shows that the combination  $G^E \ominus$ ,  $H^E \oplus$ , and  $S^E \ominus$  is inconsistent with Eq. (16.25). All other combinations are possible in principle.

**16.5** In Series A, hydrogen bonding occurs between the donor hydrogens of CH<sub>2</sub>Cl<sub>2</sub> and the electron-rich benzene molecule. In series B, a charge-transfer complex occurs between acetone and the aromatic benzene molecule. Neither cyclohexane nor *n*-hexane offers the opportunity for these special solvation interactions. Hence the mixtures containing benzene have more negative (smaller positive) values of  $H^E$  than those containing cyclohexane and *n*-hexane. (See Secs. 16.5 and 16.6.)

**16.6** (a) Acetone/cyclohexane is an NA/NP system; one expects  $G^E \oplus$ ,  $H^E \oplus$ , and  $S^E \oplus$ .

(b) Acetone/dichloromethane is a solvating NA/NA mixture. Here, without question, one will see  $G^E \ominus$ ,  $H^E \ominus$ , and  $S^E \ominus$ .

(c) Aniline/cyclohexane is an AS/NP mixture. Here, we expect either Region I or Region II behavior:  $G^E \oplus$  and  $H^E \oplus$ , with  $S^E \oplus$  or  $\ominus$ . [At 323 K (50°C), experiment shows that  $S^E$  is  $\oplus$  for this system.]

(d) Benzene/carbon disulfide is an NP/NP system. We therefore expect  $G^E \oplus$ ,  $H^E \oplus$ , and  $S^E \oplus$ .

(e) Benzene/*n*-hexane is NP/NP. Hence,  $G^E \oplus$ ,  $H^E \oplus$ , and  $S^E \oplus$ .

(f) Chloroform/1,4-dioxane is a solvating NA/NA mixture. Hence,  $G^E \ominus$ ,  $H^E \ominus$ , and  $S^E \ominus$ .

(g) Chloroform/*n*-hexane is NA/NP. Hence,  $G^E \oplus$ ,  $H^E \oplus$ , and  $S^E \oplus$ .

(h) Ethanol/*n*-nonane is an AS/NP mixture, and ethanol is a very strong associator. Hence, we expect Region II behavior:  $G^E \oplus$ ,  $H^E \oplus$ , and  $S^E \ominus$ .

**16.7** By definition,  $\delta_{ij} \equiv 2 \left[ B_{ij} - \frac{1}{2} (B_{ii} + B_{jj}) \right]$

At normal temperature levels, intermolecular attractions prevail, and the second virial coefficients are *negative*. (See Sec. 16.2 for a discussion of the connection between intermolecular forces and the second virial coefficient.) If interactions between unlike molecular pairs are weaker than interactions between pairs of molecules of the same kind,

$$|B_{ij}| < \frac{1}{2} |B_{ii} + B_{jj}|$$

and hence (since each  $B$  is *negative*)  $\delta_{ij} > 0$ . If unlike interactions are stronger than like interactions,

$$|B_{ij}| > \frac{1}{2}|B_{ii} + B_{jj}|$$

Hence  $\delta_{ij} < 0$ . For identical interactions of all molecular pairs,  $B_{ij} = B_{ii} = B_{jj}$ , and  $\delta_{ij} = 0$

The rationalizations of signs for  $H^E$  of binary liquid mixtures presented in Sec. 16.7 apply approximately to the signs of  $\delta_{12}$  for binary gas mixtures. Thus, positive  $\delta_{12}$  is the norm for NP/NP, NA/NP, and AS/NP mixtures, whereas  $\delta_{12}$  is usually negative for NA/NA mixtures comprising solvating species. One expects  $\delta_{12}$  to be essentially zero for ideal solutions of real gases, e.g., for binary gas mixtures of the isomeric xylenes.

**16.8** The magnitude of Henry's constant  $\mathcal{H}_i$  is reflected through Henry's law in the solubility of solute  $i$  in a liquid solvent: The smaller  $\mathcal{H}_i$ , the larger the solubility [see Eq. (10.4)]. Hence, molecular factors that influence solubility also influence  $\mathcal{H}_i$ . In the present case, the triple bond in acetylene and the double bond in ethylene act as proton acceptors for hydrogen-bond formation with the donor H in water, the triple bond being the stronger acceptor. No hydrogen bonds form between ethane and water. Because hydrogen-bond formation between unlike species promotes solubility through smaller values of  $G^E$  and  $\gamma_i$  than would otherwise obtain, the values of  $\mathcal{H}_i$  are in the observed order.

**16.9** By Eq. (6.70),  $\Delta H^{\alpha\beta} = T\Delta S^{\alpha\beta}$ . For the same temperature and pressure, less structure or order means larger  $S$ . Consequently,  $\Delta S^{sl}$ ,  $\Delta S^{lv}$ , and  $\Delta S^{sv}$  are all positive, and so therefore are  $\Delta H^{sl}$ ,  $\Delta H^{lv}$ , and  $\Delta H^{sv}$ .

**16.11** At the normal boiling point:  $\Delta H^{lv} \equiv H^v - H^l = (H^v - H^{ig}) - (H^l - H^{ig}) = H^{R,v} - H^{R,l}$

Therefore  $H^{R,l} = H^{R,v} - \Delta H^{lv}$

At 1(atm),  $H^{R,v}$  should be negligible relative to  $\Delta H^{lv}$ . Then  $H^{R,l} \approx -\Delta H^{lv}$ . Because the normal boiling point is a representative  $T$  for typical liquid behavior, and because  $H^R$  reflects intermolecular forces,  $\Delta H^{lv}$  has the stated feature.  $\Delta H^{lv}(\text{H}_2\text{O})$  is much larger than  $\Delta H^{lv}(\text{CH}_4)$  because of the strong hydrogen bonding in liquid water.

**16.12** By definition, write  $C_p^l = C_p^{ig} + C_p^{R,l}$ , where  $C_p^{R,l}$  is the residual heat capacity for the liquid phase. Also by definition,  $C_p^{R,l} = (\partial H^{R,l} / \partial T)_p$ . By assumption (modest pressure levels)  $C_p^{ig} \approx C_p^v$ .

Thus,

$$C_p^l \approx C_p^v + \left( \frac{\partial H^{R,l}}{\partial T} \right)_p$$

For liquids,  $H^{R,l}$  is highly negative, becoming less so as  $T$  increases, owing to diminution of intermolecular forces (see, e.g., Fig. 6.5 or Tables E.5 and E.6). Thus  $C_p^{R,l}$  is *positive*, and  $C_p^l > C_p^v$ .

**16.13** The ideal-gas equation may be written:  $V^t = \frac{nRT}{P} = \frac{N}{N_A} \cdot \frac{RT}{P} \implies \frac{V^t}{N} = \frac{RT}{N_A P}$

The quantity  $V^t/N$  is the average volume available to a particle, and the average *length* available is about:

$$\left( \frac{V^t}{N} \right)^{1/3} = \left( \frac{RT}{N_A P} \right)^{1/3}$$

$$\left( \frac{V^t}{N} \right)^{1/3} = \left( \frac{83.14 \text{ cm}^3 \text{ bar mol}^{-1} \text{ K}^{-1} \times 300 \text{ K}}{6.023 \times 10^{23} \text{ mol}^{-1} \times 1 \text{ bar} \times 10^6 \text{ cm}^3 \text{ m}^{-3}} \right)^{1/3} = 34.6 \times 10^{-10} \text{ m} \quad \text{or} \quad 34.6 \text{ \AA}$$

For argon, this is about 10 diameters. See comments on p. 649 with respect to separations at which attractions become negligible.