



Stephen Prata

Sixth Edition

# C++ Primer Plus

**Developer's Library**



# C++ Primer Plus

---

Sixth Edition

برای دریافت جزوات، نمونه سوالات و کتب بیشتر به ما  
پیوندید در

[https://t.me/iust\\_scientific](https://t.me/iust_scientific)

# Developer's Library

## ESSENTIAL REFERENCES FOR PROGRAMMING PROFESSIONALS

*Developer's Library* books are designed to provide practicing programmers with unique, high-quality references and tutorials on the programming languages and technologies they use in their daily work.

All books in the *Developer's Library* are written by expert technology practitioners who are especially skilled at organizing and presenting information in a way that's useful for other programmers.

Key titles include some of the best, most widely acclaimed books within their topic areas:

*PHP & MySQL Web Development*

Luke Welling & Laura Thomson  
ISBN-13: 978-0-672-32916-6

*MySQL*

Paul DuBois  
ISBN-13: 978-0-672-32938-8

*Linux Kernel Development*

Robert Love  
ISBN-13: 978-0-672-32946-3

*Python Essential Reference*

David Beazley  
ISBN-13: 978-0-672-32862-6

*PostgreSQL*

Korry Douglas  
ISBN-13: 978-0-672-32756-8

*C++ Primer Plus*

Stephen Prata  
ISBN-13: 978-0-321-77640-2

Developer's Library books are available at most retail and online bookstores, as well as by subscription from Safari Books Online at **safari.informit.com**.

**Developer's  
Library**

[informit.com/devlibrary](http://informit.com/devlibrary)

# C++ Primer Plus

---

Sixth Edition

Stephen Prata

◆ Addison-Wesley

Upper Saddle River, NJ • Boston • Indianapolis • San Francisco  
New York • Toronto • Montreal • London • Munich • Paris • Madrid  
Cape Town • Sydney • Tokyo • Singapore • Mexico City

Many of the designations used by manufacturers and sellers to distinguish their products are claimed as trademarks. Where those designations appear in this book, and the publisher was aware of a trademark claim, the designations have been printed with initial capital letters or in all capitals.

The author and publisher have taken care in the preparation of this book, but make no expressed or implied warranty of any kind and assume no responsibility for errors or omissions. No liability is assumed for incidental or consequential damages in connection with or arising out of the use of the information or programs contained herein.

The publisher offers excellent discounts on this book when ordered in quantity for bulk purchases or special sales, which may include electronic versions and/or custom covers and content particular to your business, training goals, marketing focus, and branding interests. For more information, please contact:

**U.S. Corporate and Government Sales**  
**(800) 382-3419**  
**corpsales@pearsontechgroup.com**

For sales outside the United States, please contact:

**International Sales**  
**international@pearson.com**

Visit us on the Web: [informit.com/aw](http://informit.com/aw).

*Library of Congress Cataloging-in-Publication data is on file.*

Copyright © 2012 Pearson Education, Inc.

All rights reserved. Printed in the United States of America. This publication is protected by copyright, and permission must be obtained from the publisher prior to any prohibited reproduction, storage in a retrieval system, or transmission in any form or by any means, electronic, mechanical, photocopying, recording, or likewise. To obtain permission to use material from this work, please submit a written request to Pearson Education, Inc., Permissions Department, One Lake Street, Upper Saddle River, New Jersey 07458, or you may fax your request to (201) 236-3290.

ISBN-13: 978-0-321-77640-2

ISBN-10: 0-321-77640-2

Text printed in the United States on recycled paper at R.R. Donnelley in Crawfordsville, Indiana.

Second printing: January 2012

Acquisitions Editor  
Mark Taber

Development  
Editor  
Michael Thurston

Managing Editor  
Kristy Hart

Project Editors  
Samantha  
Sinkhorn

Jovana Shirley

Copy Editor  
Bart Reed

Indexer  
Lisa Stumpf

Proofreader  
Language  
Logistics, LLC

Technical Reviewer  
David Horvath

Publishing  
Coordinator  
Vanessa Evans

Cover Designer  
Gary Adair

Compositor  
Nonie Ratcliff



*To my parents, with love.*



# Contents at a Glance

Introduction	1
1 Getting Started with C++	9
2 Setting Out to C++	27
3 Dealing with Data	65
4 Compound Types	115
5 Loops and Relational Expressions	195
6 Branching Statements and Logical Operators	253
7 Functions: C++'s Programming Modules	305
8 Adventures in Functions	379
9 Memory Models and Namespaces	447
10 Objects and Classes	505
11 Working with Classes	563
12 Classes and Dynamic Memory Allocation	627
13 Class Inheritance	707
14 Reusing Code in C++	785
15 Friends, Exceptions, and More	877
16 The <code>string</code> Class and the Standard Template Library	951
17 Input, Output, and Files	1061
18 Visiting with the New C++ Standard	1153

## **Appendixes**

- A Number Bases 1215**
- B C++ Reserved Words 1221**
- C The ASCII Character Set 1225**
- D Operator Precedence 1231**
- E Other Operators 1235**
- F The `string` Template Class 1249**
- G The Standard Template Library Methods and Functions 1271**
- H Selected Readings and Internet Resources 1323**
- I Converting to ISO Standard C++ 1327**
- J Answers to Chapter Reviews 1335**
  
- Index 1367**



# Table of Contents

## Introduction 1

### 1 Getting Started with C++ 9

- Learning C++: What Lies Before You 10
- The Origins of C++: A Little History 10
- Portability and Standards 15
- The Mechanics of Creating a Program 18
- Summary 25

### 2 Setting Out to C++ 27

- C++ Initiation 27
- C++ Statements 41
- More C++ Statements 45
- Functions 48
- Summary 61
- Chapter Review 62
- Programming Exercises 62

### 3 Dealing with Data 65

- Simple Variables 66
- The `const` Qualifier 90
- Floating-Point Numbers 92
- C++ Arithmetic Operators 97
- Summary 109
- Chapter Review 110
- Programming Exercises 111

### 4 Compound Types 115

- Introducing Arrays 116
- Strings 120
- Introducing the `string` Class 131
- Introducing Structures 140
- Unions 149
- Enumerations 150
- Pointers and the Free Store 153
- Pointers, Arrays, and Pointer Arithmetic 167
- Combinations of Types 184
- Array Alternatives 186
- Summary 190
- Chapter Review 191
- Programming Exercises 192

**5 Loops and Relational Expressions 195**

- Introducing `for` Loops 196
- The `while` Loop 224
- The `do while` Loop 231
- The Range-Based `for` Loop (C++11) 233
- Loops and Text Input 234
- Nested Loops and Two-Dimensional Arrays 244
- Summary 249
- Chapter Review 250
- Programming Exercises 251

**6 Branching Statements and Logical Operators 253**

- The `if` Statement 254
- Logical Expressions 260
- The `cctype` Library of Character Functions 270
- The `?:` Operator 273
- The `switch` Statement 274
- The `break` and `continue` Statements 280
- Number-Reading Loops 283
- Simple File Input/Output 287
- Summary 298
- Chapter Review 298
- Programming Exercises 301

**7 Functions: C++'s Programming Modules 305**

- Function Review 306
- Function Arguments and Passing by Value 313
- Functions and Arrays 320
- Functions and Two-Dimensional Arrays 337
- Functions and C-Style Strings 339
- Functions and Structures 343
- Functions and `string` Class Objects 353
- Functions and `array` Objects 355
- Recursion 357
- Pointers to Functions 361
- Summary 371
- Chapter Review 372
- Programming Exercises 374

**8 Adventures in Functions 379**

- C++ Inline Functions 379
- Reference Variables 383
- Default Arguments 409
- Function Overloading 412
- Function Templates 419

Summary	442
Chapter Review	443
Programming Exercises	444
<b>9 Memory Models and Namespaces</b>	<b>447</b>
Separate Compilation	447
Storage Duration, Scope, and Linkage	453
Namespaces	482
Summary	497
Chapter Review	498
Programming Exercises	501
<b>10 Objects and Classes</b>	<b>505</b>
Procedural and Object-Oriented Programming	506
Abstraction and Classes	507
Class Constructors and Destructors	524
Knowing Your Objects: The <code>this</code> Pointer	539
An Array of Objects	546
Class Scope	549
Abstract Data Types	552
Summary	557
Chapter Review	558
Programming Exercises	559
<b>11 Working with Classes</b>	<b>563</b>
Operator Overloading	564
Time on Our Hands: Developing an Operator	
Overloading Example	565
Introducing Friends	578
Overloaded Operators: Member Versus Nonmember Functions	587
More Overloading: A Vector Class	588
Automatic Conversions and Type Casts for Classes	606
Summary	621
Chapter Review	623
Programming Exercises	623
<b>12 Classes and Dynamic Memory Allocation</b>	<b>627</b>
Dynamic Memory and Classes	628
The New, Improved <code>String</code> Class	647
Things to Remember When Using <code>new</code> in Constructors	659
Observations About Returning Objects	662
Using Pointers to Objects	665
Reviewing Techniques	676
A Queue Simulation	678

Summary 699  
Chapter Review 700  
Programming Exercises 702

### **13 Class Inheritance 707**

Beginning with a Simple Base Class 708  
Inheritance: An *Is-a* Relationship 720  
Polymorphic Public Inheritance 722  
Static and Dynamic Binding 737  
Access Control: `protected` 745  
Abstract Base Classes 746  
Inheritance and Dynamic Memory Allocation 757  
Class Design Review 766  
Summary 778  
Chapter Review 779  
Programming Exercises 780

### **14 Reusing Code in C++ 785**

Classes with Object Members 786  
Private Inheritance 797  
Multiple Inheritance 808  
Class Templates 830  
Summary 866  
Chapter Review 869  
Programming Exercises 871

### **15 Friends, Exceptions, and More 877**

Friends 877  
Nested Classes 889  
Exceptions 896  
Runtime Type Identification 933  
Type Cast Operators 943  
Summary 947  
Chapter Review 947  
Programming Exercises 949

### **16 The `string` Class and the Standard Template Library 951**

The `string` Class 952  
Smart Pointer Template Classes 968  
The Standard Template Library 978  
Generic Programming 992  
Function Objects (a.k.a. Functors) 1026  
Algorithms 1035  
Other Libraries 1045

Summary	1054
Chapter Review	1056
Programming Exercises	1057
<b>17 Input, Output, and Files</b>	<b>1061</b>
An Overview of C++ Input and Output	1062
Output with <code>cout</code>	1069
Input with <code>cin</code>	1093
File Input and Output	1114
Incore Formatting	1142
Summary	1145
Chapter Review	1146
Programming Exercises	1148
<b>18 Visiting with the New C++ Standard</b>	<b>1153</b>
C++11 Features Revisited	1153
Move Semantics and the Rvalue Reference	1164
New Class Features	1178
Lambda Functions	1184
Wrappers	1191
Variadic Templates	1197
More C++11 Features	1202
Language Change	1205
What Now?	1207
Summary	1208
Chapter Review	1209
Programming Exercises	1212
<b>Appendixes</b>	
<b>A Number Bases</b>	<b>1215</b>
<b>B C++ Reserved Words</b>	<b>1221</b>
<b>C The ASCII Character Set</b>	<b>1225</b>
<b>D Operator Precedence</b>	<b>1231</b>
<b>E Other Operators</b>	<b>1235</b>
<b>F The <code>string</code> Template Class</b>	<b>1249</b>
<b>G The Standard Template Library Methods and Functions</b>	<b>1271</b>
<b>H Selected Readings and Internet Resources</b>	<b>1323</b>
<b>I Converting to ISO Standard C++</b>	<b>1327</b>
<b>J Answers to Chapter Reviews</b>	<b>1335</b>
<b>Index</b>	<b>1367</b>

# Acknowledgments

## Acknowledgments for the Sixth Edition

I'd like to thank Mark Taber and Samantha Sinkhorn of Pearson for guiding and managing this project and David Horvath for providing technical review and editing.

## Acknowledgments for the Fifth Edition

I'd like to thank Loretta Yates and Songlin Qiu of Sams Publishing for guiding and managing this project. Thanks to my colleague Fred Schmitt for several useful suggestions. Once again, I'd like to thank Ron Liechty of Metrowerks for his helpfulness.

## Acknowledgments for the Fourth Edition

Several editors from Pearson and from Sams helped originate and maintain this project; thanks to Linda Sharp, Karen Wachs, and Laurie McGuire. Thanks, too, to Michael Maddox, Bill Craun, Chris Maunder, and Phillippe Bruno for providing technical review and editing. And thanks again to Michael Maddox and Bill Craun for supplying the material for the Real World Notes. Finally, I'd like to thank Ron Liechty of Metrowerks and Greg Comeau of Comeau Computing for their aid with C++ compilers.

## Acknowledgments for the Third Edition

I'd like to thank the editors from Macmillan and The Waite Group for the roles they played in putting this book together: Tracy Dunkelberger, Susan Walton, and Andrea Rosenberg. Thanks, too, to Russ Jacobs for his content and technical editing. From Metrowerks, I'd like to thank Dave Mark, Alex Harper, and especially Ron Liechty, for their help and cooperation.

## Acknowledgments for the Second Edition

I'd like to thank Mitchell Waite and Scott Calamar for supporting a second edition and Joel Fugazzotto and Joanne Miller for guiding the project to completion. Thanks to Michael Marcotty of Metrowerks for dealing with my questions about their beta version CodeWarrior compiler. I'd also like to thank the following instructors for taking the time to give us feedback on the first edition: Jeff Buckwalter, Earl Brynner, Mike Holland, Andy Yao, Larry Sanders, Shahin Momtazi, and Don Stephens. Finally, I wish to thank Heidi Brumbaugh for her helpful content editing of new and revised material.

## Acknowledgments for the First Edition

Many people have contributed to this book. In particular, I wish to thank Mitch Waite for his work in developing, shaping, and reshaping this book, and for reviewing the manuscript. I appreciate Harry Henderson's work in reviewing the last few chapters and in

testing programs with the Zortech C++ compiler. Thanks to David Gerrold for reviewing the entire manuscript and for championing the needs of less-experienced readers. Also thanks to Hank Shiffman for testing programs using Sun C++ and to Kent Williams for testing programs with AT&T cfront and with G++. Thanks to Nan Borreson of Borland International for her responsive and cheerful assistance with Turbo C++ and Borland C++. Thank you, Ruth Myers and Christine Bush, for handling the relentless paper flow involved with this kind of project. Finally, thanks to Scott Calamar for keeping everything on track.

## About the Author

**Stephen Prata** taught astronomy, physics, and computer science at the College of Marin in Kentfield, California. He received his B.S. from the California Institute of Technology and his Ph.D. from the University of California, Berkeley. He has authored or coauthored more than a dozen books on programming topics including *New C Primer Plus*, which received the Computer Press Association's 1990 Best How-to Computer Book Award, and *C++ Primer Plus*, nominated for the Computer Press Association's Best How-to Computer Book Award in 1991.

## We Want to Hear from You!

As the reader of this book, *you* are our most important critic and commentator. We value your opinion and want to know what we're doing right, what we could do better, what areas you'd like to see us publish in, and any other words of wisdom you're willing to pass our way.

You can email or write directly to let us know what you did or didn't like about this book—as well as what we can do to make our books stronger.

*Please note that we cannot help you with technical problems related to the topic of this book, and that due to the high volume of mail we receive, we might not be able to reply to every message.*

When you write, please be sure to include this book's title and author as well as your name, email address, and phone number.

Email:        feedback@developers-library.info  
Mail:         Reader Feedback  
               Addison-Wesley Developer's Library  
               800 East 96th Street  
               Indianapolis, IN 46240 USA

## Reader Services

Visit our website and register this book at [www.informit.com/register](http://www.informit.com/register) for convenient access to any updates, downloads, or errata that might be available for this book.

# Introduction

Learning C++ is an adventure of discovery, particularly because the language accommodates several programming paradigms, including object-oriented programming, generic programming, and the traditional procedural programming. The fifth edition of this book described the language as set forth in the ISO C++ standards, informally known as C++99 and C++03, or, sometimes as C++99/03. (The 2003 version was largely a technical correction to the 1999 standard and didn't add any new features.) Since then, C++ continues to evolve. As this book is written, the international C++ Standards Committee has just approved a new version of the standard. This standard had the informal name of C++0x while in development, and now it will be known as C++11. Most contemporary compilers support C++99/03 quite well, and most of the examples in this book comply with that standard. But many features of the new standard already have appeared in some implementations, and this edition of *C++ Primer Plus* explores these new features.

*C++ Primer Plus* discusses the basic C language and presents C++ features, making this book self-contained. It presents C++ fundamentals and illustrates them with short, to-the-point programs that are easy to copy and experiment with. You learn about input/output (I/O), how to make programs perform repetitive tasks and make choices, the many ways to handle data, and how to use functions. You learn about the many features C++ has added to C, including the following:

- Classes and objects
- Inheritance
- Polymorphism, virtual functions, and runtime type identification (RTTI)
- Function overloading
- Reference variables
- Generic, or type-independent, programming, as provided by templates and the Standard Template Library (STL)
- The exception mechanism for handling error conditions
- Namespaces for managing names of functions, classes, and variables



## The Primer Approach

*C++ Primer Plus* brings several virtues to the task of presenting all this material. It builds on the primer tradition begun by *C Primer Plus* nearly two decades ago and embraces its successful philosophy:

- A primer should be an easy-to-use, friendly guide.
- A primer doesn't assume that you are already familiar with all relevant programming concepts.
- A primer emphasizes hands-on learning with brief, easily typed examples that develop your understanding, a concept or two at a time.
- A primer clarifies concepts with illustrations.
- A primer provides questions and exercises to let you test your understanding, making the book suitable for self-learning or for the classroom.

Following these principles, the book helps you understand this rich language and how to use it. For example

- It provides conceptual guidance about when to use particular features, such as using public inheritance to model what are known as *is-a* relationships.
- It illustrates common C++ programming idioms and techniques.
- It provides a variety of sidebars, including tips, cautions and notes.

The author and editors of this book do our best to keep the presentation to-the-point, simple, and fun. Our goal is that by the end of the book, you'll be able to write solid, effective programs and enjoy yourself doing so.

## Sample Code Used in This Book

This book provides an abundance of sample code, most of it in the form of complete programs. Like the previous editions, this book practices generic C++ so that it is not tied to any particular kind of computer, operating system, or compiler. Thus, the examples were tested on a Windows 7 system, a Macintosh OS X system, and a Linux system. Those programs using C++11 features require compilers supporting those features, but the remaining programs should work with any C++99/03-compliant system.

The sample code for the complete programs described in this book is available on this book's website. See the registration link given on the back cover for more information.

## How This Book Is Organized

This book is divided into 18 chapters and 10 appendixes, summarized here:

- **Chapter 1: Getting Started with C++**—Chapter 1 relates how Bjarne Stroustrup created the C++ programming language by adding object-oriented programming

support to the C language. You'll learn the distinctions between procedural languages, such as C, and object-oriented languages, such as C++. You'll read about the joint ANSI/ISO work to develop a C++ standard. This chapter discusses the mechanics of creating a C++ program, outlining the approach for several current C++ compilers. Finally, it describes the conventions used in this book.

- **Chapter 2: Setting Out to C++**—Chapter 2 guides you through the process of creating simple C++ programs. You'll learn about the role of the `main()` function and about some of the kinds of statements that C++ programs use. You'll use the predefined `cout` and `cin` objects for program output and input, and you'll learn about creating and using variables. Finally, you'll be introduced to functions, C++'s programming modules.
- **Chapter 3: Dealing with Data**—C++ provides built-in types for storing two kinds of data: integers (numbers with no fractional parts) and floating-point numbers (numbers with fractional parts). To meet the diverse requirements of programmers, C++ offers several types in each category. Chapter 3 discusses those types, including creating variables and writing constants of various types. You'll also learn how C++ handles implicit and explicit conversions from one type to another.
- **Chapter 4: Compound Types**—C++ lets you construct more elaborate types from the basic built-in types. The most advanced form is the class, discussed in Chapters 9 through 13. Chapter 4 discusses other forms, including arrays, which hold several values of a single type; structures, which hold several values of unlike types; and pointers, which identify locations in memory. You'll also learn how to create and store text strings and to handle text I/O by using C-style character arrays and the C++ `string` class. Finally, you'll learn some of the ways C++ handles memory allocation, including using the `new` and `delete` operators for managing memory explicitly.
- **Chapter 5: Loops and Relational Expressions**—Programs often must perform repetitive actions, and C++ provides three looping structures for that purpose: the `for` loop, the `while` loop, and the `do while` loop. Such loops must know when they should terminate, and the C++ relational operators enable you to create tests to guide such loops. In Chapter 5 you learn how to create loops that read and process input character-by-character. Finally, you'll learn how to create two-dimensional arrays and how to use nested loops to process them.
- **Chapter 6: Branching Statements and Logical Operators**—Programs can behave intelligently if they can tailor their behavior to circumstances. In Chapter 6 you'll learn how to control program flow by using the `if`, `if else`, and `switch` statements and the conditional operator. You'll learn how to use logical operators to help express decision-making tests. Also, you'll meet the `cctype` library of functions for evaluating character relations, such as testing whether a character is a digit or a nonprinting character. Finally, you'll get an introductory view of file I/O.

- **Chapter 7: Functions: C++'s Programming Modules**—Functions are the basic building blocks of C++ programming. Chapter 7 concentrates on features that C++ functions share with C functions. In particular, you'll review the general format of a function definition and examine how function prototypes increase the reliability of programs. Also, you'll investigate how to write functions to process arrays, character strings, and structures. Next, you'll learn about recursion, which is when a function calls itself, and see how it can be used to implement a divide-and-conquer strategy. Finally, you'll meet pointers to functions, which enable you to use a function argument to tell one function to use a second function.
- **Chapter 8: Adventures in Functions**—Chapter 8 explores the new features C++ adds to functions. You'll learn about inline functions, which can speed program execution at the cost of additional program size. You'll work with reference variables, which provide an alternative way to pass information to functions. Default arguments let a function automatically supply values for function arguments that you omit from a function call. Function overloading lets you create functions having the same name but taking different argument lists. All these features have frequent use in class design. Also you'll learn about function templates, which allow you to specify the design of a family of related functions.
- **Chapter 9: Memory Models and Namespaces**—Chapter 9 discusses putting together multifile programs. It examines the choices in allocating memory, looking at different methods of managing memory and at scope, linkage, and namespaces, which determine what parts of a program know about a variable.
- **Chapter 10: Objects and Classes**—A class is a user-defined type, and an object (such as a variable) is an instance of a class. Chapter 10 introduces you to object-oriented programming and to class design. A class declaration describes the information stored in a class object and also the operations (class methods) allowed for class objects. Some parts of an object are visible to the outside world (the public portion), and some are hidden (the private portion). Special class methods (constructors and destructors) come into play when objects are created and destroyed. You will learn about all this and other class details in this chapter, and you'll see how classes can be used to implement ADTs, such as a stack.
- **Chapter 11: Working with Classes**—In Chapter 11 you'll further your understanding of classes. First, you'll learn about operator overloading, which lets you define how operators such as + will work with class objects. You'll learn about friend functions, which can access class data that's inaccessible to the world at large. You'll see how certain constructors and overloaded operator member functions can be used to manage conversion to and from class types.
- **Chapter 12: Classes and Dynamic Memory Allocation**—Often it's useful to have a class member point to dynamically allocated memory. If you use `new` in a class constructor to allocate dynamic memory, you incur the responsibilities of providing an appropriate destructor, of defining an explicit copy constructor, and of

defining an explicit assignment operator. Chapter 12 shows you how and discusses the behavior of the member functions generated implicitly if you fail to provide explicit definitions. You'll also expand your experience with classes by using pointers to objects and studying a queue simulation problem.

- **Chapter 13: Class Inheritance**—One of the most powerful features of object-oriented programming is inheritance, by which a derived class inherits the features of a base class, enabling you to reuse the base class code. Chapter 13 discusses public inheritance, which models *is-a* relationships, meaning that a derived object is a special case of a base object. For example, a physicist is a special case of a scientist. Some inheritance relationships are polymorphic, meaning you can write code using a mixture of related classes for which the same method name may invoke behavior that depends on the object type. Implementing this kind of behavior necessitates using a new kind of member function called a virtual function. Sometimes using abstract base classes is the best approach to inheritance relationships. This chapter discusses these matters, pointing out when public inheritance is appropriate and when it is not.
- **Chapter 14: Reusing Code in C++**—Public inheritance is just one way to reuse code. Chapter 14 looks at several other ways. Containment is when one class contains members that are objects of another class. It can be used to model *has-a* relationships, in which one class has components of another class. For example, an automobile has a motor. You also can use private and protected inheritance to model such relationships. This chapter shows you how and points out the differences among the different approaches. Also, you'll learn about class templates, which let you define a class in terms of some unspecified generic type, and then use the template to create specific classes in terms of specific types. For example, a stack template enables you to create a stack of integers or a stack of strings. Finally, you'll learn about multiple public inheritance, whereby a class can derive from more than one class.
- **Chapter 15: Friends, Exceptions, and More**—Chapter 15 extends the discussion of friends to include friend classes and friend member functions. Then it presents several new developments in C++, beginning with exceptions, which provide a mechanism for dealing with unusual program occurrences, such as inappropriate function argument values and running out of memory. Then you'll learn about RTTI, a mechanism for identifying object types. Finally, you'll learn about the safer alternatives to unrestricted typecasting.
- **Chapter 16: The `string` Class and the Standard Template Library**—Chapter 16 discusses some useful class libraries recently added to the language. The `string` class is a convenient and powerful alternative to traditional C-style strings. The `auto_ptr` class helps manage dynamically allocated memory. The STL provides several generic containers, including template representations of arrays, queues, lists, sets, and maps. It also provides an efficient library of generic algorithms that can be used with STL

containers and also with ordinary arrays. The `valarray` template class provides support for numeric arrays.

- **Chapter 17: Input, Output, and Files**—Chapter 17 reviews C++ I/O and discusses how to format output. You'll learn how to use class methods to determine the state of an input or output stream and to see, for example, whether there has been a type mismatch on input or whether the end-of-file has been detected. C++ uses inheritance to derive classes for managing file input and output. You'll learn how to open files for input and output, how to append data to a file, how to use binary files, and how to get random access to a file. Finally, you'll learn how to apply standard I/O methods to read from and write to strings.
- **Chapter 18: Visiting with the New C++ Standard**—Chapter 18 begins by reviewing several C++11 features introduced in earlier chapters, including new types, uniform initialization syntax, automatic type deduction, new smart pointers, and scoped enumerations. The chapter then discusses the new `rvalue` reference type and how it's used to implement a new feature called *move semantics*. Next, the chapter covers new class features, lambda expressions, and variadic templates. Finally, the chapter outlines many new features not covered in earlier chapters of the book.
- **Appendix A: Number Bases**—Appendix A discusses octal, hexadecimal, and binary numbers.
- **Appendix B: C++ Reserved Words**—Appendix B lists C++ keywords.
- **Appendix C: The ASCII Character Set**—Appendix C lists the ASCII character set, along with decimal, octal, hexadecimal, and binary representations.
- **Appendix D: Operator Precedence**—Appendix D lists the C++ operators in order of decreasing precedence.
- **Appendix E: Other Operators**—Appendix E summarizes the C++ operators, such as the bitwise operators, not covered in the main body of the text.
- **Appendix F: The `string` Template Class**—Appendix F summarizes `string` class methods and functions.
- **Appendix G: The Standard Template Library Methods and Functions**—Appendix G summarizes the STL container methods and the general STL algorithm functions.
- **Appendix H: Selected Readings and Internet Resources**—Appendix H lists some books that can further your understanding of C++.
- **Appendix I: Converting to ISO Standard C++**—Appendix I provides guidelines for moving from C and older C++ implementations to ANSI/ISO C++.
- **Appendix J: Answers to Chapter Review**—Appendix J contains the answers to the review questions posed at the end of each chapter.

## Note to Instructors

One of the goals of this edition of *C++ Primer Plus* is to provide a book that can be used as either a teach-yourself book or as a textbook. Here are some of the features that support using *C++ Primer Plus*, Sixth Edition, as a textbook:

- This book describes generic C++, so it isn't dependent on a particular implementation.
- The contents track the ISO/ANSI C++ standards committee's work and include discussions of templates, the STL, the `string` class, exceptions, RTTI, and namespaces.
- It doesn't assume prior knowledge of C, so it can be used without a C prerequisite. (Some programming background is desirable, however.)
- Topics are arranged so that the early chapters can be covered rapidly as review chapters for courses that do have a C prerequisite.
- Chapters include review questions and programming exercises. Appendix J provides the answers to the review questions.
- The book introduces several topics that are appropriate for computer science courses, including abstract data types (ADTs), stacks, queues, simple lists, simulations, generic programming, and using recursion to implement a divide-and-conquer strategy.
- Most chapters are short enough to cover in a week or less.
- The book discusses *when* to use certain features as well as *how* to use them. For example, it links public inheritance to *is-a* relationships and composition and private inheritance to *has-a* relationships, and it discusses when to use virtual functions and when not to.

## Conventions Used in This Book

This book uses several typographic conventions to distinguish among various kinds of text:

- Code lines, commands, statements, variables, filenames, and program output appear in a computer typeface:

```
#include <iostream>
int main()
{
    using namespace std;
    cout << "What's up, Doc!\n";
    return 0;
}
```

- Program input that you should type appears in **bold computer typeface**:

Please enter your name:

**Plato**

- Placeholders in syntax descriptions appear in an *italic computer typeface*. You should replace a placeholder with the actual filename, parameter, or whatever element it represents.
- *Italic type* is used for new terms.

### Sidebar

A sidebar provides a deeper discussion or additional background to help illuminate a topic.

### Tip

Tips present short, helpful guides to particular programming situations.

### Caution

A caution alerts you to potential pitfalls.

### Note

The notes provide a catch-all category for comments that don't fall into one of the other categories.

## Systems Used to Develop This Book's Programming Examples

For the record, the C++11 examples in this book were developed using Microsoft Visual C++ 2010 and Cygwin with Gnu g++ 4.5.0, both running under 64-bit Windows 7. The remaining examples were tested with these systems, as well as on an iMac using g++ 4.2.1 under OS X 10.6.8 and on an Ubuntu Linux system using g++ 4.4.1. Most of the pre-C++11 examples were originally developed using Microsoft Visual C++ 2003 and Metrowerks CodeWarrior Development Studio 9 running under Windows XP Professional and checked using the Borland C++ 5.5 command-line compiler and GNU gpp 3.3.3 on the same system, using Comeau 4.3.3 and GNU g++ 3.3.1 under SuSE 9.0 Linux, and using Metrowerks Development Studio 9 on a Macintosh G4 under OS 10.3.

C++ offers a lot to the programmer; learn and enjoy!

# Getting Started with C++

In this chapter you'll learn about the following:

- The history and philosophy of C and of C++
- Procedural versus object-oriented programming
- How C++ adds object-oriented concepts to the C language
- How C++ adds generic programming concepts to the C language
- Programming language standards
- The mechanics of creating a program

Welcome to C++! This exciting language, which blends the C language with support for object-oriented programming and for generic programming, became one of the most important programming languages of the 1990s and continues strongly in the 2000s. Its C ancestry brings to C++ the tradition of an efficient, compact, fast, and portable language. Its object-oriented heritage brings C++ a fresh programming methodology, designed to cope with the escalating complexity of modern programming tasks. Its template features bring yet another new programming methodology: generic programming. This triple heritage is both a blessing and a bane. It makes the language very powerful, but it also means there's a lot to learn.

This chapter explores C++'s background further and then goes over some of the ground rules for creating C++ programs. The rest of the book teaches you to use the C++ language, going from the modest basics of the language to the glory of object-oriented programming (OOP) and its supporting cast of new jargon—objects, classes, encapsulation, data hiding, polymorphism, and inheritance—and then on to its support of generic programming. (Of course, as you learn C++, these terms will be transformed from buzzwords to the necessary vocabulary of cultivated discourse.)



## Learning C++: What Lies Before You

C++ joins three separate programming categories: the procedural language, represented by C; the object-oriented language, represented by the class enhancements C++ adds to C; and generic programming, supported by C++ templates. This chapter looks into those traditions. But first, let's consider what this heritage implies about learning C++. One reason to use C++ is to avail yourself of its object-oriented features. To do so, you need a sound background in standard C, for that language provides the basic types, operators, control structures, and syntax rules. So if you already know C, you're poised to learn C++. But it's not just a matter of learning a few more keywords and constructs. Going from C to C++ involves perhaps more work than learning C in the first place. Also if you know C, you must unlearn some programming habits as you make the transition to C++. If you don't know C, you have to master the C components, the OOP components, and the generic components to learn C++, but at least you may not have to unlearn programming habits. If you are beginning to think that learning C++ may involve some mind-stretching effort on your part, you're right. This book will guide you through the process in a clear, helpful manner, one step at a time, so the mind-stretching will be sufficiently gentle to leave your brain resilient.

*C++ Primer Plus* approaches C++ by teaching both its C basis and its new components, so it assumes that you have no prior knowledge of C. You'll start by learning the features C++ shares with C. Even if you know C, you may find this part of the book a good review. Also it points out concepts that will become important later, and it indicates where C++ differs from C. After you have a good grounding in the basics of C, you'll learn about the C++ superstructure. At that point, you'll learn about objects and classes and how C++ implements them. And you will learn about templates.

This book is not intended to be a complete C++ reference; it doesn't explore every nook and cranny of the language. But you will learn most of the major features of the language, including templates, exceptions, and namespaces.

Now let's take a brief look at some of C++'s background.

## The Origins of C++: A Little History

Computer technology has evolved at an amazing rate over the past few decades. Today a notebook computer can compute faster and store more information than the mainframe computers of the 1960s. (Quite a few programmers can recall bearing offerings of decks of punched cards to be submitted to a mighty, room-filling computer system with a majestic 100KB of memory—far less memory than even a smartphone uses today.) Computer languages have evolved, too. The changes may not be as dramatic, but they are important. Bigger, more powerful computers spawn bigger, more complex programs, which, in turn, raise new problems in program management and maintenance.

In the 1970s, languages such as C and Pascal helped usher in an era of structured programming, a philosophy that brought some order and discipline to a field badly in need of these qualities. Besides providing the tools for structured programming, C also

produced compact, fast-running programs, along with the ability to address hardware matters, such as managing communication ports and disk drives. These gifts helped make C the dominant programming language in the 1980s. Meanwhile, the 1980s witnessed the growth of a new programming paradigm: object-oriented programming, or OOP, as embodied in languages such as SmallTalk and C++. Let's examine these C and OOP a bit more closely.

## The C Language

In the early 1970s, Dennis Ritchie of Bell Laboratories was working on a project to develop the Unix operating system. (An *operating system* is a set of programs that manages a computer's resources and handles its interactions with users. For example, it's the operating system that puts the system prompt onscreen for a terminal-style interface that manages the windows and mice for graphical interfaces and that runs programs for you.) For this work Ritchie needed a language that was concise, that produced compact, fast programs, and that could control hardware efficiently.

Traditionally, programmers met these needs by using assembly language, which is closely tied to a computer's internal machine language. However, assembly language is a *low-level* language—that is, it works directly with the hardware (for instance, accessing CPU registers and memory locations directly). Thus, assembly language is specific to a particular computer processor. So if you want to move an assembly program to a different kind of computer, you may have to completely rewrite the program, using a different assembly language. It was a bit as if each time you bought a new car, you found that the designers decided to change where the controls went and what they did, forcing you to relearn how to drive.

But Unix was intended to work on a variety of computer types (or platforms). That suggested using a high-level language. A *high-level* language is oriented toward problem solving instead of toward specific hardware. Special programs called *compilers* translate a high-level language to the internal language of a particular computer. Thus, you can use the same high-level language program on different platforms by using a separate compiler for each platform. Ritchie wanted a language that combined low-level efficiency and hardware access with high-level generality and portability. So building from older languages, he created C.

## C Programming Philosophy

Because C++ grafts a new programming philosophy onto C, we should first take a look at the older philosophy that C follows. In general, computer languages deal with two concepts—data and algorithms. The *data* constitutes the information a program uses and processes. The *algorithms* are the methods the program uses (see Figure 1.1). Like most mainstream languages when C was created, C is a *procedural* language. That means it emphasizes the algorithm side of programming. Conceptually, procedural programming

consists of figuring out the actions a computer should take and then using the programming language to implement those actions. A program prescribes a set of procedures for the computer to follow to produce a particular outcome, much as a recipe prescribes a set of procedures for a cook to follow to produce a cake.

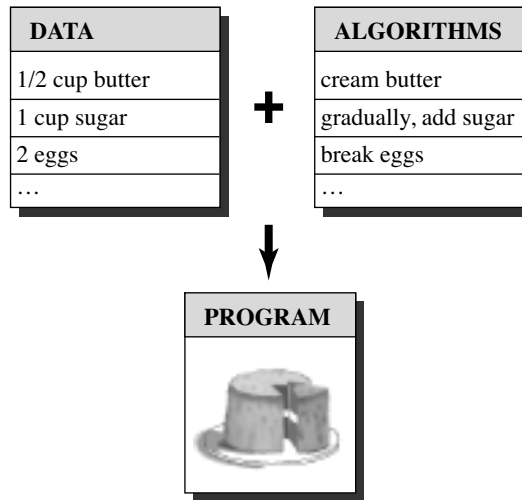

Figure 1.1 Data + algorithms = program.

Earlier procedural languages, such as FORTRAN and BASIC, ran into organizational problems as programs grew larger. For example, programs often use branching statements, which route execution to one or another set of instructions, depending on the result of some sort of test. Many older programs had such tangled routing (called “spaghetti programming”) that it was virtually impossible to understand a program by reading it, and modifying such a program was an invitation to disaster. In response, computer scientists developed a more disciplined style of programming called *structured programming*. C includes features to facilitate this approach. For example, structured programming limits branching (choosing which instruction to do next) to a small set of well-behaved constructions. C incorporates these constructions (the `for` loop, the `while` loop, the `do while` loop, and the `if else` statement) into its vocabulary.

*Top-down* design was another of the new principles. With C, the idea is to break a large program into smaller, more manageable tasks. If one of these tasks is still too broad, you divide it into yet smaller tasks. You continue with this process until the program is compartmentalized into small, easily programmed modules. (Organize your study. Aargh! Well, organize your desk, your table top, your filing cabinet, and your bookshelves. Aargh! Well, start with the desk and organize each drawer, starting with the middle one. Hmmm, perhaps I can manage that task.) C’s design facilitates this approach, encouraging you to

develop program units called *functions* to represent individual task modules. As you may have noticed, the structured programming techniques reflect a procedural mind-set, thinking of a program in terms of the actions it performs.

## The C++ Shift: Object-Oriented Programming

Although the principles of structured programming improved the clarity, reliability, and ease of maintenance of programs, large-scale programming still remains a challenge. OOP brings a new approach to that challenge. Unlike procedural programming, which emphasizes algorithms, OOP emphasizes the data. Rather than try to fit a problem to the procedural approach of a language, OOP attempts to fit the language to the problem. The idea is to design data forms that correspond to the essential features of a problem.

In C++, a *class* is a specification describing such a new data form, and an *object* is a particular data structure constructed according to that plan. For example, a class could describe the general properties of a corporation executive (name, title, salary, unusual abilities, for example), while an object would represent a specific executive (Guilford Sheepblat, vice president, \$925,000, knows how to restore the Windows registry). In general, a class defines what data is used to represent an object *and* the operations that can be performed on that data. For example, suppose you were developing a computer drawing program capable of drawing a rectangle. You could define a class to describe a rectangle. The data part of the specification could include such things as the location of the corners, the height and width, the color and style of the boundary line, and the color and pattern used to fill the rectangle. The operations part of the specification could include methods for moving the rectangle, resizing it, rotating it, changing colors and patterns, and copying the rectangle to another location. If you then used your program to draw a rectangle, it would create an object according to the class specification. That object would hold all the data values describing the rectangle, and you could use the class methods to modify that rectangle. If you drew two rectangles, the program would create two objects, one for each rectangle.

The OOP approach to program design is to first design classes that accurately represent those things with which the program deals. For example, a drawing program might define classes to represent rectangles, lines, circles, brushes, pens, and the like. The class definitions, recall, include a description of permissible operations for each class, such as moving a circle or rotating a line. Then you would proceed to design a program, using objects of those classes. The process of going from a lower level of organization, such as classes, to a higher level, such as program design, is called *bottom-up* programming.

There's more to OOP than the binding of data and methods into a class definition. For example, OOP facilitates creating reusable code, and that can eventually save a lot of work. Information hiding safeguards data from improper access. Polymorphism lets you create multiple definitions for operators and functions, with the programming context determining which definition is used. Inheritance lets you derive new classes from old ones. As you can see, OOP introduces many new ideas and involves a different approach to programming than does procedural programming. Instead of concentrating on tasks,

you concentrate on representing concepts. Instead of taking a top-down programming approach, you sometimes take a bottom-up approach. This book will guide you through all these points, with plenty of easily grasped examples.

Designing a useful, reliable class can be a difficult task. Fortunately, OOP languages make it simple to incorporate existing classes into your own programming. Vendors provide a variety of useful class libraries, including libraries of classes designed to simplify creating programs for environments such as Windows or the Macintosh. One of the real benefits of C++ is that it lets you easily reuse and adapt existing, well-tested code.

## C++ and Generic Programming

Generic programming is yet another programming paradigm supported by C++. It shares with OOP the aim of making it simpler to reuse code and the technique of abstracting general concepts. But whereas OOP emphasizes the data aspect of programming, generic programming emphasizes independence from a particular data type. And its focus is different. OOP is a tool for managing large projects, whereas generic programming provides tools for performing common tasks, such as sorting data or merging lists. The term *generic* refers to code that is type independent. C++ data representations come in many types—integers, numbers with fractional parts, characters, strings of characters, and user-defined compound structures of several types. If, for example, you wanted to sort data of these various types, you would normally have to create a separate sorting function for each type. Generic programming involves extending the language so that you can write a function for a generic (that is, an unspecified) type once and use it for a variety of actual types. C++ templates provide a mechanism for doing that.

## The Genesis of C++

Like C, C++ began its life at Bell Labs, where Bjarne Stroustrup developed the language in the early 1980s. In Stroustrup's own words, "C++ was designed primarily so that my friends and I would not have to program in assembler, C, or various modern high-level languages. Its main purpose was to make writing good programs easier and more pleasant for the individual programmer" (Bjarne Stroustrup, *The C++ Programming Language*, Third Edition. Reading, MA: Addison-Wesley, 1997).

### *Bjarne Stroustrup's Home Page*

Bjarne Stroustrup designed and implemented the C++ programming language and is the author of the definitive reference manuals *The C++ Programming Language* and *The Design and Evolution of C++*. His personal website at AT&T Labs Research should be the first C++ bookmark, or favorite, you create:

[www.research.att.com/~bs](http://www.research.att.com/~bs)

This site includes an interesting historical perspective of the hows and whys of the C++ language, Stroustrup's biographical material, and C++ FAQs. Surprisingly, Stroustrup's most frequently asked question may be how to pronounce *Bjarne Stroustrup*. Check out the FAQ on Stroustrup's website and download the .wav file to hear for yourself!

Stroustrup was more concerned with making C++ useful than with enforcing particular programming philosophies or styles. Real programming needs are more important than theoretical purity in determining C++ language features. Stroustrup based C++ on C because of C's brevity, its suitability to system programming, its widespread availability, and its close ties to the Unix operating system. C++'s OOP aspect was inspired by a computer simulation language called Simula67. Stroustrup added OOP features and generic programming support to C without significantly changing the C component. Thus C++ is a superset of C, meaning that any valid C program is a valid C++ program, too. There are some minor discrepancies but nothing crucial. C++ programs can use existing C software libraries. *Libraries* are collections of programming modules that you can call up from a program. They provide proven solutions to many common programming problems, thus saving you much time and effort. This has helped the spread of C++.

The name C++ comes from the C increment operator ++, which adds one to the value of a variable. Therefore, the name C++ correctly suggests an augmented version of C.

A computer program translates a real-life problem into a series of actions to be taken by a computer. The OOP aspect of C++ gives the language the ability to relate to concepts involved in the problem, and the C part of C++ gives the language the ability to get close to the hardware (see Figure 1.2). This combination of abilities has enabled the spread of C++. It may also involve a mental shift of gears as you turn from one aspect of a program to another. (Indeed, some OOP purists regard adding OOP features to C as being akin to adding wings to a pig, albeit a lean, efficient pig.) Also because C++ grafts OOP onto C, you can ignore C++'s object-oriented features. But you'll miss a lot if that's all you do.

Only after C++ achieved some success did Stroustrup add templates, enabling generic programming. And only after the template feature had been used and enhanced did it become apparent that templates were perhaps as significant an addition as OOP—or even more significant, some would argue. The fact that C++ incorporates both OOP and generic programming, as well as the more traditional procedural approach, demonstrates that C++ emphasizes the utilitarian over the ideological approach, and that is one of the reasons for the language's success.

## Portability and Standards

Say you've written a handy C++ program for the elderly Pentium PC computer running Windows 2000 at work, but management decides to replace the machine with a new computer using a different operating system, say Mac OS X or Linux, perhaps one with a different processor design, such as a SPARC processor. Can you run your program on the new platform? Of course you'll have to recompile the program using a C++ compiler designed for the new platform. But will you have to make any changes to the code you wrote? If you can recompile the program without making changes and it runs without a hitch, we say the program is *portable*.

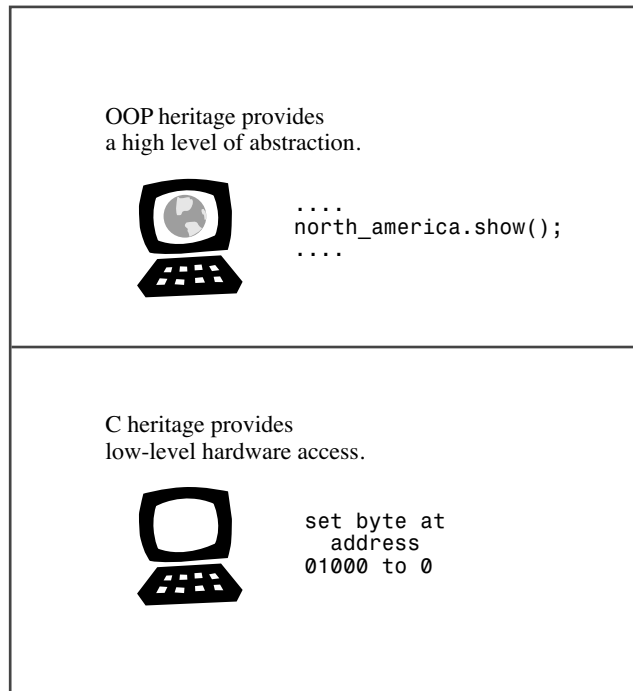

Figure 1.2 C++ duality.

There are a couple obstacles to portability, the first of which is hardware. A program that is hardware specific is not likely to be portable. One that takes direct control of an IBM PC video board, for example, speaks gibberish as far as, say, a Sun is concerned. (You can minimize portability problems by localizing the hardware-dependent parts in function modules; then you just have to rewrite those specific modules.) We avoid that sort of programming in this book.

The second obstacle to portability is language divergence. Certainly, that can be a problem with spoken languages. A Yorkshireman's description of the day's events may not be portable to Brooklyn, even though English is said to be spoken in both areas. Computer languages, too, can develop dialects. Although most implementers would like to make their versions of C++ compatible with others, it's difficult to do so without a published standard describing exactly how the language works. Therefore, the American National Standards Institute (ANSI) created a committee in 1990 (ANSI X3J16) to develop a standard for C++. (ANSI had already developed a standard for C.) The International Organization for Standardization (ISO) soon joined the process with its own committee (ISO-WG-21), creating a joint ANSI/ISO effort to develop the standard for C++.

Several years of work eventually led to the International Standard (ISO/IEC 14882:1998), which was adopted in 1998 by the ISO, the International Electrotechnical Commission (IEC), and ANSI. This standard, often called C++98, not only refined the description of existing C++ features but also extended the language with exceptions, runtime type identification (RTTI), templates, and the Standard Template Library (STL). The year 2003 brought the publication of the second edition of the C++ standard (ISO/IEC 14882:2003); the new edition is a technical revision, meaning that it tidies up the first edition—fixing typos, reducing ambiguities, and the like—but doesn't change the language features. This edition often is called C++03. Because C++03 didn't change language features, we'll follow a common usage and use C++98 to refer to C++98/C++03.

C++ continues to evolve, and the ISO committee approved a new standard August 2011 titled ISO/IEC 14882:2011 and informally dubbed C++11. Like C++98, C++11 adds many features to the language. In addition, it has the goals of removing inconsistencies and of making C++ easier to learn and use. This standard had been dubbed C++0x, with the original expectation that x would be 7 or 8, but standards work is a slow, exhaustive, and exhausting process. Fortunately, it was soon realized that 0x could be a hexadecimal integer (see Appendix A, “Number Bases”), which meant the committee had until 2015 to finish the work. So by that measure, they have finished ahead of schedule.

The ISO C++ Standard additionally draws on the ANSI C Standard because C++ is supposed to be, as far as possible, a superset of C. That means that any valid C program ideally should also be a valid C++ program. There are a few differences between ANSI C and the corresponding rules for C++, but they are minor. Indeed, ANSI C incorporates some features first introduced in C++, such as function prototyping and the `const` type qualifier.

Prior to the emergence of ANSI C, the C community followed a de facto standard based on the book *The C Programming Language*, by Kernighan and Ritchie (Addison-Wesley Publishing Company, Reading, MA, 1978). This standard was often termed K&R C; with the emergence of ANSI C, the simpler K&R C is now sometimes called *classic C*.

The ANSI C Standard not only defines the C language, it also defines a standard C library that ANSI C implementations must support. C++ also uses that library; this book refers to it as the *standard C library* or the *standard library*. In addition, the ISO C++ standard provides a standard library of C++ classes.

The C Standard was last revised as C99, which was adopted by the ISO in 1999 and ANSI in 2000. This standard adds some features to C, such as a new integer type, that some C++ compilers support.

## Language Growth

Originally, the de facto standard for C++ was a 65-page reference manual included in the 328-page *The C++ Programming Language*, by Stroustrup (Addison-Wesley, 1986).

The next major published de facto standard was *The Annotated C++ Reference Manual*, by Ellis and Stroustrup (Addison-Wesley, 1990). This is a 453-page work; it includes substantial commentary in addition to reference material.



The C++98 standard, with the addition of many features, reached nearly 800 pages, even with only minimal commentary.

The C++11 standard is over 1,350 pages long, so it augments the old standard substantially .

## This Book and C++ Standards

Contemporary compilers provide good support for C++98. Some compilers at the time of this writing also support some C++11 features, and we can expect the level of support to increase quickly now that the new standard is adopted. This book reflects the current situation, covering C++98 pretty thoroughly and introducing several C++11 features. Some of these features are integrated with the coverage of related C++98 topics. Chapter 18, “Visiting with the New C++ Standard,” concentrates on the new features, summarizing the ones mentioned earlier in the book and presenting additional features.

With the incomplete support available at the time of this writing, it would be very difficult to cover adequately all the new C++11 features. But even when the new standard is completely supported, it’s clear that comprehensive coverage would be beyond the scope of any reasonably sized single volume book. This book takes the approach of concentrating on features that are already available on some compilers and briefly summarizing many of the other features.

Before getting to the C++ language proper, let’s cover some of the groundwork related to creating programs.

## The Mechanics of Creating a Program

Suppose you’ve written a C++ program. How do you get it running? The exact steps depend on your computer environment and the particular C++ compiler you use, but they should resemble the following steps (see Figure 1.3):

1. Use a text editor of some sort to write the program and save it in a file. This file constitutes the *source code* for your program.
2. Compile the source code. This means running a program that translates the source code to the internal language, called *machine language*, used by the host computer. The file containing the translated program is the *object code* for your program.
3. Link the object code with additional code. For example, C++ programs normally use *libraries*. A C++ library contains object code for a collection of computer routines, called *functions*, to perform tasks such as displaying information onscreen or calculating the square root of a number. Linking combines your object code with object code for the functions you use and with some standard startup code to produce a runtime version of your program. The file containing this final product is called the *executable code*.

You will encounter the term *source code* throughout this book, so be sure to file it away in your personal random-access memory.

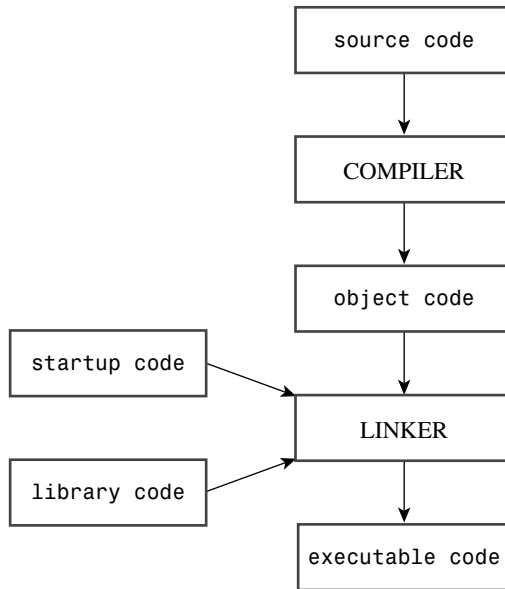

Figure 1.3 Programming steps.

Most of the programs in this book are generic and should run in any system that supports C++98. However, some, particularly those in Chapter 18, do require some C++11 support. At the time of this writing, some compilers require additional flags to activate their partial C++11 support. For instance, g++, beginning with version 4.3, currently uses the `-std=c++0x` flag when compiling a source code file:

```
g++ -std=c++0x use_auto.cpp
```

The steps for putting together a program may vary. Let's look a little further at these steps.

## Creating the Source Code File

The rest of the book deals with what goes into a source file; this section discusses the mechanics of creating one. Some C++ implementations, such as Microsoft Visual C++, Embarcadero C++ Builder, Apple Xcode, Open Watcom C++, Digital Mars C++, and Freescale CodeWarrior, provide *integrated development environments (IDEs)* that let you manage all steps of program development, including editing, from one master program. Other implementations, such as GNU C++ on Unix and Linux, IBM XL C/C++ on AIX, and the free versions of the Borland 5.5 (distributed by Embarcadero) and Digital Mars compilers, just handle the compilation and linking stages and expect you to type commands on the system command line. In such cases, you can use any available text editor to create and modify source code. On a Unix system, for example, you can use `vi` or `ed` or `ex` or `emacs`. On a Windows system running in the Command Prompt mode you can use `edlin`

or `edit` or any of several available program editors. You can even use a word processor, provided that you save the file as a standard ASCII text file instead of in a special word processor format. Alternatively, there may be IDE options for use with these command-line compilers.

In naming a source file, you must use the proper suffix to identify the file as a C++ file. This not only tells you that the file is C++ source code, it tells the compiler that, too. (If a Unix compiler complains to you about a “bad magic number,” that’s just its endearingly obscure way of saying that you used the wrong suffix.) The suffix consists of a period followed by a character or group of characters called the *extension* (see Figure 1.4).

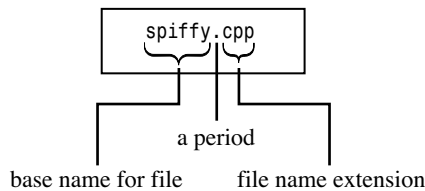

Figure 1.4 The parts of a source code filename.

The extension you use depends on the C++ implementation. Table 1.1 shows some common choices. For example, `spiffy.c` is a valid Unix C++ source code filename. Note that Unix is case sensitive, meaning you should use an uppercase C character. Actually, a lowercase `c` extension also works, but standard C uses that extension. So to avoid confusion on Unix systems, you should use `c` with C programs and `cpp` with C++ programs. If you don’t mind typing an extra character or two, you can also use the `cc` and `cxx` extensions with some Unix systems. DOS, being a bit simple-minded compared to Unix, doesn’t distinguish between uppercase and lowercase, so DOS implementations use additional letters, as shown in Table 1.1, to distinguish between C and C++ programs.

Table 1.1 Source Code Extensions

C++ Implementation	Source Code Extension(s)
Unix	C, cc, cxx, c
GNU C++	C, cc, cxx, cpp, c++
Digital Mars	cpp, cxx
Borland C++	cpp
Watcom	cpp
Microsoft Visual C++	cpp, cxx, cc
Freestyle CodeWarrior	cpp, cp, cc, cxx, c++

## Compilation and Linking

Originally, Stroustrup implemented C++ with a C++-to-C compiler program instead of developing a direct C++-to-object code compiler. This program, called `cfront` (for *C front end*), translated C++ source code to C source code, which could then be compiled by a standard C compiler. This approach simplified introducing C++ to the C community. Other implementations have used this approach to bring C++ to other platforms. As C++ has developed and grown in popularity, more and more implementers have turned to creating C++ compilers that generate object code directly from C++ source code. This direct approach speeds up the compilation process and emphasizes that C++ is a separate, if similar, language.

The mechanics of compiling depend on the implementation, and the following sections outline a few common forms. These sections outline the basic steps, but they are no substitute for consulting the documentation for your system.

### Unix Compiling and Linking

Originally, the Unix `cc` command invoked `cfront`. However, `cfront` didn't keep pace with the evolution of C++, and its last release was in 1993. These days a Unix computer instead might have no compiler, a proprietary compiler, or a third-party compiler, perhaps commercial, perhaps freeware, such as the GNU `g++` compiler. In many of these other cases (but not in the no-compiler case!), the `cc` command still works, with the actual compiler being invoked differing from system to system. For simplicity, we'll assume that `cc` is available, but realize that you might have to substitute a different command for `cc` in the following discussion.

You use the `cc` command to compile your program. The name is in uppercase letters to distinguish it from the standard Unix C compiler `cc`. The `cc` compiler is a command-line compiler, meaning you type compilation commands on the Unix command line.

For example, to compile the C++ source code file `spiffy.c`, you would type this command at the Unix prompt:

```
cc spiffy.c
```

If, through skill, dedication, or luck, your program has no errors, the compiler generates an object code file with an `.o` extension. In this case, the compiler produces a file named `spiffy.o`.

Next, the compiler automatically passes the object code file to the system linker, a program that combines your code with library code to produce the executable file. By default, the executable file is called `a.out`. If you used just one source file, the linker also deletes the `spiffy.o` file because it's no longer needed. To run the program, you just type the name of the executable file:

```
a.out
```

Note that if you compile a new program, the new `a.out` executable file replaces the previous `a.out`. (That's because executable files take a lot of space, so overwriting old executable files helps reduce storage demands.) But if you develop an executable program

you want to keep, you just use the Unix `mv` command to change the name of the executable file.

In C++, as in C, you can spread a program over more than one file. (Many of the programs in this book in Chapters 8 through 16 do this.) In such a case, you can compile a program by listing all the files on the command line, like this:

```
CC my.C precious.C
```

If there are multiple source code files, the compiler does not delete the object code files. That way, if you just change the `my.C` file, you can recompile the program with this command:

```
CC my.C precious.o
```

This recompiles the `my.C` file and links it with the previously compiled `precious.o` file.

You might have to identify some libraries explicitly. For example, to access functions defined in the math library, you may have to add the `-lm` flag to the command line:

```
CC usingmath.C -lm
```

## Linux Compiling and Linking

Linux systems most commonly use `g++`, the GNU C++ compiler from the Free Software Foundation. The compiler is included in most Linux distributions, but it may not always be installed. The `g++` compiler works much like the standard Unix compiler. For example, the following produces an executable file call `a.out`:

```
g++ spiffy.cxx
```

Some versions might require that you link in the C++ library:

```
g++ spiffy.cxx -lg++
```

To compile multiple source files, you just list them all in the command line:

```
g++ my.cxx precious.cxx
```

This produces an executable file called `a.out` and two object code files, `my.o` and `precious.o`. If you subsequently modify just one of the source code files, say `my.cxx`, you can recompile by using `my.cxx` and the `precious.o`:

```
g++ my.cxx precious.o
```

The GNU compiler is available for many platforms, including the command-line mode for Windows-based PCs as well as for Unix systems on a variety of platforms.

## Command-Line Compilers for Windows Command Prompt Mode

An inexpensive route for compiling C++ programs on a Windows PC is to download a free command-line compiler that runs in Windows Command Prompt mode, which opens an MS-DOS-like window. Free Windows downloads that include the GNU C++ compiler are Cygwin and MinGW; they use `g++` as the compiler name.

To use the `g++` compiler, you first open a command prompt window. Cygwin and MinGW do this for you automatically when you start those programs. To compile a source code file named `great.cpp`, you type the following command at the prompt:

```
g++ great.cpp
```

If the program compiles successfully, the resultant executable file is named `a.exe`.

## Windows Compilers

Windows products are too abundant and too often revised to make it reasonable to describe them all individually. At the present the most popular is Microsoft Visual C++ 2010, which is available in the free Microsoft Visual C++ 2010 Express edition. The Wikipedia link ([http://en.wikipedia.org/wiki/List\\_of\\_compilers](http://en.wikipedia.org/wiki/List_of_compilers)) provides a comprehensive list of compilers for many platforms, including Windows. Despite different designs and goals, most Windows-based C++ compilers share some common features.

Typically, you must create a project for a program and add to the project the file or files constituting the program. Each vendor supplies an IDE with menu options and, possibly, automated assistance, in creating a project. One very important matter you have to establish is the kind of program you're creating. Typically, the compiler offers many choices, such as a Windows application, an MFC Windows application, a dynamic link library, an ActiveX control, a DOS or character-mode executable, a static library, or a console application. Some of these may be available in both 64-bit and 32-bit versions.

Because the programs in this book are generic, you should avoid choices that require platform-specific code, such as Windows applications. Instead, you want to run in a character-based mode. The choice depends on the compiler. In general, you should look to see if there is an option labeled Console, character-mode, or DOS executable and try that. For instance, in Microsoft Visual C++ 2010, select the Win32 Console Application option, click Application Settings, and select the Empty Project option. In C++Builder XE, select Console Application under C++Builder Projects.

After you have the project set up, you have to compile and link your program. The IDE typically gives you several choices, such as Compile, Build, Make, Build All, Link, Execute, Run, and Debug (but not necessarily all these choices in the same IDE!):

- *Compile* typically means compile the code in the file that is currently open.
- *Build* or *Make* typically means compile the code for all the source code files in the project. This is often an incremental process. That is, if the project has three files, and you change just one, and then just that one is recompiled.
- *Build All* typically means compile all the source code files from scratch.
- As described earlier, *Link* means combine the compiled source code with the necessary library code.
- *Run* or *Execute* means run the program. Typically, if you have not yet done the earlier steps, Run does them before trying to run a program.
- *Debug* means run the program with the option of going through step-by-step.

- A compiler may offer the option of *Debug* and *Release* versions. The former contains extra code that increases the program size, slows program execution, but enables detailed debugging features.

A compiler generates an error message when you violate a language rule and identifies the line that has the problem. Unfortunately, when you are new to a language, you may find it difficult to understand the message. Sometimes the actual error may occur before the identified line, and sometimes a single error generates a chain of error messages.

### Tip

When fixing errors, fix the first error first. If you can't find it on the line identified as the line with the error, check the preceding line.

Be aware of the fact that a particular compiler accepts a program doesn't necessarily mean that the program is valid C++. And the fact that a particular compiler rejects a program doesn't necessarily mean that the program is invalid C++. However, current compilers are more compliant with the Standard than their predecessors of a few years ago. Also compilers typically have options to control how strict the compiler is.

### Tip

Occasionally, compilers get confused after incompletely building a program and respond by giving meaningless error messages that cannot be fixed. In such cases, you can clear things up by selecting Build All to restart the process from scratch. Unfortunately, it is difficult to distinguish this situation from the more common one in which the error messages merely seem to be meaningless.

Usually, the IDE lets you run the program in an auxiliary window. Some IDEs close the window as soon as the program finishes execution, and some leave it open. If your compiler closes the window, you'll have a hard time seeing the output unless you have quick eyes and a photographic memory. To see the output, you must place some additional code at the end of the program:

```
    cin.get(); // add this statement
    cin.get(); // and maybe this, too
    return 0;
}
```

The `cin.get()` statement reads the next keystroke, so this statement causes the program to wait until you press the Enter key. (No keystrokes get sent to a program until you press Enter, so there's no point in pressing another key.) The second statement is needed if the program otherwise leaves an unprocessed keystroke after its regular input. For example, if you enter a number, you type the number and then press Enter. The program reads the number but leaves the Enter keystroke unprocessed, and it is then read by the first `cin.get()`.

## C++ on the Macintosh

Apple currently supplies a developer framework called Xcode with the Mac OS X operating system. It's free but normally not preinstalled. You can install it from the operating system installation disks, or you can download it for a nominal fee from Apple. (Be aware that it is over a 4GB download.) Not only does it provide an IDE that supports several programming languages, it also installs a couple of compilers—g++ and clang—that can be used as command-line programs in the Unix mode accessible through the Terminal utility.

### Tip

For IDEs: To save time, you can use just one project for all the sample programs. Just delete the previous sample source code file from the project list and add the current source code. This saves time, effort, and lessens disk clutter.

## Summary

As computers have grown more powerful, computer programs have become larger and more complex. In response to these conditions, computer languages have evolved so that it's easier to manage the programming process. The C language incorporated features such as control structures and functions to better control the flow of a program and to enable a more structured, modular approach. To these tools C++ adds support for object-oriented programming and generic programming. This enables even more modularity and facilitates the creation of reusable code, which saves time and increases program reliability.

The popularity of C++ has resulted in a large number of implementations for many computing platforms; the C++ ISO standards (C++98/03 and C++11) provide a basis for keeping these many implementations mutually compatible. The standards establishes the features the language should have, the behavior the language should display, and a standard library of functions, classes, and templates. The standards supports the goal of a portable language across different computing platforms and different implementations of the language.

To create a C++ program, you create one or more source files containing the program as expressed in the C++ language. These are text files that must be compiled and linked to produce the machine-language files that constitute executable programs. These tasks are often accomplished in an IDE that provides a text editor for creating the source files, a compiler and a linker for producing executable files, and other resources, such as project management and debugging capabilities. But the same tasks can also be performed in a command-line environment by invoking the appropriate tools individually.



*This page intentionally left blank*

# Setting Out to C++

In this chapter you'll learn about the following:

- Creating a C++ program
- The general format for a C++ program
- The `#include` directive
- The `main()` function
- Using the `cout` object for output
- Placing comments in a C++ program
- How and when to use `endl`
- Declaring and using variables
- Using the `cin` object for input
- Defining and using simple functions

When you construct a simple home, you begin with the foundation and the framework. If you don't have a solid structure from the beginning, you'll have trouble later filling in the details, such as windows, door frames, observatory domes, and parquet ballrooms. Similarly, when you learn a computer language, you should begin by learning the basic structure for a program. Only then can you move on to the details, such as loops and objects. This chapter gives you an overview of the essential structure of a C++ program and previews some topics—notably functions and classes—covered in much greater detail in later chapters. (The idea is to introduce at least some of the basic concepts gradually en route to the great awakenings that come later.)

## C++ Initiation

Let's begin with a simple C++ program that displays a message. Listing 2.1 uses the C++ `cout` (pronounced “see-out”) facility to produce character output. The source code includes several comments to the reader; these lines begin with `//`, and the compiler ignores them. C++ is *case sensitive*; that is, it discriminates between uppercase characters

and lowercase characters. This means you must be careful to use the same case as in the examples. For example, this program uses `cout`, and if you substitute `Count` or `COUT`, the compiler rejects your offering and accuses you of using unknown identifiers. (The compiler is also spelling sensitive, so don't try `kout` or `coot`, either.) The `cpp` filename extension is a common way to indicate a C++ program; you might need to use a different extension, as described in Chapter 1, "Getting Started with C++."

### Listing 2.1 `myfirst.cpp`

---

```
// myfirst.cpp -- displays a message

#include <iostream>                // a PREPROCESSOR directive
int main()                        // function header
{
    using namespace std;         // make definitions visible
    cout << "Come up and C++ me some time."; // message
    cout << endl;                // start a new line
    cout << "You won't regret it!" << endl; // more output
    return 0;                    // terminate main()
}                                 // end of function body
```

---

### Program Adjustments

You might find that you must alter the examples in this book to run on your system. The most common reason is a matter of the programming environment. Some windowing environments run the program in a separate window and then automatically close the window when the program finishes. As discussed in Chapter 1, you can make the window stay open until you strike a key by adding the following line of code before the return statement:

```
cin.get();
```

For some programs you must add two of these lines to keep the window open until you press a key. You'll learn more about `cin.get()` in Chapter 4, "Compound Types."

If you have a very old system, it may not support features introduced by the C++98 standard.

Some programs require a compiler with some level of support for the C++11 standard. They will be clearly identified and, if possible, alternative non-C++11 code will be suggested.

After you use your editor of choice to copy this program (or else use the source code files available online from this book's web page—check the registration link on the back cover for more information), you can use your C++ compiler to create the executable code, as Chapter 1 outlines. Here is the output from running the compiled program in Listing 2.1:

```
Come up and C++ me some time.
You won't regret it!
```

## C Input and Output

If you're used to programming in C, seeing `cout` instead of the `printf()` function might come as a minor shock. C++ can, in fact, use `printf()`, `scanf()`, and all the other standard C input and output functions, provided that you include the usual C `stdio.h` file. But this is a C++ book, so it uses C++'s input facilities, which improve in many ways upon the C versions.

You construct C++ programs from building blocks called *functions*. Typically, you organize a program into major tasks and then design separate functions to handle those tasks. The example shown in Listing 2.1 is simple enough to consist of a single function named `main()`. The `myfirst.cpp` example has the following elements:

- Comments, indicated by the `//` prefix
- A preprocessor `#include` directive
- A function header: `int main()`
- A `using namespace` directive
- A function body, delimited by `{` and `}`
- Statements that uses the C++ `cout` facility to display a message
- A return statement to terminate the `main()` function

Let's look at these various elements in greater detail. The `main()` function is a good place to start because some of the features that precede `main()`, such as the preprocessor directive, are simpler to understand after you see what `main()` does.

## Features of the `main()` Function

Stripped of the trimmings, the sample program shown in Listing 2.1 has the following fundamental structure:

```
int main()
{
    statements
    return 0;
}
```

These lines state that there is a function called `main()`, and they describe how the function behaves. Together they constitute a *function definition*. This definition has two parts: the first line, `int main()`, which is called the *function header*, and the portion enclosed in braces (`{` and `}`), which is the *function body*. (A quick search on the Web reveals braces also go by other names, including “curly brackets,” “flower brackets,” “fancy brackets,” and “chicken lips.” However, the ISO Standard uses the term “braces.”) Figure 2.1 shows the `main()` function. The function header is a capsule summary of the function's interface with the rest of the program, and the function body represents instructions to the computer about what the function should do. In C++ each complete instruction is called a *statement*. You must terminate each statement with a semicolon, so don't omit the semicolons when you type the examples.

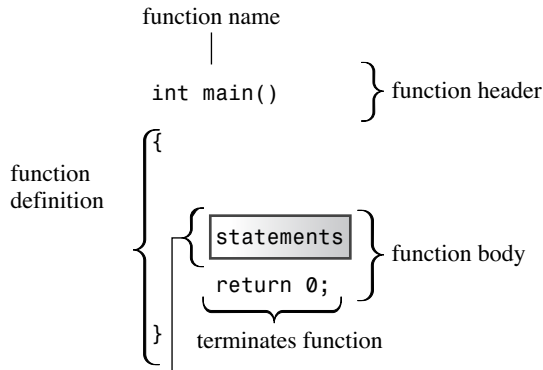

Statements are C++ expressions terminated by a semicolon.

Figure 2.1 The `main()` function.

The final statement in `main()`, called a *return statement*, terminates the function. You'll learn more about the return statement as you read through this chapter.

### Statements and Semicolons

A statement represents an action to be taken. To understand your source code, a compiler needs to know when one statement ends and another begins. Some languages use a statement separator. FORTRAN, for example, uses the end of the line to separate one statement from the next. Pascal uses a semicolon to separate one statement from the next. In Pascal you can omit the semicolon in certain cases, such as after a statement just before an `END`, when you aren't actually separating two statements. (Pragmatists and minimalists will disagree about whether *can* implies *should*.) But C++, like C, uses a semicolon as a *terminator* rather than as a separator. The difference is that a semicolon acting as a terminator is *part* of the statement rather than a marker *between* statements. The practical upshot is that in C++ you should never omit the semicolon.

### The Function Header as an Interface

Right now the main point to remember is that C++ syntax requires you to begin the definition of the `main()` function with this header: `int main()`. This chapter discusses the function header syntax in more detail later, in the section "Functions," but for those who can't put their curiosity on hold, here's a preview.

In general, a C++ function is activated, or *called*, by another function, and the function header describes the interface between a function and the function that calls it. The part preceding the function name is called the *function return type*; it describes information flow from a function back to the function that calls it. The part within the parentheses following the function name is called the *argument list* or *parameter list*; it describes information flow from the calling function to the called function. This general description is a bit confusing when you apply it to `main()` because you normally don't call `main()` from other parts of your program. Typically, however, `main()` is called by startup code that the compiler adds to your program to mediate between the program and the operating system

(Unix, Windows 7, Linux, or whatever). In effect, the function header describes the interface between `main()` and the operating system.

Consider the interface description for `main()`, beginning with the `int` part. A C++ function called by another function can return a value to the activating (calling) function. That value is called a *return value*. In this case, `main()` can return an integer value, as indicated by the keyword `int`. Next, note the empty parentheses. In general, a C++ function can pass information to another function when it calls that function. The portion of the function header enclosed in parentheses describes that information. In this case, the empty parentheses mean that the `main()` function takes no information, or in the usual terminology, `main()` takes no arguments. (To say that `main()` takes no arguments doesn't mean that `main()` is an unreasonable, authoritarian function. Instead, *argument* is the term computer buffs use to refer to information passed from one function to another.)

In short, the following function header states that the `main()` function returns an integer value to the function that calls it and that `main()` takes no information from the function that calls it:

```
int main()
```

Many existing programs use the classic C function header instead:

```
main()    // original C style
```

Under classic C, omitting the return type is the same as saying that the function is type `int`. However, C++ has phased out that usage.

You can also use this variant:

```
int main(void)    // very explicit style
```

Using the keyword `void` in the parentheses is an explicit way of saying that the function takes no arguments. Under C++ (but not C), leaving the parentheses empty is the same as using `void` in the parentheses. (In C, leaving the parentheses empty means you are remaining silent about whether there are arguments.)

Some programmers use this header and omit the return statement:

```
void main()
```

This is logically consistent because a `void` return type means the function doesn't return a value. However, although this variant works on some systems, it's not part of the C++ Standard. Thus, on other systems it fails. So you should avoid this form and use the C++ Standard form; it doesn't require that much more effort to do it right.

Finally, the ISO C++ Standard makes a concession to those who complain about the tiresome necessity of having to place a return statement at the end of `main()`. If the compiler reaches the end of `main()` without encountering a return statement, the effect will be the same as if you ended `main()` with this statement:

```
return 0;
```

This implicit return is provided only for `main()` and not for any other function.

### Why `main()` by Any Other Name Is Not the Same

There's an extremely compelling reason to name the function in the `myfirst.cpp` program `main()`: You must do so. Ordinarily, a C++ program requires a function called `main()`. (And not, by the way, `Main()` or `MAIN()` or `mane()`. Remember, case and spelling count.) Because the `myfirst.cpp` program has only one function, that function must bear the responsibility of being `main()`. When you run a C++ program, execution always begins at the beginning of the `main()` function. Therefore, if you don't have `main()`, you don't have a complete program, and the compiler points out that you haven't defined a `main()` function.

There are exceptions. For example, in Windows programming you can write a dynamic link library (DLL) module. This is code that other Windows programs can use. Because a DLL module is not a standalone program, it doesn't need a `main()`. Programs for specialized environments, such as for a controller chip in a robot, might not need a `main()`. Some programming environments provide a skeleton program calling some nonstandard function, such as `_tmain()`; in that case there is a hidden `main()` that calls `_tmain()`. But your ordinary standalone program does need a `main()`; this book discusses that sort of program.

### C++ Comments

The double slash (`//`) introduces a C++ comment. A *comment* is a remark from the programmer to the reader that usually identifies a section of a program or explains some aspect of the code. The compiler ignores comments. After all, it knows C++ at least as well as you do, and, in any case, it's incapable of understanding comments. As far as the compiler is concerned, Listing 2.1 looks as if it were written without comments, like this:

```
#include <iostream>
int main()
{
    using namespace std;
    cout << "Come up and C++ me some time.";
    cout << endl;
    cout << "You won't regret it!" << endl;
    return 0;
}
```

C++ comments run from the `//` to the end of the line. A comment can be on its own line, or it can be on the same line as code. Incidentally, note the first line in Listing 2.1:

```
// myfirst.cpp -- displays a message
```

In this book all programs begin with a comment that gives the filename for the source code and a brief program summary. As mentioned in Chapter 1, the filename extension for source code depends on your C++ system. Other systems might use `myfirst.C` or `myfirst.cxx` for names.

## Tip

You should use comments to document your programs. The more complex the program, the more valuable comments are. Not only do they help others to understand what you have done, but also they help you understand what you've done, especially if you haven't looked at the program for a while.

## C-Style Comments

C++ also recognizes C comments, which are enclosed between `/*` and `*/` symbols:

```
#include <iostream> /* a C-style comment */
```

Because the C-style comment is terminated by `*/` rather than by the end of a line, you can spread it over more than one line. You can use either or both styles in your programs. However, try sticking to the C++ style. Because it doesn't involve remembering to correctly pair an end symbol with a begin symbol, it's less likely to cause problems. Indeed, C99 has added the `//` comment to the C language.

## The C++ Preprocessor and the `iostream` File

Here's the short version of what you need to know. If your program is to use the usual C++ input or output facilities, you provide these two lines:

```
#include <iostream>
using namespace std;
```

There are some alternatives to using the second line, but let's keep things simple for now. (If your compiler doesn't like these lines, it's not C++98 compatible, and it will have many other problems with the examples in this book.) That's all you really must know to make your programs work, but now let's take a more in-depth look.

C++, like C, uses a *preprocessor*. This is a program that processes a source file before the main compilation takes place. (Some C++ implementations, as you might recall from Chapter 1, use a translator program to convert a C++ program to C. Although the translator is also a form of preprocessor, we're not discussing that preprocessor; instead, we're discussing the one that handles directives whose names begin with `#`.) You don't have to do anything special to invoke this preprocessor. It automatically operates when you compile the program.

Listing 2.1 uses the `#include` directive:

```
#include <iostream>    // a PREPROCESSOR directive
```

This directive causes the preprocessor to add the contents of the `iostream` file to your program. This is a typical preprocessor action: adding or replacing text in the source code before it's compiled.

This raises the question of why you should add the contents of the `iostream` file to the program. The answer concerns communication between the program and the outside world. The `io` in `iostream` refers to *input*, which is information brought into the program, and to *output*, which is information sent out from the program. C++'s input/output scheme involves several definitions found in the `iostream` file. Your first program needs



these definitions to use the `cout` facility to display a message. The `#include` directive causes the contents of the `iostream` file to be sent along with the contents of your file to the compiler. In essence, the contents of the `iostream` file replace the `#include <iostream>` line in the program. Your original file is not altered, but a composite file formed from your file and `iostream` goes on to the next stage of compilation.

### Note

Programs that use `cin` and `cout` for input and output must include the `iostream` file.

## Header Filenames

Files such as `iostream` are called *include files* (because they are included in other files) or *header files* (because they are included at the beginning of a file). C++ compilers come with many header files, each supporting a particular family of facilities. The C tradition has been to use the `.h` extension with header files as a simple way to identify the type of file by its name. For example, the C `math.h` header file supports various C math functions. Initially, C++ did the same. For instance, the header file supporting input and output was named `iostream.h`. But C++ usage has changed. Now the `.h` extension is reserved for the old C header files (which C++ programs can still use), whereas C++ header files have no extension. There are also C header files that have been converted to C++ header files. These files have been renamed by dropping the `.h` extension (making it a C++-style name) and prefixing the filename with a `c` (indicating that it comes from C). For example, the C++ version of `math.h` is the `cmath` header file. Sometimes the C and C++ versions of C header files are identical, whereas in other cases the new version might have a few changes. For purely C++ header files such as `iostream`, dropping the `.h` is more than a cosmetic change, for the `.h`-free header files also incorporate namespaces, the next topic in this chapter. Table 2.1 summarizes the naming conventions for header files.

Table 2.1 Header File Naming Conventions

Kind of Header	Convention	Example	Comments
C++ old style	Ends in <code>.h</code>	<code>iostream.h</code>	Usable by C++ programs
C old style	Ends in <code>.h</code>	<code>math.h</code>	Usable by C and C++ programs
C++ new style	No extension	<code>iostream</code>	Usable by C++ programs, uses namespace <code>std</code>
Converted C	<code>c</code> prefix, no extension	<code>cmath</code>	Usable by C++ programs, might use non-C features, such as namespace <code>std</code>

In view of the C tradition of using different filename extensions to indicate different file types, it appears reasonable to have some special extension, such as `.hpp` or `.hxx`, to indicate C++ header files. The ANSI/ISO committee felt so, too. The problem was agreeing on which extension to use, so eventually they agreed on nothing.

## Namespaces

If you use `iostream` instead of `iostream.h`, you should use the following namespace directive to make the definitions in `iostream` available to your program:

```
using namespace std;
```

This is called a *using directive*. The simplest thing to do is to accept this for now and worry about it later (for example, in Chapter 9, “Memory Models and Namespaces”). But so you won’t be left completely in the dark, here’s an overview of what’s happening.

Namespace support is a C++ feature designed to simplify the writing of large programs and of programs that combine pre-existing code from several vendors and to help organize programs. One potential problem is that you might use two prepackaged products that both have, say, a function called `wanda()`. If you then use the `wanda()` function, the compiler won’t know which version you mean. The namespace facility lets a vendor package its wares in a unit called a *namespace* so that you can use the name of a namespace to indicate which vendor’s product you want. So Microflop Industries could place its definitions in a namespace called `Microflop`. Then `Microflop::wanda()` would become the full name for its `wanda()` function. Similarly, `Piscine::wanda()` could denote Piscine Corporation’s version of `wanda()`. Thus, your program could now use the namespaces to discriminate between various versions:

```
Microflop::wanda("go dancing?"); // use Microflop namespace version
Piscine::wanda("a fish named Desire"); // use Piscine namespace version
```

In this spirit, the classes, functions, and variables that are a standard component of C++ compilers are now placed in a namespace called `std`. This takes place in the `h-free` header files. This means, for example, that the `cout` variable used for output and defined in `iostream` is really called `std::cout` and that `endl` is really `std::endl`. Thus, you can omit the `using` directive and, instead, code in the following style:

```
std::cout << "Come up and C++ me some time.";
std::cout << std::endl;
```

However, many users don’t feel like converting pre-namespace code, which uses `iostream.h` and `cout`, to namespace code, which uses `iostream` and `std::cout`, unless they can do so without a lot of hassle. This is where the `using` directive comes in. The following line means you can use names defined in the `std` namespace without using the `std::` prefix:

```
using namespace std;
```

This `using` directive makes all the names in the `std` namespace available. Modern practice regards this as a bit lazy and potentially a problem in large projects. The preferred approaches are to use the `std::` qualifier or to use something called a *using declaration* to make just particular names available:

```
using std::cout; // make cout available
using std::endl; // make endl available
using std::cin; // make cin available
```

If you use these directives instead of the following, you can use `cin` and `cout` without attaching `std::` to them:

```
using namespace std; // lazy approach, all names available
```

But if you need to use other names from `iostream`, you have to add them to the `using` list individually. This book initially uses the lazy approach for a couple reasons. First, for simple programs, it's not really a big issue which namespace management technique you use. Second, I'd rather emphasize the more basic aspects about learning C++. Later, the book uses the other namespace techniques.

## C++ Output with `cout`

Now let's look at how to display a message. The `myfirst.cpp` program uses the following C++ statement:

```
cout << "Come up and C++ me some time.";
```

The part enclosed within the double quotation marks is the message to print. In C++, any series of characters enclosed in double quotation marks is called a *character string*, presumably because it consists of several characters strung together into a larger unit. The `<<` notation indicates that the statement is sending the string to `cout`; the symbols point the way the information flows. And what is `cout`? It's a predefined object that knows how to display a variety of things, including strings, numbers, and individual characters. (An *object*, as you might remember from Chapter 1, is a particular instance of a class, and a *class* defines how data is stored and used.)

Well, using objects so soon is a bit awkward because you won't learn about objects for several more chapters. Actually, this reveals one of the strengths of objects. You don't have to know the innards of an object in order to use it. All you must know is its interface—that is, how to use it. The `cout` object has a simple interface. If `string` represents a string, you can do the following to display it:

```
cout << string;
```

This is all you must know to display a string, but now take a look at how the C++ conceptual view represents the process. In this view, the output is a stream—that is, a series of characters flowing from the program. The `cout` object, whose properties are defined in the `iostream` file, represents that stream. The object properties for `cout` include an insertion operator (`<<`) that inserts the information on its right into the stream. Consider the following statement (note the terminating semicolon):

```
cout << "Come up and C++ me some time.";
```

It inserts the string "Come up and C++ me some time." into the output stream. Thus, rather than say that your program displays a message, you can say that it inserts a string into the output stream. Somehow, that sounds more impressive (see Figure 2.2).

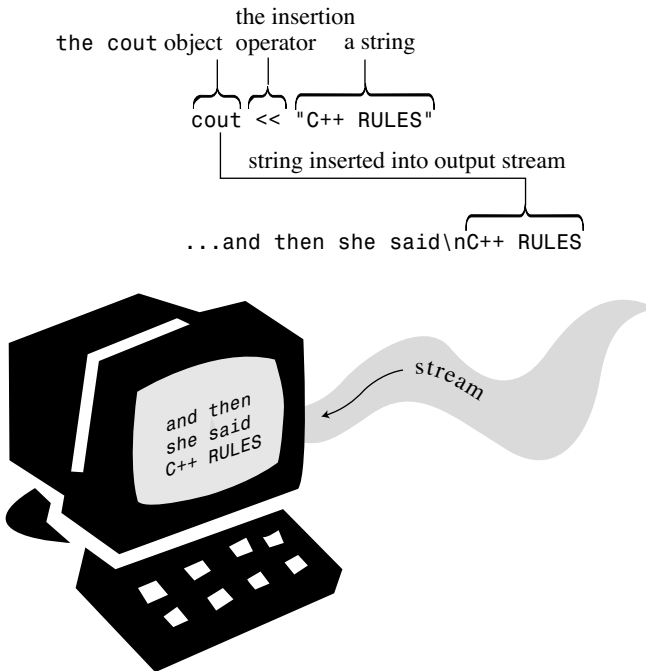

Figure 2.2 Using `cout` to display a string.

## A First Look at Operator Overloading

If you're coming to C++ from C, you probably noticed that the insertion operator (`<<`) looks just like the bitwise left-shift operator (`<<`). This is an example of *operator overloading*, by which the same operator symbol can have different meanings. The compiler uses the context to figure out which meaning is intended. C itself has some operator overloading. For example, the `&` symbol represents both the address operator and the bitwise AND operator. The `*` symbol represents both multiplication and dereferencing a pointer. The important point here is not the exact function of these operators but that the same symbol can have more than one meaning, with the compiler determining the proper meaning from the context. (You do much the same when you determine the meaning of "sound" in "sound card" versus "sound financial basis.") C++ extends the operator overloading concept by letting you redefine operator meanings for the user-defined types called classes.

## The Manipulator `endl`

Now let's examine an odd-looking notation that appears in the second output statement in Listing 2.1:

```
cout << endl;
```

`endl` is a special C++ notation that represents the important concept of beginning a new line. Inserting `endl` into the output stream causes the screen cursor to move to the beginning of the next line. Special notations like `endl` that have particular meanings to

`cout` are dubbed *manipulators*. Like `cout`, `endl` is defined in the `iostream` header file and is part of the `std` namespace.

Note that the `cout` facility does not move automatically to the next line when it prints a string, so the first `cout` statement in Listing 2.1 leaves the cursor positioned just after the period at the end of the output string. The output for each `cout` statement begins where the last output ended, so omitting `endl` would result in this output for Listing 2.1:

```
Come up and C++ me some time.You won't regret it!
```

Note that the `Y` immediately follows the period. Let's look at another example. Suppose you try this code:

```
cout << "The Good, the";
cout << "Bad, ";
cout << "and the Ukulele";
cout << endl;
```

It produces the following output:

```
The Good, theBad, and the Ukulele
```

Again, note that the beginning of one string comes immediately after the end of the preceding string. If you want a space where two strings join, you must include it in one of the strings. (Remember that to try out these output examples, you have to place them in a complete program, with a `main()` function header and opening and closing braces.)

## The Newline Character

C++ has another, more ancient, way to indicate a new line in output—the C notation `\n`:

```
cout << "What's next?\n";    // \n means start a new line
```

The `\n` combination is considered to be a single character called the *newline* character.

If you are displaying a string, you need less typing to include the newline as part of the string than to tag an `endl` onto the end:

```
cout << "Pluto is a dwarf planet.\n";    // show text, go to next line
cout << "Pluto is a dwarf planet." << endl; // show text, go to next line
```

On the other hand, if you want to generate a newline by itself, both approaches take the same amount of typing, but most people find the keystrokes for `endl` to be more comfortable:

```
cout << "\n";    // start a new line
cout << endl;    // start a new line
```

Typically, this book uses an embedded newline character (`\n`) when displaying quoted strings and the `endl` manipulator otherwise. One difference is that `endl` guarantees the output will be *flushed* (in, this case, immediately displayed onscreen) before the program moves on. You don't get that guarantee with `\n`, which means that it is possible on some

systems in some circumstances a prompt might not be displayed until after you enter the information being prompted for.

The newline character is one example of special keystroke combinations termed “escape sequences”; they are further discussed in Chapter 3, “Dealing with Data.”

## C++ Source Code Formatting

Some languages, such as FORTRAN, are line-oriented, with one statement to a line. For these languages, the carriage return (generated by pressing the Enter key or the Return key) serves to separate statements. In C++, however, the semicolon marks the end of each statement. This leaves C++ free to treat the carriage return in the same way as a space or a tab. That is, in C++ you normally can use a space where you would use a carriage return and vice versa. This means you can spread a single statement over several lines or place several statements on one line. For example, you could reformat `myfirst.cpp` as follows:

```
#include <iostream>
    int
main
() {   using
      namespace
        std; cout
          <<
"Come up and C++ me some time."
;   cout <<
endl; cout <<
"You won't regret it!" <<
endl;return 0; }
```

This is visually ugly but valid code. You do have to observe some rules. In particular, in C and C++ you can't put a space, tab, or carriage return in the middle of an element such as a name, nor can you place a carriage return in the middle of a string. Here are examples of what you can't do:

```
int ma in()    // INVALID -- space in name
re
turn 0; // INVALID -- carriage return in word
cout << "Behold the Beans
of Beauty!"; // INVALID -- carriage return in string
```

(However, the *raw* string, added by C++11 and discussed briefly in Chapter 4, does allow including a carriage return in a string.)

## Tokens and White Space in Source Code

The indivisible elements in a line of code are called *tokens* (see Figure 2.3). Generally, you must separate one token from the next with a space, tab, or carriage return, which collectively are termed *white space*. Some single characters, such as parentheses and commas, are

tokens that need not be set off by white space. Here are some examples that illustrate when white space can be used and when it can be omitted:

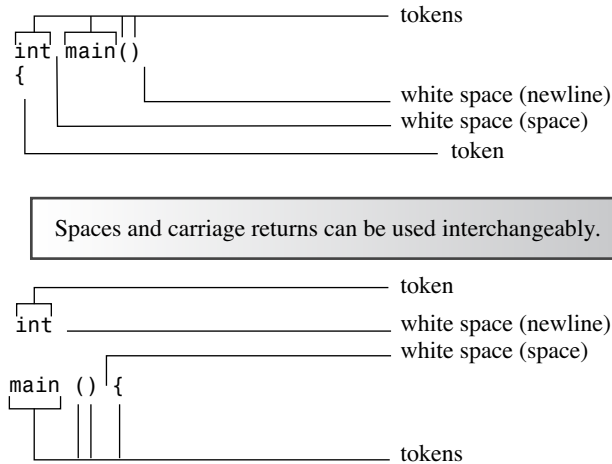

Figure 2.3 Tokens and white space.

```
return0;           // INVALID, must be return 0;
return(0);        // VALID, white space omitted
return (0);       // VALID, white space used
intmain();        // INVALID, white space omitted
int main()        // VALID, white space omitted in ( )
int main ( )     // ALSO VALID, white space used in ( )
```

### C++ Source Code Style

Although C++ gives you much formatting freedom, your programs will be easier to read if you follow a sensible style. Having valid but ugly code should leave you unsatisfied.

Most programmers use styles similar to that of Listing 2.1, which observes these rules:

- One statement per line
- An opening brace and a closing brace for a function, each of which is on its own line
- Statements in a function indented from the braces
- No whitespace around the parentheses associated with a function name

The first three rules have the simple intent of keeping the code clean and readable. The fourth helps to differentiate functions from some built-in C++ structures, such as loops, that also use parentheses. This book alerts you to other guidelines as they come up.

## C++ Statements

A C++ program is a collection of functions, and each function is a collection of statements. C++ has several kinds of statements, so let's look at some of the possibilities. Listing 2.2 provides two new kinds of statements. First, a *declaration statement* creates a variable. Second, an *assignment statement* provides a value for that variable. Also the program shows a new capability for `cout`.

Listing 2.2 `carrots.cpp`

---

```
// carrots.cpp -- food processing program
// uses and displays a variable

#include <iostream>

int main()
{
    using namespace std;

    int carrots;           // declare an integer variable

    carrots = 25;         // assign a value to the variable
    cout << "I have ";
    cout << carrots;      // display the value of the variable
    cout << " carrots.";
    cout << endl;
    carrots = carrots - 1; // modify the variable
    cout << "Crunch, crunch. Now I have " << carrots << " carrots." << endl;
    return 0;
}
```

---

A blank line separates the declaration from the rest of the program. This practice is the usual C convention, but it's somewhat less common in C++. Here is the program output for Listing 2.2:

```
I have 25 carrots.
Crunch, crunch. Now I have 24 carrots.
```

The next few pages examine this program.

### Declaration Statements and Variables

Computers are precise, orderly machines. To store an item of information in a computer, you must identify both the storage location and how much memory storage space the information requires. One relatively painless way to do this in C++ is to use a *declaration statement* to indicate the type of storage and to provide a label for the location. For example, the program in Listing 2.2 has this declaration statement (note the semicolon):

```
int carrots;
```



This statement provides two kinds of information: the type of memory storage needed and a label to attach to that storage. In particular, the statement declares that the program requires enough storage to hold an integer, for which C++ uses the label `int`. The compiler takes care of the details of allocating and labeling memory for that task. C++ can handle several kinds, or types, of data, and the `int` is the most basic data type. It corresponds to an integer, a number with no fractional part. The C++ `int` type can be positive or negative, but the size range depends on the implementation. Chapter 3 provides the details on `int` and the other basic types.

Naming the storage is the second task achieved. In this case, the declaration statement declares that henceforth the program will use the name `carrots` to identify the value stored at that location. `carrots` is called a *variable* because you can change its value. In C++ you must declare all variables. If you were to omit the declaration in `carrots.cpp`, the compiler would report an error when the program attempts to use `carrots` further on. (In fact, you might want to try omitting the declaration just to see how your compiler responds. Then if you see that response in the future, you'll know to check for omitted declarations.)

### Why Must Variables Be Declared?

Some languages, notably BASIC, create a new variable whenever you use a new name, without the aid of explicit declarations. That might seem friendlier to the user, and it is—in the short term. The problem is that if you misspell the name of a variable, you inadvertently can create a new variable without realizing it. That is, in BASIC, you can do something like the following:

```
CastleDark = 34
...
CastleDank = CastleDark + MoreGhosts
...
PRINT CastleDark
```

Because `CastleDank` is misspelled (the *r* was typed as an *n*), the changes you make to it leave `CastleDark` unchanged. This kind of error can be hard to trace because it breaks no rules in BASIC. However, in C++, `CastleDark` would be declared while the misspelled `CastleDank` would not be declared. Therefore, the equivalent C++ code breaks the rule about the need to declare a variable for you to use it, so the compiler catches the error and stomps the potential bug.

In general, then, a declaration indicates the type of data to be stored and the name the program will use for the data that's stored there. In this particular case, the program creates a variable called `carrots` in which it can store an integer (see Figure 2.4).

The declaration statement in the program is called a *defining declaration* statement, or *definition*, for short. This means that its presence causes the compiler to allocate memory space for the variable. In more complex situations, you can also have *reference declarations*. These tell the computer to use a variable that has already been defined elsewhere. In general, a declaration need not be a definition, but in this example it is.

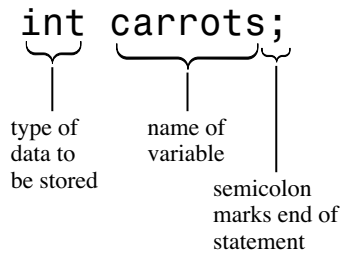

Figure 2.4 A variable declaration.

If you're familiar with C or Pascal, you're already familiar with variable declarations. You also might have a modest surprise in store for you. In C and Pascal, all variable declarations normally come at the very beginning of a function or procedure. But C++ has no such restriction. Indeed, the usual C++ style is to declare a variable just before it is first used. That way, you don't have to rummage back through a program to see what the type is. You'll see an example of this later in this chapter. This style does have the disadvantage of not gathering all your variable names in one place; thus, you can't tell at a glance what variables a function uses. (Incidentally, C99 now makes the rules for C declarations much the same as for C++.)

### Tip

The C++ style for declaring variables is to declare a variable as close to its first use as possible.

## Assignment Statements

An assignment statement assigns a value to a storage location. For example, the following statement assigns the integer 25 to the location represented by the variable `carrots`:

```
carrots = 25;
```

The `=` symbol is called the *assignment operator*. One unusual feature of C++ (and C) is that you can use the assignment operator serially. For example, the following is valid code:

```
int steinway;  
int baldwin;  
int yamaha;  
yamaha = baldwin = steinway = 88;
```

The assignment works from right to left. First, 88 is assigned to `steinway`; then the value of `steinway`, which is now 88, is assigned to `baldwin`; then `baldwin`'s value of 88 is assigned to `yamaha`. (C++ follows C's penchant for allowing weird-appearing code.)

The second assignment statement in Listing 2.2 demonstrates that you can change the value of a variable:

```
carrots = carrots - 1; // modify the variable
```

The expression to the right of the assignment operator (`carrots - 1`) is an example of an arithmetic expression. The computer will subtract 1 from 25, the value of `carrots`, obtaining 24. The assignment operator then stores this new value in the `carrots` location.

## A New Trick for `cout`

Up until now, the examples in this chapter have given `cout` strings to print. Listing 2.2 also gives `cout` a variable whose value is an integer:

```
cout << carrots;
```

The program doesn't print the word `carrots`; instead, it prints the integer value stored in `carrots`, which is 25. Actually, this is two tricks in one. First, `cout` replaces `carrots` with its current numeric value of 25. Second, it translates the value to the proper output characters.

As you can see, `cout` works with both strings and integers. This might not seem particularly remarkable to you, but keep in mind that the integer 25 is something quite different from the string "25". The string holds the characters with which you write the number (that is, a 2 character and a 5 character). The program internally stores the numeric codes for the 2 character and the 5 character. To print the string, `cout` simply prints each character in the string. But the integer 25 is stored as a numeric value. Rather than store each digit separately, the computer stores 25 as a binary number. (Appendix A, "Number Bases," discusses this representation.) The main point here is that `cout` must translate a number in integer form into character form before it can print it. Furthermore, `cout` is smart enough to recognize that `carrots` is an integer that requires conversion.

Perhaps the contrast with old C will indicate how clever `cout` is. To print the string "25" and the integer 25 in C, you could use C's multipurpose output function `printf()`:

```
printf("Printing a string: %s\n", "25");  
printf("Printing an integer: %d\n", 25);
```

Without going into the intricacies of `printf()`, note that you must use special codes (`%s` and `%d`) to indicate whether you are going to print a string or an integer. And if you tell `printf()` to print a string but give it an integer by mistake, `printf()` is too unsophisticated to notice your mistake. It just goes ahead and displays garbage.

The intelligent way in which `cout` behaves stems from C++'s object-oriented features. In essence, the C++ insertion operator (`<<`) adjusts its behavior to fit the type of data that follows it. This is an example of operator overloading. In later chapters, when you take up function overloading and operator overloading, you'll learn how to implement such smart designs yourself.

### `cout` and `printf()`

If you are used to C and `printf()`, you might think `cout` looks odd. You might even prefer to cling to your hard-won mastery of `printf()`. But `cout` actually is no stranger in appearance than `printf()`, with all its conversion specifications. More importantly, `cout` has significant advantages. Its capability to recognize types reflects a more intelligent and foolproof

design. Also, it is *extensible*. That is, you can redefine the `<<` operator so that `cout` can recognize and display new data types you develop. And if you relish the fine control `printf()` provides, you can accomplish the same effects with more advanced uses of `cout` (see Chapter 17, “Input, Output, and Files”).

## More C++ Statements

Let’s look at a couple more examples of statements. The program in Listing 2.3 expands on the preceding example by allowing you to enter a value while the program is running. To do so, it uses `cin` (pronounced “see-in”), the input counterpart to `cout`. Also the program shows yet another way to use that master of versatility, the `cout` object.

Listing 2.3 `getinfo.cpp`

---

```
// getinfo.cpp -- input and output
#include <iostream>

int main()
{
    using namespace std;

    int carrots;

    cout << "How many carrots do you have?" << endl;
    cin >> carrots;           // C++ input
    cout << "Here are two more. ";
    carrots = carrots + 2;
// the next line concatenates output
    cout << "Now you have " << carrots << " carrots." << endl;
    return 0;
}
```

---

### Program Adjustments

If you found that you had to add a `cin.get()` statement in the earlier listings, you will need to add two `cin.get()` statements to this listing to keep the program output visible onscreen. The first one will read the newline generated when you press the Enter or Return key after typing a number, and the second will cause the program to pause until you hit Return or Enter again.

Here is an example of output from the program in Listing 2.3:

```
How many carrots do you have?
12
Here are two more. Now you have 14 carrots.
```

The program has two new features: using `cin` to read keyboard input and combining four output statements into one. Let’s take a look.

## Using `cin`

As the output from Listing 2.3 demonstrates, the value typed from the keyboard (12) is eventually assigned to the variable `carrots`. The following statement performs that wonder:

```
cin >> carrots;
```

Looking at this statement, you can practically see information flowing from `cin` into `carrots`. Naturally, there is a slightly more formal description of this process. Just as C++ considers output to be a stream of characters flowing out of the program, it considers input to be a stream of characters flowing into the program. The `iostream` file defines `cin` as an object that represents this stream. For output, the `<<` operator inserts characters into the output stream. For input, `cin` uses the `>>` operator to extract characters from the input stream. Typically, you provide a variable to the right of the operator to receive the extracted information. (The symbols `<<` and `>>` were chosen to visually suggest the direction in which information flows.)

Like `cout`, `cin` is a smart object. It converts input, which is just a series of characters typed from the keyboard, into a form acceptable to the variable receiving the information. In this case, the program declares `carrots` to be an integer variable, so the input is converted to the numeric form the computer uses to store integers.

## Concatenating with `cout`

The second new feature of `getinfo.cpp` is combining four output statements into one. The `iostream` file defines the `<<` operator so that you can combine (that is, concatenate) output as follows:

```
cout << "Now you have " << carrots << " carrots." << endl;
```

This allows you to combine string output and integer output in a single statement. The resulting output is the same as what the following code produces:

```
cout << "Now you have ";
cout << carrots;
cout << " carrots";
cout << endl;
```

While you're still in the mood for `cout` advice, you can also rewrite the concatenated version this way, spreading the single statement over four lines:

```
cout << "Now you have "
    << carrots
    << " carrots."
    << endl;
```

That's because C++'s free format rules treat newlines and spaces between tokens interchangeably. This last technique is convenient when the line width cramps your style.

Another point to note is that

```
Now you have 14 carrots.
```

appears on the same line as

Here are two more.

That's because, as noted before, the output of one `cout` statement immediately follows the output of the preceding `cout` statement. This is true even if there are other statements in between.

## **`cin` and `cout`: A Touch of Class**

You've seen enough of `cin` and `cout` to justify your exposure to a little object lore. In particular, in this section you'll learn more about the notion of classes. As Chapter 1 outlined briefly, classes are one of the core concepts for object-oriented programming (OOP) in C++.

A *class* is a data type the user defines. To define a class, you describe what sort of information it can represent and what sort of actions you can perform with that data. A class bears the same relationship to an object that a type does to a variable. That is, a class definition describes a data form and how it can be used, whereas an object is an entity created according to the data form specification. Or, in noncomputer terms, if a class is analogous to a category such as famous actors, then an object is analogous to a particular example of that category, such as Kermit the Frog. To extend the analogy, a class representation of actors would include definitions of possible actions relating to the class, such as Reading for a Part, Expressing Sorrow, Projecting Menace, Accepting an Award, and the like. If you've been exposed to different OOP terminology, it might help to know that the C++ class corresponds to what some languages term an *object type*, and the C++ object corresponds to an object instance or instance variable.

Now let's get a little more specific. Recall the following declaration of a variable:

```
int carrots;
```

This creates a particular variable (`carrots`) that has the properties of the `int` type. That is, `carrots` can store an integer and can be used in particular ways—for addition and subtraction, for example. Now consider `cout`. It is an object created to have the properties of the `ostream` class. The `ostream` class definition (another inhabitant of the `iostream` file) describes the sort of data an `ostream` object represents and the operations you can perform with and to it, such as inserting a number or string into an output stream. Similarly, `cin` is an object created with the properties of the `istream` class, also defined in `iostream`.

### **Note**

The class describes all the properties of a data type, including actions that can be performed with it, and an object is an entity created according to that description.

You have learned that classes are user-defined types, but as a user, you certainly didn't design the `ostream` and `istream` classes. Just as functions can come in function libraries, classes can come in class libraries. That's the case for the `ostream` and `istream` classes. Technically, they are not built in to the C++ language; instead, they are examples of classes

that the language standard specifies. The class definitions are laid out in the `iostream` file and are not built into the compiler. You can even modify these class definitions if you like, although that's not a good idea. (More precisely, it is a truly dreadful idea.) The `iostream` family of classes and the related `fstream` (or file I/O) family are the only sets of class definitions that came with all early implementations of C++. However, the ANSI/ISO C++ committee added a few more class libraries to the Standard. Also most implementations provide additional class definitions as part of the package. Indeed, much of the current appeal of C++ is the existence of extensive and useful class libraries that support Unix, Macintosh, and Windows programming.

The class description specifies all the operations that can be performed on objects of that class. To perform such an allowed action on a particular object, you send a message to the object. For example, if you want the `cout` object to display a string, you send it a message that says, in effect, "Object! Display this!" C++ provides a couple ways to send messages. One way, using a class method, is essentially a function call like the ones you'll see soon. The other way, which is the one used with `cin` and `cout`, is to redefine an operator. Thus, the following statement uses the redefined `<<` operator to send the "display message" to `cout`:

```
cout << "I am not a crook."
```

In this case, the message comes with an argument, which is the string to be displayed. (See Figure 2.5 for a similar example.)

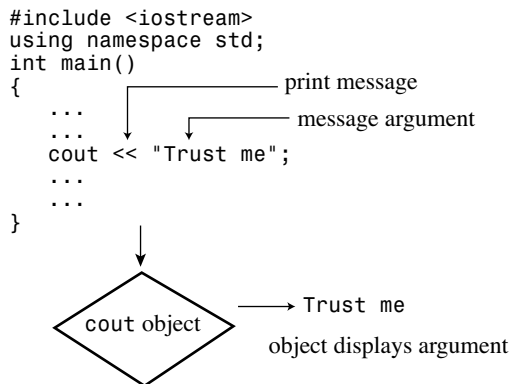

Figure 2.5 Sending a message to an object.

## Functions

Because functions are the modules from which C++ programs are built and because they are essential to C++ OOP definitions, you should become thoroughly familiar with them. Some aspects of functions are advanced topics, so the main discussion of functions comes later, in Chapter 7, "Functions: C++'s Programming Modules," and Chapter 8,

“Adventures in Functions.” However, if we deal now with some basic characteristics of functions, you’ll be more at ease and more practiced with functions later. The rest of this chapter introduces you to these function basics.

C++ functions come in two varieties: those with return values and those without them. You can find examples of each kind in the standard C++ library of functions, and you can create your own functions of each type. Let’s look at a library function that has a return value and then examine how you can write your own simple functions.

## Using a Function That Has a Return Value

A function that has a return value produces a value that you can assign to a variable or use in some other expression. For example, the standard C/C++ library includes a function called `sqrt()` that returns the square root of a number. Suppose you want to calculate the square root of 6.25 and assign it to the variable `x`. You can use the following statement in your program:

```
x = sqrt(6.25); // returns the value 2.5 and assigns it to x
```

The expression `sqrt(6.25)` invokes, or *calls*, the `sqrt()` function. The expression `sqrt(6.25)` is termed a *function call*, the invoked function is termed the *called function*, and the function containing the function call is termed the *calling function* (see Figure 2.6).

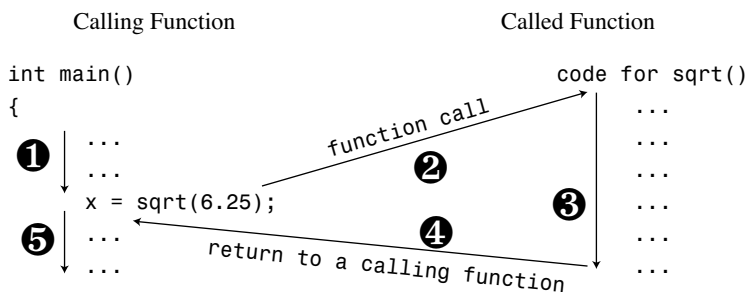

Figure 2.6 Calling a function.

The value in the parentheses (6.25, in this example) is information that is sent to the function; it is said to be *passed* to the function. A value that is sent to a function this way is called an *argument* or *parameter* (see Figure 2.7). The `sqrt()` function calculates the answer to be 2.5 and sends that value back to the calling function; the value sent back is termed the *return value* of the function. Think of the return value as what is substituted for the function call in the statement after the function finishes its job. Thus, this example assigns the return value to the variable `x`. In short, an argument is information sent to the function, and the return value is a value sent back from the function.



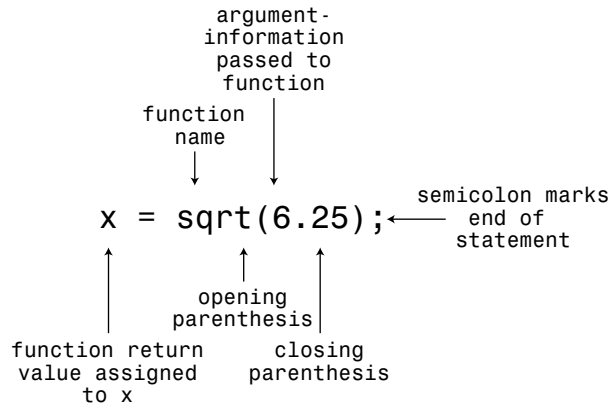

Figure 2.7 Function call syntax.

That's practically all there is to it, except that before the C++ compiler uses a function, it must know what kind of arguments the function uses and what kind of return value it has. That is, does the function return an integer? a character? a number with a decimal fraction? a guilty verdict? or something else? If it lacks this information, the compiler won't know how to interpret the return value. The C++ way to convey this information is to use a function prototype statement.

### Note

A C++ program should provide a prototype for each function used in the program.

A function prototype does for functions what a variable declaration does for variables: It tells what types are involved. For example, the C++ library defines the `sqrt()` function to take a number with (potentially) a fractional part (like 6.25) as an argument and to return a number of the same type. Some languages refer to such numbers as *real numbers*, but the name C++ uses for this type is `double`. (You'll see more of `double` in Chapter 3.) The function prototype for `sqrt()` looks like this:

```
double sqrt(double); // function prototype
```

The initial `double` means `sqrt()` returns a type `double` value. The `double` in the parentheses means `sqrt()` requires a `double` argument. So this prototype describes `sqrt()` exactly as used in the following code:

```
double x; // declare x as a type double variable
x = sqrt(6.25);
```

The terminating semicolon in the prototype identifies it as a statement and thus makes it a prototype instead of a function header. If you omit the semicolon, the compiler interprets the line as a function header and expects you to follow it with a function body that defines the function.

When you use `sqrt()` in a program, you must also provide the prototype. You can do this in either of two ways:

- You can type the function prototype into your source code file yourself.
- You can include the `cmath` (`math.h` on older systems) header file, which has the prototype in it.

The second way is better because the header file is even more likely than you to get the prototype right. Every function in the C++ library has a prototype in one or more header files. Just check the function description in your manual or with online help, if you have it, and the description tells you which header file to use. For example, the description of the `sqrt()` function should tell you to use the `cmath` header file. (Again, you might have to use the older `math.h` header file, which works for both C and C++ programs.)

Don't confuse the function prototype with the function definition. The prototype, as you've seen, only describes the function interface. That is, it describes the information sent to the function and the information sent back. The definition, however, includes the code for the function's workings—for example, the code for calculating the square root of a number. C and C++ divide these two features—prototype and definition—for library functions. The library files contain the compiled code for the functions, whereas the header files contain the prototypes.

You should place a function prototype ahead of where you first use the function. The usual practice is to place prototypes just before the definition of the `main()` function. Listing 2.4 demonstrates the use of the library function `sqrt()`; it provides a prototype by including the `cmath` file.

#### Listing 2.4 `sqrt.cpp`

---

```
// sqrt.cpp -- using the sqrt() function

#include <iostream>
#include <cmath>    // or math.h

int main()
{
    using namespace std;

    double area;
    cout << "Enter the floor area, in square feet, of your home: ";
    cin >> area;
    double side;
    side = sqrt(area);
    cout << "That's the equivalent of a square " << side
         << " feet to the side." << endl;
    cout << "How fascinating!" << endl;
    return 0;
}
```

---

### Using Library Functions

C++ library functions are stored in library files. When the compiler compiles a program, it must search the library files for the functions you've used. Compilers differ on which library files they search automatically. If you try to run Listing 2.4 and get a message that `_sqrt` is an undefined external (sounds like a condition to avoid!), chances are that your compiler doesn't automatically search the math library. (Compilers like to add an underscore prefix to function names—another subtle reminder that they have the last say about your program.) If you get such a message, check your compiler documentation to see how to have the compiler search the correct library. If you get such a complaint on a Unix implementation, for example, it may require that you use the `-lm` option (for *library math*) at the end of the command line:

```
CC sqrt.C -lm
```

Some versions of the Gnu compiler under Linux behave similarly:

```
g++ sqrt.C -lm
```

Merely including the `cmath` header file provides the prototype but does not necessarily cause the compiler to search the correct library file.

Here's a sample run of the program in Listing 2.4:

```
Enter the floor area, in square feet, of your home: 1536
That's the equivalent of a square 39.1918 feet to the side.
How fascinating!
```

Because `sqrt()` works with type `double` values, the example makes the variables that type. Note that you declare a type `double` variable by using the same form, or syntax, as when you declare a type `int` variable:

```
type-name variable-name;
```

Type `double` allows the variables `area` and `side` to hold values with decimal fractions, such as `1536.0` and `39.1918`. An apparent integer, such as `1536`, is stored as a real value with a decimal fraction part of `.0` when stored in a type `double` variable. As you'll see in Chapter 3, type `double` encompasses a much greater range of values than type `int`.

C++ allows you to declare new variables anywhere in a program, so `sqrt.cpp` didn't declare `side` until just before using it. C++ also allows you to assign a value to a variable when you create it, so you could also have done this:

```
double side = sqrt(area);
```

You'll learn more about this process, called *initialization*, in Chapter 3.

Note that `cin` knows how to convert information from the input stream to type `double`, and `cout` knows how to insert type `double` into the output stream. As noted earlier, these objects are smart.

## Function Variations

Some functions require more than one item of information. These functions use multiple arguments separated by commas. For example, the math function `pow()` takes two arguments and returns a value equal to the first argument raised to the power given by the second argument. It has this prototype:

```
double pow(double, double); // prototype of a function with two arguments
```

If, say, you wanted to find  $5^8$  (5 to the eighth power), you would use the function like this:

```
answer = pow(5.0, 8.0); // function call with a list of arguments
```

Other functions take no arguments. For example, one of the C libraries (the one associated with the `cstdlib` or the `stdlib.h` header file) has a `rand()` function that has no arguments and that returns a random integer. Its prototype looks like this:

```
int rand(void); // prototype of a function that takes no arguments
```

The keyword `void` explicitly indicates that the function takes no arguments. If you omit `void` and leave the parentheses empty, C++ interprets this as an implicit declaration that there are no arguments. You could use the function this way:

```
myGuess = rand(); // function call with no arguments
```

Note that unlike some computer languages, in C++ you must use the parentheses in the function call even if there are no arguments.

There also are functions that have no return value. For example, suppose you wrote a function that displayed a number in dollars-and-cents format. You could send to it an argument of, say, 23.5, and it would display \$23.50 onscreen. Because this function sends a value to the screen instead of to the calling program, it doesn't require a return value. You indicate this in the prototype by using the keyword `void` for the return type:

```
void bucks(double); // prototype for function with no return value
```

Because `bucks()` doesn't return a value, you can't use this function as part of an assignment statement or of some other expression. Instead, you have a pure function call statement:

```
bucks(1234.56); // function call, no return value
```

Some languages reserve the term *function* for functions with return values and use the terms *procedure* or *subroutine* for those without return values, but C++, like C, uses the term *function* for both variations.

## User-Defined Functions

The standard C library provides more than 140 predefined functions. If one fits your needs, by all means use it. But often you have to write your own, particularly when you design classes. Anyway, it's fun to design your own functions, so now let's examine that process. You've already used several user-defined functions, and they have all been named `main()`. Every C++ program must have a `main()` function, which the user must define.

Suppose you want to add a second user-defined function. Just as with a library function, you can call a user-defined function by using its name. And, as with a library function, you must provide a function prototype before using the function, which you typically do by placing the prototype above the `main()` definition. But now you, not the library vendor, must provide source code for the new function. The simplest way is to place the code in the same file after the code for `main()`. Listing 2.5 illustrates these elements.

#### Listing 2.5 `ourfunc.cpp`

---

```
// ourfunc.cpp -- defining your own function
#include <iostream>
void simon(int);    // function prototype for simon()

int main()
{
    using namespace std;
    simon(3);        // call the simon() function
    cout << "Pick an integer: ";
    int count;
    cin >> count;
    simon(count);   // call it again
    cout << "Done!" << endl;
    return 0;
}

void simon(int n)    // define the simon() function
{
    using namespace std;
    cout << "Simon says touch your toes " << n << " times." << endl;
}
// void functions don't need return statements
```

---

The `main()` function calls the `simon()` function twice, once with an argument of 3 and once with a variable argument `count`. In between, the user enters an integer that's used to set the value of `count`. The example doesn't use a newline character in the `cout` prompting message. This results in the user input appearing on the same line as the prompt. Here is a sample run of the program in Listing 2.5:

```
Simon says touch your toes 3 times.
Pick an integer: 512
Simon says touch your toes 512 times.
Done!
```

### Function Form

The definition for the `simon()` function in Listing 2.5 follows the same general form as the definition for `main()`. First, there is a function header. Then, enclosed in braces, comes the function body. You can generalize the form for a function definition as follows:

```

type functionname(argumentlist)
{
    statements
}

```

Note that the source code that defines `simon()` follows the closing brace of `main()`. Like C, and unlike Pascal, C++ does not allow you to embed one function definition inside another. Each function definition stands separately from all others; all functions are created equal (see Figure 2.8).

```

                                #include <iostream>
                                using namespace std;

function prototypes { void simon(int);
                    { double taxes(double);

function #1 { int main()
             { {
               ...
               return 0;
             }

function #2 { void simon(int n)
             { {
               ...
             }

function #3 { double taxes(double t)
             { {
               ...
               return 2 * t;
             }

```

Figure 2.8 Function definitions occur sequentially in a file.

## Function Headers

The `simon()` function in Listing 2.5 has this header:

```
void simon(int n)
```

The initial `void` means that `simon()` has no return value. So calling `simon()` doesn't produce a number that you can assign to a variable in `main()`. Thus, the first function call looks like this:

```
simon(3);           // ok for void functions
```

Because poor `simon()` lacks a return value, you can't use it this way:

```
simple = simon(3);  // not allowed for void functions
```

The `int n` within the parentheses means that you are expected to use `simon()` with a single argument of type `int`. The `n` is a new variable assigned the value passed during a

function call. Thus, the following function call assigns the value 3 to the `n` variable defined in the `simon()` header:

```
simon(3);
```

When the `cout` statement in the function body uses `n`, it uses the value passed in the function call. That's why `simon(3)` displays a 3 in its output. The call to `simon(count)` in the sample run causes the function to display 512 because that was the value entered for `count`. In short, the header for `simon()` tells you that this function takes a single type `int` argument and that it doesn't have a return value.

Let's review `main()`'s function header:

```
int main()
```

The initial `int` means that `main()` returns an integer value. The empty parentheses (which optionally could contain `void`) means that `main()` has no arguments. Functions that have return values should use the keyword `return` to provide the return value and to terminate the function. That's why you've been using the following statement at the end of `main()`:

```
return 0;
```

This is logically consistent: `main()` is supposed to return a type `int` value, and you have it return the integer 0. But, you might wonder, to what are you returning a value? After all, nowhere in any of your programs have you seen anything calling `main()`:

```
squeeze = main(); // absent from our programs
```

The answer is that you can think of your computer's operating system (Unix, say, or Windows) as calling your program. So `main()`'s return value is returned not to another part of the program but to the operating system. Many operating systems can use the program's return value. For example, Unix shell scripts and Windows's command-line interface batch files can be designed to run programs and test their return values, usually called *exit values*. The normal convention is that an exit value of zero means the program ran successfully, whereas a nonzero value means there was a problem. Thus, you can design a C++ program to return a nonzero value if, say, it fails to open a file. You can then design a shell script or batch file to run that program and to take some alternative action if the program signals failure.

### Keywords

Keywords are the vocabulary of a computer language. This chapter has used four C++ keywords: `int`, `void`, `return`, and `double`. Because these keywords are special to C++, you can't use them for other purposes. That is, you can't use `return` as the name for a variable or `double` as the name of a function. But you can use them as part of a name, as in `painter` (with its hidden `int`) or `return_aces`. Appendix B, "C++ Reserved Words," provides a complete list of C++ keywords. Incidentally, `main` is not a keyword because it's not part of the language. Instead, it is the name of a required function. You can use `main` as a variable name. (That can cause a problem in circumstances too esoteric to describe here, and because it is confusing in any case, you'd best not.) Similarly, other function names and

object names are not keywords. However, using the same name, say `cout`, for both an object and a variable in a program confuses the compiler. That is, you can use `cout` as a variable name in a function that doesn't use the `cout` object for output, but you can't use `cout` both ways in the same function.

## Using a User-Defined Function That Has a Return Value

Let's go one step further and write a function that uses the return statement. The `main()` function already illustrates the plan for a function with a return value: Give the return type in the function header and use `return` at the end of the function body. You can use this form to solve a weighty problem for those visiting the United Kingdom. In the United Kingdom, many bathroom scales are calibrated in *stone* instead of in U.S. pounds or international kilograms. The word *stone* is both singular and plural in this context. (The English language does lack the internal consistency of, say, C++.) One stone is 14 pounds, and the program in Listing 2.6 uses a function to make this conversion.

### Listing 2.6 `convert.cpp`

---

```
// convert.cpp -- converts stone to pounds
#include <iostream>
int stonetolb(int);    // function prototype
int main()
{
    using namespace std;
    int stone;
    cout << "Enter the weight in stone: ";
    cin >> stone;
    int pounds = stonetolb(stone);
    cout << stone << " stone = ";
    cout << pounds << " pounds." << endl;
    return 0;
}

int stonetolb(int sts)
{
    return 14 * sts;
}
```

---

Here's a sample run of the program in Listing 2.6:

```
Enter the weight in stone: 15
15 stone = 210 pounds.
```

In `main()`, the program uses `cin` to provide a value for the integer variable `stone`. This value is passed to the `stonetolb()` function as an argument and is assigned to the variable `sts` in that function. `stonetolb()` then uses the `return` keyword to return the value of `14 * sts` to `main()`. This illustrates that you aren't limited to following `return` with a simple number. Here, by using a more complex expression, you avoid the bother of having



to create a new variable to which to assign the value before returning it. The program calculates the value of that expression (210 in this example) and returns the resulting value. If returning the value of an expression bothers you, you can take the longer route:

```
int stonetolb(int sts)
{
    int pounds = 14 * sts;
    return pounds;
}
```

Both versions produce the same result. The second version, because it separates the computation process from the return process, is easier to read and modify.

In general, you can use a function with a return value wherever you would use a simple constant of the same type. For example, `stonetolb()` returns a type `int` value. This means you can use the function in the following ways:

```
int aunt = stonetolb(20);
int aunts = aunt + stonetolb(10);
cout << "Ferdie weighs " << stonetolb(16) << " pounds." << endl;
```

In each case, the program calculates the return value and then uses that number in these statements.

As these examples show, the function prototype describes the function interface—that is, how the function interacts with the rest of the program. The argument list shows what sort of information goes into the function, and the function type shows the type of value returned. Programmers sometimes describe functions as *black boxes* (a term from electronics) specified by the flow of information into and out of them. The function prototype perfectly portrays that point of view (see Figure 2.9).

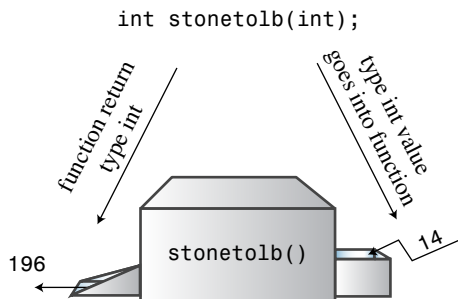

Figure 2.9 The function prototype and the function as a black box.

The `stonetolb()` function is short and simple, yet it embodies a full range of functional features:

- It has a header and a body.
- It accepts an argument.

- It returns a value.
- It requires a prototype.

Consider `stoneto1b()` as a standard form for function design. You'll further explore functions in Chapters 7 and 8. In the meantime, the material in this chapter should give you a good feel for how functions work and how they fit into C++.

## Placing the `using` Directive in Multifunction Programs

Notice that Listing 2.5 places a `using` directive in each of the two functions:

```
using namespace std;
```

This is because each function uses `cout` and thus needs access to the `cout` definition from the `std` namespace.

There's another way to make the `std` namespace available to both functions in Listing 2.5, and that's to place the directive outside and above both functions:

```
// ourfunc1.cpp -- repositioning the using directive
#include <iostream>
using namespace std; // affects all function definitions in this file
void simon(int);

int main()
{
    simon(3);
    cout << "Pick an integer: ";
    int count;
    cin >> count;
    simon(count);
    cout << "Done!" << endl;
    return 0;
}

void simon(int n)
{
    cout << "Simon says touch your toes " << n << " times." << endl;
}
```

The current prevalent philosophy is that it's preferable to be more discriminating and limit access to the `std` namespace to only those functions that need access. For example, in Listing 2.6, only `main()` uses `cout`, so there is no need to make the `std` namespace available to the `stoneto1b()` function. Thus, the `using` directive is placed inside the `main()` function only, limiting `std` namespace access to just that function.

In summary, you have several choices for making `std` namespace elements available to a program. Here are some:

- You can place the following above the function definitions in a file, making all the contents of the `std` namespace available to every function in the file:

```
using namespace std;
```

- You can place the following in a specific function definition, making all the contents of the `std` namespace available to that specific function:

```
using namespace std;
```

- Instead of using

```
using namespace std;
```

you can place `using` declarations like the following in a specific function definition and make a particular element, such as `cout`, available to that function:

```
using std::cout;
```

- You can omit the `using` directives and declarations entirely and use the `std::` prefix whenever you use elements from the `std` namespace:

```
std::cout << "I'm using cout and endl from the std namespace" << std::endl;
```

## Naming Conventions

C++ programmers are blessed (or cursed) with myriad options when naming functions, classes, and variables. Programmers have strong and varied opinions about style, and these often surface as holy wars in public forums. Starting with the same basic idea for a function name, a programmer might select any of the following:

```
MyFunction( )
myfunction( )
myFunction( )
my_function( )
my_funct( )
```

The choice will depend on the development team, the idiosyncrasies of the technologies or libraries used, and the tastes and preferences of the individual programmer. Rest assured that any style consistent with the C++ rules presented in Chapter 3 is correct as far as the C++ language is concerned, and it can be used based on your own judgment.

Language allowances aside, it is worth noting that a personal naming style—one that aids you through consistency and precision—is well worth pursuing. A precise, recognizable personal naming convention is a hallmark of good software engineering, and it will aid you throughout your programming career.

## Summary

A C++ program consists of one or more modules called functions. Programs begin executing at the beginning of the function called `main()` (all lowercase), so you should always have a function by this name. A function, in turn, consists of a header and a body. The function header tells you what kind of return value, if any, the function produces and what sort of information it expects arguments to pass to it. The function body consists of a series of C++ statements enclosed in paired braces `{ }`.

C++ statement types include the following:

- **Declaration statement**—A declaration statement announces the name and the type of a variable used in a function.
- **Assignment statement**—An assignment statement uses the assignment operator (`=`) to assign a value to a variable.
- **Message statement**—A message statement sends a message to an object, initiating some sort of action.
- **Function call**—A function call activates a function. When the called function terminates, the program returns to the statement in the calling function immediately following the function call.
- **Function prototype**—A function prototype declares the return type for a function, along with the number and type of arguments the function expects.
- **Return statement**—A return statement sends a value from a called function back to the calling function.

A class is a user-defined specification for a data type. This specification details how information is to be represented and also the operations that can be performed with the data. An object is an entity created according to a class prescription, just as a simple variable is an entity created according to a data type description.

C++ provides two predefined objects (`cin` and `cout`) for handling input and output. They are examples of the `istream` and `ostream` classes, which are defined in the `iostream` file. These classes view input and output as streams of characters. The insertion operator (`<<`), which is defined for the `ostream` class, lets you insert data into the output stream, and the extraction operator (`>>`), which is defined for the `istream` class, lets you extract information from the input stream. Both `cin` and `cout` are smart objects, capable of automatically converting information from one form to another according to the program context.

C++ can use the extensive set of C library functions. To use a library function, you should include the header file that provides the prototype for the function.

Now that you have an overall view of simple C++ programs, you can go on in the next chapters to fill in details and expand horizons.

## Chapter Review

You can find the answers to the chapter review at the end of each chapter in Appendix J, “Answers to Chapter Review.”

1. What are the modules of C++ programs called?
2. What does the following preprocessor directive do?  

```
#include <iostream>
```
3. What does the following statement do?  

```
using namespace std;
```
4. What statement would you use to print the phrase “Hello, world” and then start a new line?
5. What statement would you use to create an integer variable with the name `cheeses`?
6. What statement would you use to assign the value 32 to the variable `cheeses`?
7. What statement would you use to read a value from keyboard input into the variable `cheeses`?
8. What statement would you use to print “We have X varieties of cheese,” where the current value of the `cheeses` variable replaces `X`?
9. What do the following function prototypes tell you about the functions?  

```
int froop(double t);
void rattle(int n);
int prune(void);
```
10. When do you not have to use the keyword `return` when you define a function?
11. Suppose your `main()` function has the following line:  

```
cout << "Please enter your PIN: ";
```

And suppose the compiler complains that `cout` is an unknown identifier. What is the likely cause of this complaint, and what are three ways to fix the problem?

## Programming Exercises

1. Write a C++ program that displays your name and address (or if you value your privacy, a fictitious name and address).
2. Write a C++ program that asks for a distance in furlongs and converts it to yards. (One furlong is 220 yards.)

3. Write a C++ program that uses three user-defined functions (counting `main()` as one) and produces the following output:

```
Three blind mice
Three blind mice
See how they run
See how they run
```

One function, called two times, should produce the first two lines, and the remaining function, also called twice, should produce the remaining output.

4. Write a program that asks the user to enter his or her age. The program then should display the age in months:

```
Enter your age: 29
```

```
Your age in months is 384.
```

5. Write a program that has `main()` call a user-defined function that takes a Celsius temperature value as an argument and then returns the equivalent Fahrenheit value. The program should request the Celsius value as input from the user and display the result, as shown in the following code:

```
Please enter a Celsius value: 20
20 degrees Celsius is 68 degrees Fahrenheit.
```

For reference, here is the formula for making the conversion:

$$\text{Fahrenheit} = 1.8 \times \text{degrees Celsius} + 32.0$$

6. Write a program that has `main()` call a user-defined function that takes a distance in light years as an argument and then returns the distance in astronomical units. The program should request the light year value as input from the user and display the result, as shown in the following code:

```
Enter the number of light years: 4.2
4.2 light years = 265608 astronomical units.
```

An astronomical unit is the average distance from the earth to the sun (about 150,000,000 km or 93,000,000 miles), and a light year is the distance light travels in a year (about 10 trillion kilometers or 6 trillion miles). (The nearest star after the sun is about 4.2 light years away.) Use type `double` (as in Listing 2.4) and this conversion factor:

$$1 \text{ light year} = 63,240 \text{ astronomical units}$$

7. Write a program that asks the user to enter an hour value and a minute value. The `main()` function should then pass these two values to a type `void` function that displays the two values in the format shown in the following sample run:

```
Enter the number of hours: 9
Enter the number of minutes: 28
Time: 9:28
```

*This page intentionally left blank*

# Dealing with Data

In this chapter you'll learn about the following:

- Rules for naming C++ variables
- C++'s built-in integer types: `unsigned long`, `long`, `unsigned int`, `int`, `unsigned short`, `short`, `char`, `unsigned char`, `signed char`, `bool`
- C++11's additions: `unsigned long long` and `long long`
- The `climits` file, which represents system limits for various integer types
- Numeric literals (constants) of various integer types
- Using the `const` qualifier to create symbolic constants
- C++'s built-in floating-point types: `float`, `double`, and `long double`
- The `cmath` file, which represents system limits for various floating-point types
- Numeric literals of various floating-point types
- C++'s arithmetic operators
- Automatic type conversions
- Forced type conversions (type casts)

The essence of object-oriented programming (OOP) is designing and extending your own data types. Designing your own data types represents an effort to make a type match the data. If you do this properly, you'll find it much simpler to work with the data later. But before you can create your own types, you must know and understand the types that are built in to C++ because those types will be your building blocks.

The built-in C++ types come in two groups: fundamental types and compound types. In this chapter you'll meet the fundamental types, which represent integers and floating-point numbers. That might sound like just two types; however, C++ recognizes that no one integer type and no one floating-point type match all programming requirements, so it offers several variants on these two data themes. Chapter 4, "Compound Types," follows up by covering several types that are built on the basic types; these additional compound types include arrays, strings, pointers, and structures.



Of course, a program also needs a means to identify stored data. In this chapter you'll examine one method for doing so—using variables. Then you'll look at how to do arithmetic in C++. Finally, you'll see how C++ converts values from one type to another.

## Simple Variables

Programs typically need to store information—perhaps the current price of Google stock, the average humidity in New York City in August, the most common letter in the U.S. Constitution and its relative frequency, or the number of available Elvis impersonators. To store an item of information in a computer, the program must keep track of three fundamental properties:

- Where the information is stored
- What value is kept there
- What kind of information is stored

The strategy the examples in this book have used so far is to declare a variable. The type used in the declaration describes the kind of information, and the variable name represents the value symbolically. For example, suppose Chief Lab Assistant Igor uses the following statements:

```
int braincount;  
braincount = 5;
```

These statements tell the program that it is storing an integer and that the name `braincount` represents the integer's value, 5 in this case. In essence, the program locates a chunk of memory large enough to hold an integer, notes the location, and copies the value 5 into the location. You then can use `braincount` later in your program to access that memory location. These statements don't tell you (or Igor) where in memory the value is stored, but the program does keep track of that information, too. Indeed, you can use the `&` operator to retrieve `braincount`'s address in memory. You'll learn about that operator in the next chapter, when you investigate a second strategy for identifying data—using pointers.

## Names for Variables

C++ encourages you to use meaningful names for variables. If a variable represents the cost of a trip, you should call it `cost_of_trip` or `costOfTrip`, not just `x` or `cot`. You do have to follow a few simple C++ naming rules:

- The only characters you can use in names are alphabetic characters, numeric digits, and the underscore (`_`) character.
- The first character in a name cannot be a numeric digit.
- Uppercase characters are considered distinct from lowercase characters.

- You can't use a C++ keyword for a name.
- Names beginning with two underscore characters or with an underscore character followed by an uppercase letter are reserved for use by the implementation—that is, the compiler and the resources it uses. Names beginning with a single underscore character are reserved for use as global identifiers by the implementation.
- C++ places no limits on the length of a name, and all characters in a name are significant. However, some platforms might have their own length limits.

The next-to-last point is a bit different from the preceding points because using a name such as `__time_stop` or `_Donut` doesn't produce a compiler error; instead, it leads to undefined behavior. In other words, there's no telling what the result will be. The reason there is no compiler error is that the names are not illegal but rather are reserved for the implementation to use. The bit about global names refers to where the names are declared; Chapter 4 touches on that topic.

The final point differentiates C++ from ANSI C (C99), which guarantees only that the first 63 characters in a name are significant. (In ANSI C, two names that have the same first 63 characters are considered identical, even if the 64th characters differ.)

Here are some valid and invalid C++ names:

```
int poodle;    // valid
int Poodle;   // valid and distinct from poodle
int POODLE;   // valid and even more distinct
Int terrier;  // invalid -- has to be int, not Int
int my_stars3 // valid
int _Mystars3; // valid but reserved -- starts with underscore
int 4ever;    // invalid because starts with a digit
int double;   // invalid -- double is a C++ keyword
int begin;    // valid -- begin is a Pascal keyword
int __fools;  // valid but reserved -- starts with two underscores
int the_very_best_variable_i_can_be_version_112; // valid
int honky-tonk; // invalid -- no hyphens allowed
```

If you want to form a name from two or more words, the usual practice is to separate the words with an underscore character, as in `my_onions`, or to capitalize the initial character of each word after the first, as in `myEyeTooth`. (C veterans tend to use the underscore method in the C tradition, whereas those raised in the Pascal tradition prefer the capitalization approach.) Either form makes it easier to see the individual words and to distinguish between, say, `carDrip` and `cardRip`, or `boat_sport` and `boats_port`.

## Naming Schemes

Schemes for naming variables, like schemes for naming functions, provide fertile ground for fervid discussion. Indeed, this topic produces some of the most strident disagreements in programming. Again, as with function names, the C++ compiler doesn't care about your variable names as long as they satisfy the rules, but a consistent, precise personal naming convention will serve you well.

As in function naming, capitalization is a key issue in variable naming (see the sidebar “Naming Conventions” in Chapter 2, “Setting Out to C++”), but many programmers may insert an additional level of information in a variable name—a prefix that describes the variable’s type or contents. For instance, the integer `myWeight` might be named `nMyWeight`; here, the `n` prefix is used to represent an integer value, which is useful when you are reading code and the definition of the variable isn’t immediately at hand. Alternatively, this variable might be named `intMyWeight`, which is more precise and legible, although it does include a couple extra letters (anathema to many programmers). Other prefixes are commonly used in like fashion: `str` or `sz` might be used to represent a null-terminated string of characters, `b` might represent a Boolean value, `p` a pointer, `c` a single character.

As you progress into the world of C++, you will find many examples of the prefix naming style (including the handsome `m_lpcstr` prefix—a class member value that contains a long pointer to a constant, null-terminated string of characters), as well as other, more bizarre and possibly counterintuitive styles that you may or may not adopt as your own. As in all the stylistic, subjective parts of C++, consistency and precision are best. You should use variable names to fit your own needs, preferences, and personal style. (Or, if required, choose names that fit the needs, preferences, and personal style of your employer.)

## Integer Types

*Integers* are numbers with no fractional part, such as 2, 98, -5286, and 0. There are lots of integers, assuming that you consider an infinite number to be a lot, so no finite amount of computer memory can represent all possible integers. Thus, a language can represent only a subset of all integers. Some languages offer just one integer type (one type fits all!), but C++ provides several choices. This gives you the option of choosing the integer type that best meets a program’s particular requirements. This concern with matching type to data presages the designed data types of OOP.

The various C++ integer types differ in the amount of memory they use to hold an integer. A larger block of memory can represent a larger range in integer values. Also some types (signed types) can represent both positive and negative values, whereas others (unsigned types) can’t represent negative values. The usual term for describing the amount of memory used for an integer is *width*. The more memory a value uses, the wider it is. C++’s basic integer types, in order of increasing width, are `char`, `short`, `int`, `long`, and, with C++11, `long long`. Each comes in both signed and unsigned versions. That gives you a choice of ten different integer types! Let’s look at these integer types in more detail. Because the `char` type has some special properties (it’s most often used to represent characters instead of numbers), this chapter covers the other types first.

## The short, int, long, and long long Integer Types

Computer memory consists of units called *bits*. (See the “Bits and Bytes” sidebar later in this chapter.) By using different numbers of bits to store values, the C++ types `short`, `int`, `long`, and `long long` can represent up to four different integer widths. It would be convenient if each type were always some particular width for all systems—for example, if `short` were always 16 bits, `int` were always 32 bits, and so on. But life is not that simple.

No one choice is suitable for all computer designs. C++ offers a flexible standard with some guaranteed minimum sizes, which it takes from C. Here's what you get:

- A `short` integer is at least 16 bits wide.
- An `int` integer is at least as big as `short`.
- A `long` integer is at least 32 bits wide and at least as big as `int`.
- A `long long` integer is at least 64 bits wide and at least as big as `long`.

## Bits and Bytes

The fundamental unit of computer memory is the *bit*. Think of a bit as an electronic switch that you can set to either off or on. Off represents the value 0, and on represents the value 1. An 8-bit chunk of memory can be set to 256 different combinations. The number 256 comes from the fact that each bit has two possible settings, making the total number of combinations for 8 bits  $2 \times 2 \times 2 \times 2 \times 2 \times 2 \times 2 \times 2$ , or 256. Thus, an 8-bit unit can represent, say, the values 0 through 255 or the values -128 through 127. Each additional bit doubles the number of combinations. This means you can set a 16-bit unit to 65,536 different values, a 32-bit unit to 4,294,967,296 different values, and a 64-bit unit to 18,446,744,073,709,551,616 different values. As a point of comparison, `unsigned long` can't hold the Earth's current population or the number of stars in our galaxy, but `long long` can.

A *byte* usually means an 8-bit unit of memory. *Byte* in this sense is the unit of measurement that describes the amount of memory in a computer, with a kilobyte equal to 1,024 bytes and a megabyte equal to 1,024 kilobytes. However, C++ defines *byte* differently. The C++ *byte* consists of at least enough adjacent bits to accommodate the basic character set for the implementation. That is, the number of possible values must equal or exceed the number of distinct characters. In the United States, the basic character sets are usually the ASCII and EBCDIC sets, each of which can be accommodated by 8 bits, so the C++ *byte* is typically 8 bits on systems using those character sets. However, international programming can require much larger character sets, such as Unicode, so some implementations may use a 16-bit *byte* or even a 32-bit *byte*. Some use the term *octet* to denote an 8-bit *byte*.

Many systems currently use the minimum guarantee, making `short` 16 bits and `long` 32 bits. This still leaves several choices open for `int`. It could be 16, 24, or 32 bits in width and meet the standard. It could even be 64 bits, providing that `long` and `long long` are at least that wide. Typically, `int` is 16 bits (the same as `short`) for older IBM PC implementations and 32 bits (the same as `long`) for Windows XP, Windows Vista, Windows 7, Macintosh OS X, VAX, and many other minicomputer implementations. Some implementations give you a choice of how to handle `int`. (What does your implementation use? The next example shows you how to determine the limits for your system without your having to open a manual.) The differences between implementations for type widths can cause problems when you move a C++ program from one environment to another, including using a different compiler on the same system. But a little care, as discussed later in this chapter, can minimize those problems.

You use these type names to declare variables just as you would use `int`:

```
short score;           // creates a type short integer variable
int temperature;      // creates a type int integer variable
long position;        // creates a type long integer variable
```

Actually, `short` is short for `short int` and `long` is short for `long int`, but hardly anyone uses the longer forms.

The four types—`int`, `short`, `long`, and `long long`—are signed types, meaning each splits its range approximately equally between positive and negative values. For example, a 16-bit `int` might run from  $-32,768$  to  $+32,767$ .

If you want to know how your system's integers size up, you can use C++ tools to investigate type sizes with a program. First, the `sizeof` operator returns the size, in bytes, of a type or a variable. (An *operator* is a built-in language element that operates on one or more items to produce a value. For example, the addition operator, represented by `+`, adds two values.) Recall that the meaning of *byte* is implementation dependent, so a 2-byte `int` could be 16 bits on one system and 32 bits on another. Second, the `climits` header file (or, for older implementations, the `limits.h` header file) contains information about integer type limits. In particular, it defines symbolic names to represent different limits. For example, it defines `INT_MAX` as the largest possible `int` value and `CHAR_BIT` as the number of bits in a byte. Listing 3.1 demonstrates how to use these facilities. The program also illustrates *initialization*, which is the use of a declaration statement to assign a value to a variable.

### Listing 3.1 `limits.cpp`

---

```
// limits.cpp -- some integer limits
#include <iostream>
#include <climits>           // use limits.h for older systems
int main()
{
    using namespace std;
    int n_int = INT_MAX;      // initialize n_int to max int value
    short n_short = SHRT_MAX; // symbols defined in climits file
    long n_long = LONG_MAX;
    long long n_llong = LLONG_MAX;

    // sizeof operator yields size of type or of variable
    cout << "int is " << sizeof (int) << " bytes." << endl;
    cout << "short is " << sizeof n_short << " bytes." << endl;
    cout << "long is " << sizeof n_long << " bytes." << endl;
    cout << "long long is " << sizeof n_llong << " bytes." << endl;
    cout << endl;

    cout << "Maximum values:" << endl;
    cout << "int: " << n_int << endl;
    cout << "short: " << n_short << endl;
```

```

cout << "long: " << n_long << endl;
cout << "long long: " << n_llong << endl << endl;

cout << "Minimum int value = " << INT_MIN << endl;
cout << "Bits per byte = " << CHAR_BIT << endl;
return 0;
}

```

---

### Note

If your system doesn't support the `long long` type, you should remove the lines using that type.

Here is sample output from the program in Listing 3.1:

```

int is 4 bytes.
short is 2 bytes.
long is 4 bytes.
long long is 8 bytes.

```

Maximum values:

```

int: 2147483647
short: 32767
long: 2147483647
long long: 9223372036854775807

```

Minimum int value = -2147483648

Bits per byte = 8

These particular values came from a system running 64-bit Windows 7.

The following sections look at the chief programming features for this program.

## The `sizeof` Operator and the `climits` Header File

The `sizeof` operator reports that `int` is 4 bytes on the base system, which uses an 8-bit byte. You can apply the `sizeof` operator to a type name or to a variable name. When you use the `sizeof` operator with a type name, such as `int`, you enclose the name in parentheses. But when you use the operator with the name of the variable, such as `n_short`, parentheses are optional:

```

cout << "int is " << sizeof (int) << " bytes.\n";
cout << "short is " << sizeof n_short << " bytes.\n";

```

The `climits` header file defines symbolic constants (see the sidebar, “Symbolic Constants the Preprocessor Way,” later in this chapter) to represent type limits. As mentioned previously, `INT_MAX` represents the largest value type `int` can hold; this turned out to be 2,147,483,647 for our Windows 7 system. The compiler manufacturer provides a `climits` file that reflects the values appropriate to that compiler. For example, the `climits` file for some older systems that used a 16-bit `int`, defines `INT_MAX` to represent 32,767. Table 3.1

summarizes the symbolic constants defined in the `climits` file; some pertain to types you have not yet learned.

Table 3.1 Symbolic Constants from `climits`

Symbolic Constant	Represents
<code>CHAR_BIT</code>	Number of bits in a <code>char</code>
<code>CHAR_MAX</code>	Maximum <code>char</code> value
<code>CHAR_MIN</code>	Minimum <code>char</code> value
<code>SCHAR_MAX</code>	Maximum signed <code>char</code> value
<code>SCHAR_MIN</code>	Minimum signed <code>char</code> value
<code>UCHAR_MAX</code>	Maximum unsigned <code>char</code> value
<code>SHRT_MAX</code>	Maximum <code>short</code> value
<code>SHRT_MIN</code>	Minimum <code>short</code> value
<code>USHRT_MAX</code>	Maximum unsigned <code>short</code> value
<code>INT_MAX</code>	Maximum <code>int</code> value
<code>INT_MIN</code>	Minimum <code>int</code> value
<code>UINT_MAX</code>	Maximum unsigned <code>int</code> value
<code>LONG_MAX</code>	Maximum <code>long</code> value
<code>LONG_MIN</code>	Minimum <code>long</code> value
<code>ULONG_MAX</code>	Maximum unsigned <code>long</code> value
<code>LLONG_MAX</code>	Maximum <code>long long</code> value
<code>LLONG_MIN</code>	Minimum <code>long long</code> value
<code>ULLONG_MAX</code>	Maximum unsigned <code>long long</code> value

### Symbolic Constants the Preprocessor Way

The `climits` file contains lines similar to the following:

```
#define INT_MAX 32767
```

Recall that the C++ compilation process first passes the source code through a preprocessor. Here `#define`, like `#include`, is a preprocessor directive. What this particular directive tells the preprocessor is this: Look through the program for instances of `INT_MAX` and replace each occurrence with `32767`. So the `#define` directive works like a global search-and-replace command in a text editor or word processor. The altered program is compiled after these replacements occur. The preprocessor looks for independent tokens (separate words) and skips embedded words. That is, the preprocessor doesn't replace `PINT_MAXIM`

with `P32767IM`. You can use `#define` to define your own symbolic constants, too (see Listing 3.2). However, the `#define` directive is a C relic. C++ has a better way of creating symbolic constants (using the `const` keyword, discussed in a later section), so you won't be using `#define` much. But some header files, particularly those designed to be used with both C and C++, do use it.

## Initialization

*Initialization* combines assignment with declaration. For example, the following statement declares the `n_int` variable and sets it to the largest possible type `int` value:

```
int n_int = INT_MAX;
```

You can also use literal constants, such as `255`, to initialize values. You can initialize a variable to another variable, provided that the other variable has been defined first. You can even initialize a variable to an expression, provided that all the values in the expression are known when program execution reaches the declaration:

```
int uncles = 5;                // initialize uncles to 5
int aunts = uncles;           // initialize aunts to 5
int chairs = aunts + uncles + 4; // initialize chairs to 14
```

Moving the `uncles` declaration to the end of this list of statements would invalidate the other two initializations because then the value of `uncles` wouldn't be known at the time the program tries to initialize the other variables.

The initialization syntax shown previously comes from C; C++ has an initialization syntax that is not shared with C:

```
int owls = 101; // traditional C initialization, sets owls to 101
int wrens(432); // alternative C++ syntax, set wrens to 432
```

## Caution

If you don't initialize a variable that is defined inside a function, the variable's value is *indeterminate*. That means the value is whatever happened to be sitting at that memory location prior to the creation of the variable.

If you know what the initial value of a variable should be, initialize it. True, separating the declaring of a variable from assigning it a value can create momentary suspense:

```
short year; // what could it be?
year = 1492; // oh
```

But initializing the variable when you declare it protects you from forgetting to assign the value later.



### Initialization with C++11

There's another format for initialization that's used with arrays and structures but in C++98 can also be used with single-valued variables:

```
int hamburgers = {24}; // set hamburgers to 24
```

Using a braced initializer for a single-valued variable hasn't been particularly common, but the C++11 standard is extending it some ways. First, it can be used with or without the = sign:

```
int emus{7}; // set emus to 5
int rheas = {12}; // set rheas to 12
```

Second, the braces can be left empty, in which case the variable is initialized to 0:

```
int rocs = {}; // set rocs to 0
int psychics{}; // set psychics to 0
```

Third, it provides better protection against type conversion errors, a topic we'll return to near the end of this chapter.

Why, you may ask with good reason, does the language need more alternatives? As odd as it may seem, the reason is to make using C++ easier for the novice. In the past, C++ has used different forms of initialization for different types, and the form used to initialize class variables was different from the form used for ordinary structures—and that, in turn, was different from the form usually used for simple variables such as we have been using. C++ added the parentheses form of initialization to make initializing ordinary variables more like initializing class variables. C++11 makes it possible to use the braces syntax (with or without the =) with all types—a universal initialization syntax. In the future, texts may introduce you to initialization using the brace forms and mention the other forms as historical oddities retained for backward compatibility.

### Unsigned Types

Each of the four integer types you just learned about comes in an unsigned variety that can't hold negative values. This has the advantage of increasing the largest value the variable can hold. For example, if `short` represents the range  $-32,768$  to  $+32,767$ , the unsigned version can represent the range 0 to 65,535. Of course, you should use unsigned types only for quantities that are never negative, such as populations, bean counts, and happy face manifestations. To create unsigned versions of the basic integer types, you just use the keyword `unsigned` to modify the declarations:

```
unsigned short change; // unsigned short type
unsigned int rovert; // unsigned int type
unsigned quarterback; // also unsigned int
unsigned long gone; // unsigned long type
unsigned long long lang_lang; // unsigned long long type
```

Note that `unsigned` by itself is short for `unsigned int`.

Listing 3.2 illustrates the use of unsigned types. It also shows what might happen if your program tries to go beyond the limits for integer types. Finally, it gives you one last look at the preprocessor `#define` statement.

### Listing 3.2 `exceed.cpp`

---

```
// exceed.cpp -- exceeding some integer limits
#include <iostream>
#define ZERO 0 // makes ZERO symbol for 0 value
#include <climits> // defines INT_MAX as largest int value
int main()
{
    using namespace std;
    short sam = SHRT_MAX; // initialize a variable to max value
    unsigned short sue = sam; // okay if variable sam already defined

    cout << "Sam has " << sam << " dollars and Sue has " << sue;
    cout << " dollars deposited." << endl
        << "Add $1 to each account." << endl << "Now ";
    sam = sam + 1;
    sue = sue + 1;
    cout << "Sam has " << sam << " dollars and Sue has " << sue;
    cout << " dollars deposited.\nPoor Sam!" << endl;
    sam = ZERO;
    sue = ZERO;
    cout << "Sam has " << sam << " dollars and Sue has " << sue;
    cout << " dollars deposited." << endl;
    cout << "Take $1 from each account." << endl << "Now ";
    sam = sam - 1;
    sue = sue - 1;
    cout << "Sam has " << sam << " dollars and Sue has " << sue;
    cout << " dollars deposited." << endl << "Lucky Sue!" << endl;
    return 0;
}
```

---

Here's the output from the program in Listing 3.2:

```
Sam has 32767 dollars and Sue has 32767 dollars deposited.
Add $1 to each account.
Now Sam has -32768 dollars and Sue has 32768 dollars deposited.
Poor Sam!
Sam has 0 dollars and Sue has 0 dollars deposited.
Take $1 from each account.
Now Sam has -1 dollars and Sue has 65535 dollars deposited.
Lucky Sue!
```

The program sets a short variable (`sam`) and an unsigned short variable (`sue`) to the largest short value, which is 32,767 on our system. Then it adds 1 to each value. This causes no problems for `sue` because the new value is still much less than the maximum value for an unsigned integer. But `sam` goes from 32,767 to -32,768! Similarly, subtracting 1 from 0 creates no problems for `sam`, but it makes the unsigned variable `sue` go from 0 to 65,535. As you can see, these integers behave much like an odometer. If you go past the limit, the values just start over at the other end of the range (see Figure 3.1). C++ guarantees that unsigned types behave in this fashion. However, C++ doesn't guarantee that signed integer types can exceed their limits (overflow and underflow) without complaint, but that is the most common behavior on current implementations.

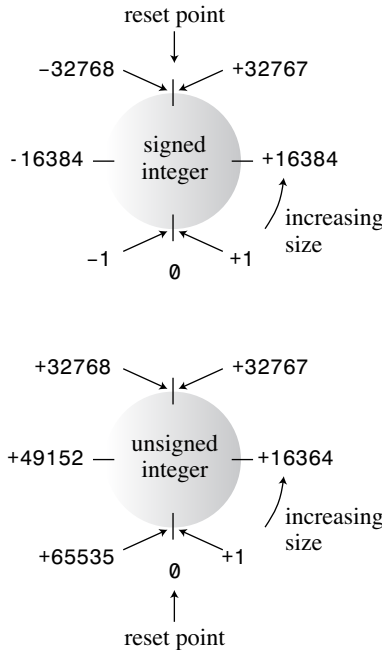

Figure 3.1 Typical overflow behavior for integers.

### Choosing an Integer Type

With the richness of C++ integer types, which should you use? Generally, `int` is set to the most “natural” integer size for the target computer. *Natural size* refers to the integer form that the computer handles most efficiently. If there is no compelling reason to choose another type, you should use `int`.

Now look at reasons why you might use another type. If a variable represents something that is never negative, such as the number of words in a document, you can use an unsigned type; that way the variable can represent higher values.

If you know that the variable might have to represent integer values too great for a 16-bit integer, you should use `long`. This is true even if `int` is 32 bits on your system. That way, if you transfer your program to a system with a 16-bit `int`, your program won't embarrass you by suddenly failing to work properly (see Figure 3.2). And if a mere two billion is inadequate for your needs, you can move up to `long long`.

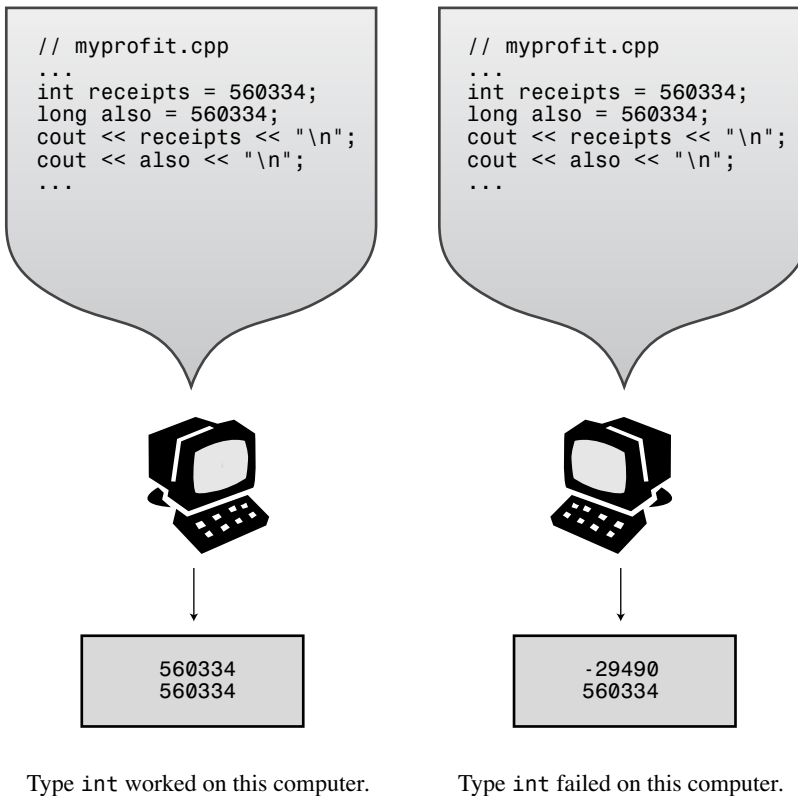

Figure 3.2 For portability, use `long` for big integers.

Using `short` can conserve memory if `short` is smaller than `int`. Most typically, this is important only if you have a large array of integers. (An *array* is a data structure that stores several values of the same type sequentially in memory.) If it is important to conserve space, you should use `short` instead of `int`, even if the two are the same size. Suppose, for example, that you move your program from a 16-bit `int` system to a 32-bit `int` system. That doubles the amount of memory needed to hold an `int` array, but it doesn't affect the requirements for a `short` array. Remember, a bit saved is a bit earned.

If you need only a single byte, you can use `char`. We'll examine that possibility soon.

## Integer Literals

An integer literal, or constant, is one you write out explicitly, such as 212 or 1776. C++, like C, lets you write integers in three different number bases: base 10 (the public favorite), base 8 (the old Unix favorite), and base 16 (the hardware hacker's favorite). Appendix A, "Number Bases," describes these bases; here we'll look at the C++ representations. C++ uses the first digit or two to identify the base of a number constant. If the first digit is in the range 1–9, the number is base 10 (decimal); thus 93 is base 10. If the first digit is 0 and the second digit is in the range 1–7, the number is base 8 (octal); thus 042 is octal and equal to 34 decimal. If the first two characters are 0x or 0X, the number is base 16 (hexadecimal); thus 0x42 is hex and equal to 66 decimal. For hexadecimal values, the characters a–f and A–F represent the hexadecimal digits corresponding to the values 10–15. 0xF is 15 and 0xA5 is 165 (10 sixteens plus 5 ones). Listing 3.3 is tailor-made to show the three bases.

Listing 3.3 `hexoct1.cpp`

---

```
// hexoct1.cpp -- shows hex and octal literals
#include <iostream>
int main()
{
    using namespace std;
    int chest = 42;      // decimal integer literal
    int waist = 0x42;   // hexadecimal integer literal
    int inseam = 042;   // octal integer literal

    cout << "Monsieur cuts a striking figure!\n";
    cout << "chest = " << chest << " (42 in decimal)\n";
    cout << "waist = " << waist << " (0x42 in hex)\n";
    cout << "inseam = " << inseam << " (042 in octal)\n";
    return 0;
}
```

---

By default, `cout` displays integers in decimal form, regardless of how they are written in a program, as the following output shows:

```
Monsieur cuts a striking figure!
chest = 42 (42 in decimal)
waist = 66 (0x42 in hex)
inseam = 34 (042 in octal)
```

Keep in mind that these notations are merely notational conveniences. For example, if you belong to a vintage PC club and read that the CGA video memory segment is B000 in hexadecimal, you don't have to convert the value to base 10 45,056 before using it in your program. Instead, you can simply use 0xB000. But whether you write the value ten as 10, 012, or 0xA, it's stored the same way in the computer—as a binary (base 2) value.

By the way, if you want to display a value in hexadecimal or octal form, you can use some special features of `cout`. Recall that the `iostream` header file provides the `endl` manipulator to give `cout` the message to start a new line. Similarly, it provides the `dec`, `hex`, and `oct` manipulators to give `cout` the messages to display integers in decimal, hexadecimal, and octal formats, respectively. Listing 3.4 uses `hex` and `oct` to display the decimal value 42 in three formats. (Decimal is the default format, and each format stays in effect until you change it.)

#### Listing 3.4 `hexoct2.cpp`

---

```
// hexoct2.cpp -- display values in hex and octal
#include <iostream>
using namespace std;
int main()
{
    using namespace std;
    int chest = 42;
    int waist = 42;
    int inseam = 42;

    cout << "Monsieur cuts a striking figure!" << endl;
    cout << "chest = " << chest << " (decimal for 42)" << endl;
    cout << hex;        // manipulator for changing number base
    cout << "waist = " << waist << " (hexadecimal for 42)" << endl;
    cout << oct;        // manipulator for changing number base
    cout << "inseam = " << inseam << " (octal for 42)" << endl;
    return 0;
}
```

---

Here's the program output for Listing 3.4:

```
Monsieur cuts a striking figure!
chest = 42 (decimal for 42)
waist = 2a (hexadecimal for 42)
inseam = 52 (octal for 42)
```

Note that code like the following doesn't display anything onscreen:

```
cout << hex;
```

Instead, it changes the way `cout` displays integers. Thus, the manipulator `hex` is really a message to `cout` that tells it how to behave. Also note that because the identifier `hex` is part of the `std` namespace and the program uses that namespace, this program can't use `hex` as the name of a variable. However, if you omitted the `using` directive and instead used `std::cout`, `std::endl`, `std::hex`, and `std::oct`, you could still use plain `hex` as the name for a variable.

## How C++ Decides What Type a Constant Is

A program's declarations tell the C++ compiler the type of a particular integer variable. But what about constants? That is, suppose you represent a number with a constant in a program:

```
cout << "Year = " << 1492 << "\n";
```

Does the program store 1492 as an `int`, a `long`, or some other integer type? The answer is that C++ stores integer constants as type `int` unless there is a reason to do otherwise. Two such reasons are if you use a special suffix to indicate a particular type or if a value is too large to be an `int`.

First, look at the suffixes. These are letters placed at the end of a numeric constant to indicate the type. An `l` or `L` suffix on an integer means the integer is a type `long` constant, a `u` or `U` suffix indicates an unsigned `int` constant, and `ul` (in any combination of orders and uppercase and lowercase) indicates a type `unsigned long` constant. (Because a lowercase `l` can look much like the digit 1, you should use the uppercase `L` for suffixes.) For example, on a system using a 16-bit `int` and a 32-bit `long`, the number 22022 is stored in 16 bits as an `int`, and the number 22022L is stored in 32 bits as a `long`. Similarly, 22022LU and 22022UL are unsigned `long`. C++11 provides the `ll` and `LL` suffixes for type `long long`, and `ull`, `Ull`, `uLL`, and `ULL` for unsigned `long long`.

Next, look at size. C++ has slightly different rules for decimal integers than it has for hexadecimal and octal integers. (Here decimal means base 10, just as hexadecimal means base 16; the term *decimal* does not necessarily imply a decimal point.) A decimal integer without a suffix is represented by the smallest of the following types that can hold it: `int`, `long`, or `long long`. On a computer system using a 16-bit `int` and a 32-bit `long`, 20000 is represented as type `int`, 40000 is represented as `long`, and 3000000000 is represented as `long long`. A hexadecimal or octal integer without a suffix is represented by the smallest of the following types that can hold it: `int`, `unsigned int`, `long`, `unsigned long`, `long long`, or `unsigned long long`. The same computer system that represents 40000 as `long` represents the hexadecimal equivalent 0x9C40 as an `unsigned int`. That's because hexadecimal is frequently used to express memory addresses, which intrinsically are unsigned. So `unsigned int` is more appropriate than `long` for a 16-bit address.

## The `char` Type: Characters and Small Integers

It's time to turn to the final integer type: `char`. As you probably suspect from its name, the `char` type is designed to store characters, such as letters and numeric digits. Now, whereas storing numbers is no big deal for computers, storing letters is another matter. Programming languages take the easy way out by using number codes for letters. Thus, the `char` type is another integer type. It's guaranteed to be large enough to represent the entire range of basic symbols—all the letters, digits, punctuation, and the like—for the target computer system. In practice, many systems support fewer than 128 kinds of characters, so a single byte can represent the whole range. Therefore, although `char` is most often used to handle characters, you can also use it as an integer type that is typically smaller than `short`.

The most common symbol set in the United States is the ASCII character set, described in Appendix C, “The ASCII Character Set.” A numeric code (the ASCII code) represents each character in the set. For example, 65 is the code for the character A, and 77 is the code for the character M. For convenience, this book assumes ASCII code in its examples. However, a C++ implementation uses whatever code is native to its host system—for example, EBCDIC (pronounced “eb-se-dik”) on an IBM mainframe. Neither ASCII nor EBCDIC serve international needs that well, and C++ supports a wide-character type that can hold a larger range of values, such as are used by the international Unicode character set. You’ll learn about this `wchar_t` type later in this chapter.

Try the `char` type in Listing 3.5.

### Listing 3.5 `chartype.cpp`

---

```
// chartype.cpp -- the char type
#include <iostream>
int main( )
{
    using namespace std;
    char ch;           // declare a char variable

    cout << "Enter a character: " << endl;
    cin >> ch;
    cout << "Hola! ";
    cout << "Thank you for the " << ch << " character." << endl;
    return 0;
}
```

---

Here’s the output from the program in Listing 3.5:

```
Enter a character:
M
Hola! Thank you for the M character.
```

The interesting thing is that you type an `M`, not the corresponding character code, `77`. Also the program prints an `M`, not `77`. Yet if you peer into memory, you find that `77` is the value stored in the `ch` variable. The magic, such as it is, lies not in the `char` type but in `cin` and `cout`. These worthy facilities make conversions on your behalf. On input, `cin` converts the keystroke input `M` to the value `77`. On output, `cout` converts the value `77` to the displayed character `M`; `cin` and `cout` are guided by the type of variable. If you place the same value `77` into an `int` variable, `cout` displays it as `77`. (That is, `cout` displays two 7 characters.) Listing 3.6 illustrates this point. It also shows how to write a character literal in C++: Enclose the character within two single quotation marks, as in `'M'`. (Note that the example doesn’t use double quotation marks. C++ uses single quotation marks for a character and double quotation marks for a string. The `cout` object can handle either, but, as Chapter 4 discusses, the two are quite different from one another.) Finally, the program introduces a `cout` feature, the `cout.put()` function, which displays a single character.



Listing 3.6 `morechar.cpp`

---

```
// morechar.cpp -- the char type and int type contrasted
#include <iostream>
int main()
{
    using namespace std;
    char ch = 'M';           // assign ASCII code for M to ch
    int i = ch;             // store same code in an int
    cout << "The ASCII code for " << ch << " is " << i << endl;

    cout << "Add one to the character code:" << endl;
    ch = ch + 1;           // change character code in ch
    i = ch;                // save new character code in i
    cout << "The ASCII code for " << ch << " is " << i << endl;

    // using the cout.put() member function to display a char
    cout << "Displaying char ch using cout.put(ch): ";
    cout.put(ch);

    // using cout.put() to display a char constant
    cout.put('!');

    cout << endl << "Done" << endl;
    return 0;
}
```

---

Here is the output from the program in Listing 3.6:

```
The ASCII code for M is 77
Add one to the character code:
The ASCII code for N is 78
Displaying char ch using cout.put(ch): N!
Done
```

### Program Notes

In the program in Listing 3.6, the notation 'M' represents the numeric code for the M character, so initializing the char variable `ch` to 'M' sets `ch` to the value 77. The program then assigns the identical value to the int variable `i`, so both `ch` and `i` have the value 77. Next, `cout` displays `ch` as M and `i` as 77. As previously stated, a value's type guides `cout` as it chooses how to display that value—just another example of smart objects.

Because `ch` is really an integer, you can apply integer operations to it, such as adding 1. This changes the value of `ch` to 78. The program then resets `i` to the new value. (Equivalently, you can simply add 1 to `i`.) Again, `cout` displays the char version of that value as a character and the int version as a number.

The fact that C++ represents characters as integers is a genuine convenience that makes it easy to manipulate character values. You don't have to use awkward conversion functions to convert characters to ASCII and back.

Even digits entered via the keyboard are read as characters. Consider the following sequence:

```
char ch;  
cin >> ch;
```

If you type 5 and Enter, this code reads the 5 character and stores the character code for the 5 character (53 in ASCII) in `ch`. Now consider this code:

```
int n;  
cin >> n;
```

The same input results in the program reading the 5 character and running a routine converting the character to the corresponding numeric value of 5, which gets stored in `n`.

Finally, the program uses the `cout.put()` function to display both `c` and a character constant.

### A Member Function: `cout.put()`

Just what is `cout.put()`, and why does it have a period in its name? The `cout.put()` function is your first example of an important C++ OOP concept, the *member function*. Remember that a class defines how to represent data and how to manipulate it. A member function belongs to a class and describes a method for manipulating class data. The `ostream` class, for example, has a `put()` member function that is designed to output characters. You can use a member function only with a particular object of that class, such as the `cout` object, in this case. To use a class member function with an object such as `cout`, you use a period to combine the object name (`cout`) with the function name (`put()`). The period is called the *membership operator*. The notation `cout.put()` means to use the class member function `put()` with the class object `cout`. You'll learn about this in greater detail when you reach classes in Chapter 10, "Objects and Classes." Now the only classes you have are the `istream` and `ostream` classes, and you can experiment with their member functions to get more comfortable with the concept.

The `cout.put()` member function provides an alternative to using the `<<` operator to display a character. At this point you might wonder why there is any need for `cout.put()`. Much of the answer is historical. Before Release 2.0 of C++, `cout` would display character *variables* as characters but display character *constants*, such as `'M'` and `'N'`, as numbers. The problem was that earlier versions of C++, like C, stored character constants as type `int`. That is, the code 77 for `'M'` would be stored in a 16-bit or 32-bit unit. Meanwhile, `char` variables typically occupied 8 bits. A statement like the following copied 8 bits (the important 8 bits) from the constant `'M'` to the variable `ch`:

```
char ch = 'M';
```

Unfortunately, this meant that, to `cout`, `'M'` and `ch` looked quite different from one another, even though both held the same value. So a statement like the following would print the ASCII code for the `§` character rather than simply display `§`:

```
cout << '§';
```

But the following would print the character, as desired:

```
cout.put('§');
```

Now, after Release 2.0, C++ stores single-character constants as type `char`, not type `int`. Therefore, `cout` now correctly handles character constants.

The `cin` object has a couple different ways of reading characters from input. You can explore these by using a program that uses a loop to read several characters, so we'll return to this topic when we cover loops in Chapter 5, "Loops and Relational Expressions."

### char Literals

You have several options for writing character literals in C++. The simplest choice for ordinary characters, such as letters, punctuation, and digits, is to enclose the character in single quotation marks. This notation stands for the numeric code for the character. For example, an ASCII system has the following correspondences:

- `'A'` is 65, the ASCII code for A.
- `'a'` is 97, the ASCII code for a.
- `'5'` is 53, the ASCII code for the digit 5.
- `' '` is 32, the ASCII code for the space character.
- `'!'` is 33, the ASCII code for the exclamation point.

Using this notation is better than using the numeric codes explicitly. It's clearer, and it doesn't assume a particular code. If a system uses EBCDIC, then 65 is not the code for A, but `'A'` still represents the character.

There are some characters that you can't enter into a program directly from the keyboard. For example, you can't make the newline character part of a string by pressing the Enter key; instead, the program editor interprets that keystroke as a request for it to start a new line in your source code file. Other characters have difficulties because the C++ language imbues them with special significance. For example, the double quotation mark character delimits string literals, so you can't just stick one in the middle of a string literal. C++ has special notations, called *escape sequences*, for several of these characters, as shown in Table 3.2. For example, `\a` represents the alert character, which beeps your terminal's speaker or rings its bell. The escape sequence `\n` represents a newline. And `\"` represents the double quotation mark as an ordinary character instead of a string delimiter. You can use these notations in strings or in character constants, as in the following examples:

Table 3.2 C++ Escape Sequence Codes

Character Name	ASCII Symbol	C++ Code	ASCII Decimal Code	ASCII Hex Code
Newline	NL (LF)	<code>\n</code>	10	0xA
Horizontal tab	HT	<code>\t</code>	9	0x9
Vertical tab	VT	<code>\v</code>	11	0xB
Backspace	BS	<code>\b</code>	8	0x8
Carriage return	CR	<code>\r</code>	13	0xD
Alert	BEL	<code>\a</code>	7	0x7
Backslash	<code>\</code>	<code>\\</code>	92	0x5C
Question mark	<code>?</code>	<code>\?</code>	63	0x3F
Single quote	<code>'</code>	<code>\'</code>	39	0x27
Double quote	<code>"</code>	<code>\"</code>	34	0x22

```
char alarm = '\a';
cout << alarm << "Don't do that again!\a\n";
cout << "Ben \"Bugsie\" Hacker\nwas here!\n";
```

The last line produces the following output:

```
Ben "Bugsie" Hacker
was here!
```

Note that you treat an escape sequence, such as `\n`, just as a regular character, such as `Q`. That is, you enclose it in single quotes to create a character constant and don't use single quotes when including it as part of a string.

The escape sequence concept dates back to when people communicated with computers using the teletype, an electromechanical typewriter-printer, and modern systems don't always honor the complete set of escape sequences. For example, some systems remain silent for the alarm character.

The newline character provides an alternative to `endl` for inserting new lines into output. You can use the newline character in character constant notation (`'\n'`) or as character in a string (`"\n"`). All three of the following move the screen cursor to the beginning of the next line:

```
cout << endl;    // using the endl manipulator
cout << '\n';    // using a character constant
cout << "\n";    // using a string
```

You can embed the newline character in a longer string; this is often more convenient than using `endl`. For example, the following two `cout` statements produce the same output:

```
cout << endl << endl << "What next?" << endl << "Enter a number:" << endl;
cout << "\n\nWhat next?\nEnter a number:\n";
```

When you're displaying a number, `endl` is a bit easier to type than `"\n"` or `'\n'`, but when you're displaying a string, ending the string with a newline character requires less typing:

```
cout << x << endl;    // easier than cout << x << "\n";
cout << "Dr. X.\n";   // easier than cout << "The Dr. X." << endl;
```

Finally, you can use escape sequences based on the octal or hexadecimal codes for a character. For example, `Ctrl+Z` has an ASCII code of 26, which is `032` in octal and `0x1a` in hexadecimal. You can represent this character with either of the following escape sequences: `\032` or `\x1a`. You can make character constants out of these by enclosing them in single quotes, as in `'\032'`, and you can use them as parts of a string, as in `"hi\x1a there"`.

### Tip

When you have a choice between using a numeric escape sequence or a symbolic escape sequence, as in `\0x8` versus `\b`, use the symbolic code. The numeric representation is tied to a particular code, such as ASCII, but the symbolic representation works with all codes and is more readable.

Listing 3.7 demonstrates a few escape sequences. It uses the alert character to get your attention, the newline character to advance the cursor (one small step for a cursor, one giant step for `cursorkind`), and the backspace character to back the cursor one space to the left. (Houdini once painted a picture of the Hudson River using only escape sequences; he was, of course, a great escape artist.)

### Listing 3.7 `bondini.cpp`

---

```
// bondini.cpp -- using escape sequences
#include <iostream>
int main()
{
    using namespace std;
    cout << "\aOperation \"HyperHype\" is now activated!\n";
    cout << "Enter your agent code: _____\b\b\b\b\b\b\b\b";
    long code;
    cin >> code;
    cout << "\aYou entered " << code << "...!\n";
    cout << "\aCode verified! Proceed with Plan Z3!\n";
    return 0;
}
```

---

### Note

Some systems might behave differently, displaying the `\b` as a small rectangle rather than backspacing, for example, or perhaps erasing while backspacing, perhaps ignoring `\a`.

When you start the program in Listing 3.7, it puts the following text onscreen:

```
Operation "HyperHype" is now activated!
Enter your agent code:_____
```

After printing the underscore characters, the program uses the backspace character to back up the cursor to the first underscore. You can then enter your secret code and continue. Here's a complete run:

```
Operation "HyperHype" is now activated!
Enter your agent code:42007007
You entered 42007007...
Code verified! Proceed with Plan Z3!
```

## Universal Character Names

C++ implementations support a basic source character set—that is, the set of characters you can use to write source code. It consists of the letters (uppercase and lowercase) and digits found on a standard U.S. keyboard, the symbols, such as { and =, used in the C language, and a scattering of other characters, such as the space character. Then there is a basic execution character set, which includes characters that can be processed during the execution of a program (for example, characters read from a file or displayed on screen). This adds a few more characters, such as backspace and alert. The C++ Standard also allows an implementation to offer extended source character sets and extended execution character sets. Furthermore, those additional characters that qualify as letters can be used as part of the name of an identifier. Thus, a German implementation might allow you to use unlauded vowels, and a French implementation might allow accented vowels. C++ has a mechanism for representing such international characters that is independent of any particular keyboard: the use of *universal character names*.

Using universal character names is similar to using escape sequences. A universal character name begins either with `\u` or `\U`. The `\u` form is followed by 8 hexadecimal digits, and the `\U` form by 16 hexadecimal digits. These digits represent the ISO 10646 code point for the character. (ISO 10646 is an international standard under development that provides numeric codes for a wide range of characters. See “Unicode and ISO 10646,” later in this chapter.)

If your implementation supports extended characters, you can use universal character names in identifiers, as character constants, and in strings. For example, consider the following code:

```
int k\u00F6rper;
cout << "Let them eat g\u00E2teau.\n";
```

The ISO 10646 code point for ö is 00F6, and the code point for â is 00E2. Thus, this C++ code would set the variable name to `körper` and display the following output:

```
Let them eat gâteau.
```

If your system doesn't support ISO 10646, it might display some other character for `â` or perhaps simply display the word `gu00E2teau`.

Actually, from the standpoint of readability, there's not much point to using `\u00F6` as part of a variable name, but an implementation that included the `ö` character as part of an extended source character set probably would also allow you to type that character from the keyboard.

Note that C++ uses the term “universal code name,” not, say, “universal code.” That's because a construction such as `\u00F6` should be considered a label meaning “the character whose Unicode code point is U-00F6.” A compliant C++ compiler will recognize this as representing the `'ö'` character, but there is no requirement that internal coding be `00F6`. Just as, in principle, the character `'T'` can be represented internally by ASCII on one computer and by a different coding system on another computer, the `'\u00F6'` character can have different encodings on different systems. Your source code can use the same universal code name on all systems, and the compiler will then represent it by the appropriate internal code used on the particular system.

### Unicode and ISO 10646

Unicode provides a solution to the representation of various character sets by providing a standard numbering system for a great number of characters and symbols, grouping them by type. For example, the ASCII code is incorporated as a subset of Unicode, so U.S. Latin characters such as A and Z have the same representation under both systems. But Unicode also incorporates other Latin characters, such as those used in European languages; characters from other alphabets, including Greek, Cyrillic, Hebrew, Cherokee, Arabic, Thai, and Bengali; and ideographs, such as those used for Chinese and Japanese. So far Unicode represents more than 109,000 symbols and more than 90 scripts, and it is still under development. If you want to know more, you can check the Unicode Consortium's website, at [www.unicode.org](http://www.unicode.org).

Unicode assigns a number, called a `code point`, for each of its characters. The typical notation for Unicode code points looks like this: U-222B. The U identifies this as a Unicode character, and the 222B is the hexadecimal number for the character—an integral sign, in this case.

The International Organization for Standardization (ISO) established a working group to develop ISO 10646, also a standard for coding multilingual text. The ISO 10646 group and the Unicode group have worked together since 1991 to keep their standards synchronized with one another.

### signed char and unsigned char

Unlike `int`, `char` is not signed by default. Nor is it unsigned by default. The choice is left to the C++ implementation in order to allow the compiler developer to best fit the type to the hardware properties. If it is vital to you that `char` has a particular behavior, you can use `signed char` or `unsigned char` explicitly as types:

```
char fodo;           // may be signed, may be unsigned
unsigned char bar;  // definitely unsigned
signed char snark;  // definitely signed
```

These distinctions are particularly important if you use `char` as a numeric type. The `unsigned char` type typically represents the range 0 to 255, and `signed char` typically represents the range  $-128$  to  $127$ . For example, suppose you want to use a `char` variable to hold values as large as 200. That works on some systems but fails on others. You can, however, successfully use `unsigned char` for that purpose on any system. On the other hand, if you use a `char` variable to hold a standard ASCII character, it doesn't really matter whether `char` is signed or unsigned, so you can simply use `char`.

### For When You Need More: `wchar_t`

Programs might have to handle character sets that don't fit within the confines of a single 8-bit byte (for example, the Japanese kanji system). C++ handles this in a couple ways. First, if a large set of characters is the basic character set for an implementation, a compiler vendor can define `char` as a 16-bit byte or larger. Second, an implementation can support both a small basic character set and a larger extended character set. The usual 8-bit `char` can represent the basic character set, and another type, called `wchar_t` (for *wide character type*), can represent the extended character set. The `wchar_t` type is an integer type with sufficient space to represent the largest extended character set used on the system. This type has the same size and sign properties as one of the other integer types, which is called the *underlying* type. The choice of underlying type depends on the implementation, so it could be `unsigned short` on one system and `int` on another.

The `cin` and `cout` family consider input and output as consisting of streams of chars, so they are not suitable for handling the `wchar_t` type. The `iostream` header file provides parallel facilities in the form of `wcin` and `wcout` for handling `wchar_t` streams. Also you can indicate a wide-character constant or string by preceding it with an `L`. The following code stores a `wchar_t` version of the letter `P` in the variable `bob` and displays a `wchar_t` version of the word `tall`:

```
wchar_t bob = L'P';           // a wide-character constant
wcout << L"tall" << endl;    // outputting a wide-character string
```

On a system with a 2-byte `wchar_t`, this code stores each character in a 2-byte unit of memory. This book doesn't use the wide-character type, but you should be aware of it, particularly if you become involved in international programming or in using Unicode or ISO 10646.

### New C++11 Types: `char16_t` and `char32_t`

As the programming community gained more experience with Unicode, it became clear that the `wchar_t` type wasn't enough. It turns out that encoding characters and strings of characters on a computer system is more complex than just using the Unicode numeric values (called code points). In particular, it's useful, when encoding strings of characters, to have a type of definite size and signedness. But the sign and size of `wchar_t` can vary from one implementation to another. So C++11 introduces the types `char16_t`, which is unsigned and 16 bits, and `char32_t`, which is unsigned and 32 bits. C++11 uses the `u` prefix for `char16_t` character and string constants, as in `u'C'` and `u"be good"`. Similarly, it



uses the `U` prefix for `char32_t` constants, as in `U'R'` and `U"dirty rat"`. The `char16_t` type is a natural match for universal character names of the form `\u00F6`, and the `char32_t` type is a natural match for universal character names of the form `\U0000222B`. The prefixes `u` and `U` are used to indicate character literals of types `char16_t` and `char32_t`, respectively:

```
char16_t ch1 = u'g';           // basic character in 16-bit form
char32_t ch2 = U'\U0000222B'; // universal character name in 32-bit form
```

Like `wchar_t`, `char16_t` and `char32_t` each have an underlying type, which is one of the built-in integer types. But the underlying type can be different on one system from what it is on another.

## The bool Type

The ANSI/ISO C++ Standard has added a new type (new to C++, that is), called `bool`. It's named in honor of the English mathematician George Boole, who developed a mathematical representation of the laws of logic. In computing, a *Boolean variable* is one whose value can be either `true` or `false`. In the past, C++, like C, has not had a Boolean type. Instead, as you'll see in greater detail in Chapters 5 and 6, C++ interprets nonzero values as `true` and zero values as `false`. Now, however, you can use the `bool` type to represent `true` and `false`, and the predefined literals `true` and `false` represent those values. That is, you can make statements like the following:

```
bool is_ready = true;
```

The literals `true` and `false` can be converted to type `int` by promotion, with `true` converting to 1 and `false` to 0:

```
int ans = true;           // ans assigned 1
int promise = false;     // promise assigned 0
```

Also any numeric or pointer value can be converted implicitly (that is, without an explicit type cast) to a `bool` value. Any nonzero value converts to `true`, whereas a zero value converts to `false`:

```
bool start = -100;       // start assigned true
bool stop = 0;           // stop assigned false
```

After the book introduces `if` statements (in Chapter 6, “Branching Statements and Logical Operators”), the `bool` type will become a common feature in the examples.

## The const Qualifier

Now let's return to the topic of symbolic names for constants. A symbolic name can suggest what the constant represents. Also if the program uses the constant in several places and you need to change the value, you can just change the single symbol definition. The

note about `#define` statements earlier in this chapter (see the sidebar “Symbolic Constants the Preprocessor Way”) promises that C++ has a better way to handle symbolic constants. That way is to use the `const` keyword to modify a variable declaration and initialization. Suppose, for example, that you want a symbolic constant for the number of months in a year. Just enter this line in a program:

```
const int Months = 12; // Months is symbolic constant for 12
```

Now you can use `Months` in a program instead of `12`. (A bare `12` in a program might represent the number of inches in a foot or the number of donuts in a dozen, but the name `Months` tells you what the value `12` represents.) After you initialize a constant such as `Months`, its value is set. The compiler does not let you subsequently change the value `Months`. If you try to, for example, `g++` gives an error message that the program used an assignment of a read-only variable. The keyword `const` is termed a *qualifier* because it qualifies the meaning of a declaration.

A common practice is to capitalize the first character in a name to help remind yourself that `Months` is a constant. This is by no means a universal convention, but it helps separate the constants from the variables when you read a program. Another convention is to make all the characters uppercase; this is the usual convention for constants created using `#define`. Yet another convention is to begin constant names with the letter `k`, as in `kmonths`. And there are yet other conventions. Many organizations have particular coding conventions they expect their programmers to follow.

The general form for creating a constant is this:

```
const type name = value;
```

Note that you initialize a `const` in the declaration. The following sequence is no good:

```
const int toes; // value of toes undefined at this point
toes = 10; // too late!
```

If you don't provide a value when you declare the constant, it ends up with an unspecified value that you cannot modify.

If your background is in C, you might feel that the `#define` statement, which is discussed earlier, already does the job adequately. But `const` is better. For one thing, it lets you specify the type explicitly. Second, you can use C++'s scoping rules to limit the definition to particular functions or files. (Scoping rules describe how widely known a name is to different modules; you'll learn about this in more detail in Chapter 9, “Memory Models and Namespaces.”) Third, you can use `const` with more elaborate types, such as arrays and structures, as discussed in Chapter 4.

## Tip

If you are coming to C++ from C and you are about to use `#define` to define a symbolic constant, use `const` instead.

ANSI C also uses the `const` qualifier, which it borrows from C++. If you're familiar with the ANSI C version, you should be aware that the C++ version is slightly different.

One difference relates to the scope rules, and Chapter 9 covers that point. The other main difference is that in C++ (but not in C), you can use a `const` value to declare the size of an array. You'll see examples in Chapter 4.

## Floating-Point Numbers

Now that you have seen the complete line of C++ integer types, let's look at the floating-point types, which compose the second major group of fundamental C++ types. These numbers let you represent numbers with fractional parts, such as the gas mileage of an M1 tank (0.56 MPG). They also provide a much greater range in values. If a number is too large to be represented as type `long`—for example, the number of bacterial cells in a human body (estimated to be greater than 100,000,000,000,000)—you can use one of the floating-point types.

With floating-point types, you can represent numbers such as 2.5 and 3.14159 and 122442.32—that is, numbers with fractional parts. A computer stores such values in two parts. One part represents a value, and the other part scales that value up or down. Here's an analogy. Consider the two numbers 34.1245 and 34124.5. They're identical except for scale. You can represent the first one as 0.341245 (the base value) and 100 (the scaling factor). You can represent the second as 0.341245 (the same base value) and 100,000 (a bigger scaling factor). The scaling factor serves to move the decimal point, hence the term *floating-point*. C++ uses a similar method to represent floating-point numbers internally, except it's based on binary numbers, so the scaling is by factors of 2 instead of by factors of 10. Fortunately, you don't have to know much about the internal representation. The main points are that floating-point numbers let you represent fractional, very large, and very small values, and they have internal representations much different from those of integers.

## Writing Floating-Point Numbers

C++ has two ways of writing floating-point numbers. The first is to use the standard decimal-point notation you've been using much of your life:

```
12.34           // floating-point
939001.32      // floating-point
0.00023        // floating-point
8.0            // still floating-point
```

Even if the fractional part is 0, as in 8.0, the decimal point ensures that the number is represented in floating-point format and not as an integer. (The C++ Standard does allow for implementations to represent different locales—for example, providing a mechanism for using the European method of using a comma instead of a period for the decimal point. However, these choices govern how the numbers can appear in input and output, not in code.)

The second method for representing floating-point values is called E notation, and it looks like this: `3.45E6`. This means that the value 3.45 is multiplied by 1,000,000; the E6 means 10 to the 6th power, which is 1 followed by 6 zeros. Thus `3.45E6` means

3,450,000. The 6 is called an *exponent*, and the 3.45 is termed the *mantissa*. Here are more examples:

```
2.52e+8           // can use E or e, + is optional
8.33E-4          // exponent can be negative
7E5              // same as 7.0E+05
-18.32e13       // can have + or - sign in front
1.69e12         // 2010 Brazilian public debt in reais
5.98E24         // mass of earth in kilograms
9.11e-31        // mass of an electron in kilograms
```

As you might have noticed, E notation is most useful for very large and very small numbers.

E notation guarantees that a number is stored in floating-point format, even if no decimal point is used. Note that you can use either E or e, and the exponent can have a positive or negative sign (see Figure 3.3). However, you can't have spaces in the number, so, for example, 7.2 E6 is invalid.

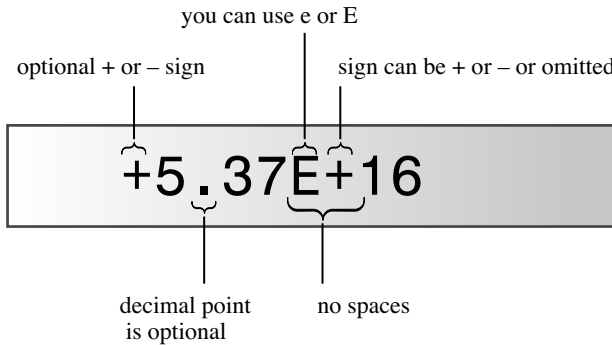

Figure 3.3 E notation.

To use a negative exponent means to divide by a power of 10 instead of to multiply by a power of 10. So 8.33E-4 means  $8.33 / 10^4$ , or 0.000833. Similarly, the electron mass 9.11e-31 kg means 0.0000000000000000000000000000911 kg. Take your choice. (Incidentally, note that 911 is the usual emergency telephone number in the United States and that telephone messages are carried by electrons. Coincidence or scientific conspiracy? You be the judge.) Note that -8.33E4 means -83300. A sign in front applies to the number value, and a sign in the exponent applies to the scaling.

**Note**  
 The form  $d.dddE+n$  means move the decimal point  $n$  places to the right, and the form  $d.dddE-n$  means move the decimal point  $n$  places to the left. This moveable decimal point is the origin of the term “floating-point.”

## Floating-Point Types

Like ANSI C, C++ has three floating-point types: `float`, `double`, and `long double`. These types are described in terms of the number of significant figures they can represent and the minimum allowable range of exponents. *Significant figures* are the meaningful digits in a number. For example, writing the height of Mt. Shasta in California as 14,179 feet uses five significant figures, for it specifies the height to the nearest foot. But writing the height of Mt. Shasta as about 14,000 feet tall uses two significant figures, for the result is rounded to the nearest thousand feet; in this case, the remaining three digits are just placeholders. The number of significant figures doesn't depend on the location of the decimal point. For example, you can write the height as 14.179 thousand feet. Again, this uses five significant digits because the value is accurate to the fifth digit.

In effect, the C and C++ requirements for significant digits amount to `float` being at least 32 bits, `double` being at least 48 bits and certainly no smaller than `float`, and `long double` being at least as big as `double`. All three can be the same size. Typically, however, `float` is 32 bits, `double` is 64 bits, and `long double` is 80, 96, or 128 bits. Also the range in exponents for all three types is at least  $-37$  to  $+37$ . You can look in the `cfloat` or `float.h` header files to find the limits for your system. (`cfloat` is the C++ version of the C `float.h` file.) Here, for example, are some annotated entries from the `float.h` file for Borland C++Builder:

```
// the following are the minimum number of significant digits
#define DBL_DIG 15          // double
#define FLT_DIG 6          // float
#define LDBL_DIG 18        // long double

// the following are the number of bits used to represent the mantissa
#define DBL_MANT_DIG 53
#define FLT_MANT_DIG 24
#define LDBL_MANT_DIG 64

// the following are the maximum and minimum exponent values
#define DBL_MAX_10_EXP +308
#define FLT_MAX_10_EXP +38
#define LDBL_MAX_10_EXP +4932

#define DBL_MIN_10_EXP -307
#define FLT_MIN_10_EXP -37
#define LDBL_MIN_10_EXP -4931
```

Listing 3.8 examines types `float` and `double` and how they can differ in the precision to which they represent numbers (that's the significant figure aspect). The program previews an `ostream` method called `setf()` from Chapter 17, "Input, Output, and Files." This particular call forces output to stay in fixed-point notation so that you can better see the precision. It prevents the program from switching to E notation for large values and causes the program to display six digits to the right of the decimal. The arguments

`ios_base::fixed` and `ios_base::floatfield` are constants provided by including `iostream`.

### Listing 3.8 `floatnum.cpp`

---

```
// floatnum.cpp -- floating-point types
#include <iostream>
int main()
{
    using namespace std;
    cout.setf(ios_base::fixed, ios_base::floatfield); // fixed-point
    float tub = 10.0 / 3.0;    // good to about 6 places
    double mint = 10.0 / 3.0; // good to about 15 places
    const float million = 1.0e6;

    cout << "tub = " << tub;
    cout << ", a million tubs = " << million * tub;
    cout << ", \nand ten million tubs = ";
    cout << 10 * million * tub << endl;

    cout << "mint = " << mint << " and a million mints = ";
    cout << million * mint << endl;
    return 0;
}
```

---

Here is the output from the program in Listing 3.8:

```
tub = 3.333333, a million tubs = 3333333.250000,
and ten million tubs = 33333332.000000
mint = 3.333333 and a million mints = 3333333.333333
```

### Program Notes

Normally `cout` drops trailing zeros. For example, it would display `3333333.250000` as `3333333.25`. The call to `cout.setf()` overrides that behavior, at least in new implementations. The main thing to note in Listing 3.8 is how `float` has less precision than `double`. Both `tub` and `mint` are initialized to `10.0 / 3.0`. That should evaluate to `3.3333333333333333...`(etc.). Because `cout` prints six figures to the right of the decimal, you can see that both `tub` and `mint` are accurate that far. But after the program multiplies each number by a million, you see that `tub` diverges from the proper value after the seventh three. `tub` is good to seven significant figures. (This system guarantees six significant figures for `float`, but that's the worst-case scenario.) The type `double` variable, however, shows 13 threes, so it's good to at least 13 significant figures. Because the system guarantees 15, this shouldn't surprise you. Also note that multiplying a million `tubs` by 10 doesn't quite result in the correct answer; this again points out the limitations of `float` precision.

The `ostream` class to which `cout` belongs has class member functions that give you precise control over how the output is formatted—field widths, places to the right of the decimal point, decimal form or E form, and so on. Chapter 17 outlines those choices. This book's examples keep it simple and usually just use the `<<` operator. Occasionally, this practice displays more digits than necessary, but that causes only aesthetic harm. If you do mind, you can skim Chapter 17 to see how to use the formatting methods. Don't, however, expect to fully follow the explanations at this point.

### Reading Include Files

The include directives found at the top of C++ source files often take on the air of a magical incantation; novice C++ programmers learn, through reading and experience, which header files add particular functionalities, and they include them solely to make their programs work. Don't rely on the include files only as a source of mystic and arcane knowledge; feel free to open them up and read them. They are text files, so you can read them easily. All the files you include in your programs exist on your computer or in a place where your computer can use them. Find the includes you use and see what they contain. You'll quickly see that the source and header files you use are an excellent source of knowledge and information—in some cases, the best documentation available. Later, as you progress into more complex inclusions and begin to use other, nonstandard libraries in your applications, this habit will serve you well.

## Floating-Point Constants

When you write a floating-point constant in a program, in which floating-point type does the program store it? By default, floating-point constants such as `8.24` and `2.4E8` are type `double`. If you want a constant to be type `float`, you use an `f` or `F` suffix. For type `long double`, you use an `l` or `L` suffix. (Because the lowercase `l` looks a lot like the digit `1`, the uppercase `L` is a better choice.) Here are some samples:

```
1.234f          // a float constant
2.45E20F        // a float constant
2.345324E28     // a double constant
2.2L            // a long double constant
```

## Advantages and Disadvantages of Floating-Point Numbers

Floating-point numbers have two advantages over integers. First, they can represent values between integers. Second, because of the scaling factor, they can represent a much greater range of values. On the other hand, floating point operations usually are slightly slower than integer operations, and you can lose precision. Listing 3.9 illustrates the last point.

### Listing 3.9 `fltadd.cpp`

```
// fltadd.cpp -- precision problems with float
#include <iostream>
int main()
{
```

```
using namespace std;
float a = 2.34E+22f;
float b = a + 1.0f;

cout << "a = " << a << endl;
cout << "b - a = " << b - a << endl;
return 0;
}
```

The program in Listing 3.9 takes a number, adds 1, and then subtracts the original number. That should result in a value of 1. Does it? Here is the output from the program in Listing 3.9 for one system:

```
a = 2.34e+022
b - a = 0
```

The problem is that 2.34E+22 represents a number with 23 digits to the left of the decimal. By adding 1, you are attempting to add 1 to the 23rd digit in that number. But type `float` can represent only the first 6 or 7 digits in a number, so trying to change the 23rd digit has no effect on the value.

### Classifying Data Types

C++ brings some order to its basic types by classifying them into families. Types `signed char`, `short`, `int`, and `long` are termed *signed integer* types. C++11 adds `long long` to that list. The unsigned versions are termed *unsigned integer* types. The `bool`, `char`, `wchar_t`, `signed integer`, and `unsigned integer` types together are termed *integral* types or *integer* types. C++11 adds `char16_t` and `char32_t` to that list. The `float`, `double`, and `long double` types are termed *floating-point* types. Integer and floating-point types are collectively termed *arithmetic* types.

## C++ Arithmetic Operators

Perhaps you have warm memories of doing arithmetic drills in grade school. You can give that same pleasure to your computer. C++ uses operators to do arithmetic. It provides operators for five basic arithmetic calculations: addition, subtraction, multiplication, division, and taking the modulus. Each of these operators uses two values (called *operands*) to calculate a final answer. Together, the operator and its operands constitute an *expression*. For example, consider the following statement:

```
int wheels = 4 + 2;
```

The values 4 and 2 are operands, the + symbol is the addition operator, and 4 + 2 is an expression whose value is 6.



Here are C++'s five basic arithmetic operators:

- The + operator adds its operands. For example,  $4 + 20$  evaluates to 24.
- The - operator subtracts the second operand from the first. For example,  $12 - 3$  evaluates to 9.
- The \* operator multiplies its operands. For example,  $28 * 4$  evaluates to 112.
- The / operator divides its first operand by the second. For example,  $1000 / 5$  evaluates to 200. If both operands are integers, the result is the integer portion of the quotient. For example,  $17 / 3$  is 5, with the fractional part discarded.
- The % operator finds the modulus of its first operand with respect to the second. That is, it produces the remainder of dividing the first by the second. For example,  $19 \% 6$  is 1 because 6 goes into 19 three times, with a remainder of 1. Both operands must be integer types; using the % operator with floating-point values causes a compile-time error. If one of the operands is negative, the sign of the result satisfies the following rule:  $(a/b) * b + a \% b$  equals a.

Of course, you can use variables as well as constants for operands. Listing 3.10 does just that. Because the % operator works only with integers, we'll leave it for a later example.

#### Listing 3.10 `arith.cpp`

---

```
// arith.cpp -- some C++ arithmetic
#include <iostream>
int main()
{
    using namespace std;
    float hats, heads;

    cout.setf(ios_base::fixed, ios_base::floatfield); // fixed-point
    cout << "Enter a number: ";
    cin >> hats;
    cout << "Enter another number: ";
    cin >> heads;

    cout << "hats = " << hats << "; heads = " << heads << endl;
    cout << "hats + heads = " << hats + heads << endl;
    cout << "hats - heads = " << hats - heads << endl;
    cout << "hats * heads = " << hats * heads << endl;
    cout << "hats / heads = " << hats / heads << endl;
    return 0;
}
```

---

As you can see in the following sample output from the program in Listing 3.10, you can trust C++ to do simple arithmetic:

```
Enter a number: 50.25
Enter another number: 11.17
hats = 50.250000; heads = 11.170000
hats + heads = 61.419998
hats - heads = 39.080002
hats * heads = 561.292480
hats / heads = 4.498657
```

Well, maybe you can't trust it completely. Adding 11.17 to 50.25 should yield 61.42, but the output reports 61.419998. This is not an arithmetic problem; it's a problem with the limited capacity of type `float` to represent significant figures. Remember, C++ guarantees just six significant figures for `float`. If you round 61.419998 to six figures, you get 61.4200, which is the correct value to the guaranteed precision. The moral is that if you need greater accuracy, you should use `double` or `long double`.

## Order of Operation: Operator Precedence and Associativity

Can you trust C++ to do complicated arithmetic? Yes, but you must know the rules C++ uses. For example, many expressions involve more than one operator. That can raise questions about which operator gets applied first. For example, consider this statement:

```
int flyingpigs = 3 + 4 * 5; // 35 or 23?
```

The 4 appears to be an operand for both the `+` and `*` operators. When more than one operator can be applied to the same operand, C++ uses *precedence* rules to decide which operator is used first. The arithmetic operators follow the usual algebraic precedence, with multiplication, division, and the taking of the modulus done before addition and subtraction. Thus `3 + 4 * 5` means `3 + (4 * 5)`, not `(3 + 4) * 5`. So the answer is 23, not 35. Of course, you can use parentheses to enforce your own priorities. Appendix D, "Operator Precedence," shows precedence for all the C++ operators. Note that `*`, `/`, and `%` are all in the same row in Appendix D. That means they have equal precedence. Similarly, addition and subtraction share a lower precedence.

Sometimes the precedence list is not enough. Consider the following statement:

```
float logs = 120 / 4 * 5; // 150 or 6?
```

Once again, 4 is an operand for two operators. But the `/` and `*` operators have the same precedence, so precedence alone doesn't tell the program whether to first divide 120 by 4 or multiply 4 by 5. Because the first choice leads to a result of 150 and the second to a result of 6, the choice is an important one. When two operators have the same precedence, C++ looks at whether the operators have a left-to-right *associativity* or a right-to-left associativity. Left-to-right associativity means that if two operators acting on the same operand have the same precedence, you apply the left-hand operator first. For right-to-left associativity, you apply the right-hand operator first. The associativity information, too, is in Appendix D. Appendix D shows that multiplication and division associate left-to-right. That means you use 4 with the leftmost operator first. That is, you divide 120 by 4, get 30 as a result, and then multiply the result by 5 to get 150.

Note that the precedence and associativity rules come into play only when two operators share the same operand. Consider the following expression:

```
int dues = 20 * 5 + 24 * 6;
```

Operator precedence tells you two things: The program must evaluate  $20 * 5$  before doing addition, and the program must evaluate  $24 * 6$  before doing addition. But neither precedence nor associativity says which multiplication takes place first. You might think that associativity says to do the leftmost multiplication first, but in this case, the two  $*$  operators do not share a common operand, so the rules don't apply. In fact, C++ leaves it to the implementation to decide which order works best on a system. For this example, either order gives the same result, but there are circumstances in which the order can make a difference. You'll see one in Chapter 5, which discusses the increment operator.

## Division Diversions

You have yet to see the rest of the story about the division operator ( $/$ ). The behavior of this operator depends on the type of the operands. If both operands are integers, C++ performs integer division. That means any fractional part of the answer is discarded, making the result an integer. If one or both operands are floating-point values, the fractional part is kept, making the result floating-point. Listing 3.11 illustrates how C++ division works with different types of values. As in Listing 3.10, Listing 3.11 invokes the `setf()` member function to modify how the results are displayed.

Listing 3.11 `divide.cpp`

---

```
// divide.cpp -- integer and floating-point division
#include <iostream>
int main()
{
    using namespace std;
    cout.setf(ios_base::fixed, ios_base::floatfield);
    cout << "Integer division: 9/5 = " << 9 / 5 << endl;
    cout << "Floating-point division: 9.0/5.0 = ";
    cout << 9.0 / 5.0 << endl;
    cout << "Mixed division: 9.0/5 = " << 9.0 / 5 << endl;
    cout << "double constants: 1e7/9.0 = ";
    cout << 1.e7 / 9.0 << endl;
    cout << "float constants: 1e7f/9.0f = ";
    cout << 1.e7f / 9.0f << endl;
    return 0;
}
```

---

Here is the output from the program in Listing 3.11 for one implementation:

```
Integer division: 9/5 = 1
Floating-point division: 9.0/5.0 = 1.800000
Mixed division: 9.0/5 = 1.800000
```

```
double constants: 1e7/9.0 = 1111111.111111
float constants: 1e7f/9.0f = 1111111.125000
```

The first output line shows that dividing the integer 9 by the integer 5 yields the integer 1. The fractional part of  $4 / 5$  (or 0.8) is discarded. (You'll see a practical use for this kind of division when you learn about the modulus operator, later in this chapter.) The next two lines show that when at least one of the operands is floating-point, you get a floating-point answer of 1.8. Actually, when you try to combine mixed types, C++ converts all the concerned types to the same type. You'll learn about these automatic conversions later in this chapter. The relative precisions of the last two lines show that the result is type `double` if both operands are `double` and that it is `float` if both operands are `float`. Remember, floating-point constants are type `double` by default.

### A Glimpse at Operator Overloading

In Listing 3.11, the division operator represents three distinct operations: `int` division, `float` division, and `double` division. C++ uses the context—in this case the type of operands—to determine which operator is meant. The process of using the same symbol for more than one operation is called *operator overloading*. C++ has a few examples of overloading built in to the language. C++ also lets you extend operator overloading to user-defined classes, so what you see here is a precursor of an important OOP property (see Figure 3.4).

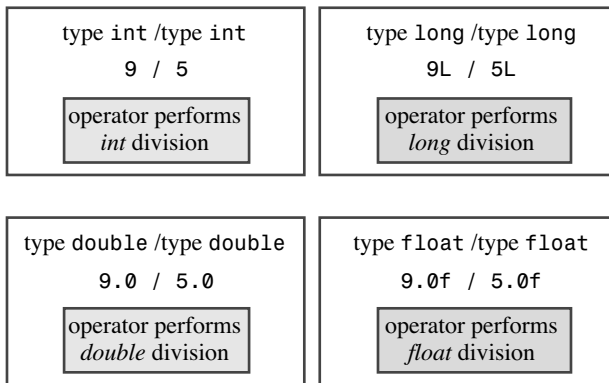

Figure 3.4 Different divisions.

## The Modulus Operator

Most people are more familiar with addition, subtraction, multiplication, and division than with the modulus operation, so let's take a moment to look at the modulus operator in action. The modulus operator returns the remainder of an integer division. In combination with integer division, the modulus operation is particularly useful in problems that require dividing a quantity into different integral units, such as converting inches to feet and inches or converting dollars to quarters, dimes, nickels, and pennies. In Chapter 2,

Listing 2.6 converts weight in British stone to pounds. Listing 3.12 reverses the process, converting weight in pounds to stone. A stone, you remember, is 14 pounds, and most British bathroom scales are calibrated in this unit. The program uses integer division to find the largest number of whole stone in the weight, and it uses the modulus operator to find the number of pounds left over.

### Listing 3.12 `modulus.cpp`

---

```
// modulus.cpp -- uses % operator to convert lbs to stone
#include <iostream>
int main()
{
    using namespace std;
    const int Lbs_per_stn = 14;
    int lbs;

    cout << "Enter your weight in pounds: ";
    cin >> lbs;
    int stone = lbs / Lbs_per_stn;    // whole stone
    int pounds = lbs % Lbs_per_stn;   // remainder in pounds
    cout << lbs << " pounds are " << stone
        << " stone, " << pounds << " pound(s).\n";
    return 0;
}
```

---

Here is a sample run of the program in Listing 3.12:

```
Enter your weight in pounds: 181
181 pounds are 12 stone, 13 pound(s).
```

In the expression `lbs / Lbs_per_stn`, both operands are type `int`, so the computer performs integer division. With a `lbs` value of 181, the expression evaluates to 12. The product of 12 and 14 is 168, so the remainder of dividing 14 into 181 is 13, and that's the value of `lbs % Lbs_per_stn`. Now you are prepared technically, if not emotionally, to respond to questions about your weight when you travel in Great Britain.

## Type Conversions

C++'s profusion of types lets you match the type to the need. It also complicates life for the computer. For example, adding two `short` values may involve different hardware instructions than adding two `long` values. With 11 integer types and 3 floating-point types, the computer can have a lot of different cases to handle, especially if you start mixing types. To help deal with this potential mishmash, C++ makes many type conversions automatically:

- C++ converts values when you assign a value of one arithmetic type to a variable of another arithmetic type.

- C++ converts values when you combine mixed types in expressions.
- C++ converts values when you pass arguments to functions.

If you don't understand what happens in these automatic conversions, you might find some program results baffling, so let's take a more detailed look at the rules.

### Conversion on Initialization and Assignment

C++ is fairly liberal in allowing you to assign a numeric value of one type to a variable of another type. Whenever you do so, the value is converted to the type of the receiving variable. For example, suppose `so_long` is type `long`, `thirty` is type `short`, and you have the following statement in a program:

```
so_long = thirty;           // assigning a short to a long
```

The program takes the value of `thirty` (typically a 16-bit value) and expands it to a `long` value (typically a 32-bit value) upon making the assignment. Note that the expansion creates a new value to place into `so_long`; the contents of `thirty` are unaltered.

Assigning a value to a type with a greater range usually poses no problem. For example, assigning a `short` value to a `long` variable doesn't change the value; it just gives the value a few more bytes in which to laze about. However, assigning a large `long` value such as 2111222333 to a `float` variable results in the loss of some precision. Because `float` can have just six significant figures, the value can be rounded to 2.11122E9. So while some conversions are safe, some may pose difficulties. Table 3.3 points out some possible conversion problems.

Table 3.3 Potential Numeric Conversion Problems

Conversion Type	Potential Problems
Bigger floating-point type to smaller floating-point type, such as <code>double</code> to <code>float</code>	Loss of precision (significant figures); value might be out of range for target type, in which case result is undefined.
Floating-point type to integer type	Loss of fractional part; original value might be out of range for target type, in which case result is undefined.
Bigger integer type to smaller integer type, such as <code>long</code> to <code>short</code>	Original value might be out of range for target type; typically just the low-order bytes are copied.

A zero value assigned to a `bool` variable is converted to `false`, and a nonzero value is converted to `true`.

Assigning floating-point values to integer types poses a couple problems. First, converting floating-point to integer results in truncating the number (discarding the fractional part). Second, a `float` value might be too big to fit in a cramped `int` variable. In that

case, C++ doesn't define what the result should be; that means different implementations can respond differently.

Traditional initialization behaves the same as assignment. Listing 3.13 shows a few conversions by initialization.

Listing 3.13 `init.cpp`

---

```
// init.cpp -- type changes on initialization
#include <iostream>
int main()
{
    using namespace std;
    cout.setf(ios_base::fixed, ios_base::floatfield);
    float tree = 3;    // int converted to float
    int guess(3.9832); // double converted to int
    int debt = 7.2E12; // result not defined in C++
    cout << "tree = " << tree << endl;
    cout << "guess = " << guess << endl;
    cout << "debt = " << debt << endl;
    return 0;
}
```

---

Here is the output from the program in Listing 3.13 for one system:

```
tree = 3.000000
guess = 3
debt = 1634811904
```

In this case, `tree` is assigned the floating-point value 3.0. Assigning 3.9832 to the `int` variable `guess` causes the value to be truncated to 3; C++ uses truncation (discarding the fractional part) and not rounding (finding the closest integer value) when converting floating-point types to integer types. Finally, note that the `int` variable `debt` is unable to hold the value 7.2E12. This creates a situation in which C++ doesn't define the result. On this system, `debt` ends up with the value 1634811904, or about 1.6E09. Well, that's a novel way to reduce massive indebtedness!

Some compilers issue warnings of possible data loss for those statements that initialize integer variables to floating-point values. Also the value displayed for `debt` varies from compiler to compiler. For example, running the same program from Listing 3.13 on a second system produced a value of 2147483647.

### Initialization Conversions When `{ }` Are Used (C++11)

C++11 calls an initialization that uses braces a *list-initialization*. That's because this form can be used more generally to provide lists of values for more complicated data types. It's more restrictive in type conversions than the forms used in Listing 13.3. In particular, list-initialization doesn't permit *narrowing*, which is when the type of the variable may not be able to represent the assigned value. For example, conversions of floating types to integer

types are not allowed. Converting from integer types to other integer types or floating types may be allowed if the compiler can tell if the target variable can hold the value correctly. For instance, it's okay to initialize a `long` variable to an `int` value because `long` is always at least as big as `int`. Conversions in the other direction may be allowed if the value is a constant that can be handled by the type:

```
const int code = 66;
int x = 66;
char c1 {31325}; // narrowing, not allowed
char c2 = {66}; // allowed because char can hold 66
char c3 {code}; // ditto
char c4 = {x}; // not allowed, x is not constant
x = 31325;
char c5 = x; // allowed by this form of initialization
```

For the initialization of `c4`, we know `x` has the value `66`, but to the compiler, `x` is a variable and conceivably could have some other, much larger value. It's not the compiler's job to keep track of what may have happened to `x` between the time it was initialized and the time it was used in the attempted initialization of `c4`.

## Conversions in Expressions

Consider what happens when you combine two different arithmetic types in one expression. C++ makes two kinds of automatic conversions in that case. First, some types are automatically converted whenever they occur. Second, some types are converted when they are combined with other types in an expression.

First, let's examine the automatic conversions. When it evaluates expressions, C++ converts `bool`, `char`, `unsigned char`, `signed char`, and `short` values to `int`. In particular, `true` is promoted to `1` and `false` to `0`. These conversions are termed *integral promotions*. For example, consider the following fowl statements:

```
short chickens = 20; // line 1
short ducks = 35; // line 2
short fowl = chickens + ducks; // line 3
```

To execute the statement on line 3, a C++ program takes the values of `chickens` and `ducks` and converts both to `int`. Then the program converts the result back to type `short` because the answer is assigned to a type `short` variable. You might find this a bit round-about, but it does make sense. The `int` type is generally chosen to be the computer's most natural type, which means the computer probably does calculations fastest for that type.

There are more integral promotions: The `unsigned short` type is converted to `int` if `short` is smaller than `int`. If the two types are the same size, `unsigned short` is converted to `unsigned int`. This rule ensures that there's no data loss in promoting `unsigned short`. Similarly, `wchar_t` is promoted to the first of the following types that is wide enough to accommodate its range: `int`, `unsigned int`, `long`, or `unsigned long`.



Then there are the conversions that take place when you arithmetically combine different types, such as adding an `int` to a `float`. When an operation involves two types, the smaller is converted to the larger. For example, the program in Listing 3.11 divides 9.0 by 5. Because 9.0 is type `double`, the program converts 5 to type `double` before it does the division. More generally, the compiler goes through a checklist to determine which conversions to make in an arithmetic expression. C++11 has modified the list slightly. Here's the C++11 version of the list, which the compiler goes through in order:

1. If either operand is type `long double`, the other operand is converted to `long double`.
2. Otherwise, if either operand is `double`, the other operand is converted to `double`.
3. Otherwise, if either operand is `float`, the other operand is converted to `float`.
4. Otherwise, the operands are integer types and the integral promotions are made.
5. In that case, if both operands are signed or if both are unsigned, and one is of lower rank than the other, it is converted to the higher rank.
6. Otherwise, one operand is signed and one is unsigned. If the unsigned operand is of higher rank than the signed operand, the latter is converted to the type of the unsigned operand.
7. Otherwise, if the signed type can represent all values of the unsigned type, the unsigned operand is converted to the type of the signed type.
8. Otherwise, both operands are converted to the unsigned version of the signed type.

ANSI C follows the same rules as ISO 2003 C++, which are slightly different from the preceding rules, and classic K&R C has yet slightly different rules. For example, classic C always promotes `float` to `double`, even if both operands are `float`.

This list introduces the concept of ranking the integer types. In brief, as you might expect, the basic ranking for signed integer types from high to low is `long long`, `long`, `int`, `short`, and `signed char`. Unsigned types have the same rank as the corresponding signed type. The three types `char`, `signed char`, and `unsigned char` all have the same rank. The `bool` type has the lowest rank. The `wchar_t`, `char16_t`, and `char32_t` have the same types as their underlying types.

### Conversions in Passing Arguments

Normally, C++ function prototyping controls type conversions for the passing of arguments, as you'll learn in Chapter 7, "Functions: C++'s Programming Modules." However, it is possible, although usually unwise, to waive prototype control for argument passing. In that case, C++ applies the integral promotions to the `char` and `short` types (signed

and unsigned). Also to preserve compatibility with huge amounts of code in classic C, C++ promotes `float` arguments to `double` when passing them to a function that waives prototyping.

## Type Casts

C++ empowers you to force type conversions explicitly via the type cast mechanism. (C++ recognizes the need for type rules, and it also recognizes the need to occasionally override those rules.) The type cast comes in two forms. For example, to convert an `int` value stored in a variable called `thorn` to type `long`, you can use either of the following expressions:

```
(long) thorn    // returns a type long conversion of thorn
long (thorn)   // returns a type long conversion of thorn
```

The type cast doesn't alter the `thorn` variable itself; instead, it creates a new value of the indicated type, which you can then use in an expression, as in the following:

```
cout << int('Q'); // displays the integer code for 'Q'
```

More generally, you can do the following:

```
(typeName) value // converts value to typeName type
typeName (value) // converts value to typeName type
```

The first form is straight C. The second form is pure C++. The idea behind the new form is to make a type cast look like a function call. This makes type casts for the built-in types look like the type conversions you can design for user-defined classes.

C++ also introduces four type cast operators that are more restrictive in how they can be used. Chapter 15, “Friends, Exceptions, and More,” covers them. Of the four, the `static_cast<>` operator, can be used for converting values from one numeric type to another. For example, using it to convert `thorn` to a type `long` value looks like this:

```
static_cast<long> (thorn) // returns a type long conversion of thorn
```

More generally, you can do the following:

```
static_cast<typeName> (value) // converts value to typeName type
```

As Chapter 15 discusses further, Stroustrup felt that the traditional C-style type cast is dangerously unlimited in its possibilities. The `static_cast<>` operator is more restrictive than the traditional type cast.

Listing 3.14 briefly illustrates both the basic type cast (two forms) and `static_cast<>`. Imagine that the first section of this listing is part of a powerful ecological modeling program that does floating-point calculations that are converted to integral numbers of birds and animals. The results you get depend on when you convert. The calculation for `auks` first adds the floating-point values and then converts the sum to `int` upon assignment. But the calculations for `bats` and `coots` first use type casts to convert the floating-point values to `int` and then sum the values. The final part of the program shows how you can use a type cast to display the ASCII code for a type `char` value.

Listing 3.14 `typecast.cpp`

---

```
// typecast.cpp -- forcing type changes
#include <iostream>
int main()
{
    using namespace std;
    int auks, bats, coots;

    // the following statement adds the values as double,
    // then converts the result to int
    auks = 19.99 + 11.99;

    // these statements add values as int
    bats = (int) 19.99 + (int) 11.99; // old C syntax
    coots = int (19.99) + int (11.99); // new C++ syntax
    cout << "auks = " << auks << ", bats = " << bats;
    cout << ", coots = " << coots << endl;

    char ch = 'Z';
    cout << "The code for " << ch << " is "; // print as char
    cout << int(ch) << endl; // print as int
    cout << "Yes, the code is ";
    cout << static_cast<int>(ch) << endl; // using static_cast
    return 0;
}
```

---

Here is the result of the program in Listing 3.14:

```
auks = 31, bats = 30, coots = 30
The code for Z is 90
Yes, the code is 90
```

First, adding 19.99 to 11.99 yields 31.98. When this value is assigned to the `int` variable `auks`, it's truncated to 31. But using type casts truncates the same two values to 19 and 11 before addition, making 30 the result for both `bats` and `coots`. Then two `cout` statements use type casts to convert a type `char` value to `int` before they display the result. These conversions cause `cout` to print the value as an integer rather than as a character.

This program illustrates two reasons to use type casting. First, you might have values that are stored as type `double` but are used to calculate a type `int` value. For example, you might be fitting a position to a grid or modeling integer values, such as populations, with floating-point numbers. You might want the calculations to treat the values as `int`. Type casting enables you to do so directly. Notice that you get a different result, at least for these values, when you convert to `int` and add than you do when you add first and then convert to `int`.

The second part of the program shows the most common reason to use a type cast: the capability to compel data in one form to meet a different expectation. In Listing 3.14, for example, the `char` variable `ch` holds the code for the letter `Z`. Using `cout` with `ch` displays the character `Z` because `cout` zeros in on the fact that `ch` is type `char`. But by type casting `ch` to type `int`, you get `cout` to shift to `int` mode and print the ASCII code stored in `ch`.

## auto Declarations in C++11

C++11 introduces a facility that allows the compiler to deduce a type from the type of an initialization value. For this purpose it redefines the meaning of `auto`, a keyword dating back to C, but one hardly ever used. (Chapter 9 discusses the previous meaning of `auto`.) Just use `auto` instead of the type name in an initializing declaration, and the compiler assigns the variable the same type as that of the initializer:

```
auto n = 100;    // n is int
auto x = 1.5;    // x is double
auto y = 1.3e12L; // y is long double
```

However, this automatic type deduction isn't really intended for such simple cases. Indeed, you might even go astray. For example, suppose `x`, `y`, and `z` are all intended to be type `double`. Consider the following code:

```
auto x = 0.0;    // ok, x is double because 0.0 is double
double y = 0;    // ok, 0 automatically converted to 0.0
auto z = 0;      // oops, z is int because 0 is int
```

Using `0` instead of `0.0` doesn't cause problems with explicit typing, but it does with automatic type conversion.

Automatic type deduction becomes much more useful when dealing with complicated types, such as those in the STL (Standard Template Library). For example, C++98 code might have this:

```
std::vector<double> scores;
std::vector<double>::iterator pv = scores.begin();
```

C++11 allows you to write this instead:

```
std::vector<double> scores;
auto pv = scores.begin();
```

We'll mention this new meaning of `auto` again later when it becomes more relevant to the topics at hand.

## Summary

C++'s basic types fall into two groups. One group consists of values that are stored as integers. The second group consists of values that are stored in floating-point format. The integer types differ from each other in the amount of memory used to store values and in whether they are signed or unsigned. From smallest to largest, the integer types are `bool`,

`char`, `signed char`, `unsigned char`, `short`, `unsigned short`, `int`, `unsigned int`, `long`, `unsigned long`, and, with C++11, `long long`, and `unsigned long long`. There is also a `wchar_t` type whose placement in this sequence of size depends on the implementation. C++11 adds the `char16_t` and `char32_t` types, which are wide enough to hold 16-bit and 32-bit character codes, respectively. C++ guarantees that `char` is large enough to hold any member of the system's basic character set, `wchar_t` can hold any member of the system's extended character set, `short` is at least 16 bits, `int` is at least as big as `short`, and `long` is at least 32 bits and at least as large as `int`. The exact sizes depend on the implementation.

Characters are represented by their numeric codes. The I/O system determines whether a code is interpreted as a character or as a number.

The floating-point types can represent fractional values and values much larger than integers can represent. The three floating-point types are `float`, `double`, and `long double`. C++ guarantees that `float` is no larger than `double` and that `double` is no larger than `long double`. Typically, `float` uses 32 bits of memory, `double` uses 64 bits, and `long double` uses 80 to 128 bits.

By providing a variety of types in different sizes and in both signed and unsigned varieties, C++ lets you match the type to particular data requirements.

C++ uses operators to provide the usual arithmetical support for numeric types: addition, subtraction, multiplication, division, and taking the modulus. When two operators seek to operate on the same value, C++'s precedence and associativity rules determine which operation takes place first.

C++ converts values from one type to another when you assign values to a variable, mix types in arithmetic, and use type casts to force type conversions. Many type conversions are "safe," meaning you can make them with no loss or alteration of data. For example, you can convert an `int` value to a `long` value with no problems. Others, such as conversions of floating-point types to integer types, require more care.

At first, you might find the large number of basic C++ types a little excessive, particularly when you take into account the various conversion rules. But most likely you will eventually find occasions when one of the types is just what you need at the time, and you'll thank C++ for having it.

## Chapter Review

1. Why does C++ have more than one integer type?
2. Declare variables matching the following descriptions:
  - a. A `short` integer with the value 80
  - b. An `unsigned int` integer with the value 42,110
  - c. An integer with the value 3,000,000,000

3. What safeguards does C++ provide to keep you from exceeding the limits of an integer type?
4. What is the distinction between `33L` and `33`?
5. Consider the two C++ statements that follow:  

```
char grade = 65;  
char grade = 'A';
```

Are they equivalent?
6. How could you use C++ to find out which character the code `88` represents? Come up with at least two ways.
7. Assigning a `long` value to a `float` can result in a rounding error. What about assigning `long` to `double`? `long long` to `double`?
8. Evaluate the following expressions as C++ would:
  - a.  $8 * 9 + 2$
  - b.  $6 * 3 / 4$
  - c.  $3 / 4 * 6$
  - d.  $6.0 * 3 / 4$
  - e.  $15 \% 4$
9. Suppose `x1` and `x2` are two type `double` variables that you want to add as integers and assign to an integer variable. Construct a C++ statement for doing so. What if you want to add them as type `double` and then convert to `int`?
10. What is the variable type for each of the following declarations?
  - a. `auto cars = 15;`
  - b. `auto iou = 150.37f;`
  - c. `auto level = 'B';`
  - d. `auto crat = U'/U00002155';`
  - e. `auto fract = 8.25f/2.5;`

## Programming Exercises

1. Write a short program that asks for your height in integer inches and then converts your height to feet and inches. Have the program use the underscore character to indicate where to type the response. Also use a `const` symbolic constant to represent the conversion factor.

2. Write a short program that asks for your height in feet and inches and your weight in pounds. (Use three variables to store the information.) Have the program report your body mass index (BMI). To calculate the BMI, first convert your height in feet and inches to your height in inches (1 foot = 12 inches). Then convert your height in inches to your height in meters by multiplying by 0.0254. Then convert your weight in pounds into your mass in kilograms by dividing by 2.2. Finally, compute your BMI by dividing your mass in kilograms by the square of your height in meters. Use symbolic constants to represent the various conversion factors.
3. Write a program that asks the user to enter a latitude in degrees, minutes, and seconds and that then displays the latitude in decimal format. There are 60 seconds of arc to a minute and 60 minutes of arc to a degree; represent these values with symbolic constants. You should use a separate variable for each input value. A sample run should look like this:

```
Enter a latitude in degrees, minutes, and seconds:
First, enter the degrees: 37
Next, enter the minutes of arc: 51
Finally, enter the seconds of arc: 19
37 degrees, 51 minutes, 19 seconds = 37.8553 degrees
```

4. Write a program that asks the user to enter the number of seconds as an integer value (use type `long`, or, if available, `long long`) and that then displays the equivalent time in days, hours, minutes, and seconds. Use symbolic constants to represent the number of hours in the day, the number of minutes in an hour, and the number of seconds in a minute. The output should look like this:

```
Enter the number of seconds: 31600000
31600000 seconds = 365 days, 17 hours, 46 minutes, 40 seconds
```

5. Write a program that requests the user to enter the current world population and the current population of the U.S. (or of some other nation of your choice). Store the information in variables of type `long long`. Have the program display the percent that the U.S. (or other nation's) population is of the world's population. The output should look something like this:

```
Enter the world's population: 6898758899
Enter the population of the US: 310783781
The population of the US is 4.50492% of the world population.
```

You can use the Internet to get more recent figures.

6. Write a program that asks how many miles you have driven and how many gallons of gasoline you have used and then reports the miles per gallon your car has gotten. Or, if you prefer, the program can request distance in kilometers and petrol in liters and then report the result European style, in liters per 100 kilometers.

7. Write a program that asks you to enter an automobile gasoline consumption figure in the European style (liters per 100 kilometers) and converts to the U.S. style of miles per gallon. Note that in addition to using different units of measurement, the U.S. approach (distance / fuel) is the inverse of the European approach (fuel / distance). Note that 100 kilometers is 62.14 miles, and 1 gallon is 3.875 liters. Thus, 19 mpg is about 12.4 l/100 km, and 27 mpg is about 8.7 l/100 km.



*This page intentionally left blank*

# Compound Types

In this chapter you'll learn about the following:

- Creating and using arrays
- Creating and using C-style strings
- Creating and using `string`-class strings
- Using the `getline()` and `get()` methods for reading strings
- Mixing string and numeric input
- Creating and using structures
- Creating and using unions
- Creating and using enumerations
- Creating and using pointers
- Managing dynamic memory with `new` and `delete`
- Creating dynamic arrays
- Creating dynamic structures
- Automatic, static, and dynamic storage
- The `vector` and `array` classes (an introduction)

Say you've developed a computer game called *User-Hostile* in which players match wits with a cryptic and abusive computer interface. Now you must write a program that keeps track of your monthly game sales for a five-year period. Or you want to inventory your accumulation of hacker-hero trading cards. You soon conclude that you need something more than C++'s simple basic types to meet these data requirements, and C++ offers something more—compound types. These are types built from the basic integer and floating-point types. The most far-reaching compound type is the class, that bastion of OOP toward which we are progressing. But C++ also supports several more modest compound types taken from C. The array, for example, can hold several values of the same type. A particular kind of array can hold a string, which is a series of characters. Structures can hold several values of differing types. Then there are pointers, which are variables that tell a computer where data is placed. You'll examine all these compound forms (except

classes) in this chapter, take a first look at `new` and `delete` and how you can use them to manage data, and take an introductory look at the C++ `string` class, which gives you an alternative way to work with strings.

## Introducing Arrays

An *array* is a data form that can hold several values, all of one type. For example, an array can hold 60 type `int` values that represent five years of game sales data, 12 `short` values that represent the number of days in each month, or 365 `float` values that indicate your food expenses for each day of the year. Each value is stored in a separate array element, and the computer stores all the elements of an array consecutively in memory.

To create an array, you use a declaration statement. An array declaration should indicate three things:

- The type of value to be stored in each element
- The name of the array
- The number of elements in the array

You accomplish this in C++ by modifying the declaration for a simple variable and adding brackets that contain the number of elements. For example, the following declaration creates an array named `months` that has 12 elements, each of which can hold a type `short` value:

```
short months[12];    // creates array of 12 short
```

Each element, in essence, is a variable that you can treat as a simple variable.

This is the general form for declaring an array:

```
typeName arrayName[arraySize];
```

The expression `arraySize`, which is the number of elements, must be an integer constant, such as 10 or a `const` value, or a constant expression, such as `8 * sizeof (int)`, for which all values are known at the time compilation takes place. In particular, `arraySize` cannot be a variable whose value is set while the program is running. However, later in this chapter you'll learn how to use the `new` operator to get around that restriction.

### The Array as Compound Type

An array is called a *compound type* because it is built from some other type. (C uses the term *derived type*, but because C++ uses the term *derived* for class relationships, it had to come up with a new term.) You can't simply declare that something is an array; it always has to be an array of some particular type. There is no generalized array type. Instead, there are many specific array types, such as array of `char` or array of `long`. For example, consider this declaration:

```
float loans[20];
```

The type for `loans` is not "array"; rather, it is "array of `float`." This emphasizes that the `loans` array is built from the `float` type.

Much of the usefulness of the array comes from the fact that you can access array elements individually. The way to do this is to use a *subscript*, or an *index*, to number the elements. C++ array numbering starts with zero. (This is nonnegotiable; you have to start at zero. Pascal and BASIC users will have to adjust.) C++ uses a bracket notation with the index to specify an array element. For example, `months[0]` is the first element of the `months` array, and `months[11]` is the last element. Note that the index of the last element is one less than the size of the array (see Figure 4.1). Thus, an array declaration enables you to create a lot of variables with a single declaration, and you can then use an index to identify and access individual elements.

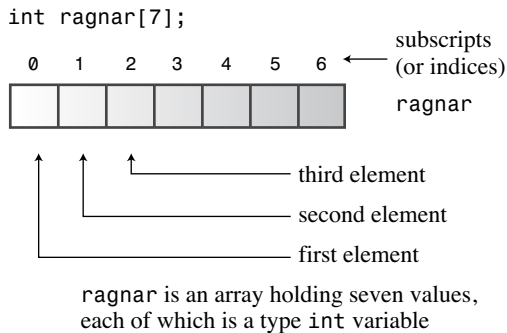

Figure 4.1 Creating an array.

### The Importance of Valid Subscript Values

The compiler does not check to see if you use a valid subscript. For instance, the compiler won't complain if you assign a value to the nonexistent element `months[101]`. But that assignment could cause problems when the program runs, possibly corrupting data or code, possibly causing the program to abort. So it is your responsibility to make sure that your program uses only valid subscript values.

The `yam` analysis program in Listing 4.1 demonstrates a few properties of arrays, including declaring an array, assigning values to array elements, and initializing an array.

#### Listing 4.1 `arrayone.cpp`

```
// arrayone.cpp -- small arrays of integers
#include <iostream>
int main()
{
    using namespace std;
    int yams[3];    // creates array with three elements
    yams[0] = 7;   // assign value to first element
```

```

    yams[1] = 8;
    yams[2] = 6;

    int yamcosts[3] = {20, 30, 5}; // create, initialize array
// NOTE: If your C++ compiler or translator can't initialize
// this array, use static int yamcosts[3] instead of
// int yamcosts[3]

    cout << "Total yams = ";
    cout << yams[0] + yams[1] + yams[2] << endl;
    cout << "The package with " << yams[1] << " yams costs ";
    cout << yamcosts[1] << " cents per yam.\n";
    int total = yams[0] * yamcosts[0] + yams[1] * yamcosts[1];
    total = total + yams[2] * yamcosts[2];
    cout << "The total yam expense is " << total << " cents.\n";

    cout << "\nSize of yams array = " << sizeof yams;
    cout << " bytes.\n";
    cout << "Size of one element = " << sizeof yams[0];
    cout << " bytes.\n";
    return 0;
}

```

---

Here is the output from the program in Listing 4.1:

```

Total yams = 21
The package with 8 yams costs 30 cents per yam.
The total yam expense is 410 cents.

Size of yams array = 12 bytes.
Size of one element = 4 bytes.

```

## Program Notes

First, the program in Listing 4.1 creates a three-element array called `yams`. Because `yams` has three elements, the elements are numbered from 0 through 2, and `arrayone.cpp` uses index values of 0 through 2 to assign values to the three individual elements. Each individual `yam` element is an `int` with all the rights and privileges of an `int` type, so `arrayone.cpp` can, and does, assign values to elements, add elements, multiply elements, and display elements.

The program uses the long way to assign values to the `yam` elements. C++ also lets you initialize array elements within the declaration statement. Listing 4.1 uses this shortcut to assign values to the `yamcosts` array:

```
int yamcosts[3] = {20, 30, 5};
```

It simply provides a comma-separated list of values (the *initialization list*) enclosed in braces. The spaces in the list are optional. If you don't initialize an array that's defined inside a function, the element values remain undefined. That means the element takes on whatever value previously resided at that location in memory.

Next, the program uses the array values in a few calculations. This part of the program looks cluttered with all the subscripts and brackets. The `for` loop, coming up in Chapter 5, "Loops and Relational Expressions," provides a powerful way to deal with arrays and eliminates the need to write each index explicitly. For the time being, we'll stick to small arrays.

As you should recall, the `sizeof` operator returns the size, in bytes, of a type or data object. Note that if you use the `sizeof` operator with an array name, you get the number of bytes in the whole array. But if you use `sizeof` with an array element, you get the size, in bytes, of the element. This illustrates that `yams` is an array, but `yams[1]` is just an `int`.

## Initialization Rules for Arrays

C++ has several rules about initializing arrays. They restrict when you can do it, and they determine what happens if the number of array elements doesn't match the number of values in the initializer. Let's examine these rules.

You can use the initialization form *only* when defining the array. You cannot use it later, and you cannot assign one array wholesale to another:

```
int cards[4] = {3, 6, 8, 10};    // okay
int hand[4];                    // okay
hand[4] = {5, 6, 7, 9};        // not allowed
hand = cards;                   // not allowed
```

However, you can use subscripts and assign values to the elements of an array individually.

When initializing an array, you can provide fewer values than array elements. For example, the following statement initializes only the first two elements of `hotelTips`:

```
float hotelTips[5] = {5.0, 2.5};
```

If you partially initialize an array, the compiler sets the remaining elements to zero. Thus, it's easy to initialize all the elements of an array to zero—just explicitly initialize the first element to zero and then let the compiler initialize the remaining elements to zero:

```
long totals[500] = {0};
```

Note that if you initialize to `{1}` instead of to `{0}`, just the first element is set to 1; the rest still get set to 0.

If you leave the square brackets (`[]`) empty when you initialize an array, the C++ compiler counts the elements for you. Suppose, for example, that you make this declaration:

```
short things[] = {1, 5, 3, 8};
```

The compiler makes `things` an array of four elements.

### Letting the Compiler Do It

Often, letting the compiler count the number of elements is poor practice because its count can be different from what you think it should be. You could, for instance, accidentally omit an initial value from the list. However, this approach can be a safe one for initializing a character array to a string, as you'll soon see. And if your main concern is that the program, not you, knows how large an array is, you can do something like this:

```
short things[] = {1, 5, 3, 8};
int num_elements = sizeof things / sizeof (short);
```

Whether this is useful or lazy depends on the circumstances.

## C++11 Array Initialization

As Chapter 3, “Dealing with Data,” mentioned, C++11 makes the brace form of initialization (list-initialization) a universal form for all types. Arrays already use list-initialization, but the C++11 version adds a few more features.

First, you can drop the = sign when initializing an array:

```
double earnings[4] {1.2e4, 1.6e4, 1.1e4, 1.7e4}; // okay with C++11
```

Second, you can use empty braces to set all the elements to 0:

```
unsigned int counts[10] = {}; // all elements set to 0
float balances[100] {}; // all elements set to 0
```

Third, as discussed in Chapter 3, list-initialization protects against narrowing:

```
long plifs[] = {25, 92, 3.0}; // not allowed
char slifs[4] {'h', 'i', 1122011, '\0'}; // not allowed
char tlifs[4] {'h', 'i', 112, '\0'}; // allowed
```

The first initialization fails because converting from a floating-point type to an integer type is narrowing, even if the floating-point value has only zeros after the decimal point. The second initialization fails because 1122011 is outside the range of a char, assuming we have an 8-bit char. The third succeeds because, even though 112 is an int value, it still is in the range of a char.

The C++ Standard Template Library (STL) provides an alternative to arrays called the vector template class, and C++11 adds an array template class. These alternatives are more sophisticated and flexible than the built-in array composite type. This chapter will discuss them briefly later, and Chapter 16, “The string Class and the Standard Template Library,” discusses them more fully.

## Strings

A *string* is a series of characters stored in consecutive bytes of memory. C++ has two ways of dealing with strings. The first, taken from C and often called a *C-style string*, is the first one this chapter examines. Later, this chapter discusses an alternative method based on a string class library.

The idea of a series of characters stored in consecutive bytes implies that you can store a string in an array of `char`, with each character kept in its own array element. Strings provide a convenient way to store text information, such as messages to the user (“*Please tell me your secret Swiss bank account number*”) or responses from the user (“*You must be joking*”). C-style strings have a special feature: The last character of every string is the *null character*. This character, written `\0`, is the character with ASCII code 0, and it serves to mark the string’s end. For example, consider the following two declarations:

```
char dog[8] = { 'b', 'e', 'a', 'u', 'x', ' ', 'I', 'I' }; // not a string!
char cat[8] = { 'f', 'a', 't', 'e', 's', 's', 'a', '\0' }; // a string!
```

Both of these arrays are arrays of `char`, but only the second is a string. The null character plays a fundamental role in C-style strings. For example, C++ has many functions that handle strings, including those used by `cout`. They all work by processing a string character-by-character until they reach the null character. If you ask `cout` to display a nice string like `cat` in the preceding example, it displays the first seven characters, detects the null character, and stops. But if you are ungracious enough to tell `cout` to display the `dog` array from the preceding example, which is not a string, `cout` prints the eight letters in the array and then keeps marching through memory byte-by-byte, interpreting each byte as a character to print, until it reaches a null character. Because null characters, which really are bytes set to zero, tend to be common in memory, the damage is usually contained quickly; nonetheless, you should not treat nonstring character arrays as strings.

The `cat` array example makes initializing an array to a string look tedious—all those single quotes and then having to remember the null character. Don’t worry. There is a better way to initialize a character array to a string. Just use a quoted string, called a *string constant* or *string literal*, as in the following:

```
char bird[11] = "Mr. Cheeps"; // the \0 is understood
char fish[] = "Bubbles"; // let the compiler count
```

Quoted strings always include the terminating null character implicitly, so you don’t have to spell it out (see Figure 4.2). Also the various C++ input facilities for reading a string from keyboard input into a `char` array automatically add the terminating null character for you. (If, when you run the program in Listing 4.1, you discover that you have to use the keyword `static` to initialize an array, you have to use it with these `char` arrays, too.)

Of course, you should make sure the array is large enough to hold all the characters of the string, including the null character. Initializing a character array with a string constant is one case where it may be safer to let the compiler count the number of elements for you. There is no harm, other than wasted space, in making an array larger than the string. That’s because functions that work with strings are guided by the location of the null character, not by the size of the array. C++ imposes no limits on the length of a string.

### Caution

When determining the minimum array size necessary to hold a string, remember to include the terminating null character in your count.



```
char boss[8] = "Bozo";
```

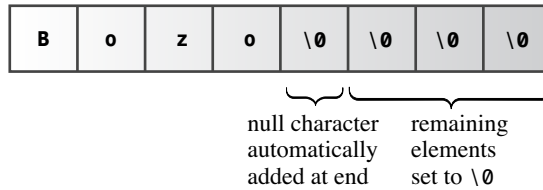

## Using Strings in an Array

The two most common ways of getting a string into an array are to initialize an array to a string constant and to read keyboard or file input into an array. Listing 4.2 demonstrates these approaches by initializing one array to a quoted string and using `cin` to place an input string into a second array. The program also uses the standard C library function `strlen()` to get the length of a string. The standard `cstring` header file (or `string.h` for older implementations) provides declarations for this and many other string-related functions.

### Listing 4.2 `strings.cpp`

---

```
// strings.cpp -- storing strings in an array
#include <iostream>
#include <cstring> // for the strlen() function
int main()
{
    using namespace std;
    const int Size = 15;
    char name1[Size]; // empty array
    char name2[Size] = "C++owboy"; // initialized array
    // NOTE: some implementations may require the static keyword
    // to initialize the array name2

    cout << "Howdy! I'm " << name2;
    cout << "! What's your name?\n";
    cin >> name1;
    cout << "Well, " << name1 << ", your name has ";
    cout << strlen(name1) << " letters and is stored\n";
    cout << "in an array of " << sizeof(name1) << " bytes.\n";
    cout << "Your initial is " << name1[0] << ".\n";
    name2[3] = '\0'; // set to null character
    cout << "Here are the first 3 characters of my name: ";
    cout << name2 << endl;
    return 0;
}
```

---

Here is a sample run of the program in Listing 4.2:

```
Howdy! I'm C++owboy! What's your name?
Basicman
Well, Basicman, your name has 8 letters and is stored
in an array of 15 bytes.
Your initial is B.
Here are the first 3 characters of my name: C++
```

### Program Notes

What can you learn from Listing 4.2? First, note that the `sizeof` operator gives the size of the entire array, 15 bytes, but the `strlen()` function returns the size of the string stored in the array and not the size of the array itself. Also `strlen()` counts just the visible characters and not the null character. Thus, it returns a value of 8, not 9, for the length of `Basicman`. If `cosmic` is a string, the minimum array size for holding that string is `strlen(cosmic) + 1`.

Because `name1` and `name2` are arrays, you can use an index to access individual characters in the array. For example, the program uses `name1[0]` to find the first character in that array. Also the program sets `name2[3]` to the null character. That makes the string end after three characters, even though more characters remain in the array (see Figure 4.3).

```
const int ArSize = 15;
char name2[ArSize] = "C++owboy";
```

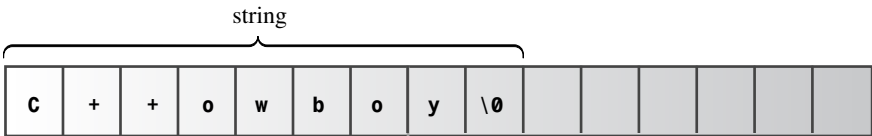

```
name2[3] = '\0';
```

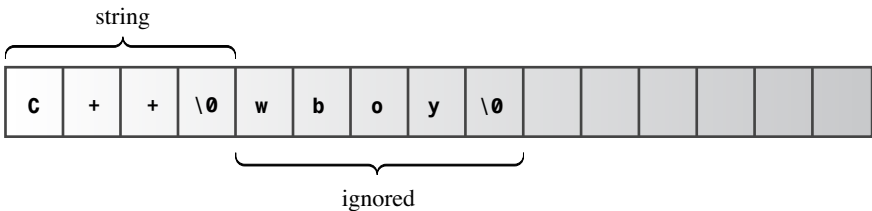

Figure 4.3 Shortening a string with `\0`.

Note that the program in Listing 4.2 uses a symbolic constant for the array size. Often the size of an array appears in several statements in a program. Using a symbolic constant to represent the size of an array simplifies revising the program to use a different array size; you just have to change the value once, where the symbolic constant is defined.

### Adventures in String Input

The `strings.cpp` program has a blemish that is concealed through the often useful technique of carefully selected sample input. Listing 4.3 removes the veils and shows that string input can be tricky.

**Listing 4.3 instr1.cpp**

---

```
// instr1.cpp -- reading more than one string
#include <iostream>
int main()
{
    using namespace std;
    const int ArSize = 20;
    char name[ArSize];
    char dessert[ArSize];

    cout << "Enter your name:\n";
    cin >> name;
    cout << "Enter your favorite dessert:\n";
    cin >> dessert;
    cout << "I have some delicious " << dessert;
    cout << " for you, " << name << ".\n";
    return 0;
}
```

---

The intent of the program in Listing 4.3 is simple: Read a user's name and favorite dessert from the keyboard and then display the information. Here is a sample run:

```
Enter your name:
Alistair Dreeb
Enter your favorite dessert:
I have some delicious Dreeb for you, Alistair.
```

We didn't even get a chance to respond to the dessert prompt! The program showed it and then immediately moved on to display the final line.

The problem lies with how `cin` determines when you've finished entering a string. You can't enter the null character from the keyboard, so `cin` needs some other means for locating the end of a string. The `cin` technique is to use whitespace—spaces, tabs, and newlines—to delineate a string. This means `cin` reads just one word when it gets input for a character array. After it reads this word, `cin` automatically adds the terminating null character when it places the string into the array.

The practical result in this example is that `cin` reads `Alistair` as the entire first string and puts it into the `name` array. This leaves poor `Dreeb` still sitting in the input queue. When `cin` searches the input queue for the response to the favorite dessert question, it finds `Dreeb` still there. Then `cin` gobbles up `Dreeb` and puts it into the `dessert` array (see Figure 4.4).

Another problem, which didn't surface in the sample run, is that the input string might turn out to be longer than the destination array. Using `cin` as this example did offers no protection against placing a 30-character string in a 20-character array.

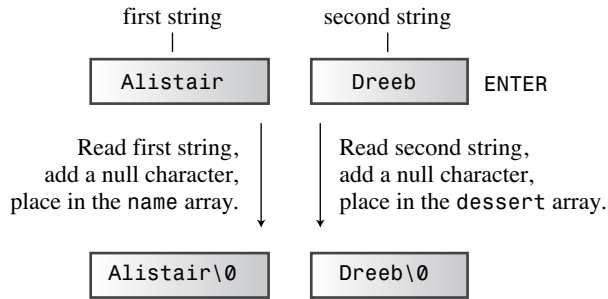

Figure 4.4 The `cin` view of string input.

Many programs depend on string input, so it's worthwhile to explore this topic further. We'll have to draw on some of the more advanced features of `cin`, which are described in Chapter 17, "Input, Output, and Files."

## Reading String Input a Line at a Time

Reading string input a word at a time is often not the most desirable choice. For instance, suppose a program asks the user to enter a city, and the user responds with **New York** or **Sao Paulo**. You would want the program to read and store the full names, not just **New** and **Sao**. To be able to enter whole phrases instead of single words as a string, you need a different approach to string input. Specifically, you need a line-oriented method instead of a word-oriented method. You are in luck, for the `istream` class, of which `cin` is an example, has some line-oriented class member functions: `getline()` and `get()`. Both read an entire input line—that is, up until a newline character. However, `getline()` then discards the newline character, whereas `get()` leaves it in the input queue. Let's look at the details, beginning with `getline()`.

### Line-Oriented Input with `getline()`

The `getline()` function reads a whole line, using the newline character transmitted by the Enter key to mark the end of input. You invoke this method by using `cin.getline()` as a function call. The function takes two arguments. The first argument is the name of the target (that is, the array destined to hold the line of input), and the second argument is a limit on the number of characters to be read. If this limit is, say, 20, the function reads no more than 19 characters, leaving room to automatically add the null character at the end. The `getline()` member function stops reading input when it reaches this numeric limit or when it reads a newline character, whichever comes first.

For example, suppose you want to use `getline()` to read a name into the 20-element name array. You would use this call:

```
cin.getline(name, 20);
```

This reads the entire line into the name array, provided that the line consists of 19 or fewer characters. (The `getline()` member function also has an optional third argument, which Chapter 17 discusses.)

Listing 4.4 modifies Listing 4.3 to use `cin.getline()` instead of a simple `cin`. Otherwise, the program is unchanged.

#### Listing 4.4 `instr2.cpp`

---

```
// instr2.cpp -- reading more than one word with getline
#include <iostream>
int main()
{
    using namespace std;
    const int ArSize = 20;
    char name[ArSize];
    char dessert[ArSize];

    cout << "Enter your name:\n";
    cin.getline(name, ArSize); // reads through newline
    cout << "Enter your favorite dessert:\n";
    cin.getline(dessert, ArSize);
    cout << "I have some delicious " << dessert;
    cout << " for you, " << name << ".\n";
    return 0;
}
```

---

Here is some sample output for Listing 4.4:

```
Enter your name:
Dirk Hammernose
Enter your favorite dessert:
Radish Torte
I have some delicious Radish Torte for you, Dirk Hammernose.
```

The program now reads complete names and delivers the user his just desserts! The `getline()` function conveniently gets a line at a time. It reads input through the newline character marking the end of the line, but it doesn't save the newline character. Instead, it replaces it with a null character when storing the string (see Figure 4.5).

#### Line-Oriented Input with `get()`

Let's try another approach. The `istream` class has another member function, `get()`, which comes in several variations. One variant works much like `getline()`. It takes the same arguments, interprets them the same way, and reads to the end of a line. But rather than read and discard the newline character, `get()` leaves that character in the input queue. Suppose you use two calls to `get()` in a row:

```
cin.get(name, ArSize);
cin.get(dessert, ArSize); // a problem
```

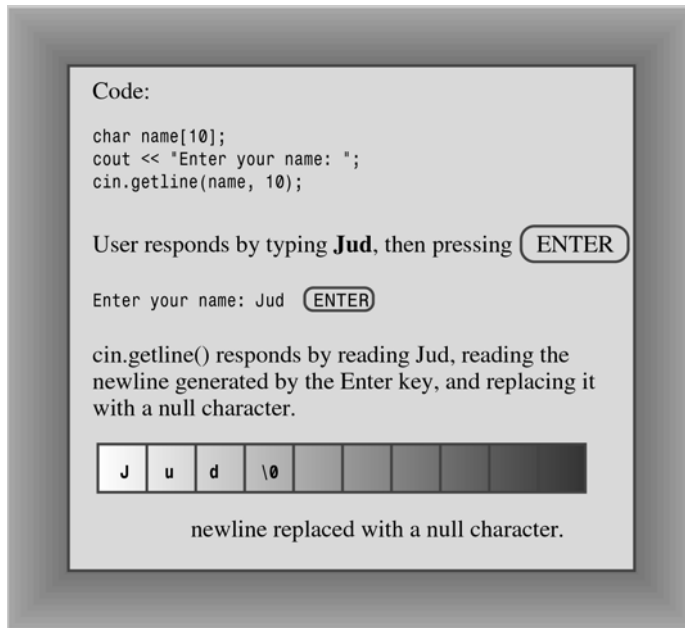

Figure 4.5 `getline()` reads and replaces the newline character.

Because the first call leaves the newline character in the input queue, that newline character is the first character the second call sees. Thus, `get()` concludes that it's reached the end of line without having found anything to read. Without help, `get()` just can't get past that newline character.

Fortunately, there is help in the form of a variation of `get()`. The call `cin.get()` (with no arguments) reads the single next character, even if it is a newline, so you can use it to dispose of the newline character and prepare for the next line of input. That is, this sequence works:

```
cin.get(name, ArSize); // read first line
cin.get();             // read newline
cin.get(dessert, ArSize); // read second line
```

Another way to use `get()` is to *concatenate*, or join, the two class member functions, as follows:

```
cin.get(name, ArSize).get(); // concatenate member functions
```

What makes this possible is that `cin.get(name, ArSize)` returns the `cin` object, which is then used as the object that invokes the `get()` function. Similarly, the following

statement reads two consecutive input lines into the arrays `name1` and `name2`; it's equivalent to making two separate calls to `cin.getline()`:

```
cin.getline(name1, ArSize).getline(name2, ArSize);
```

Listing 4.5 uses concatenation. In Chapter 11, “Working with Classes,” you’ll learn how to incorporate this feature into your class definitions.

#### Listing 4.5 `instr3.cpp`

---

```
// instr3.cpp -- reading more than one word with get() & get()
#include <iostream>
int main()
{
    using namespace std;
    const int ArSize = 20;
    char name[ArSize];
    char dessert[ArSize];

    cout << "Enter your name:\n";
    cin.get(name, ArSize).get(); // read string, newline
    cout << "Enter your favorite dessert:\n";
    cin.get(dessert, ArSize).get();
    cout << "I have some delicious " << dessert;
    cout << " for you, " << name << ".\n";
    return 0;
}
```

---

Here is a sample run of the program in Listing 4.5:

```
Enter your name:
```

```
Mai Parfait
```

```
Enter your favorite dessert:
```

```
Chocolate Mousse
```

```
I have some delicious Chocolate Mousse for you, Mai Parfait.
```

One thing to note is how C++ allows multiple versions of functions, provided that they have different argument lists. If you use, say, `cin.get(name, ArSize)`, the compiler notices you’re using the form that puts a string into an array and sets up the appropriate member function. If, instead, you use `cin.get()`, the compiler realizes you want the form that reads one character. Chapter 8, “Adventures in Functions,” explores this feature, which is called *function overloading*.

Why use `get()` instead of `getline()` at all? First, older implementations may not have `getline()`. Second, `get()` lets you be a bit more careful. Suppose, for example, you used `get()` to read a line into an array. How can you tell if it read the whole line rather than stopped because the array was filled? Look at the next input character. If it is a newline character, then the whole line was read. If it is not a newline character, then there is still



more input on that line. Chapter 17 investigates this technique. In short, `getline()` is a little simpler to use, but `get()` makes error checking simpler. You can use either one to read a line of input; just keep the slightly different behaviors in mind.

### Empty Lines and Other Problems

What happens after `getline()` or `get()` reads an empty line? The original practice was that the next input statement picked up where the last `getline()` or `get()` left off. However, the current practice is that after `get()` (but not `getline()`) reads an empty line, it sets something called the *failbit*. The implications of this act are that further input is blocked, but you can restore input with the following command:

```
cin.clear();
```

Another potential problem is that the input string could be longer than the allocated space. If the input line is longer than the number of characters specified, both `getline()` and `get()` leave the remaining characters in the input queue. However, `getline()` additionally sets the failbit and turns off further input.

Chapters 5, 6, and 17 investigate these properties and how to program around them.

### Mixing String and Numeric Input

Mixing numeric input with line-oriented string input can cause problems. Consider the simple program in Listing 4.6.

Listing 4.6 `numstr.cpp`

---

```
// numstr.cpp -- following number input with line input
#include <iostream>
int main()
{
    using namespace std;
    cout << "What year was your house built?\n";
    int year;
    cin >> year;
    cout << "What is its street address?\n";
    char address[80];
    cin.getline(address, 80);
    cout << "Year built: " << year << endl;
    cout << "Address: " << address << endl;
    cout << "Done!\n";
    return 0;
}
```

---

Running the program in Listing 4.6 would look something like this:

```
What year was your house built?  
1966  
What is its street address?  
Year built: 1966  
Address  
Done!
```

You never get the opportunity to enter the address. The problem is that when `cin` reads the year, it leaves the newline generated by the Enter key in the input queue. Then `cin.getline()` reads the newline as an empty line and assigns a null string to the address array. The fix is to read and discard the newline before reading the address. This can be done several ways, including by using `get()` with a `char` argument or with no argument, as described in the preceding example. You can make these calls separately:

```
cin >> year;  
cin.get(); // or cin.get(ch);
```

Or you can concatenate the calls, making use of the fact that the expression `cin >> year` returns the `cin` object:

```
(cin >> year).get(); // or (cin >> year).get(ch);
```

If you make one of these changes to Listing 4.6, it works properly:

```
What year was your house built?  
1966  
What is its street address?  
43821 Unsigned Short Street  
Year built: 1966  
Address: 43821 Unsigned Short Street  
Done!
```

C++ programs frequently use pointers instead of arrays to handle strings. We'll take up that aspect of strings after talking a bit about pointers. Meanwhile, let's take a look at a more recent way to handle strings: the C++ `string` class.

## Introducing the `string` Class

The ISO/ANSI C++98 Standard expanded the C++ library by adding a `string` class. So now, instead of using a character array to hold a string, you can use a type `string` variable (or object, to use C++ terminology). As you'll see, the `string` class is simpler to use than the array and also provides a truer representation of a string as a type.

To use the `string` class, a program has to include the `string` header file. The `string` class is part of the `std` namespace, so you have to provide a `using` directive or declaration or else refer to the class as `std::string`. The class definition hides the array nature of a string and lets you treat a string much like an ordinary variable. Listing 4.7 illustrates some of the similarities and differences between `string` objects and character arrays.

Listing 4.7 `strtype1.cpp`

---

```

// strtype1.cpp -- using the C++ string class
#include <iostream>
#include <string>           // make string class available
int main()
{
    using namespace std;
    char charr1[20];        // create an empty array
    char charr2[20] = "jaguar"; // create an initialized array
    string str1;           // create an empty string object
    string str2 = "panther"; // create an initialized string

    cout << "Enter a kind of feline: ";
    cin >> charr1;
    cout << "Enter another kind of feline: ";
    cin >> str1;           // use cin for input
    cout << "Here are some felines:\n";
    cout << charr1 << " " << charr2 << " "
         << str1 << " " << str2 // use cout for output
         << endl;
    cout << "The third letter in " << charr2 << " is "
         << charr2[2] << endl;
    cout << "The third letter in " << str2 << " is "
         << str2[2] << endl;    // use array notation

    return 0;
}

```

---

Here is a sample run of the program in Listing 4.7:

```

Enter a kind of feline: ocelot
Enter another kind of feline: tiger
Here are some felines:
ocelot jaguar tiger panther
The third letter in jaguar is g
The third letter in panther is n

```

You should learn from this example that, in many ways, you can use a string object in the same manner as a character array:

- You can initialize a `string` object to a C-style string.
- You can use `cin` to store keyboard input in a `string` object.
- You can use `cout` to display a `string` object.
- You can use array notation to access individual characters stored in a `string` object.

The main difference between `string` objects and character arrays shown in Listing 4.7 is that you declare a `string` object as a simple variable, not as an array:

```
string str1;           // create an empty string object
string str2 = "panther"; // create an initialized string
```

The class design allows the program to handle the sizing automatically. For instance, the declaration for `str1` creates a `string` object of length zero, but the program automatically resizes `str1` when it reads input into `str1`:

```
cin >> str1;           // str1 resized to fit input
```

This makes using a `string` object both more convenient and safer than using an array. Conceptually, one thinks of an array of `char` as a collection of `char` storage units used to store a string but of a `string` class variable as a single entity representing the string.

## C++11 String Initialization

As you might expect by now, C++11 enables list-initialization for C-style strings and `string` objects:

```
char first_date[] = {"Le Chapon Dodu"};
char second_date[] {"The Elegant Plate"};
string third_date = {"The Bread Bowl"};
string fourth_date {"Hank's Fine Eats"};
```

## Assignment, Concatenation, and Appending

The `string` class makes some operations simpler than is the case for arrays. For example, you can't simply assign one array to another. But you can assign one `string` object to another:

```
char charr1[20];           // create an empty array
char charr2[20] = "jaguar"; // create an initialized array
string str1;              // create an empty string object
string str2 = "panther";  // create an initialized string
charr1 = charr2;          // INVALID, no array assignment
str1 = str2;              // VALID, object assignment ok
```

The `string` class simplifies combining strings. You can use the `+` operator to add two `string` objects together and the `+=` operator to tack on a string to the end of an existing `string` object. Continuing with the preceding code, we have the following possibilities:

```
string str3;
str3 = str1 + str2;        // assign str3 the joined strings
str1 += str2;             // add str2 to the end of str1
```

Listing 4.8 illustrates these usages. Note that you can add and append C-style strings as well as `string` objects to a `string` object.

Listing 4.8 `strtype2.cpp`

---

```
// strtype2.cpp -- assigning, adding, and appending
#include <iostream>
#include <string>           // make string class available
int main()
{
    using namespace std;
    string s1 = "penguin";
    string s2, s3;

    cout << "You can assign one string object to another: s2 = s1\n";
    s2 = s1;
    cout << "s1: " << s1 << ", s2: " << s2 << endl;
    cout << "You can assign a C-style string to a string object.\n";
    cout << "s2 = \"buzzard\"\n";
    s2 = "buzzard";
    cout << "s2: " << s2 << endl;
    cout << "You can concatenate strings: s3 = s1 + s2\n";
    s3 = s1 + s2;
    cout << "s3: " << s3 << endl;
    cout << "You can append strings.\n";
    s1 += s2;
    cout <<"s1 += s2 yields s1 = " << s1 << endl;
    s2 += " for a day";
    cout <<"s2 += \" for a day\" yields s2 = " << s2 << endl;

    return 0;
}
```

---

Recall that the escape sequence `\"` represents a double quotation mark that is used as a literal character rather than as marking the limits of a string. Here is the output from the program in Listing 4.8:

```
You can assign one string object to another: s2 = s1
s1: penguin, s2: penguin
You can assign a C-style string to a string object.
s2 = "buzzard"
s2: buzzard
You can concatenate strings: s3 = s1 + s2
s3: penguinbuzzard
You can append strings.
s1 += s2 yields s1 = penguinbuzzard
s2 += " for a day" yields s2 = buzzard for a day
```

## More string Class Operations

Even before the string class was added to C++, programmers needed to do things like assign strings. For C-style strings, they used functions from the C library for these tasks. The `cstring` header file (formerly `string.h`) supports these functions. For example, you can use the `strcpy()` function to copy a string to a character array, and you can use the `strcat()` function to append a string to a character array:

```
strcpy(charr1, charr2); // copy charr2 to charr1
strcat(charr1, charr2); // append contents of charr2 to charr1
```

Listing 4.9 compares techniques used with string objects with techniques used with character arrays.

### Listing 4.9 `strtype3.cpp`

---

```
// strtype3.cpp -- more string class features
#include <iostream>
#include <string>           // make string class available
#include <cstring>        // C-style string library
int main()
{
    using namespace std;
    char charr1[20];
    char charr2[20] = "jaguar";
    string str1;
    string str2 = "panther";

    // assignment for string objects and character arrays
    str1 = str2;           // copy str2 to str1
    strcpy(charr1, charr2); // copy charr2 to charr1

    // appending for string objects and character arrays
    str1 += " paste";     // add paste to end of str1
    strcat(charr1, " juice"); // add juice to end of charr1

    // finding the length of a string object and a C-style string
    int len1 = str1.size(); // obtain length of str1
    int len2 = strlen(charr1); // obtain length of charr1

    cout << "The string " << str1 << " contains "
         << len1 << " characters.\n";
    cout << "The string " << charr1 << " contains "
         << len2 << " characters.\n";

    return 0;
}
```

---

Here is the output:

```
The string panther paste contains 13 characters.
The string jaguar juice contains 12 characters.
```

The syntax for working with string objects tends to be simpler than using the C string functions. This is especially true for more complex operations. For example, the C library equivalent of

```
str3 = str1 + str2;
```

is this:

```
strcpy(charr3, charr1);
strcat(charr3, charr2);
```

Furthermore, with arrays, there is always the danger of the destination array being too small to hold the information, as in this example:

```
char site[10] = "house";
strcat(site, " of pancakes"); // memory problem
```

The `strcat()` function would attempt to copy all 12 characters into the `site` array, thus overrunning adjacent memory. This might cause the program to abort, or the program might continue running but with corrupted data. The `string` class, with its automatic resizing as necessary, avoids this sort of problem. The C library does provide cousins to `strcat()` and `strcpy()`, called `strncat()` and `strncpy()`, that work more safely by taking a third argument to indicate the maximum allowed size of the target array, but using them adds another layer of complexity in writing programs.

Notice the different syntax used to obtain the number of characters in a string:

```
int len1 = str1.size(); // obtain length of str1
int len2 = strlen(charr1); // obtain length of charr1
```

The `strlen()` function is a regular function that takes a C-style string as its argument and that returns the number of characters in the string. The `size()` function basically does the same thing, but the syntax for it is different. Instead of appearing as a function argument, `str1` precedes the function name and is connected to it with a dot. As you saw with the `put()` method in Chapter 3, this syntax indicates that `str1` is an object and that `size()` is a class method. A method is a function that can be invoked only by an object belonging to the same class as the method. In this particular case, `str1` is a `string` object, and `size()` is a `string` method. In short, the C functions use a function argument to identify which string to use, and the C++ `string` class objects use the object name and the dot operator to indicate which string to use.

## More on string Class I/O

As you've seen, you can use `cin` with the `>>` operator to read a `string` object and `cout` with the `<<` operator to display a `string` object using the same syntax you use with a

C-style string. But reading a line at a time instead of a word at a time uses a different syntax. Listing 4.10 shows this difference.

Listing 4.10 **strtype4.cpp**

---

```
// strtype4.cpp -- line input
#include <iostream>
#include <string>           // make string class available
#include <cstring>         // C-style string library
int main()
{
    using namespace std;
    char charr[20];
    string str;

    cout << "Length of string in charr before input: "
         << strlen(charr) << endl;
    cout << "Length of string in str before input: "
         << str.size() << endl;
    cout << "Enter a line of text:\n";
    cin.getline(charr, 20);    // indicate maximum length
    cout << "You entered: " << charr << endl;
    cout << "Enter another line of text:\n";
    getline(cin, str);        // cin now an argument; no length specifier
    cout << "You entered: " << str << endl;
    cout << "Length of string in charr after input: "
         << strlen(charr) << endl;
    cout << "Length of string in str after input: "
         << str.size() << endl;

    return 0;
}
```

---

Here's a sample run of the program in Listing 4.10:

```
Length of string in charr before input: 27
Length of string in str before input: 0
Enter a line of text:
peanut butter
You entered: peanut butter
Enter another line of text:
blueberry jam
You entered: blueberry jam
Length of string in charr after input: 13
Length of string in str after input: 13
```



Note that the program says the length of the string in the array `charr` before input is 27, which is larger than the size of the array! Two things are going on here. The first is that the contents of an uninitialized array are undefined. The second is that the `strlen()` function works by starting at the first element of the array and counting bytes until it reaches a null character. In this case, the first null character doesn't appear until several bytes *after* the end of the array. Where the first null character appears in uninitialized data is essentially random, so you very well could get a different numeric result using this program.

Also note that the length of the string in `str` before input is 0. That's because an uninitialized `string` object is automatically set to zero size.

This is the code for reading a line into an array:

```
cin.getline(charr, 20);
```

The dot notation indicates that the `getline()` function is a class method for the `istream` class. (Recall that `cin` is an `istream` object.) As mentioned earlier, the first argument indicates the destination array, and the second argument is the array size, which `getline()` used to avoid overrunning the array.

This is the code for reading a line into a `string` object:

```
getline(cin, str);
```

There is no dot notation, which indicates that *this* `getline()` is *not* a class method. So it takes `cin` as an argument that tells it where to find the input. Also there isn't an argument for the size of the string because the `string` object automatically resizes to fit the string.

So why is one `getline()` an `istream` class method and the other `getline()` not? The `istream` class was part of C++ long before the `string` class was added. So the `istream` design recognizes basic C++ types such as `double` and `int`, but it is ignorant of the `string` type. Therefore, there are `istream` class methods for processing `double`, `int`, and the other basic types, but there are no `istream` class methods for processing `string` objects.

Because there are no `istream` class methods for processing `string` objects, you might wonder why code like this works:

```
cin >> str; // read a word into the str string object
```

It turns out that code like the following does (in disguised notation) use a member function of the `istream` class:

```
cin >> x; // read a value into a basic C++ type
```

But the `string` class equivalent uses a friend function (also in disguised notation) of the `string` class. You'll have to wait until Chapter 11 to see what a friend function is and how this technique works. In the meantime, you can use `cin` and `cout` with `string` objects and not worry about the inner workings.

## Other Forms of String Literals

C++, recall, has the `wchar_t` type in addition to `char`. And C++11 adds the `char16_t` and `char32_t` types. It's possible to create arrays of these types and string literals of these types. C++ uses the `L`, `u`, and `U` prefixes, respectively, for string literals of these types.

Here's an example of how they can be used:

```
wchar_t title[] = L"Chief Astrogator"; // w_char string
char16_t name[] = u"Felonia Ripova"; // char_16 string
char32_t car[] = U"Humber Super Snipe"; // char_32 string
```

C++11 also supports an encoding scheme for Unicode characters called UTF-8. In this scheme a given character may be stored in anywhere from one 8-bit unit, or octet, to four 8-bit units, depending on the numeric value. C++ uses the `u8` prefix to indicate string literals of that type.

Another C++11 addition is the raw string. In a raw string, characters simply stand for themselves. For example, the sequence `\n` is not interpreted as representing the newline character; instead, it is two ordinary characters, a backslash and an `n`, and it would display as those two characters onscreen. As another example, you can use a simple `"` inside a string instead of the more awkward `\"` we used in Listing 4.8. Of course, if you allow a `"` inside a string literal, you no longer can use it to delimit the ends of a string. Therefore, raw strings use `" ( and )` as delimiters, and they use an `R` prefix to identify them as raw strings:

```
cout << R"(Jim "King" Tutt uses "\n" instead of endl.)" << '\n';
```

This would display the following:

```
Jim "King" Tutt uses \n instead of endl.
```

The standard string literal equivalent would be this:

```
cout << "Jim \"King\" Tutt uses \" \\n\" instead of endl." << '\n';
```

Here we had to use `\\` to display `\` because a single `\` is interpreted as the first character of an escape sequence.

If you press the Enter or Return key while typing a raw string, that not only moves the cursor to the next line onscreen, it also places a carriage return character in the raw string.

What if you want to display the combination `)"` in a raw string? (Who wouldn't?) Won't the compiler interpret the first occurrence of `)"` as the end of the string? Yes, it will. But the raw string syntax allows you to place additional characters between the opening `"` and `.` This implies that the same additional characters must appear between the final `)"` and `.` So a raw string beginning with `R"++ ( must terminate with )++`". Thus, the statement

```
cout << R"++("(Who wouldn't?)", she whispered.)++" << endl;
```

would display the following:

```
"(Who wouldn't?)", she whispered.
```

In short, the default delimiters of " ( and ) " have been replaced with "+\*( and )+\*". You can use any of the members of the basic character set as part of the delimiter other than the space, the left parenthesis, the right parenthesis, the backslash, and control characters such as a tab or a newline.

The `R` prefix can be combined with the other string prefixes to produce raw strings of `wchar_t` and so on. It can be either the first or the last part of a compound prefix: `Ru`, `UR`, and so on.

Now let's go on to another compound type—the structure.

## Introducing Structures

Suppose you want to store information about a basketball player. You might want to store his or her name, salary, height, weight, scoring average, free-throw percentage, assists, and so on. You'd like some sort of data form that could hold all this information in one unit. An array won't do. Although an array can hold several items, each item has to be the same type. That is, one array can hold 20 `ints` and another can hold 10 `floats`, but a single array can't store `ints` in some elements and `floats` in other elements.

The answer to your desire (the one about storing information about a basketball player) is the C++ structure. A *structure* is a more versatile data form than an array because a single structure can hold items of more than one data type. This enables you to unify your data representation by storing all the related basketball information in a single structure variable. If you want to keep track of a whole team, you can use an array of structures. The structure type is also a stepping stone to that bulwark of C++ OOP, the class. Learning a little about structures now takes you that much closer to the OOP heart of C++.

A structure is a user-definable type, with a structure declaration serving to define the type's data properties. After you define the type, you can create variables of that type. Thus, creating a structure is a two-part process. First, you define a structure description that describes and labels the different types of data that can be stored in a structure. Then you can create structure variables, or, more generally, structure data objects, that follow the description's plan.

For example, suppose that Bloataire, Inc., wants to create a type to describe members of its product line of designer inflatables. In particular, the type should hold the name of the item, its volume in cubic feet, and its selling price. Here is a structure description that meets those needs:

```
struct inflatable // structure declaration
{
    char name[20];
    float volume;
    double price;
};
```

The keyword `struct` indicates that the code defines the layout for a structure. The identifier `inflatable` is the name, or *tag*, for this form; this makes `inflatable` the name



the way, the method used to access class member functions such as `cin.getline()` has its origins in the method used to access structure member variables such as `vincent.price`.

## Using a Structure in a Program

Now that we've covered some of the main features of structures, it's time to put the ideas together in a structure-using program. Listing 4.11 illustrates these points about a structure. Also it shows how to initialize one.

Listing 4.11 `structur.cpp`

---

```
// structur.cpp -- a simple structure
#include <iostream>
struct inflatable // structure declaration
{
    char name[20];
    float volume;
    double price;
};

int main()
{
    using namespace std;
    inflatable guest =
    {
        "Glorious Gloria", // name value
        1.88,              // volume value
        29.99              // price value
    }; // guest is a structure variable of type inflatable
// It's initialized to the indicated values
    inflatable pal =
    {
        "Audacious Arthur",
        3.12,
        32.99
    }; // pal is a second variable of type inflatable
// NOTE: some implementations require using
// static inflatable guest =

    cout << "Expand your guest list with " << guest.name;
    cout << " and " << pal.name << "!\n";
// pal.name is the name member of the pal variable
    cout << "You can have both for $";
    cout << guest.price + pal.price << "!\n";
    return 0;
}
```

---

Here is the output from the program in Listing 4.11:

```
Expand your guest list with Glorious Gloria and Audacious Arthur!
You can have both for $62.98!
```

## Program Notes

One important matter related to the program in Listing 4.11 is where to place the structure declaration. There are two choices for `structur.cpp`. You could place the declaration inside the `main()` function, just after the opening brace. The second choice, and the one made here, is to place it outside and preceding `main()`. When a declaration occurs outside any function, it's called an *external declaration*. For this program, there is no practical difference between the two choices. But for programs consisting of two or more functions, the difference can be crucial. The external declaration can be used by all the functions following it, whereas the internal declaration can be used only by the function in which the declaration is found. Most often, you want an external structure declaration so that all the functions can use structures of that type (see Figure 4.7).

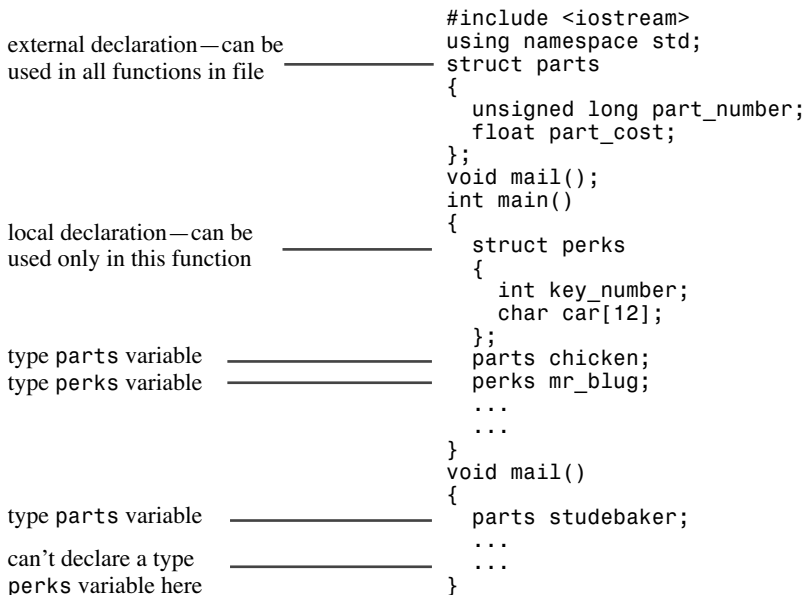

Figure 4.7 Local and external structure declarations.

Variables, too, can be defined internally or externally, with external variables shared among functions. (Chapter 9, “Memory Models and Namespaces,” looks further into that topic.) C++ practices discourage the use of external variables but encourage the use of

external structure declarations. Also it often makes sense to declare symbolic constants externally.

Next, notice the initialization procedure:

```
inflatable guest =
{
    "Glorious Gloria", // name value
    1.88,              // volume value
    29.99             // price value
};
```

As with arrays, you use a comma-separated list of values enclosed in a pair of braces. The program places one value per line, but you can place them all on the same line. Just remember to separate items with commas:

```
inflatable duck = {"Daphne", 0.12, 9.98};
```

You can initialize each member of the structure to the appropriate kind of data. For example, the name member is a character array, so you can initialize it to a string.

Each structure member is treated as a variable of that type. Thus, `pal.price` is a double variable, and `pal.name` is an array of `char`. And when the program uses `cout` to display `pal.name`, it displays the member as a string. By the way, because `pal.name` is a character array, we can use subscripts to access individual characters in the array. For example, `pal.name[0]` is the character A. But `pal[0]` is meaningless because `pal` is a structure, not an array.

## C++11 Structure Initialization

As with arrays, C++11 extends the features of list-initialization. The `=` sign is optional:

```
inflatable duck {"Daphne", 0.12, 9.98}; // can omit the = in C++11
```

Next, empty braces result in the individual members being set to 0. For example, the following declaration results in `mayor.volume` and `mayor.price` being set to 0 and all the bytes in `mayor.name` being set to 0:

```
inflatable mayor {};
```

Finally, narrowing is not allowed.

## Can a Structure Use a `string` Class Member?

Can you use a `string` class object instead of a character array for the name member? That is, can you declare a structure like this:

```
#include <string>
struct inflatable // structure definition
{
    std::string name;
    float volume;
    double price;
};
```

The answer is yes unless you are using an obsolete compiler that does not support initialization of structures with `string` class members.

Make sure that the structure definition has access to the `std` namespace. You can do this by moving the `using` directive so that it is above the structure definition. The better choice, as shown previously, is to declare `name` as having type `std::string`.

## Other Structure Properties

C++ makes user-defined types as similar as possible to built-in types. For example, you can pass structures as arguments to a function, and you can have a function use a structure as a return value. Also you can use the assignment operator (`=`) to assign one structure to another of the same type. Doing so causes each member of one structure to be set to the value of the corresponding member in the other structure, even if the member is an array. This kind of assignment is called *memberwise assignment*. We'll defer passing and returning structures until we discuss functions in Chapter 7, "Functions: C++'s Programming Modules," but we can take a quick look at structure assignment now. Listing 4.12 provides an example.

### Listing 4.12 `assgn_st.cpp`

---

```
// assgn_st.cpp -- assigning structures
#include <iostream>
struct inflatable
{
    char name[20];
    float volume;
    double price;
};
int main()
{
    using namespace std;
    inflatable bouquet =
    {
        "sunflowers",
        0.20,
        12.49
    };
    inflatable choice;
    cout << "bouquet: " << bouquet.name << " for $";
    cout << bouquet.price << endl;

    choice = bouquet; // assign one structure to another
    cout << "choice: " << choice.name << " for $";
    cout << choice.price << endl;
    return 0;
}
```

---



Here's the output from the program in Listing 4.12:

```
bouquet: sunflowers for $12.49
choice: sunflowers for $12.49
```

As you can see, memberwise assignment is at work, for the members of the `choice` structure are assigned the same values stored in the `bouquet` structure.

You can combine the definition of a structure form with the creation of structure variables. To do so, you follow the closing brace with the variable name or names:

```
struct perks
{
    int key_number;
    char car[12];
} mr_smith, ms_jones; // two perks variables
```

You even can initialize a variable you create in this fashion:

```
struct perks
{
    int key_number;
    char car[12];
} mr_glitz =
{
    7, // value for mr_glitz.key_number member
    "Packard" // value for mr_glitz.car member
};
```

However, keeping the structure definition separate from the variable declarations usually makes a program easier to read and follow.

Another thing you can do with structures is create a structure with no type name. You do this by omitting a tag name while simultaneously defining a structure form and a variable:

```
struct // no tag
{
    int x; // 2 members
    int y;
} position; // a structure variable
```

This creates one structure variable called `position`. You can access its members with the membership operator, as in `position.x`, but there is no general name for the type. You can't subsequently create other variables of the same type. This book doesn't use that limited form of structure.

Aside from the fact that a C++ program can use the structure tag as a type name, C structures have all the features discussed so far for C++ structures, apart from the C++11 changes. But C++ structures go further. Unlike C structures, for example, C++ structures can have member functions in addition to member variables. But these more advanced features most typically are used with classes rather than structures, so we'll discuss them when we cover classes, beginning with Chapter 10, "Objects and Classes."

## Arrays of Structures

The `inflatable` structure contains an array (the name `array`). It's also possible to create arrays whose elements are structures. The technique is exactly the same as for creating arrays of the fundamental types. For example, to create an array of 100 `inflatable` structures, you could do the following:

```
inflatable gifts[100]; // array of 100 inflatable structures
```

This makes `gifts` an array of `inflatables`. Hence each element of the array, such as `gifts[0]` or `gifts[99]`, is an `inflatable` object and can be used with the membership operator:

```
cin >> gifts[0].volume; // use volume member of first struct
cout << gifts[99].price << endl; // display price member of last struct
```

Keep in mind that `gifts` itself is an array, not a structure, so constructions such as `gifts.price` are not valid.

To initialize an array of structures, you combine the rule for initializing arrays (a brace-enclosed, comma-separated list of values for each element) with the rule for structures (a brace-enclosed, comma-separated list of values for each member). Because each element of the array is a structure, its value is represented by a structure initialization. Thus, you wind up with a brace-enclosed, comma-separated list of values, each of which itself is a brace-enclosed, comma-separated list of values:

```
inflatable guests[2] = // initializing an array of structs
{
    {"Bambi", 0.5, 21.99}, // first structure in array
    {"Godzilla", 2000, 565.99} // next structure in array
};
```

As usual, you can format this the way you like. For example, both initializations can be on the same line, or each separate structure member initialization can get a line of its own.

Listing 4.13 shows a short example that uses an array of structures. Note that because `guests` is an array of `inflatable`, `guest[0]` is type `inflatable`, so you can use it with the dot operator to access a member of the `inflatable` structure.

### Listing 4.13 `arrstruc.cpp`

---

```
// arrstruc.cpp -- an array of structures
#include <iostream>
struct inflatable
{
    char name[20];
    float volume;
    double price;
};
int main()
{
```

```

using namespace std;
inflatable guests[2] =           // initializing an array of structs
{
    {"Bambi", 0.5, 21.99},        // first structure in array
    {"Godzilla", 2000, 565.99}   // next structure in array
};

cout << "The guests " << guests[0].name << " and " << guests[1].name
    << "\nhave a combined volume of "
    << guests[0].volume + guests[1].volume << " cubic feet.\n";
return 0;
}

```

---

Here is the output of the program in Listing 4.13:

```

The guests Bambi and Godzilla
have a combined volume of 2000.5 cubic feet.

```

## Bit Fields in Structures

C++, like C, enables you to specify structure members that occupy a particular number of bits. This can be handy for creating a data structure that corresponds, say, to a register on some hardware device. The field type should be an integral or enumeration type (enumerations are discussed later in this chapter), and a colon followed by a number indicates the actual number of bits to be used. You can use unnamed fields to provide spacing. Each member is termed a *bit field*. Here's an example:

```

struct toggle_register
{
    unsigned int SN : 4;    // 4 bits for SN value
    unsigned int : 4;      // 4 bits unused
    bool goodIn : 1;       // valid input (1 bit)
    bool goodToggle : 1;   // successful toggling
};

```

You can initialize the fields in the usual manner, and you use standard structure notation to access bit fields:

```

toggle_register tr = { 14, true, false };
...
if (tr.goodIn)    // if statement covered in Chapter 6
...

```

Bit fields are typically used in low-level programming. Often, using an integral type and the bitwise operators listed in Appendix E, “Other Operators,” provides an alternative approach.

## Unions

A *union* is a data format that can hold different data types but only one type at a time. That is, whereas a structure can hold, say, an *int* *and* a *long* *and* a *double*, a union can hold an *int* *or* a *long* *or* a *double*. The syntax is like that for a structure, but the meaning is different. For example, consider the following declaration:

```
union one4all
{
    int int_val;
    long long_val;
    double double_val;
};
```

You can use a `one4all` variable to hold an `int`, a `long`, or a `double`, just as long as you do so at different times:

```
one4all pail;
pail.int_val = 15;           // store an int
cout << pail.int_val;
pail.double_val = 1.38;    // store a double, int value is lost
cout << pail.double_val;
```

Thus, `pail` can serve as an `int` variable on one occasion and as a `double` variable at another time. The member name identifies the capacity in which the variable is acting. Because a union holds only one value at a time, it has to have space enough to hold its largest member. Hence, the size of the union is the size of its largest member.

One use for a union is to save space when a data item can use two or more formats but never simultaneously. For example, suppose you manage a mixed inventory of widgets, some of which have an integer ID, and some of which have a string ID. In that case, you could use the following:

```
struct widget
{
    char brand[20];
    int type;
    union id           // format depends on widget type
    {
        long id_num;    // type 1 widgets
        char id_char[20]; // other widgets
    } id_val;
};
...
widget prize;
...
if (prize.type == 1)           // if-else statement (Chapter 6)
    cin >> prize.id_val.id_num; // use member name to indicate mode
else
    cin >> prize.id_val.id_char;
```

An *anonymous union* has no name; in essence, its members become variables that share the same address. Naturally, only one member can be current at a time:

```
struct widget
{
    char brand[20];
    int type;
    union                // anonymous union
    {
        long id_num;    // type 1 widgets
        char id_char[20]; // other widgets
    };
};
...
widget prize;
...
if (prize.type == 1)
    cin >> prize.id_num;
else
    cin >> prize.id_char;
```

Because the union is anonymous, `id_num` and `id_char` are treated as two members of `prize` that share the same address. The need for an intermediate identifier `id_val` is eliminated. It is up to the programmer to keep track of which choice is active.

Unions often (but not exclusively) are used to save memory space. That may not seem that necessary in these days of gigabytes of RAM and terabytes of storage, but not all C++ programs are written for such systems. C++ also is used for embedded systems, such as the processors used to control a toaster oven, an MP3 player, or a Mars rover. In these applications space may be at a premium. Also unions often are used when working with operating systems or hardware data structures.

## Enumerations

The C++ `enum` facility provides an alternative to `const` for creating symbolic constants. It also lets you define new types but in a fairly restricted fashion. The syntax for `enum` resembles structure syntax. For example, consider the following statement:

```
enum spectrum {red, orange, yellow, green, blue, violet, indigo, ultraviolet};
```

This statement does two things:

- It makes `spectrum` the name of a new type; `spectrum` is termed an *enumeration*, much as a `struct` variable is called a structure.
- It establishes `red`, `orange`, `yellow`, and so on, as symbolic constants for the integer values 0–7. These constants are called *enumerators*.

By default, enumerators are assigned integer values starting with 0 for the first enumerator, 1 for the second enumerator, and so forth. You can override the default by explicitly assigning integer values. You'll see how later in this chapter.

You can use an enumeration name to declare a variable of the enumeration type:

```
spectrum band; // band a variable of type spectrum
```

An enumeration variable has some special properties, which we'll examine now.

The only valid values that you can assign to an enumeration variable without a type cast are the enumerator values used in defining the type. Thus, we have the following:

```
band = blue;           // valid, blue is an enumerator
band = 2000;          // invalid, 2000 not an enumerator
```

Thus, a `spectrum` variable is limited to just eight possible values. Some compilers issue a compiler error if you attempt to assign an invalid value, whereas others issue a warning. For maximum portability, you should regard assigning a non-enum value to an enum variable as an error.

Only the assignment operator is defined for enumerations. In particular, arithmetic operations are not defined:

```
band = orange;        // valid
++band;               // not valid, ++ discussed in Chapter 6
band = orange + red;  // not valid, but a little tricky
...
```

However, some implementations do not honor this restriction. That can make it possible to violate the type limits. For example, if `band` has the value `ultraviolet`, or 7, then `++band`, if valid, increments `band` to 8, which is not a valid value for a `spectrum` type. Again, for maximum portability, you should adopt the stricter limitations.

Enumerators are of integer type and can be promoted to type `int`, but `int` types are not converted automatically to the enumeration type:

```
int color = blue;     // valid, spectrum type promoted to int
band = 3;             // invalid, int not converted to spectrum
color = 3 + red;      // valid, red converted to int
...
```

Note that in this example, even though 3 corresponds to the enumerator `green`, assigning 3 to `band` is a type error. But assigning `green` to `band` is fine because they are both type `spectrum`. Again, some implementations do not enforce this restriction. In the expression `3 + red`, addition isn't defined for enumerations. However, `red` is converted to type `int`, and the result is type `int`. Because of the conversion from enumeration to `int` in this situation, you can use enumerations in arithmetic expressions to combine them with ordinary integers, even though arithmetic isn't defined for enumerations themselves.

The earlier example

```
band = orange + red; // not valid, but a little tricky
```

fails for a somewhat involved reason. It is true that the `+` operator is not defined for enumerators. But it is also true that enumerators are converted to integers when used in arithmetic expressions, so the expression `orange + red` gets converted to `1 + 0`, which is a valid expression. But it is of type `int` and hence cannot be assigned to the type `spectrum` variable `band`.

You can assign an `int` value to an `enum`, provided that the value is valid and that you use an explicit type cast:

```
band = spectrum(3);           // typecast 3 to type spectrum
```

What if you try to type cast an inappropriate value? The result is undefined, meaning that the attempt won't be flagged as an error but that you can't rely on the value of the result:

```
band = spectrum(40003);     // undefined
```

(See the section “Value Ranges for Enumerations,” later in this chapter for a discussion of what values are and are not appropriate.)

As you can see, the rules governing enumerations are fairly restrictive. In practice, enumerations are used more often as a way of defining related symbolic constants than as a means of defining new types. For example, you might use an enumeration to define symbolic constants for a `switch` statement. (See Chapter 6, “Branching Statements and Logical Operators,” for an example.) If you plan to use just the constants and not create variables of the enumeration type, you can omit an enumeration type name, as in this example:

```
enum {red, orange, yellow, green, blue, violet, indigo, ultraviolet};
```

## Setting Enumerator Values

You can set enumerator values explicitly by using the assignment operator:

```
enum bits{one = 1, two = 2, four = 4, eight = 8};
```

The assigned values must be integers. You also can define just some of the enumerators explicitly:

```
enum bigstep{first, second = 100, third};
```

In this case, `first` is 0 by default. Subsequent uninitialized enumerators are larger by one than their predecessors. So, `third` would have the value 101.

Finally, you can create more than one enumerator with the same value:

```
enum {zero, null = 0, one, numero_uno = 1};
```

Here, both `zero` and `null` are 0, and both `one` and `numero_uno` are 1. In earlier versions of C++, you could assign only `int` values (or values that promote to `int`) to enumerators, but that restriction has been removed so that you can use type `long` or even `long long` values.

## Value Ranges for Enumerations

Originally, the only valid values for an enumeration were those named in the declaration. However, C++ has expanded the list of valid values that can be assigned to an enumeration variable through the use of a type cast. Each enumeration has a *range*, and you can assign any integer value in the range, even if it's not an enumerator value, by using a type cast to an enumeration variable. For example, suppose that `bits` and `myflag` are defined this way:

```
enum bits{one = 1, two = 2, four = 4, eight = 8};
bits myflag;
```

In this case, the following is valid:

```
myflag = bits(6);    // valid, because 6 is in bits range
```

Here `6` is not one of the enumerations, but it lies in the range the enumerations define.

The range is defined as follows. First, to find the upper limit, you take the largest enumerator value. Then you find the smallest power of two greater than this largest value and subtract one; the result is the upper end of the range. (For example, the largest `bigstep` value, as previously defined, is 101. The smallest power of two greater than this is 128, so the upper end of the range is 127.) Next, to find the lower limit, you find the smallest enumerator value. If it is 0 or greater, the lower limit for the range is 0. If the smallest enumerator is negative, you use the same approach as for finding the upper limit but toss in a minus sign. (For example, if the smallest enumerator is `-6`, the next power of two [times a minus sign] is `-8`, and the lower limit is `-7`.)

The idea is that the compiler can choose how much space to use to hold an enumeration. It might use 1 byte or less for an enumeration with a small range and 4 bytes for an enumeration with type `long` values.

C++11 extends enumerations with a form called the *scoped enumeration*. Chapter 10 discusses this form briefly in the section “Class Scope.”

## Pointers and the Free Store

The beginning of Chapter 3 mentions three fundamental properties of which a computer program must keep track when it stores data. To save the book the wear and tear of your thumbing back to that chapter, here are those properties again:

- Where the information is stored
- What value is kept there
- What kind of information is stored

You've used one strategy for accomplishing these ends: defining a simple variable. The declaration statement provides the type and a symbolic name for the value. It also causes the program to allocate memory for the value and to keep track of the location internally.



Let's look at a second strategy now, one that becomes particularly important in developing C++ classes. This strategy is based on pointers, which are variables that store addresses of values rather than the values themselves. But before discussing pointers, let's talk about how to explicitly find addresses for ordinary variables. You just apply the address operator, represented by `&`, to a variable to get its location; for example, if `home` is a variable, `&home` is its address. Listing 4.14 demonstrates this operator.

Listing 4.14 `address.cpp`

---

```
// address.cpp -- using the & operator to find addresses
#include <iostream>
int main()
{
    using namespace std;
    int donuts = 6;
    double cups = 4.5;

    cout << "donuts value = " << donuts;
    cout << " and donuts address = " << &donuts << endl;
// NOTE: you may need to use unsigned (&donuts)
// and unsigned (&cups)
    cout << "cups value = " << cups;
    cout << " and cups address = " << &cups << endl;
    return 0;
}
```

---

Here is the output from the program in Listing 4.14 on one system:

```
donuts value = 6 and donuts address = 0x0065fd40
cups value = 4.5 and cups address = 0x0065fd44
```

The particular implementation of `cout` shown here uses hexadecimal notation when displaying address values because that is the usual notation used to specify a memory address. (Some implementations use base 10 notation instead.) Our implementation stores `donuts` at a lower memory location than `cups`. The difference between the two addresses is `0x0065fd44 - 0x0065fd40`, or 4. This makes sense because `donuts` is type `int`, which uses 4 bytes. Different systems, of course, will give different values for the address. Also some may store `cups` first, then `donuts`, giving a difference of 8 bytes because `cups` is `double`. And some may not even use adjacent locations.

Using ordinary variables, then, treats the value as a named quantity and the location as a derived quantity. Now let's look at the pointer strategy, one that is essential to the C++ programming philosophy of memory management. (See the following sidebar, "Pointers and the C++ Philosophy.")

## Pointers and the C++ Philosophy

Object-oriented programming differs from traditional procedural programming in that OOP emphasizes making decisions during runtime instead of during compile time. *Runtime* means while a program is running, and *compile time* means when the compiler is putting a program together. A runtime decision is like, when on vacation, choosing what sights to see depending on the weather and your mood at the moment, whereas a compile-time decision is more like adhering to a preset schedule, regardless of the conditions.

Runtime decisions provide the flexibility to adjust to current circumstances. For example, consider allocating memory for an array. The traditional way is to declare an array. To declare an array in C++, you have to commit yourself to a particular array size. Thus, the array size is set when the program is compiled; it is a compile-time decision. Perhaps you think an array of 20 elements is sufficient 80% of the time but that occasionally the program will need to handle 200 elements. To be safe, you use an array with 200 elements. This results in your program wasting memory most of the time it's used. OOP tries to make a program more flexible by delaying such decisions until runtime. That way, after the program is running, you can tell it you need only 20 elements one time or that you need 205 elements another time.

In short, with OOP you would like to make the array size a runtime decision. To make this approach possible, the language has to allow you to create an array—or the equivalent—while the program runs. The C++ method, as you soon see, involves using the keyword `new` to request the correct amount of memory and using pointers to keep track of where the newly allocated memory is found.

Making runtime decisions is not unique to OOP. But C++ makes writing the code a bit more straightforward than does C.

The new strategy for handling stored data switches things around by treating the location as the named quantity and the value as a derived quantity. A special type of variable—the *pointer*—holds the address of a value. Thus, the name of the pointer represents the location. Applying the `*` operator, called the *indirect value* or the *dereferencing* operator, yields the value at the location. (Yes, this is the same `*` symbol used for multiplication; C++ uses the context to determine whether you mean multiplication or dereferencing.) Suppose, for example, that `manly` is a pointer. In that case, `manly` represents an address, and `*manly` represents the value at that address. The combination `*manly` becomes equivalent to an ordinary type `int` variable. Listing 4.15 demonstrates these ideas. It also shows how to declare a pointer.

### Listing 4.15 `pointer.cpp`

```
// pointer.cpp -- our first pointer variable
#include <iostream>
int main()
{
    using namespace std;
    int updates = 6;           // declare a variable
    int * p_updates;          // declare pointer to an int
```

```

    p_updates = &updates; // assign address of int to pointer

// express values two ways
    cout << "Values: updates = " << updates;
    cout << ", *p_updates = " << *p_updates << endl;

// express address two ways
    cout << "Addresses: &updates = " << &updates;
    cout << ", p_updates = " << p_updates << endl;

// use pointer to change value
    *p_updates = *p_updates + 1;
    cout << "Now updates = " << updates << endl;
    return 0;
}

```

Here is the output from the program in Listing 4.15:

```

Values: updates = 6, *p_updates = 6
Addresses: &updates = 0x0065fd48, p_updates = 0x0065fd48
Now updates = 7

```

As you can see, the `int` variable `updates` and the pointer variable `p_updates` are just two sides of the same coin. The `updates` variable represents the value as primary and uses the `&` operator to get the address, whereas the `p_updates` variable represents the address as primary and uses the `*` operator to get the value (see Figure 4.8). Because `p_updates` points to `updates`, `*p_updates` and `updates` are completely equivalent. You can use `*p_updates` exactly as you would use a type `int` variable. As the program in Listing 4.15 shows, you can even assign values to `*p_updates`. Doing so changes the value of the pointed-to value, `updates`.

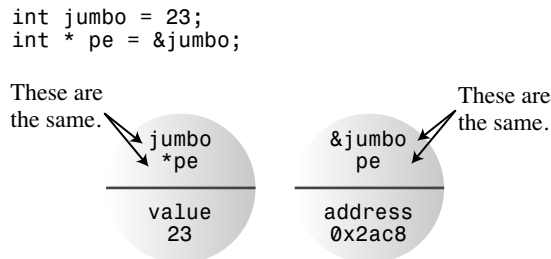

Figure 4.8 Two sides of a coin.

## Declaring and Initializing Pointers

Let's examine the process of declaring pointers. A computer needs to keep track of the type of value to which a pointer refers. For example, the address of a `char` typically looks the same as the address of a `double`, but `char` and `double` use different numbers of bytes and different internal formats for storing values. Therefore, a pointer declaration must specify what type of data to which the pointer points.

For example, the preceding example has this declaration:

```
int * p_updates;
```

This states that the combination `* p_updates` is type `int`. Because you use the `*` operator by applying it to a pointer, the `p_updates` variable itself must *be* a pointer. We say that `p_updates` points to type `int`. We also say that the type for `p_updates` is pointer-to-`int` or, more concisely, `int *`. To repeat: `p_updates` is a pointer (an address), and `*p_updates` is an `int` and not a pointer (see Figure 4.9).

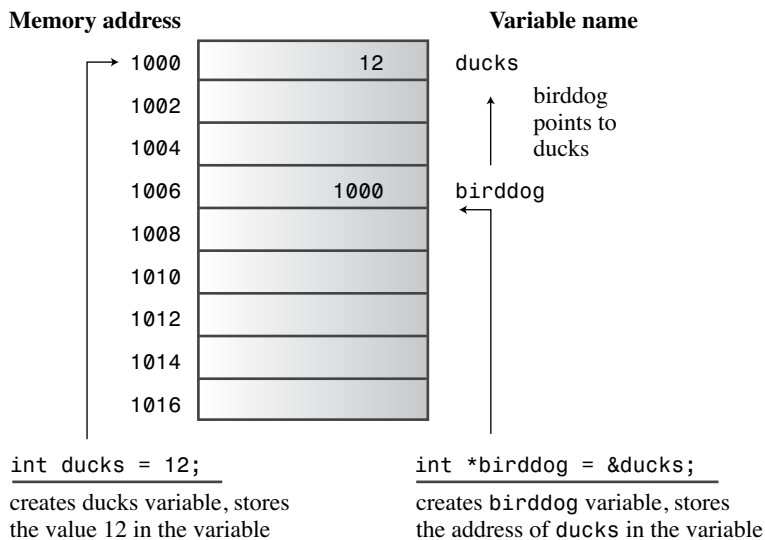

Figure 4.9 Pointers store addresses.

Incidentally, the use of spaces around the `*` operator are optional. Traditionally, C programmers have used this form:

```
int *ptr;
```

This accentuates the idea that the combination `*ptr` is a type `int` value. Many C++ programmers, on the other hand, use this form:

```
int* ptr;
```

This emphasizes the idea that `int*` is a type, pointer-to-`int`. Where you put the spaces makes no difference to the compiler. You could even do this:

```
int*ptr;
```

Be aware, however, that the following declaration creates one pointer (`p1`) and one ordinary `int` (`p2`):

```
int* p1, p2;
```

You need an `*` for each pointer variable name.

### Note

In C++, the combination `int *` is a compound type, pointer-to-`int`.

You use the same syntax to declare pointers to other types:

```
double * tax_ptr; // tax_ptr points to type double
char * str;      // str points to type char
```

Because you declare `tax_ptr` as a pointer-to-`double`, the compiler knows that `*tax_ptr` is a type `double` value. That is, it knows that `*tax_ptr` represents a number stored in floating-point format that occupies (on most systems) 8 bytes. A pointer variable is never simply a pointer. It is always a pointer to a specific type. `tax_ptr` is type pointer-to-`double` (or type `double *`), and `str` is type pointer-to-`char` (or `char *`). Although both are pointers, they are pointers of two different types. Like arrays, pointers are based on other types.

Note that whereas `tax_ptr` and `str` point to data types of two different sizes, the two variables `tax_ptr` and `str` themselves are typically the same size. That is, the address of a `char` is the same size as the address of a `double`, much as 1016 might be the street address for a department store, whereas 1024 could be the street address of a small cottage. The size or value of an address doesn't really tell you anything about the size or kind of variable or building you find at that address. Usually, addresses require 2 or 4 bytes, depending on the computer system. (Some systems might have larger addresses, and a system can use different address sizes for different types.)

You can use a declaration statement to initialize a pointer. In that case, the pointer, not the pointed-to value, is initialized. That is, the following statements set `pt` and not `*pt` to the value `&higgins`:

```
int higgins = 5;
int * pt = &higgins;
```

Listing 4.16 demonstrates how to initialize a pointer to an address.

#### Listing 4.16 `init_ptr.cpp`

---

```
// init_ptr.cpp -- initialize a pointer
#include <iostream>
int main()
{
```

```
using namespace std;
int higgins = 5;
int * pt = &higgins;

cout << "Value of higgins = " << higgins
     << "; Address of higgins = " << &higgins << endl;
cout << "Value of *pt = " << *pt
     << "; Value of pt = " << pt << endl;
return 0;
}
```

---

Here is some sample output from the program in Listing 4.16:

```
Value of higgins = 5; Address of higgins = 0012FED4
Value of *pt = 5; Value of pt = 0012FED4
```

You can see that the program initializes `pt`, not `*pt`, to the address of `higgins`. (Your system most likely will show different values for the addresses and may display them in a different format.)

## Pointer Danger

Danger awaits those who incautiously use pointers. One extremely important point is that when you create a pointer in C++, the computer allocates memory to hold an address, but it does not allocate memory to hold the data to which the address points. Creating space for the data involves a separate step. Omitting that step, as in the following, is an invitation to disaster:

```
long * fellow;           // create a pointer-to-long
*fellow = 223323;       // place a value in never-never land
```

Sure, `fellow` is a pointer. But where does it point? The code failed to assign an address to `fellow`. So where is the value 223323 placed? We can't say. Because `fellow` wasn't initialized, it could have any value. Whatever that value is, the program interprets it as the address at which to store 223323. If `fellow` happens to have the value 1200, then the computer attempts to place the data at address 1200, even if that happens to be an address in the middle of your program code. Chances are that wherever `fellow` points, that is not where you want to put the number 223323. This kind of error can produce some of the most insidious and hard-to-trace bugs.

### Caution

**Pointer Golden Rule:** *Always initialize a pointer to a definite and appropriate address before you apply the dereferencing operator (\*) to it.*

## Pointers and Numbers

Pointers are not integer types, even though computers typically handle addresses as integers. Conceptually, pointers are distinct types from integers. Integers are numbers you can add, subtract, divide, and so on. But a pointer describes a location, and it doesn't make sense, for example, to multiply two locations by each other. In terms of the operations you can perform with them, pointers and integers are different from each other. Consequently, you can't simply assign an integer to a pointer:

```
int * pt;
pt = 0xB8000000; // type mismatch
```

Here, the left side is a pointer to `int`, so you can assign it an address, but the right side is just an integer. You might know that `0xB8000000` is the combined segment–offset address of video memory on your aging computer system, but nothing in the statement tells the program that this number is an address. C prior to C99 lets you make assignments like this. But C++ more stringently enforces type agreement, and the compiler will give you an error message saying you have a type mismatch. If you want to use a numeric value as an address, you should use a type cast to convert the number to the appropriate address type:

```
int * pt;
pt = (int *) 0xB8000000; // types now match
```

Now both sides of the assignment statement represent addresses of integers, so the assignment is valid. Note that just because it is the address of a type `int` value doesn't mean that `pt` itself is type `int`. For example, one might have a platform for which type `int` is a 2-byte value and the addresses are 4-byte values.

Pointers have some other interesting properties that we'll discuss as they become relevant. Meanwhile, let's look at how pointers can be used to manage runtime allocation of memory space.

## Allocating Memory with `new`

Now that you have a feel for how pointers work, let's see how they can implement the important technique of allocating memory as a program runs. So far, you've initialized pointers to the addresses of variables; the variables are *named* memory allocated during compile time, and each pointer merely provides an alias for memory you could access directly by name anyway. The true worth of pointers comes into play when you allocate *unnamed* memory during runtime to hold values. In this case, pointers become the only access to that memory. In C, you can allocate memory with the library function `malloc()`. You can still do so in C++, but C++ also has a better way: the `new` operator.

Let's try out this new technique by creating unnamed runtime storage for a type `int` value and accessing the value with a pointer. The key is the C++ `new` operator. You tell `new` for what data type you want memory; `new` finds a block of the correct size and

returns the address of the block. You assign this address to a pointer, and you're in business. Here's an example of the technique:

```
int * pn = new int;
```

The `new int` part tells the program you want some new storage suitable for holding an `int`. The `new` operator uses the type to figure out how many bytes are needed. Then it finds the memory and returns the address. Next, you assign the address to `pn`, which is declared to be of type `pointer-to-int`. Now `pn` is the address and `*pn` is the value stored there. Compare this with assigning the address of a variable to a pointer:

```
int higgins;
int * pt = &higgins;
```

In both cases (`pn` and `pt`), you assign the address of an `int` to a pointer. In the second case, you can also access the `int` by name: `higgins`. In the first case, your only access is via the pointer. That raises a question: Because the memory to which `pn` points lacks a name, what do you call it? We say that `pn` points to a *data object*. This is not “object” in the sense of “object-oriented programming”; it's just “object” in the sense of “thing.” The term “data object” is more general than the term “variable” because it means any block of memory allocated for a data item. Thus, a variable is also a data object, but the memory to which `pn` points is not a variable. The pointer method for handling data objects may seem more awkward at first, but it offers greater control over how your program manages memory.

The general form for obtaining and assigning memory for a single data object, which can be a structure as well as a fundamental type, is this:

```
typeName * pointer_name = new typeName;
```

You use the data type twice: once to specify the kind of memory requested and once to declare a suitable pointer. Of course, if you've already declared a pointer of the correct type, you can use it rather than declare a new one. Listing 4.17 illustrates using `new` with two different types.

#### Listing 4.17 `use_new.cpp`

---

```
// use_new.cpp -- using the new operator
#include <iostream>
int main()
{
    using namespace std;
    int nights = 1001;
    int * pt = new int;           // allocate space for an int
    *pt = 1001;                  // store a value there

    cout << "nights value = ";
    cout << nights << ": location " << &nights << endl;
    cout << "int ";
    cout << "value = " << *pt << ": location = " << pt << endl;
```



```

double * pd = new double; // allocate space for a double
*pd = 10000001.0;        // store a double there

cout << "double ";
cout << "value = " << *pd << ": location = " << pd << endl;
cout << "location of pointer pd: " << &pd << endl;
cout << "size of pt = " << sizeof(pt);
cout << ": size of *pt = " << sizeof(*pt) << endl;
cout << "size of pd = " << sizeof pd;
cout << ": size of *pd = " << sizeof(*pd) << endl;
return 0;
}

```

---

Here is the output from the program in Listing 4.17:

```

nights value = 1001: location 0028F7F8
int value = 1001: location = 00033A98
double value = 1e+007: location = 000339B8
location of pointer pd: 0028F7FC
size of pt = 4: size of *pt = 4
size of pd = 4: size of *pd = 8

```

Of course, the exact values for the memory locations differ from system to system.

### Program Notes

The program in Listing 4.17 uses `new` to allocate memory for the type `int` and type `double` data objects. This occurs while the program is running. The pointers `pt` and `pd` point to these two data objects. Without them, you cannot access those memory locations. With them, you can use `*pt` and `*pd` just as you would use variables. You assign values to `*pt` and `*pd` to assign values to the new data objects. Similarly, you print `*pt` and `*pd` to display those values.

The program in Listing 4.17 also demonstrates one of the reasons you have to declare the type a pointer points to. An address in itself reveals only the beginning address of the object stored, not its type or the number of bytes used. Look at the addresses of the two values. They are just numbers with no type or size information. Also note that the size of a pointer-to-`int` is the same as the size of a pointer-to-`double`. Both are just addresses. But because `use_new.cpp` declares the pointer types, the program knows that `*pd` is a `double` value of 8 bytes, whereas `*pt` is an `int` value of 4 bytes. When `use_new.cpp` prints the value of `*pd`, `cout` can tell how many bytes to read and how to interpret them.

Another point to note is that typically `new` uses a different block of memory than do the ordinary variable definitions that we have been using. Both the variables `nights` and `pd` have their values stored in a memory region called the *stack*, whereas the memory allocated by `new` is in a region called the *heap* or *free store*. Chapter 9 discusses this a bit further.

## Out of Memory?

It's possible that a computer might not have sufficient memory available to satisfy a new request. When that is the case, `new` normally responds by throwing an exception, an error-handling technique discussed in Chapter 15, "Friends, Exceptions, and More." In older implementations `new` returns the value 0. In C++, a pointer with the value 0 is called the *null pointer*. C++ guarantees that the null pointer never points to valid data, so it is often used to indicate failure for operators or functions that otherwise return usable pointers. The `if` statement, discussed in Chapter 6, helps you deal with this possibility. For now, the important point is that C++ provides the tools to detect and respond to allocation failures.

## Freeing Memory with `delete`

Using `new` to request memory when you need it is just the more glamorous half of the C++ memory-management package. The other half is the `delete` operator, which enables you to return memory to the memory pool when you are finished with it. That is an important step toward making the most effective use of memory. Memory that you return, or *free*, can then be reused by other parts of the program. You use `delete` by following it with a pointer to a block of memory originally allocated with `new`:

```
int * ps = new int; // allocate memory with new
. . .             // use the memory
delete ps;        // free memory with delete when done
```

This removes the memory to which `ps` points; it doesn't remove the pointer `ps` itself. You can reuse `ps`, for example, to point to another `new` allocation. You should always balance a use of `new` with a use of `delete`; otherwise, you can wind up with a *memory leak*—that is, memory that has been allocated but can no longer be used. If a memory leak grows too large, it can bring a program seeking more memory to a halt.

You should not attempt to free a block of memory that you have previously freed. The C++ Standard says the result of such an attempt is undefined, meaning that the consequences could be anything. Also you cannot use `delete` to free memory created by declaring ordinary variables:

```
int * ps = new int;    // ok
delete ps;            // ok
delete ps;            // not ok now
int jugs = 5;         // ok
int * pi = &jugs;     // ok
delete pi;            // not allowed, memory not allocated by new
```

## Caution

You should use `delete` only to free memory allocated with `new`. However, it is safe to apply `delete` to a null pointer.

Note that the critical requirement for using `delete` is to use it with memory allocated by `new`. This doesn't mean you have to use the same pointer you used with `new`; instead, you have to use the same address:

```
int * ps = new int;    // allocate memory
int * pq = ps;        // set second pointer to same block
delete pq;            // delete with second pointer
```

Ordinarily, you won't create two pointers to the same block of memory because that raises the possibility that you will mistakenly try to delete the same block twice. But as you'll soon see, using a second pointer does make sense when you work with a function that returns a pointer.

## Using `new` to Create Dynamic Arrays

If all a program needs is a single value, you might as well declare a simple variable because that is simpler, if less impressive, than using `new` and a pointer to manage a single small data object. More typically, you use `new` with larger chunks of data, such as arrays, strings, and structures. This is where `new` is useful. Suppose, for example, you're writing a program that might or might not need an array, depending on information given to the program while it is running. If you create an array by declaring it, the space is allocated when the program is compiled. Whether or not the program finally uses the array, the array is there, using up memory. Allocating the array during compile time is called *static binding*, meaning that the array is built in to the program at compile time. But with `new`, you can create an array during runtime if you need it and skip creating the array if you don't need it. Or you can select an array size after the program is running. This is called *dynamic binding*, meaning that the array is created while the program is running. Such an array is called a *dynamic array*. With static binding, you must specify the array size when you write the program. With dynamic binding, the program can decide on an array size while the program runs.

For now, we'll look at two basic matters concerning dynamic arrays: how to use C++'s `new` operator to create an array and how to use a pointer to access array elements.

### Creating a Dynamic Array with `new`

It's easy to create a dynamic array in C++; you tell `new` the type of array element and number of elements you want. The syntax requires that you follow the type name with the number of elements, in brackets. For example, if you need an array of 10 `ints`, you use this:

```
int * psome = new int [10]; // get a block of 10 ints
```

The `new` operator returns the address of the first element of the block. In this example, that value is assigned to the pointer `psome`.

As always, you should balance the call to `new` with a call to `delete` when the program finishes using that block of memory. However, using `new` with brackets to create an array requires using an alternative form of `delete` when freeing the array:

```
delete [] psome;           // free a dynamic array
```

The presence of the brackets tells the program that it should free the whole array, not just the element pointed to by the pointer. Note that the brackets are between `delete` and the pointer. If you use `new` without brackets, you should use `delete` without brackets. If you use `new` with brackets, you should use `delete` with brackets. Earlier versions of C++ might not recognize the bracket notation. For the ANSI/ISO Standard, however, the effect of mismatching `new` and `delete` forms is undefined, meaning that you can't rely on some particular behavior. Here's an example:

```
int * pt = new int;
short * ps = new short [500];
delete [] pt; // effect is undefined, don't do it
delete ps;    // effect is undefined, don't do it
```

In short, you should observe these rules when you use `new` and `delete`:

- Don't use `delete` to free memory that `new` didn't allocate.
- Don't use `delete` to free the same block of memory twice in succession.
- Use `delete []` if you used `new []` to allocate an array.
- Use `delete` (no brackets) if you used `new` to allocate a single entity.
- It's safe to apply `delete` to the null pointer (nothing happens).

Now let's return to the dynamic array. Note that `psome` is a pointer to a single `int`, the first element of the block. It's your responsibility to keep track of how many elements are in the block. That is, because the compiler doesn't keep track of the fact that `psome` points to the first of 10 integers, you have to write your program so that it keeps track of the number of elements.

Actually, the program does keep track of the amount of memory allocated so that it can be correctly freed at a later time when you use the `delete []` operator. But that information isn't publicly available; you can't use the `sizeof` operator, for example, to find the number of bytes in a dynamically allocated array.

The general form for allocating and assigning memory for an array is this:

```
type_name * pointer_name = new type_name [num_elements];
```

Invoking the `new` operator secures a block of memory large enough to hold `num_elements` elements of type `type_name`, with `pointer_name` pointing to the first element. As you're about to see, you can use `pointer_name` in many of the same ways you can use an array name.

## Using a Dynamic Array

After you create a dynamic array, how do you use it? First, think about the problem conceptually. The following statement creates a pointer, `psome`, that points to the first element of a block of 10 `int` values:

```
int * psome = new int [10]; // get a block of 10 ints
```

Think of it as a finger pointing to that element. Suppose an `int` occupies 4 bytes. Then, by moving your finger 4 bytes in the correct direction, you can point to the second element. Altogether, there are 10 elements, which is the range over which you can move your finger. Thus, the `new` statement supplies you with all the information you need to identify every element in the block.

Now think about the problem practically. How do you access one of these elements? The first element is no problem. Because `psome` points to the first element of the array, `*psome` is the value of the first element. That leaves nine more elements to access. The simplest way to access the elements may surprise you if you haven't worked with C: Just use the pointer as if it were an array name. That is, you can use `psome[0]` instead of `*psome` for the first element, `psome[1]` for the second element, and so on. It turns out to be very simple to use a pointer to access a dynamic array, even if it may not immediately be obvious why the method works. The reason you can do this is that C and C++ handle arrays internally by using pointers anyway. This near equivalence of arrays and pointers is one of the beauties of C and C++. (It's also sometimes a problem, but that's another story.) You'll learn more about this equivalence in a moment. First, Listing 4.18 shows how you can use `new` to create a dynamic array and then use array notation to access the elements. It also points out a fundamental difference between a pointer and a true array name.

Listing 4.18 `arraynew.cpp`

---

```
// arraynew.cpp -- using the new operator for arrays
#include <iostream>
int main()
{
    using namespace std;
    double * p3 = new double [3]; // space for 3 doubles
    p3[0] = 0.2;                  // treat p3 like an array name
    p3[1] = 0.5;
    p3[2] = 0.8;
    cout << "p3[1] is " << p3[1] << ".\n";
    p3 = p3 + 1;                  // increment the pointer
    cout << "Now p3[0] is " << p3[0] << " and ";
    cout << "p3[1] is " << p3[1] << ".\n";
    p3 = p3 - 1;                  // point back to beginning
    delete [] p3;                 // free the memory
    return 0;
}
```

---

Here is the output from the program in Listing 4.18:

```
p3[1] is 0.5.
Now p3[0] is 0.5 and p3[1] is 0.8.
```

As you can see, `arraynew.cpp` uses the pointer `p3` as if it were the name of an array, with `p3[0]` as the first element, and so on. The fundamental difference between an array name and a pointer appears in the following line:

```
p3 = p3 + 1; // okay for pointers, wrong for array names
```

You can't change the value of an array name. But a pointer is a variable, hence you can change its value. Note the effect of adding 1 to `p3`. The expression `p3[0]` now refers to the former second element of the array. Thus, adding 1 to `p3` causes it to point to the second element instead of the first. Subtracting one takes the pointer back to its original value so that the program can provide `delete []` with the correct address.

The actual addresses of consecutive `ints` typically differ by 2 or 4 bytes, so the fact that adding 1 to `p3` gives the address of the next element suggests that there is something special about pointer arithmetic. There is.

## Pointers, Arrays, and Pointer Arithmetic

The near equivalence of pointers and array names stems from *pointer arithmetic* and how C++ handles arrays internally. First, let's check out the arithmetic. Adding one to an integer variable increases its value by one, but adding one to a pointer variable increases its value by the number of bytes of the type to which it points. Adding one to a pointer to `double` adds 8 to the numeric value on systems with 8-byte `double`, whereas adding one to a pointer-to-`short` adds two to the pointer value if `short` is 2 bytes. Listing 4.19 demonstrates this amazing point. It also shows a second important point: C++ interprets the array name as an address.

Listing 4.19 `addpntrs.cpp`

---

```
// addpntrs.cpp -- pointer addition
#include <iostream>
int main()
{
    using namespace std;
    double wages[3] = {10000.0, 20000.0, 30000.0};
    short stacks[3] = {3, 2, 1};

    // Here are two ways to get the address of an array
    double * pw = wages; // name of an array = address
    short * ps = &stacks[0]; // or use address operator
    // with array element
    cout << "pw = " << pw << ", *pw = " << *pw << endl;
    pw = pw + 1;
    cout << "add 1 to the pw pointer:\n";
    cout << "pw = " << pw << ", *pw = " << *pw << "\n\n";
```

```

    cout << "pw = " << pw << ", *pw = " << *pw << endl;
    pw = pw + 1;
    cout << "add 1 to the pw pointer:\n";
    cout << "pw = " << pw << ", *pw = " << *pw << "\n\n";

    cout << "access two elements with array notation\n";
    cout << "stacks[0] = " << stacks[0]
        << ", stacks[1] = " << stacks[1] << endl;
    cout << "access two elements with pointer notation\n";
    cout << "*stacks = " << *stacks
        << ", *(stacks + 1) = " << *(stacks + 1) << endl;

    cout << sizeof(wages) << " = size of wages array\n";
    cout << sizeof(pw) << " = size of pw pointer\n";
    return 0;
}

```

---

Here is the output from the program in Listing 4.19:

```

pw = 0x28ccf0, *pw = 10000
add 1 to the pw pointer:
pw = 0x28ccf8, *pw = 20000

ps = 0x28ccea, *ps = 3
add 1 to the ps pointer:
ps = 0x28ccec, *ps = 2

access two elements with array notation
stacks[0] = 3, stacks[1] = 2
access two elements with pointer notation
*stacks = 3, *(stacks + 1) = 2
24 = size of wages array
4 = size of pw pointer

```

## Program Notes

In most contexts, C++ interprets the name of an array as the address of its first element. Thus, the following statement makes `pw` a pointer to type `double` and then initializes `pw` to `wages`, which is the address of the first element of the `wages` array:

```
double * pw = wages;
```

For `wages`, as with any array, we have the following equality:

```
wages = &wages[0] = address of first element of array
```

Just to show that this is no jive, the program explicitly uses the address operator in the expression `&stacks[0]` to initialize the `ps` pointer to the first element of the `stacks` array.

Next, the program inspects the values of `pw` and `*pw`. The first is an address, and the second is the value at that address. Because `pw` points to the first element, the value displayed for `*pw` is that of the first element, `10000`. Then the program adds one to `pw`. As promised, this adds eight to the numeric address value because `double` on this system is 8 bytes. This makes `pw` equal to the address of the second element. Thus, `*pw` is now `20000`, the value of the second element (see Figure 4.10). (The address values in the figure are adjusted to make the figure clearer.)

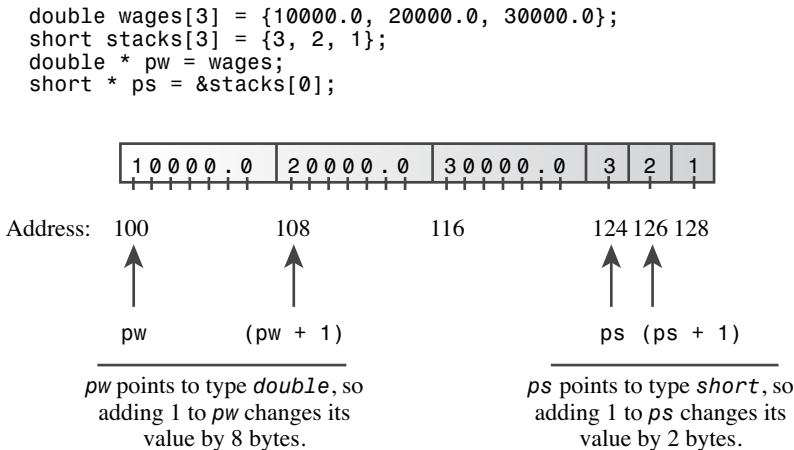

Figure 4.10 Pointer addition.

After this, the program goes through similar steps for `ps`. This time, because `ps` points to type `short` and because `short` is 2 bytes, adding 1 to the pointer increases its value by 2 (`0x28ccea + 2 = 0x28ccce` in hexadecimal). Again, the result is to make the pointer point to the next element of the array.

### Note

Adding one to a pointer variable increases its value by the number of bytes of the type to which it points.

Now consider the array expression `stacks[1]`. The C++ compiler treats this expression exactly as if you wrote it as `*(stacks + 1)`. The second expression means calculate the address of the second element of the array and then find the value stored there. The end result is precisely what `stacks[1]` means. (Operator precedence requires that you use the parentheses. Without them, `1` would be added to `*stacks` instead of to `stacks`.)

The program output demonstrates that `*(stacks + 1)` and `stacks[1]` are the same. Similarly, `*(stacks + 2)` is the same as `stacks[2]`. In general, wherever you use array notation, C++ makes the following conversion:

`arrayname[i]` becomes `*(arrayname + i)`



And if you use a pointer instead of an array name, C++ makes the same conversion:

```
pointername[i] becomes *(pointername + i)
```

Thus, in many respects you can use pointer names and array names in the same way. You can use the array brackets notation with either. You can apply the dereferencing operator (\*) to either. In most expressions, each represents an address. One difference is that you can change the value of a pointer, whereas an array name is a constant:

```
pointername = pointername + 1; // valid
arrayname = arrayname + 1;    // not allowed
```

A second difference is that applying the `sizeof` operator to an array name yields the size of the array, but applying `sizeof` to a pointer yields the size of the pointer, even if the pointer points to the array. For example, in Listing 4.19, both `pw` and `wages` refer to the same array. But applying the `sizeof` operator to them produces the following results:

```
24 = size of wages array << displaying sizeof wages
```

```
4 = size of pw pointer << displaying sizeof pw
```

This is one case in which C++ doesn't interpret the array name as an address.

### The Address of an Array

Taking the address of an array is another case in which the name of an array is not interpreted as its address. But wait, isn't the name of an array interpreted as the address of the array? Not quite—the name of the array is interpreted as the address of the first element of an array, whereas applying the address operator yields the address of the whole array:

```
short tell[10];          // tell an array of 20 bytes
cout << tell << endl;   // displays &tell[0]
cout << &tell << endl;  // displays address of whole array
```

Numerically, these two addresses are the same, but conceptually `&tell[0]`, and hence `tell`, is the address of a 2-byte block of memory, whereas `&tell` is the address of a 20-byte block of memory. So the expression `tell + 1` adds 2 to the address value, whereas `&tell + 1` adds 20 to the address value. Another way of expressing this is to say that `tell` is type pointer-to-short, or `short *`, and `&tell` is type pointer-to-array-of-20-shorts, or `short (*) [20]`.

Now you might be wondering about the genesis of that last type description. First, here is how you could declare and initialize a pointer of that type:

```
short (*pas)[20] = &tell; // pas points to array of 20 shorts
```

If you omit the parentheses, precedence rules would first associate `[20]` with `pas`, making `pas` an array of 20 pointers-to-short, so the parentheses are necessary. Next, if you wish to describe the type of a variable, you can use the declaration of that variable as a guide and remove the variable name. Thus, the type of `pas` is `short (*) [20]`. Also note that because `pas` is set to `&tell`, `*pas` is equivalent to `tell`, so `(*pas)[0]` would be the first element of the `tell` array.

In short, using `new` to create an array and using a pointer to access the different elements is a simple matter. You just treat the pointer as an array name. Understanding why this works, however, is an interesting challenge. If you actually want to understand arrays and pointers, you should review their mutual relationships carefully.

## Summarizing Pointer Points

You've been exposed to quite a bit of pointer knowledge lately, so let's summarize what's been revealed about pointers and arrays to date.

### Declaring Pointers

To declare a pointer to a particular type, use this form:

```
typeName * pointerName;
```

Here are some examples:

```
double * pn;      // pn can point to a double value
char * pc;       // pc can point to a char value
```

Here `pn` and `pc` are pointers, and `double *` and `char *` are the C++ notations for the types `pointer-to-double` and `pointer-to-char`.

### Assigning Values to Pointers

You should assign a memory address to a pointer. You can apply the `&` operator to a variable name to get an address of named memory, and the `new` operator returns the address of unnamed memory.

Here are some examples:

```
double * pn;      // pn can point to a double value
double * pa;     // so can pa
char * pc;       // pc can point to a char value
double bubble = 3.2;
pn = &bubble;    // assign address of bubble to pn
pc = new char;   // assign address of newly allocated char memory to pc
pa = new double[30]; // assign address of 1st element of array of 30 double to pa
```

### Dereferencing Pointers

Dereferencing a pointer means referring to the pointed-to value. You apply the dereferencing, or indirect value, operator (`*`) to a pointer to dereference it. Thus, if `pn` is a pointer to `bubble`, as in the preceding example, then `*pn` is the pointed-to value, or 3.2, in this case.

Here are some examples:

```
cout << *pn; // print the value of bubble
*pc = 'S';  // place 'S' into the memory location whose address is pc
```

Array notation is a second way to dereference a pointer; for instance, `pn[0]` is the same as `*pn`. You should never dereference a pointer that has not been initialized to a proper address.

### Distinguishing Between a Pointer and the Pointed-to Value

Remember, if `pt` is a pointer-to-`int`, `*pt` is not a pointer-to-`int`; instead, `*pt` is the complete equivalent to a type `int` variable. It is `pt` that is the pointer.

Here are some examples:

```
int * pt = new int;      // assigns an address to the pointer pt
*pt = 5;                // stores the value 5 at that address
```

### Array Names

In most contexts, C++ treats the name of an array as equivalent to the address of the first element of an array.

Here is an example:

```
int tacos[10];          // now tacos is the same as &tacos[0]
```

One exception is when you use the name of an array with the `sizeof` operator. In that case, `sizeof` returns the size of the entire array, in bytes.

### Pointer Arithmetic

C++ allows you to add an integer to a pointer. The result of adding one equals the original address value plus a value equal to the number of bytes in the pointed-to object. You can also subtract an integer from a pointer to take the difference between two pointers. The last operation, which yields an integer, is meaningful only if the two pointers point into the same array (pointing to one position past the end is allowed, too); it then yields the separation between the two elements.

Here are some examples:

```
int tacos[10] = {5,2,8,4,1,2,2,4,6,8};
int * pt = tacos;      // suppose pf and tacos are the address 3000
pt = pt + 1;           // now pt is 3004 if a int is 4 bytes
int *pe = &tacos[9];   // pe is 3036 if an int is 4 bytes
pe = pe - 1;           // now pe is 3032, the address of tacos[8]
int diff = pe - pt;    // diff is 7, the separation between
                       // tacos[8] and tacos[1]
```

### Dynamic Binding and Static Binding for Arrays

You can use an array declaration to create an array with static binding—that is, an array whose size is set during the compilation process:

```
int tacos[10]; // static binding, size fixed at compile time
```

You use the `new []` operator to create an array with dynamic binding (a dynamic array)—that is, an array that is allocated and whose size can be set during runtime. You free the memory with `delete []` when you are done:

```
int size;
cin >> size;
int * pz = new int [size]; // dynamic binding, size set at run time
...
delete [] pz; // free memory when finished
```

## Array Notation and Pointer Notation

Using bracket array notation is equivalent to dereferencing a pointer:

```
tacos[0] means *tacos means the value at address tacos
tacos[3] means *(tacos + 3) means the value at address tacos + 3
```

This is true for both array names and pointer variables, so you can use either pointer notation or array notation with pointers and array names.

Here are some examples:

```
int * pt = new int [10]; // pt points to block of 10 ints
*pt = 5; // set element number 0 to 5
pt[0] = 6; // reset element number 0 to 6
pt[9] = 44; // set tenth element (element number 9) to 44
int coats[10];
*(coats + 4) = 12; // set coats[4] to 12
```

## Pointers and Strings

The special relationship between arrays and pointers extends to C-style strings. Consider the following code:

```
char flower[10] = "rose";
cout << flower << "s are red\n";
```

The name of an array is the address of its first element, so `flower` in the `cout` statement is the address of the `char` element containing the character `r`. The `cout` object assumes that the address of a `char` is the address of a string, so it prints the character at that address and then continues printing characters until it runs into the null character (`\0`). In short, if you give `cout` the address of a character, it prints everything from that character to the first null character that follows it.

The crucial element here is not that `flower` is an array name but that `flower` acts as the address of a `char`. This implies that you can use a pointer-to-`char` variable as an argument to `cout` also because it, too, is the address of a `char`. Of course, that pointer should point to the beginning of a string. We'll check that out in a moment.

But what about the final part of the preceding `cout` statement? If `flower` is actually the address of the first character of a string, what is the expression `"s are red\n"`? To be consistent with `cout`'s handling of string output, this quoted string should also be an

address. And it is, for in C++ a quoted string, like an array name, serves as the address of its first element. The preceding code doesn't really send a whole string to `cout`; it just sends the string address. This means strings in an array, quoted string constants, and strings described by pointers are all handled equivalently. Each is really passed along as an address. That's certainly less work than passing each and every character in a string.

### Note

With `cout` and with most C++ expressions, the name of an array of `char`, a pointer-to-`char`, and a quoted string constant are all interpreted as the address of the first character of a string.

Listing 4.20 illustrates the use of the different forms of strings. It uses two functions from the string library. The `strlen()` function, which you've used before, returns the length of a string. The `strcpy()` function copies a string from one location to another. Both have function prototypes in the `cstring` header file (or `string.h`, on less up-to-date implementations). The program also uses comments to showcase some pointer misuses that you should try to avoid.

#### Listing 4.20 `ptrstr.cpp`

---

```
// ptrstr.cpp -- using pointers to strings
#include <iostream>
#include <cstring>           // declare strlen(), strcpy()
int main()
{
    using namespace std;
    char animal[20] = "bear"; // animal holds bear
    const char * bird = "wren"; // bird holds address of string
    char * ps;                // uninitialized

    cout << animal << " and "; // display bear
    cout << bird << "\n";      // display wren
    // cout << ps << "\n";     //may display garbage, may cause a crash

    cout << "Enter a kind of animal: ";
    cin >> animal;             // ok if input < 20 chars
    // cin >> ps; Too horrible a blunder to try; ps doesn't
    //           point to allocated space

    ps = animal;              // set ps to point to string
    cout << ps << "!\n";        // ok, same as using animal
    cout << "Before using strcpy():\n";
    cout << animal << " at " << (int *) animal << endl;
    cout << ps << " at " << (int *) ps << endl;

    ps = new char[strlen(animal) + 1]; // get new storage
    strcpy(ps, animal);                // copy string to new storage
```

```
cout << "After using strcpy():\n";
cout << animal << " at " << (int *) animal << endl;
cout << ps << " at " << (int *) ps << endl;
delete [] ps;
return 0;
}
```

---

Here is a sample run of the program in Listing 4.20:

```
bear and wren
Enter a kind of animal: fox
fox!
Before using strcpy():
fox at 0x0065fd30
fox at 0x0065fd30
After using strcpy():
fox at 0x0065fd30
fox at 0x004301c8
```

### Program Notes

The program in Listing 4.20 creates one char array (`animal`) and two pointers-to-char variables (`bird` and `ps`). The program begins by initializing the `animal` array to the "bear" string, just as you've initialized arrays before. Then, the program does something new. It initializes a pointer-to-char to a string:

```
const char * bird = "wren"; // bird holds address of string
```

Remember, "wren" actually represents the address of the string, so this statement assigns the address of "wren" to the `bird` pointer. (Typically, a compiler sets aside an area in memory to hold all the quoted strings used in the program source code, associating each stored string with its address.) This means you can use the pointer `bird` just as you would use the string "wren", as in this example:

```
cout << "A concerned " << bird << " speaks\n";
```

String literals are constants, which is why the code uses the `const` keyword in the declaration. Using `const` in this fashion means you can use `bird` to access the string but not to change it. Chapter 7 takes up the topic of `const` pointers in greater detail. Finally, the pointer `ps` remains uninitialized, so it doesn't point to any string. (As you know, that is usually a bad idea, and this example is no exception.)

Next, the program illustrates that you can use the array name `animal` and the pointer `bird` equivalently with `cout`. Both, after all, are the addresses of strings, and `cout` displays the two strings ("bear" and "wren") stored at those addresses. If you activate the code that makes the error of attempting to display `ps`, you might get a blank line, you might get garbage displayed, and you might get a program crash. Creating an uninitialized pointer is a bit like distributing a blank signed check: You lack control over how it will be used.

For input, the situation is a bit different. It's safe to use the array `animal` for input as long as the input is short enough to fit into the array. It would not be proper to use `bird` for input, however:

- Some compilers treat string literals as read-only constants, leading to a runtime error if you try to write new data over them. That string literals be constants is the mandated behavior in C++, but not all compilers have made that change from older behavior yet.
- Some compilers use just one copy of a string literal to represent all occurrences of that literal in a program.

Let's amplify the second point. C++ doesn't guarantee that string literals are stored uniquely. That is, if you use a string literal "wren" several times in a program, the compiler might store several copies of the string or just one copy. If it does the latter, then setting `bird` to point to one "wren" makes it point to the only copy of that string. Reading a value into one string could affect what you thought was an independent string elsewhere. In any case, because the `bird` pointer is declared as `const`, the compiler prevents any attempt to change the contents of the location pointed to by `bird`.

Worse yet is trying to read information into the location to which `ps` points. Because `ps` is not initialized, you don't know where the information will wind up. It might even overwrite information that is already in memory. Fortunately, it's easy to avoid these problems: You just use a sufficiently large `char` array to receive input and don't use string constants to receive input or uninitialized pointers to receive input. (Or you can sidestep all these issues and use `std::string` objects instead of arrays.)

### Caution

When you read a string into a program-style string, you should always use the address of previously allocated memory. This address can be in the form of an array name or of a pointer that has been initialized using `new`.

Next, notice what the following code accomplishes:

```
ps = animal;           // set ps to point to string
...
cout << animal << " at " << (int *) animal << endl;
cout << ps << " at " << (int *) ps << endl;
```

It produces the following output:

```
fox at 0x0065fd30
fox at 0x0065fd30
```

Normally, if you give `cout` a pointer, it prints an address. But if the pointer is type `char *`, `cout` displays the pointed-to string. If you want to see the address of the string, you have to type cast the pointer to another pointer type, such as `int *`, which this code does.

So `ps` displays as the string "fox", but `(int *) ps` displays as the address where the string is found. Note that assigning `animal` to `ps` does not copy the string; it copies the address. This results in two pointers (`animal` and `ps`) to the same memory location and string.

To get a copy of a string, you need to do more. First, you need to allocate memory to hold the string. You can do this by declaring a second array or by using `new`. The second approach enables you to custom fit the storage to the string:

```
ps = new char[strlen(animal) + 1]; // get new storage
```

The string "fox" doesn't completely fill the `animal` array, so this approach wastes space. This bit of code uses `strlen()` to find the length of the string; it adds one to get the length, including the null character. Then the program uses `new` to allocate just enough space to hold the string.

Next, you need a way to copy a string from the `animal` array to the newly allocated space. It doesn't work to assign `animal` to `ps` because that just changes the address stored in `ps` and thus loses the only way the program had to access the newly allocated memory. Instead, you need to use the `strcpy()` library function:

```
strcpy(ps, animal); // copy string to new storage
```

The `strcpy()` function takes two arguments. The first is the destination address, and the second is the address of the string to be copied. It's up to you to make certain that the destination really is allocated and has sufficient space to hold the copy. That's accomplished here by using `strlen()` to find the correct size and using `new` to get free memory.

Note that by using `strcpy()` and `new`, you get two separate copies of "fox":

```
fox at 0x0065fd30
fox at 0x004301c8
```

Also note that `new` located the new storage at a memory location quite distant from that of the array `animal`.

Often you encounter the need to place a string into an array. You use the `=` operator when you initialize an array; otherwise, you use `strcpy()` or `strncpy()`. You've seen the `strcpy()` function; it works like this:

```
char food[20] = "carrots"; // initialization
strcpy(food, "flan"); // otherwise
```

Note that something like the following can cause problems because the `food` array is smaller than the string:

```
strcpy(food, "a picnic basket filled with many goodies");
```

In this case, the function copies the rest of the string into the memory bytes immediately following the array, which can overwrite other memory the program is using. To avoid that problem, you should use `strncpy()` instead. It takes a third argument: the maximum number of characters to be copied. Be aware, however, that if this function runs out



of space before it reaches the end of the string, it doesn't add the null character. Thus, you should use the function like this:

```
strcpy(food, "a picnic basket filled with many goodies", 19);
food[19] = '\0';
```

This copies up to 19 characters into the array and then sets the last element to the null character. If the string is shorter than 19 characters, `strcpy()` adds a null character earlier to mark the true end of the string.

### Caution

Use `strcpy()` or `strncpy()`, not the assignment operator, to assign a string to an array.

Now that you've seen some aspects of using C-style strings and the `cstring` library, you can appreciate the comparative simplicity of using the C++ `string` type. You (normally) don't have to worry about a string overflowing an array, and you can use the assignment operator instead of `strcpy()` or `strncpy()`.

## Using `new` to Create Dynamic Structures

You've seen how it can be advantageous to create arrays during runtime rather than at compile time. The same holds true for structures. You need to allocate space for only as many structures as a program needs during a particular run. Again, the `new` operator is the tool to use. With it, you can create dynamic structures. Again, *dynamic* means the memory is allocated during runtime, not at compile time. Incidentally, because classes are much like structures, you are able to use the techniques you'll learn in this section for structures with classes, too.

Using `new` with structures has two parts: creating the structure and accessing its members. To create a structure, you use the structure type with `new`. For example, to create an unnamed structure of the `inflatable` type and assign its address to a suitable pointer, you can use the following:

```
inflatable * ps = new inflatable;
```

This assigns to `ps` the address of a chunk of free memory large enough to hold a structure of the `inflatable` type. Note that the syntax is exactly the same as it is for C++'s built-in types.

The tricky part is accessing members. When you create a dynamic structure, you can't use the dot membership operator with the structure name because the structure has no name. All you have is its address. C++ provides an operator just for this situation: the arrow membership operator (`->`). This operator, formed by typing a hyphen and then a greater-than symbol, does for pointers to structures what the dot operator does for structure names. For example, if `ps` points to a type `inflatable` structure, then `ps->price` is the `price` member of the pointed-to structure (see Figure 4.11).

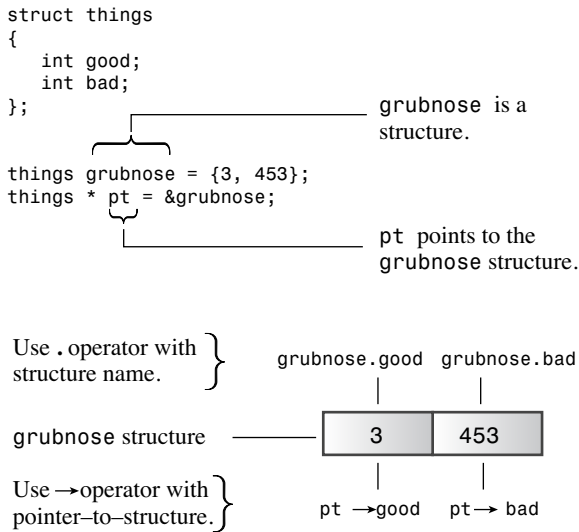

Figure 4.11 Identifying structure members.

**Tip**

Sometimes new C++ users become confused about when to use the dot operator and when to use the arrow operator to specify a structure member. The rule is simple: If the structure identifier is the name of a structure, use the dot operator. If the identifier is a pointer to the structure, use the arrow operator.

A second, uglier approach to accessing structure members is to realize that if `ps` is a pointer to a structure, then `*ps` represents the pointed-to value—the structure itself. Then, because `*ps` is a structure, `(*ps).price` is the `price` member of the structure. C++’s operator precedence rules require that you use parentheses in this construction.

Listing 4.21 uses `new` to create an unnamed structure and demonstrates both pointer notations for accessing structure members.

**Listing 4.21 newstrct.cpp**

```

// newstrct.cpp -- using new with a structure
#include <iostream>
struct inflatable // structure definition
{
    char name[20];
    float volume;
    double price;
};
int main()
{
    using namespace std;

```

```

inflatable * ps = new inflatable; // allot memory for structure
cout << "Enter name of inflatable item: ";
cin.get(ps->name, 20);           // method 1 for member access
cout << "Enter volume in cubic feet: ";
cin >> (*ps).volume;           // method 2 for member access
cout << "Enter price: $";
cin >> ps->price;
cout << "Name: " << (*ps).name << endl;           // method 2
cout << "Volume: " << ps->volume << " cubic feet\n"; // method 1
cout << "Price: $" << ps->price << endl;           // method 1
delete ps;                          // free memory used by structure
return 0;
}

```

---

Here is a sample run of the program in Listing 4.21:

```

Enter name of inflatable item: Fabulous Frodo
Enter volume in cubic feet: 1.4
Enter price: $27.99
Name: Fabulous Frodo
Volume: 1.4 cubic feet
Price: $27.99

```

### An Example of Using `new` and `delete`

Let's look at an example that uses `new` and `delete` to manage storing string input from the keyboard. Listing 4.22 defines a function `getname()` that returns a pointer to an input string. This function reads the input into a large temporary array and then uses `new []` with an appropriate size to create a chunk of memory sized to fit to the input string. Then the function returns the pointer to the block. This approach could conserve a lot of memory for programs that read in a large number of strings. (In real life, where many of us live, it would be easier to use the `string` class, which has the use of `new` and `delete` built in to its design.)

Suppose your program has to read 1,000 strings and that the largest string might be 79 characters long, but most of the strings are much shorter than that. If you used `char` arrays to hold the strings, you'd need 1,000 arrays of 80 characters each. That's 80,000 bytes, and much of that block of memory would wind up being unused. Alternatively, you could create an array of 1,000 pointers to `char` and then use `new` to allocate only the amount of memory needed for each string. That could save tens of thousands of bytes. Instead of having to use a large array for every string, you fit the memory to the input. Even better, you could also use `new` to find space to store only as many pointers as needed. Well, that's a little too ambitious for right now. Even using an array of 1,000 pointers is a little too ambitious for right now, but Listing 4.22 illustrates some of the technique. Also just to illustrate how `delete` works, the program uses it to free memory for reuse.

**Listing 4.22 delete.cpp**

---

```
// delete.cpp -- using the delete operator
#include <iostream>
#include <cstring>      // or string.h
using namespace std;
char * getname(void); // function prototype
int main()
{
    char * name;      // create pointer but no storage

    name = getname(); // assign address of string to name
    cout << name << " at " << (int *) name << "\n";
    delete [] name;   // memory freed

    name = getname(); // reuse freed memory
    cout << name << " at " << (int *) name << "\n";
    delete [] name;   // memory freed again
    return 0;
}

char * getname()      // return pointer to new string
{
    char temp[80];    // temporary storage
    cout << "Enter last name: ";
    cin >> temp;
    char * pn = new char[strlen(temp) + 1];
    strcpy(pn, temp); // copy string into smaller space

    return pn;       // temp lost when function ends
}
```

---

Here is a sample run of the program in Listing 4.22:

```
Enter last name: Fredeldumpkin
Fredeldumpkin at 0x004326b8
Enter last name: Pook
Pook at 0x004301c8
```

**Program Notes**

Consider the function `getname()` in the program in Listing 4.22. It uses `cin` to place an input word into the `temp` array. Next, it uses `new` to allocate new memory to hold the word. Including the null character, the program needs `strlen(temp) + 1` characters to store the string, so that's the value given to `new`. After the space becomes available, `getname()` uses the standard library function `strcpy()` to copy the string from `temp` to the new block. The function doesn't check to see whether the string fits, but `getname()`

covers that by requesting the right number of bytes with `new`. Finally, the function returns `pn`, the address of the string copy.

In `main()`, the return value (the address) is assigned to the pointer `name`. This pointer is defined in `main()`, but it points to the block of memory allocated in the `getline()` function. The program then prints the string and the address of the string.

Next, after it frees the block pointed to by `name`, `main()` calls `getline()` a second time. C++ doesn't guarantee that newly freed memory is the first to be chosen the next time `new` is used, and in this sample run, it isn't.

Note in this example that `getline()` allocates memory and `main()` frees it. It's usually not a good idea to put `new` and `delete` in separate functions because that makes it easier to forget to use `delete`. But this example does separate `new` from `delete` just to show that it is possible.

To appreciate some of the more subtle aspects of this program, you should know a little more about how C++ handles memory. So let's preview some material that's covered more fully in Chapter 9.

## Automatic Storage, Static Storage, and Dynamic Storage

C++ has three ways of managing memory for data, depending on the method used to allocate memory: automatic storage, static storage, and dynamic storage, sometimes called the *free store* or *heap*. Data objects allocated in these three ways differ from each other in how long they remain in existence. We'll take a quick look at each type. (C++11 adds a fourth form called *thread storage* that we'll discuss briefly in Chapter 9.)

### Automatic Storage

Ordinary variables defined inside a function use *automatic storage* and are called *automatic variables*. These terms mean that the variables come into existence automatically when the function containing them is invoked, and they expire when the function terminates. For example, the `temp` array in Listing 4.22 exists only while the `getline()` function is active. When program control returns to `main()`, the memory used for `temp` is freed automatically. If `getline()` returned the address of `temp`, the `name` pointer in `main()` would be left pointing to a memory location that would soon be reused. That's one reason you have to use `new` in `getline()`. Actually, automatic values are local to the block that contains them. A *block* is a section of code enclosed between braces. So far, all our blocks have been entire functions. But as you'll see in the next chapter, you can have blocks within a function. If you define a variable inside one of those blocks, it exists only while the program is executing statements inside the block.

Automatic variables typically are stored on a *stack*. This means that when program execution enters a block of code, its variables are added consecutively to the stack in memory and then are freed in reverse order when execution leaves the block. (This is called a *last-in, first-out*, or *LIFO*, process.) So the stack grows and shrinks as execution proceeds.

## Static Storage

Static storage is storage that exists throughout the execution of an entire program. There are two ways to make a variable static. One is to define it externally, outside a function. The other is to use the keyword `static` when declaring a variable:

```
static double fee = 56.50;
```

Under K&R C, you can initialize only static arrays and structures, whereas C++ Release 2.0 (and later) and ANSI C allow you to initialize automatic arrays and structures, too. However, as you may have discovered, some C++ implementations do not yet implement initialization for automatic arrays and structures.

Chapter 9 discusses static storage in more detail. The main point you should note now about automatic and static storage is that these methods rigidly define the lifetime of a variable. Either the variable exists for the entire duration of a program (a static variable) or it exists only while a particular function is being executed (an automatic variable).

## Dynamic Storage

The `new` and `delete` operators provide a more flexible approach than automatic and static variables. They manage a pool of memory, which C++ refers to as the *free store* or *heap*. This pool is separate from the memory used for static and automatic variables. As Listing 4.22 shows, `new` and `delete` enable you to allocate memory in one function and free it in another. Thus, the lifetime of the data is not tied arbitrarily to the life of the program or the life of a function. Using `new` and `delete` together gives you much more control over how a program uses memory than does using ordinary variables. However, memory management becomes more complex. In a stack, the automatic addition and removal mechanism results in the part of memory in use always being contiguous. But the interplay between `new` and `delete` can leave holes in the free store, making keeping track of where to allocate new memory requests more difficult.

### Stacks, Heaps, and Memory Leaks

What happens if you *don't* call `delete` after creating a variable on the free store (or heap) with the `new` operator? The variable or construct dynamically allocated on the free store continues to persist if `delete` is not called, even though the memory that contains the pointer has been freed due to rules of scope and object lifetime. In essence, you have no way to access the construct on the free store because the pointer to the memory that contains it is gone. You have now created a *memory leak*. Memory that has been leaked remains unusable through the life of the program; it's been allocated but can't be deallocated.

In extreme (though not uncommon) cases, memory leaks can be so severe that they use up all the memory available to the application, causing it to crash with an out-of-memory error. In addition, these leaks may negatively affect some operating systems or other applications running in the same memory space, causing them, in turn, to fail.

Even the best programmers and software companies create memory leaks. To avoid them, it's best to get into the habit of joining your `new` and `delete` operators immediately, planning for and entering the deletion of your construct as soon as you dynamically allocate it on the free store. C++'s smart pointers (Chapter 16) help automate the task.

**Note**

Pointers are among the most powerful of C++ tools. They are also the most dangerous because they permit computer-unfriendly actions, such as using an uninitialized pointer to access memory or attempting to free the same memory block twice. Furthermore, until you get used to pointer notation and pointer concepts through practice, pointers can be confusing. Because pointers are an important part of C++ programming, they weave in and out of future discussions in this book. This book discusses pointers several more times. The hope is that each exposure will make you more comfortable with them.

## Combinations of Types

This chapter has introduced arrays, structures, and pointers. These can be combined in various ways, so let's review some of the possibilities, starting with a structure:

```
struct antarctica_years_end
{
    int year;
    /* some really interesting data, etc. */
};
```

We can create variables of this type:

```
antarctica_years_end s01, s02, s03; // s01, s02, s03 are structures
```

We can then access members using the membership operator:

```
s01.year = 1998;
```

We can create a pointer to such a structure:

```
antarctica_years_end * pa = &s02;
```

Provided the pointer has been set to a valid address, we then can use the indirect membership operator to access members:

```
pa->year = 1999;
```

We can create arrays of structures:

```
antarctica_years_end trio[3]; // array of 3 structures
```

We then can use the membership operator to access members of an element:

```
trio[0].year = 2003; // trio[0] is a structure
```

Here, `trio` is an array, but `trio[0]` is a structure, and `trio[0].year` is a member of that structure. Because an array name is a pointer, we also can use the indirect membership operator:

```
(trio+1)->year = 2004; // same as trio[1].year = 2004;
```

We can create an array of pointers:

```
const antarctica_years_end * arp[3] = {&s01, &s02, &s03};
```

This is starting to look a bit complicated. How can we access data with this array? Well, if `arp` is an array of pointers, then `arp[1]` must be a pointer, and we can use the indirect membership operator with it to access a member:

```
std::cout << arp[1]->year << std::endl;
```

We can create a pointer to such an array:

```
const antarctica_years_end ** ppa = arp;
```

Here, `arp` is the name of an array; hence, it is the address of its first element. But its first element is a pointer, so `ppa` has to be a pointer to a pointer to `const antarctica_years_end`, hence the `**`. There are several ways you could mess up this declaration. For example, you could omit the `const`, forget an `*` or two, transpose letters, or otherwise mangle the structure type. Here is an instance for which the C++11 version of `auto` is convenient. The compiler is perfectly aware of what type `arp` is, so it can deduce the correct type for you:

```
auto ppb = arp; // C++11 automatic type deduction
```

In the past, the compiler used its knowledge of the correct type to complain about errors you may have made in the declaration; now it can let its knowledge work for you.

How can you use `ppa` to access data? Because `ppa` is a pointer to a pointer to a structure, `*ppa` is a pointer to a structure, so you can use it with the indirect membership operator:

```
std::cout << (*ppa)->year << std::endl;
std::cout << (*(ppb+1))->year << std::endl;
```

Because `ppa` points to the first member of `arp`, `*ppa` is the first member, which is `&s01`. So `(*ppa)->year` is the `year` member of `s01`. In the second statement, `ppb+1` points to the next element, `arp[1]`, which is `&s02`. The parentheses are needed to get the correct associations. For example, `*ppa->year` would attempt to apply the `*` operator to `ppa->year`, which fails because the `year` member is not a pointer.

Is all this really true? Listing 4.23 incorporates all the preceding statements into a short program.

#### Listing 4.23 `mixtypes.cpp`

---

```
// mixtypes.cpp -- some type combinations
#include <iostream>

struct antarctica_years_end
{
    int year;
    /* some really interesting data, etc. */
};

int main()
```



```

{
    antarctica_years_end s01, s02, s03;
    s01.year = 1998;
    antarctica_years_end * pa = &s02;
    pa->year = 1999;
    antarctica_years_end trio[3]; // array of 3 structures
    trio[0].year = 2003;
    std::cout << trio->year << std::endl;
    const antarctica_years_end * arp[3] = {&s01, &s02, &s03};
    std::cout << arp[1]->year << std::endl;
    const antarctica_years_end ** ppa = arp;
    auto ppb = arp; // C++11 automatic type deduction
    // or else use const antarctica_years_end ** ppb = arp;
    std::cout << (*ppa)->year << std::endl;
    std::cout << *(ppb+1)->year << std::endl;
    return 0;
}

```

---

Here's the output:

```

2003
1999
1998
1999

```

The program compiles and works as promised.

## Array Alternatives

Earlier this chapter mentioned the `vector` and `array` template classes as alternatives to the built-in array. Let's take a brief look now at how they are used and at some of the benefits of using them.

### The `vector` Template Class

The `vector` template class is similar to the `string` class in that it is a dynamic array. You can set the size of a `vector` object during runtime, and you can append new data to the end or insert new data in the middle. Basically, it's an alternative to using `new` to create a dynamic array. Actually, the `vector` class does use `new` and `delete` to manage memory, but it does so automatically.

At this time we won't venture very deeply into what it means to be a template class. Instead, we'll look at a few basic practical matters. First, to use a `vector` object, you need to include the `vector` header file. Second, the `vector` identifier is part of the `std` namespace, so you can use a `using` directive, a `using` declaration, or `std::vector`. Third,

templates use a different syntax to indicate the type of data stored. Fourth, the `vector` class uses a different syntax to indicate the number of elements. Here are some examples:

```
#include <vector>
...
using namespace std;
vector<int> vi;           // create a zero-size array of int
int n;
cin >> n;
vector<double> vd(n);   // create an array of n doubles
```

We say that `vi` is an object of type `vector<int>` and that `vd` is an object of type `vector<double>`. Because `vector` objects resize automatically when you insert or add values to them, it's okay for `vi` to start with 0 size. But for the resizing to work, you would use the various methods that are part of the `vector` package.

In general, the following declaration creates a `vector` object `vt` that can hold `n_elem` elements of type `typeName`:

```
vector<typeName> vt(n_elem);
```

The parameter `n_elem` can be an integer constant or an integer variable.

## The array Template Class (C++11)

The `vector` class has more capabilities than the built-in array type, but this comes at a cost of slightly less efficiency. If all you need is a fixed-size array, it could be advantageous to use the built-in type. However, that has its own costs of lessened convenience and safety. C++11 responded to this situation by adding the `array` template class, which is part of the `std` namespace. Like the built-in type, an `array` object has a fixed size and uses the stack (or else static memory allocation) instead of the free store, so it shares the efficiency of built-in arrays. To this it adds convenience and additional safety. To create an `array` object, you need to include the `array` header file. The syntax is a bit different from that for a `vector`:

```
#include <array>
...
using namespace std;
array<int, 5> ai;   // create array object of 5 ints
array<double, 4> ad = {1.2, 2.1, 3.43, 4.3};
```

More general, the following declaration creates an `array` object `arr` with `n_elem` elements of `typeName`:

```
array<typeName, n_elem> arr;
```

Unlike the case for `vector`, `n_elem` can't be a variable.

With C++11, you can use list-initialization with `vector` and `array` objects. However, that was not an option with C++98 `vector` objects.

## Comparing Arrays, Vector Objects, and Array Objects

Perhaps the simplest way to understand the similarities and differences between arrays, vector objects, and array objects is to look at a brief example (Listing 4.24) that uses all three approaches.

Listing 4.24 `choices.cpp`

---

```
// choices.cpp -- array variations
#include <iostream>
#include <vector>    // STL C++98
#include <array>    // C++11
int main()
{
    using namespace std;
    // C, original C++
    double a1[4] = {1.2, 2.4, 3.6, 4.8};
    // C++98 STL
    vector<double> a2(4);    // create vector with 4 elements
    // no simple way to initialize in C98
    a2[0] = 1.0/3.0;
    a2[1] = 1.0/5.0;
    a2[2] = 1.0/7.0;
    a2[3] = 1.0/9.0;
    // C++11 -- create and initialize array object
    array<double, 4> a3 = {3.14, 2.72, 1.62, 1.41};
    array<double, 4> a4;
    a4 = a3;    // valid for array objects of same size
    // use array notation
    cout << "a1[2]: " << a1[2] << " at " << &a1[2] << endl;
    cout << "a2[2]: " << a2[2] << " at " << &a2[2] << endl;
    cout << "a3[2]: " << a3[2] << " at " << &a3[2] << endl;
    cout << "a4[2]: " << a4[2] << " at " << &a4[2] << endl;
    // misdeed
    a1[-2] = 20.2;
    cout << "a1[-2]: " << a1[-2] << " at " << &a1[-2] << endl;
    cout << "a3[2]: " << a3[2] << " at " << &a3[2] << endl;
    cout << "a4[2]: " << a4[2] << " at " << &a4[2] << endl;
    return 0;
}
```

---

Here's some sample output:

```
a1[2]: 3.6 at 0x28cce8
a2[2]: 0.142857 at 0xca0328
a3[2]: 1.62 at 0x28ccc8
a4[2]: 1.62 at 0x28cca8
```

```
a1[-2]: 20.2 at 0x28ccc8
a3[2]: 20.2 at 0x28ccc8
a4[2]: 1.62 at 0x28cca8
```

## Program Notes

First, notice that whether we use a built-in array, a `vector` object, or an `array` object, we can use the standard array notation to access individual members. Second, you can see from the addresses that `array` objects use the same region of memory (the stack, in this case) as the built-in array, whereas the `vector` object is stored in a different region (the free store, or heap). Third, note that you can assign an `array` object to another `array` object. For built-in arrays, you have to copy the data element-by-element.

Next, and this deserves special attention, note this line:

```
a1[-2] = 20.2;
```

What does an index of `-2` mean? Recall that this translates to the following:

```
*(a1-2) = 20.2;
```

Expressing this in words, see where `a1` points, move backward two `double` elements, and put `20.2` there. That is, store the information at a location outside of the array. C++, like C, does not check for such out-of-range errors. In this particular case, that location turned out to be in the `array` object `a3`. Another compiler placed the wayward `20.2` in `a4`, and other compilers might make yet other bad choices. This is an example of the unsafe behavior of built-in arrays.

Do the `vector` and `array` objects protect against this behavior? They can if you let them. That is, you still can write unsafe code, such as the following:

```
a2[-2] = .5;    // still allowed
a3[200] = 1.4;
```

However, you have alternatives. One is using the `at()` member function. Just as you can use the `getline()` member function with the `cin` object, you can use the `at()` member function with objects of the `vector` or `array` type:

```
a2.at(1) = 2.3; // assign 2.3 to a2[1]
```

The difference between using bracket notation and the `at()` member function is that if you use `at()`, an invalid index is caught during runtime and the program, by default, aborts. This added checking does come at the cost of increased run time, which is why C++ gives you the option of using either notation. More than that, these classes offer ways of using objects that reduce the chances of accidental range errors. For example, the classes have `begin()` and `end()` member functions that let you delimit the range without accidentally exceeding the bounds. But we'll save that discussion until Chapter 16.

## Summary

Arrays, structures, and pointers are three C++ compound types. An array can hold several values, all of the same type, in a single data object. By using an index, or subscript, you can access the individual elements in an array.

A structure can hold several values of different types in a single data object, and you can use the membership operator (`.`) to access individual members. The first step in using structures is to create a structure template that defines what members the structure holds. The name, or tag, for this template then becomes a new type identifier. You can then declare structure variables of that type.

A union can hold a single value, but it can be of a variety of types, with the member name indicating which mode is being used.

Pointers are variables that are designed to hold addresses. We say a pointer points to the address it holds. The pointer declaration always states to what type of object a pointer points. Applying the dereferencing operator (`*`) to a pointer yields the value at the location to which the pointer points.

A string is a series of characters terminated by a null character. A string can be represented by a quoted string constant, in which case the null character is implicitly understood. You can store a string in an array of `char`, and you can represent a string with a pointer-to-`char` that is initialized to point to the string. The `strlen()` function returns the length of a string, not counting the null character. The `strcpy()` function copies a string from one location to another. When using these functions, you include the `cstring` or the `string.h` header file.

The C++ `string` class, supported by the `string` header file, offers an alternative, more user-friendly means to deal with strings. In particular, `string` objects are automatically resized to accommodate stored strings, and you can use the assignment operator to copy a string.

The `new` operator lets you request memory for a data object while a program is running. The operator returns the address of the memory it obtains, and you can assign that address to a pointer. The only means to access that memory is to use the pointer. If the data object is a simple variable, you can use the dereferencing operator (`*`) to indicate a value. If the data object is an array, you can use the pointer as if it were an array name to access the elements. If the data object is a structure, you can use the pointer dereferencing operator (`->`) to access structure members.

Pointers and arrays are closely connected. If `ar` is an array name, then the expression `ar[i]` is interpreted as `*(ar + i)`, with the array name interpreted as the address of the first element of the array. Thus, the array name plays the same role as a pointer. In turn, you can use a pointer name with array notation to access elements in an array allocated by `new`.

The `new` and `delete` operators let you explicitly control when data objects are allocated and when they are returned to the memory pool. Automatic variables, which are those declared within a function, and static variables, which are defined outside a function or with the keyword `static`, are less flexible. An automatic variable comes into being

when the block containing it (typically a function definition) is entered, and it expires when the block is left. A static variable persists for the duration of a program.

The Standard Template Library (STL), added by the C++98 standard, provides a vector template class that provides an alternative to do-it-yourself dynamic arrays. C++11 provides an array template class that offers an alternative to fixed-sized built-in arrays.

## Chapter Review

- How would you declare each of the following?
  - `actors` is an array of 30 `char`.
  - `betsie` is an array of 100 `short`.
  - `chuck` is an array of 13 `float`.
  - `dipsea` is an array of 64 `long double`.
- Does Chapter Review Question 1 use the array template class instead of built-in arrays.
- Declare an array of five `ints` and initialize it to the first five odd positive integers.
- Write a statement that assigns the sum of the first and last elements of the array in Question 3 to the variable `even`.
- Write a statement that displays the value of the second element in the `float` array `ideas`.
- Declare an array of `char` and initialize it to the string "cheeseburger".
- Declare a `string` object and initialize it to the string "Waldorf Salad".
- Devise a structure declaration that describes a fish. The structure should include the kind, the weight in whole ounces, and the length in fractional inches.
- Declare a variable of the type defined in Question 8 and initialize it.
- Use `enum` to define a type called `Response` with the possible values `Yes`, `No`, and `Maybe`. `Yes` should be 1, `No` should be 0, and `Maybe` should be 2.
- Suppose `ted` is a `double` variable. Declare a pointer that points to `ted` and use the pointer to display `ted`'s value.
- Suppose `treacle` is an array of 10 `floats`. Declare a pointer that points to the first element of `treacle` and use the pointer to display the first and last elements of the array.
- Write a code fragment that asks the user to enter a positive integer and then creates a dynamic array of that many `ints`. Do this by using `new`, then again using a vector object.

14. Is the following valid code? If so, what does it print?
- ```
cout << (int *) "Home of the jolly bytes";
```
15. Write a code fragment that dynamically allocates a structure of the type described in Question 8 and then reads a value for the `kind` member of the structure.
16. Listing 4.6 illustrates a problem created by following numeric input with line-oriented string input. How would replacing this:
- ```
cin.getline(address,80);
```
- with this:
- ```
cin >> address;
```
- affect the working of this program?
17. Declare a `vector` object of 10 `string` objects and an `array` object of 10 `string` objects. Show the necessary header files and don't use `using`. Do use a `const` for the number of strings.

## Programming Exercises

1. Write a C++ program that requests and displays information as shown in the following example of output:

```
What is your first name? Betty Sue
What is your last name? Yewe
What letter grade do you deserve? B
What is your age? 22
Name: Yewe, Betty Sue
Grade: C
Age: 22
```

Note that the program should be able to accept first names that comprise more than one word. Also note that the program adjusts the grade downward—that is, up one letter. Assume that the user requests an A, a B, or a C so that you don't have to worry about the gap between a D and an F.

2. Rewrite Listing 4.4, using the C++ `string` class instead of `char` arrays.
3. Write a program that asks the user to enter his or her first name and then last name, and that then constructs, stores, and displays a third string, consisting of the user's last name followed by a comma, a space, and first name. Use `char` arrays and functions from the `cstring` header file. A sample run could look like this:

```
Enter your first name: Flip
Enter your last name: Fleming
Here's the information in a single string: Fleming, Flip
```

4. Write a program that asks the user to enter his or her first name and then last name, and that then constructs, stores, and displays a third string consisting of the user's last name followed by a comma, a space, and first name. Use `string` objects and methods from the `string` header file. A sample run could look like this:

```
Enter your first name: Flip
```

```
Enter your last name: Fleming
```

```
Here's the information in a single string: Fleming, Flip
```

5. The `CandyBar` structure contains three members. The first member holds the brand name of a candy bar. The second member holds the weight (which may have a fractional part) of the candy bar, and the third member holds the number of calories (an integer value) in the candy bar. Write a program that declares such a structure and creates a `CandyBar` variable called `snack`, initializing its members to "Mocha Munch", 2.3, and 350, respectively. The initialization should be part of the declaration for `snack`. Finally, the program should display the contents of the `snack` variable.
6. The `CandyBar` structure contains three members, as described in Programming Exercise 5. Write a program that creates an array of three `CandyBar` structures, initializes them to values of your choice, and then displays the contents of each structure.
7. William Wingate runs a pizza-analysis service. For each pizza, he needs to record the following information:
- The name of the pizza company, which can consist of more than one word
  - The diameter of the pizza
  - The weight of the pizza

Devise a structure that can hold this information and write a program that uses a structure variable of that type. The program should ask the user to enter each of the preceding items of information, and then the program should display that information. Use `cin` (or its methods) and `cout`.

8. Do Programming Exercise 7 but use `new` to allocate a structure instead of declaring a structure variable. Also have the program request the pizza diameter before it requests the pizza company name.
9. Do Programming Exercise 6, but instead of declaring an array of three `CandyBar` structures, use `new` to allocate the array dynamically.
10. Write a program that requests the user to enter three times for the 40-yd dash (or 40-meter, if you prefer) and then displays the times and the average. Use an array object to hold the data. (Use a built-in array if `array` is not available.)



*This page intentionally left blank*

# Loops and Relational Expressions

In this chapter you'll learn about the following:

- The `for` loop
- Expressions and statements
- The increment and decrement operators: `++` and `--`
- Combination assignment operators
- Compound statements (blocks)
- The comma operator
- Relational operators: `>`, `>=`, `==`, `<=`, `<`, and `!=`
- The `while` loop
- The `typedef` facility
- The `do while` loop
- The `get ()` character input method
- The end-of-file condition
- Nested loops and two-dimensional arrays

Computers do more than store data. They analyze, consolidate, rearrange, extract, modify, extrapolate, synthesize, and otherwise manipulate data. Sometimes they even distort and trash data, but we'll try to steer clear of that kind of behavior. To perform their manipulative miracles, programs need tools for performing repetitive actions and for making decisions. Of course, C++ provides such tools. Indeed, it uses the same `for` loops, `while` loops, `do while` loops, `if` statements, and `switch` statements that regular C employs, so if you know C, you can zip through this chapter and Chapter 6, "Branching Statements and Logical Operators." (But don't zip too fast—you don't want to miss how `cin` handles character input!) These various program control statements often use relational expressions and logical expressions to govern their behavior. This chapter discusses

loops and relational expressions, and Chapter 6 follows up with branching statements and logical expressions.

## Introducing for Loops

Circumstances often call on a program to perform repetitive tasks, such as adding together the elements of an array one by one or printing some paean to productivity 20 times. The C++ `for` loop makes such tasks easy to do. Let's look at a loop in Listing 5.1, see what it does, and then discuss how it works.

Listing 5.1 `forloop.cpp`

---

```
// forloop.cpp -- introducing the for loop
#include <iostream>
int main()
{
    using namespace std;
    int i; // create a counter
    // initialize; test ; update
    for (i = 0; i < 5; i++)
        cout << "C++ knows loops.\n";
    cout << "C++ knows when to stop.\n";
    return 0;
}
```

---

Here is the output from the program in Listing 5.1:

```
C++ knows loops.
C++ knows loops.
C++ knows loops.
C++ knows loops.
C++ knows loops.
C++ knows when to stop.
```

This loop begins by setting the integer `i` to 0:

```
i = 0
```

This is the *loop initialization* part of the loop. Then in the *loop test*, the program tests whether `i` is less than 5:

```
i < 5
```

If it is, the program executes the following statement, which is termed the *loop body*:

```
cout << "C++ knows loops.\n";
```

Then the program uses the *loop update* part of the loop to increase `i` by 1:

```
i++
```

The *loop update* part of the loop uses the ++ operator, called the *increment operator*. It increments the value of its operand by 1. (The increment operator is not restricted to for loops. For example, you can use `i++`; instead of `i = i + 1`; as a statement in a program.) Incrementing `i` completes the first cycle of the loop.

Next, the loop begins a new cycle by comparing the new `i` value with 5. Because the new value (1) is also less than 5, the loop prints another line and then finishes by incrementing `i` again. That sets the stage for a fresh cycle of testing, executing a statement, and updating the value of `i`. The process continues until the loop updates `i` to 5. Then the next test fails, and the program moves on to the next statement after the loop.

## Parts of a for Loop

A for loop provides a step-by-step recipe for performing repeated actions. Let's take a more detailed look at how it's set up. The usual parts of a for loop handle these steps:

1. Setting a value initially
2. Performing a test to see whether the loop should continue
3. Executing the loop actions
4. Updating value(s) used for the test

The C++ loop design positions these elements so that you can spot them at a glance. The initialization, test, and update actions constitute a three-part control section enclosed in parentheses. Each part is an expression, and semicolons separate the expressions from each other. The statement following the control section is called the *body* of the loop, and it is executed as long as the test expression remains true:

```
for (initialization; test-expression; update-expression)  
    body
```

C++ syntax counts a complete for statement as a single statement, even though it can incorporate one or more statements in the body portion. (Having more than one statement requires using a compound statement, or block, as discussed later in this chapter.)

The loop performs initialization just once. Typically, programs use this expression to set a variable to a starting value and then use the variable to count loop cycles.

*test-expression* determines whether the loop body gets executed. Typically, this expression is a relational expression—that is, one that compares two values. Our example compares the value of `i` to 5, checking whether `i` is less than 5. If the comparison is true, the program executes the loop body. Actually, C++ doesn't limit *test-expression* to true/false comparisons. You can use any expression, and C++ will type cast it to type `bool`. Thus, an expression with a value of 0 is converted to the `bool` value `false`, and the loop terminates. If the expression evaluates to nonzero, it is type cast to the `bool` value `true`, and the loop continues. Listing 5.2 demonstrates this by using the expression `i` as the test condition. (In the update section, `i--` is similar to `i++` except that it decreases the value of `i` by 1 each time it's used.)

Listing 5.2 `num_test.cpp`

---

```
// num_test.cpp -- use numeric test in for loop
#include <iostream>
int main()
{
    using namespace std;
    cout << "Enter the starting countdown value: ";
    int limit;
    cin >> limit;
    int i;
    for (i = limit; i; i--)    // quits when i is 0
        cout << "i = " << i << "\n";
    cout << "Done now that i = " << i << "\n";
    return 0;
}

```

---

Here is the output from the program in Listing 5.2:

```
Enter the starting countdown value: 4
i = 4
i = 3
i = 2
i = 1
Done now that i = 0
```

Note that the loop terminates when *i* reaches 0.

How do relational expressions, such as `i < 5`, fit into this framework of terminating a loop with a 0 value? Before the `bool` type was introduced, relational expressions evaluated to 1 if true and 0 if false. Thus, the value of the expression `3 < 5` was 1, and the value of `5 < 5` was 0. Now that C++ has added the `bool` type, however, relational expressions evaluate to the `bool` literals `true` and `false` instead of 1 and 0. This change doesn't lead to incompatibilities, however, because a C++ program converts `true` and `false` to 1 and 0 where integer values are expected, and it converts 0 to `false` and nonzero to `true` where `bool` values are expected.

The `for` loop is an *entry-condition* loop. This means the test expression is evaluated *before* each loop cycle. The loop never executes the loop body when the test expression is false. For example, suppose you rerun the program in Listing 5.2 but give 0 as a starting value. Because the test condition fails the very first time it's evaluated, the loop body never gets executed:

```
Enter the starting countdown value: 0
Done now that i = 0
```

This look-before-you-loop attitude can help keep a program out of trouble.

*update-expression* is evaluated at the end of the loop, after the body has been executed. Typically, it's used to increase or decrease the value of the variable keeping track of

the number of loop cycles. However, it can be any valid C++ expression, as can the other control expressions. This makes the `for` loop capable of much more than simply counting from 0 to 5, the way the first loop example does. You'll see some examples of this later.

The `for` loop body consists of a single statement, but you'll soon learn how to stretch that rule. Figure 5.1 summarizes the `for` loop design.

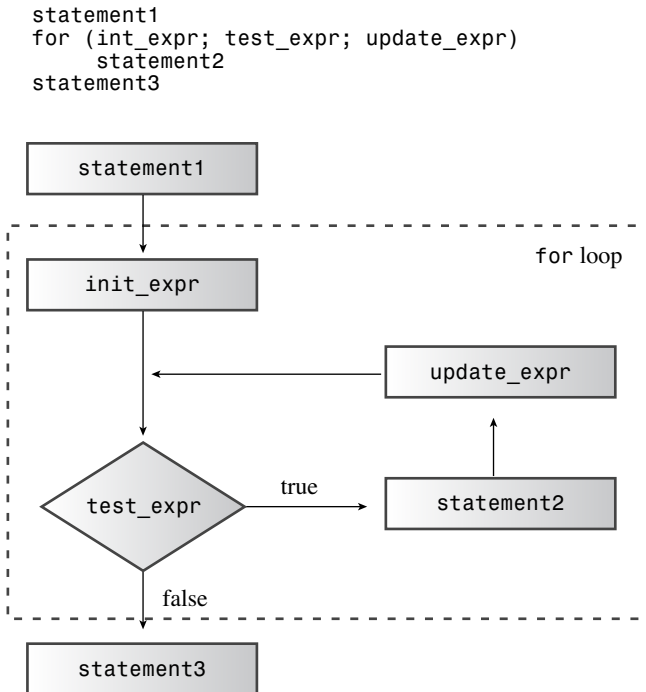

Figure 5.1 The design of `for` loops.

A `for` statement looks something like a function call because it uses a name followed by paired parentheses. However, `for`'s status as a C++ keyword prevents the compiler from thinking `for` is a function. It also prevents you from naming a function `for`.

### Tip

Common C++ style is to place a space between `for` and the following parenthesis and to omit space between a function name and the following parenthesis:

```

for (i = 6; i < 10; i++)
    smart_function(i);
  
```

Other control statements, such as `if` and `while`, are treated similarly to `for`. This serves to visually reinforce the distinction between a control statement and a function call. Also common practice is to indent the body of a `for` statement to make it stand out visually.

### Expressions and Statements

A `for` control section uses three expressions. Within its self-imposed limits of syntax, C++ is a very expressive language. Any value or any valid combination of values and operators constitute an expression. For example, `10` is an expression with the value 10 (no surprise), and `28 * 20` is an expression with the value 560. In C++ every expression has a value. Often the value is obvious. For example, the following expression is formed from two values and the addition operator, and it has the value 49:

```
22 + 27
```

Sometimes the value is less obvious. For example, the following is an expression because it's formed from two values and the assignment operator:

```
x = 20
```

C++ defines the value of an assignment expression to be the value of the member on the left, so the expression has the value 20. The fact that assignment expressions have values permits statements such as the following:

```
maids = (cooks = 4) + 3;
```

The expression `cooks = 4` has the value 4, so `maids` is assigned the value 7. However, just because C++ permits this behavior doesn't mean you should encourage it. But the same rule that makes this peculiar statement possible also makes the following useful statement possible:

```
x = y = z = 0;
```

This is a fast way to set several variables to the same value. The precedence table (see Appendix D, "Operator Precedence") reveals that assignment associates right-to-left, so first `0` is assigned to `z`, and then `z = 0` is assigned to `y`, and so on.

Finally, as mentioned previously, relational expressions such as `x < y` evaluate to the `bool` values `true` or `false`. The short program in Listing 5.3 illustrates some points about expression values. The `<<` operator has higher precedence than the operators used in the expressions, so the code uses parentheses to enforce the correct order.

#### Listing 5.3 `express.cpp`

---

```
// express.cpp -- values of expressions
#include <iostream>
int main()
{
    using namespace std;
    int x;

    cout << "The expression x = 100 has the value ";
```

```
cout << (x = 100) << endl;
cout << "Now x = " << x << endl;
cout << "The expression x < 3 has the value ";
cout << (x < 3) << endl;
cout << "The expression x > 3 has the value ";
cout << (x > 3) << endl;
cout.setf(ios_base::boolalpha); //a newer C++ feature
cout << "The expression x < 3 has the value ";
cout << (x < 3) << endl;
cout << "The expression x > 3 has the value ";
cout << (x > 3) << endl;
return 0;
}
```

---

Here is the output from the program in Listing 5.3:

```
The expression x = 100 has the value 100
Now x = 100
The expression x < 3 has the value 0
The expression x > 3 has the value 1
The expression x < 3 has the value false
The expression x > 3 has the value true
```

Normally, `cout` converts `bool` values to `int` before displaying them, but the `cout.setf(ios::boolalpha)` function call sets a flag that instructs `cout` to display the words `true` and `false` instead of `1` and `0`.

### Note

A C++ expression is a value or a combination of values and operators, and every C++ expression has a value.

To evaluate the expression `x = 100`, C++ must assign the value `100` to `x`. When the very act of evaluating an expression changes the value of data in memory, we say the evaluation has a *side effect*. Thus, evaluating an assignment expression has the side effect of changing the assignee's value. You might think of assignment as the intended effect, but from the standpoint of how C++ is constructed, evaluating the expression is the primary effect. Not all expressions have side effects. For example, evaluating `x + 15` calculates a new value, but it doesn't change the value of `x`. But evaluating `++x + 15` does have a side effect because it involves incrementing `x`.

From expression to statement is a short step; you just add a semicolon. Thus, the following is an expression:

```
age = 100
```

Whereas the following is a statement:

```
age = 100;
```



More particularly, it is an *expression statement*. Any expression can become a statement if you add a semicolon, but the result might not make programming sense. For example, if `rodents` is a variable, then the following is a valid C++ statement:

```
rodents + 6;    // valid, but useless, statement
```

The compiler allows it, but the statement doesn't accomplish anything useful. The program merely calculates the sum, does nothing with it, and goes on to the next statement. (A smart compiler might even skip the statement.)

### Nonexpressions and Statements

Some concepts, such as knowing the structure of a `for` loop, are crucial to understanding C++. But there are also relatively minor aspects of syntax that can suddenly bedevil you just when you think you understand the language. We'll look at a couple of them now.

Although it is true that adding a semicolon to any expression makes it a statement, the reverse is not true. That is, removing a semicolon from a statement does not necessarily convert it to an expression. Of the kinds of statements we've used so far, return statements, declaration statements, and `for` statements don't fit the *statement = expression + semicolon* mold. For example, this is a statement:

```
int toad;
```

But the fragment `int toad` is not an expression and does not have a value. This makes code such as the following invalid:

```
eggs = int toad * 1000;    // invalid, not an expression
cin >> int toad;          // can't combine declaration with cin
```

Similarly, you can't assign a `for` loop to a variable. In the following example, the `for` loop is not an expression, so it has no value and you can't assign it:

```
int fx = for (i = 0; i < 4; i++)
    cout >> i;    // not possible
```

### Bending the Rules

C++ adds a feature to C loops that requires some artful adjustments to the `for` loop syntax. This was the original syntax:

```
for (expression; expression; expression)
    statement
```

In particular, the control section of a `for` structure consisted of three expressions, as defined earlier in this chapter, separated by semicolons. C++ loops allow you to do things like the following, however:

```
for (int i = 0; i < 5; i++)
```

That is, you can declare a variable in the initialization area of a `for` loop. This can be convenient, but it doesn't fit the original syntax because a declaration is not an expression. This once outlawed behavior was originally accommodated by defining a new kind of

expression, the *declaration-statement expression*, which was a declaration stripped of the semicolon, and which could appear only in a `for` statement. That adjustment has been dropped, however. Instead, the syntax for the `for` statement has been modified to the following:

```
for (for-init-statement condition; expression)
    statement
```

At first glance, this looks odd because there is just one semicolon instead of two. But that's okay because *for-init-statement* is identified as a statement, and a statement has its own semicolon. As for *for-init-statement*, it's identified as either an expression-statement or a declaration. This syntax rule replaces an expression followed by a semicolon with a statement, which has its own semicolon. What this boils down to is that C++ programmers want to be able to declare and initialize a variable in a `for` loop initialization, and they'll do whatever is necessary to C++ syntax and to the English language to make it possible.

There's a practical aspect to declaring a variable in *for-init-statement* that you should know about. Such a variable exists only within the `for` statement. That is, after the program leaves the loop, the variable is eliminated:

```
for (int i = 0; i < 5; i++)
    cout << "C++ knows loops.\n";
cout << i << endl; // oops! i no longer defined
```

Another thing you should know is that some older C++ implementations follow an earlier rule and treat the preceding loop as if `i` were declared *before* the loop, thus making it available after the loop terminates.

## Back to the for Loop

Let's be a bit more ambitious with loops. Listing 5.4 uses a loop to calculate and store the first 16 factorials. Factorials, which are handy for computing odds, are calculated the following way. Zero factorial, written as  $0!$ , is defined to be 1. Then,  $1!$  is  $1 * 0!$ , or 1. Next,  $2!$  is  $2 * 1!$ , or 2. Then,  $3!$  is  $3 * 2!$ , or 6, and so on, with the factorial of each integer being the product of that integer with the preceding factorial. (One of the late pianist-comedian Victor Borge's best-known monologues featured phonetic punctuation, in which the exclamation mark is pronounced something like phffff pptz, with a moist accent. However, in this case, "!" is pronounced "factorial.") The program uses one loop to calculate the values of successive factorials, storing them in an array. Then it uses a second loop to display the results. Also the program introduces the use of external declarations for values.

### Listing 5.4 `formore.cpp`

---

```
// formore.cpp -- more looping with for
#include <iostream>
const int ArSize = 16; // example of external declaration
int main()
{
    long long factorials[ArSize];
```

```

    factorials[1] = factorials[0] = 1LL;
    for (int i = 2; i < ArSize; i++)
        factorials[i] = i * factorials[i-1];
    for (int i = 0; i < ArSize; i++)
        std::cout << i << "!" << " = " << factorials[i] << std::endl;
    return 0;
}

```

---

Here is the output from the program in Listing 5.4:

```

0! = 1
1! = 1
2! = 2
3! = 6
4! = 24
5! = 120
6! = 720
7! = 5040
8! = 40320
9! = 362880
10! = 3628800
11! = 39916800
12! = 479001600
13! = 6227020800
14! = 87178291200
15! = 1307674368000

```

Factorials get big fast!

### Note

This listing uses the `long long` type. If your system doesn't have that type available, you can use `double`. However, the integer format gives a nicer visual representation of how the numbers grow larger.

### Program Notes

The program in Listing 5.4 creates an array to hold the factorial values. Element 0 is 0!, element 1 is 1!, and so on. Because the first two factorials equal 1, the program sets the first two elements of the `factorials` array to 1.0. (Remember, the first element of an array has an index value of 0.) After that, the program uses a loop to set each factorial to the product of the index with the previous factorial. The loop illustrates that you can use the loop counter as a variable in the body of the loop.

The program in Listing 5.4 demonstrates how the `for` loop works hand-in-hand with arrays by providing a convenient means to access each array member in turn. Also `formore.cpp` uses `const` to create a symbolic representation (`ArSize`) for the array size. Then it uses `ArSize` wherever the array size comes into play, such as in the array

definition and in the limits for the loops handling the array. Now, if you wish to extend the program to, say, 20 factorials, you just have to set `ArSize` to 20 in the program and recompile. By using a symbolic constant, you avoid having to change every occurrence of 16 to 20 individually.

### Tip

It's usually a good idea to define a `const` value to represent the number of elements in an array. You can use the `const` value in the array declaration and in all other references to the array size, such as in a `for` loop.

The limit expression `i < ArSize` reflects the fact that subscripts for an array with `ArSize` elements run from 0 to `ArSize - 1`, so the array index should stop one short of `ArSize`. You could use the test `i <= ArSize - 1` instead, but it looks awkward in comparison.

Note that the program declares the `const int` variable `ArSize` outside the body of `main()`. As the end of Chapter 4, "Compound Types," mentions, this makes `ArSize` external data. The two consequences of declaring `ArSize` in this fashion are that `ArSize` exists for the duration of the program and that all functions in the program file can use it. In this particular case, the program has just one function, so declaring `ArSize` externally has little practical effect. But multifunction programs often benefit from sharing external constants, so we'll practice using them next.

Also this example reminds us that we can use `std::` instead of a `using` directive to make selected standard names available.

## Changing the Step Size

So far the loop examples in this chapter have increased or decreased the loop counter by one in each cycle. You can change that by changing the update expression. The program in Listing 5.5, for example, increases the loop counter by a user-selected step size. Rather than use `i++` as the update expression, it uses the expression `i = i + by`, where `by` is the user-selected step size.

Listing 5.5 `bigstep.cpp`

---

```
// bigstep.cpp -- count as directed
#include <iostream>
int main()
{
    using std::cout;    // a using declaration
    using std::cin;
    using std::endl;
    cout << "Enter an integer: ";
    int by;
```

```

    cin >> by;
    cout << "Counting by " << by << "s:\n";
    for (int i = 0; i < 100; i = i + by)
        cout << i << endl;
    return 0;
}

```

---

Here is a sample run of the program in Listing 5.5:

```

Enter an integer: 17
Counting by 17s:
0
17
34
51
68
85

```

When `i` reaches the value 102, the loop quits. The main point here is that the update expression can be any valid expression. For example, if you want to square `i` and add 10 in each cycle, you can use `i = i * i + 10`.

Another point to note is that it often is a better idea to test for inequality than equality. For example, the test `i == 100` would have failed in this case because `i` skips over the value 100.

Finally, this example illustrates the use of `using` declarations instead of a `using` directive.

## Inside Strings with the `for` Loop

The `for` loop provides a direct way to access each character in a string in turn. For example, Listing 5.6 enables you to enter a string and then displays the string character-by-character, in reverse order. You could use either a `string` class object or an array of `char` in this example because both allow you to use array notation to access individual characters in a string; Listing 5.6 uses a `string` class object. The `string` class `size()` method yields the number of characters in the string; the loop uses that value in its initializing expression to set `i` to the index of the last character in the string, not counting the null character. To count backward, the program uses the decrement operator (`--`) to decrease the array subscript by one in each loop. Also Listing 5.6 uses the greater-than-or-equal-to relational operator (`>=`) to test whether the loop has reached the first element. We'll summarize all the relational operators soon.

### Listing 5.6 `forstr1.cpp`

---

```

// forstr1.cpp -- using for with a string
#include <iostream>
#include <string>
int main()
{

```

```
using namespace std;
cout << "Enter a word: ";
string word;
cin >> word;

// display letters in reverse order
for (int i = word.size() - 1; i >= 0; i--)
    cout << word[i];
cout << "\nBye.\n";
return 0;
}
```

---

Here is a sample run of the program in Listing 5.6:

```
Enter a word: animal
lamina
Bye.
```

Yes, the program succeeds in printing `animal` backward; choosing `animal` as a test word more clearly illustrates the effect of this program than choosing, say, a palindrome such as `rotator`, `redder`, or `stats`.

## The Increment (++) and Decrement (--) Operators

C++ features several operators that are frequently used in loops; let's take a little time to examine them now. You've already seen two: the increment operator (`++`), which inspired the name C++, and the decrement operator (`--`). These operators perform two exceedingly common loop operations: increasing and decreasing a loop counter by one. However, there's more to their story than you've seen to this point. Each operator comes in two varieties. The *prefix* version comes before the operand, as in `++x`. The *postfix* version comes after the operand, as in `x++`. The two versions have the same effect on the operand, but they differ in terms of when they take place. It's like getting paid for mowing the lawn in advance or afterward; both methods have the same final effect on your wallet, but they differ in when the money gets added. Listing 5.7 demonstrates this difference for the increment operator.

### Listing 5.7 `plus_one.cpp`

---

```
// plus_one.cpp -- the increment operator
#include <iostream>
int main()
{

    using std::cout;
    int a = 20;
    int b = 20;
```

```

cout << "a  = " << a << ":  b = " << b << "\n";
cout << "a++ = " << a++ << ": ++b = " << ++b << "\n";
cout << "a  = " << a << ":  b = " << b << "\n";
return 0;
}

```

---

Here is the output from the program in Listing 5.7:

```

a      = 20:  b = 20
a++    = 20: ++b = 21
a      = 21:  b = 21

```

Roughly speaking, the notation `a++` means “use the current value of `a` in evaluating an expression, and then increment the value of `a`.” Similarly, the notation `++b` means “first increment the value of `b` and then use the new value in evaluating the expression.” For example, we have the following relationships:

```

int x = 5;
int y = ++x;      // change x, then assign to y
                  // y is 6, x is 6

int z = 5;
int y = z++;      // assign to y, then change z
                  // y is 5, z is 6

```

Using the increment and decrement operators is a concise, convenient way to handle the common task of increasing or decreasing values by one.

The increment and decrement operators are nifty little operators, but don’t get carried away and increment or decrement the same value more than once in the same statement. The problem is that the use-then-change and change-then-use rules can become ambiguous. That is, a statement such as the following can produce quite different results on different systems:

```

x = 2 * x++ * (3 - ++x);    // don't do it except as an experiment

```

C++ does not define correct behavior for this sort of statement.

## Side Effects and Sequence Points

Let’s take a closer look at what C++ does and doesn’t say about when increment operators take effect. First, recall that a *side effect* is an effect that occurs when evaluating an expression modifies something, such as a value stored in a variable. A *sequence point* is a point in program execution at which all side effects are guaranteed to be evaluated before going on to the next step. In C++ the semicolon in a statement marks a sequence point. That means all changes made by assignment operators, increment operators, and decrement operators in a statement must take place before a program proceeds to the next statement. Some operators that we’ll discuss in later chapters have sequence points. Also the end of any full expression is a sequence point.

What's a full expression? It's an expression that's not a subexpression of a larger expression. Examples of full expressions include an expression portion of an expression statement and an expression that serves as a test condition for a `while` loop.

Sequence points help clarify when postfix incrementation takes place. Consider, for instance, the following code:

```
while (guests++ < 10)
    cout << guests << endl;
```

(The `while` loop, discussed later this chapter, works like a `for` loop that has just a test expression.) Sometimes C++ newcomers assume that “use the value, then increment it” means, in this context, to increment `guests` after it's used in the `cout` statement. However, the `guests++ < 10` expression is a full expression because it is a `while` loop test condition, so the end of this expression is a sequence point. Therefore, C++ guarantees that the side effect (incrementing `guests`) takes place before the program moves on to `cout`. Using the postfix form, however, guarantees that `guests` will be incremented after the comparison to 10 is made.

Now consider this statement:

```
y = (4 + x++) + (6 + x++);
```

The expression `4 + x++` is not a full expression, so C++ does not guarantee that `x` will be incremented immediately after the subexpression `4 + x++` is evaluated. Here the full expression is the entire assignment statement, and the semicolon marks the sequence point, so all that C++ guarantees is that `x` will have been incremented twice by the time the program moves to the following statement. C++ does not specify whether `x` is incremented after each subexpression is evaluated or only after all the expressions have been evaluated, which is why you should avoid statements of this kind.

C++11 documentation has dropped the term “sequence point” because the concept doesn't carry over well when discussing multiple threads of execution. Instead, descriptions are framed in terms of sequencing, with some events being described as being sequenced before other events. This descriptive approach isn't intended to change the rules; the goal is to provide language that can more clearly handle multithreaded programming.

## Prefixing Versus Postfixing

Clearly, whether you use the prefix or postfix form makes a difference if the value is used for some purpose, such as a function argument or assigning to a variable. But what if the value of an increment or decrement expression isn't used? For example, are

```
x++;
```

and

```
++x;
```

different from one another? Or are

```
for (n = lim; n > 0; --n)
```



```

    ...;
and
for (n = lim; n > 0; n--)
    ...;

```

different from one another?

Logically, whether the prefix or postfix forms are used makes no difference in these two situations. The values of the expressions aren't used, so the only effects are the side effects. Here the expressions using the operators are full expressions, so the side effects of incrementing *x* and decrementing *n* are guaranteed to be performed by the time the program moves on to the next step; the prefix form and postfix form lead to the same final result.

However, although the choice between prefix and postfix forms has no effect on the program's behavior, it is possible for the choice to have a small effect on execution speed. For built-in types and modern compilers, this seems to be a non issue. But C++ lets you define these operators for classes. In that case, the user defines a prefix function that works by incrementing a value and then returning it. But the postfix version works by first stashing a copy of the value, incrementing the value, and then returning the stashed copy. Thus, for classes, the prefix version is a bit more efficient than the postfix version.

In short, for built-in types, it most likely makes no difference which form you use. For user-defined types having user-defined increment and decrement operators, the prefix form is more efficient.

## The Increment/Decrement Operators and Pointers

You can use increment operators with pointers as well as with basic variables. Recall that adding an increment operator to a pointer increases its value by the number of bytes in the type it points to. The same rule holds for incrementing and decrementing pointers:

```

double arr[5] = {21.1, 32.8, 23.4, 45.2, 37.4};
double *pt = arr; // pt points to arr[0], i.e. to 21.1
++pt;           // pt points to arr[1], i.e. to 32.8

```

You can also use these operators to change the quantity a pointer points to by using them in conjunction with the `*` operator. Applying both `*` and `++` to a pointer raises the questions of what gets dereferenced and what gets incremented. Those actions are determined by the placement and precedence of the operators. The prefix increment, prefix decrement, and dereferencing operators all have the same precedence and associate from right to left. The postfix increment and decrement operators both have the same precedence, which is higher than the prefix precedence. These two operators associate from left to right.

The right-to-left association rule for prefix operators implies that `*++pt` means first apply `++` to `pt` (because the `++` is to the right of the `*`) and then apply `*` to the new value of `pt`:

```

double x = *++pt; // increment pointer, take the value; i.e., arr[2], or 23.4

```

On the other hand, `++*pt` means obtain the value that `pt` points to and then increment that value:

```
++*pt;           // increment the pointed to value; i.e., change 23.4 to 24.4
```

Here, `pt` remains pointing to `arr[2]`.

Next, consider this combination:

```
(*pt)++;       // increment pointed-to value
```

The parentheses indicate that first the pointer is dereferenced, yielding 24.4. Then the `++` operator increments that value to 25.4; `pt` remains pointing at `arr[2]`.

Finally, consider this combination:

```
x = *pt++;      // dereference original location, then increment pointer
```

The higher precedence of the postfix `++` operator means the `++` operator operates on `pt`, not on `*pt`, so the pointer is incremented. But the fact that the postfix operator is used means that the address that gets dereferenced is the original address, `&arr[2]`, not the new address. Thus, the value of `*pt++` is `arr[2]`, or 25.4, but the value of `pt` after the statement completes is the address of `arr[3]`.

### Note

Incrementing and decrementing pointers follow pointer arithmetic rules. Thus, if `pt` points to the first member of an array, `++pt` changes `pt` so that it points to the second member.

## Combination Assignment Operators

Listing 5.5 uses the following expression to update a loop counter:

```
i = i + by
```

C++ has a combined addition and assignment operator that accomplishes the same result more concisely:

```
i += by
```

The `+=` operator adds the values of its two operands and assigns the result to the operand on the left. This implies that the left operand must be something to which you can assign a value, such as a variable, an array element, a structure member, or data you identify by dereferencing a pointer:

```
int k = 5;
k += 3;           // ok, k set to 8
int *pa = new int[10]; // pa points to pa[0]
pa[4] = 12;
pa[4] += 6;       // ok, pa[4] set to 18
*(pa + 4) += 7;   // ok, pa[4] set to 25
pa += 2;          // ok, pa points to the former pa[2]
34 += 10;         // quite wrong
```

Each arithmetic operator has a corresponding assignment operator, as summarized in Table 5.1. Each operator works analogously to `+=`. Thus, for example, the following statement replaces the current value of `k` with a value 10 times greater:

```
k *= 10;
```

Table 5.1 Combined Assignment Operators

| Operator        | Effect (L=left operand, R=right operand)     |
|-----------------|----------------------------------------------|
| <code>+=</code> | Assigns <code>L + R</code> to <code>L</code> |
| <code>-=</code> | Assigns <code>L - R</code> to <code>L</code> |
| <code>*=</code> | Assigns <code>L * R</code> to <code>L</code> |
| <code>/=</code> | Assigns <code>L / R</code> to <code>L</code> |
| <code>%=</code> | Assigns <code>L % R</code> to <code>L</code> |

## Compound Statements, or Blocks

The format, or syntax, for writing a C++ `for` statement might seem restrictive to you because the body of the loop must be a single statement. That's awkward if you want the loop body to contain several statements. Fortunately, C++ provides a syntax loophole through which you may stuff as many statements as you like into a loop body. The trick is to use paired braces to construct a *compound statement*, or *block*. The block consists of paired braces and the statements they enclose and, for the purposes of syntax, counts as a single statement. For example, the program in Listing 5.8 uses braces to combine three separate statements into a single block. This enables the body of the loop to prompt the user, read input, and do a calculation. The program calculates the running sum of the numbers you enter, and this provides a natural occasion for using the `+=` operator.

Listing 5.8 `block.cpp`

```
// block.cpp -- use a block statement
#include <iostream>
int main()
{
    using namespace std;
    cout << "The Amazing Accounto will sum and average ";
    cout << "five numbers for you.\n";
    cout << "Please enter five values:\n";
    double number;
    double sum = 0.0;
    for (int i = 1; i <= 5; i++)
    {
        cout << "Value " << i << ": ";
        cin >> number;
        sum += number;
    }
}
```

```

cout << "Five exquisite choices indeed! ";
cout << "They sum to " << sum << endl;
cout << "and average to " << sum / 5 << ".\n";
cout << "The Amazing Accounto bids you adieu!\n";
return 0;
}

```

---

Here is a sample run of the program in Listing 5.8:

```

The Amazing Accounto will sum and average five numbers for you.
Please enter five values:
Value 1: 1942
Value 2: 1948
Value 3: 1957
Value 4: 1974
Value 5: 1980
Five exquisite choices indeed! They sum to 9801
and average to 1960.2.
The Amazing Accounto bids you adieu!

```

Suppose you leave in the indentation but omit the braces:

```

for (int i = 1; i <= 5; i++)
    cout << "Value " << i << ": ";    // loop ends here
    cin >> number;                    // after the loop
    sum += number;
cout << "Five exquisite choices indeed! ";

```

The compiler ignores indentation, so only the first statement would be in the loop. Thus, the loop would print the five prompts and do nothing more. After the loop completes, the program moves to the following lines, reading and summing just one number.

Compound statements have another interesting property. If you define a new variable inside a block, the variable persists only as long as the program is executing statements within the block. When execution leaves the block, the variable is deallocated. That means the variable is known only within the block:

```

#include <iostream>
int main()
{
    using namespace std;
    int x = 20;
    {
        int y = 100;                // block starts
        cout << x << endl;           // ok
        cout << y << endl;           // ok
    }                                // block ends
    cout << x << endl;               // ok
    cout << y << endl;               // invalid, won't compile
    return 0;
}

```

Note that a variable defined in an outer block is still defined in the inner block.

What happens if you declare a variable in a block that has the same name as one outside the block? The new variable hides the old one from its point of appearance until the end of the block. Then the old one becomes visible again, as in this example:

```
#include <iostream>
int main()
{
    using std::cout;
    using std::endl;
    int x = 20;           // original x
    {                   // block starts
        cout << x << endl; // use original x
        int x = 100;     // new x
        cout << x << endl; // use new x
    }                   // block ends
    cout << x << endl;    // use original x
    return 0;
}
```

## More Syntax Tricks—The Comma Operator

As you have seen, a block enables you to sneak two or more statements into a place where C++ syntax allows just one statement. The comma operator does the same for expressions, enabling you to sneak two expressions into a place where C++ syntax allows only one expression. For example, suppose you have a loop in which one variable increases by one each cycle and a second variable decreases by one each cycle. Doing both in the update part of a `for` loop control section would be convenient, but the loop syntax allows just one expression there. The solution is to use the comma operator to combine the two expressions into one:

```
++j, --i // two expressions count as one for syntax purposes
```

The comma is not always a comma operator. For example, the comma in this declaration serves to separate adjacent names in a list of variables:

```
int i, j; // comma is a separator here, not an operator
```

Listing 5.9 uses the comma operator twice in a program that reverses the contents of a `string` class object. (You could also write the program by using an array of `char`, but the length of the word would be limited by your choice of array size.) Note that Listing 5.6 displays the contents of an array in reverse order, but Listing 5.9 actually moves characters around in the array. The program in Listing 5.9 also uses a block to group several statements into one.

**Listing 5.9 forstr2.cpp**

---

```
// forstr2.cpp -- reversing an array
#include <iostream>
#include <string>
int main()
{
    using namespace std;
    cout << "Enter a word: ";
    string word;
    cin >> word;

    // physically modify string object
    char temp;
    int i, j;
    for (j = 0, i = word.size() - 1; j < i; --i, ++j)
    {
        // start block
        temp = word[i];
        word[i] = word[j];
        word[j] = temp;
    }
    // end block
    cout << word << "\nDone\n";
    return 0;
}
```

---

Here is a sample run of the program in Listing 5.9:

```
Enter a word: stressed
desserts
Done
```

By the way, the `string` class offers more concise ways to reverse a string, but we'll leave those for Chapter 16, "The `string` Class and the Standard Template Library."

**Program Notes**

Look at the `for` control section of the program in Listing 5.9. First, it uses the comma operator to squeeze two initializations into one expression for the first part of the control section. Then it uses the comma operator again to combine two updates into a single expression for the last part of the control section.

Next, look at the body. The program uses braces to combine several statements into a single unit. In the body, the program reverses the word by switching the first element of the array with the last element. Then it increments `j` and decrements `i` so that they now refer to the next-to-the-first element and the next-to-the-last element. After this is done, the program swaps those elements. Note that the test condition `j < i` makes the loop stop when it reaches the center of the array. If it were to continue past that point, it would begin swapping the switched elements back to their original positions (see Figure 5.2).

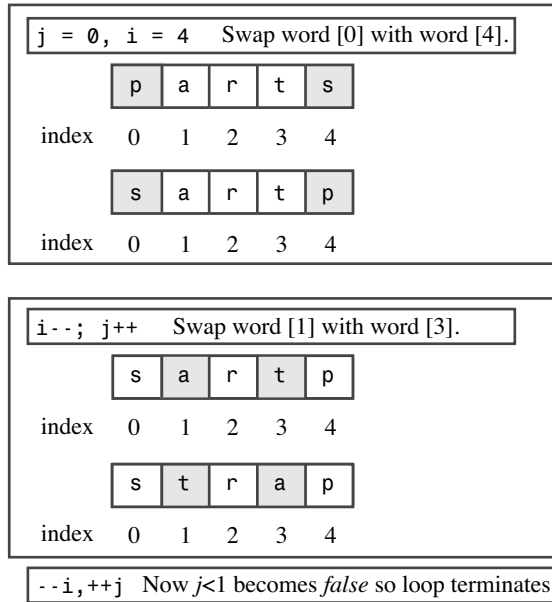

Figure 5.2 Reversing a string.

Another thing to note is the location for declaring the variables `temp`, `i`, and `j`. The code declares `i` and `j` before the loop because you can't combine two declarations with a comma operator. That's because declarations already use the comma for another purpose—separating items in a list. You can use a single declaration-statement expression to create and initialize two variables, but it's a bit confusing visually:

```
int j = 0, i = word.size() - 1;
```

In this case the comma is just a list separator, not the comma operator, so the expression declares and initializes both `j` and `i`. However, it looks as if it declares only `j`.

Incidentally, you can declare `temp` inside the `for` loop:

```
int temp = word[i];
```

This may result in `temp` being allocated and deallocated in each loop cycle. This might be a bit slower than declaring `temp` once before the loop. On the other hand, after the loop is finished, `temp` is discarded if it's declared inside the loop.

### Comma Operator Tidbits

By far the most common use for the comma operator is to fit two or more expressions into a single `for` loop expression. But C++ does provide the operator with two additional properties. First, it guarantees that the first expression is evaluated before the second

expression. (In other words, the comma operator is a sequence point.) Expressions such as the following are safe:

```
i = 20, j = 2 * i    // i set to 20, then j set to 40
```

Second, C++ states that the value of a comma expression is the value of the second part of the expression. The value of the preceding expression, for example, is 40 because that is the value of `j = 2 * i`.

The comma operator has the lowest precedence of any operator. For example, this statement:

```
cats = 17, 240;
```

gets read as this:

```
(cats = 17), 240;
```

That is, `cats` is set to 17, and 240 does nothing. But because parentheses have high precedence, the following results in `cats` being set to 240, the value of the expression on the right of the comma:

```
cats = (17, 240);
```

## Relational Expressions

Computers are more than relentless number crunchers. They have the capability to compare values, and this capability is the foundation of computer decision making. In C++ relational operators embody this ability. C++ provides six relational operators to compare numbers. Because characters are represented by their ASCII codes, you can use these operators with characters, too. They don't work with C-style strings, but they do work with `string` class objects. Each relational expression reduces to the `bool` value `true` if the comparison is true and to the `bool` value `false` if the comparison is false, so these operators are well suited for use in a loop test expression. (Older implementations evaluate true relational expressions to 1 and false relational expressions to 0.) Table 5.2 summarizes these operators.

Table 5.2 Relational Operators

| Operator              | Meaning                     |
|-----------------------|-----------------------------|
| <code>&lt;&lt;</code> | Is less than                |
| <code>&lt;=</code>    | Is less than or equal to    |
| <code>==</code>       | Is equal to                 |
| <code>&gt;</code>     | Is greater than             |
| <code>&gt;=</code>    | Is greater than or equal to |
| <code>!=</code>       | Is not equal to             |



The six relational operators exhaust the comparisons C++ enables you to make for numbers. If you want to compare two values to see which is the more beautiful or the luckier, you must look elsewhere.

Here are some sample tests:

```
for (x = 20; x > 5; x--) // continue while x is greater than 5
for (x = 1; y != x; ++x) // continue while y is not equal to x
for (cin >> x; x == 0; cin >> x) // continue while x is 0
```

The relational operators have a lower precedence than the arithmetic operators. That means this expression:

```
x + 3 > y - 2 // Expression 1
```

corresponds to this:

```
(x + 3) > (y - 2) // Expression 2
```

and not to the following:

```
x + (3 > y) - 2 // Expression 3
```

Because the expression  $(3 > y)$  is either 1 or 0 after the `bool` value is promoted to `int`, Expressions 2 and 3 are both valid. But most of us would want Expression 1 to mean Expression 2, and that is what C++ does.

## Assignment, Comparison, and a Mistake You'll Probably Make

Don't confuse testing the is-equal-to operator (`==`) with the assignment operator (`=`). This expression asks the musical question "Is musicians equal to 4?":

```
musicians == 4 // comparison
```

The expression has the value `true` or `false`. This expression assigns the value 4 to `musicians`:

```
musicians = 4 // assignment
```

The whole expression, in this case, has the value 4 because that's the value of the left side.

The flexible design of the `for` loop creates an interesting opportunity for error. If you accidentally drop an equals sign (`=`) from the `==` operator and use an assignment expression instead of a relational expression for the test part of a `for` loop, you still produce valid code. That's because you can use any valid C++ expression for a `for` loop test condition. Remember that nonzero values test as `true`, and zero tests as `false`. An expression that assigns 4 to `musicians` has the value 4 and is treated as `true`. If you come from a language, such as Pascal or BASIC, that uses `=` to test for equality, you might be particularly prone to this slip.

Listing 5.10 shows a situation in which you can make this sort of error. The program attempts to examine an array of quiz scores and stops when it reaches the first score that's not 20. It shows a loop that correctly uses comparison and then one that mistakenly uses assignment in the test condition. The program also has another egregious design error that

you'll see how to fix later. (You learn from your mistakes, and Listing 5.10 is happy to help in that respect.)

Listing 5.10 `equal.cpp`

---

```
// equal.cpp -- equality vs assignment
#include <iostream>
int main()
{
    using namespace std;
    int quizscores[10] =
        { 20, 20, 20, 20, 20, 19, 20, 18, 20, 20};

    cout << "Doing it right:\n";
    int i;
    for (i = 0; quizscores[i] == 20; i++)
        cout << "quiz " << i << " is a 20\n";
// Warning: you may prefer reading about this program
// to actually running it.
    cout << "Doing it dangerously wrong:\n";
    for (i = 0; quizscores[i] = 20; i++)
        cout << "quiz " << i << " is a 20\n";

    return 0;
}
```

---

Because the program in Listing 5.10 has a serious problem, you might prefer reading about it to actually running it. Here is some sample output from the program:

Doing it right:

```
quiz 0 is a 20
quiz 1 is a 20
quiz 2 is a 20
quiz 3 is a 20
quiz 4 is a 20
```

Doing it dangerously wrong:

```
quiz 0 is a 20
quiz 1 is a 20
quiz 2 is a 20
quiz 3 is a 20
quiz 4 is a 20
quiz 5 is a 20
quiz 6 is a 20
quiz 7 is a 20
quiz 8 is a 20
quiz 9 is a 20
quiz 10 is a 20
```

```
quiz 11 is a 20
quiz 12 is a 20
quiz 13 is a 20
...
```

The first loop correctly halts after displaying the first five quiz scores. But the second starts by displaying the whole array. Worse than that, it says every value is 20. And worse still, it doesn't stop at the end of the array! And worst of all, the program can (although not necessarily) freeze other applications running at the time and require a computer reboot.

Where things go wrong, of course, is with the following test expression:

```
quizscores[i] = 20
```

First, simply because it assigns a nonzero value to the array element, the expression is always nonzero, hence always true. Second, because the expression assigns values to the array elements, it actually changes the data. Third, because the test expression remains true, the program continues changing data beyond the end of the array. It just keeps putting more and more 20s into memory! This is not good.

The difficulty with this kind of error is that the code is syntactically correct, so the compiler won't tag it as an error. (However, years and years of C and C++ programmers making this error has eventually led many compilers to issue a warning, asking if that's what you really meant to do.)

### Caution

Don't use `=` to compare for equality; use `==`.

Like C, C++ grants you more freedom than most programming languages. This comes at the cost of requiring greater responsibility on your part. Nothing but your own good planning prevents a program from going beyond the bounds of a standard C++ array. However, with C++ classes, you can design a protected array type that prevents this sort of nonsense. Chapter 13, "Class Inheritance," provides an example. For now, you should build the protection into your programs when you need it. For example, the loop in Listing 5.10 should include a test that keeps it from going past the last member. That's true even for the "good" loop. If all the scores were 20s, the "good" loop, too, would exceed the array bounds. In short, the loop needs to test the values of the array and the array index. Chapter 6 shows how to use logical operators to combine two such tests into a single condition.

## Comparing C-Style Strings

Suppose you want to see if a string in a character array is the word `mate`. If `word` is the array name, the following test might not do what you think it should do:

```
word == "mate"
```

Remember that the name of an array is a synonym for its address. Similarly, a quoted string constant is a synonym for its address. Thus, the preceding relational expression

doesn't test whether the strings are the same; it checks whether they are stored at the same address. The answer to that is no, even if the two strings have the same characters.

Because C++ handles C-style strings as addresses, you get little satisfaction if you try to use the relational operators to compare strings. Instead, you can go to the C-style string library and use the `strcmp()` function to compare strings. This function takes two string addresses as arguments. That means the arguments can be pointers, string constants, or character array names. If the two strings are identical, the function returns the value 0. If the first string precedes the second alphabetically, `strcmp()` returns a negative value, and if the first string follows the second alphabetically, `strcmp()` returns a positive value. Actually, "in the system collating sequence" is more accurate than "alphabetically." This means that characters are compared according to the system code for characters. For example, in ASCII code, uppercase letters have smaller codes than the lowercase letters, so uppercase precedes lowercase in the collating sequence. Therefore, the string "zoo" precedes the string "aviary". The fact that comparisons are based on code values also means that uppercase and lowercase letters differ, so the string "FOO" is different from the string "foo".

In some languages, such as BASIC and standard Pascal, strings stored in differently sized arrays are necessarily unequal to each other. But C-style strings are defined by the terminating null character, not by the size of the containing array. This means that two strings can be identical even if they are contained in differently sized arrays:

```
char big[80] = "Daffy";           // 5 letters plus \0
char little[6] = "Daffy";        // 5 letters plus \0
```

By the way, although you can't use relational operators to compare strings, you can use them to compare characters because characters are actually integer types. Therefore, the following is valid code, at least for the ASCII and Unicode character sets, for displaying the characters of the alphabet:

```
for (ch = 'a'; ch <= 'z'; ch++)
    cout << ch;
```

The program in Listing 5.11 uses `strcmp()` in the test condition of a `for` loop. The program displays a word, changes its first letter, displays the word again, and keeps going until `strcmp()` determines that `word` is the same as the string "mate". Note that the listing includes the `cstring` file because it provides a function prototype for `strcmp()`.

#### Listing 5.11 `compstr1.cpp`

---

```
// compstr1.cpp -- comparing strings using arrays
#include <iostream>
#include <cstring>           // prototype for strcmp()
int main()
{
    using namespace std;
    char word[5] = "?ate";
```

```

    for (char ch = 'a'; strcmp(word, "mate"); ch++)
    {
        cout << word << endl;
        word[0] = ch;
    }
    cout << "After loop ends, word is " << word << endl;
    return 0;
}

```

---

Here is the output for the program in Listing 5.11:

```

?ate
aate
bate
cate
date
eate
fate
gate
hate
iate
jate
kate
late
After loop ends, word is mate

```

### Program Notes

The program in Listing 5.11 has some interesting points. One, of course, is the test. You want the loop to continue as long as `word` is not `mate`. That is, you want the test to continue as long as `strcmp()` says the two strings are not the same. The most obvious test for that is this:

```
strcmp(word, "mate") != 0    // strings are not the same
```

This statement has the value `1` (`true`) if the strings are unequal and the value `0` (`false`) if they are equal. But what about `strcmp(word, "mate")` by itself? It has a nonzero value (`true`) if the strings are unequal and the value `0` (`false`) if the strings are equal. In essence, the function returns `true` if the strings are different and `false` if they are the same. You can use just the function instead of the whole relational expression. This produces the same behavior and involves less typing. Also it's the way C and C++ programmers have traditionally used `strcmp()`.

#### Testing for Equality or Order

You can use `strcmp()` to test C-style strings for equality or order. The following expression is true if `str1` and `str2` are identical:

```
strcmp(str1, str2) == 0
```

The expressions

```
strcmp(str1, str2) != 0
```

and

```
strcmp(str1, str2)
```

are true if `str1` and `str2` are not identical. The following expression is true if `str1` precedes `str2`:

```
strcmp(str1, str2) < 0
```

And the following expression is true if `str1` follows `str2`:

```
strcmp(str1, str2) > 0
```

Thus, the `strcmp()` function can play the role of the `==`, `!=`, `<`, and `>` operators, depending on how you set up a test condition.

Next, `compstr1.cpp` uses the increment operator to march the variable `ch` through the alphabet:

```
ch++
```

You can use the increment and decrement operators with character variables because type `char` really is an integer type, so the operation actually changes the integer code stored in the variable. Also note that using an array index makes it simple to change individual characters in a string:

```
word[0] = ch;
```

## Comparing string Class Strings

Life is a bit simpler if you use `string` class strings instead of C-style strings because the class design allows you to use relational operators to make the comparisons. This is possible because one can define class functions that “overload,” or redefine, operators. Chapter 12, “Classes and Dynamic Memory Allocation,” discusses how to incorporate this feature into class designs, but from a practical standpoint, all you need to know now is that you can use the relational operators with `string` class objects. Listing 5.12 revises Listing 5.11 to use a `string` object instead of an array of `char`.

### Listing 5.12 `compstr2.cpp`

```
// compstr2.cpp -- comparing strings using arrays
#include <iostream>
#include <string>    // string class
int main()
{
    using namespace std;
    string word = "?ate";
```

```

for (char ch = 'a'; word != "mate"; ch++)
{
    cout << word << endl;
    word[0] = ch;
}
cout << "After loop ends, word is " << word << endl;
return 0;
}

```

---

The output from the program in Listing 5.12 is the same as that for the program in Listing 5.11.

### Program Notes

In Listing 5.12, the following test condition uses a relational operator with a `string` object on the left and a C-style string on the right:

```
word != "mate"
```

The way the `string` class overloads the `!=` operator allows you to use it as long as at least one of the operands is a `string` object; the remaining operand can be either a `string` object or a C-style string.

The `string` class design allows you to use a `string` object as a single entity, as in the relational test expression, or as an aggregate object for which you can use array notation to extract individual characters.

As you can see, you can achieve the same results with C-style strings as with `string` objects, but programming with `string` objects is simpler and more intuitive.

Finally, unlike most of the `for` loops you have seen to this point, the last two loops aren't counting loops. That is, they don't execute a block of statements a specified number of times. Instead, each of these loops watches for a particular circumstance (`word` being "mate") to signal that it's time to stop. More typically, C++ programs use `while` loops for this second kind of test, so let's examine that form next.

## The while Loop

The `while` loop is a `for` loop stripped of the initialization and update parts; it has just a test condition and a body:

```
while (test-condition)
    body
```

First, a program evaluates the parenthesized *test-condition* expression. If the expression evaluates to `true`, the program executes the statement(s) in the body. As with a `for` loop, the body consists of a single statement or a block defined by paired braces. After it finishes with the body, the program returns to the test condition and re-evaluates it. If the condition is nonzero, the program executes the body again. This cycle of testing and execution continues until the test condition evaluates to `false` (see Figure 5.3). Clearly, if

you want the loop to terminate eventually, something within the loop body must do something to affect the *test-condition* expression. For example, the loop can increment a variable used in the test condition or read a new value from keyboard input. Like the *for* loop, the *while* loop is an entry-condition loop. Thus, if *test-condition* evaluates to *false* at the beginning, the program never executes the body of the loop.

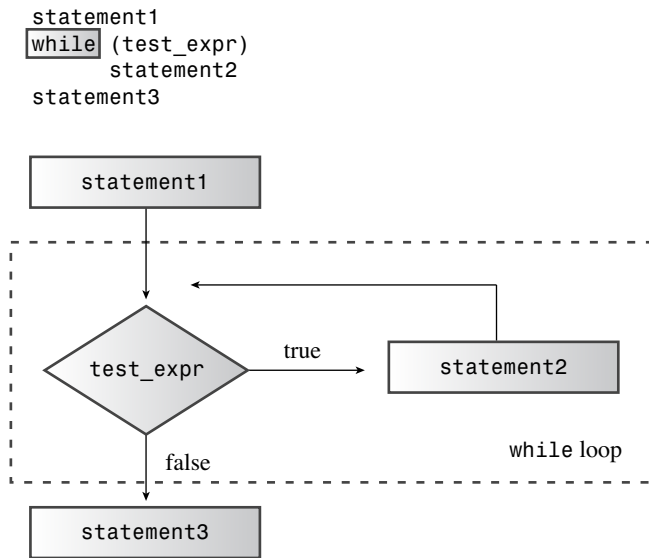

Figure 5.3 The structure of `while` loops.

Listing 5.13 puts a `while` loop to work. The loop cycles through each character in a string and displays the character and its ASCII code. The loop quits when it reaches the null character. This technique of stepping through a string character-by-character until reaching the null character is a standard C++ method for processing C-style strings. Because a string contains its own termination marker, programs often don't need explicit information about how long a string is.

#### Listing 5.13 `while.cpp`

---

```

// while.cpp -- introducing the while loop
#include <iostream>
const int ArSize = 20;
int main()
{
    using namespace std;
    char name[ArSize];

```



```

    cout << "Your first name, please: ";
    cin >> name;
    cout << "Here is your name, verticalized and ASCIIized:\n";
    int i = 0;                // start at beginning of string
    while (name[i] != '\0')  // process to end of string
    {
        cout << name[i] << ": " << int(name[i]) << endl;
        i++;                // don't forget this step
    }
    return 0;
}

```

---

Here is a sample run of the program in Listing 5.13:

```

Your first name, please: Muffy
Here is your name, verticalized and ASCIIized:
M: 77
u: 117
f: 102
f: 102
y: 121

```

(No, verticalized and ASCIIized are not real words or even good would-be words. But they do add an endearing technoid tone to the output.)

## Program Notes

The `while` condition in Listing 5.13 looks like this:

```
while (name[i] != '\0')
```

It tests whether a particular character in the array is the null character. For this test to eventually succeed, the loop body needs to change the value of `i`. It does so by incrementing `i` at the end of the loop body. Omitting this step keeps the loop stuck on the same array element, printing the character and its code until you manage to kill the program. Getting such an infinite loop is one of the most common problems with loops. Often you can cause it when you forget to update some value within the loop body.

You can rewrite the `while` line this way:

```
while (name[i])
```

With this change, the program works just as it did before. That's because when `name[i]` is an ordinary character, its value is the character code, which is nonzero, or `true`. But when `name[i]` is the null character, its character-code value is 0, or `false`. This notation is more concise (and more commonly used) but less clear than what Listing 5.13 uses. Dumb compilers might produce faster code for the second version, but smart compilers produce the same code for both.

To print the ASCII code for a character, the program uses a type cast to convert `name[i]` to an integer type. Then `cout` prints the value as an integer rather than interpret it as a character code.

Unlike a C-style string, a `string` class object doesn't use a null character to identify the end of a string, so you can't convert Listing 5.13 to a `string` class version merely by replacing the array of `char` with a `string` object. Chapter 16 discusses techniques you can use with a `string` object to identify the last character.

## for Versus while

In C++ the `for` and `while` loops are essentially equivalent. For example, the `for` loop

```
for (init-expression; test-expression; update-expression)
{
    statement(s)
}
```

could be rewritten this way:

```
init-expression;
while (test-expression)
{
    statement(s)
    update-expression;
}
```

Similarly, the `while` loop

```
while (test-expression)
    body
```

could be rewritten this way:

```
for ( ; test-expression;)
    body
```

This `for` loop requires three expressions (or, more technically, one statement followed by two expressions), but they can be empty expressions (or statements). Only the two semicolons are mandatory. Incidentally, a missing test expression in a `for` loop is construed as true, so this loop runs forever:

```
for ( ; ; )
    body
```

Because `for` loops and `while` loops are nearly equivalent, the one you use is largely a matter of style. There are three differences. One, as just mentioned, is that an omitted test condition in a `for` loop is interpreted as true. The second is that you can use the initialization statement in a `for` loop to declare a variable that is local to the loop; you can't do that with a `while` loop. Finally, there is a slight difference if the body includes a `continue` statement, which is discussed in Chapter 6. Typically, programmers use `for` loops for

counting loops because the `for` loop format enables you to place all the relevant information—initial value, terminating value, and method of updating the counter—in one place. Programmers most often use `while` loops when they don't know in advance precisely how many times a loop will execute.

### Tip

Keep in mind the following guidelines when you design a loop:

- Identify the condition that terminates loop execution.
- Initialize that condition before the first test.
- Update the condition in each loop cycle before the condition is tested again.

One nice thing about `for` loops is that their structure provides a place to implement these three guidelines, thus helping you to remember to do so. But these guidelines apply to a `while` loop, too.

### Bad Punctuation

Both `for` loops and `while` loops have bodies that consist of a single statement following the parenthesized expressions. As you've seen, that single statement can be a block, which can contain several statements. Keep in mind that braces, not indentation, define a block. Consider the following loop, for example:

```
i = 0;
while (name[i] != '\0')
    cout << name[i] << endl;
    i++;
cout << "Done\n";
```

The indentation tells you that the program author intended the `i++;` statement to be part of the loop body. The absence of braces, however, tells the compiler that the body consists solely of the first `cout` statement. Thus, the loop keeps printing the first character of the array indefinitely. The program never reaches the `i++;` statement because it is outside the loop.

The following example shows another potential pitfall:

```
i = 0;
while (name[i] != '\0'); // problem semicolon
{
    cout << name[i] << endl;
    i++;
}
cout << "Done\n";
```

This time the code gets the braces right, but it also inserts an extra semicolon. Remember, a semicolon terminates a statement, so this semicolon terminates the `while` loop. In other words, the body of the loop is a *null statement*—that is, nothing followed by a semicolon. All the material in braces now comes *after* the loop and is never reached. Instead, the loop cycles, doing nothing forever. Beware the straggling semicolon.

## Just a Moment—Building a Time-Delay Loop

Sometimes it's useful to build a time delay into a program. For example, you might have encountered programs that flash a message onscreen and then go on to something else before you can read the message. You end up being afraid that you've missed irretrievable information of vital importance. It would be much nicer if the program paused 5 seconds before moving on. The `while` loop is handy for producing this effect. A technique from the early days of personal computers was to make the computer count for a while to use up time:

```
long wait = 0;
while (wait < 10000)
    wait++;           // counting silently
```

The problem with this approach is that you have to change the counting limit when you change computer processor speed. Several games written for the original IBM PC, for example, became unmanageably fast when run on its faster successors. And these days a compiler might even deduce that it can just set `wait` to 1000 and skip the loop. A better approach is to let the system clock do the timing for you.

The ANSI C and the C++ libraries have a function to help you do this. The function is called `clock()`, and it returns the system time elapsed since a program started execution. There are a couple complications, though. First, `clock()` doesn't necessarily return the time in seconds. Second, the function's return type might be `long` on some systems, `unsigned long` on others, and perhaps some other type on others.

But the `ctime` header file (`time.h` on less current implementations) provides solutions to these problems. First, it defines a symbolic constant, `CLOCKS_PER_SEC`, that equals the number of system time units per second. So dividing the system time by this value yields seconds. Or you can multiply seconds by `CLOCKS_PER_SEC` to get time in the system units. Second, `ctime` establishes `clock_t` as an alias for the `clock()` return type. (See the sidebar "Type Aliases," later in this chapter.) This means you can declare a variable as type `clock_t`, and the compiler converts it to `long` or `unsigned int` or whatever is the proper type for your system.

Listing 5.14 shows how to use `clock()` and the `ctime` header to create a time-delay loop.

### Listing 5.14 `waiting.cpp`

---

```
// waiting.cpp -- using clock() in a time-delay loop
#include <iostream>
#include <ctime> // describes clock() function, clock_t type
int main()
{
    using namespace std;
    cout << "Enter the delay time, in seconds: ";
    float secs;
    cin >> secs;
    clock_t delay = secs * CLOCKS_PER_SEC; // convert to clock ticks
```

```

    cout << "starting\a\n";
    clock_t start = clock();
    while (clock() - start < delay )           // wait until time elapses
        ;                                     // note the semicolon
    cout << "done \a\n";
    return 0;
}

```

---

By calculating the delay time in system units instead of in seconds, the program in Listing 5.14 avoids having to convert system time to seconds in each loop cycle.

### Type Aliases

C++ has two ways to establish a new name as an alias for a type. One is to use the preprocessor:

```
#define BYTE char // preprocessor replaces BYTE with char
```

The preprocessor then replaces all occurrences of `BYTE` with `char` when you compile a program, thus making `BYTE` an alias for `char`.

The second method is to use the C++ (and C) keyword `typedef` to create an alias. For example, to make `byte` an alias for `char`, you use this:

```
typedef char byte; // makes byte an alias for char
```

Here's the general form:

```
typedef typeName aliasName;
```

In other words, if you want `aliasName` to be an alias for a particular type, you declare `aliasName` as if it were a variable of that type and then prefix the declaration with the `typedef` keyword. For example, to make `byte_pointer` an alias for pointer-to-`char`, you could declare `byte_pointer` as a pointer-to-`char` and then stick `typedef` in front:

```
typedef char * byte_pointer; // pointer to char type
```

You could try something similar with `#define`, but that wouldn't work if you declared a list of variables. For example, consider the following:

```
#define FLOAT_POINTER float *
FLOAT_POINTER pa, pb;
```

Preprocessor substitution converts the declaration to this:

```
float * pa, pb; // pa a pointer to float, pb just a float
```

The `typedef` approach doesn't have that problem. Its ability to handle more complex type aliases makes using `typedef` a better choice than `#define`—and sometimes it is the only choice.

Notice that `typedef` doesn't create a new type. It just creates a new name for an old type. If you make `word` an alias for `int`, `cout` treats a type `word` value as the `int` it really is.

## The do while Loop

You've now seen the `for` loop and the `while` loop. The third C++ loop is the `do while`. It's different from the other two because it's an *exit-condition* loop. That means this devil-may-care loop first executes the body of the loop and only then evaluates the test expression to see whether it should continue looping. If the condition evaluates to `false`, the loop terminates; otherwise, a new cycle of execution and testing begins. Such a loop always executes at least once because its program flow must pass through the body of the loop before reaching the test. Here's the syntax for the `do while` loop:

```
do
    body
while (test-expression);
```

The *body* portion can be a single statement or a brace-delimited statement block. Figure 5.4 summarizes the program flow for `do while` loops.

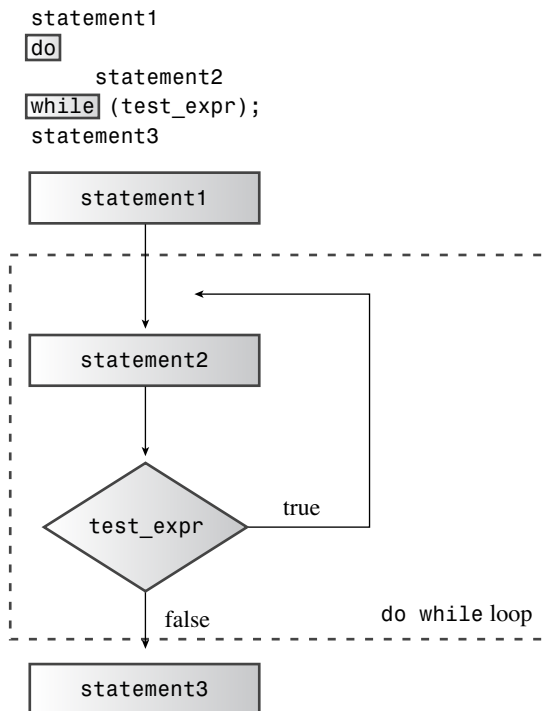

Figure 5.4 The structure of `do while` loops.

Usually, an entry-condition loop is a better choice than an exit-condition loop because the entry-condition loop checks before looping. For example, suppose Listing 5.13 used

do while instead of while. In that case, the loop would print the null character and its code before finding that it had already reached the end of the string. But sometimes a do while test does make sense. For example, if you're requesting user input, the program has to obtain the input before testing it. Listing 5.15 shows how to use do while in such a situation.

Listing 5.15 `dowhile.cpp`

---

```
// dowhile.cpp -- exit-condition loop
#include <iostream>
int main()
{
    using namespace std;
    int n;

    cout << "Enter numbers in the range 1-10 to find ";
    cout << "my favorite number\n";
    do
    {
        cin >> n;        // execute body
    } while (n != 7);    // then test
    cout << "Yes, 7 is my favorite.\n" ;
    return 0;
}
```

---

Here's a sample run of the program in Listing 5.15:

```
Enter numbers in the range 1-10 to find my favorite number
9
4
7
Yes, 7 is my favorite.
```

### Strange for loops

It's not terribly common, but you may occasionally see code that resembles the following:

```
int I = 0;
for(;;) // sometimes called a "forever loop"
{
    I++;
    // do something ...
    if (30 >= I) break;    // if statement and break (Chapter 6)
}
```

Or here is another variation:

```
int I = 0;
for(;;I++)
{
```

```

    if (30 >= I) break;
        // do something ...
}

```

The code relies on the fact that an empty test condition in a `for` loop is treated as being true. Neither of these examples is easy to read, and neither should be used as a general model of writing a loop. The functionality of the first example can be more clearly expressed in a `do while` loop:

```

int I = 0;
do {
    I++;
    // do something;
while (30 > I);

```

Similarly, the second example can be expressed more clearly as a `while` loop:

```

while (I < 30)
{
    // do something
    I++;
}

```

In general, writing clear, easily understood code is a more useful goal than demonstrating the ability to exploit obscure features of the language.

## The Range-Based for Loop (C++11)

The C++11 adds a new form of loop called the *range-based for* loop. It simplifies one common loop task—that of doing something with each element of an array, or, more generally, of one of the container classes, such as `vector` or `array`. Here is an example:

```

double prices[5] = {4.99, 10.99, 6.87, 7.99, 8.49};
for (double x : prices)
    cout << x << std::endl;

```

Here `x` initially represents the first member of the `prices` array. After displaying the first element, the loop then cycles `x` to represent the remaining elements of the array in turn, so this code would print all five members, one per line. In short, this loop displays every value included in the range of the array.

To modify array values, you need a different syntax for the loop variable:

```

for (double &x : prices)
    x = x * 0.80;           //20% off sale

```

The `&` symbol identifies `x` as a reference variable, a topic we'll discuss in Chapter 8, "Adventures in Functions." The significance here is that this form of declaration allows the subsequent code to modify the array contents, whereas the first form doesn't.

The range-based `for` loop also can be used with initialization lists:

```

for (int x : {3, 5, 2, 8, 6})
    cout << x << " ";
cout << '\n';

```



However, this loop likely will be used most often with the various template container classes discussed in Chapter 16.

## Loops and Text Input

Now that you've seen how loops work, let's look at one of the most common and important tasks assigned to loops: reading text character-by-character from a file or from the keyboard. For example, you might want to write a program that counts the number of characters, lines, and words in the input. Traditionally, C++, like C, uses the `while` loop for this sort of task. We'll next investigate how that is done. If you already know C, don't skim through the following sections too fast. Although the C++ `while` loop is the same as C's, C++'s I/O facilities are different. This can give the C++ loop a somewhat different look from the C loop. In fact, the `cin` object supports three distinct modes of single-character input, each with a different user interface. Let's look at how to use these choices with `while` loops.

### Using Unadorned `cin` for Input

If a program is going to use a loop to read text input from the keyboard, it has to have some way of knowing when to stop. How can it know when to stop? One way is to choose some special character, sometimes called a *sentinel character*, to act as a stop sign. For example, Listing 5.16 stops reading input when the program encounters a `#` character. The program counts the number of characters it reads and then echoes them. That is, it redisplay the characters that have been read. (Pressing a keyboard key doesn't automatically place a character onscreen; programs have to do that drudge work by echoing the input character. Typically, the operating system handles that task. In this case, both the operating system and the test program echo the input.) When it is finished, the program reports the total number of characters processed. Listing 5.16 shows the program.

Listing 5.16 `textin1.cpp`

---

```
// textin1.cpp -- reading chars with a while loop
#include <iostream>
int main()
{
    using namespace std;
    char ch;
    int count = 0;        // use basic input
    cout << "Enter characters; enter # to quit:\n";
    cin >> ch;           // get a character
    while (ch != '#')    // test the character
    {
        cout << ch;      // echo the character
        ++count;        // count the character
        cin >> ch;      // get the next character
    }
}
```

```
    cout << endl << count << " characters read\n";  
    return 0;  
}
```

---

Here's a sample run of the program in Listing 5.16:

```
Enter characters; enter # to quit:  
see ken run#really fast  
seekenrun  
9 characters read
```

Apparently, Ken runs so fast that he obliterates space itself—or at least the space characters in the input.

### Program Notes

Note the structure of the program in Listing 5.16. The program reads the first input character before it reaches the loop. That way, the first character can be tested when the program reaches the loop statement. This is important because the first character might be `#`. Because `textin1.cpp` uses an entry-condition loop, the program correctly skips the entire loop in that case. And because the variable `count` was previously set to 0, `count` has the correct value.

Suppose the first character read is not a `#`. In that case, the program enters the loop, displays the character, increments the count, and reads the next character. This last step is vital. Without it, the loop repeatedly processes the first input character forever. With the last step, the program advances to the next character.

Note that the loop design follows the guidelines mentioned earlier. The condition that terminates the loop is if the last character read is `#`. That condition is initialized by reading a character before the loop starts. The condition is updated by reading a new character at the end of the loop.

This all sounds reasonable. So why does the program omit the spaces on output? Blame `cin`. When reading type `char` values, just as when reading other basic types, `cin` skips over spaces and newline characters. The spaces in the input are not echoed, so they are not counted.

To further complicate things, the input to `cin` is buffered. That means the characters you type don't get sent to the program until you press Enter. This is why you are able to type characters after the `#` when running the program in Listing 5.16. After you press Enter, the whole sequence of characters is sent to the program, but the program quits processing the input after it reaches the `#` character.

### `cin.get(char)` to the Rescue

Usually, programs that read input character-by-character need to examine every character, including spaces, tabs, and newlines. The `istream` class (defined in `istream`), to which `cin` belongs, includes member functions that meet this need. In particular, the member function `cin.get(ch)` reads the next character, even if it is a space, from the input and

assigns it to the variable `ch`. By replacing `cin>>ch` with this function call, you can fix Listing 5.16. Listing 5.17 shows the result.

Listing 5.17 **textin2.cpp**

---

```
// textin2.cpp -- using cin.get(char)
#include <iostream>
int main()
{
    using namespace std;
    char ch;
    int count = 0;

    cout << "Enter characters; enter # to quit:\n";
    cin.get(ch);          // use the cin.get(ch) function
    while (ch != '#')
    {
        cout << ch;
        ++count;
        cin.get(ch);     // use it again
    }
    cout << endl << count << " characters read\n";
    return 0;
}
```

---

Here is a sample run of the program in Listing 5.17:

```
Enter characters; enter # to quit:
Did you use a #2 pencil?
Did you use a
14 characters read
```

Now the program echoes and counts every character, including the spaces. Input is still buffered, so it is still possible to type more input than what eventually reaches the program.

If you are familiar with C, this program may strike you as terribly wrong. The `cin.get(ch)` call places a value in the `ch` variable, which means it alters the value of the variable. In C you must pass the address of a variable to a function if you want to change the value of that variable. But the call to `cin.get()` in Listing 5.17 passes `ch`, not `&ch`. In C, code like this won't work. In C++ it can work, provided that the function declares the argument as a *reference*. The reference type is something that C++ added to C. The `iostream` header file declares the argument to `cin.get(ch)` as a reference type, so this function can alter the value of its argument. You'll learn the details in Chapter 8. Meanwhile, the C mavens among you can relax; ordinarily, argument passing in C++ works just as it does in C. For `cin.get(ch)`, however, it doesn't.

## Which `cin.get()` Should You Use?

Listing 4.5 in Chapter 4 uses this code:

```
char name[ArSize];
...
cout << "Enter your name:\n";
cin.get(name, ArSize).get();
```

The last line is equivalent to two consecutive function calls:

```
cin.get(name, ArSize);
cin.get();
```

One version of `cin.get()` takes two arguments: the array name, which is the address of the string (technically, type `char*`), and `ArSize`, which is an integer of type `int`. (Recall that the name of an array is the address of its first element, so the name of a character array is type `char*`.) Then the program uses `cin.get()` with no arguments. And most recently, we've used `cin.get()` this way:

```
char ch;
cin.get(ch);
```

This time `cin.get()` has one argument, and it is type `char`.

Once again it is time for those of you familiar with C to get excited or confused. In C if a function takes a pointer-to-char and an `int` as arguments, you can't successfully use the same function with a single argument of a different type. But you can do so in C++ because the language supports an OOP feature called *function overloading*. Function overloading allows you to create different functions that have the same name, provided that they have different argument lists. If, for example, you use `cin.get(name, ArSize)` in C++, the compiler finds the version of `cin.get()` that uses a `char*` and an `int` as arguments. But if you use `cin.get(ch)`, the compiler fetches the version that uses a single type `char` argument. And if the code provides no arguments, the compiler uses the version of `cin.get()` that takes no arguments.

Function overloading enables you to use the same name for related functions that perform the same basic task in different ways or for different types. This is another topic awaiting you in Chapter 8. Meanwhile, you can get accustomed to function overloading by using the `get()` examples that come with the `istream` class. To distinguish between the different function versions, we'll include the argument list when referring to them. Thus, `cin.get()` means the version that takes no arguments, and `cin.get(char)` means the version that takes one argument.

## The End-of-File Condition

As Listing 5.17 shows, using a symbol such as `#` to signal the end of input is not always satisfactory because such a symbol might be part of legitimate input. The same is true of other arbitrarily chosen symbols, such as `@` and `%`. If the input comes from a file, you can employ a much more powerful technique—detecting the end-of-file (EOF). C++ input

facilities cooperate with the operating system to detect when input reaches the end of a file and report that information back to a program.

At first glance, reading information from files seems to have little to do with `cin` and keyboard input, but there are two connections. First, many operating systems, including Unix, Linux, and the Windows Command Prompt mode, support *redirection*, which enables you to substitute a file for keyboard input. For example, suppose in Windows you have an executable program called `gofish.exe` and a text file called `fishtale`. In that case, you can give this command line in the command prompt mode:

```
gofish <fishtale
```

This causes the program to take input from the `fishtale` file instead of from the keyboard. The `<` symbol is the redirection operator for both Unix and the Windows Command Prompt mode.

Second, many operating systems allow you to simulate the EOF condition from the keyboard. In Unix you do so by pressing Ctrl+D at the beginning of a line. In the Windows Command Prompt mode, you press Ctrl+Z and then press Enter anywhere on the line. Some implementations of C++ support similar behavior even though the underlying operating system doesn't. The EOF concept for keyboard entry is actually a legacy of command-line environments. However, Symantec C++ for the Mac imitates Unix and recognizes Ctrl+D as a simulated EOF. Metrowerks Codewarrior recognizes Ctrl+Z in the Macintosh and Windows environments. Microsoft Visual C++, Borland C++ 5.5, and GNU C++ for the PC recognize Ctrl+Z when it's the first character on a line, but they require a subsequent Enter. In short, many PC programming environment recognize Ctrl+Z as a simulated EOF, but the exact details (anywhere on a line versus first character on a line, Enter key required or not required) vary.

If your programming environment can test for the EOF, you can use a program similar to Listing 5.17 with redirected files and you can use it for keyboard input in which you simulate the EOF. That sounds useful, so let's see how it's done.

When `cin` detects the EOF, it sets two bits (the *eofbit* and the *failbit*) to 1. You can use a member function named `eof()` to see whether the `eofbit` has been set; the call `cin.eof()` returns the `bool` value `true` if the EOF has been detected and `false` otherwise. Similarly, the `fail()` member function returns `true` if either the `eofbit` or the `failbit` has been set to 1 and `false` otherwise. Note that the `eof()` and `fail()` methods report the result of the most recent attempt to read; that is, they report on the past rather than look ahead. So a `cin.eof()` or `cin.fail()` test should always follow an attempt to read. The design of Listing 5.18 reflects this fact. It uses `fail()` instead of `eof()` because the former method appears to work with a broader range of implementations.

### Note

Some systems do not support simulated EOF from the keyboard. Other systems support it imperfectly. If you have been using `cin.get()` to freeze the screen until you can read it, that won't work here because detecting the EOF turns off further attempts to read input.

However, you can use a timing loop like that in Listing 5.14 to keep the screen visible for a while. Or you can use `cin.clear()`, as mentioned in Chapters 6 and 17, to reset the input stream.

Listing 5.18 `textin3.cpp`

---

```
// textin3.cpp -- reading chars to end of file
#include <iostream>
int main()
{
    using namespace std;
    char ch;
    int count = 0;
    cin.get(ch);      // attempt to read a char
    while (cin.fail() == false) // test for EOF
    {
        cout << ch;    // echo character
        ++count;
        cin.get(ch);  // attempt to read another char
    }
    cout << endl << count << " characters read\n";
    return 0;
}
```

---

Here is sample output from the program in Listing 5.18:

```
The green bird sings in the winter.<ENTER>
The green bird sings in the winter.
Yes, but the crow flies in the dawn.<ENTER>
Yes, but the crow flies in the dawn.
<CTRL>+<Z><ENTER>
73 characters read
```

Because I ran the program on a Windows 7 system, I pressed Ctrl+Z and then Enter to simulate the EOF condition. Unix and Linux users would press Ctrl+D instead. Note that in Unix and Unix-like systems, including Linux and Cygwin, Ctrl+Z suspends execution of the program; the `fg` command lets execution resume.

By using redirection, you can use the program in Listing 5.18 to display a text file and report how many characters it has. This time, we have a program read, echo, and count characters from a two-line file on a Unix system (the `$` is a Unix prompt):

```
$ textin3 < stuff
I am a Unix file. I am proud
to be a Unix file.
48 characters read
$
```

### EOF Ends Input

Remember that when a `cin` method detects the EOF, it sets a flag in the `cin` object, indicating the EOF condition. When this flag is set, `cin` does not read anymore input, and further calls to `cin` have no effect. For file input, this makes sense because you shouldn't read past the end of a file. For keyboard input, however, you might use a simulated EOF to terminate a loop but then want to read more input later. The `cin.clear()` method clears the EOF flag and lets input proceed again. Chapter 17, "Input, Output, and Files," discusses this further. Keep in mind, however, that in some systems, typing Ctrl+Z effectively terminates both input and output beyond the powers of `cin.clear()` to restore them.

### Common Idioms for Character Input

The following is the essential design of a loop intended to read text a character at a time until EOF:

```
cin.get(ch);           // attempt to read a char
while (cin.fail() == false) // test for EOF
{
    ...                // do stuff
    cin.get(ch);       // attempt to read another char
}
```

There are some shortcuts you can take with this code. Chapter 6 introduces the `!` operator, which toggles `true` to `false` and vice versa. You can use it to rewrite the `while` test to look like this:

```
while (!cin.fail()) // while input has not failed
```

The return value for the `cin.get(char)` method is `cin`, an object. However, the `istream` class provides a function that can convert an `istream` object such as `cin` to a `bool` value; this conversion function is called when `cin` occurs in a location where a `bool` is expected, such as in the test condition of a `while` loop. Furthermore, the `bool` value for the conversion is `true` if the last attempted read was successful and `false` otherwise. This means you can rewrite the `while` test to look like this:

```
while (cin) // while input is successful
```

This is a bit more general than using `!cin.fail()` or `!cin.eof()` because it detects other possible causes of failure, such as disk failure.

Finally, because the return value of `cin.get(char)` is `cin`, you can condense the loop to this format:

```
while (cin.get(ch)) // while input is successful
{
    ...                // do stuff
}
```

Here, `cin.get(char)` is called once in the test condition instead of twice—once before the loop and once at the end of the loop. To evaluate the loop test, the program

first has to execute the call to `cin.get(ch)`, which, if successful, places a value into `ch`. Then the program obtains the return value from the function call, which is `cin`. Then it applies the `bool` conversion to `cin`, which yields `true` if input worked and `false` otherwise. The three guidelines (identifying the termination condition, initializing the condition, and updating the condition) are all compressed into one loop test condition.

## Yet Another Version of `cin.get()`

Nostalgic C users might yearn for C's character I/O functions, `getchar()` and `putchar()`. They are available in C++ if you want them. You just use the `stdio.h` header file as you would in C (or use the more current `cstdio`). Or you can use member functions from the `istream` and `ostream` classes that work in much the same way. Let's look at that approach next.

The `cin.get()` member function with no arguments returns the next character from the input. That is, you use it in this way:

```
ch = cin.get();
```

(Recall that `cin.get(ch)` returns an object, not the character read.) This function works much the same as C's `getchar()`, returning the character code as a type `int` value. Similarly, you can use the `cout.put()` function (see Chapter 3, "Dealing with Data") to display the character:

```
cout.put(ch);
```

It works much like C's `putchar()`, except that its argument should be type `char` instead of type `int`.

### Note

Originally, the `put()` member had the single prototype `put(char)`. You could pass to it an `int` argument, which would then be type cast to `char`. The Standard also calls for a single prototype. However, some C++ implementations provide three prototypes: `put(char)`, `put(signed char)`, and `put(unsigned char)`. Using `put()` with an `int` argument in these implementations generates an error message because there is more than one choice for converting the `int`. An explicit type cast, such as `cin.put(char(ch))`, works for `int` types.

To use `cin.get()` successfully, you need to know how it handles the EOF condition. When the function reaches the EOF, there are no more characters to be returned. Instead, `cin.get()` returns a special value, represented by the symbolic constant `EOF`. This constant is defined in the `iostream` header file. The `EOF` value must be different from any valid character value so that the program won't confuse `EOF` with a regular character. Typically, `EOF` is defined as the value `-1` because no character has an ASCII code of `-1`, but you don't need to know the actual value. You can just use `EOF` in a program. For example, the heart of Listing 5.18 looks like this:



```

char ch;
cin.get(ch);
while (cin.fail() == false) // test for EOF
{
    cout << ch;
    ++count;
    cin.get(ch);
}

```

You can use `int ch`, replace `cin.get(char)` with `cin.get()`, replace `cout` with `cout.put()`, and replace the `cin.fail()` test with a test for `EOF`:

```

int ch;        /// for compatibility with EOF value
ch = cin.get();
while (ch != EOF)
{
    cout.put(ch); // cout.put(char(ch)) for some implementations
    ++count;
    ch = cin.get();
}

```

If `ch` is a character, the loop displays it. If `ch` is `EOF`, the loop terminates.

### Tip

You should realize that `EOF` does not represent a character in the input. Instead, it's a signal that there are no more characters.

There's a subtle but important point about using `cin.get()` beyond the changes made so far. Because `EOF` represents a value outside the valid character codes, it's possible that it might not be compatible with the `char` type. For example, on some systems type `char` is unsigned, so a `char` variable could never have the usual `EOF` value of `-1`. For this reason, if you use `cin.get()` (with no argument) and test for `EOF`, you must assign the return value to type `int` instead of to type `char`. Also if you make `ch` type `int` instead of type `char`, you might have to do a type cast to `char` when displaying `ch`.

Listing 5.19 incorporates the `cin.get()` approach into a new version of Listing 5.18. It also condenses the code by combining character input with the `while` loop test.

#### Listing 5.19 `textin4.cpp`

---

```

// textin4.cpp -- reading chars with cin.get()
#include <iostream>
int main(void)
{
    using namespace std;
    int ch;                // should be int, not char
    int count = 0;

    while ((ch = cin.get()) != EOF) // test for end-of-file

```

```

{
    cout.put(char(ch));
    ++count;
}
cout << endl << count << " characters read\n";
return 0;
}

```

## Note

Some systems either do not support simulated EOF from the keyboard or support it imperfectly, and that may prevent the example in Listing 5.19 from running as described. If you have been using `cin.get()` to freeze the screen until you can read it, that won't work here because detecting the EOF turns off further attempts to read input. However, you can use a timing loop like that in Listing 5.14 to keep the screen visible for a while. Or you can use `cin.clear()`, as described in Chapter 17, to reset the input stream.

Here's a sample run of the program in Listing 5.19:

```

The sullen mackerel sulks in the shadowy shallows.<ENTER>
The sullen mackerel sulks in the shadowy shallows.
Yes, but the blue bird of happiness harbors secrets.<ENTER>
Yes, but the blue bird of happiness harbors secrets.
<CTRL>+<Z><ENTER>
104 characters read

```

Let's analyze the loop condition:

```
while ((ch = cin.get()) != EOF)
```

The parentheses that enclose the subexpression `ch = cin.get()` cause the program to evaluate that expression first. To do the evaluation, the program first has to call the `cin.get()` function. Next, it assigns the function return value to `ch`. Because the value of an assignment statement is the value of the left operand, the whole subexpression reduces to the value of `ch`. If this value is `EOF`, the loop terminates; otherwise, it continues. The test condition needs all the parentheses. Suppose you leave some parentheses out:

```
while (ch = cin.get() != EOF)
```

The `!=` operator has higher precedence than `=`, so first the program compares `cin.get()`'s return value to `EOF`. A comparison produces a `false` or `true` result; that `bool` value is converted to `0` or `1`, and that's the value that gets assigned to `ch`.

Using `cin.get(ch)` (with an argument) for input, on the other hand, doesn't create any type problems. Remember that the `cin.get(char)` function doesn't assign a special value to `ch` at the EOF. In fact, it doesn't assign anything to `ch` in that case. `ch` is never called on to hold a non-`char` value. Table 5.3 summarizes the differences between `cin.get(char)` and `cin.get()`.

Table 5.3 `cin.get(ch)` Versus `cin.get()`

| Property                                  | <code>cin.get(ch)</code>                                                       | <code>ch=cin.get()</code>                              |
|-------------------------------------------|--------------------------------------------------------------------------------|--------------------------------------------------------|
| Method for conveying input character      | Assign to argument <code>ch</code>                                             | Use function return value to assign to <code>ch</code> |
| Function return value for character input | A class <code>istream</code> object (true after <code>bool</code> conversion)  | Code for character as type <code>int</code> value      |
| Function return value at EOF              | A class <code>istream</code> object (false after <code>bool</code> conversion) | EOF                                                    |

So which should you use, `cin.get()` or `cin.get(char)`? The form with the character argument is integrated more fully into the object approach because its return value is an `istream` object. This means, for example, that you can chain uses. For example, the following code means read the next input character into `ch1` and the following input character into `ch2`:

```
cin.get(ch1).get(ch2);
```

This works because the function call `cin.get(ch1)` returns the `cin` object, which then acts as the object to which `get(ch2)` is attached.

Probably the main use for the `get()` form is to let you make quick-and-dirty conversions from the `getchar()` and `putchar()` functions of `stdio.h` to the `cin.get()` and `cout.put()` methods of `iostream`. You just replace one header file with the other and globally replace `getchar()` and `putchar()` with their act-alike method equivalents. (If the old code uses a type `int` variable for input, you have to make further adjustments if your implementation has multiple prototypes for `put()`.)

## Nested Loops and Two-Dimensional Arrays

Earlier in this chapter you saw that the `for` loop is a natural tool for processing arrays. Now let's go a step further and look at how a `for` loop within a `for` loop (nested loops) serves to handle two-dimensional arrays.

First, let's examine what a two-dimensional array is. The arrays used so far in this chapter are termed *one-dimensional arrays* because you can visualize each array as a single row of data. You can visualize a two-dimensional array as being more like a table, having both rows and columns of data. You can use a two-dimensional array, for example, to represent quarterly sales figures for six separate districts, with one row of data for each district. Or you can use a two-dimensional array to represent the position of RoboDork on a computerized game board.

C++ doesn't provide a special two-dimensional array type. Instead, you create an array for which each element is itself an array. For example, suppose you want to store maximum temperature data for five cities over a 4-year period. In that case, you can declare an array as follows:

```
int maxtemps[4][5];
```

This declaration means that `maxtemps` is an array with four elements. Each of these elements is an array of five integers (see Figure 5.5). You can think of the `maxtemps` array as representing four rows of five temperature values each.

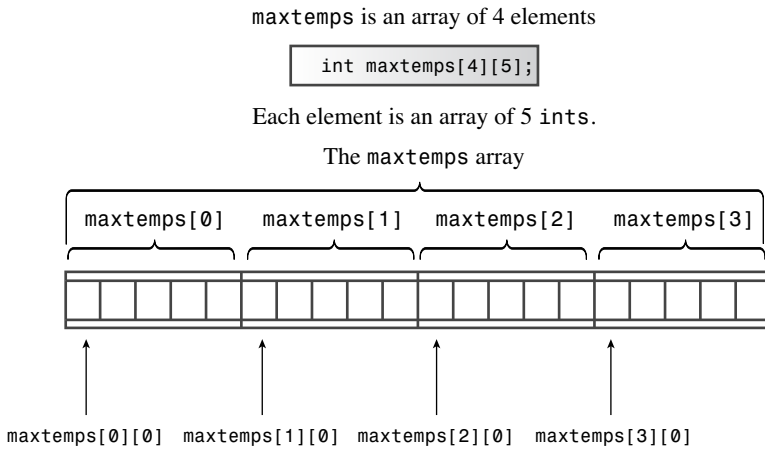

Figure 5.5 An array of arrays.

The expression `maxtemps[0]` is the first element of the `maxtemps` array; hence `maxtemps[0]` is itself an array of five `ints`. The first element of the `maxtemps[0]` array is `maxtemps[0][0]`, and this element is a single `int`. Thus, you need to use two subscripts to access the `int` elements. You can think of the first subscript as representing the row and the second subscript as representing the column (see Figure 5.6).

```
int maxtemps[4][5];
```

The `maxtemps` array viewed as a table:

|                          | 0                           | 1                           | 2                           | 3                           | 4                           |
|--------------------------|-----------------------------|-----------------------------|-----------------------------|-----------------------------|-----------------------------|
| <code>maxtemps[0]</code> | <code>maxtemps[0][0]</code> | <code>maxtemps[0][1]</code> | <code>maxtemps[0][2]</code> | <code>maxtemps[0][3]</code> | <code>maxtemps[0][4]</code> |
| <code>maxtemps[1]</code> | <code>maxtemps[1][0]</code> | <code>maxtemps[1][1]</code> | <code>maxtemps[1][2]</code> | <code>maxtemps[1][3]</code> | <code>maxtemps[1][4]</code> |
| <code>maxtemps[2]</code> | <code>maxtemps[2][0]</code> | <code>maxtemps[2][1]</code> | <code>maxtemps[2][2]</code> | <code>maxtemps[2][3]</code> | <code>maxtemps[2][4]</code> |
| <code>maxtemps[3]</code> | <code>maxtemps[3][0]</code> | <code>maxtemps[3][1]</code> | <code>maxtemps[3][2]</code> | <code>maxtemps[3][3]</code> | <code>maxtemps[3][4]</code> |

Figure 5.6 Accessing array elements with subscripts.

Suppose you want to print all the array contents. In that case, you can use one `for` loop to change rows and a second, nested, `for` loop to change columns:

```
for (int row = 0; row < 4; row++)
{
    for (int col = 0; col < 5; ++col)
        cout << maxtemps[row][col] << "\t";
    cout << endl;
}
```

For each value of `row`, the inner `for` loop cycles through all the `col` values. This example prints a tab character (`\t` in C++ escape character notation) after each value and a newline character after each complete row.

## Initializing a Two-Dimensional Array

When you create a two-dimensional array, you have the option of initializing each element. The technique is based on that for initializing a one-dimensional array. Remember that you do this by providing a comma-separated list of values enclosed in braces:

```
// initializing a one-dimensional array
int btus[5] = { 23, 26, 24, 31, 28};
```

For a two-dimensional array, each element is itself an array, so you can initialize each element by using a form like that in the previous code example. Thus, the initialization consists of a comma-separated series of one-dimensional initializations, all enclosed in a set of braces:

```
int maxtemps[4][5] = // 2-D array
{
    {96, 100, 87, 101, 105}, // values for maxtemps[0]
    {96, 98, 91, 107, 104}, // values for maxtemps[1]
    {97, 101, 93, 108, 107}, // values for maxtemps[2]
    {98, 103, 95, 109, 108} // values for maxtemps[3]
};
```

You can visualize `maxtemps` as four rows of five numbers each. The term `{94, 98, 87, 103, 101}` initializes the first row, represented by `maxtemps[0]`. As a matter of style, placing each row of data on its own line, if possible, makes the data easier to read.

## Using a Two-Dimensional Array

Listing 5.20 incorporates an initialized two-dimensional array and a nested loop into a program. This time the program reverses the order of the loops, placing the column loop (city index) on the outside and the row loop (year index) on the inside. Also it uses a

common C++ practice of initializing an array of pointers to a set of string constants. That is, `cities` is declared as an array of pointers-to-char. That makes each element, such as `cities[0]`, a pointer-to-char that can be initialized to the address of a string. The program initializes `cities[0]` to the address of the "Gribble City" string, and so on. Thus, this array of pointers behaves like an array of strings.

---

**Listing 5.20 nested.cpp**

---

```
// nested.cpp -- nested loops and 2-D array
#include <iostream>
const int Cities = 5;
const int Years = 4;
int main()
{
    using namespace std;
    const char * cities[Cities] = // array of pointers
    {                               // to 5 strings
        "Gribble City",
        "Gribbletown",
        "New Gribble",
        "San Gribble",
        "Gribble Vista"
    };

    int maxtemps[Years][Cities] = // 2-D array
    {
        {96, 100, 87, 101, 105}, // values for maxtemps[0]
        {96, 98, 91, 107, 104}, // values for maxtemps[1]
        {97, 101, 93, 108, 107}, // values for maxtemps[2]
        {98, 103, 95, 109, 108} // values for maxtemps[3]
    };

    cout << "Maximum temperatures for 2008 - 2011\n\n";
    for (int city = 0; city < Cities; ++city)
    {
        cout << cities[city] << ":\t";
        for (int year = 0; year < Years; ++year)
            cout << maxtemps[year][city] << "\t";
        cout << endl;
    }
    // cin.get();
    return 0;
}
```

---

Here is the output for the program in Listing 5.20:

```
Maximum temperatures for 2008 - 2011

Gribble City:   96      96      97      98
Gribbletown:   100     98     101     103
New Gribble:    87     91     93     95
San Gribble:   101    107    108    109
Gribble Vista: 105    104    107    108
```

Using tabs in the output spaces the data more regularly than using spaces would. However, different tab settings can cause the output to vary in appearance from one system to another. Chapter 17 presents more precise, but more complex, methods for formatting output.

More awkwardly, you could use an array of arrays of `char` instead of an array of pointers for the string data. The declaration would look like this:

```
char cities[Cities][25] = // array of 5 arrays of 25 char
{
    "Gribble City",
    "Gribbletown",
    "New Gribble",
    "San Gribble",
    "Gribble Vista"
};
```

This approach limits each of the five strings to a maximum of 24 characters. The array of pointers stores the addresses of the five string literals, but the array of `char` arrays copies each of the five string literals to the corresponding five arrays of 25 `char`. Thus, the array of pointers is much more economical in terms of space. However, if you intended to modify any of the strings, the two-dimensional array would be a better choice. Oddly enough, both choices use the same initialization list and the same `for` loop code to display the strings.

Also you could use an array of `string` class objects instead of an array of pointers for the string data. The declaration would look like this:

```
const string cities[Cities] = // array of 5 strings
{
    "Gribble City",
    "Gribbletown",
    "New Gribble",
    "San Gribble",
    "Gribble Vista"
};
```

If you intended for the strings to be modifiable, you would omit the `const` qualifier. This form uses the same initializer list and the same `for` loop display code as the other two forms. If you want modifiable strings, the automatic sizing feature of the `string` class makes this approach more convenient to use than the two-dimensional array approach.

## Summary

C++ offers three varieties of loops: `for` loops, `while` loops, and `do while` loops. A loop cycles through the same set of instructions repetitively, as long as the loop test condition evaluates to `true` or nonzero and the loop terminates execution when the test condition evaluates to `false` or zero. The `for` loop and the `while` loop are entry-condition loops, meaning that they examine the test condition before executing the statements in the body of the loop. The `do while` loop is an exit-condition loop, meaning that it examines the test condition after executing the statements in the body of the loop.

The syntax for each loop calls for the loop body to consist of a single statement. However, that statement can be a compound statement, or block, formed by enclosing several statements within paired curly braces.

Relational expressions, which compare two values, are often used as loop test conditions. Relational expressions are formed by using one of the six relational operators: `<`, `<=`, `==`, `>=`, `>`, or `!=`. Relational expressions evaluate to the type `bool` values `true` and `false`.

Many programs read text input or text files character-by-character. The `istream` class provides several ways to do this. If `ch` is a type `char` variable, the following statement reads the next input character into `ch`:

```
cin >> ch;
```

However, it skips over spaces, newlines, and tabs. The following member function call reads the next input character, regardless of its value, and places it in `ch`:

```
cin.get(ch);
```

The member function call `cin.get()` returns the next input character, including spaces, newlines, and tabs, so it can be used as follows:

```
ch = cin.get();
```

The `cin.get(char)` member function call reports encountering the EOF condition by returning a value with the `bool` conversion of `false`, whereas the `cin.get()` member function call reports the EOF by returning the value `EOF`, which is defined in the `istream` file.

A nested loop is a loop within a loop. Nested loops provide a natural way to process two-dimensional arrays.



## Chapter Review

1. What's the difference between an entry-condition loop and an exit-condition loop? Which kind is each of the C++ loops?

2. What would the following code fragment print if it were part of a valid program?

```
int i;
for (i = 0; i < 5; i++)
    cout << i;
    cout << endl;
```

3. What would the following code fragment print if it were part of a valid program?

```
int j;
for (j = 0; j < 11; j += 3)
    cout << j;
cout << endl << j << endl;
```

4. What would the following code fragment print if it were part of a valid program?

```
int j = 5;
while ( ++j < 9)
    cout << j++ << endl;
```

5. What would the following code fragment print if it were part of a valid program?

```
int k = 8;
do
    cout <<" k = " << k << endl;
while (k++ < 5);
```

6. Write a `for` loop that prints the values 1 2 4 8 16 32 64 by increasing the value of a counting variable by a factor of two in each cycle.

7. How do you make a loop body include more than one statement?

8. Is the following statement valid? If not, why not? If so, what does it do?

```
int x = (1,024);
```

What about the following?

```
int y;
y = 1,024;
```

9. How does `cin>>ch` differ from `cin.get(ch)` and `ch=cin.get()` in how it views input?

## Programming Exercises

1. Write a program that requests the user to enter two integers. The program should then calculate and report the sum of all the integers between and including the two integers. At this point, assume that the smaller integer is entered first. For example, if the user enters 2 and 9, the program should report that the sum of all the integers from 2 through 9 is 44.
2. Redo Listing 5.4 using a type array object instead of a built-in array and type `long double` instead of `long long`. Find the value of 100!
3. Write a program that asks the user to type in numbers. After each entry, the program should report the cumulative sum of the entries to date. The program should terminate when the user enters 0.
4. Daphne invests \$100 at 10% simple interest. That is, every year, the investment earns 10% of the original investment, or \$10 each and every year:

$\text{interest} = 0.10 \times \text{original balance}$

At the same time, Cleo invests \$100 at 5% compound interest. That is, interest is 5% of the current balance, including previous additions of interest:

$\text{interest} = 0.05 \times \text{current balance}$

Cleo earns 5% of \$100 the first year, giving her \$105. The next year she earns 5% of \$105, or \$5.25, and so on. Write a program that finds how many years it takes for the value of Cleo's investment to exceed the value of Daphne's investment and then displays the value of both investments at that time.

5. You sell the book *C++ for Fools*. Write a program that has you enter a year's worth of monthly sales (in terms of number of books, not of money). The program should use a loop to prompt you by month, using an array of `char *` (or an array of `string` objects, if you prefer) initialized to the month strings and storing the input data in an array of `int`. Then, the program should find the sum of the array contents and report the total sales for the year.
6. Do Programming Exercise 5 but use a two-dimensional array to store input for 3 years of monthly sales. Report the total sales for each individual year and for the combined years.
7. Design a structure called `car` that holds the following information about an automobile: its make, as a string in a character array or in a `string` object, and the year it was built, as an integer. Write a program that asks the user how many cars to catalog. The program should then use `new` to create a dynamic array of that many `car` structures. Next, it should prompt the user to input the make (which might consist of more than one word) and year information for each structure. Note that this requires some care because it alternates reading strings with numeric data (see

Chapter 4). Finally, it should display the contents of each structure. A sample run should look something like the following:

```
How many cars do you wish to catalog? 2
Car #1:
Please enter the make: Hudson Hornet
Please enter the year made: 1952
Car #2:
Please enter the make: Kaiser
Please enter the year made: 1951
Here is your collection:
1952 Hudson Hornet
1951 Kaiser
```

8. Write a program that uses an array of `char` and a loop to read one word at a time until the word `done` is entered. The program should then report the number of words entered (not counting `done`). A sample run could look like this:

```
Enter words (to stop, type the word done):
anteater birthday category dumpster
envy finagle geometry done for sure
You entered a total of 7 words.
```

You should include the `cstring` header file and use the `strcmp()` function to make the comparison test.

9. Write a program that matches the description of the program in Programming Exercise 8, but use a `string` class object instead of an array. Include the `string` header file and use a relational operator to make the comparison test.
10. Write a program using nested loops that asks the user to enter a value for the number of rows to display. It should then display that many rows of asterisks, with one asterisk in the first row, two in the second row, and so on. For each row, the asterisks are preceded by the number of periods needed to make all the rows display a total number of characters equal to the number of rows. A sample run would look like this:

```
Enter number of rows: 5
....*
...**
..***
.****
*****
```

# Branching Statements and Logical Operators

In this chapter you'll learn about the following:

- The `if` statement
- The `if else` statement
- Logical operators: `&&`, `||`, and `!`
- The `cctype` library of character functions
- The conditional operator: `?:`
- The `switch` statement
- The `continue` and `break` statements
- Number-reading loops
- Basic file input/output

One of the keys to designing intelligent programs is to give them the ability to make decisions. Chapter 5, “Loops and Relational Expressions,” shows one kind of decision making—looping—in which a program decides whether to continue looping. This chapter investigates how C++ lets you use branching statements to decide among alternative actions. Which vampire-protection scheme (garlic or cross) should the program use? What menu choice has the user selected? Did the user enter a zero? C++ provides the `if` and `switch` statements to implement decisions, and they are this chapter's main topics. This chapter also looks at the conditional operator, which provides another way to make a choice, and the logical operators, which let you combine two tests into one. Finally, the chapter takes a first look at file input/output.

## The `if` Statement

When a C++ program must choose whether to take a particular action, you usually implement the choice with an `if` statement. The `if` comes in two forms: `if` and `if else`. Let's investigate the simple `if` first. It's modeled after ordinary English, as in "If you have a Captain Cookie card, you get a free cookie." The `if` statement directs a program to execute a statement or statement block if a test condition is true and to skip that statement or block if the condition is false. Thus, an `if` statement lets a program decide whether a particular statement should be executed.

The syntax for the `if` statement is similar to the that of the `while` syntax:

```
if (test-condition)
    statement
```

A true *test-condition* causes the program to execute *statement*, which can be a single statement or a block. A false *test-condition* causes the program to skip *statement* (see Figure 6.1). As with loop test conditions, an `if` test condition is type cast to a `bool` value, so zero becomes `false` and nonzero becomes `true`. The entire `if` construction counts as a single statement.

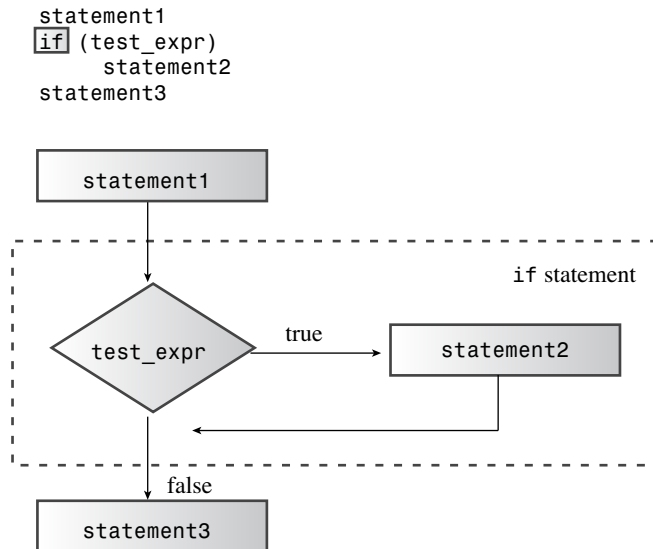

Figure 6.1 The structure of `if` statements.

Most often, *test-condition* is a relational expression such as those used to control loops. Suppose, for example, that you want a program that counts the spaces in the input as well as the total number of characters. You can use `cin.get(char)` in a `while` loop to

read the characters and then use an `if` statement to identify and count the space characters. Listing 6.1 does just that, using the period (`.`) to recognize the end of a sentence.

#### Listing 6.1 `if.cpp`

---

```
// if.cpp -- using the if statement
#include <iostream>
int main()
{
    using std::cin;    // using declarations
    using std::cout;
    char ch;
    int spaces = 0;
    int total = 0;
    cin.get(ch);
    while (ch != '.') // quit at end of sentence
    {
        if (ch == ' ') // check if ch is a space
            ++spaces;
        ++total;      // done every time
        cin.get(ch);
    }
    cout << spaces << " spaces, " << total;
    cout << " characters total in sentence\n";
    return 0;
}
```

---

Here's some sample output from the program in Listing 6.1:

```
The balloonist was an airhead
with lofty goals.
6 spaces, 46 characters total in sentence
```

As the comments in Listing 6.1 indicate, the `++spaces;` statement is executed only when `ch` is a space. Because it is outside the `if` statement, the `++total;` statement is executed in every loop cycle. Note that the total count includes the newline character that is generated by pressing Enter.

## The `if else` Statement

Whereas an `if` statement lets a program decide whether a *particular* statement or block is executed, an `if else` statement lets a program decide which of *two* statements or blocks is executed. It's an invaluable statement for creating alternative courses of action. The C++ `if else` statement is modeled after simple English, as in "If you have a Captain Cookie card, you get a Cookie Plus Plus, else you just get a Cookie d'Ordinaire." The `if else` statement has this general form:

```

if (test-condition)
    statement1
else
    statement2

```

If *test-condition* is true, or nonzero, the program executes *statement1* and skips over *statement2*. Otherwise, when *test-condition* is false, or zero, the program skips *statement1* and executes *statement2* instead. So the following code fragment prints the first message if *answer* is 1492 and prints the second message otherwise:

```

if (answer == 1492)
    cout << "That's right!\n";
else
    cout << "You'd better review Chapter 1 again.\n";

```

Each statement can be either a single statement or a statement block delimited by braces (see Figure 6.2). The entire `if else` construct counts syntactically as a single statement.

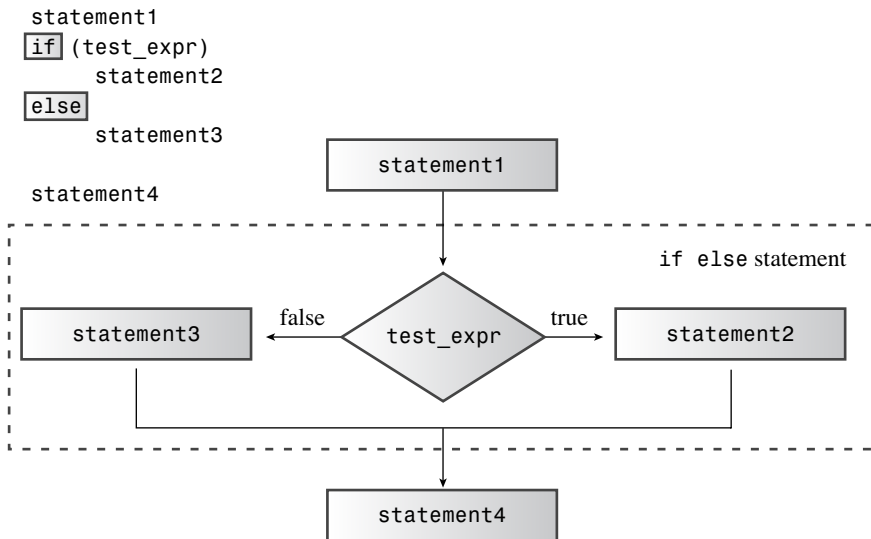

Figure 6.2 The structure of `if else` statements.

For example, suppose you want to alter incoming text by scrambling the letters while keeping the newline character intact. In that case, each line of input is converted to an output line of equal length. This means you want the program to take one course of action for newline characters and a different course of action for all other characters. As Listing 6.2 shows, `if else` makes this task easy. The listing also illustrates the `std::qualifier`, one of the alternatives to a `using` directive.

---

**Listing 6.2 ifelse.cpp**

---

```
// ifelse.cpp -- using the if else statement
#include <iostream>
int main()
{
    char ch;

    std::cout << "Type, and I shall repeat.\n";
    std::cin.get(ch);
    while (ch != '.')
    {
        if (ch == '\n')
            std::cout << ch;    // done if newline
        else
            std::cout << ++ch;  // done otherwise
        std::cin.get(ch);
    }
    // try ch + 1 instead of ++ch for interesting effect
    std::cout << "\nPlease excuse the slight confusion.\n";
    //  std::cin.get();
    //  std::cin.get();
    return 0;
}
```

---

Here's some sample output from the program in Listing 6.2:

```
Type, and I shall repeat.
An ineffable joy suffused me as I beheld
Bo!jofggbcmf!kpz!tvvgvtfe!nf!bt!J!cfifme
the wonders of modern computing.
uif!xpofst!pg!npefso!dpmqvujoh
Please excuse the slight confusion.
```

Note that one of the comments in Listing 6.2 suggests that changing `++ch` to `ch+1` has an interesting effect. Can you deduce what it will be? If not, try it out and then see if you can explain what's happening. (Hint: Think about how `cout` handles different types.)

## Formatting if else Statements

Keep in mind that the two alternatives in an `if else` statement must be single statements. If you need more than one statement, you must use braces to collect them into a single block statement. Unlike some languages, such as BASIC and FORTRAN, C++ does not automatically consider everything between `if` and `else` a block, so you have to use braces to make the statements a block. The following code, for example, produces a compiler error:



```

if (ch == 'Z')
    zorro++;           // if ends here
    cout << "Another Zorro candidate\n";
else
    // wrong
    dull++;
    cout << "Not a Zorro candidate\n";

```

The compiler sees it as a simple `if` statement that ends with the `zorro++;` statement.

Then there is a `cout` statement. So far, so good. But then there is what the compiler perceives as an unattached `else`, and that is flagged as a syntax error.

You add braces to group statements into a single statement block:

```

if (ch == 'Z')
{
    // if true block
    zorro++;
    cout << "Another Zorro candidate\n";
}
else
{
    // if false block
    dull++;
    cout << "Not a Zorro candidate\n";
}

```

Because C++ is a free-form language, you can arrange the braces as you like, as long as they enclose the statements. The preceding code shows one popular format. Here's another:

```

if (ch == 'Z') {
    zorro++;
    cout << "Another Zorro candidate\n";
}
else {
    dull++;
    cout << "Not a Zorro candidate\n";
}

```

The first form emphasizes the block structure for the statements, whereas the second form more closely ties the blocks to the keywords `if` and `else`. Either style is clear and consistent and should serve you well; however, you may encounter an instructor or employer with strong and specific views on the matter.

## The `if else if else` Construction

Computer programs, like life, might present you with a choice of more than two selections. You can extend the C++ `if else` statement to meet such a need. As you've seen, the `else` should be followed by a single statement, which can be a block. Because an `if else` statement itself is a single statement, it can follow an `else`:

```

if (ch == 'A')
    a_grade++;           // alternative # 1
else
    if (ch == 'B')      // alternative # 2
        b_grade++;     // subalternative # 2a
    else
        soso++;        // subalternative # 2b

```

If `ch` is not 'A', the program goes to the `else`. There, a second `if else` subdivides that alternative into two more choices. C++'s free formatting enables you to arrange these elements into an easier-to-read format:

```

if (ch == 'A')
    a_grade++;           // alternative # 1
else if (ch == 'B')
    b_grade++;          // alternative # 2
else
    soso++;             // alternative # 3

```

This looks like a new control structure—an `if else if else` structure. But actually it is one `if else` contained within a second. This revised format looks much cleaner, and it enables you to skim through the code to pick out the different alternatives. This entire construction still counts as one statement.

Listing 6.3 uses this preferred formatting to construct a modest quiz program.

### Listing 6.3 `ifelseif.cpp`

---

```

// ifelseif.cpp -- using if else if else
#include <iostream>
const int Fave = 27;
int main()
{
    using namespace std;
    int n;

    cout << "Enter a number in the range 1-100 to find ";
    cout << "my favorite number: ";
    do
    {
        cin >> n;
        if (n < Fave)
            cout << "Too low -- guess again: ";
        else if (n > Fave)
            cout << "Too high -- guess again: ";
        else
            cout << Fave << " is right!\n";
    } while (n != Fave);
    return 0;
}

```

---

Here's some sample output from the program in Listing 6.3:

```
Enter a number in the range 1-100 to find my favorite number: 50
Too high -- guess again: 25
Too low -- guess again: 37
Too high -- guess again: 31
Too high -- guess again: 28
Too high -- guess again: 27
27 is right!
```

### Conditional Operators and Bug Prevention

Many programmers reverse the more intuitive expression `variable == value` to `value == variable` in order to catch errors where the equality is mistyped as an assignment operator. For example, entering the conditional as follows is valid and will work properly:

```
if (3 == myNumber)
```

However, if you happen to mistype as follows, the compiler will generate an error message because it believes you are attempting to assign a value to a literal (3 always equals 3 and can't be assigned another value):

```
if (3 = myNumber)
```

Suppose you made a similar mistake, using the former notation:

```
if (myNumber = 3)
```

The compiler would simply assign the value 3 to `myNumber`, and the block within the `if` would run—a very common error, and a difficult error to find. (However, many compilers will issue a warning, which you would be wise to heed.) As a general rule, writing code that allows the compiler to find errors is much easier than repairing the causes of mysterious faulty results.

## Logical Expressions

Often you must test for more than one condition. For example, for a character to be a lowercase letter, its value must be greater than or equal to 'a' and less than or equal to 'z'. Or, if you ask a user to respond with a **y** or an **n**, you want to accept uppercase (**Y** and **N**) as well as lowercase. To meet this kind of need, C++ provides three logical operators to combine or modify existing expressions. The operators are logical OR, written `||`; logical AND, written `&&`; and logical NOT, written `!`. Let's examine them now.

### The Logical OR Operator: `||`

In English, the word *or* can indicate when one or both of two conditions satisfy a requirement. For example, you can go to the MegaMicro company picnic if you *or* your spouse work for MegaMicro, Inc. The C++ equivalent is the logical OR operator, written `||`. This operator combines two expressions into one. If either or both of the original

expressions is true, or nonzero, the resulting expression has the value true. Otherwise, the expression has the value false. Here are some examples:

```
5 == 5 || 5 == 9    // true because first expression is true
5 > 3 || 5 > 10     // true because first expression is true
5 > 8 || 5 < 10     // true because second expression is true
5 < 8 || 5 > 2      // true because both expressions are true
5 > 8 || 5 < 2      // false because both expressions are false
```

Because the `||` has a lower precedence than the relational operators, you don't need to use parentheses in these expressions. Table 6.1 summarizes how the `||` operator works.

Table 6.1 The `||` Operator

| The Value of <code>expr1    expr2</code> |                            |                             |
|------------------------------------------|----------------------------|-----------------------------|
|                                          | <code>expr1 == true</code> | <code>expr1 == false</code> |
| <code>expr2 == true</code>               | true                       | true                        |
| <code>expr2 == false</code>              | true                       | false                       |

C++ provides that the `||` operator is a *sequence point*. That is, any value changes indicated on the left side take place before the right side is evaluated. (Or in the newer parlance of C++11, the subexpression to the left of the operator is sequenced before the subexpression to the right.) For example, consider the following expression:

```
i++ < 6 || i == j
```

Suppose `i` originally has the value 10. By the time the comparison with `j` takes place, `i` has the value 11. Also C++ won't bother evaluating the expression on the right if the expression on the left is true, for it only takes one true expression to make the whole logical expression true. (The semicolon and the comma operator, recall, are also sequence points.)

Listing 6.4 uses the `||` operator in an `if` statement to check for both uppercase and lowercase versions of a character. Also it uses C++'s string concatenation feature (see Chapter 4, "Compound Types") to spread a single string over three lines.

Listing 6.4 `or.cpp`

```
// or.cpp -- using the logical OR operator
#include <iostream>
int main()
{
    using namespace std;
    cout << "This program may reformat your hard disk\n"
         << "and destroy all your data.\n"
         << "Do you wish to continue? <y/n> ";
    char ch;
```

```

cin >> ch;
if (ch == 'y' || ch == 'Y')           // y or Y
    cout << "You were warned!\a\a\n";
else if (ch == 'n' || ch == 'N')     // n or N
    cout << "A wise choice ... bye\n";
else
    cout << "That wasn't a y or n! Apparently you "
           "can't follow\ninstructions, so "
           "I'll trash your disk anyway.\a\a\n";
return 0;
}

```

---

(The program doesn't really carry out any threats.) Here is a sample run of the program in Listing 6.4:

```

This program may reformat your hard disk
and destroy all your data.
Do you wish to continue? <y/n> N
A wise choice ... bye

```

The program reads just one character, so only the first character in the response matters. That means the user could have input **NO!** instead of **N**. The program would just read the **N**. But if the program tried to read more input later, it would start at the **o**.

## The Logical AND Operator: &&

The logical AND operator, written &&, also combines two expressions into one. The resulting expression has the value *true* only if *both* of the original expressions are *true*. Here are some examples:

```

5 == 5 && 4 == 4    // true because both expressions are true
5 == 3 && 4 == 4    // false because first expression is false
5 > 3 && 5 > 10     // false because second expression is false
5 > 8 && 5 < 10     // false because first expression is false
5 < 8 && 5 > 2      // true because both expressions are true
5 > 8 && 5 < 2      // false because both expressions are false

```

Because the && has a lower precedence than the relational operators, you don't need to use parentheses in these expressions. Like the || operator, the && operator acts as a sequence point, so the left side is evaluated, and any side effects are carried out before the right side is evaluated. If the left side is false, the whole logical expression must be false, so C++ doesn't bother evaluating the right side in that case. Table 6.2 summarizes how the && operator works.

Table 6.2 The &amp;&amp; Operator

| <i>The Value of</i> expr1 && expr2 |               |                |
|------------------------------------|---------------|----------------|
|                                    | expr1 == true | expr1 == false |
| expr2 == true                      | true          | false          |
| expr2 == false                     | false         | false          |

Listing 6.5 shows how to use && to cope with a common situation, terminating a while loop, for two different reasons. In the listing, a while loop reads values into an array. One test ( $i < \text{ArSize}$ ) terminates the loop when the array is full. The second test ( $\text{temp} \geq 0$ ) gives the user the option of quitting early by entering a negative number. The program uses the && operator to combine the two tests into a single condition. The program also uses two if statements, an if else statement, and a for loop, so it demonstrates several topics from this chapter and Chapter 5.

Listing 6.5 `and.cpp`

```
// and.cpp -- using the logical AND operator
#include <iostream>
const int ArSize = 6;
int main()
{
    using namespace std;
    float naaq[ArSize];
    cout << "Enter the NAAQs (New Age Awareness Quotients) "
         << "of\nyour neighbors. Program terminates "
         << "when you make\n" << ArSize << " entries "
         << "or enter a negative value.\n";

    int i = 0;
    float temp;
    cout << "First value: ";
    cin >> temp;
    while (i < ArSize && temp >= 0) // 2 quitting criteria
    {
        naaq[i] = temp;
        ++i;
        if (i < ArSize) // room left in the array,
        {
            cout << "Next value: ";
            cin >> temp; // so get next value
        }
    }
    if (i == 0)
        cout << "No data--bye\n";
}
```

```

else
{
    cout << "Enter your NAAQ: ";
    float you;
    cin >> you;
    int count = 0;
    for (int j = 0; j < i; j++)
        if (naaq[j] > you)
            ++count;
    cout << count;
    cout << " of your neighbors have greater awareness of\n"
        << "the New Age than you do.\n";
}
return 0;
}

```

---

Note that the program in Listing 6.5 places input into the temporary variable `temp`. Only after it verifies that the input is valid does the program assign the value to the array.

Here are a couple of sample runs of the program. One terminates after six entries:

```

Enter the NAAQs (New Age Awareness Quotients) of
your neighbors. Program terminates when you make
6 entries or enter a negative value.
First value: 28
Next value: 72
Next value: 15
Next value: 6
Next value: 130
Next value: 145
Enter your NAAQ: 50
3 of your neighbors have greater awareness of
the New Age than you do.

```

The second run terminates after a negative value is entered:

```

Enter the NAAQs (New Age Awareness Quotients) of
your neighbors. Program terminates when you make
6 entries or enter a negative value.
First value: 123
Next value: 119
Next value: 4
Next value: 89
Next value: -1
Enter your NAAQ: 123.031
0 of your neighbors have greater awareness of
the New Age than you do.

```

## Program Notes

The following is the input part of the program in Listing 6.5:

```
cin >> temp;
while (i < ArSize && temp >= 0) // 2 quitting criteria
{
    naaq[i] = temp;
    ++i;
    if (i < ArSize)           // room left in the array,
    {
        cout << "Next value: ";
        cin >> temp;         // so get next value
    }
}
```

The program begins by reading the first input value into a temporary variable called `temp`. Then the `while` test condition checks whether there is still room left in the array (`i < ArSize`) and whether the input value is non-negative (`temp >= 0`). If it is, the program copies the `temp` value to the array and increases the array index by one. At that point, because array numbering starts at zero, `i` equals the total number of entries to date. That is, if `i` starts out at 0, the first cycle through the loop assigns a value to `naaq[0]` and then sets `i` to 1.

The loop terminates when the array is filled or when the user enters a negative number. Note that the loop reads another value into `temp` only if `i` is less than `ArSize`—that is, only if there is still room left in the array.

After it gets data, the program uses an `if else` statement to comment if no data was entered (that is, if the first entry was a negative number) and to process the data if any is present.

## Setting Up Ranges with &&

The `&&` operator also lets you set up a series of `if else if else` statements, with each choice corresponding to a particular range of values. Listing 6.6 illustrates the approach. It also shows a useful technique for handling a series of messages. Just as a pointer-to-char variable can identify a single string by pointing to its beginning, an array of pointers-to-char can identify a series of strings. You simply assign the address of each string to a different array element. Listing 6.6 uses the `qualify` array to hold the addresses of four strings. For example, `qualify[1]` holds the address of the string "mud tug-of-war\n". The program can then use `qualify[1]` as it would any other pointer to a string—for example, with `cout` or with `strlen()` or `strcmp()`. Using the `const` qualifier protects these strings from accidental alterations.



Listing 6.6 `more_and.cpp`

---

```
// more_and.cpp -- using the logical AND operator
#include <iostream>
const char * qualify[4] =          // an array of pointers
{                                   // to strings
    "10,000-meter race.\n",
    "mud tug-of-war.\n",
    "masters canoe jousting.\n",
    "pie-throwing festival.\n"
};
int main()
{
    using namespace std;
    int age;
    cout << "Enter your age in years: ";
    cin >> age;
    int index;

    if (age > 17 && age < 35)
        index = 0;
    else if (age >= 35 && age < 50)
        index = 1;
    else if (age >= 50 && age < 65)
        index = 2;
    else
        index = 3;

    cout << "You qualify for the " << qualify[index];
    return 0;
}
```

---

Here is a sample run of the program in Listing 6.6:

```
Enter your age in years: 87
You qualify for the pie-throwing festival.
```

The entered age doesn't match any of the test ranges, so the program sets `index` to 3 and then prints the corresponding string.

### Program Notes

In Listing 6.6, the expression `age > 17 && age < 35` tests for ages between the two values—that is, ages in the range 18–34. The expression `age >= 35 && age < 50` uses the `>=` operator to include 35 in its range, which is 35–49. If the program used `age > 35 && age < 50`, the value 35 would be missed by all the tests. When you use range tests, you should check that the ranges don't have holes between them and that they don't overlap.

Also you need to be sure to set up each range correctly; see the sidebar “Range Tests,” later in this section.

The `if else` statement serves to select an array index, which, in turn, identifies a particular string.

### Range Tests

Note that each part of a range test should use the AND operator to join two complete relational expressions:

```
if (age > 17 && age < 35)    // OK
```

Don't borrow from mathematics and use the following notation:

```
if (17 < age < 35)          // Don't do this!
```

If you make this mistake, the compiler won't catch it as an error because it is still valid C++ syntax. The `<` operator associates from left to right, so the previous expression means the following:

```
if ( (17 < age) < 35)
```

But `17 < age` is either `true`, or `1`, or else `false`, or `0`. In either case, the expression `17 < age` is less than `35`, so the entire test is always `true`!

## The Logical NOT Operator: !

The `!` operator negates, or reverses the truth value of, the expression that follows it. That is, if `expression` is `true`, then `!expression` is `false`—and vice versa. More precisely, if `expression` is `true`, or nonzero, then `!expression` is `false`. Incidentally, many people call the exclamation point *bang*, making `!x` “bang-ex” and `!!x` “bang-bang-ex.”

Usually you can more clearly express a relationship without using the `!` operator:

```
if (!(x > 5))                // if (x <= 5) is clearer
```

But the `!` operator can be useful with functions that return `true/false` values or values that can be interpreted that way. For example, `strcmp(s1, s2)` returns a nonzero (`true`) value if the two C-style strings `s1` and `s2` are different from each other and a zero value if they are the same. This implies that `!strcmp(s1, s2)` is `true` if the two strings are equal.

Listing 6.7 uses the technique of applying the `!` operator to a function return value to screen numeric input for suitability to be assigned to type `int`. The user-defined function `is_int()`, which we'll discuss further in a moment, returns `true` if its argument is within the range of values that can be assigned to type `int`. The program then uses the test `while(!is_int(num))` to reject values that don't fit in the range.

### Listing 6.7 not.cpp

---

```
// not.cpp -- using the not operator
#include <iostream>
#include <climits>
```

```

bool is_int(double);
int main()
{
    using namespace std;
    double num;

    cout << "Yo, dude! Enter an integer value: ";
    cin >> num;
    while (!is_int(num))    // continue while num is not int-able
    {
        cout << "Out of range -- please try again: ";
        cin >> num;
    }
    int val = int (num);    // type cast
    cout << "You've entered the integer " << val << "\nBye\n";
    return 0;
}

bool is_int(double x)
{
    if (x <= INT_MAX && x >= INT_MIN)    // use climits values
        return true;
    else
        return false;
}

```

---

Here is a sample run of the program in Listing 6.7 on a system with a 32-bit int:

```

Yo, dude! Enter an integer value: 6234128679
Out of range -- please try again: -8000222333
Out of range -- please try again: 99999
You've entered the integer 99999
Bye

```

### Program Notes

If you enter a too-large value to a program reading a type `int`, many C++ implementations simply truncate the value to fit, without informing you that data was lost. The program in Listing 6.7 avoids that by first reading the potential `int` as a `double`. The `double` type has more than enough precision to hold a typical `int` value, and its range is much greater. Another choice for holding the input value would be the `long long` type, assuming that it is wider than `int`.

The Boolean function `is_int()` uses the two symbolic constants (`INT_MAX` and `INT_MIN`), defined in the `climits` file (discussed in Chapter 3, “Dealing with Data”), to determine whether its argument is within the proper limits. If so, the program returns a value of `true`; otherwise, it returns `false`.

The `main()` program uses a `while` loop to reject invalid input until the user gets it right. You could make the program friendlier by displaying the `int` limits when the input is out of range. After the input has been validated, the program assigns it to an `int` variable.

## Logical Operator Facts

As mentioned earlier in this chapter, the C++ logical OR and logical AND operators have a lower precedence than relational operators. This means that an expression such as this

```
x > 5 && x < 10
```

is interpreted this way:

```
(x > 5) && (x < 10)
```

The `!` operator, on the other hand, has a higher precedence than any of the relational or arithmetic operators. Therefore, to negate an expression, you should enclose the expression in parentheses, like this:

```
!(x > 5)    // is it false that x is greater than 5  
!x > 5     // is !x greater than 5
```

Incidentally, the second expression here is always `false` because `!x` can have only the values `true` or `false`, which get converted to 1 or 0.

The logical AND operator has a higher precedence than the logical OR operator. Thus this expression:

```
age > 30 && age < 45 || weight > 300
```

means the following:

```
(age > 30 && age < 45) || weight > 300
```

That is, one condition is that `age` be in the range 31–44, and the second condition is that `weight` be greater than 300. The entire expression is `true` if one or the other or both of these conditions are `true`.

You can, of course, use parentheses to tell the program the interpretation you want. For example, suppose you want to use `&&` to combine the condition that `age` be greater than 50 or `weight` be greater than 300 with the condition that `donation` be greater than 1,000. You have to enclose the OR part within parentheses:

```
(age > 50 || weight > 300) && donation > 1000
```

Otherwise, the compiler combines the `weight` condition with the `donation` condition instead of with the `age` condition.

Although the C++ operator precedence rules often make it possible to write compound comparisons without using parentheses, the simplest course of action is to use parentheses to group the tests, whether or not the parentheses are needed. It makes the code easier to read, it doesn't force someone else to look up some of the less commonly

used precedence rules, and it reduces the chance of making errors because you don't quite remember the exact rule that applies.

C++ guarantees that when a program evaluates a logical expression, it evaluates it from left to right and stops evaluation as soon as it knows what the answer is. Suppose, for example, that you have this condition:

```
x != 0 && 1.0 / x > 100.0
```

If the first condition is `false`, then the whole expression must be `false`. That's because for this expression to be `true`, each individual condition must be `true`. Knowing the first condition is `false`, the program doesn't bother evaluating the second condition. That's fortunate in this example because evaluating the second condition would result in dividing by zero, which is not in a computer's repertoire of possible actions.

## Alternative Representations

Not all keyboards provide all the symbols used for the logical operators, so the C++ Standard provides alternative representations, as shown in Table 6.3. The identifiers `and`, `or`, and `not` are C++ reserved words, meaning that you can't use them as names for variables and so on. They are not considered keywords because they are alternative representations of existing language features. Incidentally, these are not reserved words in C, but a C program can use them as operators, provided that the program includes the `iso646.h` header file. C++ does not require using a header file.

Table 6.3 Logical Operators: Alternative Representations

| Operator                | Alternative Representation |
|-------------------------|----------------------------|
| <code>&amp;&amp;</code> | <code>and</code>           |
| <code>  </code>         | <code>or</code>            |
| <code>!</code>          | <code>not</code>           |

## The `cctype` Library of Character Functions

C++ has inherited from C a handy package of character-related functions, prototyped in the `cctype` header file (`cctype.h`, in the older style), that simplify such tasks as determining whether a character is an uppercase letter or a digit or punctuation. For example, the `isalpha(ch)` function returns a nonzero value if `ch` is a letter and a zero value otherwise. Similarly, the `ispunct(ch)` function returns a `true` value only if `ch` is a punctuation character, such as a comma or period. (These functions have return type `int` rather than `bool`, but the usual `bool` conversions allow you to treat them as type `bool`.)

Using these functions is more convenient than using the AND and OR operators. For example, here's how you might use AND and OR to test whether a character `ch` is an alphabetic character:

```
if ((ch >= 'a' && ch <= 'z') || (ch >= 'A' && ch <= 'Z'))
```

Compare that to using `isalpha()`:

```
if (isalpha(ch))
```

Not only is `isalpha()` easier to use, it is more general. The AND/OR form assumes that character codes for A through Z are in sequence, with no other characters having codes in that range. This assumption is true for ASCII codes, but it isn't always true in general.

Listing 6.8 demonstrates some functions from the `ctype` family. In particular, it uses `isalpha()`, which tests for alphabetic characters; `isdigit()`, which tests for digit characters, such as 3; `isspace()`, which tests for whitespace characters, such as newlines, spaces, and tabs; and `ispunct()`, which tests for punctuation characters. The program also reviews the `if else if` structure and using a `while` loop with `cin.get(char)`.

#### Listing 6.8 `cctypes.cpp`

---

```
// cctypes.cpp -- using the ctype.h library
#include <iostream>
#include <ctype>           // prototypes for character functions
int main()
{
    using namespace std;
    cout << "Enter text for analysis, and type @"
         << " to terminate input.\n";
    char ch;
    int whitespace = 0;
    int digits = 0;
    int chars = 0;
    int punct = 0;
    int others = 0;

    cin.get(ch);           // get first character
    while (ch != '@')     // test for sentinel
    {
        if(isalpha(ch))   // is it an alphabetic character?
            chars++;
        else if(isspace(ch)) // is it a whitespace character?
            whitespace++;
        else if(isdigit(ch)) // is it a digit?
            digits++;
        else if(ispunct(ch)) // is it punctuation?
            punct++;
        else
            others++;
        cin.get(ch);     // get next character
    }
}
```

```

    cout << chars << " letters, "
         << whitespace << " whitespace, "
         << digits << " digits, "
         << punct << " punctuations, "
         << others << " others.\n";
    return 0;
}

```

---

Here is a sample run of the program in Listing 6.8 (note that the whitespace count includes newlines):

Enter text for analysis, and type @ to terminate input.

```

AdrenalVision International producer Adrienne Vismonger
announced production of their new 3-D film, a remake of
"My Dinner with Andre," scheduled for 2013. "Wait until
you see the the new scene with an enraged Collossipede!"@

```

177 letters, 33 whitespace, 5 digits, 9 punctuations, 0 others.

Table 6.4 summarizes the functions available in the `cctype` package. Some systems may lack some of these functions or have additional ones.

Table 6.4 The `cctype` Character Functions

| Function Name          | Return Value                                                                                                                                                                      |
|------------------------|-----------------------------------------------------------------------------------------------------------------------------------------------------------------------------------|
| <code>isalnum()</code> | This function returns <code>true</code> if the argument is alphanumeric (that is, a letter or a digit).                                                                           |
| <code>isalpha()</code> | This function returns <code>true</code> if the argument is alphabetic.                                                                                                            |
| <code>isblank()</code> | This function returns <code>true</code> if the argument is a space or a horizontal tab.                                                                                           |
| <code>iscntrl()</code> | This function returns <code>true</code> if the argument is a control character.                                                                                                   |
| <code>isdigit()</code> | This function returns <code>true</code> if the argument is a decimal digit (0–9).                                                                                                 |
| <code>isgraph()</code> | This function returns <code>true</code> if the argument is any printing character other than a space.                                                                             |
| <code>islower()</code> | This function returns <code>true</code> if the argument is a lowercase letter.                                                                                                    |
| <code>isprint()</code> | This function returns <code>true</code> if the argument is any printing character, including a space.                                                                             |
| <code>ispunct()</code> | This function returns <code>true</code> if the argument is a punctuation character.                                                                                               |
| <code>isspace()</code> | This function returns <code>true</code> if the argument is a standard white-space character (that is, a space, formfeed, newline, carriage return, horizontal tab, vertical tab). |
| <code>isupper()</code> | This function returns <code>true</code> if the argument is an uppercase letter.                                                                                                   |

Table 6.4 The `cctype` Character Functions

| Function Name           | Return Value                                                                                                                                                     |
|-------------------------|------------------------------------------------------------------------------------------------------------------------------------------------------------------|
| <code>isxdigit()</code> | This function returns <code>true</code> if the argument is a hexadecimal digit character (that is, 0–9, a–f, or A–F).                                            |
| <code>tolower()</code>  | If the argument is an uppercase character, <code>tolower()</code> returns the lowercase version of that character; otherwise, it returns the argument unaltered. |
| <code>toupper()</code>  | If the argument is a lowercase character, <code>toupper()</code> returns the uppercase version of that character; otherwise, it returns the argument unaltered.  |

## The ?: Operator

C++ has an operator that can often be used instead of the `if else` statement. This operator is called the *conditional operator*, written `?:`, and, for you trivia buffs, it is the only C++ operator that requires three operands. The general form looks like this:

```
expression1 ? expression2 : expression3
```

If *expression1* is true, then the value of the whole conditional expression is the value of *expression2*. Otherwise, the value of the whole expression is the value of *expression3*. Here are two examples that show how the operator works:

```
5 > 3 ? 10 : 12 // 5 > 3 is true, so expression value is 10
3 == 9 ? 25 : 18 // 3 == 9 is false, so expression value is 18
```

We can paraphrase the first example this way: If 5 is greater than 3, the expression evaluates to 10; otherwise, it evaluates to 12. In real programming situations, of course, the expressions would involve variables.

Listing 6.9 uses the conditional operator to determine the larger of two values.

### Listing 6.9 `condit.cpp`

```
// condit.cpp -- using the conditional operator
#include <iostream>
int main()
{
    using namespace std;
    int a, b;
    cout << "Enter two integers: ";
    cin >> a >> b;
    cout << "The larger of " << a << " and " << b;
    int c = a > b ? a : b; // c = a if a > b, else c = b
    cout << " is " << c << endl;
    return 0;
}
```



Here is a sample run of the program in Listing 6.9:

```
Enter two integers: 25 28
The larger of 25 and 28 is 28
```

The key part of the program is this statement:

```
int c = a > b ? a : b;
```

It produces the same result as the following statements:

```
int c;
if (a > b)
    c = a;
else
    c = b;
```

Compared to the `if else` sequence, the conditional operator is more concise but, at first glance, less obvious. One difference between the two approaches is that the conditional operator produces an expression and hence a single value that can be assigned or be incorporated into a larger expression, as the program in Listing 6.9 does when it assigns the value of the conditional expression to the variable `c`. The conditional operator's concise form, unusual syntax, and overall weird appearance make it a great favorite among programmers who appreciate those qualities. One favorite trick for the reprehensible goal of concealing the purpose of code is to nest conditional expressions within one another, as the following mild example shows:

```
const char x[2] [20] = {"Jason ", "at your service\n"};
const char * y = "Quillstone ";

for (int i = 0; i < 3; i++)
    cout << ((i < 2)? !i ? x [i] : y : x[1]);
```

This is merely an obscure (but, by no means maximally obscure) way to print the three strings in the following order:

```
Jason Quillstone at your service
```

In terms of readability, the conditional operator is best suited for simple relationships and simple expression values:

```
x = (x > y) ? x : y;
```

If the code becomes more involved, it can probably be expressed more clearly as an `if else` statement.

## The `switch` Statement

Suppose you create a screen menu that asks the user to select one of five choices—for example, Cheap, Moderate, Expensive, Extravagant, and Excessive. You can extend an `if else if else` sequence to handle five alternatives, but the C++ `switch` statement more

easily handles selecting a choice from an extended list. Here's the general form for a switch statement:

```
switch (integer-expression)
{
    case label1 : statement(s)
    case label2 : statement(s)
    ...
    default    : statement(s)
}
```

A C++ switch statement acts as a routing device that tells the computer which line of code to execute next. On reaching a switch statement, a program jumps to the line labeled with the value corresponding to the value of *integer-expression*. For example, if *integer-expression* has the value 4, the program goes to the line that has a case 4: label. The value *integer-expression*, as the name suggests, must be an expression that reduces to an integer value. Also each label must be an integer constant expression. Most often, labels are simple int or char constants, such as 1 or 'q', or enumerators. If *integer-expression* doesn't match any of the labels, the program jumps to the line labeled default. The default label is optional. If you omit it and there is no match, the program jumps to the next statement following the switch (see Figure 6.3).

The switch statement is different from similar statements in languages such as Pascal in a very important way. Each C++ case label functions only as a line label, not as a boundary between choices. That is, after a program jumps to a particular line in a switch, it then sequentially executes all the statements following that line in the switch unless you explicitly direct it otherwise. Execution does *not* automatically stop at the next case. To make execution stop at the end of a particular group of statements, you must use the break statement. This causes execution to jump to the statement following the switch.

Listing 6.10 shows how to use switch and break together to implement a simple menu for executives. The program uses a showmenu() function to display a set of choices. A switch statement then selects an action based on the user's response.

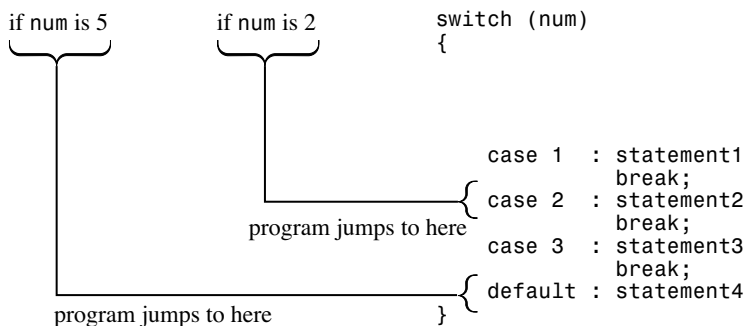

Figure 6.3 The structure of switch statements.

**Note**

Some hardware/operating system combinations treat the `\a` escape sequence (used in case 1 in Listing 6.10) as silent.

**Listing 6.10** `switch.cpp`

```
// switch.cpp -- using the switch statement
#include <iostream>
using namespace std;
void showmenu(); // function prototypes
void report();
void comfort();
int main()
{
    showmenu();
    int choice;
    cin >> choice;
    while (choice != 5)
    {
        switch(choice)
        {
            case 1 : cout << "\a\n";
                    break;
            case 2 : report();
                    break;
            case 3 : cout << "The boss was in all day.\n";
                    break;
            case 4 : comfort();
                    break;
            default : cout << "That's not a choice.\n";
        }
        showmenu();
        cin >> choice;
    }
    cout << "Bye!\n";
    return 0;
}

void showmenu()
{
    cout << "Please enter 1, 2, 3, 4, or 5:\n"
          "1) alarm          2) report\n"
          "3) alibi           4) comfort\n"
          "5) quit\n";
}

void report()
```

```
{
    cout << "It's been an excellent week for business.\n"
         "Sales are up 120%. Expenses are down 35%.\n";
}
void comfort()
{
    cout << "Your employees think you are the finest CEO\n"
         "in the industry. The board of directors think\n"
         "you are the finest CEO in the industry.\n";
}
```

---

Here is a sample run of the executive menu program in Listing 6.10:

```
Please enter 1, 2, 3, 4, or 5:
1) alarm          2) report
3) alibi          4) comfort
5) quit
4
Your employees think you are the finest CEO
in the industry. The board of directors think
you are the finest CEO in the industry.
Please enter 1, 2, 3, 4, or 5:
1) alarm          2) report
3) alibi          4) comfort
5) quit
2
It's been an excellent week for business.
Sales are up 120%. Expenses are down 35%.
Please enter 1, 2, 3, 4, or 5:
1) alarm          2) report
3) alibi          4) comfort
5) quit
6
That's not a choice.
Please enter 1, 2, 3, 4, or 5:
1) alarm          2) report
3) alibi          4) comfort
5) quit
5
Bye!
```

The while loop terminates when the user enters **5**. Entering **1** through **4** activates the corresponding choice from the switch list, and entering **6** triggers the default statements.

Note that input has to be an integer for this program to work correctly. If, for example, you enter a letter, the input statement will fail, and the loop will cycle endlessly until you kill the program. To deal with those who don't follow instructions, it's better to use character input.

As noted earlier, this program needs the `break` statements to confine execution to a particular portion of a `switch` statement. To see that this is so, you can remove the `break` statements from Listing 6.10 and see how it works afterward. You'll find, for example, that entering 2 causes the program to execute *all* the statements associated with case labels 2, 3, 4, and the default. C++ works this way because that sort of behavior can be useful. For one thing, it makes it simple to use multiple labels. For example, suppose you rewrote Listing 6.10 using characters instead of integers as menu choices and switch labels. In that case, you could use both an uppercase and a lowercase label for the same statements:

```
char choice;
cin >> choice;
while (choice != 'Q' && choice != 'q')
{
    switch(choice)
    {
        case 'a':
        case 'A': cout << "\a\n";
                break;

        case 'r':
        case 'R': report();
                break;

        case 'l':
        case 'L': cout << "The boss was in all day.\n";
                break;

        case 'c':
        case 'C': comfourt();
                break;

        default : cout << "That's not a choice.\n";
    }
    showmenu();
    cin >> choice;
}
```

Because there is no `break` immediately following case 'a', program execution passes on to the next line, which is the statement following case 'A'.

## Using Enumerators as Labels

Listing 6.11 illustrates using `enum` to define a set of related constants and then using the constants in a `switch` statement. In general, `cin` doesn't recognize enumerated types (it can't know how you will define them), so the program reads the choice as an `int`. When the `switch` statement compares the `int` value to an enumerator case label, it promotes the enumerator to `int`. Also the enumerators are promoted to type `int` in the `while` loop test condition.

Listing 6.11 `enum.cpp`

---

```
// enum.cpp -- using enum
#include <iostream>
// create named constants for 0 - 6
enum {red, orange, yellow, green, blue, violet, indigo};

int main()
{
    using namespace std;
    cout << "Enter color code (0-6): ";
    int code;
    cin >> code;
    while (code >= red && code <= indigo)
    {
        switch (code)
        {
            case red    : cout << "Her lips were red.\n"; break;
            case orange : cout << "Her hair was orange.\n"; break;
            case yellow  : cout << "Her shoes were yellow.\n"; break;
            case green   : cout << "Her nails were green.\n"; break;
            case blue    : cout << "Her sweatsuit was blue.\n"; break;
            case violet  : cout << "Her eyes were violet.\n"; break;
            case indigo  : cout << "Her mood was indigo.\n"; break;
        }
        cout << "Enter color code (0-6): ";
        cin >> code;
    }
    cout << "Bye\n";
    return 0;
}
```

---

Here's sample output from the program in Listing 6.11:

```
Enter color code (0-6): 3
Her nails were green.
Enter color code (0-6): 5
Her eyes were violet.
Enter color code (0-6): 2
Her shoes were yellow.
Enter color code (0-6): 8
Bye
```

## switch and if else

Both the `switch` statement and the `if else` statement let a program select from a list of alternatives. The `if else` is the more versatile of the two. For example, it can handle ranges, as in the following:

```
if (age > 17 && age < 35)
    index = 0;
else if (age >= 35 && age < 50)
    index = 1;
else if (age >= 50 && age < 65)
    index = 2;
else
    index = 3;
```

The `switch` statement, on the other hand, isn't designed to handle ranges. Each `switch` case label must be a single value. Also that value must be an integer (which includes `char`), so a `switch` statement can't handle floating-point tests. And the case label value must be a constant. If your alternatives involve ranges or floating-point tests or comparing two variables, you should use `if else`.

If, however, all the alternatives can be identified with integer constants, you can use a `switch` or an `if else` statement. Because that's precisely the situation that the `switch` statement is designed to process, the `switch` statement is usually the more efficient choice in terms of code size and execution speed, unless there are only a couple alternatives from which to choose.

### Tip

If you can use either an `if else if` sequence or a `switch` statement, the usual practice is to use `switch` if you have three or more alternatives.

## The `break` and `continue` Statements

The `break` and `continue` statements enable a program to skip over parts of the code. You can use the `break` statement in a `switch` statement and in any of the loops. It causes program execution to pass to the next statement following the `switch` or the loop. The `continue` statement is used in loops and causes a program to skip the rest of the body of the loop and then start a new loop cycle (see Figure 6.4).

Listing 6.12 shows how the two statements work. The program lets you enter a line of text. The loop echoes each character and uses `break` to terminate the loop if the character is a period. This shows how you can use `break` to terminate a loop from within when some condition becomes `true`. Next the program counts spaces but not other characters. The loop uses `continue` to skip over the counting part of the loop when the character isn't a space.

### Listing 6.12 `jump.cpp`

```
// jump.cpp -- using continue and break
#include <iostream>
const int ArSize = 80;
int main()
{
    using namespace std;
```

```

char line[ArSize];
int spaces = 0;

cout << "Enter a line of text:\n";
cin.get(line, ArSize);
cout << "Complete line:\n" << line << endl;
cout << "Line through first period:\n";
for (int i = 0; line[i] != '\0'; i++)
{
    cout << line[i];    // display character
    if (line[i] == '.') // quit if it's a period
        break;
    if (line[i] != ' ') // skip rest of loop
        continue;
    spaces++;
}
cout << "\n" << spaces << " spaces\n";
cout << "Done.\n";
return 0;
}

```

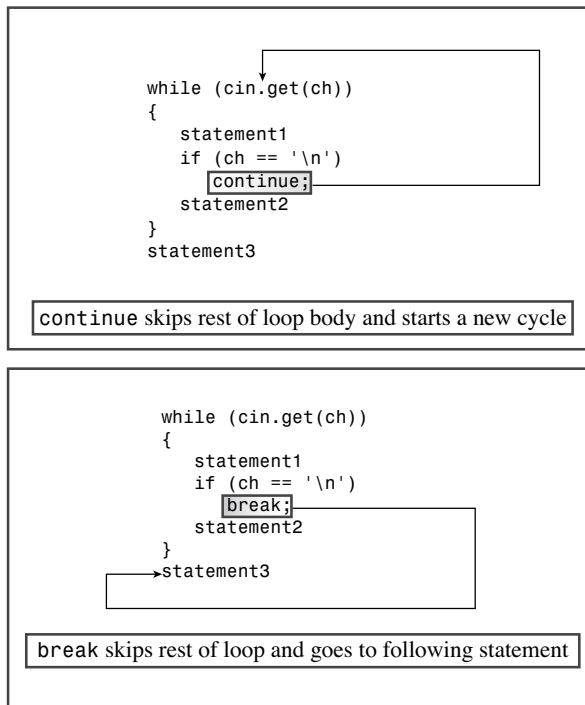
Figure 6.4 The structure of `continue` and `break` statements.



Here's a sample run of the program in Listing 6.12:

```
Enter a line of text:
Let's do lunch today. You can pay!
Complete line:
Let's do lunch today. You can pay!
Line through first period:
Let's do lunch today.
3 spaces
Done.
```

## Program Notes

Note that whereas the `continue` statement causes the program in Listing 6.12 to skip the rest of the loop body, it doesn't skip the loop update expression. In a `for` loop, the `continue` statement makes the program skip directly to the update expression and then to the test expression. For a `while` loop, however, `continue` makes the program go directly to the test expression. So any update expression in a `while` loop body following the `continue` would be skipped. In some cases, that could be a problem.

This program doesn't have to use `continue`. Instead, it could use this code:

```
if (line[i] == ' ')
    spaces++;
```

However, the `continue` statement can make a program more readable when several statements follow the `continue`. That way, you don't need to make all those statements part of an `if` statement.

C++, like C, also has a `goto` statement. A statement like this means to jump to the location bearing the `paris: label`:

```
goto paris;
```

That is, you can have code like this:

```
char ch;
cin >> ch;
if (ch == 'P')
    goto paris;
cout << ...
...
paris: cout << "You've just arrived at Paris.\n";
```

In most circumstances (some would say in all circumstances), using `goto` is a bad hack, and you should use structured controls, such as `if else`, `switch`, `continue`, and the like, to control program flow.

## Number-Reading Loops

Say you're preparing a program to read a series of numbers into an array. You want to give the user the option to terminate input before filling the array. One way to do this is utilize how `cin` behaves. Consider the following code:

```
int n;  
cin >> n;
```

What happens if the user responds by entering a word instead of a number? Four things occur in such a mismatch:

- The value of `n` is left unchanged.
- The mismatched input is left in the input queue.
- An error flag is set in the `cin` object.
- The call to the `cin` method, if converted to type `bool`, returns `false`.

The fact that the method returns `false` means that you can use non-numeric input to terminate a number-reading loop. The fact that non-numeric input sets an error flag means that you have to reset the flag before the program can read more input. The `clear()` method, which also resets the end-of-file (EOF) condition (see Chapter 5), resets the bad input flag. (Either bad input or the EOF can cause `cin` to return `false`. Chapter 17, "Input, Output, and Files," discusses how to distinguish between the two cases.) Let's look at a couple examples that illustrate these techniques.

Say you want to write a program that calculates the average weight of your day's catch of fish. There's a five-fish limit, so a five-element array can hold all the data, but it's possible that you could catch fewer fish. Listing 6.13 uses a loop that terminates if the array is full or if you enter non-numeric input.

### Listing 6.13 `cinfish.cpp`

---

```
// cinfish.cpp -- non-numeric input terminates loop  
#include <iostream>  
const int Max = 5;  
int main()  
{  
    using namespace std;  
    // get data  
    double fish[Max];  
    cout << "Please enter the weights of your fish.\n";  
    cout << "You may enter up to " << Max  
        << " fish <q to terminate>.\n";  
    cout << "fish #1: ";  
    int i = 0;  
    while (i < Max && cin >> fish[i]) {  
        if (++i < Max)  
            cout << "fish #" << i+1 << ": ";
```

```

    }
// calculate average
    double total = 0.0;
    for (int j = 0; j < i; j++)
        total += fish[j];
// report results
    if (i == 0)
        cout << "No fish\n";
    else
        cout << total / i << " = average weight of "
            << i << " fish\n";
    cout << "Done.\n";
    return 0;
}

```

---

### Note

As mentioned earlier, some execution environments require additional code to keep the window open so that you can see the output. In this example, because the input 'q' turns off further input, the treatment is more elaborate:

```

if (!cin) // input terminated by non-numeric response
{
    cin.clear(); // reset input
    cin.get(); // read q
}
cin.get(); // read end of line after last input
cin.get(); // wait for user to press <Enter>

```

You also could use code similar to this in Listing 6.13 if you wanted the program to accept more input after exiting the loop.

Listing 6.14 further illustrates using the `cin` return value and resetting `cin`.

The expression `cin >> fish[i]` in Listing 6.13 is really a `cin` method function call, and the function returns `cin`. If `cin` is part of a test condition, it's converted to type `bool`. The conversion value is `true` if input succeeds and `false` otherwise. A `false` value for the expression terminates the loop. By the way, here's a sample run of the program:

```

Please enter the weights of your fish.
You may enter up to 5 fish <q to terminate>.
fish #1: 30
fish #2: 35
fish #3: 25
fish #4: 40
fish #5: q
32.5 = average weight of 4 fish
Done.

```

Note the following line of code:

```
while (i < Max && cin >> fish[i]) {
```

Recall that C++ doesn't evaluate the right side of a logical AND expression if the left side is `false`. In such a case, evaluating the right side means using `cin` to place input into the array. If `i` does equal `Max`, the loop terminates without trying to read a value into a location past the end of the array.

The preceding example doesn't attempt to read any input after non-numeric input. Let's look at a case that does. Suppose you are required to submit exactly five golf scores to a C++ program to establish your average. If a user enters non-numeric input, the program should object, insisting on numeric input. As you've seen, you can use the value of a `cin` input expression to test for non-numeric input. Suppose the program finds that the user enters the wrong stuff. It needs to take three steps:

1. Reset `cin` to accept new input.
2. Get rid of the bad input.
3. Prompt the user to try again.

Note that the program has to reset `cin` before getting rid of the bad input. Listing 6.14 shows how these tasks can be accomplished.

#### Listing 6.14 `cingolf.cpp`

---

```
// cingolf.cpp -- non-numeric input skipped
#include <iostream>
const int Max = 5;
int main()
{
    using namespace std;
    // get data
    int golf[Max];
    cout << "Please enter your golf scores.\n";
    cout << "You must enter " << Max << " rounds.\n";
    int i;
    for (i = 0; i < Max; i++)
    {
        cout << "round #" << i+1 << ": ";
        while (!(cin >> golf[i])) {
            cin.clear();    // reset input
            while (cin.get() != '\n')
                continue;  // get rid of bad input
            cout << "Please enter a number: ";
        }
    }
    // calculate average
```

```

    double total = 0.0;
    for (i = 0; i < Max; i++)
        total += golf[i];
// report results
    cout << total / Max << " = average score "
         << Max << " rounds\n";
    return 0;
}

```

---

Here is a sample run of the program in Listing 6.14:

```

Please enter your golf scores.
You must enter 5 rounds.
round #1: 88
round #2: 87
round #3: must i?
Please enter a number: 103
round #4: 94
round #5: 86
91.6 = average score 5 rounds

```

## Program Notes

The heart of the error-handling code in Listing 6.14 is the following:

```

while (!(cin >> golf[i])) {
    cin.clear(); // reset input
    while (cin.get() != '\n')
        continue; // get rid of bad input
    cout << "Please enter a number: ";
}

```

If the user enters **88**, the `cin` expression is `true`, and a value is placed in the array. Furthermore, because `cin` is `true`, the expression `!(cin >> golf[i])` is `false`, and this inner loop terminates. But if the user enters **must i?**, the `cin` expression is `false`, nothing is placed into the array, the expression `!(cin >> golf[i])` is `true`, and the program enters the inner `while` loop. The first statement in the loop uses the `clear()` method to reset input. If you omit this statement, the program refuses to read any more input. Next, the program uses `cin.get()` in a `while` loop to read the remaining input through the end of the line. This gets rid of the bad input, along with anything else on the line. Another approach is to read to the next whitespace, which gets rid of bad input one word at a time instead of one line at a time. Finally, the program tells the user to enter a number.

## Simple File Input/Output

Sometimes keyboard input is not the best choice. For example, suppose you've written a program to analyze stocks, and you've downloaded a file of 1,000 stock prices. It would be far more convenient to have the program read the file directly than to hand-enter all the values. Similarly, it can be convenient to have a program write output to a file so that you have a permanent record of the results.

Fortunately, C++ makes it simple to transfer the skills you've acquired for keyboard input and display output (collectively termed *console I/O*) to file input and output (*file I/O*). Chapter 17 explores these topics more extensively, but we'll look at simple text file I/O now.

### Text I/O and Text Files

Let's re-examine the concept of text *I/O*. When you use `cin` for input, the program views input as a series of bytes, with each byte being interpreted as a character code. No matter what the destination data type, the input begins as character data—that is, text data. The `cin` object then has the responsibility of translating text to other types. To see how this works, let's examine how different code handles the same line of input.

Suppose you have the following sample line of input:

**38.5 19.2**

Let's see how this line of input is handled by `cin` when used with different data types. First, let's try type `char`:

```
char ch;  
cin >> ch;
```

The first character in the input line is assigned to `ch`. In this case, the first character is the digit 3, and the character code (in binary) for this digit is stored in `ch`. The input and the destination are both characters, so no translation is needed. (Note that it's not the numeric value 3 that is stored; rather, it is the character code for the digit 3.) After the input statement, the digit character 8 is the next character in the input queue and will be the next character examined by the next input operation.

Next, let's try the `int` type with the same input:

```
int n;  
cin >> n;
```

In this case, `cin` reads up to the first non-digit character. That is, it reads the 3 digit and the 8 digit, leaving the period as the next character in the input queue. Then `cin` computes that these two characters correspond to the numeric value 38, and the binary code for 38 is copied to `n`.

Next, let's try the `double` type:

```
double x;  
cin >> x;
```

In this case, `cin` reads up to the first character that's not part of a floating-point number. That is, it reads the 3 digit, the 8 digit, the period character, and the 5 digit, leaving the space as the next character in the input queue. Then `cin` computes that these four characters correspond to the numeric value 38.5, and the binary code (floating-point format) for 38.5 is copied to `x`.

Next, let's try the `char` array type:

```
char word[50];
cin >> word;
```

In this case, `cin` reads up to the whitespace character. That is, it reads the 3 digit, the 8 digit, the period character, and the 5 digit, leaving the space as the next character in the input queue. Then `cin` stores the character code for these four characters in the array `word` and adds a terminating null character. No translation is needed.

Finally, let's try an input variant for the `char` array type:

```
char word[50];
cin.getline(word,50);
```

In this case, `cin` reads up through the newline character (the sample input line had fewer than 50 characters). All the characters through the final 2 digit are stored in the array `word`, and a null character is added. The newline character is discarded, and the next character in the input queue will be the first character on the next line. No translation is needed.

On output, the opposite translations take place. That is, integers are converted to sequences of digit characters, and floating-point numbers are converted to sequences of digits and other characters (for example, 284.53 or -1.587E+06). Character data requires no translation.

The main point to this is that all the input starts out as text. Therefore, the file equivalent to console input is a text file—that is, a file in which each byte stores a character code. Not all files are text files. For example, databases and spreadsheets store numeric data in numeric forms—that is, in binary integer or binary floating-point form. Also, word processing files may contain text information, but they also contain non-text data to describe formatting, fonts, printers, and the like.

The file I/O discussed in this chapter parallels console I/O and thus should be used with text files. To create a text file for input, you use a text editor, such as Notepad for Windows, or `vi` or `emacs` for Unix/Linux. You can use a word processor, as long as you save the file in text format. The code editors that are part of IDEs also produce text files; indeed, the source code files are examples of text files. Similarly, you can use text editors to look at files created with text output.

## Writing to a Text File

For file output, C++ uses analogs to `cout`. So to prepare for file output, let's review some basic facts about using `cout` for console output:

- You must include the `iostream` header file.
- The `iostream` header file defines an `ostream` class for handling output.
- The `iostream` header file declares an `ostream` variable, or object, called `cout`.
- You must account for the `std` namespace; for example, you can use the `using` directive or the `std::` prefix for elements such as `cout` and `endl`.
- You can use `cout` with the `<<` operator to read a variety of data types.

File output parallels this very closely:

- You must include the `fstream` header file.
- The `fstream` header file defines an `ofstream` class for handling output.
- You need to declare one or more `ofstream` variables, or objects, which you can name as you please, as long as you respect the usual naming conventions.
- You must account for the `std` namespace; for example, you can use the `using` directive or the `std::` prefix for elements such as `ofstream`.
- You need to associate a specific `ofstream` object with a specific file; one way to do so is to use the `open()` method.
- When you're finished with a file, you should use the `close()` method to close the file.
- You can use an `ofstream` object with the `<<` operator to output a variety of data types.

Note that although the `iostream` header file provides a predefined `ostream` object called `cout`, you have to declare your own `ofstream` object, choosing a name for it and associating it with a file. Here's how you declare such objects:

```
ofstream outFile;           // outFile an ofstream object
ofstream fout;             // fout an ofstream object
```

Here's how you can associate the objects with particular files:

```
outFile.open("fish.txt");  // outFile used to write to the fish.txt file
char filename[50];
cin >> filename;          // user specifies a name
fout.open(filename);      // fout used to read specified file
```

Note that the `open()` method requires a C-style string as its argument. This can be a literal string or a string stored in an array.

Here's how you can use these objects:

```
double wt = 125.8;
outFile << wt;             // write a number to fish.txt
char line[81] = "Objects are closer than they appear.";
fout << line << endl;     // write a line of text
```

The important point is that after you've declared an `ofstream` object and associated it with a file, you use it exactly as you would use `cout`. All the operations and methods



available to `cout`, such as `<<`, `endl`, and `setf()`, are also available to `ofstream` objects, such as `outFile` and `fout` in the preceding examples.

In short, these are the main steps for using file output:

1. Include the `fstream` header file.
2. Create an `ofstream` object.
3. Associate the `ofstream` object with a file.
4. Use the `ofstream` object in the same manner you would use `cout`.

The program in Listing 6.15 demonstrates this approach. It solicits information from the user, sends output to the display, and then sends the same output to a file. You can use a text editor to examine the output file.

#### Listing 6.15 `outfile.cpp`

---

```
// outfile.cpp -- writing to a file
#include <iostream>
#include <fstream>                // for file I/O

int main()
{
    using namespace std;

    char automobile[50];
    int year;
    double a_price;
    double d_price;

    ofstream outFile;            // create object for output
    outFile.open("carinfo.txt"); // associate with a file

    cout << "Enter the make and model of automobile: ";
    cin.getline(automobile, 50);
    cout << "Enter the model year: ";
    cin >> year;
    cout << "Enter the original asking price: ";
    cin >> a_price;
    d_price = 0.913 * a_price;

    // display information on screen with cout

    cout << fixed;
    cout.precision(2);
    cout.setf(ios_base::showpoint);
    cout << "Make and model: " << automobile << endl;
    cout << "Year: " << year << endl;
```

```
    cout << "Was asking $" << a_price << endl;
    cout << "Now asking $" << d_price << endl;

// now do exact same things using outFile instead of cout

    outFile << fixed;
    outFile.precision(2);
    outFile.setf(ios_base::showpoint);
    outFile << "Make and model: " << automobile << endl;
    outFile << "Year: " << year << endl;
    outFile << "Was asking $" << a_price << endl;
    outFile << "Now asking $" << d_price << endl;

    outFile.close();           // done with file
    return 0;
}
```

---

Note that the final section of the program in Listing 6.15 duplicates the `cout` section, with `cout` replaced by `outFile`. Here is a sample run of this program:

```
Enter the make and model of automobile: Flitz Perky
Enter the model year: 2009
Enter the original asking price: 13500
Make and model: Flitz Perky
Year: 2009
Was asking $13500.00
Now asking $12325.50
```

The screen output comes from using `cout`. If you check the directory or folder that contains the executable program, you should find a new file called `carinfo.txt`. (Or it may be in some other folder, depending on how the compiler is configured.) It contains the output generated by using `outFile`. If you open it with a text editor, you should find the following contents:

```
Make and model: Flitz Perky
Year: 2009
Was asking $13500.00
Now asking $12325.50
```

As you can see, `outFile` sends precisely the same sequence of characters to the `carinfo.txt` file that `cout` sends to the display.

## Program Notes

After the program in Listing 6.15 declares an `ofstream` object, you can use the `open()` method to associate the object with a particular file:

```
ofstream outFile;           // create object for output
outFile.open("carinfo.txt"); // associate with a file
```

When the program is done using a file, it should close the connection:

```
outFile.close();
```

Notice that the `close()` method doesn't require a filename. That's because `outFile` has already been associated with a particular file. If you forget to close a file, the program will close it automatically if the program terminates normally.

Notice that `outFile` can use the same methods that `cout` does. Not only can it use the `<<` operator, but it can use the various formatting methods, such as `setf()` and `precision()`. These methods affect only the object that invokes the method. For example, you can provide different values for different objects:

```
cout.precision(2);           // use a precision of 2 for the display
outFile.precision(4);       // use a precision of 4 for file output
```

The main point you should remember is that after you set up an `ofstream` object such as `outFile`, you use it in precisely the same matter as you use `cout`.

Let's go back to the `open()` method:

```
outFile.open("carinfo.txt");
```

In this case, the file `carinfo.txt` does not exist before the program runs. In this circumstance, the `open()` method creates a brand new file by that name. When the file `carinfo.txt` exists, what happens if you run the program again? By default, `open()` first truncates the file; that is, it trims `carinfo.txt` to zero length, discarding the current contents. The contents are then replaced with the new output. Chapter 17 reveals how to override this default behavior.

### Caution

When you open an existing file for output, by default it is truncated to a length of zero bytes, so the contents are lost.

It is possible that an attempt to open a file for output might fail. For example, a file having the requested name might already exist and have restricted access. Therefore, a careful programmer would check to see if the attempt succeeded. You'll learn the technique for this in the next example.

## Reading from a Text File

Next, let's examine text file input. It's based on console input, which has many elements. So let's begin with a summary those elements:

- You must include the `iostream` header file.
- The `iostream` header file defines an `istream` class for handling input.
- The `iostream` header file declares an `istream` variable, or object, called `cin`.
- You must account for the `std` namespace; for example, you can use the `using` directive or the `std::` prefix for elements such as `cin`.

- You can use `cin` with the `>>` operator to read a variety of data types.
- You can use `cin` with the `get()` method to read individual characters and with the `getline()` method to read a line of characters at a time.
- You can use `cin` with methods such as `eof()` and `fail()` to monitor the success of an input attempt.
- The object `cin` itself, when used as a test condition, is converted to the Boolean value `true` if the last read attempt succeeded and to `false` otherwise.

File input parallels this very closely:

- You must include the `fstream` header file.
- The `fstream` header file defines an `ifstream` class for handling input.
- You need to declare one or more `ifstream` variables, or objects, which you can name as you please, as long as you respect the usual naming conventions.
- You must account for the `std` namespace; for example, you can use the `using` directive or the `std::` prefix for elements such as `ifstream`.
- You need to associate a specific `ifstream` object with a specific file; one way to do so is to use the `open()` method.
- When you're finished with a file, you should use the `close()` method to close the file.
- You can use an `ifstream` object with the `>>` operator to read a variety of data types.
- You can use an `ifstream` object with the `get()` method to read individual characters and with the `getline()` method to read a line of characters at a time.
- You can use an `ifstream` object with methods such as `eof()` and `fail()` to monitor the success of an input attempt.
- An `ifstream` object itself, when used as a test condition, is converted to the Boolean value `true` if the last read attempt succeeded and to `false` otherwise.

Note that although the `iostream` header file provides a predefined `istream` object called `cin`, you have to declare your own `ifstream` object, choosing a name for it and associating it with a file. Here's how you declare such objects:

```
ifstream inFile;           // inFile an ifstream object
ifstream fin;             // fin an ifstream object
```

Here's how you can associate them with particular files:

```
inFile.open("bowling.txt"); // inFile used to read bowling.txt file
char filename[50];
cin >> filename;           // user specifies a name
fin.open(filename);       // fin used to read specified file
```

Note that the `open()` method requires a C-style string as its argument. This can be a literal string or a string stored in an array.

Here's how you can use these objects:

```
double wt;
inFile >> wt;           // read a number from bowling.txt
char line[81];
fin.getline(line, 81); // read a line of text
```

The important point is that after you've declared an `ifstream` object and associated it with a file, you can use it exactly as you would use `cin`. All the operations and methods available to `cin` are also available to `ifstream` objects, such as `inFile` and `fin` in the preceding examples.

What happens if you attempt to open a non-existent file for input? This error causes subsequent attempts to use the `ifstream` object for input to fail. The preferred way to check whether a file was opened successfully is to use the `is_open()` method. You can use code like this:

```
inFile.open("bowling.txt");
if (!inFile.is_open())
{
    exit(EXIT_FAILURE);
}
```

The `is_open()` method returns `true` if the file was opened successfully, so the expression `!inFile.is_open()` is `true` if the attempt fails. The `exit()` function is prototyped in the `cstdlib` header file, which also defines `EXIT_FAILURE` as an argument value used to communicate with the operating system. The `exit()` function terminates the program.

The `is_open()` method is relatively new to C++. If your compiler doesn't support it, you can use the older `good()` method instead. As Chapter 17 discusses, `good()` doesn't check quite as extensively as `is_open()` for possible problems.

The program in Listing 6.16 opens a file specified by the user, reads numbers from the file, and reports the number of values, their sum, and their average. It's important that you design the input loop correctly, and the following "Program Notes" section discusses this in more detail. Notice that this program benefits greatly from using `if` statements.

#### Listing 6.16 `sumafile.cpp`

---

```
// sumafile.cpp -- functions with an array argument
#include <iostream>
#include <fstream>           // file I/O support
#include <cstdlib>          // support for exit()
const int SIZE = 60;
int main()
{
    using namespace std;
    char filename[SIZE];
    ifstream inFile;       // object for handling file input
```

```
cout << "Enter name of data file: ";
cin.getline(filename, SIZE);
inFile.open(filename); // associate inFile with a file
if (!inFile.is_open()) // failed to open file
{
    cout << "Could not open the file " << filename << endl;
    cout << "Program terminating.\n";
    exit(EXIT_FAILURE);
}
double value;
double sum = 0.0;
int count = 0;           // number of items read

inFile >> value;        // get first value
while (inFile.good())  // while input good and not at EOF
{
    ++count;           // one more item read
    sum += value;      // calculate running total
    inFile >> value;   // get next value
}
if (inFile.eof())
    cout << "End of file reached.\n";
else if (inFile.fail())
    cout << "Input terminated by data mismatch.\n";
else
    cout << "Input terminated for unknown reason.\n";
if (count == 0)
    cout << "No data processed.\n";
else
{
    cout << "Items read: " << count << endl;
    cout << "Sum: " << sum << endl;
    cout << "Average: " << sum / count << endl;
}
inFile.close();        // finished with the file
return 0;
}
```

---

To use the program in Listing 6.16, you first have to create a text file that contains numbers. You can use a text editor, such as the text editor you use to write source code, to create this file. Let's assume that the file is called `scores.txt` and has the following contents:

```
18 19 18.5 13.5 14
16 19.5 20 18 12 18.5
17.5
```

The program has to be able to find the file. Typically, unless your input includes a path-name with the file, the program will look in the same folder or directory that contains the executable file.

### Caution

A Windows text file uses the carriage return character followed by a linefeed character to terminate a line of text. (The usual C++ text mode translates this combination to newline character when reading a file and reverses the translation when writing to a file.) Some text editors, such as the Metrowerks CodeWarrior IDE editor, don't automatically add a this combination to the final line. Therefore, if you use such an editor, you need to press the Enter key after typing the final text and before exiting the file.

Here's a sample run of the program in Listing 6.16:

```
Enter name of data file: scores.txt
End of file reached.
Items read: 12
Sum: 204.5
Average: 17.0417
```

### Program Notes

Instead of hard-coding a filename, the program in Listing 6.16 stores a user-supplied name in the character array `filename`. Then the array is used as an argument to `open()`:

```
inFile.open(filename);
```

As discussed earlier in this chapter, it's vital to test whether the attempt to open the file succeeded. Here are a few of the things that might go wrong: The file might not exist, the file might be located in another directory or file folder, access might be denied, and the user might mistype the name or omit a file extension. Many a beginner has spent a long time trying to figure what's wrong with a file-reading loop when the real problem was that the program didn't open the file. Testing for file-opening failure can save you such misspent effort.

You need to pay close attention to the proper design of a file-reading loop. There are several things to test for when reading from a file. First, the program should not try to read past the EOF. The `eof()` method returns `true` if the most recent attempt to read data ran into the EOF. Second, the program might encounter a type mismatch. For instance, Listing 6.16 expects a file containing only numbers. The `fail()` method returns `true` if the most recent read attempt encountered a type mismatch. (This method also returns `true` if the EOF is encountered.) Finally, something unexpected may go wrong—for example, a corrupted file or a hardware failure. The `bad()` method returns `true` if the most recent read attempt encountered such a problem. Rather than test for these conditions individually, it's simpler to use the `good()` method, which returns `true` if nothing when wrong:

```
while (inFile.good()) // while input good and not at EOF
{
    ...
}
```

Then, if you like, you can use the other methods to determine exactly why the loop terminated:

```
if (inFile.eof())
    cout << "End of file reached.\n";
else if (inFile.fail())
    cout << "Input terminated by data mismatch.\n";
else
    cout << "Input terminated for unknown reason.\n";
```

This code comes immediately after the loop so that it investigates why the loop terminated. Because `eof()` tests just for the EOF and `fail()` tests for both the EOF and type mismatch, this code tests for the EOF first. That way, if execution reaches the `else if` test, the EOF has already been excluded, so a `true` value for `fail()` unambiguously identifies type mismatch as the cause of loop termination.

It's particularly important that you understand that `good()` reports on the most recent attempt to read input. That means there should be an attempt to read input *immediately* before applying the test. A standard way of doing that is to have one input statement immediately before the loop, just before the first execution of the loop test, and a second input statement at the end of the loop, just before subsequent executions of the loop test:

```
// standard file-reading loop design
inFile >> value; // get first value
while (inFile.good()) // while input good and not at EOF
{
    // loop body goes here
    inFile >> value; // get next value
}
```

You can condense this somewhat by using the fact that the following expression evaluates to `inFile` and that `inFile`, when placed in a context in which a `bool` value is expected, evaluates to `inFile.good()`—that is, to `true` or `false`:

```
inFile >> value
```

Thus, you can replace the two input statements with a single input statement used as a loop test. That is, you can replace the preceding loop structure with this:

```
// abbreviated file-reading loop design
// omit pre-loop input
while (inFile >> value) // read and test for success
{
    // loop body goes here
    // omit end-of-loop input
}
```



This design still follows the precept of attempting to read before testing because to evaluate the expression `infile >> value`, the program first has to attempt to read a number into `value`.

Now you know the rudiments of file I/O.

## Summary

Programs and programming become more interesting when you introduce statements that guide the program through alternative actions. (Whether this also makes the programmer more interesting is a point you may wish to investigate.) C++ provides the `if` statement, the `if else` statement, and the `switch` statement as means for managing choices. The C++ `if` statement lets a program execute a statement or statement block conditionally. That is, the program executes the statement or block if a particular condition is met. The C++ `if else` statement lets a program select from two choices which statement or statement block to execute. You can append additional `if else` statements to such a statement to present a series of choices. The C++ `switch` statement directs the program to a particular case in a list of choices.

C++ also provides operators to help in decision making. Chapter 5 discusses the relational expressions, which compare two values. The `if` and `if else` statements typically use relational expressions as test conditions. By using C++'s logical operators (`&&`, `||`, and `!`), you can combine or modify relational expressions to construct more elaborate tests. The conditional operator (`?:`) provides a compact way to choose from two values.

The `cctype` library of character functions provides a convenient and powerful set of tools for analyzing character input.

Loops and selection statements are useful tools for file I/O, which closely parallels console I/O. After you declare `ifstream` and `ofstream` objects and associate them with files, you can use these objects in the same manner you use `cin` and `cout`.

With C++'s loops and decision-making statements, you have the tools for writing interesting, intelligent, and powerful programs. But we've only begun to investigate the real powers of C++. Next, we'll look at functions.

## Chapter Review

1. Consider the following two code fragments for counting spaces and newlines:

```
// Version 1
while (cin.get(ch))    // quit on eof
{
    if (ch == ' ')
        spaces++;
    if (ch == '\n')
        newlines++;
}

// Version 2
```

```

while (cin.get(ch))    // quit on eof
{
    if (ch == ' ')
        spaces++;
    else if (ch == '\n')
        newlines++;
}

```

What advantages, if any, does the second form have over the first?

2. In Listing 6.2, what is the effect of replacing `++ch` with `ch+1`?
3. Carefully consider the following program:

```

#include <iostream>
using namespace std;
int main()
{
    char ch;
    int ct1, ct2;

    ct1 = ct2 = 0;
    while ((ch = cin.get()) != '$')
    {
        cout << ch;
        ct1++;
        if (ch == '$')
            ct2++;
        cout << ch;
    }
    cout <<"ct1 = " << ct1 << ", ct2 = " << ct2 << "\n";
    return 0;
}

```

Suppose you provide the following input, pressing the Enter key at the end of each line:

```

Hi!
Send $10 or $20 now!

```

What is the output? (Recall that input is buffered.)

4. Construct logical expressions to represent the following conditions:
  - a. weight is greater than or equal to 115 but less than 125.
  - b. ch is q or Q.
  - c. x is even but is not 26.
  - d. x is even but is not a multiple of 26.
  - e. donation is in the range 1,000–2,000 or guest is 1.

- f. `ch` is a lowercase letter or an uppercase letter. (Assume, as is true for ASCII, that lowercase letters are coded sequentially and that uppercase letters are coded sequentially but that there is a gap in the code between uppercase and lowercase.)
5. In English, the statement “I will not not speak” means the same as “I will speak.” In C++, is `!!x` the same as `x`?
  6. Construct a conditional expression that is equal to the absolute value of a variable. That is, if a variable `x` is positive, the value of the expression is just `x`, but if `x` is negative, the value of the expression is `-x`, which is positive.
  7. Rewrite the following fragment using `switch`:

```
if (ch == 'A')
    a_grade++;
else if (ch == 'B')
    b_grade++;
else if (ch == 'C')
    c_grade++;
else if (ch == 'D')
    d_grade++;
else
    f_grade++;
```

8. In Listing 6.10, what advantage would there be in using character labels, such as `a` and `c`, instead of numbers for the menu choices and `switch` cases? (Hint: Think about what happens if the user types `q` in either case and what happens if the user types `5` in either case.)
9. Consider the following code fragment:

```
int line = 0;
char ch;
while (cin.get(ch))
{
    if (ch == 'Q')
        break;
    if (ch != '\n')
        continue;
    line++;
}
```

Rewrite this code without using `break` or `continue`.

## Programming Exercises

1. Write a program that reads keyboard input to the @ symbol and that echoes the input except for digits, converting each uppercase character to lowercase, and vice versa. (Don't forget the `cctype` family.)
2. Write a program that reads up to 10 donation values into an array of `double`. (Or, if you prefer, use an array template object.) The program should terminate input on non-numeric input. It should report the average of the numbers and also report how many numbers in the array are larger than the average.

3. Write a precursor to a menu-driven program. The program should display a menu offering four choices, each labeled with a letter. If the user responds with a letter other than one of the four valid choices, the program should prompt the user to enter a valid response until the user complies. Then the program should use a switch to select a simple action based on the user's selection. A program run could look something like this:

```
Please enter one of the following choices:
```

```
c) carnivore           p) pianist
```

```
t) tree               g) game
```

```
f
```

```
Please enter a c, p, t, or g: q
```

```
Please enter a c, p, t, or g: t
```

```
A maple is a tree.
```

4. When you join the Benevolent Order of Programmers, you can be known at BOP meetings by your real name, your job title, or your secret BOP name. Write a program that can list members by real name, by job title, by secret name, or by a member's preference. Base the program on the following structure:

```
// Benevolent Order of Programmers name structure
struct bop {
    char fullname[STRSIZE]; // real name
    char title[STRSIZE];    // job title
    char bopname[STRSIZE];  // secret BOP name
    int preference;         // 0 = fullname, 1 = title, 2 = bopname
};
```

In the program, create a small array of such structures and initialize it to suitable values. Have the program run a loop that lets the user select from different alternatives:

- a. display by name
- b. display by title
- c. display by bopname
- d. display by preference
- q. quit

Note that “display by preference” does not mean display the preference member; it means display the member corresponding to the preference number. For instance, if preference is 1, choice d would display the programmer’s job title. A sample run may look something like the following:

```
Benevolent Order of Programmers Report
a. display by name      b. display by title
c. display by bopname  d. display by preference
q. quit
Enter your choice: a
Wimp Macho
Raki Rhodes
Celia Laiter
Hoppy Hipman
Pat Hand
Next choice: d
Wimp Macho
Junior Programmer
MIPS
Analyst Trainee
LOOPY
Next choice: q
Bye!
```

5. The Kingdom of Neutronia, where the unit of currency is the tvarp, has the following income tax code:

```
First 5,000 tvarps: 0% tax
Next 10,000 tvarps: 10% tax
Next 20,000 tvarps: 15% tax
Tvarps after 35,000: 20% tax
```

For example, someone earning 38,000 tvarps would owe  $5,000 \times 0.00 + 10,000 \times 0.10 + 20,000 \times 0.15 + 3,000 \times 0.20$ , or 4,600 tvarps. Write a program that uses a loop to solicit incomes and to report tax owed. The loop should terminate when the user enters a negative number or non-numeric input.

6. Put together a program that keeps track of monetary contributions to the Society for the Preservation of Rightful Influence. It should ask the user to enter the number of contributors and then solicit the user to enter the name and contribution of each contributor. The information should be stored in a dynamically allocated array of structures. Each structure should have two members: a character array (or else a string object) to store the name and a double member to hold the amount of the contribution. After reading all the data, the program should display the names and amounts donated for all donors who contributed \$10,000 or more. This list should

be headed by the label Grand Patrons. After that, the program should list the remaining donors. That list should be headed Patrons. If there are no donors in one of the categories, the program should print the word “none.” Aside from displaying two categories, the program need do no sorting.

7. Write a program that reads input a word at a time until a lone **q** is entered. The program should then report the number of words that began with vowels, the number that began with consonants, and the number that fit neither of those categories. One approach is to use `isalpha()` to discriminate between words beginning with letters and those that don't and then use an `if` or `switch` statement to further identify those passing the `isalpha()` test that begin with vowels. A sample run might look like this:

```
Enter words (q to quit):  
The 12 awesome oxen ambled  
quietly across 15 meters of lawn. q  
5 words beginning with vowels  
4 words beginning with consonants  
2 others
```

8. Write a program that opens a text file, reads it character-by-character to the end of the file, and reports the number of characters in the file.
9. Do Programming Exercise 6 but modify it to get information from a file. The first item in the file should be the number of contributors, and the rest of the file should consist of pairs of lines, with the first line of each pair being a contributor's name and the second line being a contribution. That is, the file should look like this:

```
4  
Sam Stone  
2000  
Freida Flass  
100500  
Tammy Tubbs  
5000  
Rich Raptor  
55000
```

*This page intentionally left blank*

# Functions: C++'s Programming Modules

In this chapter you'll learn about the following:

- Function basics
- Function prototypes
- Passing function arguments by value
- Designing functions to process arrays
- Using `const` pointer parameters
- Designing functions to process text strings
- Designing functions to process structures
- Designing functions to process objects of the `string` class
- Functions that call themselves (recursion)
- Pointers to functions

Fun is where you find it. Look closely, and you can find it in functions. C++ comes with a large library of useful functions (the standard ANSI C library plus several C++ classes), but real programming pleasure comes with writing your own functions. (On the other hand, real programming productivity can come with learning more about what you can do with the STL and the BOOST C++ libraries.) This chapter and Chapter 8, “Adventures in Functions,” examine how to define functions, convey information to them, and retrieve information from them. After reviewing how functions work, this chapter concentrates on how to use functions in conjunction with arrays, strings, and structures. Finally, it touches on recursion and pointers to functions. If you've paid your C dues, you'll find much of this chapter familiar. But don't be lulled into a false sense of expertise. C++ has made several additions to what C functions can do, and Chapter 8 deals primarily with those. Meanwhile, let's attend to the fundamentals.



## Function Review

Let's review what you've already seen about functions. To use a C++ function, you must do the following:

- Provide a function definition
- Provide a function prototype
- Call the function

If you're using a library function, the function has already been defined and compiled for you. Also you can and should use a standard library header file to provide the prototype. All that's left to do is call the function properly. The examples so far in this book have done that several times. For example, the standard C library includes the `strlen()` function for finding the length of the string. The associated standard header file `cstring` contains the function prototype for `strlen()` and several other string-related functions. This advance work allows you to use the `strlen()` function in programs without further worries.

But when you create your own functions, you have to handle all three aspects—defining, prototyping, and calling—yourself. Listing 7.1 shows these steps in a short example.

### Listing 7.1 `calling.cpp`

---

```
// calling.cpp -- defining, prototyping, and calling a function
#include <iostream>

void simple();    // function prototype

int main()
{
    using namespace std;
    cout << "main() will call the simple() function:\n";
    simple();    // function call
    cout << "main() is finished with the simple() function.\n";
    // cin.get();
    return 0;
}

// function definition
void simple()
{
    using namespace std;
    cout << "I'm but a simple function.\n";
}

```

---

Here's the output of the program in Listing 7.1:

```
main() will call the simple() function:
I'm but a simple function.
main() is finished with the simple() function.
```

Program execution in `main()` halts as control transfers to the `simple()` function. When `simple()` finishes, program execution in `main()` resumes. This example places a `using` directive inside each function definition because each function uses `cout`. Alternatively, the program could have a single `using` directive placed above the function definitions or otherwise use `std::cout`.

Let's take a more detailed look at these steps now.

## Defining a Function

You can group functions into two categories: those that don't have return values and those that do. Functions without return values are termed type `void` functions and have the following general form:

```
void functionName(parameterList)
{
    statement(s)
    return;           // optional
}
```

Here `parameterList` specifies the types and number of arguments (parameters) passed to the function. This chapter more fully investigates this list later. The optional return statement marks the end of the function. Otherwise, the function terminates at the closing brace. Type `void` functions correspond to Pascal procedures, FORTRAN subroutines, and modern BASIC subprogram procedures. Typically, you use a `void` function to perform some sort of action. For example, a function to print *Cheers!* a given number (`n`) of times could look like this:

```
void cheers(int n)           // no return value
{
    for (int i = 0; i < n; i++)
        std::cout << "Cheers! ";
    std::cout << std::endl;
}
```

The `int n` parameter list means that `cheers()` expects to have an `int` value passed to it as an argument when you call this function.

A function with a return value produces a value that it returns to the function that called it. In other words, if the function returns the square root of 9.0 (`sqrt(9.0)`), the

function call has the value 3.0. Such a function is declared as having the same type as the value it returns. Here is the general form:

```
typeName functionName(parameterList)
{
    statements
    return value; // value is type cast to type typeName
}
```

Functions with return values require that you use a return statement so that the value is returned to the calling function. The value itself can be a constant, a variable, or a more general expression. The only requirement is that the expression reduces to a value that has, or is convertible to, the *typeName* type. (If the declared return type is, say, `double`, and the function returns an `int` expression, the `int` value is type cast to type `double`.) The function then returns the final value to the function that called it. C++ does place a restriction on what types you can use for a return value: The return value cannot be an array. Everything else is possible—integers, floating-point numbers, pointers, and even structures and objects! (Interestingly, even though a C++ function can't return an array directly, it can return an array that's part of a structure or object.)

As a programmer, you don't need to know how a function returns a value, but knowing the method might clarify the concept for you. (Also it gives you something to talk about with your friends and family.) Typically, a function returns a value by copying the return value to a specified CPU register or memory location. Then the calling program examines that location. Both the returning function and the calling function have to agree on the type of data at that location. The function prototype tells the calling program what to expect, and the function definition tells the called program what to return (see Figure 7.1). Providing the same information in the prototype as in the definition might seem like extra work, but it makes good sense. Certainly, if you want a courier to pick up something from your desk at the office, you enhance the odds of the task being done right if you provide a description of what you want both to the courier and to someone at the office.

A function terminates after executing a return statement. If a function has more than one return statement—for example, as alternatives to different `if else` selections—the function terminates after it executes the first return statement it reaches. For instance, in the following example, the `else` isn't needed, but it does help the casual reader understand the intent:

```
int bigger(int a, int b)
{
    if (a > b )
        return a; // if a > b, function terminates here
    else
        return b; // otherwise, function terminates here
}
```

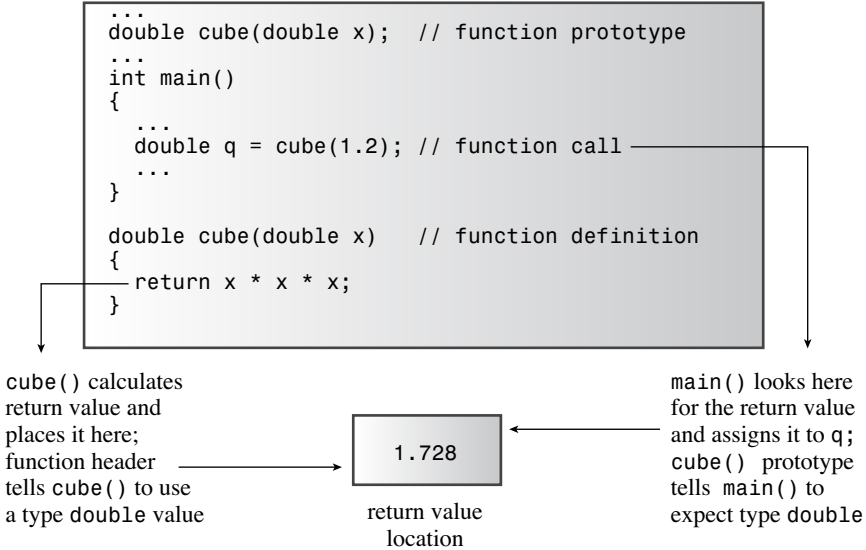

Figure 7.1 A typical return value mechanism.

(Usually, having multiple return statements in a function is considered potentially confusing, and some compilers might issue a warning. However, the code here is simple enough to understand.)

Functions with return values are much like functions in Pascal, FORTRAN, and BASIC. They return a value to the calling program, which can then assign that value to a variable, display the value, or otherwise use it. Here's a simple example that returns the cube of a type double value:

```

double cube(double x) // x times x times x
{
  return x * x * x; // a type double value
}

```

For example, the function call `cube(1.2)` returns the value `1.728`. Note that this return statement uses an expression. The function computes the value of the expression (`1.728`, in this case) and returns the value.

### Prototyping and Calling a Function

By now you are familiar with making function calls, but you may be less comfortable with function prototyping because that's often been hidden in the `include` files. Listing 7.2 shows the `cheers()` and `cube()` functions used in a program; notice the function prototypes.

Listing 7.2 `protos.cpp`

---

```
// protos.cpp -- using prototypes and function calls
#include <iostream>
void cheers(int);           // prototype: no return value
double cube(double x);     // prototype: returns a double
int main()
{
    using namespace std;
    cheers(5);             // function call
    cout << "Give me a number: ";
    double side;
    cin >> side;
    double volume = cube(side); // function call
    cout << "A " << side << "-foot cube has a volume of ";
    cout << volume << " cubic feet.\n";
    cheers(cube(2));       // prototype protection at work
    return 0;
}

void cheers(int n)
{
    using namespace std;
    for (int i = 0; i < n; i++)
        cout << "Cheers! ";
    cout << endl;
}

double cube(double x)
{
    return x * x * x;
}

```

---

The program in Listing 7.2 places a `using` directive in only those functions that use the members of the `std` namespace. Here's a sample run:

```
Cheers! Cheers! Cheers! Cheers! Cheers!
Give me a number: 5
A 5-foot cube has a volume of 125 cubic feet.
Cheers! Cheers! Cheers! Cheers! Cheers! Cheers! Cheers! Cheers! Cheers!
```

Note that `main()` calls the type `void` function `cheers()` by using the function name and arguments followed by a semicolon: `cheers(5);`. This is an example of a function call statement. But because `cube()` has a return value, `main()` can use it as part of an assignment statement:

```
double volume = cube(side);
```

But I said earlier that you should concentrate on the prototypes. What should you know about prototypes? First, you should understand why C++ requires prototypes. Then because C++ requires prototypes, you should know the proper syntax. Finally, you should appreciate what the prototype does for you. Let's look at these points in turn, using Listing 7.2 as a basis for discussion.

### Why Prototypes?

A prototype describes the function interface to the compiler. That is, it tells the compiler what type of return value, if any, the function has, and it tells the compiler the number and type of function arguments. Consider how the prototype affects this function call from Listing 7.2:

```
double volume = cube(side);
```

First, the prototype tells the compiler that `cube()` should have one type `double` argument. If the program fails to provide the argument, prototyping allows the compiler to catch the error. Second, when the `cube()` function finishes its calculation, it places its return value at some specified location—perhaps in a CPU register, perhaps in memory. Then the calling function, `main()` in this case, retrieves the value from that location. Because the prototype states that `cube()` is type `double`, the compiler knows how many bytes to retrieve and how to interpret them. Without that information, the compiler could only guess, and that is something compilers won't do.

Still, you might wonder, why does the compiler need a prototype? Can't it just look further in the file and see how the functions are defined? One problem with that approach is that it is not very efficient. The compiler would have to put compiling `main()` on hold while searching the rest of the file. An even more serious problem is the fact that the function might not even be in the file. C++ allows you to spread a program over several files, which you can compile independently and then combine later. In such a case, the compiler might not have access to the function code when it's compiling `main()`. The same is true if the function is part of a library. The only way to avoid using a function prototype is to place the function definition before its first use. That is not always possible. Also the C++ programming style is to put `main()` first because it generally provides the structure for the whole program.

### Prototype Syntax

A function prototype is a statement, so it must have a terminating semicolon. The simplest way to get a prototype is to copy the function header from the function definition and add a semicolon. That's what the program in Listing 7.2 does for `cube()`:

```
double cube(double x); // add ; to header to get prototype
```

However, the function prototype does not require that you provide names for the variables; a list of types is enough. The program in Listing 7.2 prototypes `cheers()` by using only the argument type:

```
void cheers(int); // okay to drop variable names in prototype
```

In general, you can either include or exclude variable names in the argument lists for prototypes. The variable names in the prototype just act as placeholders, so if you do use names, they don't have to match the names in the function definition.

### C++ Versus ANSI C Prototyping

ANSI C borrowed prototyping from C++, but the two languages do have some differences. The most important is that ANSI C, to preserve compatibility with classic C, made prototyping optional, whereas C++ makes prototyping mandatory. For example, consider the following function declaration:

```
void say_hi();
```

In C++, leaving the parentheses empty is the same as using the keyword `void` within the parentheses. It means the function has no arguments. In ANSI C, leaving the parentheses empty means that you are declining to state what the arguments are. That is, it means you're forgoing prototyping the argument list. The C++ equivalent for not identifying the argument list is to use an ellipsis:

```
void say_bye(...); // C++ abdication of responsibility
```

Normally this use of an ellipsis is needed only for interfacing with C functions having a variable number of arguments, such as `printf()`.

### What Prototypes Do for You

You've seen that prototypes help the compiler. But what do they do for you? They greatly reduce the chances of program errors. In particular, prototypes ensure the following:

- The compiler correctly handles the function return value.
- The compiler checks that you use the correct number of function arguments.
- The compiler checks that you use the correct type of arguments. If you don't, it converts the arguments to the correct type, if possible.

We've already discussed how to correctly handle the return value. Let's look now at what happens when you use the wrong number of arguments. For example, suppose you make the following call:

```
double z = cube();
```

A compiler that doesn't use function prototyping lets this go by. When the function is called, it looks where the call to `cube()` should have placed a number and uses whatever value happens to be there. This is how C worked before ANSI C borrowed prototyping

from C++. Because prototyping is optional for ANSI C, this is how some C programs still work. But in C++ prototyping is not optional, so you are guaranteed protection from that sort of error.

Next, suppose you provide an argument but it is the wrong type. In C, this could create weird errors. For example, if a function expects a type `int` value (assume that's 16 bits) and you pass a `double` (assume that's 64 bits), the function looks at just the first 16 bits of the 64 and tries to interpret them as an `int` value. However, C++ automatically converts the value you pass to the type specified in the prototype, provided that both are arithmetic types. For example, Listing 7.2 manages to get two type mismatches in one statement:

```
cheers(cube(2));
```

First, the program passes the `int` value of 2 to `cube()`, which expects type `double`. The compiler, noting that the `cube()` prototype specifies a type `double` argument, converts 2 to 2.0, a type `double` value. Then `cube()` returns a type `double` value (8.0) to be used as an argument to `cheers()`. Again, the compiler checks the prototypes and notes that `cheers()` requires an `int`. It converts the return value to the integer 8. In general, prototyping produces automatic type casts to the expected types. (Function overloading, discussed in Chapter 8, can create ambiguous situations, however, that prevent some automatic type casts.)

Automatic type conversion doesn't head off all possible errors. For example, if you pass a value of 8.33E27 to a function that expects an `int`, such a large value cannot be converted correctly to a mere `int`. Some compilers warn you of possible data loss when there is an automatic conversion from a larger type to a smaller.

Also prototyping results in type conversion only when it makes sense. It won't, for example, convert an integer to a structure or pointer.

Prototyping takes place during compile time and is termed *static type checking*. Static type checking, as you've just seen, catches many errors that are much more difficult to catch during runtime.

## Function Arguments and Passing by Value

It's time to take a closer look at function arguments. C++ normally passes arguments *by value*. That means the numeric value of the argument is passed to the function, where it is assigned to a new variable. For example, Listing 7.2 has this function call:

```
double volume = cube(side);
```

Here `side` is a variable that, in the sample run, had the value 5. The function header for `cube()`, recall, was this:

```
double cube(double x)
```

When this function is called, it creates a new type `double` variable called `x` and initializes it with the value 5. This insulates data in `main()` from actions that take place in `cube()` because `cube()` works with a copy of `side` rather than with the original data.



You'll see an example of this protection soon. A variable that's used to receive passed values is called a *formal argument* or *formal parameter*. The value passed to the function is called the *actual argument* or *actual parameter*. To simplify matters a bit, the C++ Standard uses the word *argument* by itself to denote an actual argument or parameter and the word *parameter* by itself to denote a formal argument or parameter. Using this terminology, argument passing initializes the parameter to the argument (see Figure 7.2).

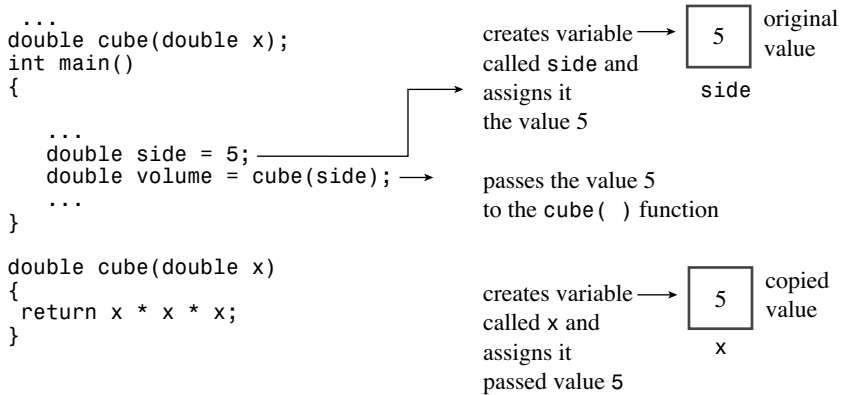

Figure 7.2 Passing by value.

Variables, including parameters, declared within a function are private to the function. When a function is called, the computer allocates the memory needed for these variables. When the function terminates, the computer frees the memory that was used for those variables. (Some C++ literature refers to this allocating and freeing of memory as *creating and destroying variables*. That does make it sound much more exciting.) Such variables are called *local variables* because they are localized to the function. As mentioned previously, this helps preserve data integrity. It also means that if you declare a variable called *x* in `main()` and another variable called *x* in some other function, these are two distinct, unrelated variables, much as the Albany in California is distinct from the Albany in New York (see Figure 7.3). Such variables are also termed *automatic variables* because they are allocated and deallocated automatically during program execution.

## Multiple Arguments

A function can have more than one argument. In the function call, you just separate the arguments with commas:

```
n_chars('R', 25);
```

This passes two arguments to the function `n_chars()`, which will be defined shortly.

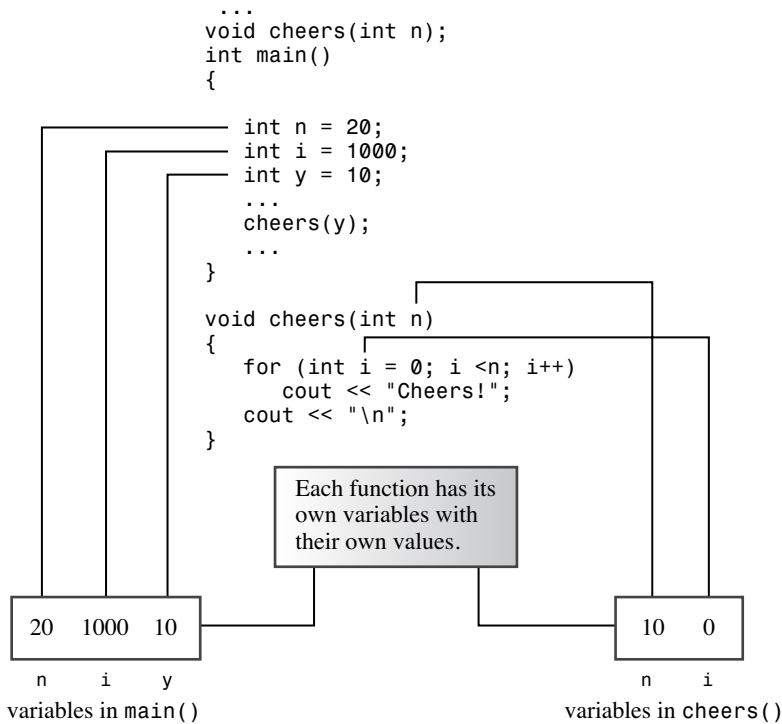

Figure 7.3 Local variables.

Similarly, when you define the function, you use a comma-separated list of parameter declarations in the function header:

```
void n_chars(char c, int n) // two arguments
```

This function header states that the function `n_chars()` takes one type `char` argument and one type `int` argument. The parameters `c` and `n` are initialized with the values passed to the function. If a function has two parameters of the same type, you have to give the type of each parameter separately. You can't combine declarations the way you can when you declare regular variables:

```
void fifi(float a, float b) // declare each variable separately
void fufu(float a, b)      // NOT acceptable
```

As with other functions, you just add a semicolon to get a prototype:

```
void n_chars(char c, int n); // prototype, style 1
```

As with single arguments, you don't have to use the same variable names in the prototype as in the definition, and you can omit the variable names in the prototype:

```
void n_chars(char, int); // prototype, style 2
```

However, providing variable names can make the prototype more understandable, particularly if two parameters are the same type. Then the names can remind you which argument is which:

```
double melon_density(double weight, double volume);
```

Listing 7.3 shows an example of a function with two arguments. It also illustrates how changing the value of a formal parameter in a function has no effect on the data in the calling program.

### Listing 7.3 `twoarg.cpp`

---

```
// twoarg.cpp -- a function with 2 arguments
#include <iostream>
using namespace std;
void n_chars(char, int);
int main()
{
    int times;
    char ch;

    cout << "Enter a character: ";
    cin >> ch;
    while (ch != 'q')        // q to quit
    {
        cout << "Enter an integer: ";
        cin >> times;
        n_chars(ch, times); // function with two arguments
        cout << "\nEnter another character or press the"
            << " q-key to quit: ";
        cin >> ch;
    }
    cout << "The value of times is " << times << ".\n";
    cout << "Bye\n";
    return 0;
}

void n_chars(char c, int n) // displays c n times
{
    while (n-- > 0)        // continue until n reaches 0
        cout << c;
}

```

---

The program in Listing 7.3 illustrates placing a `using` directive above the function definitions rather than within the functions. Here is a sample run:

```
Enter a character: W
Enter an integer: 50
```



First, you need a formula. If you have to pick six values out of 51, mathematics says that you have one chance in  $R$  of winning, where the following formula gives  $R$ :

$$R = \frac{51 \times 50 \times 49 \times 48 \times 47 \times 46}{6 \times 5 \times 4 \times 3 \times 2 \times 1}$$

For six choices, the denominator is the product of the first six integers, or 6 factorial. The numerator is also the product of six consecutive numbers, this time starting with 51 and going down. More generally, if you pick `picks` values out of `numbers` numbers, the denominator is `picks` factorial and the numerator is the product of `picks` integers, starting with the value `numbers` and working down. You can use a `for` loop to make that calculation:

```
long double result = 1.0;
for (n = numbers, p = picks; p > 0; n--, p--)
    result = result * n / p ;
```

Rather than multiply all the numerator terms first, the loop begins by multiplying 1.0 by the first numerator term and then dividing by the first denominator term. Then in the next cycle, the loop multiplies and divides by the second numerator and denominator terms. This keeps the running product smaller than if you did all the multiplication first. For example, compare

```
(10 * 9) / (2 * 1)
```

with

```
(10 / 2) * (9 / 1)
```

The first evaluates to  $90 / 2$  and then to 45, whereas the second evaluates to  $5 \times 9$  and then to 45. Both give the same answer, but the first method produces a larger intermediate value (90) than does the second. The more factors you have, the bigger the difference gets. For large numbers, this strategy of alternating multiplication with division can keep the calculation from overflowing the maximum possible floating-point value.

Listing 7.4 incorporates this formula into a `probability()` function. Because the number of picks and the total number of choices should be positive values, the program uses the `unsigned int` type (`unsigned`, for short) for those quantities. Multiplying several integers can produce pretty large results, so `lotto.cpp` uses the `long double` type for the function's return value. Also terms such as  $49 / 6$  produce a truncation error for integer types.

### Note

Some C++ implementations don't support type `long double`. If your implementation falls into that category, try ordinary `double` instead.

Listing 7.4 `lotto.cpp`

---

```
// lotto.cpp -- probability of winning
#include <iostream>
// Note: some implementations require double instead of long double
long double probability(unsigned numbers, unsigned picks);
int main()
{
    using namespace std;
    double total, choices;
    cout << "Enter the total number of choices on the game card and\n"
         << "the number of picks allowed:\n";
    while ((cin >> total >> choices) && choices <= total)
    {
        cout << "You have one chance in ";
        cout << probability(total, choices);      // compute the odds
        cout << " of winning.\n";
        cout << "Next two numbers (q to quit): ";
    }
    cout << "bye\n";
    return 0;
}

// the following function calculates the probability of picking picks
// numbers correctly from numbers choices
long double probability(unsigned numbers, unsigned picks)
{
    long double result = 1.0; // here come some local variables
    long double n;
    unsigned p;

    for (n = numbers, p = picks; p > 0; n--, p--)
        result = result * n / p ;
    return result;
}
```

---

Here's a sample run of the program in Listing 7.4:

```
Enter the total number of choices on the game card and
the number of picks allowed:
49 6
You have one chance in 1.39838e+007 of winning.
Next two numbers (q to quit): 51 6
You have one chance in 1.80095e+007 of winning.
Next two numbers (q to quit): 38 6
You have one chance in 2.76068e+006 of winning.
Next two numbers (q to quit): q
bye
```

Notice that increasing the number of choices on the game card greatly increases the odds against winning.

### Program Notes

The `probability()` function in Listing 7.4 illustrates two kinds of local variables you can have in a function. First, there are the formal parameters (`numbers` and `picks`), which are declared in the function header before the opening brace. Then come the other local variables (`result`, `n`, and `p`). They are declared in between the braces bounding the function definition. The main difference between the formal parameters and the other local variables is that the formal parameters get their values from the function that calls `probability()`, whereas the other variables get values from within the function.

## Functions and Arrays

So far the sample functions in this book have been simple, using only the basic types for arguments and return values. But functions can be the key to handling more involved types, such as arrays and structures. Let's take a look now at how arrays and functions get along with each other.

Suppose you use an array to keep track of how many cookies each person has eaten at a family picnic. (Each array index corresponds to a person, and the value of the element corresponds to the number of cookies that person has eaten.) Now you want the total. That's easy to find; you just use a loop to add all the array elements. But adding array elements is such a common task that it makes sense to design a function to do the job. Then you won't have to write a new loop every time you have to sum an array.

Let's consider what the function interface involves. Because the function calculates a sum, it should return the answer. If you keep your cookies intact, you can use a function with a type `int` return value. So that the function knows what array to sum, you want to pass the array name as an argument. And to make the function general so that it is not restricted to an array of a particular size, you pass the size of the array. The only new ingredient here is that you have to declare that one of the formal arguments is an array name. Let's see what that and the rest of the function header look like:

```
int sum_arr(int arr[], int n) // arr = array name, n = size
```

This looks plausible. The brackets seem to indicate that `arr` is an array, and the fact that the brackets are empty seems to indicate that you can use the function with an array of any size. But things are not always as they seem: `arr` is not really an array; it's a pointer! The good news is that you can write the rest of the function just as if `arr` were an array. First, let's use an example to check that this approach works, and then let's look into why it works.

Listing 7.5 illustrates using a pointer as if it were an array name. The program initializes the array to some values and uses the `sum_arr()` function to calculate the sum. Note that the `sum_arr()` function uses `arr` as if it were an array name.

**Listing 7.5 arrfun1.cpp**

---

```
// arrfun1.cpp -- functions with an array argument
#include <iostream>
const int ArSize = 8;
int sum_arr(int arr[], int n);      // prototype
int main()
{
    using namespace std;
    int cookies[ArSize] = {1,2,4,8,16,32,64,128};
    // some systems require preceding int with static to
    // enable array initialization

    int sum = sum_arr(cookies, ArSize);
    cout << "Total cookies eaten: " << sum << "\n";
    return 0;
}

// return the sum of an integer array
int sum_arr(int arr[], int n)
{
    int total = 0;

    for (int i = 0; i < n; i++)
        total = total + arr[i];
    return total;
}
```

---

Here is the output of the program in Listing 7.5:

```
Total cookies eaten: 255
```

As you can see, the program works. Now let's look at why it works.

## How Pointers Enable Array-Processing Functions

The key to the program in Listing 7.5 is that C++, like C, in most contexts treats the name of an array as if it were a pointer. Recall from Chapter 4, "Compound Types," that C++ interprets an array name as the address of its first element:

```
cookies == &cookies[0] // array name is address of first element
```

(There are a few exceptions to this rule. First, the array declaration uses the array name to label the storage. Second, applying `sizeof` to an array name yields the size of the whole array, in bytes. Third, as mentioned in Chapter 4, applying the address operator `&` to an array name returns the address of the whole array; for example, `&cookies` would be the address of a 32-byte block of memory if `int` is 4 bytes.)



Listing 7.5 makes the following function call:

```
int sum = sum_arr(cookies, ArSize);
```

Here `cookies` is the name of an array, hence by C++ rules `cookies` is the address of the array's first element. The function passes an address. Because the array has type `int` elements, `cookies` must be type pointer-to-`int`, or `int *`. This suggests that the correct function header should be this:

```
int sum_arr(int * arr, int n) // arr = array name, n = size
```

Here `int *arr` has replaced `int arr[]`. It turns out that both headers are correct because in C++ the notations `int *arr` and `int arr[]` have the identical meaning when (and *only* when) used in a function header or function prototype. Both mean that `arr` is a pointer-to-`int`. However, the array notation version (`int arr[]`) symbolically reminds you that `arr` not only points to an `int`, it points to the first `int` in an array of `ints`. This book uses the array notation when the pointer is to the first element of an array, and it uses the pointer notation when the pointer is to an isolated value. Remember that the notations `int *arr` and `int arr[]` are not synonymous in any other context. For example, you can't use the notation `int tip[]` to declare a pointer in the body of a function.

Given that the variable `arr` actually is a pointer, the rest of the function makes sense. As you might recall from the discussion of dynamic arrays in Chapter 4, you can use the bracket array notation equally well with array names or with pointers to access elements of an array. Whether `arr` is a pointer or an array name, the expression `arr[3]` means the fourth element of the array. And it probably will do no harm at this point to remind you of the following two identities:

```
arr[i] == *(arr + i)    // values in two notations
&arr[i] == ar + i      // addresses in two notations
```

Remember that adding one to a pointer, including an array name, actually adds a value equal to the size, in bytes, of the type to which the pointer points. Pointer addition and array subscription are two equivalent ways of counting elements from the beginning of an array.

## The Implications of Using Arrays as Arguments

Let's look at the implications of Listing 7.5. The function call `sum_arr(cookies, ArSize)` passes the address of the first element of the `cookies` array and the number of elements of the array to the `sum_arr()` function. The `sum_arr()` function initializes the `cookies` address to the pointer variable `arr` and initializes `ArSize` to the `int` variable `n`. This means Listing 7.5 doesn't really pass the array contents to the function. Instead, it tells the function where the array is (the address), what kind of elements it has (the type), and how many elements it has (the `n` variable). (See Figure 7.4.) Armed with this information, the function then uses the original array. If you pass an ordinary variable, the function works with a copy. But if you pass an array, the function works with the original. Actually, this difference doesn't violate C++'s pass-by-value approach. The `sum_arr()` function still

passes a value that's assigned to a new variable. But that value is a single address, not the contents of an array.

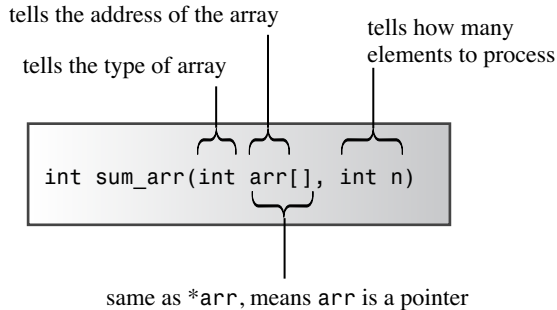

Figure 7.4 Telling a function about an array.

Is the correspondence between array names and pointers a good thing? Indeed, it is. The design decision to use array addresses as arguments saves the time and memory needed to copy an entire array. The overhead for using copies can be prohibitive if you're working with large arrays. With copies, not only does a program need more computer memory, but it has to spend time copying large blocks of data. On the other hand, working with the original data raises the possibility of inadvertent data corruption. That's a real problem in classic C, but ANSI C and C++'s `const` modifier provides a remedy. You'll soon see an example. But first, let's alter Listing 7.5 to illustrate some points about how array functions operate. Listing 7.6 demonstrates that `cookies` and `arr` have the same value. It also shows how the pointer concept makes the `sum_arr` function more versatile than it may have appeared at first. To provide a bit of variety and to show you what it looks like, the program uses the `std::` qualifier instead of the `using` directive to provide access to `cout` and `endl`.

#### Listing 7.6 `arrfun2.cpp`

---

```
// arrfun2.cpp -- functions with an array argument
#include <iostream>
const int ArSize = 8;
int sum_arr(int arr[], int n);
// use std:: instead of using directive
int main()
{
    int cookies[ArSize] = {1,2,4,8,16,32,64,128};
    // some systems require preceding int with static to
    // enable array initialization
```

```

    std::cout << cookies << " = array address, ";
// some systems require a type cast: unsigned (cookies)

    std::cout << sizeof cookies << " = sizeof cookies\n";
    int sum = sum_arr(cookies, ArSize);
    std::cout << "Total cookies eaten: " << sum << std::endl;
    sum = sum_arr(cookies, 3);          // a lie
    std::cout << "First three eaters ate " << sum << " cookies.\n";
    sum = sum_arr(cookies + 4, 4);     // another lie
    std::cout << "Last four eaters ate " << sum << " cookies.\n";
    return 0;
}

// return the sum of an integer array
int sum_arr(int arr[], int n)
{
    int total = 0;
    std::cout << arr << " = arr, ";
// some systems require a type cast: unsigned (arr)

    std::cout << sizeof arr << " = sizeof arr\n";
    for (int i = 0; i < n; i++)
        total = total + arr[i];
    return total;
}

```

---

Here's the output of the program in Listing 7.6:

```

003EF9FC = array address, 32 = sizeof cookies
003EF9FC = arr, 4 = sizeof arr
Total cookies eaten: 255
003EF9FC = arr, 4 = sizeof arr
First three eaters ate 7 cookies.
003EFA0C = arr, 4 = sizeof arr
Last four eaters ate 240 cookies.

```

Note that the address values and the array and integer sizes will vary from system to system. Also some implementations will display the addresses in base 10 notation instead of in hexadecimal. Others will use hexadecimal digits and the 0x hexadecimal prefix.

### Program Notes

Listing 7.6 illustrates some very interesting points about array functions. First, note that `cookies` and `arr` both evaluate to the same address, exactly as claimed. But `sizeof cookies` is 32, whereas `sizeof arr` is only 4. That's because `sizeof cookies` is the size of the whole array, whereas `sizeof arr` is the size of the pointer variable. (This program execution takes place on a system that uses 4-byte addresses.) By the way, this is why you

have to explicitly pass the size of the array rather than use `sizeof arr` in `sum_arr()`; the pointer by itself doesn't reveal the size of the array.

Because the only way `sum_arr()` knows the number of elements in the array is through what you tell it with the second argument, you can lie to the function. For example, the second time the program uses the function, it makes this call:

```
sum = sum_arr(cookies, 3);
```

By telling the function that `cookies` has just three elements, you get the function to calculate the sum of the first three elements.

Why stop there? You can also lie about where the array starts:

```
sum = sum_arr(cookies + 4, 4);
```

Because `cookies` acts as the address of the first element, `cookies + 4` acts as the address of the fifth element. This statement sums the fifth, sixth, seventh, and eighth elements of the array. Note in the output how the third call to the function assigns a different address to `arr` than the first two calls did. And yes, you can use `&cookies[4]` instead of `cookies + 4` as the argument; they both mean the same thing.

### Note

To indicate the kind of array and the number of elements to an array-processing function, you pass the information as two separate arguments:

```
void fillArray(int arr[], int size); // prototype
```

Don't try to pass the array size by using brackets notation:

```
void fillArray(int arr[size]); // NO -- bad prototype
```

## More Array Function Examples

When you choose to use an array to represent data, you are making a design decision. But design decisions should go beyond how data is stored; they should also involve how the data is used. Often you'll find it profitable to write specific functions to handle specific data operations. (The profits here include increased program reliability, ease of modification, and ease of debugging.) Also when you begin integrating storage properties with operations when you think about a program, you are taking an important step toward the OOP mind-set; that, too, might prove profitable in the future.

Let's examine a simple case. Suppose you want to use an array to keep track of the dollar values of your real estate. (If necessary, suppose you have real estate.) You have to decide what type to use. Certainly, `double` is less restrictive in its range than `int` or `long`, and it provides enough significant digits to represent the values precisely. Next, you have to decide on the number of array elements. (With dynamic arrays created with `new`, you can put off that decision, but let's keep things simple.) Let's say that you have no more than five properties, so you can use an array of five `doubles`.

Now consider the possible operations you might want to execute with the real estate array. Two very basic ones are reading values into the array and displaying the array

contents. Let's add one more operation to the list: reassessing the value of the properties. For simplicity, assume that all your properties increase or decrease in value at the same rate. (Remember, this is a book on C++, not on real estate management.) Next, fit a function to each operation and then write the code accordingly. We'll go through the steps of creating these pieces of a program next. Afterward, we'll fit them into a complete example.

### Filling the Array

Because a function with an array name argument accesses the original array, not a copy, you can use a function call to assign values to array elements. One argument to the function will be the name of the array to be filled. In general, a program might manage more than one person's investments, hence more than one array, so you don't want to build the array size into the function. Instead, you pass the array size as a second argument, as in the previous example. Also it's possible that you might want to quit reading data before filling the array, so you want to build that feature in to the function. Because you might enter fewer than the maximum number of elements, it makes sense to have the function return the actual number of values entered. These considerations suggest the following function prototype:

```
int fill_array(double ar[], int limit);
```

The function takes an array name argument and an argument specifying the maximum number of items to be read, and the function returns the actual number of items read. For example, if you use this function with an array of five elements, you pass 5 as the second argument. If you then enter only three values, the function returns 3.

You can use a loop to read successive values into the array, but how can you terminate the loop early? One way is to use a special value to indicate the end of input. Because no property should have a negative value, you can use a negative number to indicate the end of input. Also the function should do something about bad input, such as terminating further input. Given these considerations, you can code the function as follows:

```
int fill_array(double ar[], int limit)
{
    using namespace std;
    double temp;
    int i;
    for (i = 0; i < limit; i++)
    {
        cout << "Enter value #" << (i + 1) << ": ";
        cin >> temp;
        if (!cin) // bad input
        {
            cin.clear();
            while (cin.get() != '\n')
                continue;
            cout << "Bad input; input process terminated.\n";
```

```
        break;
    }
    else if (temp < 0)    // signal to terminate
        break;
    ar[i] = temp;
}
return i;
}
```

Note that this code includes a prompt to the user. If the user enters a non-negative value, the value is assigned to the array. Otherwise, the loop terminates. If the user enters only valid values, the loop terminates after it reads `limit` values. The last thing the loop does is increment `i`, so after the loop terminates, `i` is one greater than the last array index, hence it's equal to the number of filled elements. The function then returns that value.

### Showing the Array and Protecting It with `const`

Building a function to display the array contents is simple. You pass the name of the array and the number of filled elements to the function, which then uses a loop to display each element. But there is another consideration—guaranteeing that the display function doesn't alter the original array. Unless the purpose of a function is to alter data passed to it, you should safeguard it from doing so. That protection comes automatically with ordinary arguments because C++ passes them by value, and the function works with a copy. But functions that use an array work with the original. After all, that's why the `fill_array()` function is able to do its job. To keep a function from accidentally altering the contents of an array argument, you can use the keyword `const` (discussed in Chapter 3, “Dealing with Data”) when you declare the formal argument:

```
void show_array(const double ar[], int n);
```

The declaration states that the pointer `ar` points to constant data. This means that you can't use `ar` to change the data. That is, you can use a value such as `ar[0]`, but you can't change that value. Note that this doesn't mean that the original array needs be constant; it just means that you can't use `ar` in the `show_array()` function to change the data. Thus, `show_array()` treats the array as read-only data. Suppose you accidentally violate this restriction by doing something like the following in the `show_array()` function:

```
ar[0] += 10;
```

In this case, the compiler will put a stop to your wrongful ways. Borland C++, for example, gives an error message like this (edited slightly):

```
Cannot modify a const object in function
    show_array(const double *,int)
```

Other compilers may choose to express their displeasure in different words.

The message reminds you that C++ interprets the declaration `const double ar[]` to mean `const double *ar`. Thus, the declaration really says that `ar` points to a constant value. We'll discuss this in detail when we finish with the current example. Meanwhile, here is the code for the `show_array()` function:

```
void show_array(const double ar[], int n)
{
    using namespace std;
    for (int i = 0; i < n; i++)
    {
        cout << "Property #" << (i + 1) << ": $";
        cout << ar[i] << endl;
    }
}
```

### Modifying the Array

The third operation for the array in this example is multiplying each element by the same revaluation factor. You need to pass three arguments to the function: the factor, the array, and the number of elements. No return value is needed, so the function can look like this:

```
void revalue(double r, double ar[], int n)
{
    for (int i = 0; i < n; i++)
        ar[i] *= r;
}
```

Because this function is supposed to alter the array values, you don't use `const` when you declare `ar`.

### Putting the Pieces Together

Now that you've defined a data type in terms of how it's stored (an array) and how it's used (three functions), you can put together a program that uses the design. Because you've already built all the array-handling tools, you've greatly simplified programming `main()`. The program does check to see if the user responds to the prompt for a revaluation factor with a number. In this case, rather than stopping if the user fails to comply, the program uses a loop to ask the user to do the right thing. Most of the remaining programming work consists of having `main()` call the functions you've just developed. Listing 7.7 shows the result. It places a `using` directive in just those functions that use the `iostream` facilities.

#### Listing 7.7 `arrfun3.cpp`

---

```
// arrfun3.cpp -- array functions and const
#include <iostream>
const int Max = 5;
```

```
// function prototypes
int fill_array(double ar[], int limit);
void show_array(const double ar[], int n); // don't change data
void revalue(double r, double ar[], int n);

int main()
{
    using namespace std;
    double properties[Max];

    int size = fill_array(properties, Max);
    show_array(properties, size);
    if (size > 0)
    {
        cout << "Enter revaluation factor: ";
        double factor;
        while (!(cin >> factor)) // bad input
        {
            cin.clear();
            while (cin.get() != '\n')
                continue;
            cout << "Bad input; Please enter a number: ";
        }
        revalue(factor, properties, size);
        show_array(properties, size);
    }
    cout << "Done.\n";
    cin.get();
    cin.get();
    return 0;
}

int fill_array(double ar[], int limit)
{
    using namespace std;
    double temp;
    int i;
    for (i = 0; i < limit; i++)
    {
        cout << "Enter value #" << (i + 1) << ": ";
        cin >> temp;
        if (!cin) // bad input
        {
            cin.clear();
            while (cin.get() != '\n')
                continue;
            cout << "Bad input; input process terminated.\n";
        }
    }
}
```



```
        break;
    }
    else if (temp < 0)    // signal to terminate
        break;
    ar[i] = temp;
}
return i;
}

// the following function can use, but not alter,
// the array whose address is ar
void show_array(const double ar[], int n)
{
    using namespace std;
    for (int i = 0; i < n; i++)
    {
        cout << "Property #" << (i + 1) << ": $";
        cout << ar[i] << endl;
    }
}

// multiplies each element of ar[] by r
void revalue(double r, double ar[], int n)
{
    for (int i = 0; i < n; i++)
        ar[i] *= r;
}
```

---

Here are two sample runs of the program in Listing 7.7:

```
Enter value #1: 100000
Enter value #2: 80000
Enter value #3: 222000
Enter value #4: 240000
Enter value #5: 118000
Property #1: $100000
Property #2: $80000
Property #3: $222000
Property #4: $240000
Property #5: $118000
Enter revaluation factor: 0.8
Property #1: $80000
Property #2: $64000
Property #3: $177600
Property #4: $192000
Property #5: $94400
Done.
```

```

Enter value #1: 200000
Enter value #2: 84000
Enter value #3: 160000
Enter value #4: -2
Property #1: $200000
Property #2: $84000
Property #3: $160000
Enter reevaluation factor: 1.20
Property #1: $240000
Property #2: $100800
Property #3: $192000
Done.

```

Recall that `fill_array()` prescribes that input should quit when the user enters five properties or enters a negative number, whichever comes first. The first output example illustrates reaching the five-property limit, and the second output example illustrates that entering a negative value terminates the input phase.

## Program Notes

We've already discussed the important programming details related to the real estate example, so let's reflect on the process. You began by thinking about the data type and designed appropriate functions to handle the data. Then you assembled these functions into a program. This is sometimes called *bottom-up programming* because the design process moves from the component parts to the whole. This approach is well suited to OOP, which concentrates on data representation and manipulation first. Traditional procedural programming, on the other hand, leans toward *top-down programming*, in which you develop a modular grand design first and then turn your attention to the details. Both methods are useful, and both lead to modular programs.

## The Usual Array Function Idiom

Suppose you want a function to process an array, say, of type `double` values. If the function is intended to modify the array, the prototype might look like this:

```
void f_modify(double ar[], int n);
```

If the function preserves values, the prototype might look like this:

```
void f_no_change(const double ar[], int n);
```

Of course, you can omit the variable names in the prototypes, and the return type might be something other than `void`. The main points are that `ar` really is a pointer to the first element of the passed array and that because the number of elements is passed as an argument, either function can be used with any size of array as long as it is an array of `double`:

```

double rewards[1000];
double faults[50];
...
f_modify(rewards, 1000);
f_modify(faults, 50);

```

This idiom (pass the array name and size as arguments) works by passing two numbers—the array address and the number of elements. As you have seen, the function loses some knowledge about the original array; for example, it can't use `sizeof` to get the size and relies on you to pass the correct number of elements.

## Functions Using Array Ranges

As you've seen, C++ functions that process arrays need to be informed about the kind of data in the array, the location of the beginning of the array, and the number of elements in the array. The traditional C/C++ approach to functions that process arrays is to pass a pointer to the start of the array as one argument and to pass the size of the array as a second argument. (The pointer tells the function both where to find the array and the kind of data in it.) That gives the function the information it needs to find all the data.

There is another approach to giving a function the information it needs: specify a *range* of elements. This can be done by passing two pointers—one identifying the start of the array and one identifying the end of the array. The C++ Standard Template Library (STL; presented in Chapter 16, “The `string` Class and the Standard Template Library”), for example, generalizes the range approach. The STL approach uses the concept of “one past the end” to indicate an extent. That is, in the case of an array, the argument identifying the end of the array would be a pointer to the location just after the last element. For example, suppose you have this declaration:

```
double elbuod[20];
```

Then the two pointers `elbuod` and `elbuod + 20` define the range. First, `elbuod`, being the name of the array, points to the first element. The expression `elbuod + 19` points to the last element (that is, `elbuod[19]`), so `elbuod + 20` points to one past the end of the array. Passing a range to a function tells it which elements to process. Listing 7.8 modifies Listing 7.6 to use two pointers to specify a range.

### Listing 7.8 `arrfun4.cpp`

---

```
// arrfun4.cpp -- functions with an array range
#include <iostream>
const int ArSize = 8;
int sum_arr(const int * begin, const int * end);
int main()
{
    using namespace std;
    int cookies[ArSize] = {1,2,4,8,16,32,64,128};
    // some systems require preceding int with static to
    // enable array initialization

    int sum = sum_arr(cookies, cookies + ArSize);
    cout << "Total cookies eaten: " << sum << endl;
    sum = sum_arr(cookies, cookies + 3);          // first 3 elements
    cout << "First three eaters ate " << sum << " cookies.\n";
```

```

    sum = sum_arr(cookies + 4, cookies + 8);    // last 4 elements
    cout << "Last four eaters ate " << sum << " cookies.\n";
    return 0;
}

// return the sum of an integer array
int sum_arr(const int * begin, const int * end)
{
    const int * pt;
    int total = 0;

    for (pt = begin; pt != end; pt++)
        total = total + *pt;
    return total;
}

```

---

Here's the output of the program in Listing 7.8:

```

Total cookies eaten: 255
First three eaters ate 7 cookies.
Last four eaters ate 240 cookies.

```

## Program Notes

In Listing 7.8, notice the `for` loop in the `sum_array()` function:

```

for (pt = begin; pt != end; pt++)
    total = total + *pt;

```

It sets `pt` to point to the first element to be processed (the one pointed to by `begin`) and adds `*pt` (the value of the element) to `total`. Then the loop updates `pt` by incrementing it, causing it to point to the next element. The process continues as long as `pt != end`. When `pt` finally equals `end`, it's pointing to the location following the last element of the range, so the loop halts.

Second, notice how the different function calls specify different ranges within the array:

```

int sum = sum_arr(cookies, cookies + ArSize);
...
sum = sum_arr(cookies, cookies + 3);          // first 3 elements
...
sum = sum_arr(cookies + 4, cookies + 8);     // last 4 elements

```

The pointer value `cookies + ArSize` points to the location following the last element. (The array has `ArSize` elements, so `cookies[ArSize - 1]` is the last element, and its address is `cookies + ArSize - 1`.) So the range `cookies, cookies + ArSize` specifies the entire array. Similarly, `cookies, cookies + 3` specifies the first three elements, and so on.

Note, by the way, that the rules for pointer subtraction imply that, in `sum_arr()`, the expression `end - begin` is an integer value equal to the number of elements in the range.

Also note that it's important to pass the pointers in the correct order; the code assumes that `end` comes after `begin`.

## Pointers and `const`

Using `const` with pointers has some subtle aspects (pointers always seem to have subtle aspects), so let's take a closer look. You can use the `const` keyword two different ways with pointers. The first way is to make a pointer point to a constant object, and that prevents you from using the pointer to change the pointed-to value. The second way is to make the pointer itself constant, and that prevents you from changing where the pointer points. Now for the details.

First, let's declare a pointer `pt` that points to a constant:

```
int age = 39;
const int * pt = &age;
```

This declaration states that `pt` points to a `const int` (39, in this case). Therefore, you can't use `pt` to change that value. In other words, the value `*pt` is `const` and cannot be modified:

```
*pt += 1;           // INVALID because pt points to a const int
cin >> *pt;        // INVALID for the same reason
```

Now for a subtle point. This declaration for `pt` doesn't necessarily mean that the value it points to is really a constant; it just means the value is a constant insofar as `pt` is concerned. For example, `pt` points to `age`, and `age` is not `const`. You can change the value of `age` directly by using the `age` variable, but you can't change the value indirectly via the `pt` pointer:

```
*pt = 20;          // INVALID because pt points to a const int
age = 20;          // VALID because age is not declared to be const
```

Previous examples have assigned the address of a regular variable to a regular pointer. This example assigns the address of a regular variable to a pointer-to-`const`. That leaves two other possibilities: assigning the address of a `const` variable to a pointer-to-`const` and assigning the address of a `const` to a regular pointer. Are they both possible? The first is, and the second isn't:

```
const float g_earth = 9.80;
const float * pe = &g_earth; // VALID
```

```
const float g_moon = 1.63;
float * pm = &g_moon;        // INVALID
```

For the first case, you can use neither `g_earth` nor `pe` to change the value 9.80. C++ doesn't allow the second case for a simple reason: If you can assign the address of `g_moon` to `pm`, then you can cheat and use `pm` to alter the value of `g_moon`. That makes a mockery

of `g_moon`'s `const` status, so C++ prohibits you from assigning the address of a `const` to a non-`const` pointer. (If you are really desperate, you can use a type cast to override the restriction; see Chapter 15, "Friends, Exceptions, and More," for a discussion of the `const_cast` operator.)

The situation becomes a bit more complex if you have pointers to pointers. As you saw earlier, assigning a non-`const` pointer to a `const` pointer is okay, provided that you're dealing with just one level of indirection:

```
int age = 39;           // age++ is a valid operation
int * pd = &age;       // *pd = 41 is a valid operation
const int * pt = pd;   // *pt = 42 is an invalid operation
```

But pointer assignments that mix `const` and non-`const` in this manner are no longer safe when you go to two levels of indirection. If mixing `const` and non-`const` were allowed, you could do something like this:

```
const int **pp2;
int *p1;
const int n = 13;
pp2 = &p1; // not allowed, but suppose it were
**pp2 = &n; // valid, both const, but sets p1 to point at n
*p1 = 10; // valid, but changes const n
```

Here the code assigns a non-`const` address (`&p1`) to a `const` pointer (`pp2`), and that allows `p1` to be used to alter `const` data. So the rule that you can assign a non-`const` address or pointer to a `const` pointer works only if there is just one level of indirection—for example, if the pointer points to a fundamental data type.

### Note

You can assign the address of either `const` data or non-`const` data to a pointer-to-`const`, provided that the data type is not itself a pointer, but you can assign the address of non-`const` data only to a non-`const` pointer.

Suppose you have an array of `const` data:

```
const int months[12] = {31,28,31,30,31,30, 31, 31,30,31,30,31};
```

The prohibition against assigning the address of a constant array means that you cannot pass the array name as an argument to a function by using a non-constant formal argument:

```
int sum(int arr[], int n); // should have been const int arr[]
...
int j = sum(months, 12); // not allowed
```

This function call attempts to assign a `const` pointer (`months`) to a non-`const` pointer (`arr`), and the compiler disallows the function call.

### Using `const` When You Can

There are two strong reasons to declare pointer arguments as pointers to constant data:

- It protects you against programming errors that inadvertently alter data.
- Using `const` allows a function to process both `const` and `non-const` actual arguments, whereas a function that omits `const` in the prototype can accept only `non-const` data.

You should declare formal pointer arguments as pointers to `const` whenever it's appropriate to do so.

For yet another subtle point, consider the following declarations:

```
int age = 39;
const int * pt = &age;
```

The `const` in the second declaration only prevents you from changing the value to which `pt` points, which is 39. It doesn't prevent you from changing the value of `pt` itself. That is, you can assign a new address to `pt`:

```
int sage = 80;
pt = &sage; // okay to point to another location
```

But you still can't use `pt` to change the value to which it points (now 80).

The second way to use `const` makes it impossible to change the value of the pointer itself:

```
int sloth = 3;
const int * ps = &sloth; // a pointer to const int
int * const finger = &sloth; // a const pointer to int
```

Note that the last declaration has repositioned the keyword `const`. This form of declaration constrains `finger` to point only to `sloth`. However, it allows you to use `finger` to alter the value of `sloth`. The middle declaration does not allow you to use `ps` to alter the value of `sloth`, but it permits you to have `ps` point to another location. In short, `finger` and `*ps` are both `const`, and `*finger` and `ps` are not `const` (see Figure 7.5).

If you like, you can declare a `const` pointer to a `const` object:

```
double trouble = 2.0E30;
const double * const stick = &trouble;
```

Here `stick` can point only to `trouble`, and `stick` cannot be used to change the value of `trouble`. In short, both `stick` and `*stick` are `const`.

Typically you use the pointer-to-`const` form to protect data when you pass pointers as function arguments. For example, recall the `show_array()` prototype from Listing 7.5:

```
void show_array(const double ar[], int n);
```

Using `const` in this declaration means that `show_array()` cannot alter the values in any array that is passed to it. This technique works as long as there is just one level of indirection. Here, for example, the array elements are a fundamental type. But if they were pointers or pointers-to-pointers, you wouldn't use `const`.

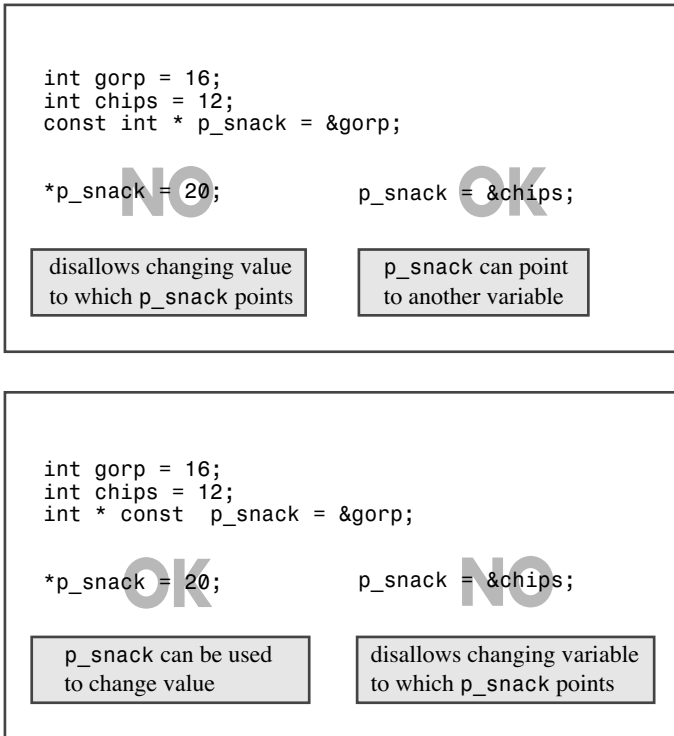

Figure 7.5 Pointers-to-const and const pointers.

## Functions and Two-Dimensional Arrays

To write a function that has a two-dimensional array as an argument, you need to remember that the name of an array is treated as its address, so the corresponding formal parameter is a pointer, just as for one-dimensional arrays. The tricky part is declaring the pointer correctly. Suppose, for example, that you start with this code:

```
int data[3][4] = {{1,2,3,4}, {9,8,7,6}, {2,4,6,8}};
int total = sum(data, 3);
```

What should the prototype for `sum()` look like? And why does the function pass the number of rows (3) as an argument and not also the number of columns (4)?

Well, `data` is the name of an array with three elements. The first element is, itself, an array of four `int` values. Thus, the type of `data` is pointer-to-array-of-four-int, so an appropriate prototype would be this:

```
int sum(int (*ar2)[4], int size);
```



The parentheses are needed because the following declaration would declare an array of four pointers-to-int instead of a single pointer-to-array-of-four-int, and a function parameter cannot be an array:

```
int *ar2[4]
```

Here's an alternative format that means exactly the same thing as this first prototype, but, perhaps, is easier to read:

```
int sum(int ar2[][4], int size);
```

Either prototype states that `ar2` is a pointer, not an array. Also note that the pointer type specifically says it points to an array of four ints. Thus, the pointer type specifies the number of columns, which is why the number of columns is not passed as a separate function argument.

Because the pointer type specifies the number of columns, the `sum()` function only works with arrays with four columns. But the number of rows is specified by the variable `size`, so `sum()` can work with a varying number of rows:

```
int a[100][4];
int b[6][4];
...
int total1 = sum(a, 100); // sum all of a
int total2 = sum(b, 6); // sum all of b
int total3 = sum(a, 10); // sum first 10 rows of a
int total4 = sum(a+10, 20); // sum next 20 rows of a
```

Given that the parameter `ar2` is a pointer to an array, how do you use it in the function definition? The simplest way is to use `ar2` as if it were the name of a two-dimensional array. Here's a possible function definition:

```
int sum(int ar2[][4], int size)
{
    int total = 0;
    for (int r = 0; r < size; r++)
        for (int c = 0; c < 4; c++)
            total += ar2[r][c];
    return total;
}
```

Again, note that the number of rows is whatever is passed to the `size` parameter, but the number of columns is fixed at four, both in the parameter declaration for `ar2` and in the inner `for` loop.

Here's why you can use array notation. Because `ar2` points to the first element (element 0) of an array whose elements are array-of-four-int, the expression `ar2 + r` points to element number `r`. Therefore `ar2[r]` is element number `r`. That element is itself an array-of-four-int, so `ar2[r]` is the name of that array-of-four-int. Applying a subscript to an array name gives an array element, so `ar2[r][c]` is an element of the array-of-four-int, hence is a single `int` value. The pointer `ar2` has to be dereferenced twice to get to

the data. The simplest way is to use brackets twice, as in `ar2[r][c]`. But it is possible, if ungainly, to use the `*` operator twice:

```
ar2[r][c] == *(*ar2 + r) + c) // same thing
```

To understand this, you can work out the meaning of the subexpressions from the inside out:

```
ar2           // pointer to first row of an array of 4 int
ar2 + r       // pointer to row r (an array of 4 int)
*(ar2 + r)    // row r (an array of 4 int, hence the name of an array,
              // thus a pointer to the first int in the row, i.e., ar2[r]

*(ar2 + r) + c // pointer int number c in row r, i.e., ar2[r] + c
*(*(ar2 + r) + c // value of int number c in row r, i.e. ar2[r][c]
```

Incidentally, the code for `sum()` doesn't use `const` in declaring the parameter `ar2` because that technique is for pointers to fundamental types, and `ar2` is a pointer to a pointer.

## Functions and C-Style Strings

Recall that a C-style string consists of a series of characters terminated by the null character. Much of what you've learned about designing array functions applies to string functions, too. For example, passing a string as an argument means passing an address, and you can use `const` to protect a string argument from being altered. But there are a few special twists to strings that we'll unravel now.

### Functions with C-Style String Arguments

Suppose you want to pass a string as an argument to a function. You have three choices for representing a string:

- An array of `char`
- A quoted string constant (also called a *string literal*)
- A pointer-to-`char` set to the address of a string

All three choices, however, are type pointer-to-`char` (more concisely, type `char *`), so you can use all three as arguments to string-processing functions:

```
char ghost[15] = "galloping";
char * str = "galumphing";
int n1 = strlen(ghost);           // ghost is &ghost[0]
int n2 = strlen(str);             // pointer to char
int n3 = strlen("gamboling");     // address of string
```

Informally, you can say that you're passing a string as an argument, but you're really passing the address of the first character in the string. This implies that a string function prototype should use type `char *` as the type for the formal parameter representing a string.

One important difference between a C-style string and a regular array is that the string has a built-in terminating character. (Recall that a `char` array containing characters but no null character is just an array and not a string.) That means you don't have to pass the size of the string as an argument. Instead, the function can use a loop to examine each character in the string in turn until the loop reaches the terminating null character. Listing 7.9 illustrates that approach with a function that counts the number of times a given character appears in a string. Because the program doesn't need to deal with negative values, it uses `unsigned int` as the type for counting.

**Listing 7.9** `strgfun.cpp`

---

```
// strgfun.cpp -- functions with a string argument
#include <iostream>
unsigned int c_in_str(const char * str, char ch);
int main()
{
    using namespace std;
    char mmm[15] = "minimum";    // string in an array
    // some systems require preceding char with static to
    // enable array initialization

    char *wail = "ululate";    // wail points to string

    unsigned int ms = c_in_str(mmm, 'm');
    unsigned int us = c_in_str(wail, 'u');
    cout << ms << " m characters in " << mmm << endl;
    cout << us << " u characters in " << wail << endl;
    return 0;
}

// this function counts the number of ch characters
// in the string str
unsigned int c_in_str(const char * str, char ch)
{
    unsigned int count = 0;

    while (*str)    // quit when *str is '\0'
    {
        if (*str == ch)
            count++;
        str++;    // move pointer to next char
    }
    return count;
}
```

---

Here's the output of the program in Listing 7.9:

```
3 m characters in minimum
2 u characters in ululate
```

### Program Notes

Because the `c_int_str()` function in Listing 7.9 shouldn't alter the original string, it uses the `const` modifier when it declares the formal parameter `str`. Then if you mistakenly let the function alter part of the string, the compiler catches your error. Of course, you can use array notation instead to declare `str` in the function header:

```
unsigned int c_in_str(const char str[], char ch) // also okay
```

However, using pointer notation reminds you that the argument doesn't have to be the name of an array but can be some other form of pointer.

The function itself demonstrates a standard way to process the characters in a string:

```
while (*str)
{
    statements
    str++;
}
```

Initially, `str` points to the first character in the string, so `*str` represents the first character itself. For example, immediately after the first function call, `*str` has the value `m`, the first character in `minimum`. As long as the character is not the null character (`\0`), `*str` is nonzero, so the loop continues. At the end of each loop, the expression `str++` increments the pointer by 1 byte so that it points to the next character in the string. Eventually, `str` points to the terminating null character, making `*str` equal to `0`, which is the numeric code for the null character. That condition terminates the loop. (Why are string-processing functions ruthless? Because they stop at nothing.)

## Functions That Return C-Style Strings

Now suppose you want to write a function that returns a string. Well, a function can't do that. But it can return the address of a string, and that's more efficient. Listing 7.10, for example, defines a function called `buildstr()` that returns a pointer. This function takes two arguments: a character and a number. Using `new`, the function creates a string whose length equals the number, and then it initializes each element to the character. Then it returns a pointer to the new string.

### Listing 7.10 `strgback.cpp`

---

```
// strgback.cpp -- a function that returns a pointer to char
#include <iostream>
char * buildstr(char c, int n);    // prototype
int main()
{
```



is the last element set to `c`. The reason for filling the string from back to front instead of front to back is to avoid using an additional variable. Using the other order would involve something like this:

```
int i = 0;
while (i < n)
    pstr[i++] = c;
```

Note that the variable `pstr` is local to the `buildstr` function, so when that function terminates, the memory used for `pstr` (but not for the string) is freed. But because the function returns the value of `pstr`, the program is able to access the new string through the `ps` pointer in `main()`.

The program in Listing 7.10 uses `delete` to free memory used for the string after the string is no longer needed. Then it reuses `ps` to point to the new block of memory obtained for the next string and frees that memory. The disadvantage to this kind of design (having a function return a pointer to memory allocated by `new`) is that it makes it the programmer's responsibility to remember to use `delete`. In Chapter 12, "Classes and Dynamic Memory Allocation," you'll see how C++ classes, by using constructors and destructors, can take care of these details for you.

## Functions and Structures

Let's move from arrays to structures. It's easier to write functions for structures than for arrays. Although structure variables resemble arrays in that both can hold several data items, structure variables behave like basic, single-valued variables when it comes to functions. That is, unlike an array, a structure ties its data in to a single entity, or data object, that will be treated as a unit. Recall that you can assign one structure to another. Similarly, you can pass structures by value, just as you do with ordinary variables. In that case, the function works with a copy of the original structure. Also a function can return a structure. There's no funny business like the name of an array being the address of its first element. The name of a structure is simply the name of the structure, and if you want its address, you have to use the `&` address operator. (C++ and C both use the `&` symbol to denote the address operator. C++ additionally uses this operator to identify reference variables, to be discussed in Chapter 8.)

The most direct way to program by using structures is to treat them as you would treat the basic types—that is, pass them as arguments and use them, if necessary, as return values. However, there is one disadvantage to passing structures by value. If the structure is large, the space and effort involved in making a copy of a structure can increase memory requirements and slow down the system. For those reasons (and because, at first, C didn't allow the passing of structures by value), many C programmers prefer passing the address of a structure and then using a pointer to access the structure contents. C++ provides a third alternative, called *passing by reference*, that is discussed in Chapter 8. Let's examine the other two choices now, beginning with passing and returning entire structures.

## Passing and Returning Structures

Passing structures by value makes the most sense when the structure is relatively compact, so let's look at a couple examples along those lines. The first example deals with travel time (not to be confused with time travel). Some maps will tell you that it is 3 hours, 50 minutes, from Thunder Falls to Bingo City and 1 hour, 25 minutes, from Bingo City to Grotosquo. You can use a structure to represent such times, using one member for the hour value and a second member for the minute value. Adding two times is a little tricky because you might have to transfer some of the minutes to the hours part. For example, the two preceding times sum to 4 hours, 75 minutes, which should be converted to 5 hours, 15 minutes. Let's develop a structure to represent a time value and then a function that takes two such structures as arguments and returns a structure that represents their sum.

Defining the structure is simple:

```
struct travel_time
{
    int hours;
    int mins;
};
```

Next, consider the prototype for a `sum()` function that returns the sum of two such structures. The return value should be type `travel_time`, and so should the two arguments. Thus, the prototype should look like this:

```
travel_time sum(travel_time t1, travel_time t2);
```

To add two times, you first add the minute members. Integer division by 60 yields the number of hours to carry over, and the modulus operation (`%`) yields the number of minutes left. Listing 7.11 incorporates this approach into the `sum()` function and adds a `show_time()` function to display the contents of a `travel_time` structure.

---

### Listing 7.11 `travel.cpp`

```
// travel.cpp -- using structures with functions
#include <iostream>
struct travel_time
{
    int hours;
    int mins;
};
const int Mins_per_hr = 60;

travel_time sum(travel_time t1, travel_time t2);
void show_time(travel_time t);

int main()
{
    using namespace std;
```

```
travel_time day1 = {5, 45};    // 5 hrs, 45 min
travel_time day2 = {4, 55};    // 4 hrs, 55 min

travel_time trip = sum(day1, day2);
cout << "Two-day total: ";
show_time(trip);

travel_time day3= {4, 32};
cout << "Three-day total: ";
show_time(sum(trip, day3));

return 0;
}

travel_time sum(travel_time t1, travel_time t2)
{
    travel_time total;

    total.mins = (t1.mins + t2.mins) % Mins_per_hr;
    total.hours = t1.hours + t2.hours +
        (t1.mins + t2.mins) / Mins_per_hr;
    return total;
}

void show_time(travel_time t)
{
    using namespace std;
    cout << t.hours << " hours, "
        << t.mins << " minutes\n";
}
```

---

Here `travel_time` acts just like a standard type name; you can use it to declare variables, function return types, and function argument types. Because variables such as `total` and `t1` are `travel_time` structures, you can apply the dot membership operator to them. Note that because the `sum()` function returns a `travel_time` structure, you can use it as an argument for the `show_time()` function. Because C++ functions, by default, pass arguments by value, the `show_time(sum(trip, day3))` function call first evaluates the `sum(trip, day3)` function call in order to find its return value. The `show_time()` call then passes `sum()`'s return value, not the function itself, to `show_time()`. Here's the output of the program in Listing 7.11:

```
Two-day total: 10 hours, 40 minutes
Three-day total: 15 hours, 12 minutes
```



## Another Example of Using Functions with Structures

Much of what you learn about functions and C++ structures carries over to C++ classes, so it's worth looking at a second example. This time let's deal with space instead of time. In particular, this example defines two structures representing two different ways of describing positions and then develops functions to convert one form to the other and show the result. This example is a bit more mathematical than the last, but you don't have to follow the mathematics to follow the C++.

Suppose you want to describe the position of a point on the screen or a location on a map relative to some origin. One way is to state the horizontal offset and the vertical offset of the point from the origin. Traditionally, mathematicians use the symbol  $x$  to represent the horizontal offset and  $y$  to represent the vertical offset (see Figure 7.6). Together,  $x$  and  $y$  constitute *rectangular coordinates*. You can define a structure consisting of two coordinates to represent a position:

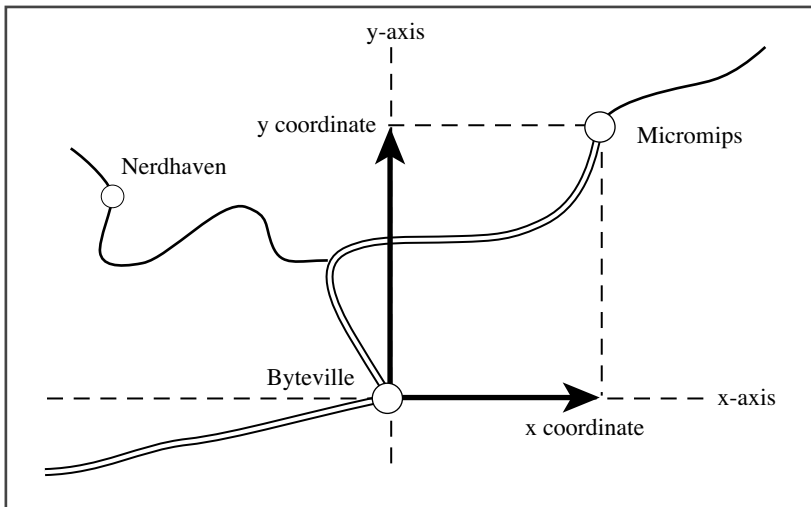

rectangular coordinates of Micromips relative to Byteville

Figure 7.6 Rectangular coordinates.

```
struct rect
{
    double x;           // horizontal distance from origin
    double y;           // vertical distance from origin
};
```

A second way to describe the position of a point is to state how far it is from the origin and in what direction it is (for example, 40 degrees north of east). Traditionally, mathematicians have measured the angle counterclockwise from the positive horizontal

axis (see Figure 7.7). The distance and angle together constitute *polar coordinates*. You can define a second structure to represent this view of a position:

```
struct polar
{
    double distance; // distance from origin
    double angle;    // direction from origin
};
```

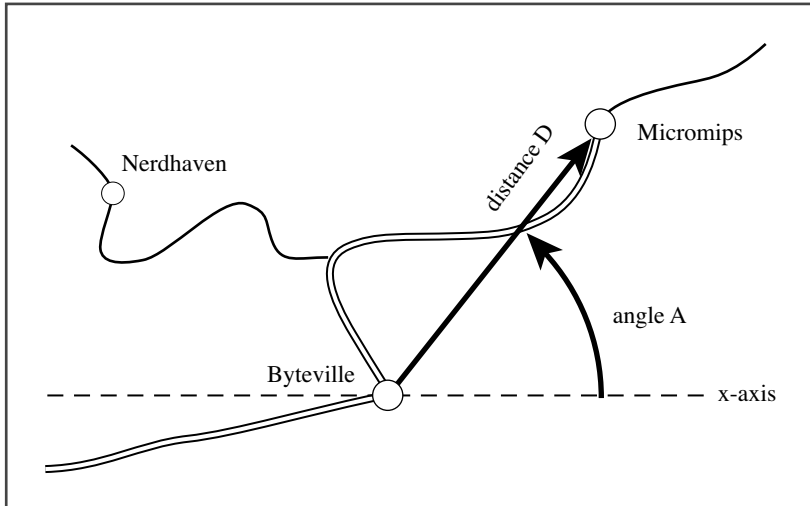

polar coordinates of Micromips relative to Byteville

Figure 7.7 Polar coordinates.

Let's construct a function that displays the contents of a type `polar` structure. The math functions in the C++ library (borrowed from C) assume that angles are in radians, so you need to measure angles in that unit. But for display purposes, you can convert radian measure to degrees. This means multiplying by  $180/\pi$ , which is approximately 57.29577951. Here's the function:

```
// show polar coordinates, converting angle to degrees
void show_polar (polar dapos)
{
    using namespace std;
    const double Rad_to_deg = 57.29577951;

    cout << "distance = " << dapos.distance;
    cout << ", angle = " << dapos.angle * Rad_to_deg;
    cout << " degrees\n";
}
```

Notice that the formal variable is type `polar`. When you pass a `polar` structure to this function, the structure contents are copied into the `dapos` structure, and the function then uses that copy in its work. Because `dapos` is a structure, the function uses the membership (dot) operator (see Chapter 4) to identify structure members.

Next, let's try something more ambitious and write a function that converts rectangular coordinates to polar coordinates. We'll have the function accept a `rect` structure as its argument and return a `polar` structure to the calling function. This involves using functions from the math library, so the program has to include the `cmath` header file (`math.h` on older systems). Also on some systems you have to tell the compiler to load the math library (see Chapter 1, "Getting Started with C++"). You can use the Pythagorean theorem to get the distance from the horizontal and vertical components:

```
distance = sqrt( x * x + y * y)
```

The `atan2()` function from the math library calculates the angle from the `x` and `y` values:

```
angle = atan2(y, x)
```

(There's also an `atan()` function, but it doesn't distinguish between angles 180 degrees apart. That uncertainty is no more desirable in a math function than it is in a wilderness guide.)

Given these formulas, you can write the function as follows:

```
// convert rectangular to polar coordinates
polar rect_to_polar(rect xypos) // type polar
{
    polar answer;

    answer.distance =
        sqrt( xypos.x * xypos.x + xypos.y * xypos.y );
    answer.angle = atan2(xypos.y, xypos.x);
    return answer; // returns a polar structure
}
```

Now that the functions are ready, writing the rest of the program is straightforward. Listing 7.12 presents the result.

#### Listing 7.12 `strctfun.cpp`

---

```
// strctfun.cpp -- functions with a structure argument
#include <iostream>
#include <cmath>

// structure declarations
struct polar
{
    double distance; // distance from origin
    double angle; // direction from origin
};
struct rect
```

```
{
    double x;           // horizontal distance from origin
    double y;           // vertical distance from origin
};

// prototypes
polar rect_to_polar(rect xypos);
void show_polar(polar dapos);

int main()
{
    using namespace std;
    rect rplace;
    polar pplace;

    cout << "Enter the x and y values: ";
    while (cin >> rplace.x >> rplace.y) // slick use of cin
    {
        pplace = rect_to_polar(rplace);
        show_polar(pplace);
        cout << "Next two numbers (q to quit): ";
    }
    cout << "Done.\n";
    return 0;
}

// convert rectangular to polar coordinates
polar rect_to_polar(rect xypos)
{
    using namespace std;
    polar answer;

    answer.distance =
        sqrt( xypos.x * xypos.x + xypos.y * xypos.y );
    answer.angle = atan2(xypos.y, xypos.x);
    return answer;    // returns a polar structure
}

// show polar coordinates, converting angle to degrees
void show_polar (polar dapos)
{
    using namespace std;
    const double Rad_to_deg = 57.29577951;

    cout << "distance = " << dapos.distance;
    cout << ", angle = " << dapos.angle * Rad_to_deg;
    cout << " degrees\n";
}

```

---

**Note**

Some compilers require explicit instructions to search the math library. For example, older versions of g++ uses this command line:

```
g++ structfun.C -lm
```

Here is a sample run of the program in Listing 7.12:

```
Enter the x and y values: 30 40
distance = 50, angle = 53.1301 degrees
Next two numbers (q to quit): -100 100
distance = 141.421, angle = 135 degrees
Next two numbers (q to quit): q
```

**Program Notes**

We've already discussed the two functions in Listing 7.12, so let's review how the program uses `cin` to control a `while` loop:

```
while (cin >> rplace.x >> rplace.y)
```

Recall that `cin` is an object of the `istream` class. The extraction operator (`>>`) is designed in such a way that `cin >> rplace.x` also is an object of that type. As you'll see in Chapter 11, "Working with Classes," class operators are implemented with functions. What really happens when you use `cin >> rplace.x` is that the program calls a function that returns a type `istream` value. If you apply the extraction operator to the `cin >> rplace.x` object (as in `cin >> rplace.x >> rplace.y`), you again get an object of the `istream` class. Thus, the entire `while` loop test expression eventually evaluates to `cin`, which, as you may recall, when used in the context of a test expression, is converted to a `bool` value of `true` or `false`, depending on whether input succeeded. In the loop in Listing 7.12, for example, `cin` expects the user to enter two numbers. If, instead, the user enters `q`, as shown in the sample output, `cin >>` recognizes that `q` is not a number. It leaves the `q` in the input queue and returns a value that's converted to `false`, terminating the loop.

Compare that approach for reading numbers to this simpler one:

```
for (int i = 0; i < limit; i++)
{
    cout << "Enter value #" << (i + 1) << ": ";
    cin >> temp;
    if (temp < 0)
        break;
    ar[i] = temp;
}
```

To terminate this loop early, you enter a negative number. This restricts input to non-negative values. This restriction fits the needs of some programs, but more typically you

would want a means of terminating a loop that doesn't exclude certain numeric values. Using `cin >>` as the test condition eliminates such restrictions because it accepts all valid numeric input. You should keep this trick in mind when you need an input loop for numbers. Also, you should keep in mind that non-numeric input sets an error condition that prevents the reading of any more input. If a program needs input subsequent to the input loop, you must use `cin.clear()` to reset input, and you might then need to get rid of the offending input by reading it. Listing 7.7 illustrates those techniques.

## Passing Structure Addresses

Suppose you want to save time and space by passing the address of a structure instead of passing the entire structure. This requires rewriting the functions so that they use pointers to structures. First, let's look at how you rewrite the `show_polar()` function. You need to make three changes:

- When calling the function, pass it the address of the structure (`&pplace`) rather than the structure itself (`pplace`).
- Declare the formal parameter to be a pointer-to-polar—that is, type `polar *`. Because the function shouldn't modify the structure, use the `const` modifier.
- Because the formal parameter is a pointer instead of a structure, use the indirect membership operator (`->`) rather than the membership operator (`.`).

After these changes are made, the function looks like this:

```
// show polar coordinates, converting angle to degrees
void show_polar (const polar * pda)
{
    using namespace std;
    const double Rad_to_deg = 57.29577951;

    cout << "distance = " << pda->distance;
    cout << ", angle = " << pda->angle * Rad_to_deg;
    cout << " degrees\n";
}
```

Next, let's alter `rect_to_polar`. This is more involved because the original `rect_to_polar` function returns a structure. To take full advantage of pointer efficiency, you should use a pointer instead of a return value. The way to do this is to pass two pointers to the function. The first points to the structure to be converted, and the second points to the structure that's to hold the conversion. Instead of *returning* a new structure, the function *modifies* an existing structure in the calling function. Hence, although the first argument is `const` pointer, the second is not `const`. Otherwise, you apply the same principles used to convert `show_polar()` to pointer arguments. Listing 7.13 shows the reworked program.

Listing 7.13 `strctptr.cpp`

---

```

// strctptr.cpp -- functions with pointer to structure arguments
#include <iostream>
#include <cmath>

// structure templates
struct polar
{
    double distance;    // distance from origin
    double angle;      // direction from origin
};
struct rect
{
    double x;           // horizontal distance from origin
    double y;          // vertical distance from origin
};

// prototypes
void rect_to_polar(const rect * pxy, polar * pda);
void show_polar (const polar * pda);

int main()
{
    using namespace std;
    rect rplace;
    polar pplace;

    cout << "Enter the x and y values: ";
    while (cin >> rplace.x >> rplace.y)
    {
        rect_to_polar(&rplace, &pplace);    // pass addresses
        show_polar(&pplace);                // pass address
        cout << "Next two numbers (q to quit): ";
    }
    cout << "Done.\n";
    return 0;
}

// show polar coordinates, converting angle to degrees
void show_polar (const polar * pda)
{
    using namespace std;
    const double Rad_to_deg = 57.29577951;

    cout << "distance = " << pda->distance;
    cout << ", angle = " << pda->angle * Rad_to_deg;

```

```
    cout << " degrees\n";
}

// convert rectangular to polar coordinates
void rect_to_polar(const rect * pxy, polar * pda)
{
    using namespace std;
    pda->distance =
        sqrt(pxy->x * pxy->x + pxy->y * pxy->y);
    pda->angle = atan2(pxy->y, pxy->x);
}
```

---

### Note

Some compilers require explicit instructions to search the math library. For example, older versions of g++ use this command line:

```
g++ structfun.C -lm
```

From the user's standpoint, the program in Listing 7.13 behaves like that in Listing 7.12. The hidden difference is that Listing 7.12 works with copies of structures, whereas Listing 7.13 uses pointers, allowing the functions to operate on the original structures.

## Functions and string Class Objects

Although C-style strings and `string` class objects serve much the same purpose, a `string` class object is more closely related to a structure than to an array. For example, you can assign a structure to another structure and an object to another object. You can pass a structure as a complete entity to a function, and you can pass an object as a complete entity. If you need several strings, you can declare a one-dimensional array of `string` objects instead of a two-dimensional array of `char`.

Listing 7.14 provides a short example that declares an array of `string` objects and passes the array to a function that displays the contents.

### Listing 7.14 `topfive.cpp`

---

```
// topfive.cpp -- handling an array of string objects
#include <iostream>
#include <string>
using namespace std;
const int SIZE = 5;
void display(const string sa[], int n);
int main()
{
    string list[SIZE];    // an array holding 5 string object
    cout << "Enter your " << SIZE << " favorite astronomical sights:\n";
```



```

    for (int i = 0; i < SIZE; i++)
    {
        cout << i + 1 << ": ";
        getline(cin, list[i]);
    }

    cout << "Your list:\n";
    display(list, SIZE);

    return 0;
}

void display(const string sa[], int n)
{
    for (int i = 0; i < n; i++)
        cout << i + 1 << ": " << sa[i] << endl;
}

```

---

Here's a sample run of the program in Listing 7.14:

Enter your 5 favorite astronomical sights:

1: **Orion Nebula**

2: **M13**

3: **Saturn**

4: **Jupiter**

5: **Moon**

Your list:

1: Orion Nebula

2: M13

3: Saturn

4: Jupiter

5: Moon

The main point to note in this example is that, aside from the `getline()` function, this program treats `string` just as it would treat any of the built-in types, such as `int`. If you want an array of `string`, you just use the usual array-declaration format:

```
string list[SIZE];    // an array holding 5 string object
```

Each element of the `list` array, then, is a `string` object and can be used as such:

```
getline(cin, list[i]);
```

Similarly, the formal argument `sa` is a pointer to a `string` object, so `sa[i]` is a `string` object and can be used accordingly:

```
cout << i + 1 << ": " << sa[i] << endl;
```

## Functions and array Objects

Class objects in C++ are based on structures, so some of the same programming considerations that apply to structures also apply to classes. For example, you can pass an object by value to a function, in which case the function acts on a copy of the original object. Alternatively, you can pass a pointer to an object, which allows the function to act on the original object. Let's look at an example using the C++11 `array` template class.

Suppose we have an `array` object intended to hold expense figures for each of the four seasons of the year:

```
std::array<double, 4> expenses;
```

(Recall that using the `array` class requires the `array` header file and that the name `array` is part of the `std` namespace.) If we want a function to display the contents of `expenses`, we can pass `expenses` by value:

```
show(expenses);
```

But if we want a function that modifies the `expenses` object, we need to pass the address of the object to the function:

```
fill(&expenses);
```

(The next chapter discusses an alternative approach, using references.) This is the same approach that Listing 7.13 used for structures.

How can we declare these two functions? The type of `expenses` is `array<double, 4>`, so that's what must appear in the prototypes:

```
void show(std::array<double, 4> da); // da an object
void fill(std::array<double, 4> * pa); // pa a pointer to an object
```

These considerations form the core of the sample program. The program adds a few more features. First, it replaces `4` with a symbolic constant:

```
const int Seasons = 4;
```

Second, it adds a `const array` object containing four `string` objects representing the four seasons:

```
const std::array<std::string, Seasons> Snames =
    {"Spring", "Summer", "Fall", "Winter"};
```

Note that the `array` template is not limited to holding the basic data types; it can use class types too. Listing 7.15 presents the program in full.

### Listing 7.15 `arobj.cpp`

---

```
//arobj.cpp -- functions with array objects (C++11)
#include <iostream>
#include <array>
#include <string>
// constant data
```

```
const int Seasons = 4;
const std::array<std::string, Seasons> Snames =
    {"Spring", "Summer", "Fall", "Winter"};

// function to modify array object
void fill(std::array<double, Seasons> * pa);
// function that uses array object without modifying it
void show(std::array<double, Seasons> da);

int main()
{
    std::array<double, Seasons> expenses;
    fill(&expenses);
    show(expenses);
    return 0;
}

void fill(std::array<double, Seasons> * pa)
{
    using namespace std;
    for (int i = 0; i < Seasons; i++)
    {
        cout << "Enter " << Snames[i] << " expenses: ";
        cin >> (*pa)[i];
    }
}

void show(std::array<double, Seasons> da)
{
    using namespace std;
    double total = 0.0;
    cout << "\nEXPENSES\n";
    for (int i = 0; i < Seasons; i++)
    {
        cout << Snames[i] << ": $" << da[i] << endl;
        total += da[i];
    }
    cout << "Total Expenses: $" << total << endl;
}
```

---

Here's a sample run:

```
Enter Spring expenses: 212
Enter Summer expenses: 256
Enter Fall expenses: 208
Enter Winter expenses: 244
```

```

EXPENSES
Spring: $212
Summer: $256
Fall: $208
Winter: $244
Total: $920

```

## Program Notes

Because the `const` array object `snames` is declared above all the functions, it can be used in any of the following function definitions. Like the `const seasons`, `snames` is shared by the whole source code file. The program doesn't have a `using` directive, so `array` and `string` have to be used with the `str::` qualifier. To keep the program short and focused on how functions can use objects, the `fill()` function doesn't check for valid input.

Both `fill()` and `show()` have drawbacks. For `show()`, the problem is that `expenses` holds four `double` values and it's inefficient to create a new object of that size and to copy the `expenses` values into it. The problem gets worse if we modify the program to handle `expenses` on a monthly basis or daily basis and expand `expenses` accordingly.

The `fill()` function avoids this inefficiency problem by using a pointer so that the function acts on the original object. But this comes at the cost of notation that makes the programming look more complicated:

```

fill(&expenses);    // don't forget the &
...
cin >> (*pa)[i];

```

In the last statement, `pa` is a pointer to an `array<double, 4>` object, so `*pa` is the object, and `(*pa)[i]` is an element in the object. The parentheses are required because of operator precedence. The logic is straightforward, but results enhance opportunities for making errors.

Using references, as discussed in Chapter 8, helps solve both the efficiency and the notational problems.

## Recursion

And now for something completely different. A C++ function has the interesting characteristic that it can call itself. (Unlike C, however, C++ does not let `main()` call itself.) This ability is termed *recursion*. Recursion is an important tool in certain types of programming, such as artificial intelligence, but we'll just take a superficial look (artificial shallowness) at how it works.

## Recursion with a Single Recursive Call

If a recursive function calls itself, then the newly called function calls itself, and so on, ad infinitum unless the code includes something to terminate the chain of calls. The usual method is to make the recursive call part of an `if` statement. For example, a type `void` recursive function called `recurs()` can have a form like this:

```
void recurs(argumentlist)
{
    statements1
    if (test)
        recurs(arguments)
    statements2
}
```

With luck or foresight, `test` eventually becomes `false`, and the chain of calls is broken.

Recursive calls produce an intriguing chain of events. As long as the `if` statement remains `true`, each call to `recurs()` executes `statements1` and then invokes a new incarnation of `recurs()` without reaching `statements2`. When the `if` statement becomes `false`, the current call then proceeds to `statements2`. Then when the current call terminates, program control returns to the previous version of `recurs()` that called it. Then, that version of `recurs()` completes executing its `statements2` section and terminates, returning control to the prior call, and so on. Thus, if `recurs()` undergoes five recursive calls, first the `statements1` section is executed five times in the order in which the functions were called, and then the `statements2` section is executed five times in the opposite order from the order in which the functions were called. After going into five levels of recursion, the program then has to back out through the same five levels. Listing 7.16 illustrates this behavior.

### Listing 7.16 `recur.cpp`

---

```
// recur.cpp -- using recursion
#include <iostream>
void countdown(int n);

int main()
{
    countdown(4);           // call the recursive function
    return 0;
}

void countdown(int n)
{
    using namespace std;
    cout << "Counting down ... " << n << endl;
    if (n > 0)
```

```

        countdown(n-1);    // function calls itself
    cout << n << ": Kaboom!\n";
}

```

---

Here's the annotated output of the program in Listing 7.16:

```

Counting down ... 4    <level 1; adding levels of recursion
Counting down ... 3    <level 2
Counting down ... 2    <level 3
Counting down ... 1    <level 4
Counting down ... 0    <level 5; final recursive call
0: Kaboom!             <level 5; beginning to back out
1: Kaboom!             <level 4
2: Kaboom!             <level 3
3: Kaboom!             <level 2
4: Kaboom!             <level 1

```

Note that each recursive call creates its own set of variables, so by the time the program reaches the fifth call, it has five separate variables called `n`, each with a different value. You can verify this for yourself by modifying Listing 7.16 so that it displays the address of `n` as well as its value:

```

cout << "Counting down ... " << n << " (n at " << &n << ")" << endl;
...
cout << n << ": Kaboom!"; << "          (n at " << &n << ")" << endl;

```

Doing so produces output like the following:

```

Counting down ... 4 (n at 0012FE0C)
Counting down ... 3 (n at 0012FD34)
Counting down ... 2 (n at 0012FC5C)
Counting down ... 1 (n at 0012FB84)
Counting down ... 0 (n at 0012FAAC)
0: Kaboom!         (n at 0012FAAC)
1: Kaboom!         (n at 0012FB84)
2: Kaboom!         (n at 0012FC5C)
3: Kaboom!         (n at 0012FD34)
4: Kaboom!         (n at 0012FE0C)

```

Note how the `n` having the value 4 is stored at one location (memory address 0012FE0C in this example), the `n` having the value 3 is stored at a second location (memory address 0012FD34), and so on. Also note how the address of `n` for a particular level during the “Counting down” stage is the same as its address for the same level during the “Kaboom!” stage.

## Recursion with Multiple Recursive Calls

Recursion is particularly useful for situations that call for repeatedly subdividing a task into two smaller, similar tasks. For example, consider this approach to drawing a ruler.

Mark the two ends, locate the midpoint, and mark it. Then apply this same procedure to the left half of the ruler and then to the right half. If you want more subdivisions, apply the same procedure to each of the current subdivisions. This recursive approach is sometimes called the *divide-and-conquer strategy*. Listing 7.17 illustrates this approach, with the recursive function `subdivide()`. It uses a string initially filled with spaces except for a `|` character at each end. The main program uses a loop to call the `subdivide()` function six times, each time increasing the number of recursion levels and printing the resulting string. Thus, each line of output represents an additional level of recursion. To remind you that it's an option, the program uses the `std::` qualifier instead of a `using` directive.

#### Listing 7.17 `ruler.cpp`

---

```
// ruler.cpp -- using recursion to subdivide a ruler
#include <iostream>
const int Len = 66;
const int Divs = 6;
void subdivide(char ar[], int low, int high, int level);
int main()
{
    char ruler[Len];
    int i;
    for (i = 1; i < Len - 2; i++)
        ruler[i] = ' ';
    ruler[Len - 1] = '\0';
    int max = Len - 2;
    int min = 0;
    ruler[min] = ruler[max] = '|';
    std::cout << ruler << std::endl;
    for (i = 1; i <= Divs; i++)
    {
        subdivide(ruler, min, max, i);
        std::cout << ruler << std::endl;
        for (int j = 1; j < Len - 2; j++)
            ruler[j] = ' '; // reset to blank ruler
    }

    return 0;
}

void subdivide(char ar[], int low, int high, int level)
{
    if (level == 0)
        return;
    int mid = (high + low) / 2;
```





## Function Pointer Basics

Let's clarify this process with an example. Suppose you want to design an `estimate()` function that estimates the amount of time necessary to write a given number of lines of code, and you want different programmers to use the function. Part of the code for `estimate()` will be the same for all users, but the function will allow each programmer to provide his or her own algorithm for estimating time. The mechanism for that will be to pass to `estimate()` the address of the particular algorithm function the programmer wants to use. To implement this plan, you need to be able to do the following:

- Obtain the address of a function.
- Declare a pointer to a function.
- Use a pointer to a function to invoke the function.

### Obtaining the Address of a Function

Obtaining the address of a function is simple: You just use the function name without trailing parentheses. That is, if `think()` is a function, then `think` is the address of the function. To pass a function as an argument, you pass the function name. Be sure you distinguish between passing the *address* of a function and passing the *return value* of a function:

```
process(think); // passes address of think() to process()
thought(think()); // passes return value of think() to thought()
```

The `process()` call enables the `process()` function to invoke the `think()` function from within `process()`. The `thought()` call first invokes the `think()` function and then passes the return value of `think()` to the `thought()` function.

### Declaring a Pointer to a Function

To declare pointers to a data type, the declaration has had to specify exactly to what type the pointer points. Similarly, a pointer to a function has to specify to what type of function the pointer points. This means the declaration should identify the function's return type and the function's signature (its argument list). That is, the declaration should provide the same information about a function that a function prototype does. For example, suppose Pam LeCoder has written a time-estimating function with the following prototype:

```
double pam(int); // prototype
```

Here's what a declaration of an appropriate pointer type looks like:

```
double (*pf)(int); // pf points to a function that takes
                  // one int argument and that
                  // returns type double
```

#### Tip

In general, to declare a pointer to a particular kind of function, you can first write a prototype for a regular function of the desired kind and then replace the function name with an expression in the form `(*pf)`. In this case, `pf` is a pointer to a function of that type.

The declaration requires the parentheses around `*pf` to provide the proper operator precedence. Parentheses have a higher precedence than the `*` operator, so `*pf(int)` means `pf()` is a function that returns a pointer, whereas `(*pf)(int)` means `pf` is a pointer to a function:

```
double (*pf)(int); // pf points to a function that returns double
double *pf(int);  // pf() a function that returns a pointer-to-double
```

After you declare `pf` properly, you can assign to it the address of a matching function:

```
double pam(int);
double (*pf)(int);
pf = pam;           // pf now points to the pam() function
```

Note that `pam()` has to match `pf` in both signature and return type. The compiler rejects nonmatching assignments:

```
double ned(double);
int ted(int);
double (*pf)(int);
pf = ned;           // invalid -- mismatched signature
pf = ted;           // invalid -- mismatched return types
```

Let's return to the `estimate()` function mentioned earlier. Suppose you want to pass to it the number of lines of code to be written and the address of an estimating algorithm, such as the `pam()` function. It could have the following prototype:

```
void estimate(int lines, double (*pf)(int));
```

This declaration says the second argument is a pointer to a function that has an `int` argument and a `double` return value. To have `estimate()` use the `pam()` function, you pass `pam()`'s address to it:

```
estimate(50, pam); // function call telling estimate() to use pam()
```

Clearly, the tricky part about using pointers to functions is writing the prototypes, whereas passing the address is very simple.

### Using a Pointer to Invoke a Function

Now we get to the final part of the technique, which is using a pointer to call the pointed-to function. The clue comes in the pointer declaration. There, recall, `(*pf)` plays the same role as a function name. Thus, all you have to do is use `(*pf)` as if it were a function name:

```
double pam(int);
double (*pf)(int);
pf = pam;           // pf now points to the pam() function
double x = pam(4); // call pam() using the function name
double y = (*pf)(5); // call pam() using the pointer pf
```

Actually, C++ also allows you to use `pf` as if it were a function name:

```
double y = pf(5);    // also call pam() using the pointer pf
```

Using the first form is uglier, but it provides a strong visual reminder that the code is using a function pointer.

### History Versus Logic

Holy syntax! How can `pf` and `(*pf)` be equivalent? One school of thought maintains that because `pf` is a pointer to a function, `*pf` is a function; hence, you should use `(*pf)()` as a function call. A second school maintains that because the name of a function is a pointer to that function, a pointer to that function should act like the name of a function; hence you should use `pf()` as a function call. C++ takes the compromise view that both forms are correct, or at least can be allowed, even though they are logically inconsistent with each other. Before you judge that compromise too harshly, reflect that the ability to hold views that are not logically self-consistent is a hallmark of the human mental process.

## A Function Pointer Example

Listing 7.18 demonstrates using function pointers in a program. It calls the `estimate()` function twice, once passing the `betsy()` function address and once passing the `pam()` function address. In the first case, `estimate()` uses `betsy()` to calculate the number of hours necessary, and in the second case, `estimate()` uses `pam()` for the calculation. This design facilitates future program development. When Ralph develops his own algorithm for estimating time, he doesn't have to rewrite `estimate()`. Instead, he merely needs to supply his own `ralph()` function, making sure it has the correct signature and return type. Of course, rewriting `estimate()` isn't a difficult task, but the same principle applies to more complex code. Also the function pointer method allows Ralph to modify the behavior of `estimate()`, even if he doesn't have access to the source code for `estimate()`.

### Listing 7.18 `fun_ptr.cpp`

---

```
// fun_ptr.cpp -- pointers to functions
#include <iostream>
double betsy(int);
double pam(int);

// second argument is pointer to a type double function that
// takes a type int argument
void estimate(int lines, double (*pf)(int));

int main()
{
    using namespace std;
    int code;
```

```
    cout << "How many lines of code do you need? ";
    cin >> code;
    cout << "Here's Betsy's estimate:\n";
    estimate(code, betsy);
    cout << "Here's Pam's estimate:\n";
    estimate(code, pam);
    return 0;
}

double betsy(int lns)
{
    return 0.05 * lns;
}

double pam(int lns)
{
    return 0.03 * lns + 0.0004 * lns * lns;
}

void estimate(int lines, double (*pf)(int))
{
    using namespace std;
    cout << lines << " lines will take ";
    cout << (*pf)(lines) << " hour(s)\n";
}
```

---

Here is a sample run of the program in Listing 7.18:

```
How many lines of code do you need? 30
Here's Betsy's estimate:
30 lines will take 1.5 hour(s)
Here's Pam's estimate:
30 lines will take 1.26 hour(s)
```

Here is a second sample run of the program:

```
How many lines of code do you need? 100
Here's Betsy's estimate:
100 lines will take 5 hour(s)
Here's Pam's estimate:
100 lines will take 7 hour(s)
```

## Variations on the Theme of Function Pointers

With function pointers, the notation can get intimidating. Let's look at an example that illustrates some of the challenges of function pointers and ways of dealing with them. To begin, here are prototypes for some functions that share the same signature and return type:

```
const double * f1(const double ar[], int n);
const double * f2(const double [], int);
const double * f3(const double *, int);
```

The signatures might look different, but they are the same. First, recall that in a function prototype parameter list `const double ar[]` and `const double * ar` have exactly the same meaning. Second, recall that in a prototype you can omit identifiers. Therefore, `const double ar[]` can be reduced to `const double []`, and `const double * ar` can be reduced to `const double *`. So all the function signatures shown previously have the same meaning. Function definitions, on the other hand, do provide identifiers, so either `const double ar[]` or `const double * ar` will serve in that context.

Next, suppose you wish to declare a pointer that can point to one of these three functions. The technique, you'll recall, is if `pa` is the desired pointer, take the prototype for a target function and replace the function name with `(*pa)`:

```
const double * (*p1)(const double *, int);
```

This can be combined with initialization:

```
const double * (*p1)(const double *, int) = f1;
```

With the C++11 automatic type deduction feature, you can simplify this a bit:

```
auto p2 = f2; // C++11 automatic type deduction
```

Now consider the following statements:

```
cout << (*p1)(av,3) << " : " << (*p1)(av,3) << endl;
cout << p2(av,3) << " : " << *p2(av,3) << endl;
```

Both `(*p1)(av,3)` and `p2(av,3)`, recall, represent calling the pointed-to functions (`f1()` and `f2()`, in this case) with `av` and `3` as arguments. Therefore, what should print are the return values of these two functions. The return values are type `const double *` (that is, address of `double` values). So the first part of each `cout` expression should print the address of a `double` value. To see the actual value stored at the addresses, we need to apply the `*` operator to these addresses, and that's what the expressions `(*p1)(av,3)` and `*p2(av,3)` do.

With three functions to work with, it could be handy to have an array of function pointers. Then one can use a `for` loop to call each function, via its pointer, in turn. What would that look like? Clearly, it should look something like the declaration of a single pointer, but there should be a `[3]` somewhere to indicate an array of three pointers. The question is where. And here's the answer (including initialization):

```
const double * (*pa[3])(const double *, int) = {f1,f2,f3};
```

Why put the `[3]` there? Well, `pa` is an array of three things, and the starting point for declaring an array of three things is this: `pa[3]`. The rest of the declaration is about what kind of thing is to be placed in the array. Operator precedence ranks `[]` higher than `*`, so `*pa[3]` says `pa` is an array of three pointers. The rest of the declaration indicates what each pointer points to: a function with a signature of `const double *, int` and a return

type of `const double *`. Hence, `pa` is an array of three pointers, each of which is a pointer to a function that takes a `const double *` and `int` as arguments and returns a `const double *`.

Can we use `auto` here? No. Automatic type deduction works with a single initializer value, not an initialization list. But now that we have the array `pa`, it is simple to declare a pointer of the matching type:

```
auto pb = pa;
```

The name of an array, as you'll recall, is a pointer to its first element, so both `pa` and `pb` are pointers to a pointer to a function.

How can we use them to call a function? Both `pa[i]` and `pb[i]` represent pointers in the array, so you can use either of the function call notations with either of them:

```
const double * px = pa[0] (av, 3);
const double * py = (*pb[1]) (av, 3);
```

And you can apply the `*` operator to get the pointed-to `double` value:

```
double x = *pa[0] (av, 3);
double y = *(*pb[1]) (av, 3);
```

Something else you can do (and who wouldn't want to?) is create a pointer to the whole array. Because the array name `pa` already is a pointer to a function pointer, a pointer to the array would be a pointer to a pointer to a pointer. This sounds intimidating, but because the result can be initialed with a single value, you can use `auto`:

```
auto pc = &pa; // C++11 automatic type deduction
```

What if you prefer to do it yourself? Clearly, the declaration should resemble the declaration for `pa`, but because there is one more level of indirection, we'll need one more `*` stuck somewhere. In particular, if we call the new pointer `pd`, we need to indicate that it is pointer, not an array name. This suggests the heart of the declaration should be `(*pd)[3]`. The parentheses bind the `pd` identifier to the `*`:

```
*pd[3] // an array of 3 pointers
(*pd)[3] // a pointer to an array of 3 elements
```

In other words, `pd` is a pointer, and it points to an array of three things. What those things are is described by the rest of the original declaration of `pa`. This approach yields the following:

```
const double *(*pd)[3] (const double *, int) = &pa;
```

To call a function, realize that if `pd` points to an array, then `*pd` is the array and `(*pd)[i]` is an array element, which is a pointer to a function. The simpler notation, then, for the function call is `(*pd)[i] (av, 3)`, and `*(*pd)[i] (av, 3)` would be the value that the returned pointer points to. Alternatively, you could use second syntax for invoking a function with a pointer and use `(*(*pd)[i]) (av, 3)` for the call and `*(*(*pd)[i]) (av, 3)` for the pointed-to `double` value.

Be aware of the difference between `pa`, which as an array name is an address, and `&pa`. As you've seen before, in most contexts `pa` is the address of the first element of the array—that is, `&pa[0]`. Therefore, it is the address of a single pointer. But `&pa` is the address of the entire array (that is, of a block of three pointers). Numerically, `pa` and `&pa` may have the same value, but they are of different types. One practical difference is that `pa+1` is the address of the next element in the array, whereas `&pa+1` is the address of the next block of 12 bytes (assuming addresses are 4 bytes) following the `pa` array. Another difference is that you dereference `pa` once to get the value of the first element and you dereference `&pa` twice to get the same value:

```
**&pa == *pa == pa[0]
```

Listing 7.19 puts this discussion to use. For illustrative purposes, the functions `f1()`, and so on, have been kept embarrassingly simple. The program shows, as comments, the C++98 alternatives to using `auto`.

#### Listing 7.19 `arfupt.cpp`

---

```
// arfupt.cpp -- an array of function pointers
#include <iostream>
// various notations, same signatures
const double * f1(const double ar[], int n);
const double * f2(const double [], int);
const double * f3(const double *, int);

int main()
{
    using namespace std;
    double av[3] = {1112.3, 1542.6, 2227.9};

    // pointer to a function
    const double *(*p1)(const double *, int) = f1;
    auto p2 = f2; // C++11 automatic type deduction
    // pre-C++11 can use the following code instead
    // const double *(*p2)(const double *, int) = f2;
    cout << "Using pointers to functions:\n";
    cout << " Address Value\n";
    cout << (*p1)(av,3) << " : " << *(*p1)(av,3) << endl;
    cout << p2(av,3) << " : " << *p2(av,3) << endl;

    // pa an array of pointers
    // auto doesn't work with list initialization
    const double *(*pa[3])(const double *, int) = {f1,f2,f3};
    // but it does work for initializing to a single value
    // pb a pointer to first element of pa
    auto pb = pa;
    // pre-C++11 can use the following code instead
```

```

// const double *(*pb)(const double *, int) = pa;
cout << "\nUsing an array of pointers to functions:\n";
cout << " Address Value\n";
for (int i = 0; i < 3; i++)
    cout << pa[i](av,3) << ": " << *pa[i](av,3) << endl;
cout << "\nUsing a pointer to a pointer to a function:\n";
cout << " Address Value\n";
for (int i = 0; i < 3; i++)
    cout << pb[i](av,3) << ": " << *pb[i](av,3) << endl;

// what about a pointer to an array of function pointers
cout << "\nUsing pointers to an array of pointers:\n";
cout << " Address Value\n";
// easy way to declare pc
auto pc = &pa;
// pre-C++11 can use the following code instead
// const double *(*pc)[3](const double *, int) = &pa;
cout << (*pc)[0](av,3) << ": " << *(*pc)[0](av,3) << endl;
// hard way to declare pd
const double *(*pd)[3](const double *, int) = &pa;
// store return value in pdb
const double * pdb = (*pd)[1](av,3);
cout << pdb << ": " << *pdb << endl;
// alternative notation
cout << *(*pd)[2](av,3) << ": " << *(*pd)[2](av,3) << endl;
// cin.get();
return 0;
}

// some rather dull functions

const double * f1(const double * ar, int n)
{
    return ar;
}
const double * f2(const double ar[], int n)
{
    return ar+1;
}
const double * f3(const double ar[], int n)
{
    return ar+2;
}

```

---



And here is the output:

Using pointers to functions:

```
Address  Value
002AF9E0: 1112.3
002AF9E8: 1542.6
```

Using an array of pointers to functions:

```
Address  Value
002AF9E0: 1112.3
002AF9E8: 1542.6
002AF9F0: 2227.9
```

Using a pointer to a pointer to a function:

```
Address  Value
002AF9E0: 1112.3
002AF9E8: 1542.6
002AF9F0: 2227.9
```

Using pointers to an array of pointers:

```
Address  Value
002AF9E0: 1112.3
002AF9E8: 1542.6
002AF9F0: 2227.9
```

The addresses shown are the locations of the `double` values in the `av` array.

This example may seem esoteric, but pointers to arrays of pointers to functions are not unheard of. Indeed, the usual implementation of virtual class methods (see Chapter 13, “Class Inheritance”) uses this technique. Fortunately, the compiler handles the details.

### Appreciating `auto`

One of the goals of C++11 is to make C++ easier to use, letting the programmer concentrate more on design and less on details. Listing 7.19 surely illustrates this point:

```
auto pc = &pa; // C++11 automatic type deduction
const double *(*(*pd)[3])(const double *, int) = &pa; // C++98, do it yourself
```

The automatic type deduction feature reflects a philosophical shift in the role of the compiler. In C++98, the compiler uses its knowledge to tell you when you are wrong. In C++11, at least with this feature, it uses its knowledge to help you get the right declaration.

There is a potential drawback. Automatic type deduction ensures that the type of the variable matches the type of the initializer, but it still is possible that you might provide the wrong type of initializer:

```
auto pc = *pa; // oops! used *pa instead of &pa
```

This declaration would make `pc` match the type of `*pa`, and that would result in a compile-time error when Listing 7.19 later uses `pc`, assuming that it is of the same type as `&pa`.

## Simplifying with typedef

C++ does provide tools other than `auto` for simplifying declarations. You may recall from Chapter 5, “Loops and Relational Expressions,” that the `typedef` keyword allows you to create a type alias:

```
typedef double real; // makes real another name for double
```

The technique is to declare the alias as if it were an identifier and to insert the keyword `typedef` at the beginning. So you can do this to make `p_fun` an alias for the function pointer type used in Listing 7.19:

```
typedef const double *(*p_fun)(const double *, int); // p_fun now a type name
p_fun p1 = f1; // p1 points to the f1() function
```

You then can use this type to build elaborations:

```
p_fun pa[3] = {f1,f2,f3}; // pa an array of 3 function pointers
p_fun (*pd)[3] = &pa; // pd points to an array of 3 function pointers
```

Not only does `typedef` save you some typing, it makes writing the code less error prone, and it makes the program easier to understand.

## Summary

Functions are the C++ programming modules. To use a function, you need to provide a definition and a prototype, and you have to use a function call. The function definition is the code that implements what the function does. The function prototype describes the function interface: how many and what kinds of values to pass to the function and what sort of return type, if any, to get from it. The function call causes the program to pass the function arguments to the function and to transfer program execution to the function code.

By default, C++ functions pass arguments by value. This means that the formal parameters in the function definition are new variables that are initialized to the values provided by the function call. Thus, C++ functions protect the integrity of the original data by working with copies.

C++ treats an array name argument as the address of the first element of the array. Technically, this is still passing by value because the pointer is a copy of the original address, but the function uses the pointer to access the contents of the original array. When you declare formal parameters for a function (and only then), the following two declarations are equivalent:

```
typeName arr[];
typeName * arr;
```

Both of these mean that `arr` is a pointer to `typeName`. When you write the function code, however, you can use `arr` as if it were an array name in order to access elements: `arr[i]`. Even when passing pointers, you can preserve the integrity of the original data by declaring the formal argument to be a pointer to a `const` type. Because passing the

address of an array conveys no information about the size of the array, you normally pass the array size as a separate argument. Alternatively, you can pass pointers to the beginning of the array and to one position past the end to indicate a range, as do the algorithms in the STL.

C++ provides three ways to represent C-style strings: by using a character array, a string constant, or a pointer to a string. All are type `char*` (pointer-to-char), so they are passed to a function as a type `char*` argument. C++ uses the null character (`\0`) to terminate strings, and string functions test for the null character to determine the end of any string they are processing.

C++ also provides the `string` class to represent strings. A function can accept `string` objects as arguments and use a `string` object as a return value. The `string` class `size()` method can be used to determine the length of a stored string.

C++ treats structures the same as basic types, meaning that you can pass them by value and use them as function return types. However, if a structure is large, it might be more efficient to pass a pointer to the structure and let the function work with the original data. These same considerations apply to class objects.

A C++ function can be recursive; that is, the code for a particular function can include a call of itself.

The name of a C++ function acts as the address of the function. By using a function argument that is a pointer to a function, you can pass to a function the name of a second function that you want the first function to evoke.

## Chapter Review

1. What are the three steps in using a function?
2. Construct function prototypes that match the following descriptions:
  - a. `igor()` takes no arguments and has no return value.
  - b. `tofu()` takes an `int` argument and returns a `float`.
  - c. `mpg()` takes two type `double` arguments and returns a `double`.
  - d. `summation()` takes the name of a `long` array and an array size as values and returns a `long` value.
  - e. `doctor()` takes a `string` argument (the string is not to be modified) and returns a `double` value.
  - f. `ofcourse()` takes a `boss` structure as an argument and returns nothing.
  - g. `plot()` takes a pointer to a `map` structure as an argument and returns a `string`.

3. Write a function that takes three arguments: the name of an `int` array, the array size, and an `int` value. Have the function set each element of the array to the `int` value.
4. Write a function that takes three arguments: a pointer to the first element of a range in an array, a pointer to the element following the end of a range in an array, and an `int` value. Have the function set each element of the array to the `int` value.
5. Write a function that takes a `double` array name and an array size as arguments and returns the largest value in that array. Note that this function shouldn't alter the contents of the array.
6. Why don't you use the `const` qualifier for function arguments that are one of the fundamental types?
7. What are the three forms a C-style string can take in a C++ program?
8. Write a function that has this prototype:

```
int replace(char * str, char c1, char c2);
```

Have the function replace every occurrence of `c1` in the string `str` with `c2`, and have the function return the number of replacements it makes.
9. What does the expression `*"pizza"` mean? What about `"taco"[2]`?
10. C++ enables you to pass a structure by value, and it lets you pass the address of a structure. If `glitz` is a structure variable, how would you pass it by value? How would you pass its address? What are the trade-offs of the two approaches?
11. The function `judge()` has a type `int` return value. As an argument, it takes the address of a function. The function whose address is passed, in turn, takes a pointer to a `const char` as an argument and returns an `int`. Write the function prototype.
12. Suppose we have the following structure declaration:

```
struct applicant {
    char name[30];
    int credit_ratings[3];
};
```

  - a. Write a function that takes an `applicant` structure as an argument and displays its contents.
  - b. Write a function that takes the address of an `applicant` structure as an argument and displays the contents of the pointed-to structure.
13. Suppose the functions `f1()` and `f2()` have the following prototypes:

```
void f1(applicant * a);
const char * f2(const applicant * a1, const applicant * a2);
```

Declare `p1` as a pointer that points to `f1` and `p2` as a pointer to `f2`. Declare `ap` as an array of five pointers of the same type as `p1`, and declare `pa` as a pointer to an array of ten pointers of the same type as `p2`. Use `typedef` as an aid.

## Programming Exercises

1. Write a program that repeatedly asks the user to enter pairs of numbers until at least one of the pair is 0. For each pair, the program should use a function to calculate the harmonic mean of the numbers. The function should return the answer to `main()`, which should report the result. The harmonic mean of the numbers is the inverse of the average of the inverses and can be calculated as follows:

$$\text{harmonic mean} = 2.0 \times x \times y / (x + y)$$

2. Write a program that asks the user to enter up to 10 golf scores, which are to be stored in an array. You should provide a means for the user to terminate input prior to entering 10 scores. The program should display all the scores on one line and report the average score. Handle input, display, and the average calculation with three separate array-processing functions.
3. Here is a structure declaration:

```
struct box
{
    char maker[40];
    float height;
    float width;
    float length;
    float volume;
};
```

- a. Write a function that passes a `box` structure by value and that displays the value of each member.
  - b. Write a function that passes the address of a `box` structure and that sets the `volume` member to the product of the other three dimensions.
  - c. Write a simple program that uses these two functions.
4. Many state lotteries use a variation of the simple lottery portrayed by Listing 7.4. In these variations you choose several numbers from one set and call them the field numbers. For example, you might select five numbers from the field of 1–47). You also pick a single number (called a mega number or a power ball, etc.) from a second range, such as 1–27. To win the grand prize, you have to guess all the picks correctly. The chance of winning is the product of the probability of picking all the field numbers times the probability of picking the mega number. For instance, the

probability of winning the example described here is the product of the probability of picking 5 out of 47 correctly times the probability of picking 1 out of 27 correctly. Modify Listing 7.4 to calculate the probability of winning this kind of lottery.

5. Define a recursive function that takes an integer argument and returns the factorial of that argument. Recall that 3 factorial, written  $3!$ , equals  $3 \times 2!$ , and so on, with  $0!$  defined as 1. In general, if  $n$  is greater than zero,  $n! = n * (n - 1)!$ . Test your function in a program that uses a loop to allow the user to enter various values for which the program reports the factorial.

6. Write a program that uses the following functions:

`Fill_array()` takes as arguments the name of an array of `double` values and an array size. It prompts the user to enter `double` values to be entered in the array. It ceases taking input when the array is full or when the user enters non-numeric input, and it returns the actual number of entries.

`Show_array()` takes as arguments the name of an array of `double` values and an array size and displays the contents of the array.

`Reverse_array()` takes as arguments the name of an array of `double` values and an array size and reverses the order of the values stored in the array.

The program should use these functions to fill an array, show the array, reverse the array, show the array, reverse all but the first and last elements of the array, and then show the array.

7. Redo Listing 7.7, modifying the three array-handling functions to each use two pointer parameters to represent a range. The `fill_array()` function, instead of returning the actual number of items read, should return a pointer to the location after the last location filled; the other functions can use this pointer as the second argument to identify the end of the data.

8. Redo Listing 7.15 without using the `array` class. Do two versions:

- a. Use an ordinary array of `const char *` for the strings representing the season names, and use an ordinary array of `double` for the expenses.
- b. Use an ordinary array of `const char *` for the strings representing the season names, and use a structure whose sole member is an ordinary array of `double` for the expenses. (This design is similar to the basic design of the `array` class.)

9. This exercise provides practice in writing functions dealing with arrays and structures. The following is a program skeleton. Complete it by providing the described functions:

```
#include <iostream>
using namespace std;
```

```

const int SLEN = 30;
struct student {
    char fullname[SLEN];
    char hobby[SLEN];
    int ooplevel;
};
// getinfo() has two arguments: a pointer to the first element of
// an array of student structures and an int representing the
// number of elements of the array. The function solicits and
// stores data about students. It terminates input upon filling
// the array or upon encountering a blank line for the student
// name. The function returns the actual number of array elements
// filled.
int getinfo(student pa[], int n);

// display1() takes a student structure as an argument
// and displays its contents
void display1(student st);

// display2() takes the address of student structure as an
// argument and displays the structure's contents
void display2(const student * ps);

// display3() takes the address of the first element of an array
// of student structures and the number of array elements as
// arguments and displays the contents of the structures
void display3(const student pa[], int n);

int main()
{
    cout << "Enter class size: ";
    int class_size;
    cin >> class_size;
    while (cin.get() != '\n')
        continue;

    student * ptr_stu = new student[class_size];
    int entered = getinfo(ptr_stu, class_size);
    for (int i = 0; i < entered; i++)
    {
        display1(ptr_stu[i]);
        display2(&ptr_stu[i]);
    }
    display3(ptr_stu, entered);
    delete [] ptr_stu;
    cout << "Done\n";
    return 0;
}

```

10. Design a function `calculate()` that takes two `double` values and a pointer to a function that takes two `double` arguments and returns a `double`. The `calculate()` function should also be type `double`, and it should return the value that the pointed-to function calculates, using the `double` arguments to `calculate()`. For example, suppose you have this definition for the `add()` function:

```
double add(double x, double y)
{
    return x + y;
}
```

Then, the function call in the following would cause `calculate()` to pass the values 2.5 and 10.4 to the `add()` function and then return the `add()` return value (12.9):

```
double q = calculate(2.5, 10.4, add);
```

Use these functions and at least one additional function in the `add()` mold in a program. The program should use a loop that allows the user to enter pairs of numbers. For each pair, use `calculate()` to invoke `add()` and at least one other function. If you are feeling adventurous, try creating an array of pointers to `add()`-style functions and use a loop to successively apply `calculate()` to a series of functions by using these pointers. Hint: Here's how to declare such an array of three pointers:

```
double (*pf[3])(double, double);
```

You can initialize such an array by using the usual array initialization syntax and function names as addresses.



*This page intentionally left blank*

# Adventures in Functions

In this chapter you'll learn about the following:

- Inline functions
- Reference variables
- How to pass function arguments by reference
- Default arguments
- Function overloading
- Function templates
- Function template specializations

With Chapter 7, “Functions: C++’s Programming Modules,” under your belt, you now know a lot about C++ functions, but there’s much more to come. C++ provides many new function features that separate C++ from its C heritage. The new features include inline functions, by-reference variable passing, default argument values, function overloading (polymorphism), and template functions. This chapter, more than any other you’ve read so far, explores features found in C++ but not C, so it marks your first major foray into plus-plussedness.

## C++ Inline Functions

*Inline functions* are a C++ enhancement designed to speed up programs. The primary distinction between normal functions and inline functions is not in how you code them but in how the C++ compiler incorporates them into a program. To understand the distinction between inline functions and normal functions, you need to peer more deeply into a program’s innards than we have so far. Let’s do that now.

The final product of the compilation process is an executable program, which consists of a set of machine language instructions. When you start a program, the operating system loads these instructions into the computer’s memory so that each instruction has a particular memory address. The computer then goes through these instructions step-by-step. Sometimes, as when you have a loop or a branching statement, program execution skips

over instructions, jumping backward or forward to a particular address. Normal function calls also involve having a program jump to another address (the function's address) and then jump back when the function terminates. Let's look at a typical implementation of that process in a little more detail. When a program reaches the function call instruction, the program stores the memory address of the instruction immediately following the function call, copies function arguments to the stack (a block of memory reserved for that purpose), jumps to the memory location that marks the beginning of the function, executes the function code (perhaps placing a return value in a register), and then jumps back to the instruction whose address it saved.<sup>1</sup> Jumping back and forth and keeping track of where to jump means that there is an overhead in elapsed time to using functions.

C++ inline functions provide an alternative. In an inline function, the compiled code is "in line" with the other code in the program. That is, the compiler replaces the function call with the corresponding function code. With inline code, the program doesn't have to jump to another location to execute the code and then jump back. Inline functions thus run a little faster than regular functions, but they come with a memory penalty. If a program calls an inline function at ten separate locations, then the program winds up with ten copies of the function inserted into the code (see Figure 8.1).

You should be selective about using inline functions. If the time needed to execute the function code is long compared to the time needed to handle the function call mechanism, then the time saved is a relatively small portion of the entire process. If the code execution time is short, then an inline call can save a large portion of the time used by the non-inline call. On the other hand, you are now saving a large portion of a relatively quick process, so the absolute time savings may not be that great unless the function is called frequently.

To use this feature, you must take at least one of two actions:

- Preface the function declaration with the keyword `inline`.
- Preface the function definition with the keyword `inline`.

A common practice is to omit the prototype and to place the entire definition (meaning the function header and all the function code) where the prototype would normally go.

The compiler does not have to honor your request to make a function inline. It might decide the function is too large or notice that it calls itself (recursion is not allowed or indeed possible for inline functions), or the feature might not be turned on or implemented for your particular compiler.

---

<sup>1</sup> It's a bit like having to leave off reading some text to find out what a footnote says and then, upon finishing the footnote, returning to where you were reading in the text.

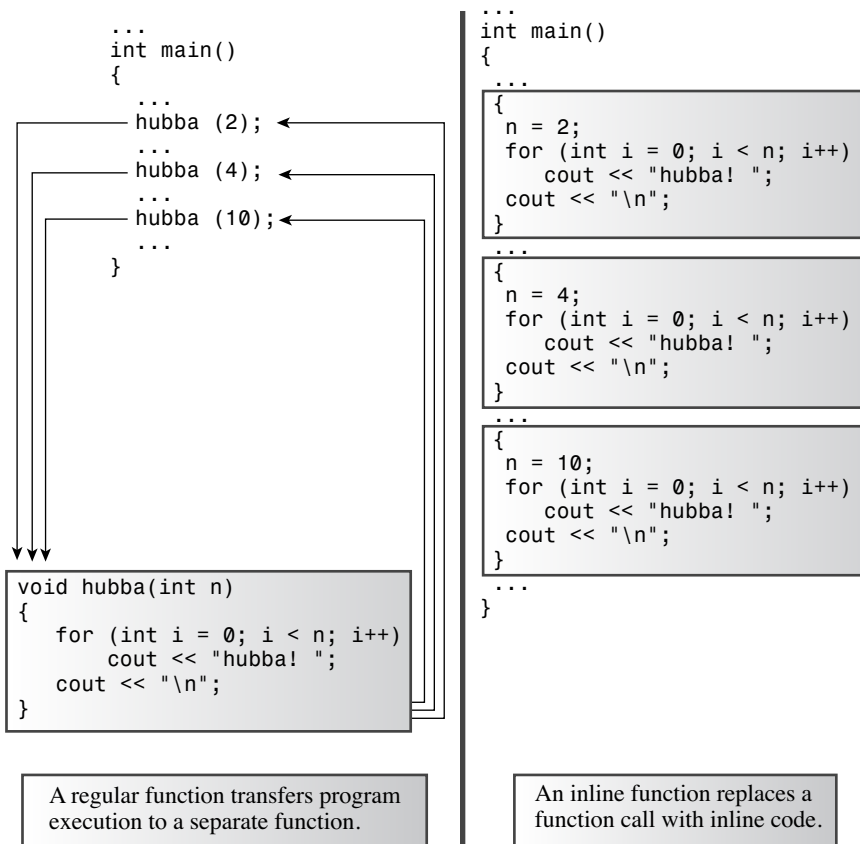

Figure 8.1 Inline functions versus regular functions.

Listing 8.1 illustrates the inline technique with an inline `square()` function that squares its argument. Note that the entire definition is on one line. That's not required, but if the definition doesn't fit on one or two lines (assuming you don't have lengthy identifiers), the function is probably a poor candidate for an inline function.

#### Listing 8.1 `inline.cpp`

```

// inline.cpp -- using an inline function
#include <iostream>

// an inline function definition
inline double square(double x) { return x * x; }

int main()
{

```

```

using namespace std;
double a, b;
double c = 13.0;

a = square(5.0);
b = square(4.5 + 7.5); // can pass expressions
cout << "a = " << a << ", b = " << b << "\n";
cout << "c = " << c;
cout << ", c squared = " << square(c++) << "\n";
cout << "Now c = " << c << "\n";
return 0;
}

```

Here's the output of the program in Listing 8.1:

```

a = 25, b = 144
c = 13, c squared = 169
Now c = 14

```

This output illustrates that inline functions pass arguments by value just like regular functions do. If the argument is an expression, such as  $4.5 + 7.5$ , the function passes the value of the expression—12 in this case. This makes C++'s inline facility far superior to C's macro definitions. See the "Inline Versus Macros" sidebar.

Even though the program doesn't provide a separate prototype, C++'s prototyping features are still in play. That's because the entire definition, which comes before the function's first use, serves as a prototype. This means you can use `square()` with an `int` argument or a `long` argument, and the program automatically type casts the value to type `double` before passing it to the function.

### Inline Versus Macros

The `inline` facility is an addition to C++. C uses the preprocessor `#define` statement to provide *macros*, which are crude implementations of inline code. For example, here's a macro for squaring a number:

```
#define SQUARE(X) X*X
```

This works not by passing arguments but through text substitution, with the `x` acting as a symbolic label for the "argument":

```

a = SQUARE(5.0); is replaced by a = 5.0*5.0;
b = SQUARE(4.5 + 7.5); is replaced by b = 4.5 + 7.5 * 4.5 + 7.5;
d = SQUARE(c++); is replaced by d = c++*c++;

```

Only the first example here works properly. You can improve matters with a liberal application of parentheses:

```
#define SQUARE(X) ((X)*(X))
```

Still, the problem remains that macros don't pass by value. Even with this new definition, `SQUARE(c++)` increments `c` twice, but the inline `square()` function in Listing 8.1 evaluates `c`, passes that value to be squared, and then increments `c` once.

The intent here is not to show you how to write C macros. Rather, it is to suggest that if you have been using C macros to perform function-like services, you should consider converting them to C++ inline functions.

## Reference Variables

C++ adds a new compound type to the language—the reference variable. A *reference* is a name that acts as an alias, or an alternative name, for a previously defined variable. For example, if you make `twain` a reference to the `clemens` variable, you can use `twain` and `clemens` interchangeably to represent that variable. Of what use is such an alias? Is it to help people who are embarrassed by their choice of variable names? Maybe, but the main use for a reference variable is as a formal argument to a function. If you use a reference as an argument, the function works with the original data instead of with a copy. References provide a convenient alternative to pointers for processing large structures with a function, and they are essential for designing classes. Before you see how to use references with functions, however, let's examine the basics of defining and using a reference. Keep in mind that the purpose of the following discussion is to illustrate how references work, not how they are typically used.

### Creating a Reference Variable

You might recall that C and C++ use the `&` symbol to indicate the address of a variable. C++ assigns an additional meaning to the `&` symbol and presses it into service for declaring references. For example, to make `rodents` an alternative name for the variable `rats`, you could do the following:

```
int rats;
int &rodents = rats;    // makes rodents an alias for rats
```

In this context, `&` is not the address operator. Instead, it serves as part of the type identifier. Just as `char *` in a declaration means pointer-to-char, `int &` means reference-to-int. The reference declaration allows you to use `rats` and `rodents` interchangeably; both refer to the same value and the same memory location. Listing 8.2 illustrates the truth of this claim.

#### Listing 8.2 `firstref.cpp`

```
// firstref.cpp -- defining and using a reference
#include <iostream>
int main()
{
    using namespace std;
    int rats = 101;
    int &rodents = rats;    // rodents is a reference
```

```

    cout << "rats = " << rats;
    cout << ", rodents = " << rodents << endl;
    rodents++;
    cout << "rats = " << rats;
    cout << ", rodents = " << rodents << endl;

// some implementations require type casting the following
// addresses to type unsigned
    cout << "rats address = " << &rats;
    cout << ", rodents address = " << &rodents << endl;
    return 0;
}

```

---

Note that the `&` operator in the following statement *is not* the address operator but declares that `rodents` is of type `int &` (that is, it is a reference to an `int` variable):

```
int &rodents = rats;
```

But the `&` operator in the next statement *is* the address operator, with `&rodents` representing the address of the variable to which `rodents` refers:

```
cout << ", rodents address = " << &rodents << endl;
```

Here is the output of the program in Listing 8.2:

```

rats = 101, rodents = 101
rats = 102, rodents = 102
rats address = 0x0065fd48, rodents address = 0x0065fd48

```

As you can see, both `rats` and `rodents` have the same value and the same address. (The address values and display format vary from system to system.) Incrementing `rodents` by one affects both variables. More precisely, the `rodents++` operation increments a single variable for which there are two names. (Again, keep in mind that although this example shows you how a reference works, it doesn't represent the typical use for a reference, which is as a function parameter, particularly for structure and object arguments. We'll look into these uses pretty soon.)

References tend to be a bit confusing at first to C veterans coming to C++ because they are tantalizingly reminiscent of pointers, yet somehow different. For example, you can create both a reference and a pointer to refer to `rats`:

```

int rats = 101;
int &rodents = rats; // rodents a reference
int *prats = &rats; // prats a pointer

```

Then you could use the expressions `rodents` and `*prats` interchangeably with `rats` and use the expressions `&rodents` and `prats` interchangeably with `&rats`. From this standpoint, a reference looks a lot like a pointer in disguised notation in which the `*` dereferencing operator is understood implicitly. And, in fact, that's more or less what a reference is. But there are differences besides those of notation. For one, it is necessary to

initialize the reference when you declare it; you can't declare the reference and then assign it a value later the way you can with a pointer:

```
int rat;
int & rodent;
rodent = rat; // No, you can't do this.
```

### Note

You should initialize a reference variable when you declare it.

A reference is rather like a `const` pointer; you have to initialize it when you create it, and when a reference pledges its allegiance to a particular variable, it sticks to its pledge. That is,

```
int & rodents = rats;
```

is, in essence, a disguised notation for something like this:

```
int * const pr = &rats;
```

Here, the reference `rodents` plays the same role as the expression `*pr`.

Listing 8.3 shows what happens if you try to make a reference change allegiance from a `rats` variable to a `bunnies` variable.

### Listing 8.3 `secref.cpp`

---

```
// secref.cpp -- defining and using a reference
#include <iostream>
int main()
{
    using namespace std;
    int rats = 101;
    int & rodents = rats; // rodents is a reference

    cout << "rats = " << rats;
    cout << ", rodents = " << rodents << endl;

    cout << "rats address = " << &rats;
    cout << ", rodents address = " << &rodents << endl;

    int bunnies = 50;
    rodents = bunnies; // can we change the reference?
    cout << "bunnies = " << bunnies;
    cout << ", rats = " << rats;
    cout << ", rodents = " << rodents << endl;

    cout << "bunnies address = " << &bunnies;
    cout << ", rodents address = " << &rodents << endl;
    return 0;
}
```

---



Here's the output of the program in Listing 8.3:

```
rats = 101, rodents = 101
rats address = 0x0065fd44, rodents address = 0x0065fd44
bunnies = 50, rats = 50, rodents = 50
bunnies address = 0x0065fd48, rodents address = 0x0065fd4
```

Initially, `rodents` refers to `rats`, but then the program apparently attempts to make `rodents` a reference to `bunnies`:

```
rodents = bunnies;
```

For a moment, it looks as if this attempt has succeeded because the value of `rodents` changes from 101 to 50. But closer inspection reveals that `rats` also has changed to 50 and that `rats` and `rodents` still share the same address, which differs from the `bunnies` address. Because `rodents` is an alias for `rats`, the assignment statement really means the same as the following:

```
rats = bunnies;
```

That is, it means “Assign the value of the `bunnies` variable to the `rat` variable.” In short, you can set a reference by an initializing declaration, not by assignment.

Suppose you tried the following:

```
int rats = 101;
int * pt = &rats;
int & rodents = *pt;
int bunnies = 50;
pt = &bunnies;
```

Initializing `rodents` to `*pt` makes `rodents` refer to `rats`. Subsequently altering `pt` to point to `bunnies` does not alter the fact that `rodents` refers to `rats`.

## References as Function Parameters

Most often, references are used as function parameters, making a variable name in a function an alias for a variable in the calling program. This method of passing arguments is called *passing by reference*. Passing by reference allows a called function to access variables in the calling function. C++'s addition of the feature is a break from C, which only passes by value. Passing by value, recall, results in the called function working with copies of values from the calling program (see Figure 8.2). Of course, C lets you get around the passing by value limitation by using pointers.

Let's compare using references and using pointers in a common computer problem: swapping the values of two variables. A swapping function has to be able to alter values of variables in the calling program. That means the usual approach of passing variables by value won't work because the function will end up swapping the contents of copies of the original variables instead of the variables themselves. If you pass references, however, the function can work with the original data. Alternatively, you can pass pointers in order to access the original data. Listing 8.4 shows all three methods, including the one that doesn't work, so that you can compare them.

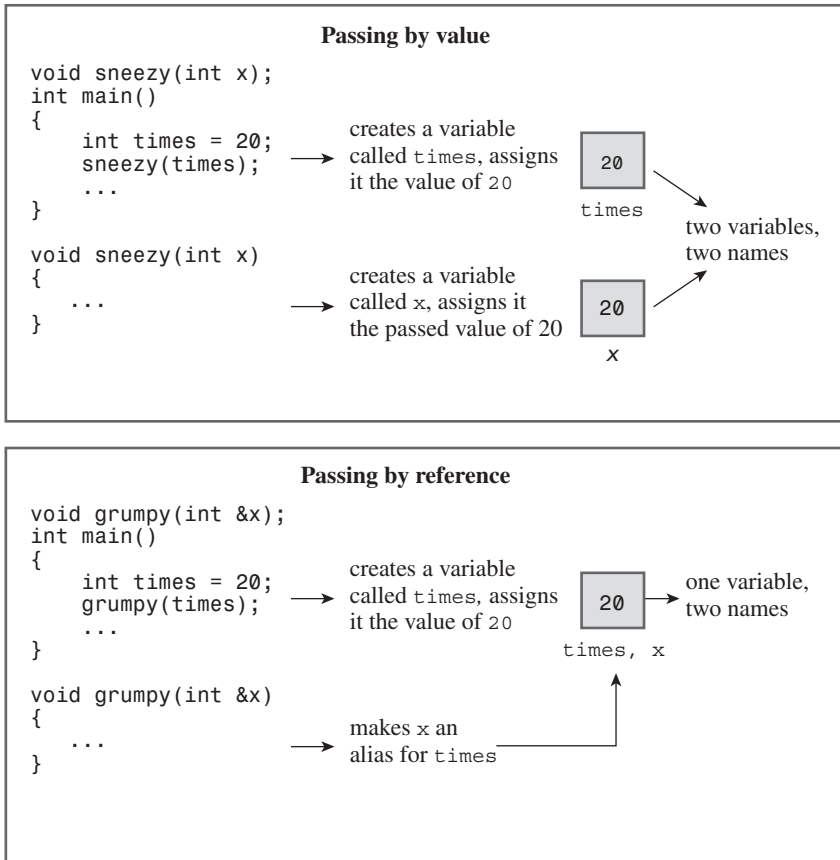

Figure 8.2 Passing by value and passing by reference.

Listing 8.4 **swaps.cpp**

```

// swaps.cpp -- swapping with references and with pointers
#include <iostream>
void swapr(int &a, int &b); // a, b are aliases for ints
void swapp(int *p, int *q); // p, q are addresses of ints
void swapv(int a, int b); // a, b are new variables
int main()
{
    using namespace std;
    int wallet1 = 300;
    int wallet2 = 350;
}

```

```
    cout << "wallet1 = $" << wallet1;
    cout << " wallet2 = $" << wallet2 << endl;

    cout << "Using references to swap contents:\n";
    swapr(wallet1, wallet2); // pass variables
    cout << "wallet1 = $" << wallet1;
    cout << " wallet2 = $" << wallet2 << endl;

    cout << "Using pointers to swap contents again:\n";
    swapp(&wallet1, &wallet2); // pass addresses of variables
    cout << "wallet1 = $" << wallet1;
    cout << " wallet2 = $" << wallet2 << endl;

    cout << "Trying to use passing by value:\n";
    swapv(wallet1, wallet2); // pass values of variables
    cout << "wallet1 = $" << wallet1;
    cout << " wallet2 = $" << wallet2 << endl;
    return 0;
}

void swapr(int & a, int & b) // use references
{
    int temp;

    temp = a; // use a, b for values of variables
    a = b;
    b = temp;
}

void swapp(int * p, int * q) // use pointers
{
    int temp;

    temp = *p; // use *p, *q for values of variables
    *p = *q;
    *q = temp;
}

void swapv(int a, int b) // try using values
{
    int temp;

    temp = a; // use a, b for values of variables
    a = b;
    b = temp;
}
```

---

Here's the output of the program in Listing 8.4:

```
wallet1 = $300 wallet2 = $350          << original values
Using references to swap contents:
wallet1 = $350 wallet2 = $300        << values swapped
Using pointers to swap contents again:
wallet1 = $300 wallet2 = $350        << values swapped again
Trying to use passing by value:
wallet1 = $300 wallet2 = $350        << swap failed
```

As you'd expect, the reference and pointer methods both successfully swap the contents of the two wallets, whereas the passing by value method fails.

## Program Notes

First, note how each function in Listing 8.4 is called:

```
swapr(wallet1, wallet2);           // pass variables
swapp(&wallet1, &wallet2);         // pass addresses of variables
swapv(wallet1, wallet2);           // pass values of variables
```

Passing by reference (`swapr(wallet1, wallet2)`) and passing by value (`swapv(wallet1, wallet2)`) look identical. The only way you can tell that `swapr()` passes by reference is by looking at the prototype or the function definition. However, the presence of the address operator (`&`) makes it obvious when a function passes by address (`swapp(&wallet1, &wallet2)`). (Recall that the type declaration `int *p` means that `p` is a pointer to an `int` and therefore the argument corresponding to `p` should be an address, such as `&wallet1`.)

Next, compare the code for the functions `swapr()` (passing by reference) and `swapv()` (passing by value). The only outward difference between the two is how the function parameters are declared:

```
void swapr(int &a, int &b)
void swapv(int a, int b)
```

The internal difference, of course, is that in `swapr()` the variables `a` and `b` serve as aliases for `wallet1` and `wallet2`, so swapping `a` and `b` swaps `wallet1` and `wallet2`. But in `swapv()`, the variables `a` and `b` are new variables that copy the values of `wallet1` and `wallet2`, so swapping `a` and `b` has no effect on `wallet1` and `wallet2`.

Finally, compare the functions `swapr()` (passing a reference) and `swapp()` (passing a pointer). The first difference is in how the function parameters are declared:

```
void swapr(int &a, int &b)
void swapp(int *p, int *q)
```

The second difference is that the pointer version requires using the `*` dereferencing operator throughout when the function uses `p` and `q`.

Earlier, I said you should initialize a reference variable when you define it. A function call initializes its parameters with argument values from the function call. So reference function arguments are initialized to the argument passed by the function call. That is, the

following function call initializes the formal parameter `a` to `wallet1` and the formal parameter `b` to `wallet2`:

```
swapr(wallet1, wallet2);
```

## Reference Properties and Oddities

Using reference arguments has several twists you need to know about. First, consider Listing 8.5. It uses two functions to cube an argument. One takes a type `double` argument, and the other takes a reference to `double`. The actual code for cubing is purposefully a bit odd to illustrate a point.

### Listing 8.5 `cubes.cpp`

---

```
// cubes.cpp -- regular and reference arguments
#include <iostream>
double cube(double a);
double refcube(double &ra);
int main ()
{
    using namespace std;
    double x = 3.0;

    cout << cube(x);
    cout << " = cube of " << x << endl;
    cout << refcube(x);
    cout << " = cube of " << x << endl;
    return 0;
}

double cube(double a)
{
    a *= a * a;
    return a;
}

double refcube(double &ra)
{
    ra *= ra * ra;
    return ra;
}
```

---

Here is the output of the program in Listing 8.5:

```
27 = cube of 3
27 = cube of 27
```

Note that the `refcube()` function modifies the value of `x` in `main()` and `cube()` doesn't, which reminds you why passing by value is the norm. The variable `a` is local to `cube()`. It is initialized to the value of `x`, but changing `a` has no effect on `x`. But because `refcube()` uses a reference argument, the changes it makes to `ra` are actually made to `x`. If your intent is that a function use the information passed to it without modifying the information, and if you're using a reference, you should use a constant reference. Here, for example, you should use `const` in the function prototype and function header:

```
double refcube(const double &ra);
```

If you do this, the compiler generates an error message when it finds code altering the value of `ra`.

Incidentally, if you need to write a function along the lines of this example (that is, using a basic numeric type), you should use passing by value rather than the more exotic passing by reference. Reference arguments become useful with larger data units, such as structures and classes, as you'll soon see.

Functions that pass by value, such as the `cube()` function in Listing 8.5, can use many kinds of actual arguments. For example, all the following calls are valid:

```
double z = cube(x + 2.0);    // evaluate x + 2.0, pass value
z = cube(8.0);             // pass the value 8.0
int k = 10;
z = cube(k);               // convert value of k to double, pass value
double yo[3] = { 2.2, 3.3, 4.4};
z = cube (yo[2]);         // pass the value 4.4
```

Suppose you try similar arguments for a function with a reference parameter. It would seem that passing a reference should be more restrictive. After all, if `ra` is the alternative name for a variable, then the actual argument should be that variable. Something like the following doesn't appear to make sense because the expression `x + 3.0` is not a variable:

```
double z = refcube(x + 3.0); // should not compile
```

For example, you can't assign a value to such an expression:

```
x + 3.0 = 5.0; // nonsensical
```

What happens if you try a function call like `refcube(x + 3.0)`? In contemporary C++, that's an error, and most compilers will tell you so. Some older ones give you a warning along the following lines:

```
Warning: Temporary used for parameter 'ra' in call to refcube(double &)
```

The reason for this milder response is that C++, in its early years, did allow you to pass expressions to a reference variable. In some cases, it still does. What happens is that because `x + 3.0` is not a type `double` variable, the program creates a temporary, nameless variable, initializing it to the value of the expression `x + 3.0`. Then `ra` becomes a reference to that temporary variable. Let's take a closer look at temporary variables and see when they are and are not created.

### Temporary Variables, Reference Arguments, and `const`

C++ can generate a temporary variable if the actual argument doesn't match a reference argument. Currently, C++ permits this only if the argument is a `const` reference, but this was not always the case. Let's look at the cases in which C++ does generate temporary variables and see why the restriction to a `const` reference makes sense.

First, when is a temporary variable created? Provided that the reference parameter is a `const`, the compiler generates a temporary variable in two kinds of situations:

- When the actual argument is the correct type but isn't an *lvalue*
- When the actual argument is of the wrong type, but it's of a type that can be converted to the correct type

What is an *lvalue*? An argument that's an *lvalue* is a data object that can be referenced by address. For example, a variable, an array element, a structure member, a reference, and a dereferenced pointer are *lvalues*. Non-*lvalues* include literal constants (aside from quoted strings, which are represented by their addresses) and expressions with multiple terms. The term *lvalue* in C originally meant entities that could appear on the left side of an assignment statement, but that was before the `const` keyword was introduced. Now both a regular variable and a `const` variable would be considered *lvalues* because both can be accessed by address. But the regular variable can be further characterized as being a *modifiable lvalue* and the `const` variable as a *non-modifiable lvalue*.

Now, to return to our example, suppose you redefine `refcube()` so that it has a constant reference argument:

```
double refcube(const double &ra)
{
    return ra * ra * ra;
}
```

Next, consider the following code:

```
double side = 3.0;
double * pd = &side;
double & rd = side;
long edge = 5L;
double lens[4] = { 2.0, 5.0, 10.0, 12.0};
double c1 = refcube(side);           // ra is side
double c2 = refcube(lens[2]);       // ra is lens[2]
double c3 = refcube(rd);            // ra is rd is side
double c4 = refcube(*pd);           // ra is *pd is side
double c5 = refcube(edge);          // ra is temporary variable
double c6 = refcube(7.0);           // ra is temporary variable
double c7 = refcube(side + 10.0);   // ra is temporary variable
```

The arguments `side`, `lens[2]`, `rd`, and `*pd` are type `double` data objects with names, so it is possible to generate a reference for them, and no temporary variables are needed. (Recall that an element of an array behaves like a variable of the same type as the

element.) But although `edge` is a variable, it is of the wrong type. A reference to a `double` can't refer to a `long`. The arguments `7.0` and `side + 10.0`, on the other hand, are the right type, but they are not named data objects. In each of these cases, the compiler generates a temporary, anonymous variable and makes `ra` refer to it. These temporary variables last for the duration of the function call, but then the compiler is free to dump them.

So why is this behavior okay for constant references but not otherwise? Recall the `swapr()` function from Listing 8.4:

```
void swapr(int &a, int &b) // use references
{
    int temp;

    temp = a;           // use a, b for values of variables
    a = b;
    b = temp;
}
```

What would happen if you did the following under the freer rules of early C++?

```
long a = 3, b = 5;
swapr(a, b);
```

Here there is a type mismatch, so the compiler would create two temporary `int` variables, initialize them to 3 and 5, and then swap the contents of the temporary variables, leaving `a` and `b` unaltered.

In short, if the intent of a function with reference arguments is to modify variables passed as arguments, situations that create temporary variables thwart that purpose. The solution is to prohibit creating temporary variables in these situations, and that is what the C++ Standard now does. (However, some compilers still, by default, issue warnings instead of error messages, so if you see a warning about temporary variables, don't ignore it.)

Now think about the `refcube()` function. Its intent is merely to use passed values, not to modify them, so temporary variables cause no harm and make the function more general in the sorts of arguments it can handle. Therefore, if the declaration states that a reference is `const`, C++ generates temporary variables when necessary. In essence, a C++ function with a `const` reference formal argument and a nonmatching actual argument mimics the traditional passing by value behavior, guaranteeing that the original data is unaltered and using a temporary variable to hold the value.

### Note

If a function call argument isn't an lvalue or does not match the type of the corresponding `const` reference parameter, C++ creates an anonymous variable of the correct type, assigns the value of the function call argument to the anonymous variable, and has the parameter refer to that variable.



### Use `const` When You Can

There are three strong reasons to declare reference arguments as references to constant data:

- Using `const` protects you against programming errors that inadvertently alter data.
- Using `const` allows a function to process both `const` and non-`const` actual arguments, whereas a function that omits `const` in the prototype only can accept non-`const` data.
- Using a `const` reference allows the function to generate and use a temporary variable appropriately.

You should declare formal reference arguments as `const` whenever it's appropriate to do so.

C++11 introduces a second kind of reference, called an *rvalue reference*, that can refer to an rvalue. It's declared using `&&`:

```
double && rref = std::sqrt(36.00); // not allowed for double &
double j = 15.0;
double && jref = 2.0* j + 18.5; // not allowed for double &
std::cout << rref << '\n'; // display 6.0
std::cout << jref << '\n'; // display 48.5;
```

The rvalue reference was introduced mainly to help library designers provide more efficient implementations of certain operations. Chapter 18, “Visiting will the New C++ Standard,” discusses how rvalue references are used to implement an approach called move semantics. The original reference type (the one declared using a single `&`) is now called an lvalue reference.

### Using References with a Structure

References work wonderfully with structures and classes, C++’s user-defined types. Indeed, references were introduced primarily for use with these types, not for use with the basic built-in types.

The method for using a reference to a structure as a function parameter is the same as the method for using a reference to a basic variable: You just use the `&` reference operator when declaring a structure parameter. For example, suppose we have the following definition of a structure:

```
struct free_throws
{
    std::string name;
    int made;
    int attempts;
    float percent;
};
```

Then a function using a reference to this type could be prototyped as follows:

```
void set_pc(free_throws & ft); // use a reference to a structure
```

If the intent is that the function doesn't alter the structure, use `const`:

```
void display(const free_throws & ft); // don't allow changes to structure
```

The program in Listing 8.6 does exactly these things. It also adds an interesting twist by having a function return a reference to the structure. This works a bit differently from returning a structure. There are some cautions to note, which we'll get to shortly.

#### Listing 8.6 `strc_ref.cpp`

---

```
//strc_ref.cpp -- using structure references
#include <iostream>
#include <string>
struct free_throws
{
    std::string name;
    int made;
    int attempts;
    float percent;
};

void display(const free_throws & ft);
void set_pc(free_throws & ft);
free_throws & accumulate(free_throws & target, const free_throws & source);

int main()
{
    // partial initializations - remaining members set to 0
    free_throws one = {"Ifelsa Branch", 13, 14};
    free_throws two = {"Andor Knott", 10, 16};
    free_throws three = {"Minnie Max", 7, 9};
    free_throws four = {"Whily Looper", 5, 9};
    free_throws five = {"Long Long", 6, 14};
    free_throws team = {"Throwgoods", 0, 0};
    // no initialization
    free_throws dup;

    set_pc(one);
    display(one);
    accumulate(team, one);
    display(team);
    // use return value as argument
    display(accumulate(team, two));
    accumulate(accumulate(team, three), four);
    display(team);
    // use return value in assignment
    dup = accumulate(team, five);
    std::cout << "Displaying team:\n";
    display(team);
    std::cout << "Displaying dup after assignment:\n";
    display(dup);
}
```

```

    set_pc(four);
// ill-advised assignment
accumulate(dup, five) = four;
std::cout << "Displaying dup after ill-advised assignment:\n";
display(dup);
return 0;
}

void display(const free_throws & ft)
{
    using std::cout;
    cout << "Name: " << ft.name << '\n';
    cout << "  Made: " << ft.made << '\t';
    cout << "Attempts: " << ft.attempts << '\t';
    cout << "Percent: " << ft.percent << '\n';
}

void set_pc(free_throws & ft)
{
    if (ft.attempts != 0)
        ft.percent = 100.0f *float(ft.made)/float(ft.attempts);
    else
        ft.percent = 0;
}

free_throws & accumulate(free_throws & target, const free_throws & source)
{
    target.attempts += source.attempts;
    target.made += source.made;
    set_pc(target);
    return target;
}

```

---

Here is the program output:

```

Name: Ifelsa Branch
  Made: 13      Attempts: 14      Percent: 92.8571
Name: Throwgoods
  Made: 13      Attempts: 14      Percent: 92.8571
Name: Throwgoods
  Made: 23      Attempts: 30      Percent: 76.6667
Name: Throwgoods
  Made: 35      Attempts: 48      Percent: 72.9167
Displaying team:
Name: Throwgoods
  Made: 41      Attempts: 62      Percent: 66.129
Displaying dup after assignment:
Name: Throwgoods

```

```

Made: 41      Attempts: 62      Percent: 66.129
Displaying dup after ill-advised assignment:
Name: Whily Looper
Made: 5      Attempts: 9      Percent: 55.5556

```

## Program Notes

The program begins by initializing several structure objects. Recall that if there are fewer initializers than members, the remaining members (just the `percent` members in this case) are set to 0. The first function call is this:

```
set_pc(one);
```

Because the formal parameter `ft` in `set_pc()` is a reference, `ft` refers to `one`, and the code in `set_pc()` sets the `one.percent` member. Passing by value would not work in this case because that would result in setting the `percent` member of a temporary copy of `one`. The alternative, as you may recall from the previous chapter, is using a pointer parameter and passing an address, but the form is slightly more complicated:

```

set_pcp(&one);    // using pointers instead - &one instead of one
...
void set_pcp(free_throws * pt)
{
    if (pt->attempts != 0)
        pt->percent = 100.0f *float(pt->made)/float(pt->attempts);
    else
        pt->percent = 0;
}

```

The next function call is this:

```
display(one);
```

Because `display()` displays the contents of the structure without altering them, the function uses a `const` reference parameter. In this case, one could have passed the structure by value, but using a reference is more economical in time and memory than making a copy of the original structure.

The next function call is this:

```
accumulate(team, one);
```

The `accumulate()` function takes two structure arguments. It adds data from the `attempts` and `made` members of the second structure to the corresponding members of the first structure. Only the first structure is modified, so the first parameter is a reference, whereas the second parameter is a `const` reference:

```
free_throws & accumulate(free_throws & target, const free_throws & source);
```

What about the return value? The function call we just discussed didn't use it; as far as that use went, the function could have been type `void`. But look at this function call:

```
display(accumulate(team, two));
```

What's going on here? Let's follow the structure object `team`. First, `team` is passed to `accumulate()` as its first argument. That means that the `target` object in `accumulate()` really is `team`. The `accumulate()` function modifies `team`, then returns it as a reference. Note that the actual return statement looks like this:

```
return target;
```

Nothing in this statement indicates that a reference is being returned. That information comes from the function header (and, also, from the prototype):

```
free_throws & accumulate(free_throws & target, const free_throws & source)
```

If the return type were declared `free_throws` instead of `free_throws &`, the same return statement would return a copy of `target` (and hence a copy of `team`). But the return type is a reference, so that means the return value is the original `team` object first passed to `accumulate()`.

What happens next? The `accumulate()` return value is the first argument to `display()`, so that means `team` is the first argument to `display()`. Because the `display()` parameter is a reference, that means the `ft` object in `display()` really is `team`. Therefore, the contents of `team` get displayed. The net effect of

```
display(accumulate(team, two));
```

is the same as that of the following:

```
accumulate(team, two);
display(team);
```

The same logic applies to this statement:

```
accumulate(accumulate(team, three), four);
```

This has the same effect as the following:

```
accumulate(team, three);
accumulate(team, four);
```

Next, the program uses an assignment statement:

```
dup = accumulate(team, five);
```

As you might expect, this copies the values in `team` to `dup`.

Finally, the program uses `accumulate()` in a manner for which it was not intended:

```
accumulate(dup, five) = four;
```

This statement—that is, assigning a value to a function call—works because the return value is a reference. The code won't compile if `accumulate()` returns by value. Because the return value is a reference to `dup`, this code has the same effect as the following:

```
accumulate(dup, five); // add five's data to dup
dup = four;           // overwrite the contents of dup with the contents of four
```

The second statement wipes out the work accomplished by the first, so the original assignment statement was not a good use of `accumulate()`.

### Why Return a Reference?

Let's look a bit further at how returning a reference is different from the traditional return mechanism. The latter works much like passing by value does with function parameters. The expression following the return is evaluated, and that value is passed back to the calling function. Conceptually, this value is copied to a temporary location and the calling program uses the value. Consider the following:

```
double m = sqrt(16.0);
cout << sqrt(25.0);
```

In the first statement, the value `4.0` is copied to a temporary location and then the value in that location is copied to `m`. In the second statement, the value `5.0` is copied to a temporary location, then the contents of that location are passed on to `cout`. (This is the conceptual description. In practice, an optimizing compiler might consolidate some of the steps.)

Now consider this statement:

```
dup = accumulate(team, five);
```

If `accumulate()` returned a structure instead of a reference to a structure, this could involve copying the entire structure to a temporary location and then copying that copy to `dup`. But with a reference return value, `team` is copied directly to `dup`, a more efficient approach.

#### Note

A function that returns a reference is actually an alias for the referred-to variable.

### Being Careful About What a Return Reference Refers To

The single most important point to remember when returning a reference is to avoid returning a reference to a memory location that ceases to exist when the function terminates. What you want to avoid is code along these lines:

```
const free_throws & clone2(free_throws & ft)
{
    free_throws newguy; // first step to big error
    newguy = ft;        // copy info
    return newguy;     // return reference to copy
}
```

This has the unfortunate effect of returning a reference to a temporary variable (`newguy`) that passes from existence as soon as the function terminates. (Chapter 9, "Memory Models and Namespaces," discusses the persistence of various kinds of variables.) Similarly, you should avoid returning pointers to such temporary variables.

The simplest way to avoid this problem is to return a reference that was passed as an argument to the function. A reference parameter will refer to data used by the calling function; hence, the returned reference will refer to that same data. This, for example, is what `accumulate()` does in Listing 8.6.

A second method is to use `new` to create new storage. You've already seen examples in which `new` creates space for a string and the function returns a pointer to that space. Here's how you could do something similar with a reference:

```
const free_throws & clone(free_throws & ft)
{
    free_throws * pt;
    *pt = ft;           // copy info
    return *pt;       // return reference to copy
}
```

The first statement creates a nameless `free_throws` structure. The pointer `pt` points to the structure, so `*pt` is the structure. The code appears to return the structure, but the function declaration indicates that the function really returns a reference to this structure. You could then use the function this way:

```
free_throws & jolly = clone(three);
```

This makes `jolly` a reference to the new structure. There is a problem with this approach: You should use `delete` to free memory allocated by `new` when the memory is no longer needed. A call to `clone()` conceals the call to `new`, making it simpler to forget to use `delete` later. The `auto_ptr` template or, better, the C++11 `unique_ptr` discussed in Chapter 16, “The `string` Class and the Standard Template Library,” can help automate the deletion process.

### Why Use `const` with a Reference Return?

Listing 8.6, as you'll recall, had this statement:

```
accumulate(dup, five) = four;
```

It had the effect of first adding data from `five` to `dup`, then overwriting the contents of `dup` with the contents of `four`. Why does this statement compile? Assignment requires a modifiable lvalue on the left. That is, the subexpression on the left of an assignment expression should identify a block of memory that can be modified. In this case, the function returned a reference to `dup`, which does identify such a block of memory. So the statement is valid.

Regular (non reference) return types, on the other hand, are *rvalues*, values that can't be accessed by address. Such expressions can appear on the right side of an assignment statement but not the left. Other examples of rvalues include literals, such as `10.0`, and expressions such as `x + y`. Clearly, it doesn't make sense to try to take the address of a literal such as `10.0`, but why is a normal function return value an rvalue? It's because the return value, you'll recall, resides in a temporary memory location that doesn't necessarily persist even until the next statement.

Suppose you want to use a reference return value but don't want to permit behavior such as assigning a value to `accumulate()`. Just make the return type a `const` reference:

```
const free_throws &
    accumulate(free_throws & target, const free_throws & source);
```

The return type now is `const`, hence a nonmodifiable lvalue. Therefore, the assignment no longer is allowed:

```
accumulate(dup, five) = four; // not allowed for const reference return
```

What about the other function calls in the program? With a `const` reference return type, the following statement would still be allowed:

```
display(accumulate(team, two));
```

That's because the formal parameter for `display()` also is type `const free_throws &`. But the following statement would not be allowed because the first formal parameter for `accumulate()` is not `const`:

```
accumulate(accumulate(team, three), four);
```

Is this a great loss? Not in this case because you still can do the following:

```
accumulate(team, three);
accumulate(team, four);
```

And of course you still could use `accumulate()` on the right side of an assignment statement.

By omitting `const`, you can write shorter but more obscure-looking code.

Usually, you're better off avoiding the addition of obscure features to a design because obscure features often expand the opportunities for obscure errors. Making the return type a `const` reference therefore protects you from the temptation of obfuscation. Occasionally, however, omitting `const` does make sense. The overloaded `<<` operator discussed in Chapter 11, "Working with Classes," is an example.

## Using References with a Class Object

The usual C++ practice for passing class objects to a function is to use references. For instance, you would use reference parameters for functions taking objects of the `string`, `ostream`, `istream`, `ofstream`, and `ifstream` classes as arguments.

Let's look at an example that uses the `string` class and illustrates some different design choices, some of them bad. The general idea is to create a function that adds a given string to each end of another string. Listing 8.7 provides three functions that are intended to do this. However, one of the designs is so flawed that it may cause the program to crash or even not compile.



Listing 8.7 `strquote.cpp`

---

```

// strquote.cpp -- different designs
#include <iostream>
#include <string>
using namespace std;
string version1(const string & s1, const string & s2);
const string & version2(string & s1, const string & s2); // has side effect
const string & version3(string & s1, const string & s2); // bad design

int main()
{
    string input;
    string copy;
    string result;

    cout << "Enter a string: ";
    getline(cin, input);
    copy = input;
    cout << "Your string as entered: " << input << endl;
    result = version1(input, "***");
    cout << "Your string enhanced: " << result << endl;
    cout << "Your original string: " << input << endl;

    result = version2(input, "###");
    cout << "Your string enhanced: " << result << endl;
    cout << "Your original string: " << input << endl;

    cout << "Resetting original string.\n";
    input = copy;
    result = version3(input, "@@@");
    cout << "Your string enhanced: " << result << endl;
    cout << "Your original string: " << input << endl;

    return 0;
}

string version1(const string & s1, const string & s2)
{
    string temp;

    temp = s2 + s1 + s2;
    return temp;
}

const string & version2(string & s1, const string & s2) // has side effect
{

```

```

    s1 = s2 + s1 + s2;
// safe to return reference passed to function
    return s1;
}

const string & version3(string & s1, const string & s2) // bad design
{
    string temp;

    temp = s2 + s1 + s2;
// unsafe to return reference to local variable
    return temp;
}

```

---

Here is a sample run of the program in Listing 8.7:

```

Enter a string: It's not my fault.
Your string as entered: It's not my fault.
Your string enhanced: ***It's not my fault.***
Your original string: It's not my fault.
Your string enhanced: ###It's not my fault.###
Your original string: ###It's not my fault.###
Resetting original string.

```

At this point the program crashed.

## Program Notes

Version 1 of the function in Listing 8.7 is the most straightforward of the three:

```

string version1(const string & s1, const string & s2)
{
    string temp;

    temp = s2 + s1 + s2;
    return temp;
}

```

It takes two `string` arguments and uses `string` class addition to create a new `string` that has the desired properties. Note that the two function arguments are `const` references. The function would produce the same end result if it just passed `string` objects:

```

string version4(string s1, string s2) // would work the same

```

In this case, `s1` and `s2` would be brand-new `string` objects. Thus, using references is more efficient because the function doesn't have to create new objects and copy data from the old objects to the new. The use of the `const` qualifier indicates that this function will use, but not modify, the original strings.

The `temp` object is a new object, local to the `version1()` function, and it ceases to exist when the function terminates. Thus, returning `temp` as a reference won't work, so the

function type is `string`. This means the contents of `temp` will be copied to a temporary return location. Then, in `main()`, the contents of the return location are copied to the string named `result`:

```
result = version1(input, "****");
```

### Passing a C-Style String Argument to a `string` Object Reference Parameter

You may have noticed a rather interesting fact about the `version1()` function: Both formal parameters (`s1` and `s2`) are type `const string &`, but the actual arguments (`input` and `"****"`) are type `string` and `const char *`, respectively. Because `input` is type `string`, there is no problem having `s1` refer to it. But how is it that the program accepts passing a pointer-to-char argument to a `string` reference?

Two things are going on here. One is that the `string` class defines a `char *`-to-`string` conversion, which makes it possible to initialize a `string` object to a C-style string. The second is a property of `const` reference formal parameters that is discussed earlier in this chapter. Suppose the actual argument type doesn't match the reference parameter type but can be converted to the reference type. Then the program creates a temporary variable of the correct type, initializes it to the converted value, and passes a reference to the temporary variable. Earlier this chapter you saw, for instance, that a `const double &` parameter can handle an `int` argument in this fashion. Similarly, a `const string &` parameter can handle a `char *` or `const char *` argument in this fashion.

The convenient outcome of this is that if the formal parameter is type `const string &`, the actual argument used in the function call can be a `string` object or a C-style string, such as a quoted string literal, a null-terminated array of `char`, or a pointer variable that points to a `char`. Hence the following works fine:

```
result = version1(input, "****");
```

The `version2()` function doesn't create a temporary string. Instead, it directly alters the original string:

```
const string & version2(string & s1, const string & s2) // has side effect
{
    s1 = s2 + s1 + s2;
// safe to return reference passed to function
    return s1;
}
```

This function is allowed to alter `s1` because `s1`, unlike `s2`, is not declared using `const`.

Because `s1` is a reference to an object (`input`) in `main()`, it's safe to return `s1` as a reference. Because `s1` is a reference to `input`, the line

```
result = version2(input, "###");
```

essentially becomes equivalent to the following:

```
version2(input, "###"); // input altered directly by version2()
result = input;         // reference to s1 is reference to input
```

However, because `s1` is a reference to `input`, calling this function has the side effect of altering `input` also:

```
Your original string: It's not my fault.
Your string enhanced: ###It's not my fault.###
Your original string: ###It's not my fault.###
```

Thus, if you want to keep the original string unaltered, this is the wrong design.

The third version in Listing 8.7 is a reminder of what not to do:

```
const string & version3(string & s1, const string & s2) // bad design
{
    string temp;

    temp = s2 + s1 + s2;
// unsafe to return reference to local variable
    return temp;
}
```

It has the fatal flaw of returning a reference to a variable declared locally inside `version3()`. This function compiles (with a warning), but the program crashes when attempting to execute the function. Specifically, the following assignment aspect causes the problem:

```
result = version3(input, "###");
```

The program attempts to refer to memory that is no longer in use.

## Another Object Lesson: Objects, Inheritance, and References

The `ostream` and `ofstream` classes bring an interesting property of references to the fore. As you may recall from Chapter 6, “Branching Statements and Logical Operators,” objects of the `ofstream` type can use `ostream` methods, allowing file input/output to use the same forms as console input/output. The language feature that makes it possible to pass features from one class to another is called *inheritance*, and Chapter 13, “Class Inheritance,” discusses this feature in detail. In brief, `ostream` is termed a base class (because the `ofstream` class is based on it) and `ofstream` is termed a *derived class* (because it is derived from `ostream`). A derived class inherits the base class methods, which means that an `ofstream` object can use base class features such as the `precision()` and `setf()` formatting methods.

Another aspect of inheritance is that a base class reference can refer to a derived class object without requiring a type cast. The practical upshot of this is that you can define a function having a base class reference parameter, and that function can be used with base class objects and also with derived objects. For example, a function with a type `ostream &` parameter can accept an `ostream` object, such as `cout`, or an `ofstream` object, such as you might declare, equally well.

Listing 8.8 demonstrates this point by using the same function to write data to a file and to display the data onscreen; only the function call argument is changed. This program

solicits the focal length of a telescope objective (its main mirror or lens) and of some eyepieces. Then it calculates and displays the magnification each eyepiece would produce in that telescope. The magnification equals the focal length of the telescope divided by the focal length of the eyepiece used, so the calculation is simple. The program also uses some formatting methods, which, as promised, work equally well with `cout` and with `ofstream` objects (`fout`, in this example).

#### Listing 8.8 `filefunc.cpp`

---

```
//filefunc.cpp -- function with ostream & parameter
#include <iostream>
#include <fstream>
#include <cstdlib>
using namespace std;

void file_it(ostream & os, double fo, const double fe[],int n);
const int LIMIT = 5;
int main()
{
    ofstream fout;
    const char * fn = "ep-data.txt";
    fout.open(fn);
    if (!fout.is_open())
    {
        cout << "Can't open " << fn << ". Bye.\n";
        exit(EXIT_FAILURE);
    }
    double objective;
    cout << "Enter the focal length of your "
         << "telescope objective in mm: ";
    cin >> objective;
    double eps[LIMIT];
    cout << "Enter the focal lengths, in mm, of " << LIMIT
         << " eyepieces:\n";
    for (int i = 0; i < LIMIT; i++)
    {
        cout << "Eyepiece #" << i + 1 << ": ";
        cin >> eps[i];
    }
    file_it(fout, objective, eps, LIMIT);
    file_it(cout, objective, eps, LIMIT);
    cout << "Done\n";
    return 0;
}
```

```

void file_it(ostream & os, double fo, const double fe[],int n)
{
    ios_base::fmtflags initial;
    initial = os.setf(ios_base::fixed); // save initial formatting state
    os.precision(0);
    os << "Focal length of objective: " << fo << " mm\n";
    os.setf(ios::showpoint);
    os.precision(1);
    os.width(12);
    os << "f.l. eyepiece";
    os.width(15);
    os << "magnification" << endl;
    for (int i = 0; i < n; i++)
    {
        os.width(12);
        os << fe[i];
        os.width(15);
        os << int (fo/fe[i] + 0.5) << endl;
    }
    os.setf(initial); // restore initial formatting state
}

```

---

Here is a sample run of the program in Listing 8.8:

```

Enter the focal length of your telescope objective in mm: 1800
Enter the focal lengths, in mm, of 5 eyepieces:
Eyepiece #1: 30
Eyepiece #2: 19
Eyepiece #3: 14
Eyepiece #4: 8.8
Eyepiece #5: 7.5
Focal length of objective: 1800 mm
f.l. eyepiece  magnification
      30.0          60
      19.0          95
      14.0         129
       8.8         205
       7.5         240
Done

```

The following line writes the eyepiece data to the file `ep-data.txt`:

```
file_it(fout, objective, eps, LIMIT);
```

And this line writes the identical information in the identical format to the screen:

```
file_it(cout, objective, eps, LIMIT);
```

## Program Notes

The main point of Listing 8.8 is that the `os` parameter, which is type `ostream &`, can refer to an `ostream` object such as `cout` and to an `ofstream` object such as `fout`. But the program also illustrates how `ostream` formatting methods can be used for both types. Let's review, or, in some cases, examine for the first time, some of these methods. (Chapter 17, "Input, Output, and Files," provides a fuller discussion.)

The `setf()` method allows you to set various formatting states. For example, the method call `setf(ios_base::fixed)` places an object in the mode of using fixed decimal-point notation. The call `setf(ios_base::showpoint)` places an object in the mode of showing a trailing decimal point, even if the following digits are zeros. The `precision()` method indicates the number of figures to be shown to the right of the decimal (provided that the object is in `fixed` mode). All these settings stay in place unless they're reset by another method call. The `width()` call sets the field width to be used for the next output action. This setting holds for displaying one value only, and then it reverts to the default. (The default is a field width of zero, which is then expanded to just fit the actual quantity being displayed.)

The `file_it()` function uses an interesting pair of method calls:

```
ios_base::fmtflags initial;
initial = os.setf(ios_base::fixed); // save initial formatting state
...
os.setf(initial); // restore initial formatting state
```

The `setf()` method returns a copy of all the formatting settings in effect before the call was made. `ios_base::fmtflags` is a fancy name for the type needed to store this information. So the assignment to `initial` stores the settings that were in place before the `file_it()` function was called. The `initial` variable can then be used as an argument to `setf()` to reset all the formatting settings to this original value. Thus, the function restores the object to the state it had before being passed to `file_it()`.

Knowing more about classes will help you understand better how these methods work and, why, for example, `ios_base` keeps popping up. But you don't have to wait until Chapter 17 to use these methods.

One final point: Each object stores its own formatting settings. So when the program passes `cout` to `file_it()`, `cout`'s settings are altered and then restored. When the program passes `fout` to `file_it()`, `fout`'s settings are altered and then restored.

## When to Use Reference Arguments

There are two main reasons for using reference arguments:

- To allow you to alter a data object in the calling function
- To speed up a program by passing a reference instead of an entire data object

The second reason is most important for larger data objects, such as structures and class objects. These two reasons are the same reasons you might have for using a pointer argument. This makes sense because reference arguments are really just a different interface for

pointer-based code. So when should you use a reference? Use a pointer? Pass by value? The following are some guidelines.

A function uses passed data without modifying it:

- If the data object is small, such as a built-in data type or a small structure, pass it by value.
- If the data object is an array, use a pointer because that's your only choice. Make the pointer a pointer to `const`.
- If the data object is a good-sized structure, use a `const` pointer or a `const` reference to increase program efficiency. You save the time and space needed to copy a structure or a class design. Make the pointer or reference `const`.
- If the data object is a class object, use a `const` reference. The semantics of class design often require using a reference, which is the main reason C++ added this feature. Thus, the standard way to pass class object arguments is by reference.

A function modifies data in the calling function:

- If the data object is a built-in data type, use a pointer. If you spot code like `fixit(&x)`, where `x` is an `int`, it's pretty clear that this function intends to modify `x`.
- If the data object is an array, use your only choice: a pointer.
- If the data object is a structure, use a reference or a pointer.
- If the data object is a class object, use a reference.

Of course, these are just guidelines, and there might be reasons for making different choices. For example, `cin` uses references for basic types so that you can use `cin >> n` instead of `cin >> &n`.

## Default Arguments

Let's look at another topic from C++'s bag of new tricks: the default argument. A *default argument* is a value that's used automatically if you omit the corresponding actual argument from a function call. For example, if you set up `void wow(int n)` so that `n` has a default value of `1`, the function call `wow()` is the same as `wow(1)`. This gives you flexibility in how you use a function. Suppose you have a function called `left()` that returns the first `n` characters of a string, with the string and `n` as arguments. More precisely, the function returns a pointer to a new string consisting of the selected portion of the original string. For example, the call `left("theory", 3)` constructs a new string "the" and returns a pointer to it. Now suppose you establish a default value of `1` for the second argument. The call `left("theory", 3)` would work as before, with your choice of `3` overriding the default. But the call `left("theory")`, instead of being an error, would assume a second argument of `1` and return a pointer to the string "t". This kind of default is helpful if your program often needs to extract a one-character string but occasionally needs to extract longer strings.



How do you establish a default value? You must use the function prototype. Because the compiler looks at the prototype to see how many arguments a function uses, the function prototype also has to alert the program to the possibility of default arguments. The method is to assign a value to the argument in the prototype. For example, here's the prototype fitting this description of `left()`:

```
char * left(const char * str, int n = 1);
```

You want the function to return a new string, so its type is `char*`, or pointer-to-`char`. You want to leave the original string unaltered, so you use the `const` qualifier for the first argument. You want `n` to have a default value of 1, so you assign that value to `n`. A default argument value is an initialization value. Thus, the preceding prototype initializes `n` to the value 1. If you leave `n` alone, it has the value 1, but if you pass an argument, the new value overwrites the 1.

When you use a function with an argument list, you must add defaults from right to left. That is, you can't provide a default value for a particular argument unless you also provide defaults for all the arguments to its right:

```
int harpo(int n, int m = 4, int j = 5);           // VALID
int chico(int n, int m = 6, int j);           // INVALID
int groucho(int k = 1, int m = 2, int n = 3);  // VALID
```

For example, the `harpo()` prototype permits calls with one, two, or three arguments:

```
beeps = harpo(2);           // same as harpo(2,4,5)
beeps = harpo(1,8);        // same as harpo(1,8,5)
beeps = harpo (8,7,6);     // no default arguments used
```

The actual arguments are assigned to the corresponding formal arguments from left to right; you can't skip over arguments. Thus, the following isn't allowed:

```
beeps = harpo(3, ,8);      // invalid, doesn't set m to 4
```

Default arguments aren't a major programming breakthrough; rather, they are a convenience. When you begin working with class design, you'll find that they can reduce the number of constructors, methods, and method overloads you have to define.

Listing 8.9 puts default arguments to use. Note that only the prototype indicates the default. The function definition is the same as it would be without default arguments.

#### Listing 8.9 `left.cpp`

---

```
// left.cpp -- string function with a default argument
#include <iostream>
const int ArSize = 80;
char * left(const char * str, int n = 1);
int main()
{
    using namespace std;
    char sample[ArSize];
    cout << "Enter a string:\n";
```

```
cin.get(sample, ArSize);
char *ps = left(sample, 4);
cout << ps << endl;
delete [] ps; // free old string
ps = left(sample);
cout << ps << endl;
delete [] ps; // free new string
return 0;
}

// This function returns a pointer to a new string
// consisting of the first n characters in the str string.
char * left(const char * str, int n)
{
    if(n < 0)
        n = 0;
    char * p = new char[n+1];
    int i;
    for (i = 0; i < n && str[i]; i++)
        p[i] = str[i]; // copy characters
    while (i <= n)
        p[i++] = '\0'; // set rest of string to '\0'
    return p;
}
```

---

Here's a sample run of the program in Listing 8.9:

```
Enter a string:
forthcoming
fort
f
```

## Program Notes

The program in Listing 8.9 uses `new` to create a new string for holding the selected characters. One awkward possibility is that an uncooperative user may request a negative number of characters. In that case, the function sets the character count to 0 and eventually returns the null string. Another awkward possibility is that an irresponsible user may request more characters than the string contains. The function protects against this by using a combined test:

```
i < n && str[i]
```

The `i < n` test stops the loop after `n` characters have been copied. The second part of the test, the expression `str[i]`, is the code for the character about to be copied. If the loop reaches the null character, the code is 0, and the loop terminates. The final `while`

loop terminates the string with the null character and then sets the rest of the allocated space, if any, to null characters.

Another approach for setting the size of the new string is to set `n` to the smaller of the passed value and the string length:

```
int len = strlen(str);
n = (n < len) ? n : len;    // the lesser of n and len
char * p = new char[n+1];
```

This ensures that `new` doesn't allocate more space than what's needed to hold the string. That can be useful if you make a call such as `left("Hi!", 32767)`. The first approach copies the "Hi!" into an array of 32767 characters, setting all but the first 3 characters to the null character. The second approach copies "Hi!" into an array of 4 characters. But by adding another function call (`strlen()`), it increases the program size, slows the process, and requires that you remember to include the `cstring` (or `string.h`) header file. C programmers have tended to opt for faster running, more compact code and leave a greater burden on the programmer to use functions correctly. However, the C++ tradition places greater weight on reliability. After all, a slower program that works correctly is better than a fast program that works incorrectly. If the time taken to call `strlen()` turns out to be a problem, you can let `left()` determine the lesser of `n` and the string length directly. For example, the following loop quits when `m` reaches `n` or the end of the string, whichever comes first:

```
int m = 0;
while (m <= n && str[m] != '\0')
    m++;
char * p = new char[m+1];
// use m instead of n in rest of code
```

Remember, the expression `str[m] != '\0'` evaluates to `true` when `str[m]` is not the null character and to `false` when it is the null character. Because nonzero values are converted to `true` in an `&&` expression and zero is converted to `false`, the `while` test also can be written this way:

```
while (m<=n && str[m])
```

## Function Overloading

Function polymorphism is a neat C++ addition to C's capabilities. Whereas default arguments let you call the same function by using varying numbers of arguments, *function polymorphism*, also called *function overloading*, lets you use multiple functions sharing the same name. The word *polymorphism* means having many forms, so *function polymorphism* lets a function have many forms. Similarly, the expression *function overloading* means you can attach more than one function to the same name, thus overloading the name. Both expressions boil down to the same thing, but we'll usually use the expression *function overloading*—it sounds harder working. You can use function overloading to design a family of functions that do essentially the same thing but using different argument lists.

Overloaded functions are analogous to verbs having more than one meaning. For example, Miss Piggy can root at the ball park for the home team, and she can root in soil for truffles. The context (one hopes) tells you which meaning of *root* is intended in each case. Similarly, C++ uses the context to decide which version of an overloaded function is intended.

The key to function overloading is a function's argument list, also called the *function signature*. If two functions use the same number and types of arguments in the same order, they have the same signature; the variable names don't matter. C++ enables you to define two functions by the same name, provided that the functions have different signatures. The signature can differ in the number of arguments or in the type of arguments, or both. For example, you can define a set of `print()` functions with the following prototypes:

```
void print(const char * str, int width); // #1
void print(double d, int width);       // #2
void print(long l, int width);         // #3
void print(int i, int width);          // #4
void print(const char *str);           // #5
```

When you then use a `print()` function, the compiler matches your use to the prototype that has the same signature:

```
print("Pancakes", 15);                // use #1
print("Syrup");                        // use #5
print(1999.0, 10);                     // use #2
print(1999, 12);                        // use #4
print(1999L, 15);                       // use #3
```

For example, `print("Pancakes", 15)` uses a string and an integer as arguments, and it matches Prototype #1.

When you use overloaded functions, you need to be sure you use the proper argument types in the function call. For example, consider the following statements:

```
unsigned int year = 3210;
print(year, 6); // ambiguous call
```

Which prototype does the `print()` call match here? It doesn't match any of them! A lack of a matching prototype doesn't automatically rule out using one of the functions because C++ will try to use standard type conversions to force a match. If, say, the *only* `print()` prototype were #2, the function call `print(year, 6)` would convert the `year` value to type `double`. But in the earlier code there are three prototypes that take a number as the first argument, providing three different choices for converting `year`. Faced with this ambiguous situation, C++ rejects the function call as an error.

Some signatures that appear to be different from each other nonetheless can't coexist. For example, consider these two prototypes:

```
double cube(double x);
double cube(double & x);
```

You might think this is a place you could use function overloading because the function signatures appear to be different. But consider things from the compiler's standpoint. Suppose you have code like this:

```
cout << cube(x);
```

The `x` argument matches both the `double x` prototype and the `double &x` prototype. The compiler has no way of knowing which function to use. Therefore, to avoid such confusion, when it checks function signatures, the compiler considers a reference to a type and the type itself to be the same signature.

The function-matching process does discriminate between `const` and non-`const` variables. Consider the following prototypes:

```
void dribble(char * bits);           // overloaded
void dribble (const char *cbits);   // overloaded
void dabble(char * bits);           // not overloaded
void driv1(const char * bits);      // not overloaded
```

Here's what various function calls would match:

```
const char p1[20] = "How's the weather?";
char p2[20] = "How's business?";
dribble(p1);           // dribble(const char *);
dribble(p2);           // dribble(char *);
dabble(p1);           // no match
dabble(p2);           // dabble(char *);
driv1(p1);            // driv1(const char *);
driv1(p2);            // driv1(const char *);
```

The `dribble()` function has two prototypes—one for `const` pointers and one for regular pointers—and the compiler selects one or the other, depending on whether the actual argument is `const`. The `dabble()` function only matches a call with a non-`const` argument, but the `driv1()` function matches calls with either `const` or non-`const` arguments. The reason for this difference in behavior between `driv1()` and `dabble()` is that it's valid to assign a non-`const` value to a `const` variable, but not vice versa.

Keep in mind that the signature, not the function type, enables function overloading. For example, the following two declarations are incompatible:

```
long gronk(int n, float m);        // same signatures,
double gronk(int n, float m);     // hence not allowed
```

Therefore, C++ doesn't permit you to overload `gronk()` in this fashion. You can have different return types, but only if the signatures are also different:

```
long gronk(int n, float m);        // different signatures,
double gronk(float n, float m);    // hence allowed
```

After we discuss templates later in this chapter, we'll further discuss function matching.

## Overloading Reference Parameters

Class designs and the STL often use reference parameters, and it's useful to know how overloading works with different reference types. Consider the following three prototypes:

```
void sink(double & r1);           // matches modifiable lvalue
void sank(const double & r2);    // matches modifiable or const lvalue, rvalue
void sunk(double && r3);         // matches rvalue
```

The lvalue reference parameter `r1` matches a modifiable lvalue argument, such as a `double` variable. The `const` lvalue reference parameter `r2` matches a modifiable lvalue argument, a `const` lvalue argument, and an rvalue argument, such as the sum of two `double` values. Finally, the rvalue reference `r3` matches an rvalue. Note how `r2` can match the same sort of arguments that `r1` and `r3` match. This raises the question of what happens when you overload a function on these three types of parameters. The answer is that the more exact match is made:

```
void staff(double & rs);         // matches modifiable lvalue
void staff(const double & rcs); // matches rvalue, const lvalue
void stove(double & r1);        // matches modifiable lvalue
void stove(const double & r2);  // matches const lvalue
void stove(double && r3);       // matches rvalue
```

This allows you to customize the behavior of a function based on the lvalue, `const`, or rvalue nature of the argument:

```
double x = 55.5;
const double y = 32.0;
stove(x);           // calls stove(double &)
stove(y);          // calls stove(const double &)
stove(x+y);        // calls stove(double &&)
```

If, say, you omit the `stove(double &&)` function, then `stove(x+y)` will call the `stove(const double &)` function instead.

## An Overloading Example

In this chapter we've already developed a `left()` function that returns a pointer to the first `n` characters in a string. Let's add a second `left()` function, one that returns the first `n` digits in an integer. You can use it, for example, to examine the first three digits of a U.S. postal zip code stored as an integer, which is useful if you want to sort for urban areas.

The integer function is a bit more difficult to program than the string version because you don't have the benefit of each digit being stored in its own array element. One approach is to first compute the number of digits in the number. Dividing a number by 10 lops off one digit, so you can use division to count digits. More precisely, you can do so with a loop, like this:

```
unsigned digits = 1;
while (n /= 10)
    digits++;
```

This loop counts how many times you can remove a digit from  $n$  until none are left. Recall that  $n /= 10$  is short for  $n = n / 10$ . If  $n$  is 8, for example, the test condition assigns to  $n$  the value  $8 / 10$ , or 0, because it's integer division. That terminates the loop, and `digits` remains at 1. But if  $n$  is 238, the first loop test sets  $n$  to  $238 / 10$ , or 23. That's nonzero, so the loop increases `digits` to 2. The next cycle sets  $n$  to  $23 / 10$ , or 2. Again, that's nonzero, so `digits` grows to 3. The next cycle sets  $n$  to  $2 / 10$ , or 0, and the loop quits, leaving `digits` set to the correct value, 3.

Now suppose you know that the number has five digits, and you want to return the first three digits. You can get that value by dividing the number by 10 and then dividing the answer by 10 again. Each division by 10 lops one more digit off the right end. To calculate the number of digits to lop, you just subtract the number of digits to be shown from the total number of digits. For example, to show four digits of a nine-digit number, you lop off the last five digits. You can code this approach as follows:

```
ct = digits - ct;
while (ct--)
    num /= 10;
return num;
```

Listing 8.10 incorporates this code into a new `left()` function. The function includes some additional code to handle special cases, such as asking for zero digits or asking for more digits than the number possesses. Because the signature of the new `left()` differs from that of the old `left()`, you can use both functions in the same program.

#### Listing 8.10 `leftover.cpp`

---

```
// leftover.cpp -- overloading the left() function
#include <iostream>
unsigned long left(unsigned long num, unsigned ct);
char * left(const char * str, int n = 1);

int main()
{
    using namespace std;
    char * trip = "Hawaii!!"; // test value
    unsigned long n = 12345678; // test value
    int i;
    char * temp;

    for (i = 1; i < 10; i++)
    {
        cout << left(n, i) << endl;
        temp = left(trip, i);
        cout << temp << endl;
        delete [] temp; // point to temporary storage
    }
    return 0;
```

```
}

// This function returns the first ct digits of the number num.
unsigned long left(unsigned long num, unsigned ct)
{
    unsigned digits = 1;
    unsigned long n = num;

    if (ct == 0 || num == 0)
        return 0;        // return 0 if no digits
    while (n /= 10)
        digits++;
    if (digits > ct)
    {
        ct = digits - ct;
        while (ct--)
            num /= 10;
        return num;      // return left ct digits
    }
    else                // if ct >= number of digits
        return num;     // return the whole number
}

// This function returns a pointer to a new string
// consisting of the first n characters in the str string.
char * left(const char * str, int n)
{
    if(n < 0)
        n = 0;
    char * p = new char[n+1];
    int i;
    for (i = 0; i < n && str[i]; i++)
        p[i] = str[i]; // copy characters
    while (i <= n)
        p[i++] = '\0'; // set rest of string to '\0'
    return p;
}
```

---

Here's the output of the program in Listing 8.10:

```
1
H
12
Ha
123
Haw
1234
```



```
Hawa
12345
Hawai
123456
Hawaii
1234567
Hawaii!
12345678
Hawaii!!
12345678
Hawaii!!!
```

## When to Use Function Overloading

You might find function overloading fascinating, but you shouldn't overuse it. You should reserve function overloading for functions that perform basically the same task but with different forms of data. Also you might want to check whether you can accomplish the same end by using default arguments. For example, you could replace the single, string-oriented `left()` function with two overloaded functions:

```
char * left(const char * str, unsigned n); // two arguments
char * left(const char * str);           // one argument
```

But using the single function with a default argument is simpler. There's just one function to write instead of two, and the program requires memory for just one function instead of two. If you decide to modify the function, you have to edit only one. However, if you require different types of arguments, default arguments are of no avail, so in that case, you should use function overloading.

### What Is Name Decoration?

How does C++ keep track of which overloaded function is which? It assigns a secret identity to each of these functions. When you use the editor of your C++ development tool to write and compile programs, your C++ compiler performs a bit of magic on your behalf—known as *name decoration* or *name mangling*—through which each function name is encrypted, based on the formal parameter types specified in the function's prototype. Consider the following undecorated function prototype:

```
long MyFunctionFoo(int, float);
```

This format is fine for us humans; we know that the function accepts two arguments of type `int` and `float`, and it returns a value of type `long`. For its own use, the compiler documents this interface by transforming the name into an internal representation with a more unsightly appearance, perhaps something like this:

```
?MyFunctionFoo@@YAXH
```

The apparent gibberish decorating the original name (or mangling it, depending on your attitude) encodes the number and types of parameters. A different function signature would result in a different set of symbols being added, and different compilers would use different conventions for their efforts at decorating.

## Function Templates

Contemporary C++ compilers implement one of the newer C++ additions: function templates. A *function template* is a generic function description; that is, it defines a function in terms of a generic type for which a specific type, such as `int` or `double`, can be substituted. By passing a type as a parameter to a template, you cause the compiler to generate a function for that particular type. Because templates let you program in terms of a generic type instead of a specific type, the process is sometimes termed *generic programming*. Because types are represented by parameters, the template feature is sometimes referred to as *parameterized types*. Let's see why such a feature is useful and how it works.

Earlier Listing 8.4 defined a function that swapped two `int` values. Suppose you want to swap two `double` values instead. One approach is to duplicate the original code but replace each `int` with `double`. If you need to swap two `char` values, you can use the same technique again. Still, it's wasteful of your valuable time to have to make these petty changes, and there's always the possibility of making an error. If you make the changes by hand, you might overlook an `int`. If you do a global search-and-replace to substitute, say, `double` for `int`, you might do something such as converting

```
int x;  
short interval;
```

to the following:

```
double x;           // intended change of type  
short doubleerval; // unintended change of variable name
```

C++'s function template capability automates the process, saving you time and providing greater reliability.

Function templates enable you to define a function in terms of some arbitrary type. For example, you can set up a swapping template like this:

```
template <typename AnyType>  
void Swap(AnyType &a, AnyType &b)  
{  
    AnyType temp;  
    temp = a;  
    a = b;  
    b = temp;  
}
```

The first line specifies that you are setting up a template and that you're naming the arbitrary type `AnyType`. The keywords `template` and `typename` are obligatory, except that you can use the keyword `class` instead of `typename`. Also you must use the angle brackets. The type name (`AnyType`, in this example) is your choice, as long as you follow the usual C++ naming rules; many programmers use simple names such as `T`, which, one must admit, is simple indeed. The rest of the code describes the algorithm for swapping two values of type `AnyType`. The template does not create any functions. Instead, it provides the compiler with directions about how to define a function. If you want a function to swap

ints, then the compiler creates a function following the template pattern, substituting `int` for `AnyType`. Similarly, if you need a function to swap `doubles`, the compiler follows the template, substituting the `double` type for `AnyType`.

Before the C++98 Standard added the keyword `typename` to the language, C++ used the keyword `class` in this particular context. That is, you can write the template definition this way:

```
template <class AnyType>
void Swap(AnyType &a, AnyType &b)
{
    AnyType temp;
    temp = a;
    a = b;
    b = temp;
}
```

The `typename` keyword makes it a bit more obvious that the parameter `AnyType` represents a type; however, large libraries of code have already been developed by using the older keyword `class`. The C++ Standard treats the two keywords identically when they are used in this context. This book uses both forms so that you will be familiar with them when encountering them elsewhere.

### Tip

You should use templates if you need functions that apply the same algorithm to a variety of types. If you aren't concerned with backward compatibility and can put up with the effort of typing a longer word, you can use the keyword `typename` rather than `class` when you declare type parameters.

To let the compiler know that you need a particular form of swap function, you just use a function called `Swap()` in your program. The compiler checks the argument types you use and then generates the corresponding function. Listing 8.11 shows how this works. The program layout follows the usual pattern for ordinary functions, with a template function prototype near the top of the file and the template function definition following `main()`. The example follows the more usual practice of using `T` instead of `AnyType` as the type parameter.

#### Listing 8.11 funtemp.cpp

---

```
// funtemp.cpp -- using a function template
#include <iostream>
// function template prototype
template <typename T> // or class T
void Swap(T &a, T &b);

int main()
{
    using namespace std;
```

```

int i = 10;
int j = 20;
cout << "i, j = " << i << ", " << j << ".\n";
cout << "Using compiler-generated int swapper:\n";
Swap(i,j); // generates void Swap(int &, int &)
cout << "Now i, j = " << i << ", " << j << ".\n";

double x = 24.5;
double y = 81.7;
cout << "x, y = " << x << ", " << y << ".\n";
cout << "Using compiler-generated double swapper:\n";
Swap(x,y); // generates void Swap(double &, double &)
cout << "Now x, y = " << x << ", " << y << ".\n";
// cin.get();
return 0;
}

// function template definition
template <typename T> // or class T
void Swap(T &a, T &b)
{
    T temp; // temp a variable of type T
    temp = a;
    a = b;
    b = temp;
}

```

---

The first `Swap()` function in Listing 8.11 has two `int` arguments, so the compiler generates an `int` version of the function. That is, it replaces each use of `T` with `int`, producing a definition that looks like this:

```

void Swap(int &a, int &b)
{
    int temp;
    temp = a;
    a = b;
    b = temp;
}

```

You don't see this code, but the compiler generates and then uses it in the program. The second `Swap()` function has two `double` arguments, so the compiler generates a `double` version. That is, it replaces `T` with `double`, generating this code:

```

void Swap(double &a, double &b)
{
    double temp;
    temp = a;
}

```

```

    a = b;
    b = temp;
}

```

Here's the output of the program in Listing 8.11, which shows that the process has worked:

```

i, j = 10, 20.
Using compiler-generated int swapper:
Now i, j = 20, 10.
x, y = 24.5, 81.7.
Using compiler-generated double swapper:
Now x, y = 81.7, 24.5.

```

Note that function templates don't make executable programs any shorter. In Listing 8.11, you still wind up with two separate function definitions, just as you would if you defined each function manually. And the final code doesn't contain any templates; it just contains the actual functions generated for the program. The benefits of templates are that they make generating multiple function definitions simpler and more reliable.

More typically, templates are placed in a header file that is then included in the file using them. Chapter 9 discusses header files.

## Overloaded Templates

You use templates when you need functions that apply the same algorithm to a variety of types, as in Listing 8.11. It might be, however, that not all types would use the same algorithm. To handle this possibility, you can overload template definitions, just as you overload regular function definitions. As with ordinary overloading, overloaded templates need distinct function signatures. For example, Listing 8.12 adds a new swapping template—one for swapping elements of two arrays. The original template has the signature `(T &, T &)`, whereas the new template has the signature `(T [], T [], int)`. Note that the final parameter in this case happens to be a specific type (`int`) rather than a generic type. Not all template arguments have to be template parameter types.

When, in `twotemps.cpp`, the compiler encounters the first use of `Swap()`, it notices that it has two `int` arguments and matches `Swap()` to the original template. The second use, however, has two `int` arrays and an `int` value as arguments, and this matches the new template.

### Listing 8.12 `twotemps.cpp`

---

```

// twotemps.cpp -- using overloaded template functions
#include <iostream>
template <typename T>      // original template
void Swap(T &a, T &b);

template <typename T>      // new template
void Swap(T *a, T *b, int n);

```

```
void Show(int a[]);
const int Lim = 8;
int main()
{
    using namespace std;
    int i = 10, j = 20;
    cout << "i, j = " << i << ", " << j << ".\n";
    cout << "Using compiler-generated int swapper:\n";
    Swap(i,j);           // matches original template
    cout << "Now i, j = " << i << ", " << j << ".\n";

    int d1[Lim] = {0,7,0,4,1,7,7,6};
    int d2[Lim] = {0,7,2,0,1,9,6,9};
    cout << "Original arrays:\n";
    Show(d1);
    Show(d2);
    Swap(d1,d2,Lim);    // matches new template
    cout << "Swapped arrays:\n";
    Show(d1);
    Show(d2);
    // cin.get();
    return 0;
}

template <typename T>
void Swap(T &a, T &b)
{
    T temp;
    temp = a;
    a = b;
    b = temp;
}

template <typename T>
void Swap(T a[], T b[], int n)
{
    T temp;
    for (int i = 0; i < n; i++)
    {
        temp = a[i];
        a[i] = b[i];
        b[i] = temp;
    }
}

void Show(int a[])
{
```

```

using namespace std;
cout << a[0] << a[1] << "/";
cout << a[2] << a[3] << "/";
for (int i = 4; i < Lim; i++)
    cout << a[i];
cout << endl;
}

```

---

Here is the output of the program in Listing 8.12:

```

i, j = 10, 20.
Using compiler-generated int swapper:
Now i, j = 20, 10.
Original arrays:
07/04/1776
07/20/1969
Swapped arrays:
07/20/1969
07/04/1776

```

## Template Limitations

Suppose you have a template function:

```

template <class T>      // or template <typename T>
void f(T a, T b)
{...}

```

Often the code makes assumptions about what operations are possible for the type. For instance, the following statement assumes that assignment is defined, and this would not be true if type `T` is a built-in array type:

```
a = b;
```

Similarly, the following assumes `>` is defined, which is not true if `T` is an ordinary structure:

```
if (a > b)
```

Also the `>` operator is defined for array names, but because array names are addresses, it compares the addresses of the arrays, which may not be what you have in mind. And the following assumes the multiplication operator is defined for type `T`, which is not the case if `T` is an array, a pointer, or a structure:

```
T c = a*b;
```

In short, it's easy to write a template function that cannot handle certain types. On the other hand, sometimes a generalization makes sense, even if ordinary C++ syntax doesn't allow for it. For example, it could make sense to add structures containing position coordinates, even though the `+` operator isn't defined for structures. One approach is that C++

allows one to overload the `+` operator so that it can be used with a particular form of structure or class. Chapter 11 discusses this facility. A template that requires using the `+` operator then could handle a structure that had an overloaded `+` operator. Another approach is to provide specialized template definitions for particular types. Let's look at that next.

## Explicit Specializations

Suppose you define a structure like the following:

```
struct job
{
    char name[40];
    double salary;
    int floor;
};
```

Also suppose you want to be able to swap the contents of two such structures. The original template uses the following code to effect a swap:

```
temp = a;
a = b;
b = temp;
```

Because C++ allows you to assign one structure to another, this works fine, even if type `T` is a `job` structure. But suppose you only want to swap the `salary` and `floor` members, keeping the `name` members unchanged. This requires different code, but the arguments to `Swap()` would be the same as for the first case (references to two `job` structures), so you can't use template overloading to supply the alternative code.

However, you can supply a specialized function definition, called an *explicit specialization*, with the required code. If the compiler finds a specialized definition that exactly matches a function call, it uses that definition without looking for templates.

The specialization mechanism has changed with the evolution of C++. We'll look at the current form as mandated by the C++ Standard.

### Third-Generation Specialization (ISO/ANSI C++ Standard)

After some youthful experimentation with other approaches, the C++98 Standard settled on this approach:

- For a given function name, you can have a non template function, a template function, and an explicit specialization template function, along with overloaded versions of all of these.
- The prototype and definition for an explicit specialization should be preceded by `template <>` and should mention the specialized type by name.
- A specialization overrides the regular template, and a non template function overrides both.



Here's how prototypes for swapping type `job` structures would look for these three forms:

```
// non template function prototype
void Swap(job &, job &);

// template prototype
template <typename T>
void Swap(T &, T &);

// explicit specialization for the job type
template <> void Swap<job>(job &, job &);
```

As mentioned previously, if more than one of these prototypes is present, the compiler chooses the non template version over explicit specializations and template versions, and it chooses an explicit specialization over a version generated from a template. For example, in the following code, the first call to `Swap()` uses the general template, and the second call uses the explicit specialization, based on the `job` type:

```
...
template <class T>           // template
void Swap(T &, T &);

// explicit specialization for the job type
template <> void Swap<job>(job &, job &);
int main()
{
    double u, v;
    ...
    Swap(u,v); // use template
    job a, b;
    ...
    Swap(a,b); // use void Swap<job>(job &, job &)
}
```

The `<job>` in `Swap<job>` is optional because the function argument types indicate that this is a specialization for `job`. Thus, the prototype can also be written this way:

```
template <> void Swap(job &, job &); // simpler form
```

In case you have to work with an older compiler, we'll come back to pre-C++ Standard usage soon, but first, let's see how explicit specializations are supposed to work.

### An Example of Explicit Specialization

Listing 8.13 illustrates how explicit specialization works.

Listing 8.13 twoswap.cpp

---

```
// twoswap.cpp -- specialization overrides a template
#include <iostream>
template <typename T>
void Swap(T &a, T &b);

struct job
{
    char name[40];
    double salary;
    int floor;
};

// explicit specialization
template <> void Swap<job>(job &j1, job &j2);
void Show(job &j);

int main()
{
    using namespace std;
    cout.precision(2);
    cout.setf(ios::fixed, ios::floatfield);
    int i = 10, j = 20;
    cout << "i, j = " << i << ", " << j << ".\n";
    cout << "Using compiler-generated int swapper:\n";
    Swap(i,j);    // generates void Swap(int &, int &)
    cout << "Now i, j = " << i << ", " << j << ".\n";

    job sue = {"Susan Yaffee", 73000.60, 7};
    job sidney = {"Sidney Taffee", 78060.72, 9};
    cout << "Before job swapping:\n";
    Show(sue);
    Show(sidney);
    Swap(sue, sidney); // uses void Swap(job &, job &)
    cout << "After job swapping:\n";
    Show(sue);
    Show(sidney);
    // cin.get();
    return 0;
}

template <typename T>
void Swap(T &a, T &b)    // general version
{
    T temp;
    temp = a;
```

```

    a = b;
    b = temp;
}

// swaps just the salary and floor fields of a job structure

template <> void Swap<job>(job &j1, job &j2) // specialization
{
    double t1;
    int t2;
    t1 = j1.salary;
    j1.salary = j2.salary;
    j2.salary = t1;
    t2 = j1.floor;
    j1.floor = j2.floor;
    j2.floor = t2;
}

void Show(job &j)
{
    using namespace std;
    cout << j.name << ": $" << j.salary
         << " on floor " << j.floor << endl;
}

```

---

Here's the output of the program in Listing 8.13:

```

i, j = 10, 20.
Using compiler-generated int swapper:
Now i, j = 20, 10.
Before job swapping:
Susan Yaffee: $73000.60 on floor 7
Sidney Taffee: $78060.72 on floor 9
After job swapping:
Susan Yaffee: $78060.72 on floor 9
Sidney Taffee: $73000.60 on floor 7

```

## Instantiations and Specializations

To extend your understanding of templates, let's investigate the terms *instantiation* and *specialization*. Keep in mind that including a function template in your code does not in itself generate a function definition. It's merely a plan for generating a function definition.

When the compiler uses the template to generate a function definition for a particular type, the result is termed an *instantiation* of the template. For example, in Listing 8.13, the function call `Swap(i, j)` causes the compiler to generate an instantiation of `Swap()`, using `int` as the type. The template *is not* a function definition, but the specific instantiation

using `int` is a function definition. This type of instantiation is termed *implicit instantiation* because the compiler deduces the necessity for making the definition by noting that the program uses a `Swap()` function with `int` parameters.

Originally, using implicit instantiation was the only way the compiler generated function definitions from templates, but now C++ allows for *explicit instantiation*. That means you can instruct the compiler to create a particular instantiation—for example, `Swap<int>()`—directly. The syntax is to declare the particular variety you want, using the `<>` notation to indicate the type and prefixing the declaration with the keyword `template`:

```
template void Swap<int>(int, int); // explicit instantiation
```

A compiler that implements this feature will, upon seeing this declaration, use the `Swap()` template to generate an instantiation, using the `int` type. That is, this declaration means “Use the `Swap()` template to generate a function definition for the `int` type.” Contrast the explicit instantiation with the explicit specialization, which uses one or the other of these equivalent declarations:

```
template <> void Swap<int>(int &, int &); // explicit specialization
template <> void Swap(int &, int &);      // explicit specialization
```

The difference is that these last two declarations mean “Don’t use the `Swap()` template to generate a function definition. Instead, use a separate, specialized function definition explicitly defined for the `int` type.” These prototypes have to be coupled with their own function definitions. The explicit specialization declaration has `<>` after the keyword `template`, whereas the explicit instantiation omits the `<>`.

### Caution

It is an error to try to use both an explicit instantiation and an explicit specialization for the same type(s) in the same file, or, more generally, the same translation unit.

Explicit instantiations also can be created by using the function in a program. For instance, consider the following:

```
template <class T>
T Add(T a, T b)    // pass by value
{
    return a + b;
}
...
int m = 6;
double x = 10.2;
cout << Add<double>(x, m) << endl; // explicit instantiation
```

The template would fail to match the function call `Add(x, m)` because the template expects both function arguments to be of the same type. But using `Add<double>(x, m)` forces the type `double` instantiation, and the argument `m` is type cast to type `double` to match the second parameter of the `Add<double>(double, double)` function.

What if you do something similar with `Swap()`?

```
int m = 5;
double x = 14.3;
Swap<double>(m, x); // almost works
```

This generates an explicit instantiation for type `double`. Unfortunately, in this case, the code won't work because the first formal parameter, being type `double &`, can't refer to the type `int` variable `m`.

Implicit instantiations, explicit instantiations, and explicit specializations collectively are termed *specializations*. What they all have in common is that they represent a function definition that uses specific types rather than one that is a generic description.

The addition of the explicit instantiation led to the new syntax of using `template` and `template <>` prefixes in declarations to distinguish between the explicit instantiation and the explicit specialization. As in many other cases, the cost of doing more is more syntax rules. The following fragment summarizes these concepts:

```
...
template <class T>
void Swap (T &, T &); // template prototype

template <> void Swap<job>(job &, job &); // explicit specialization for job
int main(void)
{
    template void Swap<char>(char &, char &); // explicit instantiation for char
    short a, b;
    ...
    Swap(a,b); // implicit template instantiation for short
    job n, m;
    ...
    Swap(n, m); // use explicit specialization for job
    char g, h;
    ...
    Swap(g, h); // use explicit template instantiation for char
    ...
}
```

When the compiler reaches the explicit instantiation for `char`, it uses the template definition to generate a `char` version of `Swap()`. For the remaining uses of `Swap()`, the compiler matches a template to the actual arguments used in the function call. For example, when the compiler reaches the function call `Swap(a,b)`, it generates a `short` version of `Swap()` because the two arguments are type `short`. When the compiler reaches `Swap(n,m)`, it uses the separate definition (the explicit specialization) provided for the `job` type. When the compiler reaches `Swap(g,h)`, it uses the template specialization it already generated when it processed the explicit instantiation.

## Which Function Version Does the Compiler Pick?

What with function overloading, function templates, and function template overloading, C++ needs, and has, a well-defined strategy for deciding which function definition to use for a function call, particularly when there are multiple arguments. The process is called *overload resolution*. Detailing the complete strategy would take a small chapter, so let's take just a broad look at how the process works:

- **Phase 1**—Assemble a list of candidate functions. These are functions and template functions that have the same names as the called functions.
- **Phase 2**—From the candidate functions, assemble a list of viable functions. These are functions with the correct number of arguments and for which there is an implicit conversion sequence, which includes the case of an exact match for each type of actual argument to the type of the corresponding formal argument. For example, a function call with a type `float` argument could have that value converted to a `double` to match a type `double` formal parameter, and a template could generate an instantiation for `float`.
- **Phase 3**—Determine whether there is a best viable function. If so, you use that function. Otherwise, the function call is an error.

Consider a case with just one function argument—for example, the following call:

```
may('B'); // actual argument is type char
```

First, the compiler rounds up the suspects, which are functions and function templates that have the name `may()`. Then, it finds those that can be called with one argument. For example, the following pass muster because they have the same name and can be used with one argument:

```
void may(int); // #1
float may(float, float = 3); // #2
void may(char); // #3
char * may(const char *); // #4
char may(const char &); // #5
template<class T> void may(const T &); // #6
template<class T> void may(T *); // #7
```

Note that just the signatures and not the return types are considered. Two of these candidates (#4 and #7), however, are not viable because an integral type cannot be converted implicitly (that is, without an explicit type cast) to a pointer type. The remaining template is viable because it can be used to generate a specialization, with `T` taken as type `char`. That leaves five viable functions, each of which could be used if it were the only function declared.

Next, the compiler has to determine which of the viable functions is best. It looks at the conversion required to make the function call argument match the viable candidate's argument. In general, the ranking from best to worst is this:

1. Exact match, with regular functions outranking templates
2. Conversion by promotion (for example, the automatic conversions of `char` and `short` to `int` and of `float` to `double`)
3. Conversion by standard conversion (for example, converting `int` to `char` or `long` to `double`)
4. User-defined conversions, such as those defined in class declarations

For example, Function #1 is better than Function #2 because `char-to-int` is a promotion (refer to Chapter 3, “Dealing with Data”), whereas `char-to-float` is a standard conversion (refer to Chapter 3). Functions #3, #5, and #6 are better than either #1 or #2 because they are exact matches. Both #3 and #5 are better than #6 because #6 is a template. This analysis raises a couple questions. What is an exact match? And what happens if you get two of them, such as #3 and #5? Usually, as is the case with this example, two exact matches are an error; but a couple special cases are exceptions to this rule. Clearly, we need to investigate the matter further!

### Exact Matches and Best Matches

C++ allows some “trivial conversions” when making an exact match. Table 8.1 lists them, with *Type* standing for some arbitrary type. For example, an `int` actual argument is an exact match to an `int &` formal parameter. Note that *Type* can be something like `char &`, so these rules include converting `char &` to `const char &`. The *Type (argument-list)* entry means that a function name as an actual argument matches a function pointer as a formal parameter, as long as both have the same return type and argument list. (Remember function pointers from Chapter 7. Also recall that you can pass the name of a function as an argument to a function that expects a pointer to a function.) We’ll discuss the `volatile` keyword later in Chapter 9.

Table 8.1 Trivial Conversions Allowed for an Exact Match

| From an Actual Argument           | To a Formal Argument                  |
|-----------------------------------|---------------------------------------|
| <code>Type</code>                 | <code>Type &amp;</code>               |
| <code>Type &amp;</code>           | <code>Type</code>                     |
| <code>Type []</code>              | <code>* Type</code>                   |
| <code>Type (argument-list)</code> | <code>Type (*) (argument-list)</code> |
| <code>Type</code>                 | <code>const Type</code>               |
| <code>Type</code>                 | <code>volatile Type</code>            |
| <code>Type *</code>               | <code>const Type *</code>             |
| <code>Type *</code>               | <code>volatile Type *</code>          |

Suppose you have the following function code:

```
struct blot {int a; char b[10];};
blot ink = {25, "spots"};
...
recycle(ink);
```

In that case, all the following prototypes would be exact matches:

```
void recycle(blot);           // #1 blot-to-blot
void recycle(const blot);    // #2 blot-to-(const blot)
void recycle(blot &);        // #3 blot-to-(blot &)
void recycle(const blot &);  // #4 blot-to-(const blot &)
```

As you might expect, the result of having several matching prototypes is that the compiler cannot complete the overload resolution process. There is no best viable function, and the compiler generates an error message, probably using words such as *ambiguous*.

However, sometimes there can be overload resolution even if two functions are an exact match. First, pointers and references to non-`const` data are preferentially matched to non-`const` pointer and reference parameters. That is, if only Functions #3 and #4 were available in the `recycle()` example, #3 would be chosen because `ink` wasn't declared as `const`. However, this discrimination between `const` and non-`const` applies just to data referred to by pointers and references. That is, if only #1 and #2 were available, you would get an ambiguity error.

Another case in which one exact match is better than another is when one function is a non template function and the other isn't. In that case, the non template is considered better than a template, including explicit specializations.

If you wind up with two exact matches that both happen to be template functions, the template function that is the more specialized, if either, is the better function. That means, for example, that an explicit specialization is chosen over one generated implicitly from the template pattern:

```
struct blot {int a; char b[10];};
template <class Type> void recycle (Type t); // template
template <> void recycle<blot> (blot & t);  // specialization for blot
...
blot ink = {25, "spots"};
...
recycle(ink); // use specialization
```

The term *most specialized* doesn't necessarily imply an explicit specialization; more generally, it indicates that fewer conversions take place when the compiler deduces what type to use. For example, consider the following two templates:

```
template <class Type> void recycle (Type t);    // #1
template <class Type> void recycle (Type * t);  // #2
```



Suppose the program that contains those templates also contains the following code:

```
struct blot {int a; char b[10];};
blot ink = {25, "spots"};
...
recycle(&ink); // address of a structure
```

The `recycle(&ink)` call matches Template #1, with `Type` interpreted as `blot *`. The `recycle(&ink)` function call also matches Template #2, this time with `Type` being `ink`. This combination sends two implicit instantiations, `recycle<blot *>(blot *)` and `recycle<blot>(blot *)`, to the viable function pool.

Of these two template functions, `recycle<blot *>(blot *)` is considered the more specialized because it underwent fewer conversions in being generated. That is, Template #2 already explicitly said that the function argument was pointer-to-`Type`, so `Type` could be directly identified with `blot`. However, Template #1 had `Type` as the function argument, so `Type` had to be interpreted as pointer-to-`blot`. That is, in Template #2, `Type` was already specialized as a pointer, hence it is “more specialized.”

The rules for finding the most specialized template are called the *partial ordering rules* for function templates. Like explicit instantiations, they are C++98 additions to the C++ language.

### A Partial Ordering Rules Example

Let’s examine a complete program that uses the partial ordering rules for identifying which template definition to use. Listing 8.14 has two template definitions for displaying the contents of an array. The first definition (Template A) assumes that the array that is passed as an argument contains the data to be displayed. The second definition (Template B) assumes that the array elements are pointers to the data to be displayed.

Listing 8.14 `tempover.cpp`

---

```
// tempover.cpp -- template overloading
#include <iostream>

template <typename T> // template A
void ShowArray(T arr[], int n);

template <typename T> // template B
void ShowArray(T * arr[], int n);

struct debts
{
    char name[50];
    double amount;
};

int main()
```

```
{
    using namespace std;
    int things[6] = {13, 31, 103, 301, 310, 130};
    struct debts mr_E[3] =
    {
        {"Ima Wolfe", 2400.0},
        {"Ura Foxe", 1300.0},
        {"Iby Stout", 1800.0}
    };
    double * pd[3];

    // set pointers to the amount members of the structures in mr_E
    for (int i = 0; i < 3; i++)
        pd[i] = &mr_E[i].amount;

    cout << "Listing Mr. E's counts of things:\n";
    // things is an array of int
    ShowArray(things, 6); // uses template A
    cout << "Listing Mr. E's debts:\n";
    // pd is an array of pointers to double
    ShowArray(pd, 3); // uses template B (more specialized)
    return 0;
}

template <typename T>
void ShowArray(T arr[], int n)
{
    using namespace std;
    cout << "template A\n";
    for (int i = 0; i < n; i++)
        cout << arr[i] << ' ';
    cout << endl;
}

template <typename T>
void ShowArray(T * arr[], int n)
{
    using namespace std;
    cout << "template B\n";
    for (int i = 0; i < n; i++)
        cout << *arr[i] << ' ';
    cout << endl;
}
```

---

Consider this function call:

```
ShowArray(things, 6);
```

The identifier `things` is the name of an array of `int`, so it matches the following template with `T` taken to be type `int`:

```
template <typename T>           // template A
void ShowArray(T arr[], int n);
```

Next, consider this function call:

```
ShowArray(pd, 3);
```

Here, `pd` is the name of an array of `double *`. This could be matched by Template A:

```
template <typename T>           // template A
void ShowArray(T arr[], int n);
```

Here, `T` would be taken to be type `double *`. In this case, the template function would display the contents of the `pd` array: three addresses. The function call could also be matched by Template B:

```
template <typename T>           // template B
void ShowArray(T * arr[], int n);
```

In this case, `T` is type `double`, and the function displays the dereferenced elements `*arr[i]`—that is, the `double` values pointed to by the array contents. Of the two templates, Template B is the more specialized because it makes the specific assumption that the array contents are pointers, so it is the template that gets used.

Here's the output of the program in Listing 8.14:

```
Listing Mr. E's counts of things:
```

```
template A
```

```
13 31 103 301 310 130
```

```
Listing Mr. E's debts:
```

```
template B
```

```
2400 1300 1800
```

If you remove Template B from the program, the compiler then uses Template A for listing the contents of `pd`, so it lists the addresses instead of the values. Try it and see.

In short, the overload resolution process looks for a function that's the best match. If there's just one, that function is chosen. If more than one are otherwise tied, but only one is a non template function, that non template function is chosen. If more than one candidate are otherwise tied and all are template functions, but one template is more specialized than the rest, that one is chosen. If there are two or more equally good non template functions, or if there are two or more equally good template functions, none of which is more specialized than the rest, the function call is ambiguous and an error. If there are no matching calls, of course, that is also an error.

## Making Your Own Choices

In some circumstances, you can lead the compiler to make the choice you want by suitably writing the function call. Consider Listing 8.15, which, by the way, eliminates the template prototype and places the template function definition at the top of the file. As with regular functions, a template function definition can act as its own prototype if it appears before the function is used.

### Listing 8.15 `choices.cpp`

---

```
// choices.cpp -- choosing a template
#include <iostream>

template<class T> // or template <typename T>
T lesser(T a, T b) // #1
{
    return a < b ? a : b;
}

int lesser (int a, int b) // #2
{
    a = a < 0 ? -a : a;
    b = b < 0 ? -b : b;
    return a < b ? a : b;
}

int main()
{
    using namespace std;
    int m = 20;
    int n = -30;
    double x = 15.5;
    double y = 25.9;

    cout << lesser(m, n) << endl; // use #2
    cout << lesser(x, y) << endl; // use #1 with double
    cout << lesser<>(m, n) << endl; // use #1 with int
    cout << lesser<int>(x, y) << endl; // use #1 with int

    return 0;
}
```

---

(The final function call converts `double` to `int`, and some compilers will issue warnings about that.)

Here is the program output:

```
20
15.5
-30
15
```

Listing 8.15 provides a template that returns the lesser of two values and a standard function that returns the smaller absolute value of two values. If a function definition appears before its first use, the definition acts as a prototype, so this example omits the prototypes. Consider the following statement:

```
cout << lesser(m, n) << endl;           // use #2
```

The function call arguments match both the template function and the non template function, so the non template function is chosen, and it returns the value 20.

Next, the function call in the statement matches the template, with type `T` taken to be `double`:

```
cout << lesser(x, y) << endl;           // use #1 with double
```

Now consider this statement:

```
cout << lesser<>(m, n) << endl;         // use #1 with int
```

The presence of the angle brackets in `lesser<>(m, n)` indicates that the compiler should choose a template function rather than a non template function, and the compiler, noting that the actual arguments are type `int`, instantiates the template using `int` for `T`.

Finally, consider this statement:

```
cout << lesser<int>(x, y) << endl;      // use #1 with int
```

Here we have a request for an explicit instantiation using `int` for `T`, and that's the function that gets used. The values of `x` and `y` are type cast to type `int`, and the function returns an `int` value, which is why the program displays 15 instead of 15.5.

## Functions with Multiple Type Arguments

Where matters really get involved is when a function call with multiple arguments is matched to prototypes with multiple type arguments. The compiler must look at matches for all the arguments. If it can find a function that is better than all the other viable functions, it is chosen. For one function to be better than another function, it has to provide at least as good a match for all arguments and a better match for at least one argument.

This book does not intend to challenge the matching process with complex examples. The rules are there so that there is a well-defined result for any possible set of function prototypes and templates.

## Template Function Evolution

In the early days of C++, most people didn't envision how powerful and useful template functions and template classes would prove to be. (Probably they didn't even expend their

envisionary powers on the topic.) But clever and dedicated programmers pushed the limits of template techniques and expanded the ideas of what was possible. Feedback from those who developed familiarity with templates led to changes that were incorporated into the C++98 Standard as well as the addition of the Standard Template Library. Since then, template programmers have continued to explore the possibilities offered by the genre, and occasionally they bump up against limitations. Their feedback has led to some changes in the C++11 Standard. We'll look at a couple of related problems now and their solutions.

### What's That Type?

One problem is that when you write a template function, it's not always possible in C++98 to know what type to use in a declaration. Consider this partial example:

```
template<class T1, class T2>
void ft(T1 x, T2 y)
{
    ...
    ?type? xpy = x + y;
    ...
}
```

What should the type for `xpy` be? We don't know in advance how `ft()` might be used. The proper type might be `T1` or `T2` or some other type altogether. For example, `T1` could be `double` and `T2` could be `int`, in which case the type of the sum is `double`. Or `T1` could be `short` and `T2` could be `int`, in which case the type of the sum is `int`. Or suppose `T1` is `short` and `T2` is `char`. Then addition invokes automatic integer promotions, and the resultant type is `int`. Also the `+` operator can be overloaded for structures and classes, complicating the options further. Therefore, in C++98 there is no obvious choice for the type of `xpy`.

### The `decltype` Keyword (C++11)

The C++11 solution is a new keyword: `decltype`. It can be used in this way:

```
int x;
decltype(x) y; // make y the same type as x
```

The argument to `decltype` can be an expression, so in the `ft()` example, we could use this code:

```
decltype(x + y) xpy; // make xpy the same type as x + y
xpy = x + y;
```

Alternatively, we could combine these two statements into an initialization:

```
decltype(x + y) xpy = x + y;
```

So we can fix the `ft()` template this way:

```
template<class T1, class T2>
void ft(T1 x, T2 y)
{
    ...
    decltype(x + y) xpy = x + y;
    ...
}
```

The `decltype` facility is a bit more complex than it might appear from these examples. The compiler has to go through a checklist to decide on the type. Suppose we have the following:

```
decltype(expression) var;
```

Here's a somewhat simplified version of the list.

**Stage 1:** If *expression* is an unparenthesized identifier (that is, no additional parentheses), then *var* is of the same type as the identifier, including qualifiers such as `const`:

```
double x = 5.5;
double y = 7.9;
double &rx = x;
const double * pd;
decltype(x) w;           // w is type double
decltype(rx) u = y;     // u is type double &
decltype(pd) v;        // v is type const double *
```

**Stage 2:** If *expression* is a function call, then *var* has the type of the function return type:

```
long indeed(int);
decltype (indeed(3)) m; // m is type int
```

### Note

The call *expression* isn't evaluated. In this case, the compiler examines the prototype to get the return type; there's no need to actually call the function.

**Stage 3:** If *expression* is an lvalue, then *var* is a reference to the expression type. This might seem to imply that earlier examples such as *w* should have been reference types, given that *w* is an lvalue. However, keep in mind that case was already captured in Stage 1. For this stage to apply, *expression* can't be an unparenthesized identifier. So what can it be? One obvious possibility is a parenthesized identifier:

```
double xx = 4.4;
decltype ((xx)) r2 = xx; // r2 is double &
decltype(xx) w = xx;    // w is double (Stage 1 match)
```

Incidentally, parentheses don't change the value or lvaluedness of an expression. For example, the following two statements have the same effect:

```
xx = 98.6;
(xx) = 98.6; // () don't affect use of xx
```

**Stage 4:** If none of the preceding special cases apply, `var` is of the same type as *expression*:

```
int j = 3;
int &k = j;
int &n = j;
decltype(j+6) i1; // i1 type int
decltype(100L) i2; // i2 type long
decltype(k+n) i3; // i3 type int;
```

Note that although `k` and `n` are references, the expression `k+n` is not a reference; it's just the sum of two ints, hence an int.

If you need more than one declaration, you can use `typedef` with `decltype`:

```
template<class T1, class T2>
void ft(T1 x, T2 y)
{
    ...
    typedef decltype(x + y) xytype;
    xytype xpy = x + y;
    xytype arr[10];
    xytype & rxy = arr[2]; // rxy a reference
    ...
}
```

### Alternative Function Syntax (C++11 Trailing Return Type)

The `decltype` mechanism by itself leaves another related problem unsolved. Consider this incomplete template function:

```
template<class T1, class T2>
?type? gt(T1 x, T2 y)
{
    ...
    return x + y;
}
```

Again, we don't know in advance what type results from adding `x` and `y`. It might seem that we could use `decltype(x + y)` for the return type. Unfortunately, at that point in the code, the parameters `x` and `y` have not yet been declared, so they are not in scope (visible and usable to the compiler). The `decltype` specifier has to come *after* the parameters are declared. To make this possible, C++11 allows a new syntax for declaring and defining functions. Here's how it works using built-in types. The prototype



```
double h(int x, float y);
```

can be written with this alternative syntax:

```
auto h(int x, float y) -> double;
```

This moves the return type to after the parameter declarations. The combination `-> double` is called a *trailing return type*. Here, `auto`, in another new C++11 role, is a placeholder for the type provided by the trailing return type. The same form would be used with the function definition:

```
auto h(int x, float y) -> double
{ /* function body */};
```

Combining this syntax with `decltype` leads to the following solution for specifying the return type for `gt()`:

```
template<class T1, class T2>
auto gt(T1 x, T2 y) -> decltype(x + y)
{
    ...
    return x + y;
}
```

Now `decltype` comes after the parameter declarations, so `x` and `y` are in scope and can be used.

## Summary

C++ has expanded C function capabilities. By using an `inline` keyword with a function definition and by placing that definition ahead of the first call to that function, you suggest to the C++ compiler that it make the function inline. That is, instead of having the program jump to a separate section of code to execute the function, the compiler replaces the function call with the corresponding code inline. An inline facility should be used only when the function is short.

A reference variable is a kind of disguised pointer that lets you create an alias (that is, a second name) for a variable. Reference variables are primarily used as arguments to functions that process structures and class objects. Normally, an identifier declared as a reference to a particular type can refer only to data of that type. However, when one class is derived from another, such as `ofstream` from `ostream`, a reference to the base type may also refer to the derived type.

C++ prototypes enable you to define default values for arguments. If a function call omits the corresponding argument, the program uses the default value. If the function includes an argument value, the program uses that value instead of the default. Default arguments can be provided only from right to left in the argument list. Thus, if you provide a default value for a particular argument, you must also provide default values for all arguments to the right of that argument.

A function's signature is its argument list. You can define two functions having the same name, provided that they have different signatures. This is called *function polymorphism*, or *function overloading*. Typically, you overload functions to provide essentially the same service to different data types.

Function templates automate the process of overloading functions. You define a function by using a generic type and a particular algorithm, and the compiler generates appropriate function definitions for the particular argument types you use in a program.

## Chapter Review

1. What kinds of functions are good candidates for inline status?
2. Suppose the `song()` function has this prototype:  

```
void song(const char * name, int times);
```

  - a. How would you modify the prototype so that the default value for `times` is 1?
  - b. What changes would you make in the function definition?
  - c. Can you provide a default value of "O, My Papa" for `name`?
3. Write overloaded versions of `iquote()`, a function that displays its argument enclosed in double quotation marks. Write three versions: one for an `int` argument, one for a `double` argument, and one for a `string` argument.
4. The following is a structure template:

```
struct box
{
    char maker[40];
    float height;
    float width;
    float length;
    float volume;
};
```

- a. Write a function that has a reference to a `box` structure as its formal argument and displays the value of each member.
  - b. Write a function that has a reference to a `box` structure as its formal argument and sets the `volume` member to the product of the other three dimensions.
5. What changes would need be made to Listing 7.15 so that the functions `fill()` and `show()` use reference parameters?

6. The following are some desired effects. Indicate whether each can be accomplished with default arguments, function overloading, both, or neither. Provide appropriate prototypes.
  - a. `mass(density, volume)` returns the mass of an object having a density of `density` and a volume of `volume`, whereas `mass(density)` returns the mass having a density of `density` and a volume of 1.0 cubic meters. All quantities are type `double`.
  - b. `repeat(10, "I'm OK")` displays the indicated string 10 times, and `repeat("But you're kind of stupid")` displays the indicated string 5 times.
  - c. `average(3, 6)` returns the `int` average of two `int` arguments, and `average(3.0, 6.0)` returns the `double` average of two `double` values.
  - d. `mangle("I'm glad to meet you")` returns the character `I` or a pointer to the string "I'm mad to gleet you", depending on whether you assign the return value to a `char` variable or to a `char*` variable.
7. Write a function template that returns the larger of its two arguments.
8. Given the template of Chapter Review Question 7 and the `box` structure of Chapter Review Question 4, provide a template specialization that takes two `box` arguments and returns the one with the larger volume.
9. What types are assigned to `v1`, `v2`, `v3`, `v4`, and `v5` in the following code (assuming the code is part of a complete program)?

```
int g(int x);
...
float m = 5.5f;
float & rm = m;
decltype(m) v1 = m;
decltype(rm) v2 = m;
decltype(m) v3 = m;
decltype(g(100)) v4;
decltype(2.0 * m) v5;
```

## Programming Exercises

1. Write a function that normally takes one argument, the address of a string, and prints that string once. However, if a second, type `int`, argument is provided and is nonzero, the function should print the string a number of times equal to the number of times that function has been called at that point. (Note that the number of times the string is printed is not equal to the value of the second argument; it is



```

    show(beany);        // prints member string once
    show(beany, 2);    // prints member string twice
    testing[0] = 'D';
    testing[1] = 'u';
    show(testing);     // prints testing string once
    show(testing, 3); // prints testing string thrice
    show("Done!");
    return 0;
}

```

Complete this skeleton by providing the described functions and prototypes. Note that there should be two `show()` functions, each using default arguments. Use `const` arguments when appropriate. Note that `set()` should use `new` to allocate sufficient space to hold the designated string. The techniques used here are similar to those used in designing and implementing classes. (You might have to alter the header filenames and delete the `using` directive, depending on your compiler.)

5. Write a template function `max5()` that takes as its argument an array of five items of type `T` and returns the largest item in the array. (Because the size is fixed, it can be hard-coded into the loop instead of being passed as an argument.) Test it in a program that uses the function with an array of five `int` value and an array of five `double` values.
6. Write a template function `maxn()` that takes as its arguments an array of items of type `T` and an integer representing the number of elements in the array and that returns the largest item in the array. Test it in a program that uses the function template with an array of six `int` value and an array of four `double` values. The program should also include a specialization that takes an array of pointers-to-`char` as an argument and the number of pointers as a second argument and that returns the address of the longest string. If multiple strings are tied for having the longest length, the function should return the address of the first one tied for longest. Test the specialization with an array of five string pointers.
7. Modify Listing 8.14 so that it uses two template functions called `SumArray()` to return the sum of the array contents instead of displaying the contents. The program now should report the total number of things and the sum of all the debts.

# Memory Models and Namespaces

In this chapter you'll learn about the following:

- Separate compilation of programs
- Storage duration, scope, and linkage
- Placement `new`
- Namespaces

C++ offers many choices for storing data in memory. You have choices for how long data remains in memory (storage duration) and choices for which parts of a program have access to data (scope and linkage). You can allocate memory dynamically by using `new`, and placement `new` offers a variation on that technique. The C++ namespace facility provides additional control over access. Larger programs typically consist of several source code files that may share some data in common. Such programs involve the separate compilation of the program files, and this chapter begins with that topic.

## Separate Compilation

C++, like C, allows and even encourages you to locate the component functions of a program in separate files. As Chapter 1, “Getting Started with C++,” describes, you can compile the files separately and then link them into the final executable program. (A C++ compiler typically compiles programs and also manages the linker program.) If you modify just one file, you can recompile just that one file and then link it to the previously compiled versions of the other files. This facility makes it easier to manage large programs. Furthermore, most C++ environments provide additional facilities to help with the management. Unix and Linux systems, for example, have `make` programs, which keep track of which files a program depends on and when they were last modified. If you run `make`, and it detects that you've changed one or more source files since the last compilation, `make` remembers the proper steps needed to reconstitute the program. Most integrated development environments (IDEs), including Embarcadero C++ Builder, Microsoft Visual

C++, Apple Xcode, and Freescale CodeWarrior, provide similar facilities with their Project menus.

Let's look at a simple example. Instead of looking at compilation details, which depend on the implementation, let's concentrate on more general aspects, such as design.

Suppose, for example, that you decide to break up the program in Listing 7.12 by placing the two supporting functions in a separate file. Recall that Listing 7.12 converts rectangular coordinates to polar coordinates and then displays the result. You can't simply cut the original file on a dotted line after the end of `main()`. The problem is that `main()` and the other two functions use the same structure declarations, so you need to put the declarations in both files. Simply typing them in is an invitation to error. Even if you copy the structure declarations correctly, you have to remember to modify both sets of declarations if you make changes later. In short, spreading a program over multiple files creates new problems.

Who wants more problems? The developers of C and C++ didn't, so they've provided the `#include` facility to deal with this situation. Instead of placing the structure declarations in each file, you can place them in a header file and then include that header file in each source code file. That way, if you modify the structure declaration, you can do so just once, in the header file. Also you can place the function prototypes in the header file. Thus, you can divide the original program into three parts:

- A header file that contains the structure declarations and prototypes for functions that use those structures
- A source code file that contains the code for the structure-related functions
- A source code file that contains the code that calls the structure-related functions

This is a useful strategy for organizing a program. If, for example, you write another program that uses those same functions, you can just include the header file and add the functions file to the project or `make` list. Also this organization is consistent with the OOP approach. One file, the header file, contains the definition of the user-defined types. A second file contains the function code for manipulating the user-defined types. Together, they form a package you can use for a variety of programs.

You shouldn't put function definitions or variable declarations into a header file. That might work for a simple setup but usually it leads to trouble. For example, if you had a function definition in a header file and then included the header file in two other files that are part of a single program, you'd wind up with two definitions of the same function in a single program, which is an error, unless the function is inline. Here are some things commonly found in header files:

- Function prototypes
- Symbolic constants defined using `#define` or `const`
- Structure declarations
- Class declarations

- Template declarations
- Inline functions

It's okay to put structure declarations in a header file because they don't create variables; they just tell the compiler how to create a structure variable when you declare one in a source code file. Similarly, template declarations aren't code to be compiled; they are instructions to the compiler on how to generate function definitions to match function calls found in the source code. Data declared `const` and inline functions have special linkage properties (described shortly) that allow them to be placed in header files without causing problems.

Listings 9.1, 9.2, and 9.3 show the result of dividing Listing 7.12 into separate parts. Note that you use `"coordin.h"` instead of `<coordin.h>` when including the header file. If the filename is enclosed in angle brackets, the C++ compiler looks at the part of the host system's file system that holds the standard header files. But if the filename is enclosed in double quotation marks, the compiler first looks at the current working directory or at the source code directory (or some such choice, depending on the compiler). If it doesn't find the header file there, it then looks in the standard location. So you should use quotation marks, not angle brackets, when including your own header files.

Figure 9.1 outlines the steps for putting this program together on a Unix system. Note that you just give the `CC` compile command, and the other steps follow automatically. The `g++` and `gpp` command-line compilers and the Borland C++ command-line compiler (`bcc32.exe`) also behave that way. Apple Xcode, Embarcadero C++ Builder, and Microsoft Visual C++ go through essentially the same steps, but, as outlined in Chapter 1, you initiate the process differently, using menus that let you create a project and associate source code files with it. Note that you only add source code files, not header files, to projects. That's because the `#include` directive manages the header files. Also you shouldn't use `#include` to include source code files because that can lead to multiple declarations.

### Caution

In IDEs, don't add header files to the project list and don't use `#include` to include source code files in other source code files.

#### Listing 9.1 `coordin.h`

```
// coordin.h -- structure templates and function prototypes
// structure templates
#ifndef COORDIN_H_
#define COORDIN_H_

struct polar
{
    double distance;    // distance from origin
    double angle;      // direction from origin
};
```



```

struct rect
{
    double x;        // horizontal distance from origin
    double y;        // vertical distance from origin
};

// prototypes
polar rect_to_polar(rect xypos);
void show_polar(polar dapos);

#endif

```

1. Give UNIX compile command for two source files:  
CC file1.cpp file2.cpp
2. Preprocessor combines included files with source code:

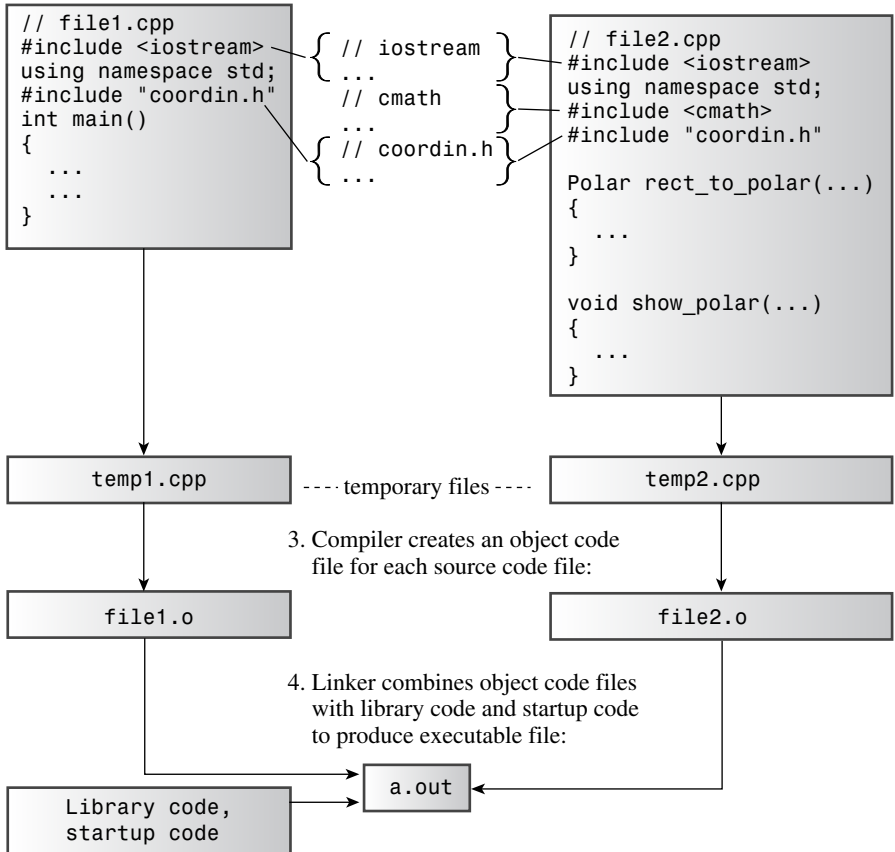

Figure 9.1 Compiling a multifile C++ program on a Unix system.

## Header File Management

You should include a header file just once in a file. That might seem to be an easy thing to remember, but it's possible to include a header file several times without knowing you did so. For example, you might use a header file that includes another header file. There's a standard C/C++ technique for avoiding multiple inclusions of header files. It's based on the preprocessor `#ifndef` (for *if not defined*) directive. A code segment like the following means "process the statements between the `#ifndef` and `#endif` only if the name `COORDIN_H_` has not been defined previously by the preprocessor `#define` directive":

```
#ifndef COORDIN_H_
...
#endif
```

Normally, you use the `#define` statement to create symbolic constants, as in the following:

```
#define MAXIMUM 4096
```

But simply using `#define` with a name is enough to establish that a name is defined, as in the following:

```
#define COORDIN_H_
```

The technique that Listing 9.1 uses is to wrap the file contents in an `#ifndef`:

```
#ifndef COORDIN_H_
#define COORDIN_H_
// place include file contents here
#endif
```

The first time the compiler encounters the file, the name `COORDIN_H_` should be undefined. (I chose a name based on the `include` filename, with a few underscore characters tossed in to create a name that is unlikely to be defined elsewhere.) That being the case, the compiler looks at the material between the `#ifndef` and the `#endif`, which is what you want. In the process of looking at the material, the compiler reads the line defining `COORDIN_H_`. If it then encounters a second inclusion of `coordin.h` in the same file, the compiler notes that `COORDIN_H_` is defined and skips to the line following the `#endif`. Note that this method doesn't keep the compiler from including a file twice. Instead, it makes the compiler ignore the contents of all but the first inclusion. Most of the standard C and C++ header files use this guarding scheme. Otherwise you might get the same structure defined twice in one file, and that will produce a compile error.

### Listing 9.2 `file1.cpp`

```
// file1.cpp -- example of a three-file program
#include <iostream>
#include "coordin.h" // structure templates, function prototypes
using namespace std;
int main()
```

```

{
    rect rplace;
    polar pplace;

    cout << "Enter the x and y values: ";
    while (cin >> rplace.x >> rplace.y) // slick use of cin
    {
        pplace = rect_to_polar(rplace);
        show_polar(pplace);
        cout << "Next two numbers (q to quit): ";
    }
    cout << "Bye!\n";
    return 0;
}

```

---

### Listing 9.3 `file2.cpp`

---

```

// file2.cpp -- contains functions called in file1.cpp
#include <iostream>
#include <cmath>
#include "coordin.h" // structure templates, function prototypes

// convert rectangular to polar coordinates
polar rect_to_polar(rect xypos)
{
    using namespace std;
    polar answer;

    answer.distance =
        sqrt( xypos.x * xypos.x + xypos.y * xypos.y);
    answer.angle = atan2(xypos.y, xypos.x);
    return answer; // returns a polar structure
}

// show polar coordinates, converting angle to degrees
void show_polar (polar dapos)
{
    using namespace std;
    const double Rad_to_deg = 57.29577951;

    cout << "distance = " << dapos.distance;
    cout << ", angle = " << dapos.angle * Rad_to_deg;
    cout << " degrees\n";
}

```

---

Compiling and linking these two source code files along with the new header file produces an executable program. Here is a sample run:

```
Enter the x and y values: 120 80
distance = 144.222, angle = 33.6901 degrees
Next two numbers (q to quit): 120 50
distance = 130, angle = 22.6199 degrees
Next two numbers (q to quit): q
```

By the way, although we've discussed separate compilation in terms of files, the C++ Standard uses the term *translation unit* instead of *file* in order to preserve greater generality; the file metaphor is not the only possible way to organize information for a computer. For simplicity, this book will use the term *file*, but feel free to translate that to *translation unit*.

### Multiple Library Linking

The C++ Standard allows each compiler designer the latitude to implement name decoration or mangling (see the sidebar “What Is Name Decoration?” in Chapter 8, “Adventures in Functions”) as it sees fit, so you should be aware that binary modules (object-code files) created with different compilers will, most likely, not link properly. That is, the two compilers will generate different decorated names for the same function. This name difference will prevent the linker from matching the function call generated by one compiler with the function definition generated by a second compiler. When attempting to link compiled modules, you should make sure that each object file or library was generated with the same compiler. If you are provided with the source code, you can usually resolve link errors by recompiling the source with your compiler.

## Storage Duration, Scope, and Linkage

Now that you've seen a multifile program, it's a good time to extend the discussion of memory schemes in Chapter 4, “Compound Types,” because storage categories affect how information can be shared across files. It might have been a while since you last read Chapter 4, so let's review what it says about memory. C++ uses three separate schemes (four under C++11) for storing data, and the schemes differ in how long they preserve data in memory:

- **Automatic storage duration**—Variables declared inside a function definition—including function parameters—have automatic storage duration. They are created when program execution enters the function or block in which they are defined, and the memory used for them is freed when execution leaves the function or block. C++ has two kinds of automatic storage duration variables.
- **Static storage duration**—Variables defined outside a function definition or else by using the keyword `static` have static storage duration. They persist for the entire time a program is running. C++ has three kinds of static storage duration variables.
- **Thread storage duration (C++11)**—These days multicore processors are common. These are CPUs that can handle several execution tasks simultaneously. This allows a program to split computations into separate *threads* that can be processed

concurrently. Variables declared with the `thread_local` keyword have storage that persists for as long as the containing thread lasts. This book does not venture into concurrent programming.

- **Dynamic storage duration**—Memory allocated by the `new` operator persists until it is freed with the `delete` operator or until the program ends, whichever comes first. This memory has dynamic storage duration and sometimes is termed the *free store* or the *heap*.

You'll get the rest of the story now, including fascinating details about when variables of different types are in scope, or visible (that is, usable by the program), and about linkage, which determines what information is shared across files.

## Scope and Linkage

*Scope* describes how widely visible a name is in a file (translation unit). For example, a variable defined in a function can be used in that function but not in another, whereas a variable defined in a file above the function definitions can be used in all the functions. *Linkage* describes how a name can be shared in different units. A name with *external linkage* can be shared across files, and a name with *internal linkage* can be shared by functions within a single file. Names of automatic variables have no linkage because they are not shared.

A C++ variable can have one of several scopes. A variable that has *local scope* (also termed *block scope*) is known only within the block in which it is defined. Recall that a block is a series of statements enclosed in braces. A function body, for example, is a block, but you can have other blocks nested within the function body. A variable that has *global scope* (also termed *file scope*) is known throughout the file after the point where it is defined. Automatic variables have local scope, and a static variable can have either scope, depending on how it is defined. Names used in a *function prototype scope* are known just within the parentheses enclosing the argument list. (That's why it doesn't really matter what they are or if they are even present.) Members declared in a class have *class scope* (see Chapter 10, "Objects and Classes"). Variables declared in a namespace have *namespace scope*. (Now that namespaces have been added to the C++ language, the global scope has become a special case of namespace scope.)

C++ functions can have class scope or namespace scope, including global scope, but they can't have local scope. (Because a function can't be defined inside a block, if a function were to have local scope, it could only be known to itself and hence couldn't be called by another function. Such a function couldn't function.)

The various C++ storage choices are characterized by their storage duration, their scope, and their linkage. Let's look at C++'s storage classes in terms of these properties. We begin by examining the situation before namespaces were added to the mix and then see how namespaces modify the picture.

## Automatic Storage Duration

Function parameters and variables declared inside a function have, by default, automatic storage duration. They also have local scope and no linkage. That is, if you declare a variable called `texas` in `main()` and you declare another variable with the same name in a function called `oil()`, you've created two independent variables, each known only in the function in which it's defined. Anything you do to the `texas` in `oil()` has no effect on the `texas` in `main()`, and vice versa. Also each variable is allocated when program execution enters the innermost block containing the definition, and each fades from existence when execution leaves that block. (Note that the variable is allocated when execution enters the block, but the scope begins only after the point of declaration.)

If you define a variable inside a block, the variable's persistence and scope are confined to that block. Suppose, for example, that you define a variable called `teledeli` at the beginning of `main()`. Now suppose you start a new block within `main()` and define a new variable, called `websight`, in the block. Then, `teledeli` is visible in both the outer and inner blocks, whereas `websight` exists only in the inner block and is in scope only from its point of definition until program execution passes the end of the block:

```
int main()
{
    int teledeli = 5;
    {
        cout << "Hello\n";           // websight allocated
        int websight = -2;          // websight scope begins
        cout << websight << ' ' << teledeli << endl;
    }                               // websight expires
    cout << teledeli << endl;
    ...
} // teledeli expires
```

But what if you name the variable in the inner block `teledeli` instead of `websight` so that you have two variables of the same name, with one in the outer block and one in the inner block? In this case, the program interprets the `teledeli` name to mean the local block variable while the program executes statements within the block. We say the new definition *hides* the prior definition. The new definition is in scope, and the old definition is temporarily out of scope. When the program leaves the block, the original definition comes back into scope (see Figure 9.2).

Listing 9.4 illustrates how automatic variables are localized to the functions or blocks that contain them.

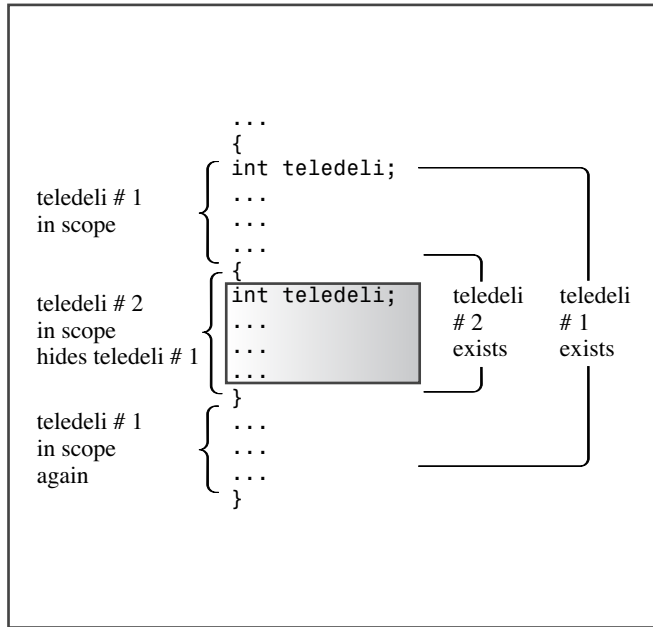

Figure 9.2 Blocks and scope.

Listing 9.4 **autoscp.cpp**

```

// autoscp.cpp -- illustrating scope of automatic variables
#include <iostream>
void oil(int x);
int main()
{
    using namespace std;

    int texas = 31;
    int year = 2011;
    cout << "In main(), texas = " << texas << ", &texas = ";
    cout << &texas << endl;
    cout << "In main(), year = " << year << ", &year = ";
    cout << &year << endl;
    oil(texas);
    cout << "In main(), texas = " << texas << ", &texas = ";
    cout << &texas << endl;
    cout << "In main(), year = " << year << ", &year = ";
    cout << &year << endl;
    return 0;
}

```

```

void oil(int x)
{
    using namespace std;
    int texas = 5;

    cout << "In oil(), texas = " << texas << ", &texas = ";
    cout << &texas << endl;
    cout << "In oil(), x = " << x << ", &x = ";
    cout << &x << endl;
    {
        // start a block
        int texas = 113;
        cout << "In block, texas = " << texas;
        cout << ", &texas = " << &texas << endl;
        cout << "In block, x = " << x << ", &x = ";
        cout << &x << endl;
    }
    // end a block
    cout << "Post-block texas = " << texas;
    cout << ", &texas = " << &texas << endl;
}

```

---

Here is the output from the program in Listing 9.4:

```

In main(), texas = 31, &texas = 0012FED4
In main(), year = 2011, &year = 0012FEC8
In oil(), texas = 5, &texas = 0012FDE4
In oil(), x = 31, &x = 0012FDF4
In block, texas = 113, &texas = 0012FDD8
In block, x = 31, &x = 0012FDF4
Post-block texas = 5, &texas = 0012FDE4
In main(), texas = 31, &texas = 0012FED4
In main(), year = 2011, &year = 0012FEC8

```

Notice that each of the three `texas` variables in Listing 9.4 has its own distinct address and that the program uses only the particular variable in scope at the moment, so assigning the value 113 to the `texas` in the inner block in `oil()` has no effect on the other variables of the same name. (As usual, the actual address values and address format will differ from system to system.)

Let's summarize the sequence of events. When `main()` starts, the program allocates space for `texas` and `year`, and these variables come into scope. When the program calls `oil()`, these variables remain in memory but pass out of scope. Two new variables, `x` and `texas`, are allocated and come into scope. When program execution reaches the inner block in `oil()`, the new `texas` passes out of scope (is hidden) because it is superseded by an even newer definition. The variable `x`, however, stays in scope because the block doesn't define a new `x`. When execution exits the block, the memory for the newest `texas` is freed, and `texas #2` comes back into scope. When the `oil()` function terminates, that `texas` and `x` expire, and the original `texas` and `year` come back into scope.



### Changes to `auto` in C++11

In C++11, the keyword `auto` is used for automatic type deduction, as you have seen in Chapters 3, 7, and 8. But in C and in prior versions of C++, `auto` has an entirely different meaning. It's used to explicitly identify a variable as having automatic storage:

```
int froob(int n)
{
    auto float ford; // ford has automatic storage
    ...
}
```

Because programmers can use the `auto` keyword only with variables that are already automatic by default, they rarely bother using it. Its main function is to document that you really wanted to use a local automatic variable.

In C++11, this usage no longer is valid. The people who prepare standards are reluctant to introduce new keywords because doing so might invalidate existing code that already uses that word for other purposes. In this case, it was felt that the old use of `auto` was rare enough that it was better to repurpose this keyword rather than introduce a new one.

### Initialization of Automatic Variables

You can initialize an automatic variable with any expression whose value will be known when the declaration is reached. The following example shows the variables `x`, `big`, `y`, and `z` being initialized:

```
int w;           // value of w is indeterminate
int x = 5;       // initialized with a numeric literal
int big = INT_MAX - 1; // initialized with a constant expression
int y = 2 * x;   // use previously determined value of x
cin >> w;
int z = 3 * w;   // use new value of w
```

### Automatic Variables and the Stack

You might gain a better understanding of automatic variables if you look at how a typical C++ compiler implements them. Because the number of automatic variables grows and shrinks as functions start and terminate, the program has to manage automatic variables as it runs. The usual means is to set aside a section of memory and treat it as a stack for managing the flow and ebb of variables. It's called a *stack* because new data is figuratively stacked atop old data (that is, at an adjacent location, not at the same location) and then removed from the stack when a program is finished with it. The default size of the stack depends on the implementation, but a compiler typically provides the option of changing the size. The program keeps track of the stack by using two pointers. One points to the base of the stack, where the memory set aside for the stack begins, and one points to the top of the stack, which is the next free memory location. When a function is called, its automatic variables are added to the stack, and the pointer to the top points to the next available free space following the variables. When the function terminates, the top pointer

is reset to the value it had before the function was called, effectively freeing the memory that had been used for the new variables.

A stack is a LIFO (last-in, first-out) design, meaning the last variables added to the stack are the first to go. The design simplifies argument passing. The function call places the values of its arguments on top of the stack and resets the top pointer. The called function uses the description of its formal parameters to determine the addresses of each argument. For example, Figure 9.3 shows a `fib()` function that, when called, passes a 2-byte `int` and a 4-byte `long`. These values go on the stack. When `fib()` begins execution, it associates the names `real` and `tell` with the two values. When `fib()` terminates, the top-of-stack pointer is relocated to its former position. The new values aren't erased, but they are no longer labeled, and the space they occupy will be used by the next process that places values on the stack. (Figure 9.3 is somewhat simplified because function calls may pass additional information, such as a return address.)

## Register Variables

C originally introduced the `register` keyword to suggest that the compiler use a CPU register to store an automatic variable:

```
register int count_fast; // request for a register variable
```

The idea was that this would allow faster access to the variable.

Prior to C++11, C++ used the keyword in the same fashion, except that as hardware and compilers developed in sophistication, the hint was generalized to mean that the variable was heavily used and perhaps the compiler could provide some sort of special treatment. With C++11, even that hint is being deprecated, leaving `register` as just a way to explicitly identify a variable as being automatic. Given that `register` can only be used with variables that would be automatic anyway, one reason to use this keyword is to indicate that you really do want to use an automatic variable, perhaps one with the same name as an external variable. This is the same purpose the original use of `auto` served. The more important reason for retaining `register`, however, is to avoid invalidating existing code that uses that keyword.

## Static Duration Variables

C++, like C, provides static storage duration variables with three kinds of linkage: external linkage (accessible across files), internal linkage (accessible to functions within a single file), and no linkage (accessible to just one function or to one block within a function). All three last for the duration of the program; they are less ephemeral than automatic variables. Because the number of static variables doesn't change as the program runs, the program doesn't need a special device such as a stack to manage them. Instead, the compiler allocates a fixed block of memory to hold all the static variables, and those variables stay present as long as the program executes. Also if you don't explicitly initialize a static variable, the compiler sets it to 0. Static arrays and structures have all the bits of each element or member set to 0 by default.

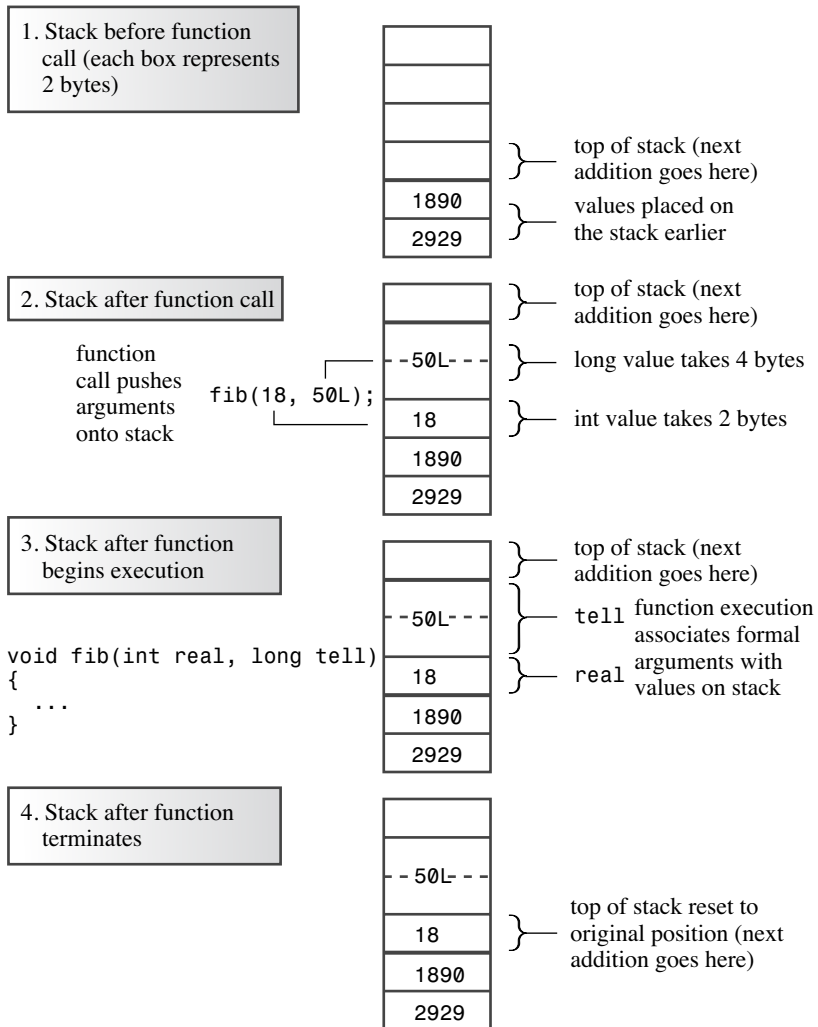

Figure 9.3 Passing arguments by using a stack.

**Note**

Classic K&R C does not allow you to initialize automatic arrays and structures, but it does allow you to initialize static arrays and structures. ANSI C and C++ allow you to initialize both kinds. But some older C++ translators use C compilers that are not fully ANSI C-compliant. If you are using such an implementation, you might need to use one of the three varieties of static storage classes for initializing arrays and structures.

Let's look at how to create the three different kinds of static duration variables; then we can go on to examine their properties. To create a static duration variable with external linkage, you declare it outside any block. To create a static duration variable with internal linkage, you declare it outside any block and use the `static` storage class modifier. To create a static duration variable with no linkage, you declare it inside a block, using the `static` modifier. The following code fragment shows these three variations:

```
...
int global = 1000;           // static duration, external linkage
static int one_file = 50;   // static duration, internal linkage
int main()
{
    ...
}
void funct1(int n)
{
    static int count = 0;    // static duration, no linkage
    int llama = 0;
    ...
}
void funct2(int q)
{
    ...
}
```

As stated previously, all the static duration variables (`global`, `one_file`, and `count`, in this example) persist from the time the program begins execution until it terminates. The variable `count`, which is declared inside `funct1()`, has local scope and no linkage, which means it can be used only inside the `funct1()` function, just like the automatic variable `llama`. But unlike `llama`, `count` remains in memory even when the `funct1()` function is not being executed. Both `global` and `one_file` have file scope, meaning they can be used from the point of declaration until the end of the file. In particular, both can be used in `main()`, `funct1()`, and `funct2()`. Because `one_file` has internal linkage, it can be used only in the file containing this code. Because `global` has external linkage, it also can be used in other files that are part of the program.

All static duration variables share the following initialization feature: An uninitialized static variable has all its bits set to 0. Such a variable is said to be *zero-initialized*.

Table 9.1 summarizes the storage class features as used in the pre-namespace era. Next, we'll examine the static duration varieties in more detail.

Note that the keyword `static` has somewhat different meanings in the two uses shown in Table 9.1. When used with a local declaration to indicate a static variable with no linkage, `static` indicates the kind of storage duration. When used with a declaration outside of a block, `static` indicates internal linkage; the variable already has static duration. One might term this *keyword overloading*, with the precise meaning determined by context.

Table 9.1 The Five Kinds of Variable Storage

| Storage Description          | Duration  | Scope | Linkage  | How Declared                                               |
|------------------------------|-----------|-------|----------|------------------------------------------------------------|
| Automatic                    | Automatic | Block | None     | In a block                                                 |
| Register                     | Automatic | Block | None     | In a block with the keyword <code>register</code>          |
| Static with no linkage       | Static    | Block | None     | In a block with the keyword <code>static</code>            |
| Static with external linkage | Static    | File  | External | Outside all functions                                      |
| Static with internal linkage | Static    | File  | Internal | Outside all functions with the keyword <code>static</code> |

### Initializing Static Variables

Static variables may be *zero-initialized*, they may undergo *constant expression initialization*, and they may undergo *dynamic initialization*. As you may have surmised, zero-initialization means setting the variable to the value zero. For scalar types, the zero is type cast to the appropriate type. For example, the null pointer, which is represented by 0 in C++ code, may have a nonzero internal representation, so a pointer variable would be initialized to that value. Structure members are zero-initialized, and any padding bits are set to zero.

Zero-initialization and constant-expression initialization collectively are called *static initialization*. This means the variable is initialized when the compiler processes the file (or translation unit). Dynamic initialization means the variable is initialized later.

So what determines which form of initialization takes place? First of all, all static variables are zero-initialized, whether or not any initialization is indicated. Next, if the variable is initialized using a constant expression that the compiler can evaluate solely from the file contents (including included header files), it can perform constant-expression initialization. The compiler is prepared to do simple calculations if needed. If there's not enough information at this time, the variable will be dynamically initialized. Consider the following:

```
#include <cmath>
int x; // zero-initialization
int y = 5; // constant-expression initialization
long z = 13 * 13; // constant-expression initialization
const double pi = 4.0 * atan(1.0); // dynamic initialization
```

First, `x`, `y`, `z`, and `pi` are zero-initialized. Then the compiler evaluates the constant expressions and initializes `y` and `z` to 5 and 169, respectively. But initializing `pi` requires

calling the `atan()` function, and this has to wait until the function is linked and the program executes.

A constant expression is not limited to arithmetic expressions using literal constants. It can, for example, use the `sizeof` operator:

```
int enough = 2 * sizeof (long) + 1; // constant expression initialization
```

C++11 introduces a new keyword, `constexpr`, to expand the options for creating constant expressions; this is one of the new C++11 features that this book does not pursue further.

## Static Duration, External Linkage

Variables with external linkage are often simply called *external variables*. They necessarily have static storage duration and file scope. External variables are defined outside, and hence external to, any function. For example, they could be declared above the `main()` function or in a header file. You can use an external variable in any function that follows the external variable's definition in the file. Thus, external variables are also termed *global variables*, in contrast to automatic variables, which are local variables.

### The One Definition Rule

On the one hand, an external variable has to be declared in each file that uses the variable. On the other hand, C++ has the “one definition rule” (also known as *odr*), which states that there can be only one definition of a variable. To satisfy these requirements, C++ has two kinds of variable declarations. One is the *defining declaration* or, simply, a *definition*. It causes storage for the variable to be allocated. The second is the *referencing declaration* or, simply, a *declaration*. It does not cause storage to be allocated because it refers to an existing variable.

A referencing declaration uses the keyword `extern` and does not provide initialization. Otherwise, a declaration is a definition and causes storage to be allocated:

```
double up;           // definition, up is 0
extern int blem;     // blem defined elsewhere
extern char gr = 'z'; // definition because initialized
```

If you use an external variable in several files, only one file can contain a definition for that variable (per the one definition rule). But every other file using the variable needs to declare that variable using the keyword `extern`:

```
// file01.cpp
extern int cats = 20; // definition because of initialization
int dogs = 22;       // also a definition
int fleas;          // also a definition
...
// file02.cpp
// use cats and dogs from file01.cpp
extern int cats;     // not definitions because they use
```

```
extern int dogs;          // extern and have no initialization
...
// file98.cpp
// use cats, dogs, and fleas from file01.cpp
extern int cats;
extern int dogs;
extern int fleas;
...
```

In this case, all the files use the `cats` and `dogs` variables defined in `file01.cpp`. However, `file02.cpp` doesn't re-declare the `fleas` variable, so it can't access it. The `extern` in `file01.cpp` isn't really needed because the effect is the same if it is omitted (also see Figure 9.4).

|                                                                                                                                                                                                                                                     |                                                                                                                                                                                                                                                               |
|-----------------------------------------------------------------------------------------------------------------------------------------------------------------------------------------------------------------------------------------------------|---------------------------------------------------------------------------------------------------------------------------------------------------------------------------------------------------------------------------------------------------------------|
| <pre>// file1.cpp #include &lt;iostream&gt; using namespace std;  // function prototypes #include "mystuff.h"  // defining an external variable int process_status = 0;  void promise (); int main() {     ... }  void promise () {     ... }</pre> | <pre>// file2.cpp #include &lt;iostream&gt; using namespace std;  // function prototypes #include "mystuff.h"  // referencing an external variable extern int process_status;  int manipulate(int n) {     ... }  char * remark(char * str) {     ... }</pre> |
|-----------------------------------------------------------------------------------------------------------------------------------------------------------------------------------------------------------------------------------------------------|---------------------------------------------------------------------------------------------------------------------------------------------------------------------------------------------------------------------------------------------------------------|

This file defines the variable `process_status`, causing the compiler to allocate space for it.

This file uses `extern` to instruct the program to use the variable `process_status` that was defined in another file.

Figure 9.4 Defining declaration and referencing declaration.

Note that the one definition rule doesn't mean that there can be only one variable with a given name. For example, automatic variables sharing the same name but defined in different functions are separate variables, independent of one another, and each having its own address. Also as later examples show, a local variable can hide a global variable of the same name. However, although a program can have different variables of the same name, each version can have only one definition.

What if you define an external variable and then declare a variable by the same name inside a function? The second declaration is interpreted as a definition for an automatic variable. The automatic variable is the one that is in scope when the program executes that particular function. Listings 9.5 and 9.6, to be compiled together, illustrate using an external variable in two files and how an automatic variable hides a global variable of the same name. The program also shows how you can use the keyword `extern` to re-declare an external variable defined earlier and how you can use C++'s scope-resolution operator to access an otherwise hidden external variable.

#### Listing 9.5 `external.cpp`

---

```
// external.cpp -- external variables
// compile with support.cpp
#include <iostream>
using namespace std;
// external variable
double warming = 0.3;      // warming defined
// function prototypes
void update(double dt);
void local();

int main()                 // uses global variable
{
    cout << "Global warming is " << warming << " degrees.\n";
    update(0.1);           // call function to change warming
    cout << "Global warming is " << warming << " degrees.\n";
    local();              // call function with local warming
    cout << "Global warming is " << warming << " degrees.\n";
    return 0;
}
```

---

#### Listing 9.6 `support.cpp`

---

```
// support.cpp -- use external variable
// compile with external.cpp
#include <iostream>
extern double warming; // use warming from another file

// function prototypes
void update(double dt);
void local();

using std::cout;
void update(double dt)    // modifies global variable
{
    extern double warming; // optional redeclaration
```



```

    warming += dt;           // uses global warming
    cout << "Updating global warming to " << warming;
    cout << " degrees.\n";
}

void local()                // uses local variable
{
    double warming = 0.8;   // new variable hides external one

    cout << "Local warming = " << warming << " degrees.\n";
        // Access global variable with the
        // scope resolution operator
    cout << "But global warming = " << ::warming;
    cout << " degrees.\n";
}

```

---

Here is the output from the program:

```

Global warming is 0.3 degrees.
Updating global warming to 0.4 degrees.
Global warming is 0.4 degrees.
Local warming = 0.8 degrees.
But global warming = 0.4 degrees.
Global warming is 0.4 degrees.

```

### Program Notes

The output of the program in Listings 9.5 and 9.6 illustrates that both `main()` and `update()` can access the external variable `warming`. Note that the change that `update()` makes to `warming` shows up in subsequent uses of the variable.

The definition for `warming` is in Listing 9.5:

```
double warming = 0.3;      // warming defined
```

Listing 9.6 uses `extern` to make the `warming` variable available to the functions in that file:

```
extern double warming;    // use warming from another file
```

As the comment indicates, this declaration says, “Use the `warming` variable defined externally elsewhere.”

In addition, the `update()` function re-declares the `warming` variable by using the keyword `extern`. This keyword means “Use the variable by this name previously defined externally.” Because that is what `update()` would do anyway if you omitted the entire declaration, this declaration is optional. It serves to document that the function is designed to use the external variable.

The `local()` function demonstrates that when you define a local variable that has the same name as a global variable, the local version hides the global version. The `local()`

function, for example, uses the local definition of `warming` when it displays the value of `warming`.

C++ goes a step beyond C by offering the *scope-resolution operator* (`::`). When it is prefixed to the name of a variable, this operator means to use the global version of that variable. Thus, `local()` displays `warming` as `0.8`, but it displays `::warming` as `0.4`. You'll encounter this operator again in namespaces and classes. In terms of clarity and error-avoidance, it would have been better and safer to use `::warming` in the `update()` function instead of using just `warming` and relying on scope rules.

### Global Versus Local Variables

Now that you have a choice of using global or local variables, which should you use? At first, global variables have a seductive appeal—because all functions have access to a global variable, you don't have to bother passing arguments. But this easy access has a heavy price: unreliable programs. Computing experience has shown that the better job your program does of isolating data from unnecessary access, the better job the program does in preserving the integrity of the data. Most often, you should use local variables and pass data to functions on a need-to-know basis rather than make data available indiscriminately by using global variables. As you will see, OOP takes this data isolation a step further.

Global variables do have their uses, however. For example, you might have a block of data that's to be used by several functions, such as an array of month names or the atomic weights of the elements. The external storage class is particularly suited to representing constant data because you can use the keyword `const` to protect the data from change:

```
const char * const months[12] =
{
    "January", "February", "March", "April", "May",
    "June", "July", "August", "September", "October",
    "November", "December"
};
```

In this example, the first `const` protects the strings from change, and the second `const` makes sure that each pointer in the array remains pointing to the same string to which it pointed initially.

### Static Duration, Internal Linkage

Applying the `static` modifier to a file-scope variable gives it internal linkage. The difference between internal linkage and external linkage becomes meaningful in multifile programs. In that context, a variable with internal linkage is local to the file that contains it. But a regular external variable has external linkage, meaning that it can be used in different files, as the previous example showed.

What if you want to use the same name to denote different variables in different files? Can you just omit the `extern`?

```
// file1
int errors = 20;          // external declaration
...
-----
// file2
int errors = 5;          // ??known to file2 only??
void froobish()
{
    cout << errors;      // fails
    ...
}
```

No, this attempt fails because it violates the one definition rule. The `file2` definition attempts to create an external variable, so the program winds up with two definitions of `errors`, which is an error.

But if a file declares a static external variable that has the same name as an ordinary external variable declared in another file, the static version is the one in scope for that file:

```
// file1
int errors = 20;          // external declaration
...
-----
// file2
static int errors = 5;    // known to file2 only
void froobish()
{
    cout << errors;      // uses errors defined in file2
    ...
}
```

This doesn't violate the one definition rule because the keyword `static` establishes that the identifier `errors` has internal linkage, so no attempt is made to bring in an external definition.

### Note

In a multifile program, you can define an external variable in one and only one file. All other files using that variable have to declare that variable with the `extern` keyword.

You can use an external variable to share data among different parts of a multifile program. You can use a static variable with internal linkage to share data among functions found in just one file. (Namespaces offer an alternative method for this.) Also if you make a file-scope variable static, you needn't worry about its name conflicting with file-scope variables found in other files.

Listings 9.7 and 9.8 show how C++ handles variables with external and internal linkage. Listing 9.7 (`twofile1.cpp`) defines the external variables `tom` and `dick` and the static external variable `harry`. The `main()` function in that file displays the addresses of the three variables and then calls the `remote_access()` function, which is defined in a second file. Listing 9.8 (`twofile2.cpp`) shows that file. In addition to defining `remote_access()`, the file uses the `extern` keyword to share `tom` with the first file. Next, the file defines a static

variable called `dick`. The `static` modifier makes this variable local to the file and overrides the global definition. Then the file defines an external variable called `harry`. It can do so without conflicting with the `harry` of the first file because the first `harry` has internal linkage only. Then the `remote_access()` function displays the addresses of these three variables so that you can compare them with the addresses of the corresponding variables in the first file. Remember that you need to compile both files and link them to get the complete program.

---

**Listing 9.7 twofile1.cpp**

---

```
// twofile1.cpp -- variables with external and internal linkage
#include <iostream>      // to be compiled with two file2.cpp
int tom = 3;           // external variable definition
int dick = 30;         // external variable definition
static int harry = 300; // static, internal linkage

// function prototype
void remote_access();

int main()
{
    using namespace std;
    cout << "main() reports the following addresses:\n";
    cout << &tom << " = &tom, " << &dick << " = &dick, ";
    cout << &harry << " = &harry\n";
    remote_access();
    return 0;
}
```

---

---

**Listing 9.8 twofile2.cpp**

---

```
// twofile2.cpp -- variables with internal and external linkage
#include <iostream>
extern int tom;           // tom defined elsewhere
static int dick = 10;    // overrides external dick
int harry = 200;         // external variable definition,
                        // no conflict with twofile1 harry

void remote_access()
{
    using namespace std;
    cout << "remote_access() reports the following addresses:\n";
    cout << &tom << " = &tom, " << &dick << " = &dick, ";
    cout << &harry << " = &harry\n";
}
```

---

Here is the output from the program produced by compiling Listings 9.7 and 9.8 together:

```
main() reports the following addresses:
0x0041a020 = &tom, 0x0041a024 = &dick, 0x0041a028 = &harry
remote_access() reports the following addresses:
0x0041a020 = &tom, 0x0041a450 = &dick, 0x0041a454 = &harry
```

As you can see from the addresses, both files use the same `tom` variable but different `dick` and `harry` variables. (The particular address values and formatting may be different on your system, but the `tom` addresses will match each other, and the `dick` and `harry` addresses won't.)

## Static Storage Duration, No Linkage

So far, we've looked at a file-scope variable with external linkage and a file-scope variable with internal linkage. Now let's look at the third member of the static duration family: local variables with no linkage. You create such a variable by applying the `static` modifier to a variable defined inside a block. When you use it inside a block, `static` causes a local variable to have static storage duration. This means that even though the variable is known within that block, it exists even while the block is inactive. Thus a static local variable can preserve its value between function calls. (Static variables would be useful for reincarnation—you could use them to pass secret account numbers for a Swiss bank to your next appearance.) Also if you initialize a static local variable, the program initializes the variable once, when the program starts up. Subsequent calls to the function don't reinitialize the variable the way they do for automatic variables. Listing 9.9 illustrates these points.

### Listing 9.9 `static.cpp`

---

```
// static.cpp -- using a static local variable
#include <iostream>
// constants
const int ArSize = 10;

// function prototype
void strcount(const char * str);

int main()
{
    using namespace std;
    char input[ArSize];
    char next;

    cout << "Enter a line:\n";
    cin.get(input, ArSize);
    while (cin)
    {
```

```

    cin.get(next);
    while (next != '\n')    // string didn't fit!
        cin.get(next);    // dispose of remainder
    strcount(input);
    cout << "Enter next line (empty line to quit):\n";
    cin.get(input, ArSize);
}
cout << "Bye\n";
return 0;
}

void strcount(const char * str)
{
    using namespace std;
    static int total = 0;    // static local variable
    int count = 0;        // automatic local variable

    cout << "\"" << str << "\" contains ";
    while (*str++)        // go to end of string
        count++;
    total += count;
    cout << count << " characters\n";
    cout << total << " characters total\n";
}

```

Incidentally, the program in Listing 9.9 shows one way to deal with line input that may exceed the size of the destination array. Recall that the `cin.get(input, ArSize)` input method reads up to the end of the line or up to `ArSize - 1` characters, whichever comes first. It leaves the newline character in the input queue. This program uses `cin.get(next)` to read the character that follows the line input. If `next` is a newline character, then the preceding call to `cin.get(input, ArSize)` must have read the whole line. If `next` isn't a newline character, there are more characters left on the line. This program then uses a loop to reject the rest of the line, but you can modify the code to use the rest of the line for the next input cycle. The program also uses the fact that attempting to read an empty line with `get(char *, int)` causes `cin` to test as `false`.

Here is the output of the program in Listing 9.9:

```

Enter a line:
nice pants
"nice pant" contains 9 characters
9 characters total
Enter next line (empty line to quit):
thanks
"thanks" contains 6 characters
15 characters total

```

```

Enter next line (empty line to quit):
parting is such sweet sorrow
"parting i" contains 9 characters
24 characters total
Enter next line (empty line to quit):
ok
"ok" contains 2 characters
26 characters total
Enter next line (empty line to quit):

Bye

```

Note that because the array size is 10, the program does not read more than nine characters per line. Also note that the automatic variable `count` is reset to 0 each time the function is called. However, the static variable `total` is set to 0 once at the beginning. After that, `total` retains its value between function calls, so it's able to maintain a running total.

## Specifiers and Qualifiers

Certain C++ keywords, called *storage class specifiers* and *cv-qualifiers*, provide additional information about storage. Here's a list of the storage class specifiers:

```

auto (eliminated as a specifier in C++11)
register
static
extern
thread_local (added by C++11)
mutable

```

You've already seen most of these, and you can use no more than one of them in a single declaration, except that `thread_local` can be used with `static` or `extern`. To review, prior to C++11, the keyword `auto` could be used in a declaration to document that the variable is an automatic variable. (In C++11, `auto` is used for automatic type deduction.) The keyword `register` is used in a declaration to indicate the register storage class, which, in C++11, simply is an explicit way of saying the variable is automatic. The keyword `static`, when used with a file-scope declaration, indicates internal linkage. When used with a local declaration, it indicates static storage duration for a local variable. The keyword `extern` indicates a reference declaration—that is, that the declaration refers to a variable defined elsewhere. The keyword `thread_local` indicates that the duration of the variable is the duration of the containing thread. A `thread_local` variable is to a thread much as a regular static variable is to the whole program. The keyword `mutable` is explained in terms of `const`, so let's look at the cv-qualifiers first before returning to `mutable`.

## Cv-Qualifiers

Here are the cv-qualifiers:

```

const
volatile

```

(As you may have guessed, *cv* stands for `const` and `volatile`.) The most commonly used *cv*-qualifier is `const`, and you've already seen its purpose: It indicates that memory, after initialized, should not be altered by a program. We'll come back to `const` in a moment.

The `volatile` keyword indicates that the value in a memory location can be altered even though nothing in the program code modifies the contents. This is less mysterious than it sounds. For example, you could have a pointer to a hardware location that contains the time or information from a port. In this case, the hardware, not the program, changes the contents. Or two programs may interact, sharing data. The intent of this keyword is to improve the optimization abilities of compilers. For example, suppose the compiler notices that a program uses the value of a particular variable twice within a few statements. Rather than have the program look up the value twice, the compiler might cache the value in a register. This optimization assumes that the value of the variable doesn't change between the two uses. If you don't declare a variable as `volatile`, then the compiler can feel free to make this optimization. If you do declare a variable as `volatile`, you're telling the compiler not to make that sort of optimization.

### **mutable**

Now let's return to `mutable`. You can use it to indicate that a particular member of a structure (or class) can be altered even if a particular structure (or class) variable is a `const`. For example, consider the following code:

```
struct data
{
    char name[30];
    mutable int accesses;
    ...
};
const data veep = {"Claybourne Clodde", 0, ... };
strcpy(veep.name, "Joye Joux"); // not allowed
veep.accesses++; // allowed
```

The `const` qualifier to `veep` prevents a program from changing `veep`'s members, but the `mutable` specifier to the `accesses` member shields `accesses` from that restriction.

This book doesn't use `volatile` or `mutable`, but there is more to learn about `const`.

### **More About const**

In C++ (but not C), the `const` modifier alters the default storage classes slightly. Whereas a global variable has external linkage by default, a `const` global variable has internal linkage by default. That is, C++ treats a global `const` definition, such as in the following code fragment, as if the `static` specifier had been used:

```
const int fingers = 10; // same as static const int fingers = 10;
int main(void)
{
    ...
}
```



C++ has altered the rules for constant types to make life easier for you. Suppose, for example, that you have a set of constants that you'd like to place in a header file and that you use this header file in several files in the same program. After the preprocessor includes the header file contents in each source file, each source file will contain definitions like this:

```
const int fingers = 10;
const char * warning = "Wak!";
```

If global `const` declarations had external linkage as regular variables do, this would be an error because of the one definition rule. That is, only one file can contain the preceding declaration, and the other files have to provide reference declarations using the `extern` keyword. Moreover, only the declarations without the `extern` keyword would be able to initialize values:

```
// extern would be required if const had external linkage
extern const int fingers;           // can't be initialized
extern const char * warning;
```

So you would need one set of definitions for one file and a different set of declarations for the other files. Instead, because externally defined `const` data has internal linkage, you can use the same declarations in all files.

Internal linkage also means that each file gets its own set of constants rather than sharing them. Each definition is private to the file that contains it. This is why it's a good idea to put constant definitions in a header file. That way, as long as you include the same header file in two source code files, they receive the same set of constants.

If, for some reason, you want to make a constant have external linkage, you can use the `extern` keyword to override the default internal linkage:

```
extern const int states = 50;      // definition with external linkage
```

You then must use the `extern` keyword to declare the constant in all files that use the constant. This differs from regular external variables, in which you don't have to use the keyword `extern` when you define a variable, but you use `extern` in other files using that variable. Keep in mind, however, now that a single `const` is being shared among files, only one file can use initialization.

When you declare a `const` within a function or block, it has block scope, which means the constant is usable only when the program is executing code within the block. This means that you can create constants within a function or block and not have to worry about the names conflicting with constants defined elsewhere.

## Functions and Linkage

Like variables, functions have linkage properties, although the selection is more limited than for variables. C++, like C, does not allow you to define one function inside another, so all functions automatically have static storage duration, meaning they are all present as long as the program is running. By default, functions have external linkage, meaning they can be shared across files. You can, in fact, use the keyword `extern` in a function prototype

to indicate that the function is defined in another file, but that is optional. (For the program to find the function in another file, that file must be one of the files being compiled as part of the program or a library file searched by the linker.) You can also use the keyword `static` to give a function internal linkage, confining its use to a single file. You would apply this keyword to the prototype and to the function definition:

```
static int private(double x);  
...  
static int private(double x)  
{  
    ...  
}
```

This means the function is known only in that file. It also means you can use the same name for another function in a different file. As with variables, a static function overrides an external definition for the file containing the static declaration, so a file containing a static function definition will use that version of the function even if there is an external definition of a function that has the same name.

The one definition rule extends to non-inline functions, too. Therefore, every program shall contain exactly one definition of every non-inline function. For functions with external linkage, this means that only one file of a multifile program can contain the function definition. (This file could be a library file rather than one you supply.) However, each file that uses the function should have the function prototype.

Inline functions are excepted from this rule to allow you to place inline function definitions in a header file. Thus, each file that includes the header file ends up having the inline function definition. However, C++ does require that all the inline definitions for a particular function be identical.

### Where C++ Finds Functions

Suppose you call a function in a particular file in a program. Where does C++ look for the function definition? If the function prototype in that file indicates that the function is static, the compiler looks only in that file for the function definition. Otherwise, the compiler (and the linker, too) looks in all the program files. If it finds two definitions, the compiler sends you an error message because you can have only one definition for an external function. If it fails to find any definition in the files, the function then searches the libraries. This implies that if you define a function that has the same name as a library function, the compiler uses your version rather than the library version. (However, C++ reserves the names of the standard library functions, so you shouldn't reuse them.) Some compiler-linkers need explicit instructions to identify which libraries to search.

## Language Linking

Another form of linking, called *language linking*, affects functions. First, a little background. A linker needs a different symbolic name for each distinct function. In C, this is simple to implement because there can be only one C function with a given name. So for internal purposes, a C compiler might translate a C function name such as `spiff` to `_spiff`. The

C approach is termed *C language linkage*. However, C++ can have several functions with the same C++ name that have to be translated to separate symbolic names. Thus, the C++ compiler indulges in the process of name mangling or name decoration (as discussed in Chapter 8) to generate different symbolic names for overloaded functions. For example, it could convert `spiff(int)` to, say, `_spiff_i`, and `spiff(double, double)` to `_spiff_d_d`. The C++ approach is *C++ language linkage*.

When the linker looks for a function to match a C++ function call, it uses a different look-up method than it does to match a C function call. But suppose you want to use a precompiled function from a C library in a C++ program? For example, suppose you have this code:

```
spiff(22); // want spiff(int) from a C library
```

Its hypothetical symbolic name in the C library file is `_spiff`, but for our hypothetical linker, the C++ look-up convention is to look for the symbolic name `_spiff_i`. To get around this problem, you can use the function prototype to indicate which protocol to use:

```
extern "C" void spiff(int); // use C protocol for name look-up
extern void spoff(int); // use C++ protocol for name look-up
extern "C++" void spaff(int); // use C++ protocol for name look-up
```

The first example here uses C language linkage. The second and third examples use C++ language linkage; the second does so by default, and the third does so explicitly.

C and C++ language linkage are the only specifiers required by the C++ Standard. But implementations have the option of providing additional language linkage specifiers.

## Storage Schemes and Dynamic Allocation

You've seen the five schemes, excluding threaded memory, C++ uses to allocate memory for variables (including arrays and structures). They don't apply to memory allocated by using the C++ `new` operator (or by using the older C `malloc()` function). We call that kind of memory *dynamic memory*. As you saw in Chapter 4, dynamic memory is controlled by the `new` and `delete` operators, not by scope and linkage rules. Thus, dynamic memory can be allocated from one function and freed from another function. Unlike automatic memory, dynamic memory is not LIFO; the order of allocation and freeing depends on when and how `new` and `delete` are used. Typically, the compiler uses three separate memory chunks: one for static variables (this chunk might be subdivided), one for automatic variables, and one for dynamic storage.

Although the storage scheme concepts don't apply to dynamic memory, they do apply to automatic and static pointer variables used to keep track of dynamic memory. For example, suppose you have the following statement inside a function:

```
float * p_fees = new float [20];
```

The 80 bytes (assuming that a `float` is 4 bytes) of memory allocated by `new` remains in memory until the `delete` operator frees it. But the `p_fees` pointer passes from existence when program execution exits the block containing this declaration. If you want to have

the 80 bytes of allocated memory available to another function, you need to pass or return its address to that function. On the other hand, if you declare `p_fees` with external linkage, the `p_fees` pointer will be available to all the functions following that declaration in the file. And by using the following in a second file, you make that same pointer available in the second file:

```
extern float * p_fees;
```

### Note

Memory allocated by `new` is typically freed when the program terminates. However, this is not always true. Under some less robust operating systems, for example, in some circumstances a request for a large block of memory can result in a block that is not deleted automatically when the program terminates. The best practice is to use `delete` to free memory allocated by `new`.

## Initialization with the `new` Operator

What if you want to initialize a variable as part of the dynamic memory allocation? With C++98, you can do so in some instances. C++11 expands what is possible. Let's look first at what has been possible.

If you wish to create and initialize storage for one of the scalar built-in types, such as `int` or `double`, you can do so by following the desired type with an initialization value enclosed in parentheses:

```
int *pi = new int (6); // *pi set to 6
double *pd = new double (99.99); // *pd set to 99.99
```

The parentheses syntax also can be used with classes having suitable constructors, but we haven't got that far yet.

To initialize an ordinary structure or an array, however, you need C++11 and list-initialization using braces. The new standard allows the following:

```
struct where {double x; double y; double z;};
where * one = new where {2.5, 5.3, 7.2}; // C++11
int * ar = new int [4] {2,4,6,7}; // C++11
```

With C++11, you also can use the brace initialization for single-valued variables:

```
int *pin = new int {}; // *pi set to 6
double * pdo = new double {99.99}; // *pd set to 99.99
```

## When `new` Fails

It may be that `new` can't find the requested amount of memory. For its first decade, C++ handled that eventuality by having `new` return a null pointer. Currently, however, `new` throws a `std::bad_alloc` exception. Chapter 15, "Friends, Exceptions, and More," provides some short examples showing how each approach works.

### **new: Operators, Functions, and Replacement Functions**

The `new` and `new[]` operators call upon two functions:

```
void * operator new(std::size_t);    // used by new
void * operator new[](std::size_t); // used by new[]
```

These are termed *allocation functions*, and they are part of the global namespace. Similarly, there are deallocation functions used by `delete` and `delete []`:

```
void operator delete(void *);
void operator delete[](void *);
```

They use the operator-overloading syntax discussed in Chapter 11, “Working with Classes.” The `std::size_t` is a `typedef` for some suitable integer type. A basic statement such as

```
int * pi = new int;
```

gets translated into something like this:

```
int * pi = new(sizeof(int));
```

And the statement

```
int * pa = new int[40];
```

gets translated into something like this:

```
int * pa = new(40 * sizeof(int));
```

As you’ve seen, a statement with a `new` operator can also provide initialization values, so, in general, using the `new` operator may do more than just call the `new()` function.

Similarly,

```
delete pi;
```

invokes the following function call:

```
delete (pi);
```

Interestingly, C++ terms these functions *replaceable*. That means if you have sufficient expertise and desire, you can supply replacement functions for `new` and `delete` and tailor them to meet your specific requirements. One option, for instance, is to define replacement functions with class scope so that they can be tailored to fit the allocation needs of a particular class. Your code would use the `new` operator as usual, but the `new` operator would call upon the replacement `new()` function.

### **The Placement new Operator**

Normally, the `new` operator has the responsibility of finding in the heap a block of memory that is large enough to handle the amount of memory you request. The `new` operator has a variation, called *placement new*, that allows you to specify the location to be used. A programmer might use this feature to set up his or her own memory-management

procedures or to deal with hardware that is accessed via a particular address or to construct objects in a particular memory location.

To use the placement `new` feature, you first include the `new` header file, which provides a prototype for this version of `new`. Then you use `new` with an argument that provides the intended address. Aside from this argument, the syntax is the same as for regular `new`. In particular, you can use placement `new` either without or with brackets. The following code fragment shows the syntax for using these four forms of `new`:

```
#include <new>
struct chaff
{
    char dross[20];
    int slag;
};
char buffer1[50];
char buffer2[500];
int main()
{
    chaff *p1, *p2;
    int *p3, *p4;
// first, the regular forms of new
    p1 = new chaff;           // place structure in heap
    p3 = new int[20];        // place int array in heap
// now, the two forms of placement new
    p2 = new (buffer1) chaff; // place structure in buffer1
    p4 = new (buffer2) int[20]; // place int array in buffer2
    ...
}
```

For simplicity, this example uses two static arrays to provide memory space for placement `new`. So this code allocates space for a `chaff` structure in `buffer1` and space for an array of 20 ints in `buffer2`.

Now that you've made your acquaintance with placement `new`, let's look at a sample program. Listing 9.10 uses both `new` and placement `new` to create dynamically allocated arrays. This program illustrates some important differences between `new` and placement `new` that we'll discuss after seeing the output.

#### Listing 9.10 `newplace.cpp`

---

```
// newplace.cpp -- using placement new
#include <iostream>
#include <new>           // for placement new
const int BUF = 512;
const int N = 5;
char buffer[BUF];      // chunk of memory
int main()
{
    using namespace std;
```

```

double *pd1, *pd2;
int i;
cout << "Calling new and placement new:\n";
pd1 = new double[N];           // use heap
pd2 = new (buffer) double[N]; // use buffer array
for (i = 0; i < N; i++)
    pd2[i] = pd1[i] = 1000 + 20.0 * i;
cout << "Memory addresses:\n" << " heap: " << pd1
    << " static: " << (void *) buffer << endl;
cout << "Memory contents:\n";
for (i = 0; i < N; i++)
{
    cout << pd1[i] << " at " << &pd1[i] << " ";
    cout << pd2[i] << " at " << &pd2[i] << endl;
}

cout << "\nCalling new and placement new a second time:\n";
double *pd3, *pd4;
pd3= new double[N];           // find new address
pd4 = new (buffer) double[N]; // overwrite old data
for (i = 0; i < N; i++)
    pd4[i] = pd3[i] = 1000 + 40.0 * i;
cout << "Memory contents:\n";
for (i = 0; i < N; i++)
{
    cout << pd3[i] << " at " << &pd3[i] << " ";
    cout << pd4[i] << " at " << &pd4[i] << endl;
}

cout << "\nCalling new and placement new a third time:\n";
delete [] pd1;
pd1= new double[N];
pd2 = new (buffer + N * sizeof(double)) double[N];
for (i = 0; i < N; i++)
    pd2[i] = pd1[i] = 1000 + 60.0 * i;
cout << "Memory contents:\n";
for (i = 0; i < N; i++)
{
    cout << pd1[i] << " at " << &pd1[i] << " ";
    cout << pd2[i] << " at " << &pd2[i] << endl;
}
delete [] pd1;
delete [] pd3;
return 0;
}

```

---

Here is the output from the program in Listing 9.10 on one system:

Calling new and placement new:

Memory addresses:

heap: 006E4AB0 static: 00FD9138

Memory contents:

1000 at 006E4AB0; 1000 at 00FD9138  
 1020 at 006E4AB8; 1020 at 00FD9140  
 1040 at 006E4AC0; 1040 at 00FD9148  
 1060 at 006E4AC8; 1060 at 00FD9150  
 1080 at 006E4AD0; 1080 at 00FD9158

Calling new and placement new a second time:

Memory contents:

1000 at 006E4B68; 1000 at 00FD9138  
 1040 at 006E4B70; 1040 at 00FD9140  
 1080 at 006E4B78; 1080 at 00FD9148  
 1120 at 006E4B80; 1120 at 00FD9150  
 1160 at 006E4B88; 1160 at 00FD9158

Calling new and placement new a third time:

Memory contents:

1000 at 006E4AB0; 1000 at 00FD9160  
 1060 at 006E4AB8; 1060 at 00FD9168  
 1120 at 006E4AC0; 1120 at 00FD9170  
 1180 at 006E4AC8; 1180 at 00FD9178  
 1240 at 006E4AD0; 1240 at 00FD9180

## Program Notes

The first thing to note about Listing 9.10 is that placement new does, indeed, place the `p2` array in the `buffer` array; both `p2` and `buffer` have the value `00FD9138`. They are, however, of different types; `p1` is pointer-to-double, whereas `buffer` is pointer-to-char. (By the way, that's why the program uses a `(void *)` cast for `buffer`; otherwise, `cout` would try to display a string.) Meanwhile, regular `new` locates the `p1` array rather far away in memory, at location `006E4AB0`, which is part of the dynamically managed heap.

The second point to note is that the second call to regular `new` results in `new` finding a new block of memory—one beginning at `006E4B68`. But the second call to placement `new` results in the same block of memory being used as before—that is, the block beginning at `00FD9138`. The important fact here is that placement `new` simply uses the address that is passed to it; it doesn't keep track of whether that location has already been used, and it doesn't search the block for unused memory. This shifts some of the burden of memory management to the programmer. For example, the third call to placement `new` provides an offset into the `buffer` array so that new memory is used:

```
pd2 = new (buffer + N * sizeof(double)) double[N]; // offset of 40 bytes
```



The third point has to do with the use and nonuse of `delete`. For regular `new`, the following statement frees up the block of memory beginning at `006E4AB0`, and as a result, the next call to `new` is able to reuse that block:

```
delete [] pd1;
```

In contrast, the program in Listing 9.10 does not use `delete` to free the memory used by placement `new`. In fact, in this case, it can't. The memory specified by `buffer` is static memory, and `delete` can be used only with a pointer to heap memory allocated by regular `new`. That is, the `buffer` array is outside the jurisdiction of `delete`, and the following statement will produce a runtime error:

```
delete [] pd2; // won't work
```

On the other hand, if you use regular `new` to create a buffer in the first place, you use regular `delete` to free that entire block.

Another way you can use placement `new` is to combine it with `new` initialization to place information at a specific hardware address.

You may wonder exactly what the placement `new` function does. Basically, it does nothing other than return the address passed to it, type casting it to `void *` so that it can be assigned to any pointer type. But that's the default placement `new`. C++ allows programmers to overload placement `new`.

The situation becomes more involved when you use placement `new` with class objects. Chapter 12, "Classes and Dynamic Memory Allocation," continues this story.

### Other Forms of Placement `new`

Just as regular `new` invokes a new function with one argument, the standard placement `new` invokes a new function with two arguments:

```
int * p1 = new int;           // invokes new(sizeof(int))
int * p2 = new(buffer) int;   // invokes new(sizeof(int), buffer)
int * p3 = new(buffer) int[40]; // invokes new(40*sizeof(int), buffer)
```

The placement `new` function is not replaceable, but it can be overloaded. It needs at least two parameters, the first of which always is a `std::size_t` parameter designating the number of bytes requested. Any such overloaded function is termed a placement `new`, even if the additional parameters don't specify a location.

## Namespaces

Names in C++ can refer to variables, functions, structures, enumerations, classes, and class and structure members. When programming projects grow large, the potential for name conflicts increases. When you use class libraries from more than one source, you can get name conflicts. For example, two libraries might both define classes named `List`, `Tree`, and `Node`, but in incompatible ways. You might want the `List` class from one library and the `Tree` from the other, and each might expect its own version of `Node`. Such conflicts are termed *namespace problems*.

The C++ Standard provides namespace facilities to provide greater control over the scope of names. It took a while for compilers to incorporate namespaces, but, by now, support has become common.

## Traditional C++ Namespaces

Before looking at the new namespace facilities in C++, let's review the namespace properties that already exist in C++ and introduce some terminology. This can help make the idea of namespaces seem more familiar.

One term you need to be aware of is *declarative region*. A declarative region is a region in which declarations can be made. For example, you can declare a global variable outside any function. The declarative region for that variable is the file in which it is declared. If you declare a variable inside a function, its declarative region is the innermost block in which it is declared.

A second term you need to be aware of is *potential scope*. The potential scope for a variable begins at its point of declaration and extends to the end of its declarative region. So the potential scope is more limited than the declarative region because you can't use a variable above the point where it is first defined.

However, a variable might not be visible everywhere in its potential scope. For instance, it might be hidden by another variable of the same name declared in a nested declarative region. For example, a local variable declared in a function (for this variable, the declarative region is the function) hides a global variable declared in the same file (for this variable, the declarative region is the file). The portion of the program that can actually see the variable is termed the *scope*, which is the way we've been using the term all along. Figures 9.5 and 9.6 illustrate the terms *declarative region*, *potential scope*, and *scope*.

C++'s rules about global and local variables define a kind of namespace hierarchy. Each declarative region can declare names that are independent of names declared in other declarative regions. A local variable declared in one function doesn't conflict with a local variable declared in a second function.

## New Namespace Features

C++ now adds the ability to create named namespaces by defining a new kind of declarative region, one whose main purpose is to provide an area in which to declare names. The names in one namespace don't conflict with the same names declared in other namespaces, and there are mechanisms for letting other parts of a program use items declared in a namespace. The following code, for example, uses the new keyword `namespace` to create two namespaces, `Jack` and `Jill`:

```
namespace Jack {
    double pail;                // variable declaration
    void fetch();              // function prototype
    int pal;                    // variable declaration
    struct Well { ... };       // structure declaration
}
namespace Jill {
```

```

double bucket(double n) { ... } // function definition
double fetch;                // variable declaration
int pal;                      // variable declaration
struct Hill { ... };        // structure declaration
}

```

Namespaces can be located at the global level or inside other namespaces, but they cannot be placed in a block. Thus, a name declared in a namespace has external linkage by default (unless it refers to a constant).

In addition to user-defined namespaces, there is one more namespace, the *global namespace*. This corresponds to the file-level declarative region, so what used to be termed *global variables* are now described as being part of the global namespace.

The names in any one namespace don't conflict with names in another namespace. Thus, the `fetch` in `Jack` can coexist with the `fetch` in `Jill`, and the `Hill` in `Jill` can coexist with an external `Hill`. The rules governing declarations and definitions in a namespace are the same as the rules for global declarations and definitions.

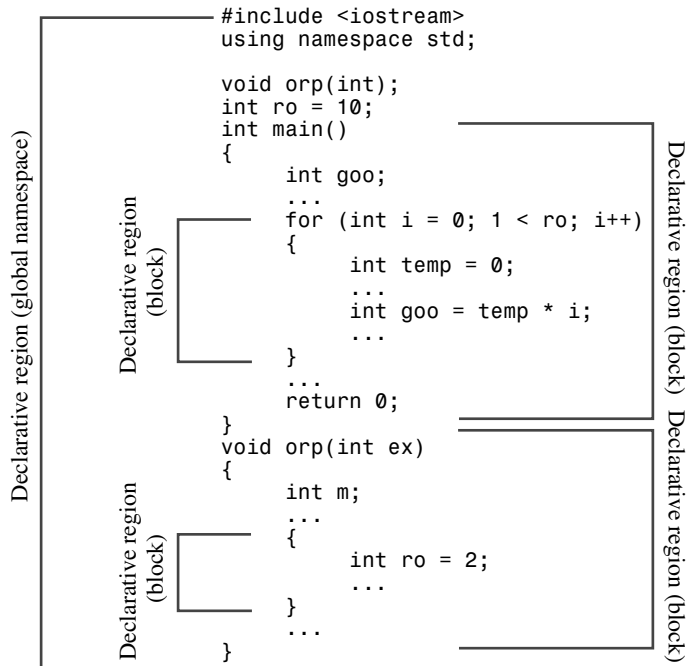

Figure 9.5 Declarative regions.

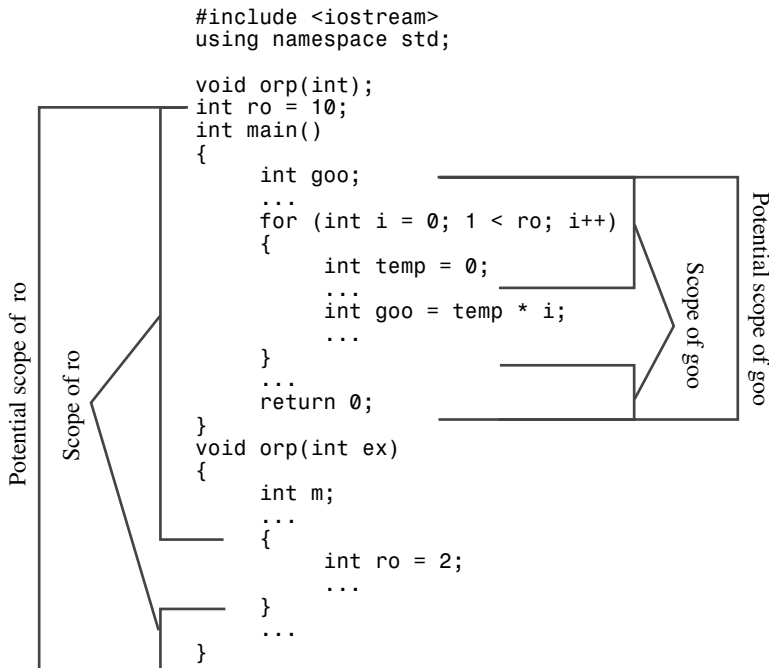

Figure 9.6 Potential scope and scope.

Namespaces are *open*, meaning that you can add names to existing namespaces. For example, the following statement adds the name `goose` to the existing list of names in `Jill`:

```

namespace Jill {
    char * goose(const char *);
}

```

Similarly, the original `Jack` namespace provides a prototype for a `fetch()` function. You can provide the code for the function later in the file (or in another file) by using the `Jack` namespace again:

```

namespace Jack {
    void fetch()
    {
        ...
    }
}

```

Of course, you need a way to access names in a given namespace. The simplest way is to use `::`, the scope-resolution operator, to *qualify* a name with its namespace:

```
Jack::pail = 12.34; // use a variable
Jill::Hill mole;   // create a type Hill structure
Jack::fetch();    // use a function
```

An unadorned name, such as `pail`, is termed the *unqualified name*, whereas a name with the namespace, as in `Jack::pail`, is termed a *qualified name*.

### using Declarations and using Directives

Having to qualify names every time they are used is not always an appealing prospect, so C++ provides two mechanisms—the *using declaration* and the *using directive*—to simplify using namespace names. The *using declaration* lets you make particular identifiers available, and the *using directive* makes the entire namespace accessible.

The *using declaration* involves preceding a qualified name with the keyword `using`:

```
using Jill::fetch; // a using declaration
```

A *using declaration* adds a particular name to the declarative region in which it occurs. For example, the *using declaration* of `Jill::fetch` in `main()` adds `fetch` to the declarative region defined by `main()`. After making this declaration, you can use the name `fetch` instead of `Jill::fetch`. The following code fragment illustrates these points:

```
namespace Jill {
    double bucket(double n) { ... }
    double fetch;
    struct Hill { ... };
}
char fetch;
int main()
{
    using Jill::fetch; // put fetch into local namespace
    double fetch;     // Error! Already have a local fetch
    cin >> fetch;     // read a value into Jill::fetch
    cin >> ::fetch;   // read a value into global fetch
    ...
}
```

Because a *using declaration* adds the name to the local declarative region, this example precludes creating another local variable by the name of `fetch`. Also like any other local variable, `fetch` would override a global variable by the same name.

Placing a *using declaration* at the external level adds the name to the global namespace:

```
void other();
namespace Jill {
    double bucket(double n) { ... }
    double fetch;
    struct Hill { ... };
}
```

```

}
using Jill::fetch; // put fetch into global namespace
int main()
{
    cin >> fetch; // read a value into Jill::fetch
    other()
    ...
}

void other()
{
    cout << fetch; // display Jill::fetch
    ...
}

```

A `using` declaration, then, makes a single name available. In contrast, the `using` directive makes *all* the names available. A `using` directive involves preceding a namespace name with the keywords `using namespace`, and it makes all the names in the namespace available without the use of the scope-resolution operator:

```
using namespace Jack; // make all the names in Jack available
```

Placing a `using` directive at the global level makes the namespace names available globally. You've seen this in action a few times in this book in the following form:

```
#include <iostream> // places names in namespace std
using namespace std; // make names available globally
```

Placing a `using` directive in a particular function makes the names available just in that function. Here's an example:

```
int main()
{
    using namespace jack; // make names available in vorn()
    ...
}

```

You've seen this form often in this book with the `std` namespace.

One thing to keep in mind about `using` directives and `using` declarations is that they increase the possibility of name conflicts. That is, if you have both namespace `jack` and namespace `jill` available, and you use the scope-resolution operator, there is no ambiguity:

```
jack::pal = 3;
jill::pal = 10;
```

The variables `jack::pal` and `jill::pal` are distinct identifiers for distinct memory locations. However, if you employ `using` declarations, the situation changes:

```
using jack::pal;
using jill::pal;
pal = 4; // which one? now have a conflict
```

In fact, the compiler won't let you use both of these `using` declarations because of the ambiguity that would be created.

### using Directives Versus using Declarations

Using a `using` directive to import all the names from a namespace wholesale is *not* the same as using multiple `using` declarations. It's more like the mass application of a scope-resolution operator. When you use a `using` declaration, it is as if the name is declared at the location of the `using` declaration. If a particular name is already declared in a function, you can't import the same name with a `using` declaration. When you use a `using` directive, however, name resolution takes place as if you declared the names in the smallest declarative region containing both the `using` declaration and the namespace itself. For the following example, that would be the global namespace. If you use a `using` directive to import a name that is already declared in a function, the local name will hide the namespace name, just as it would hide a global variable of the same name. However, you can still use the scope-resolution operator, as in the following example:

```
namespace Jill {
    double bucket(double n) { ... }
    double fetch;
    struct Hill { ... };
}
char fetch; // global namespace
int main()
{
    using namespace Jill; // import all namespace names
    Hill Thrill; // create a type Jill::Hill structure
    double water = bucket(2); // use Jill::bucket();
    double fetch; // not an error; hides Jill::fetch
    cin >> fetch; // read a value into the local fetch
    cin >> ::fetch; // read a value into global fetch
    cin >> Jill::fetch; // read a value into Jill::fetch
    ...
}

int foom()
{
    Hill top; // ERROR
    Jill::Hill crest; // valid
}
```

Here, in `main()`, the name `Jill::fetch` is placed in the local namespace. It doesn't have local scope, so it doesn't override the global `fetch`. But the locally declared `fetch` hides both `Jill::fetch` and the global `fetch`. However, both of the last two `fetch` variables are available if you use the scope-resolution operator. You might want to compare this example to the preceding one, which uses a `using` declaration.

One other point of note is that although a `using` directive in a function treats the namespace names as being declared outside the function, it doesn't make those names available to other functions in the file. Hence in the preceding example, the `foom()` function can't use the unqualified `hill` identifier.

### Note

Suppose a namespace and a declarative region both define the same name. If you attempt to use a `using` declaration to bring the namespace name into the declarative region, the two names conflict, and you get an error. If you use a `using` directive to bring the namespace name into the declarative region, the local version of the name hides the namespace version.

Generally speaking, the `using` declaration is safer to use than a `using` directive because it shows exactly what names you are making available. And if the name conflicts with a local name, the compiler lets you know. The `using` directive adds all names, even ones you might not need. If a local name conflicts, it overrides the namespace version, and you aren't warned. Also the open nature of namespaces means that the complete list of names in a namespace might be spread over several locations, making it difficult to know exactly which names you are adding.

This is the approach used for most of this book's examples:

```
#include <iostream>
int main()
{
    using namespace std;
```

First, the `iostream` header file puts everything in the `std` namespace. Then, the `using` directive makes the names available within `main()`. Some examples do this instead:

```
#include <iostream>
using namespace std;
int main()
{
```

This exports everything from the `std` namespace into the global namespace. The main rationale for this approach is expediency. It's easy to do, and if your system doesn't have namespaces, you can replace the first two of the preceding code lines with the original form:

```
#include <iostream.h>
```

However, namespace proponents hope that you will be more selective and use either the scope-resolution operator or the `using` declaration. That is, you shouldn't use the following:

```
using namespace std; // avoid as too indiscriminate
```



Instead, you should use this:

```
int x;
std::cin >> x;
std::cout << x << std::endl;
```

Or you could use this:

```
using std::cin;
using std::cout;
using std::endl;
int x;
cin >> x;
cout << x << endl;
```

You can use nested namespaces, as described in the following section, to create a namespace that holds the `using` declarations you commonly use.

### More Namespace Features

You can nest namespace declarations, like this:

```
namespace elements
{
    namespace fire
    {
        int flame;
        ...
    }
    float water;
}
```

In this case, you refer to the `flame` variable as `elements::fire::flame`. Similarly, you can make the inner names available with this `using` directive:

```
using namespace elements::fire;
```

Also you can use `using` directives and `using` declarations inside namespaces, like this:

```
namespace myth
{
    using Jill::fetch;
    using namespace elements;
    using std::cout;
    using std::cin;
}
```

Suppose you want to access `Jill::fetch`. Because `Jill::fetch` is now part of the `myth` namespace, where it can be called `fetch`, you can access it this way:

```
std::cin >> myth::fetch;
```

Of course, because it is also part of the `Jill` namespace, you still can call it `Jill::fetch`:

```
std::cout << Jill::fetch; // display value read into myth::fetch
```

Or you can do this, provided that no local variables conflict:

```
using namespace myth;
cin >> fetch; // really std::cin and Jill::fetch
```

Now consider applying a `using` directive to the `myth` namespace. The `using` directive is *transitive*. We say that an operation *op* is transitive if  $A \text{ op } B$  and  $B \text{ op } C$  implies  $A \text{ op } C$ . For example, the `>` operator is transitive. (That is,  $A$  bigger than  $B$  and  $B$  bigger than  $C$  implies  $A$  bigger than  $C$ .) In this context, the upshot is that the following statement places both the `myth` and the `elements` namespaces in scope:

```
using namespace myth;
```

This single directive has the same effect as the following two directives:

```
using namespace myth;
using namespace elements;
```

You can create an alias for a namespace. For example, suppose you have a namespace defined as follows:

```
namespace my_very_favorite_things { ... };
```

You can make `mvft` an alias for `my_very_favorite_things` by using the following statement:

```
namespace mvft = my_very_favorite_things;
```

You can use this technique to simplify using nested namespaces:

```
namespace MEF = myth::elements::fire;
using MEF::flame;
```

## Unnamed Namespaces

You can create an *unnamed namespace* by omitting the namespace name:

```
namespace // unnamed namespace
{
    int ice;
    int bandycoot;
}
```

This code behaves as if it were followed by a `using` directive; that is, the names declared in this namespace are in potential scope until the end of the declarative region that contains the unnamed namespace. In this respect, names in an unnamed namespace are like global variables. However, if a namespace has no name, you can't explicitly use a `using` directive or `using` declaration to make the names available elsewhere. In particular,

you can't use names from an unnamed namespace in a file other than the one that contains the namespace declaration. This provides an alternative to using static variables with internal linkage. Suppose, for example, you have this code:

```
static int counts; // static storage, internal linkage
int other();
int main()
{
    ...
}

int other()
{
    ...
}
```

The namespace approach is to do this instead:

```
namespace
{
    int counts; // static storage, internal linkage
}
int other();
int main()
{
    ...
}

int other()
{
    ...
}
```

## A Namespace Example

Let's take a look at a multifile example that demonstrates some of the features of namespaces. The first file in this example (see Listing 9.11) is a header file that contains some items normally found in header files—constants, structure definitions, and function prototypes. In this case, the items are placed in two namespaces. The first namespace, `pers`, contains a definition of a `Person` structure, plus prototypes for a function that fills a structure with a person's name and a function that displays the structure's contents. The second namespace, `debts`, defines a structure for storing the name of a person and the amount of money owed to that person. This structure uses the `Person` structure, so the `debts` namespace has a `using` directive to make the names in the `pers` namespace available in the `debts` namespace. The `debts` namespace also contains some prototypes.

**Listing 9.11 namesp.h.**

---

```
// namesp.h
#include <string>
// create the pers and debts namespaces
namespace pers
{
    struct Person
    {
        std::string fname;
        std::string lname;
    };
    void getPerson(Person &);
    void showPerson(const Person &);
}

namespace debts
{
    using namespace pers;
    struct Debt
    {
        Person name;
        double amount;
    };
    void getDebt(Debt &);
    void showDebt(const Debt &);
    double sumDebts(const Debt ar[], int n);
}
```

---

The second file in this example (see Listing 9.12) follows the usual pattern of having a source code file provide definitions for functions prototyped in a header file. The function names, which are declared in a namespace, have namespace scope, so the definitions need to be in the same namespace as the declarations. This is where the open nature of namespaces comes in handy. The original namespaces are brought in by including `namesp.h` (refer to Listing 9.11). The file then adds the function definitions to the two namespaces, as shown in Listing 9.12. Also the `namesp.cpp` file illustrates bringing in elements of the `std` namespace with the `using` declaration and the scope-resolution operator.

**Listing 9.12 namesp.cpp**

---

```
// namesp.cpp -- namespaces
#include <iostream>
#include "namesp.h"

namespace pers
{
```

```

using std::cout;
using std::cin;
void getPerson(Person & rp)
{
    cout << "Enter first name: ";
    cin >> rp.fname;
    cout << "Enter last name: ";
    cin >> rp.lname;
}
void showPerson(const Person & rp)
{
    std::cout << rp.lname << ", " << rp.fname;
}
}

namespace debts
{
    void getDebt(Debt & rd)
    {
        getPerson(rd.name);
        std::cout << "Enter debt: ";
        std::cin >> rd.amount;
    }
    void showDebt(const Debt & rd)
    {
        showPerson(rd.name);
        std::cout << ": $" << rd.amount << std::endl;
    }
    double sumDebts(const Debt ar[], int n)
    {
        double total = 0;
        for (int i = 0; i < n; i++)
            total += ar[i].amount;
        return total;
    }
}
}

```

---

Finally, the third file of this program (see Listing 9.13) is a source code file that uses the structures and functions declared and defined in the namespaces. Listing 9.13 shows several methods of making the namespace identifiers available.

#### Listing 9.13 `usenmsp.cpp`

---

```

// usenmsp.cpp -- using namespaces
#include <iostream>
#include "namesp.h"

```

```
void other(void);
void another(void);
int main(void)
{
    using debts::Debt;

    using debts::showDebt;
    Debt golf = { {"Benny", "Goatsniff"}, 120.0 };
    showDebt(golf);
    other();
    another();
    return 0;
}

void other(void)
{
    using std::cout;
    using std::endl;
    using namespace debts;
    Person dg = {"Doodles", "Glister"};
    showPerson(dg);
    cout << endl;
    Debt zippy[3];
    int i;
    for (i = 0; i < 3; i++)
        getDebt(zippy[i]);

    for (i = 0; i < 3; i++)
        showDebt(zippy[i]);
    cout << "Total debt: $" << sumDebts(zippy, 3) << endl;
    return;
}

void another(void)
{
    using pers::Person;
    Person collector = { "Milo", "Rightshift" };
    pers::showPerson(collector);
    std::cout << std::endl;
}
```

---

In Listing 9.13, `main()` begins by using two `using` declarations:

```
using debts::Debt;           // makes the Debt structure definition available
using debts::showDebt;      // makes the showDebt function available
```

Note that `using` declarations just use the name; for example, the second example here doesn't describe the return type or function signature for `showDebt`; it just gives the name. (Thus, if a function were overloaded, a single `using` declaration would import all the versions.) Also although both `Debt` and `showDebt()` use the `Person` type, it isn't necessary to import any of the `Person` names because the `debt` namespace already has a `using` directive that includes the `pers` namespace.

Next, the `other()` function takes the less desirable approach of importing the entire namespace with a `using` directive:

```
using namespace debts; // make all debts and pers names available to other()
```

Because the `using` directive in `debts` imports the `pers` namespace, the `other()` function can use the `Person` type and the `showPerson()` function.

Finally, the `another()` function uses a `using` declaration and the scope-resolution operator to access specific names:

```
using pers::Person;;
pers::showPerson(collector);
```

Here is a sample run of the program built from Listings 9.11, 9.12, and 9.13:

```
Goatsniff, Benny: $120
Glistner, Doodles
Enter first name: Arabella
Enter last name: Binx
Enter debt: 100
Enter first name: Cleve
Enter last name: Delaproux
Enter debt: 120
Enter first name: Eddie
Enter last name: Flotox
Enter debt: 200
Binx, Arabella: $100
Delaproux, Cleve: $120
Flotox, Eddie: $200
Total debt: $420
Rightshift, Milo
```

## Namespaces and the Future

As programmers become more familiar with namespaces, common programming idioms will emerge. Here are some current guidelines:

- Use variables in a named namespace instead of using external global variables.
- Use variables in an unnamed namespace instead of using static global variables.
- If you develop a library of functions or classes, place them in a namespace. Indeed, C++ currently already calls for placing standard library functions in a namespace

called `std`. This extends to functions brought in from C. For example, the `math.c` header file, which is C-compatible, doesn't use namespaces, but the C++ `cmath` header file should place the various math library functions in the `std` namespace.

- Use the `using` directive only as a temporary means of converting old code to namespace usage.
- Don't use `using` directives in header files; for one thing, doing so conceals which names are being made available. Also the ordering of header files may affect behavior. If you use a `using` directive, place it after all the preprocessor `#include` directives.
- Preferentially import names by using the scope-resolution operator or a `using` declaration.
- Preferentially use local scope instead of global scope for `using` declarations.

Bear in mind that the main motivation for using namespaces is to simplify management of large programming projects. For simple, one-file programs, using a `using` directive is no great sin.

As mentioned earlier, changes in the header filenames reflect namespace changes. The older-style header files, such as `iostream.h`, do not use namespaces, but the newer `iostream` header file should use the `std` namespace.

## Summary

C++ encourages the use of multiple files in developing programs. An effective organizational strategy is to use a header file to define user types and provide function prototypes for functions to manipulate the user types. You should use a separate source code file for the function definitions. Together, the header file and the source file define and implement the user-defined type and how it can be used. Then, `main()` and other functions using those functions can go into a third file.

C++'s storage schemes determine how long variables remain in memory (storage duration) and what parts of a program have access to them (scope and linkage). Automatic variables are variables that are defined within a block, such as a function body or a block within the body. They exist and are known only while the program executes statements in the block that contains the definition. Automatic variables may be declared by using the storage class specifier `register` or with no specifier at all, in which case the variable is automatically automatic. The `register` specifier was a hint to the compiler that the variable is heavily used, but that use is deprecated under C++11.

Static variables exist for the duration of a program. A variable defined outside any function is known to all functions in the file following its definition (file scope) and is made available to other files in the program (external linkage). For another file to use such a variable, that file must declare it by using the `extern` keyword. A variable that is shared across files should have a defining declaration in one file (`extern` needn't be used but it can be used if combined with initialization) and reference declarations in the other



files (`extern` is used with no initialization.). A variable defined outside any function but qualified with the keyword `static` has file scope but is not made available to other files (internal linkage). A variable defined inside a block but qualified with the keyword `static` is local to that block (local scope, no linkage) but retains its value for the duration of the program.

By default, C++ functions have external linkage, so they can be shared across files. But functions qualified with the keyword `static` have internal linkage and are confined to the defining file.

Dynamic memory allocation and deallocation, using `new` and `delete`, uses the free store, or heap, for data. The memory comes into use when `new` is called and is freed when `delete` is called. The program uses pointers to keep track of these memory locations.

Namespaces let you define named regions in which you can declare identifiers. The intent is to reduce name conflicts, particularly in large programs that use code from several vendors. You can make available identifiers in a namespace by using the scope-resolution operator, by using a `using` declaration, or by using a `using` directive.

## Chapter Review

1. What storage scheme would you use for the following situations?
  - a. `homer` is a formal argument (parameter) to a function.
  - b. The `secret` variable is to be shared by two files.
  - c. The `topsecret` variable is to be shared by the functions in one file but hidden from other files.
  - d. `beencalled` keeps track of how many times the function containing it has been called.
2. Describe the differences between a `using` declaration and a `using` directive.
3. Rewrite the following so that it doesn't use `using` declarations or `using` directives:

```
#include <iostream>
using namespace std;
int main()
{
    double x;
    cout << "Enter value: ";
    while (! (cin >> x) )
    {
        cout << "Bad input. Please enter a number: ";
        cin.clear();
        while (cin.get() != '\n')
            continue;
    }
}
```

```
    }
    cout << "Value = " << x << endl;
    return 0;
}
```

4. Rewrite the following so that it uses using declarations instead of the using directive:

```
#include <iostream>
using namespace std;
int main()
{
    double x;
    cout << "Enter value: ";
    while (! (cin >> x) )
    {
        cout << "Bad input. Please enter a number: ";
        cin.clear();
        while (cin.get() != '\n')
            continue;
    }
    cout << "Value = " << x << endl;
    return 0;
}
```

5. Suppose you want the `average(3,6)` function to return an `int` average of the two `int` arguments when it is called in one file, and you want it to return a `double` average of the two `int` arguments when it is called in a second file in the same program. How could you set this up?
6. What will the following two-file program display?

```
// file1.cpp
#include <iostream>
using namespace std;
void other();
void another();
int x = 10;
int y;

int main()
{
    cout << x << endl;
    {
        int x = 4;
        cout << x << endl;
        cout << y << endl;
    }
}
```

```
    }
    other();
    another();
    return 0;
}

void other()
{
    int y = 1;
    cout << "Other: " << x << ", " << y << endl;
}

// file 2.cpp
#include <iostream>
using namespace std;
extern int x;
namespace
{
    int y = -4;
}

void another()
{
    cout << "another(): " << x << ", " << y << endl;
}
```

7. What will the following program display?

```
#include <iostream>
using namespace std;
void other();
namespace n1
{
    int x = 1;
}

namespace n2
{
    int x = 2;
}

int main()
{
    using namespace n1;
    cout << x << endl;
    {
```

```
        int x = 4;
        cout << x << ", " << n1::x << ", " << n2::x << endl;
    }
    using n2::x;
    cout << x << endl;
    other();
    return 0;
}

void other()
{
    using namespace n2;
    cout << x << endl;
    {
        int x = 4;
        cout << x << ", " << n1::x << ", " << n2::x << endl;
    }
    using n2::x;
    cout << x << endl;
}
```

## Programming Exercises

1. Here is a header file:

```
// golf.h -- for pe9-1.cpp

const int Len = 40;
struct golf
{
    char fullname[Len];
    int handicap;
};

// non-interactive version:
// function sets golf structure to provided name, handicap
// using values passed as arguments to the function
void setgolf(golf & g, const char * name, int hc);

// interactive version:
// function solicits name and handicap from user
// and sets the members of g to the values entered
// returns 1 if name is entered, 0 if name is empty string
int setgolf(golf & g);
```

```
// function resets handicap to new value
void handicap(golf & g, int hc);

// function displays contents of golf structure
void showgolf(const golf & g);
```

Note that `setgolf()` is overloaded. Using the first version of `setgolf()` would look like this:

```
golf ann;
setgolf(ann, "Ann Birdfree", 24);
```

The function call provides the information that's stored in the `ann` structure. Using the second version of `setgolf()` would look like this:

```
golf andy;
setgolf(andy);
```

The function would prompt the user to enter the name and handicap and store them in the `andy` structure. This function could (but doesn't need to) use the first version internally.

Put together a multifile program based on this header. One file, named `golf.cpp`, should provide suitable function definitions to match the prototypes in the header file. A second file should contain `main()` and demonstrate all the features of the prototyped functions. For example, a loop should solicit input for an array of golf structures and terminate when the array is full or the user enters an empty string for the golfer's name. The `main()` function should use only the prototyped functions to access the golf structures.

2. Redo Listing 9.9, replacing the character array with a `string` object. The program should no longer have to check whether the input string fits, and it can compare the input string to `" "` to check for an empty line.
3. Begin with the following structure declaration:

```
struct chaff
{
    char dross[20];
    int slag;
};
```

Write a program that uses placement `new` to place an array of two such structures in a buffer. Then assign values to the structure members (remembering to use `strcpy()` for the `char` array) and use a loop to display the contents. Option 1 is to use a static array, like that in Listing 9.10, for the buffer. Option 2 is to use regular `new` to allocate the buffer.

4. Write a three-file program based on the following namespace:

```
namespace SALES
{
    const int QUARTERS = 4;
    struct Sales
    {
        double sales[QUARTERS];
        double average;
        double max;
        double min;
    };
    // copies the lesser of 4 or n items from the array ar
    // to the sales member of s and computes and stores the
    // average, maximum, and minimum values of the entered items;
    // remaining elements of sales, if any, set to 0
    void setSales(Sales & s, const double ar[], int n);
    // gathers sales for 4 quarters interactively, stores them
    // in the sales member of s and computes and stores the
    // average, maximum, and minimum values
    void setSales(Sales & s);
    // display all information in structure s
    void showSales(const Sales & s);
}
```

The first file should be a header file that contains the namespace. The second file should be a source code file that extends the namespace to provide definitions for the three prototyped functions. The third file should declare two `Sales` objects. It should use the interactive version of `setSales()` to provide values for one structure and the non-interactive version of `setSales()` to provide values for the second structure. It should display the contents of both structures by using `showSales()`.

*This page intentionally left blank*

# Objects and Classes

In this chapter you'll learn about the following:

- Procedural and object-oriented programming
- The concept of classes
- How to define and implement a class
- Public and private class access
- Class data members
- Class methods (also called class function members)
- Creating and using class objects
- Class constructors and destructors
- `const` member functions
- The `this` pointer
- Creating arrays of objects
- Class scope
- Abstract data types

Object-oriented programming (OOP) is a particular conceptual approach to designing programs, and C++ has enhanced C with features that ease the way to applying that approach. The following are the most important OOP features:

- Abstraction
- Encapsulation and data hiding
- Polymorphism
- Inheritance
- Reusability of code



The class is the single most important C++ enhancement for implementing these features and tying them together. This chapter begins an examination of classes. It explains abstraction, encapsulation, and data hiding, and shows how classes implement these features. It discusses how to define a class, provide a class with public and private sections, and create member functions that work with the class data. Also this chapter acquaints you with constructors and destructors, which are special member functions for creating and disposing of objects that belong to a class. Finally, you meet the `this` pointer, an important component of some class programming. The following chapters extend this discussion to operator overloading (another variety of polymorphism) and inheritance, the basis for reusing code.

## Procedural and Object-Oriented Programming

Although in this book we have occasionally explored the OOP perspective on programming, we've usually stuck pretty close to the standard procedural approach of languages such as C, Pascal, and BASIC. Let's look at an example that clarifies how the OOP outlook differs from that of procedural programming.

As the newest member of the Genre Giants softball team, you've been asked to keep the team statistics. Naturally, you turn to your computer for help. If you were a procedural programmer, you might think along these lines:

Let's see, I want to enter the name, times at bat, number of hits, batting averages (for those who don't follow baseball or softball, the batting average is the number of hits divided by the player's official number of times at bat; an at bat terminates when a player gets on base or makes an out, but certain events, such as getting a walk, don't count as official times at bat), and all those other great basic statistics for each player. Wait, the computer is supposed to make life easier for me, so I want to have it figure out some of that stuff, such as the batting average. Also I want the program to report the results. How should I organize this? I guess I should do things right and use functions. Yeah, I'll make `main()` call a function to get the input, call another function to make the calculations, and then call a third function to report the results. Hmm, what happens when I get data from the next game? I don't want to start from scratch again. Okay, I can add a function to update the statistics. Golly, maybe I'll need a menu in `main()` to select between entering, calculating, updating, and showing the data. Hmm...how am I going to represent the data? I could use an array of strings to hold the players' names, another array to hold the at bats for each player, yet another array to hold the hits, and so on. No, that's dumb. I can design a structure to hold all the information for a single player and then use an array of those structures to represent the whole team.

In short, with a procedural approach, you first concentrate on the procedures you will follow and then think about how to represent the data. (So that you don't have to keep the program running the whole season, you probably also want to be able to save data to a file and read data from a file.)

Now let's see how your perspective changes when you don your OOP hat (in an attractive polymorphic design). You begin by thinking about the data. Furthermore, you think about the data not only in terms of how to represent it, but in terms of how it's to be used:

Let's see, what am I keeping track of? A ball player, of course. So I want an object that represents the whole player, not just her batting average or times at bat. Yeah, that'll be my fundamental data unit, an object representing the name and statistics for a player. I'll need some methods to handle this object. Hmm, I guess I need a method to get basic information into this unit. The computer should calculate some of the stuff, like the batting averages—I can add methods to do calculations. And the program should do those calculations automatically, without the user having to remember to ask to have them done. Also I'll need methods for updating and displaying the information. So the user gets three ways to interact with the data: initialization, updating, and reporting. That's the user interface.

In short, with an OOP approach, you concentrate on the object as the user perceives it, thinking about the data you need to describe the object and the operations that will describe the user's interaction with the data. After you develop a description of that interface, you move on to decide how to implement the interface and data storage. Finally, you put together a program to use your new design.

## Abstraction and Classes

Life is full of complexities, and one way we cope with complexity is to frame simplifying abstractions. You are a collection of more than an octillion atoms. Some students of the mind would say that your mind is a collection of several semiautonomous agents. But it's much simpler to think of yourself as a single entity. In computing, abstraction is the crucial step of representing information in terms of its interface with the user. That is, you abstract the essential operational features of a problem and express a solution in those terms. In the softball statistics example, the interface describes how the user initializes, updates, and displays the data. From abstraction, it is a short step to the user-defined type, which in C++ is a class design that implements the abstract interface.

### What Is a Type?

Let's think a little more about what constitutes a type. For example, what is a nerd? If you subscribe to the popular stereotype, you might think of a nerd in visual terms—thick, black-rimmed glasses, pocket protector full of pens, and so on. After a little reflection, you might conclude that a nerd is better defined operationally—for example, in terms of how he or she responds to an awkward social situation. You have a similar situation, if you don't mind stretched analogies, with a procedural language such as C. At first, you tend to think of a data type in terms of its appearance—how it is stored in memory. A `char`, for

example, is 1 byte of memory, and a `double` is often 8 bytes of memory. But a little reflection leads you to conclude that a data type is also defined in terms of the operations that can be performed on it. For example, the `int` type can use all the arithmetic operations. You can add, subtract, multiply, and divide integers. You can also use the modulus operator (`%`) with them.

On the other hand, consider pointers. A pointer might very well require the same amount of memory as an `int`. It might even be represented internally as an integer. But a pointer doesn't allow the same operations that an integer does. You can't, for example, multiply two pointers by each other. The concept makes no sense, so C++ doesn't implement it. Thus, when you declare a variable as an `int` or as a pointer-to-`float`, you're not just allocating memory—you are also establishing which operations can be performed with the variable. In short, specifying a basic type does three things:

- It determines how much memory is needed for a data object.
- It determines how the bits in memory are interpreted. (A `long` and a `float` might use the same number of bits in memory, but they are translated into numeric values differently.)
- It determines what operations, or methods, can be performed using the data object.

For built-in types, the information about operations is built in to the compiler. But when you define a user-defined type in C++, you have to provide the same kind of information yourself. In exchange for this extra work, you gain the power and flexibility to custom fit new data types to match real-world requirements.

## Classes in C++

A *class* is a C++ vehicle for translating an abstraction to a user-defined type. It combines data representation and methods for manipulating that data into one neat package. Let's look at a class that represents stocks.

First, you have to think a bit about how to represent stocks. You could take one share of stock as the basic unit and define a class to represent a share. However, that implies that you would need 100 objects to represent 100 shares, and that's not practical. Instead, you can represent a person's current holdings in a particular stock as a basic unit. The number of shares owned would be part of the data representation. A realistic approach would have to maintain records of such things as initial purchase price and date of purchase for tax purposes. Also it would have to manage events such as stock splits. That seems a bit ambitious for a first effort at defining a class, so you can instead take an idealized, simplified view of matters. In particular, you can limit the operations you can perform to the following:

- Acquire stock in a company.
- Buy more shares of the same stock.
- Sell stock.
- Update the per-share value of a stock.
- Display information about the holdings.

You can use this list to define the public interface for the stock class. (And you can add additional features later if you're interested.) To support this interface, you need to store some information. Again, you can use a simplified approach. For example, don't worry about the U.S. practice of evaluating stocks in multiples of eighths of a dollar. (Apparently the New York Stock Exchange must have seen this simplification in a previous edition of the book because it has decided to change over to the system used here.) Here's a list of information to store:

- Name of company
- Number of stocks owned
- Value of each share
- Total value of all shares

Next, you can define the class. Generally, a class specification has two parts:

- A *class declaration*, which describes the data component, in terms of data members, and the public interface, in terms of member functions, termed *methods*
- The *class method definitions*, which describe how certain class member functions are implemented

Roughly speaking, the class declaration provides a class overview, whereas the method definitions supply the details.

### What Is an Interface?

An *interface* is a shared framework for interactions between two systems—for instance, between a computer and a printer or between a user and a computer program. For example, the user might be you and the program might be a word processor. When you use the word processor, you don't transfer words directly from your mind to the computer memory. Instead, you interact with the interface provided by the program. You press a key, and the computer shows you a character on the screen. You move the mouse, and the computer moves a cursor on the screen. You click the mouse accidentally, and something weird happens to the paragraph you were typing. The program interface manages the conversion of your intentions to specific information stored in the computer.

For classes, we speak of the public interface. In this case, the public is the program using the class, the interacting system consists of the class objects, and the interface consists of the methods provided by whoever wrote the class. The interface enables you, the programmer, to write code that interacts with class objects, and thus it enables the program to use the class objects. For example, to find the number of characters in a `string` object, you don't open up the object to what is inside; you just use the `size()` method provided by the class creators. It turns out that the class design denies direct access to the public user. But the public is allowed to use the `size()` method. The `size()` method, then, is part of the public interface between the user and a `string` class object. Similarly, the `getline()` method is part of the `istream` class public interface; a program using `cin` doesn't tinker

directly with the innards of a `cin` object to read a line of input; instead, `getline()` does the work.

If you want a more personal relationship, instead of thinking of the program using a class as the public user, you can think of the person writing the program using the class as the public user. But in any case, to use a class, you need to know its public interface; to write a class, you need to create its public interface.

Developing a class and a program using it requires several steps. Rather than take them all at once, let's break up the development into smaller stages. Typically, C++ programmers place the interface, in the form of a class definition, in a header file and place the implementation, in the form of code for the class methods, in a source code file. So let's be typical. Listing 10.1 presents the first stage, a tentative class declaration for a class called `Stock`. The file uses `#ifndef`, and so on, as described in Chapter 9, "Memory Models and Namespaces," to protect against multiple file inclusions.

To help identify classes, this book follows a common, but not universal, convention of capitalizing class names. You'll notice that Listing 10.1 looks like a structure declaration with a few additional wrinkles, such as member functions and public and private sections. We'll improve on this declaration shortly (so don't use it as a model), but first let's see how this definition works.

---

#### Listing 10.1 `stock00.h`

---

```
// stock00.h -- Stock class interface
// version 00
#ifndef STOCK00_H_
#define STOCK00_H_

#include <string>

class Stock // class declaration
{
private:
    std::string company;
    long shares;
    double share_val;
    double total_val;
    void set_tot() { total_val = shares * share_val; }
public:
    void acquire(const std::string & co, long n, double pr);
    void buy(long num, double price);
    void sell(long num, double price);
    void update(double price);
    void show();
}; // note semicolon at the end

#endif
```

---

You'll get a closer look at the class details later, but first let's examine the more general features. To begin, the C++ keyword `class` identifies the code in Listing 10.1 as defining the design of a class. (In this context the keywords `class` and `typename` are not synonymous the way they were in template parameters; `typename` can't be used here.) The syntax identifies `Stock` as the type name for this new class. This declaration enables you to declare variables, called *objects*, or *instances*, of the `Stock` type. Each individual object represents a single holding. For example, the following declarations create two `Stock` objects called `sally` and `solly`:

```
Stock sally;  
Stock solly;
```

The `sally` object, for example, could represent Sally's stock holdings in a particular company.

Next, notice that the information you decided to store appears in the form of class data members, such as `company` and `shares`. The `company` member of `sally`, for example, holds the name of the company, the `share` member holds the number of shares Sally owns, the `share_val` member holds the value of each share, and the `total_val` member holds the total value of all the shares. Similarly, the desired operations appear as class function members (or methods), such as `sell()` and `update()`. A member function can be defined in place—for example, `set_tot()`—or it can be represented by a prototype, like the other member functions in this class. The full definitions for the other member functions come later in the implementation file, but the prototypes suffice to describe the function interfaces. The binding of data and methods into a single unit is the most striking feature of the class. Because of this design, creating a `Stock` object automatically establishes the rules governing how that object can be used.

You've already seen how the `istream` and `ostream` classes have member functions, such as `get()` and `getline()`. The function prototypes in the `Stock` class declaration demonstrate how member functions are established. The `istream` header file, for example, has a `getline()` prototype in the `istream` class declaration.

## Access Control

Also new are the keywords `private` and `public`. These labels describe *access control* for class members. Any program that uses an object of a particular class can access the public portions directly. A program can access the private members of an object *only* by using the public member functions (or, as you'll see in Chapter 11, "Working with Classes," via a friend function). For example, the only way to alter the `shares` member of the `Stock` class is to use one of the `Stock` member functions. Thus, the public member functions act as go-betweens between a program and an object's private members; they provide the interface between object and program. This insulation of data from direct access by a program is called *data hiding*. (C++ provides a third access-control keyword, *protected*, which we'll discuss when we cover class inheritance in Chapter 13, "Class Inheritance.") (See Figure 10.1.) Whereas data hiding may be an unscrupulous act in, say, a stock fund prospectus, it's a good practice in computing because it preserves the integrity of the data.

keyword `private` identifies class members that can be accessed only through the public member functions (data hiding)

keyword `class` identifies class definition

the class name becomes the name of this user-defined type

class members can be data types or functions

```
class Stock
{
private:
    char company[30];
    int shares;
    double share_val;
    double total_val;
    void set_tot() { total_val = shares * share_val; }
public:
    void acquire(const char * co, int n, double pr);
    void buy(int num, double price);
    void sell(int num, double price);
    void update(double price);
    void show();
};
```

keyword `public` identifies class members that constitute the public interface for the class (abstraction)

Figure 10.1 The `Stock` class.

A class design attempts to separate the public interface from the specifics of the implementation. The public interface represents the abstraction component of the design. Gathering the implementation details together and separating them from the abstraction is called *encapsulation*. *Data hiding* (putting data into the private section of a class) is an instance of encapsulation, and so is hiding functional details of an implementation in the private section, as the `Stock` class does with `set_tot()`. Another example of encapsulation is the usual practice of placing class function definitions in a separate file from the class declaration.

### OOP and C++

OOP is a programming style that you can use to some degree with any language. Certainly, you can incorporate many OOP ideas into ordinary C programs. For example, Chapter 9 provides an example (see Listings 9.1, 9.2, 9.3) in which a header file contains a structure prototype along with the prototypes for functions to manipulate that structure. The `main()` function simply defines variables of that structure type and uses the associated functions to handle those variables; `main()` does not directly access structure members. In essence, that example defines an abstract type that places the storage format and the function prototypes in a header file, hiding the actual data representation from `main()`.

C++ includes features specifically intended to implement the OOP approach, so it enables you to take the process a few steps further than you can with C. First, placing the data representation and the function prototypes into a single class declaration instead of keeping them separate unifies the description by placing everything in one class declaration. Second, making the data representation `private` enforces the stricture that data is accessed only by authorized functions. If in the C example `main()` directly accesses a structure member, it violates the spirit of OOP, but it doesn't break any C language rules. However, trying to directly access, say, the `shares` member of a `Stock` object does break a C++ language rule, and the compiler will catch it.

Note that data hiding not only prevents you from accessing data directly, but it also absolves you (in the roll as a user of the class) from needing to know how the data is represented. For example, the `show()` member displays, among other things, the total value of a holding. This value can be stored as part of an object, as the code in Listing 10.1 does, or it can be calculated when needed. From the standpoint of using the class, it makes no difference which approach is used. What you do need to know is what the different member functions accomplish; that is, you need to know what kinds of arguments a member function takes and what kind of return value it has. The principle is to separate the details of the implementation from the design of the interface. If you later find a better way to implement the data representation or the details of the member functions, you can change those details without changing the program interface, and that makes programs much easier to maintain.

### Member Access Control: Public or Private?

You can declare class members, whether they are data items or member functions, either in the `public` or the `private` section of a class. But because one of the main precepts of OOP is to hide the data, data items normally go into the `private` section. The member functions that constitute the class interface go into the `public` section; otherwise, you can't call those functions from a program. As the `Stock` declaration shows, you can also put member functions in the `private` section. You can't call such functions directly from a program, but the `public` methods can use them. Typically, you use `private` member functions to handle implementation details that don't form part of the `public` interface.

You don't have to use the keyword `private` in class declarations because that is the default access control for class objects:

```
class World
{
    float mass;           // private by default
    char name[20];       // private by default
public:
    void tellall(void);
    ...
};
```

However, this book explicitly uses the `private` label in order to emphasize the concept of data hiding.



### Classes and Structures

Class descriptions look much like structure declarations with the addition of member functions and the `public` and `private` visibility labels. In fact, C++ extends to structures the same features classes have. The only difference is that the default access type for a structure is `public`, whereas the default type for a class is `private`. C++ programmers commonly use classes to implement class descriptions while restricting structures to representing pure data objects (often called *plain-old data* structures, or *POD* structures).

## Implementing Class Member Functions

We still have to create the second part of the class specification: providing code for those member functions represented by a prototype in the class declaration. Member function definitions are much like regular function definitions. Each has a function header and a function body. Member function definitions can have return types and arguments. But they also have two special characteristics:

- When you define a member function, you use the scope-resolution operator (`::`) to identify the class to which the function belongs.
- Class methods can access the `private` components of the class.

Let's look at these points now.

First, the function header for a member function uses the scope-resolution operator (`::`) to indicate to which class the function belongs. For example, the header for the `update()` member function looks like this:

```
void Stock::update(double price)
```

This notation means you are defining the `update()` function that is a member of the `Stock` class. Not only does this identify `update()` as a member function, it means you can use the same name for a member function for a different class. For example, an `update()` function for a `Buffoon` class would have this function header:

```
void Buffoon::update()
```

Thus, the scope-resolution operator resolves the identity of the class to which a method definition applies. We say that the identifier `update()` has *class scope*. Other member functions of the `Stock` class can, if necessary, use the `update()` method without using the scope-resolution operator. That's because they belong to the same class, making `update()` in scope. Using `update()` outside the class declaration and method definitions, however, requires special measures, which we'll get to soon.

One way of looking at method names is that the complete name of a class method includes the class name. `Stock::update()` is called the *qualified name* of the function. A simple `update()`, on the other hand, is an abbreviation (the *unqualified name*) for the full name—one that can be used just in class scope.

The second special characteristic of methods is that a method can access the private members of a class. For example, the `show()` method can use code like this:

```
std::cout << "Company: " << company
          << " Shares: " << shares << endl
          << " Share Price: $" << share_val
          << " Total Worth: $" << total_val << endl;
```

Here `company`, `shares`, and so on are private data members of the `Stock` class. If you try to use a nonmember function to access these data members, the compiler stops you cold in your tracks. (However, friend functions, which Chapter 11 discusses, provide an exception.)

With these two points in mind, we can implement the class methods as shown in Listing 10.2. We've placed them in a separate implementation file, so the file needs to include the `stock00.h` header file so that compiler can access the class definition. To provide more namespace experience, the code uses the `std::` qualifier in some methods and using declarations in others.

### Listing 10.2 `stock00.cpp`

---

```
// stock00.cpp -- implementing the Stock class
// version 00
#include <iostream>
#include "stock00.h"

void Stock::acquire(const std::string & co, long n, double pr)
{
    company = co;
    if (n < 0)
    {
        std::cout << "Number of shares can't be negative; "
                  << company << " shares set to 0.\n";
        shares = 0;
    }
    else
        shares = n;
    share_val = pr;
    set_tot();
}

void Stock::buy(long num, double price)
{
    if (num < 0)
    {
        std::cout << "Number of shares purchased can't be negative. "
                  << "Transaction is aborted.\n";
    }
    else
    {
        shares += num;
    }
}
```

```

        share_val = price;
        set_tot();
    }
}

void Stock::sell(long num, double price)
{
    using std::cout;
    if (num < 0)
    {
        cout << "Number of shares sold can't be negative. "
              << "Transaction is aborted.\n";
    }
    else if (num > shares)
    {
        cout << "You can't sell more than you have! "
              << "Transaction is aborted.\n";
    }
    else
    {
        shares -= num;
        share_val = price;
        set_tot();
    }
}

void Stock::update(double price)
{
    share_val = price;
    set_tot();
}

void Stock::show()
{
    std::cout << "Company: " << company
              << " Shares: " << shares << '\n'
              << " Share Price: $" << share_val
              << " Total Worth: $" << total_val << '\n';
}

```

---

### Member Function Notes

The `acquire()` function manages the first acquisition of stock for a given company, whereas `buy()` and `sell()` manage adding to or subtracting from an existing holding. The `buy()` and `sell()` methods make sure that the number of shares bought or sold is not a negative number. Also if the user attempts to sell more shares than he or she has, the

`sell()` function terminates the transaction. The technique of making the data private and limiting access to public functions gives you control over how the data can be used; in this case, it allows you to insert these safeguards against faulty transactions.

Four of the member functions set or reset the `total_val` member value. Rather than write this calculation four times, the class has each function call the `set_tot()` function. Because this function is merely the means of implementing the code and not part of the public interface, the class makes `set_tot()` a private member function. (That is, `set_tot()` is a member function used by the person writing the class but not used by someone writing code that uses the class.) If the calculation were lengthy, this could save some typing and code space. Here, however, the main value is that by using a function call instead of retyping the calculation each time, you ensure that exactly the same calculation gets done. Also if you have to revise the calculation (which is not likely in this particular case), you have to revise it in just one location.

### Inline Methods

Any function with a definition in the class declaration automatically becomes an inline function. Thus, `Stock::set_tot()` is an inline function. Class declarations often use inline functions for short member functions, and `set_tot()` qualifies on that account.

You can, if you like, define a member function outside the class declaration and still make it inline. To do so, you just use the `inline` qualifier when you define the function in the class implementation section:

```
class Stock
{
private:
    ...
    void set_tot(); // definition kept separate
public:
    ...
};

inline void Stock::set_tot() // use inline in definition
{
    total_val = shares * share_val;
}
```

The special rules for inline functions require that they be defined in each file in which they are used. The easiest way to make sure that inline definitions are available to all files in a multifile program is to include the inline definition in the same header file in which the corresponding class is defined. (Some development systems may have smart linkers that allow the inline definitions to go into a separate implementation file.)

Incidentally, according to the *rewrite rule*, defining a method within a class declaration is equivalent to replacing the method definition with a prototype and then rewriting the definition as an inline function immediately after the class declaration. That is, the original

inline definition of `set_tot()` in Listing 10.1 is equivalent to the one just shown, with the definition following the class declaration.

### Which Object Does a Method Use?

Now we come to one of the most important aspects of using objects: how you apply a class method to an object. Code such as this uses the `shares` member of an object:

```
shares += num;
```

But which object? That's an excellent question! To answer it, first consider how you create an object. The simplest way is to declare class variables:

```
Stock kate, joe;
```

This creates two objects of the `Stock` class, one named `kate` and one named `joe`.

Next, consider how to use a member function with one of these objects. The answer, as with structures and structure members, is to use the membership operator:

```
kate.show();    // the kate object calls the member function
joe.show();    // the joe object calls the member function
```

The first call here invokes `show()` as a member of the `kate` object. This means the method interprets `shares` as `kate.shares` and `share_val` as `kate.share_val`. Similarly, the call `joe.show()` makes the `show()` method interpret `shares` and `share_val` as `joe.shares` and `joe.share_val`, respectively.

#### Note

When you call a member function, it uses the data members of the particular object used to invoke the member function.

Similarly, the function call `kate.sell()` invokes the `set_tot()` function as if it were `kate.set_tot()`, causing that function to get its data from the `kate` object.

Each new object you create contains storage for its own internal variables, the class members. But all objects of the same class share the same set of class methods, with just one copy of each method. Suppose, for example, that `kate` and `joe` are `Stock` objects. In that case, `kate.shares` occupies one chunk of memory, and `joe.shares` occupies a second chunk of memory. But `kate.show()` and `joe.show()` both invoke the same method—that is, both execute the same block of code. They just apply the code to different data. Calling a member function is what some OOP languages term *sending a message*. Thus, sending the same message to two different objects invokes the same method but applies it to two different objects (see Figure 10.2).

## Using Classes

In this chapter you've seen how to define a class and its class methods. The next step is to produce a program that creates and uses objects of a class. The C++ goal is to make using classes as similar as possible to using the basic, built-in types, such as `int` and `char`. You can create a class object by declaring a class variable or using `new` to allocate an object of a

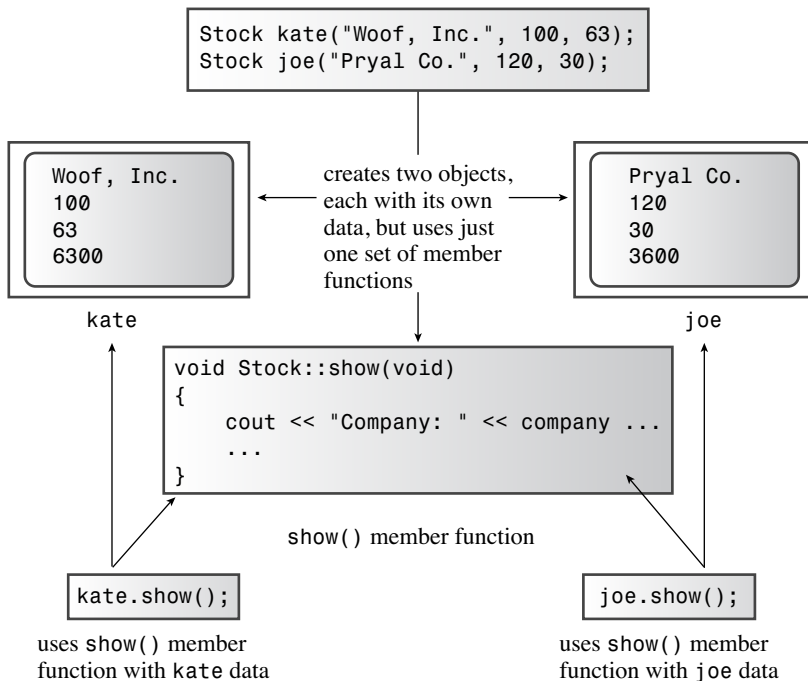

Figure 10.2 Objects, data, and member functions.

class type. You can pass objects as arguments, return them as function return values, and assign one object to another. C++ provides facilities for initializing objects, teaching `cin` and `cout` to recognize objects, and even providing automatic type conversions between objects of similar classes. It will be a while before you can do all those things, but let's start now with the simpler properties. Indeed, you've already seen how to declare a class object and call a member function. Listing 10.3 provides a program to use the interface and implementation files. It creates a `Stock` object named `fluffy_the_cat`. The program is simple, but it tests the features built in to the class. To compile the complete program, use the techniques for multifile programs described in Chapter 1, "Getting Started with C++," and in Chapter 9. In particular, compile it with `stock00.cpp` and have `stock00.h` present in the same directory or folder.

Listing 10.3 `usestok0.cpp`

```
// usestok0.cpp -- the client program
// compile with stock00.cpp
#include <iostream>
#include "stock00.h"
```

```

int main()
{
    Stock fluffy_the_cat;
    fluffy_the_cat.acquire("NanoSmart", 20, 12.50);
    fluffy_the_cat.show();
    fluffy_the_cat.buy(15, 18.125);
    fluffy_the_cat.show();
    fluffy_the_cat.sell(400, 20.00);
    fluffy_the_cat.show();
    fluffy_the_cat.buy(300000,40.125);
    fluffy_the_cat.show();
    fluffy_the_cat.sell(300000,0.125);
    fluffy_the_cat.show();
    return 0;
}

```

Here is the output of the program in Listing 10.3:

```

Company: NanoSmart  Shares: 20
  Share Price: $12.5  Total Worth: $250
Company: NanoSmart  Shares: 35
  Share Price: $18.125  Total Worth: $634.375
You can't sell more than you have! Transaction is aborted.
Company: NanoSmart  Shares: 35
  Share Price: $18.125  Total Worth: $634.375
Company: NanoSmart  Shares: 300035
  Share Price: $40.125  Total Worth: $1.20389e+007
Company: NanoSmart  Shares: 35
  Share Price: $0.125  Total Worth: $4.375

```

Note that `main()` is just a vehicle for testing the design of the `Stock` class. When the `Stock` class works as you want it to, you can use it as a user-defined type in other programs. The critical point in using the new type is to understand what the member functions do; you shouldn't have to think about the implementation details. See the following sidebar, "The Client/Server Model."

### The Client/Server Model

OOP programmers often discuss program design in terms of a client/server model. In this conceptualization, the *client* is a program that uses the class. The class declaration, including the class methods, constitute the *server*, which is a resource that is available to the programs that need it. The client uses the server through the publicly defined interface only. This means that the client's only responsibility, and, by extension, the client's programmer's only responsibility, is to know that interface. The server's responsibility, and, by extension, the server's designer's responsibility, is to see that the server reliably and accurately performs according to that interface. Any changes the server designer makes to the class design should be to details of implementation, not to the interface. This allows programmers to improve the client and the server independently of each other, without changes in the server having unforeseen repercussions on the client's behavior.

## Changing the Implementation

There may be something about the program output, aside from Fluffy the Cat’s lack of financial acumen, that bothers you—the somewhat inconsistent formatting of the numbers. Here’s an opportunity to refine an implementation while keeping the interface unchanged. The `ostream` class included member functions that control formatting. Without going into much detail, you can avoid e-notation by using the `setf()` method much as we did in Listing 8.8:

```
std::cout.setf(std::ios_base::fixed, std::ios_base::floatfield);
```

This sets a flag in the `cout` object instructing `cout` to use fixed-point notation. Similarly, the following statement causes `cout` to show three places to the right of the decimal when using fixed-point notation:

```
std::cout.precision(3);
```

You’ll find more details in Chapter 17, “Input, Output, and Files.”

These tools can be used in the `show()` method to control the formatting, but there is another point to consider. When you change the implementation for a method, the changes should not affect other parts of the client program. The format changes just mentioned stay in place until changed again, so they could affect subsequent output in the client program. Therefore, the polite thing for `show()` to do is to reset the formatting information to the state that existed before `show()` was called. This can be done, as in Listing 8.8, using return values for the setting statements:

```
std::streamsize prec =
    std::cout.precision(3); // save preceding value for precision
...
std::cout.precision(prec); // reset to old value

// store original flags
std::ios_base::fmtflags orig = std::cout.setf(std::ios_base::fixed);
...
// reset to stored values
std::cout.setf(orig, std::ios_base::floatfield);
```

As you may recall, `fmtflags` is a type defined in the `ios_base` class, which is defined in the `std` namespace, hence the rather long type name for `orig`. Second, `orig` holds all the flags, and the `reset` statement uses that information to reset information in the `floatfield` section, which includes flags for fixed-point notation and scientific notation. Third, let’s not worry too much about the details here. The main points are that the changes are confined to the implementation file and that the changes don’t affect other aspects of the program using the class.



Putting this information to use, we can replace the `show()` definition in the implementation file with this:

```
void Stock::show()
{
    using std::cout;
    using std::ios_base;
    // set format to #.###
    ios_base::fmtflags orig =
        cout.setf(ios_base::fixed, ios_base::floatfield);
    std::streamsize prec = cout.precision(3);

    cout << "Company: " << company
        << " Shares: " << shares << '\n';
    cout << " Share Price: $" << share_val;
    // set format to #.##
    cout.precision(2);
    cout << " Total Worth: $" << total_val << '\n';

    // restore original format
    cout.setf(orig, ios_base::floatfield);
    cout.precision(prec);
}
```

After this replacement and leaving the header file and client file unchanged, you can recompile the program. Now the output would look like this:

```
Company: NanoSmart Shares: 20
Share Price: $12.500 Total Worth: $250.00
Company: NanoSmart Shares: 35
Share Price: $18.125 Total Worth: $634.38
You can't sell more than you have! Transaction is aborted.
Company: NanoSmart Shares: 35
Share Price: $18.125 Total Worth: $634.38
Company: NanoSmart Shares: 300035
Share Price: $40.125 Total Worth: $12038904.38
Company: NanoSmart Shares: 35
Share Price: $0.125 Total Worth: $4.38
```

## Reviewing Our Story to Date

The first step in specifying a class design is to provide a class declaration. The class declaration is modeled after a structure declaration and can include data members and function members. The declaration has a private section, and members declared in that section can be accessed only through the member functions. The declaration also has a public section, and members declared there can be accessed directly by a program using class objects.

Typically, data members go into the private section and member functions go into the public section, so a typical class declaration has this form:

```
class className
{
private:
    data member declarations
public:
    member function prototypes
};
```

The contents of the public section constitute the abstract part of the design, the public interface. Encapsulating data in the private section protects the integrity of the data and is called data hiding. Thus, using a class is the C++ way of making it easy to implement the OOP features abstraction, data hiding, and encapsulation.

The second step in specifying a class design is to implement the class member functions. You can use a complete function definition instead of a function prototype in the class declaration, but the usual practice, except with very brief functions, is to provide the function definitions separately. In that case, you need to use the scope-resolution operator to indicate to which class a member function belongs. For example, suppose the `Bozo` class has a member function called `Retort()` that returns a pointer to a `char`. The function header would look like this:

```
char * Bozo::Retort()
```

In other words, `Retort()` is not just a type `char *` function; it is a type `char *` function that belongs to the `Bozo` class. The full, or qualified, name of the function is `Bozo::Retort()`. The name `Retort()`, on the other hand, is an abbreviation of the qualified name, and it can be used only in certain circumstances, such as in the code for the class methods.

Another way of describing this situation is to say that the name `Retort` has class scope, so the scope-resolution operator is needed to qualify the name when it is used outside the class declaration and a class method.

To create an object, which is a particular example of a class, you use the class name as if it were a type name:

```
Bozo bozetta;
```

This works because a class *is* a user-defined type.

You invoke a class member function, or method, by using a class object. You do so by using the dot membership operator:

```
cout << Bozetta.Retort();
```

This invokes the `Retort()` member function, and whenever the code for that function refers to a particular data member, the function uses the value that member has in the `bozetta` object.

## Class Constructors and Destructors

At this point, you need to do more with the `Stock` class. There are certain standard functions, called *constructors* and *destructors*, that you should normally provide for a class. Let's talk about why they are needed and how to write them.

One of C++'s aims is to make using class objects similar to using standard types. However, the code provided so far in this chapter doesn't let you initialize a `Stock` object the way you can an ordinary `int` or `struct`. That is, the usual initialization syntax doesn't carry over for the `Stock` type

```
int year = 2001; // valid initialization
struct thing
{
    char * pn;
    int m;
};
thing amabob = {"wodget", -23}; // valid initialization
Stock hot = {"Sukie's Autos, Inc.", 200, 50.25}; // NO! compile error
```

The reason you can't initialize a `Stock` object this way is because the data parts have private access status, which means a program cannot access the data members directly. As you've seen, the only way a program can access the data members is through a member function. Therefore, you need to devise an appropriate member function if you're to succeed in initializing an object. (You could initialize a class object as just shown if you made the data members public instead of private, but making the data public goes against one of the main justifications for using classes: data hiding.)

In general, it's best that all objects be initialized when they are created. For example, consider the following code:

```
Stock gift;
gift.buy(10, 24.75);
```

With the current implementation of the `Stock` class, the `gift` object has no value for the `company` member. The class design assumes that the user calls `acquire()` before calling any other member functions, but there is no way to enforce that assumption. One way around this difficulty is to have objects initialized automatically when they are created. To accomplish this, C++ provides for special member functions, called *class constructors*, especially for constructing new objects and assigning values to their data members. More precisely, C++ provides a name for these member functions and a syntax for using them, and you provide the method definition. The name is the same as the class name. For example, a possible constructor for the `Stock` class is a member function called `Stock()`. The constructor prototype and header have an interesting property: Although the constructor has no return value, it's not declared type `void`. In fact, a constructor has no declared type.

## Declaring and Defining Constructors

Now you need to build a `Stock` constructor. Because a `Stock` object has three values to be provided from the outside world, you should give the constructor three arguments. (The fourth value, the `total_val` member, is calculated from `shares` and `share_val`, so you don't have to provide it to the constructor.) Possibly, you may want to provide just the `company` member value and set the other values to zero; you can do this by using default arguments (see Chapter 8, "Adventures in Functions."). Thus, the prototype would look like this:

```
// constructor prototype with some default arguments
Stock(const string & co, long n = 0, double pr = 0.0);
```

The first argument is a pointer to the string that is used to initialize the `company` string member. The `n` and `pr` arguments provide values for the `shares` and `share_val` members. Note that there is no return type. The prototype goes in the public section of the class declaration.

Next, here's one possible definition for the constructor:

```
// constructor definition
Stock::Stock(const string & co, long n, double pr)
{
    company = co;

    if (n < 0)
    {
        std::cerr << "Number of shares can't be negative; "
                  << company << " shares set to 0.\n";
        shares = 0;
    }
    else
        shares = n;
    share_val = pr;
    set_tot();
}
```

This is the same code that the `acquire()` function used earlier in this chapter. The difference is that in this case, a program automatically invokes the constructor when it declares an object.

### Member Names and Parameter Names

Often those new to constructors try to use the class member names as parameter names in the constructor, as in this example:

```
// NO!
Stock::Stock(const string & company, long shares, double share_val)
{
```

```
...
}
```

This is wrong. The constructor arguments don't represent the class members; they represent values that are assigned to the class members. Thus, they must have distinct names, or you end up with confusing code like this:

```
shares = shares;
```

One common coding practice to help avoid such confusion is to use an `m_` prefix to identify data member names:

```
class Stock
{
private:
    string m_company;
    long m_shares;
    ...
}
```

Another common practice is to use an underbar suffix for member names:

```
class Stock
{
private:
    string company_;
    long shares_;
    ...
}
```

With either convention, you then can use `company` and `shares` as the parameter names in the public interface.

## Using Constructors

C++ provides two ways to initialize an object by using a constructor. The first is to call the constructor explicitly:

```
Stock food = Stock("World Cabbage", 250, 1.25);
```

This sets the `company` member of the `food` object to the string "World Cabbage", the `shares` member to 250, and so on.

The second way is to call the constructor implicitly:

```
Stock garment("Furry Mason", 50, 2.5);
```

This more compact form is equivalent to the following explicit call:

```
Stock garment = Stock("Furry Mason", 50, 2.5);
```

C++ uses a class constructor whenever you create an object of that class, even when you use `new` for dynamic memory allocation. Here's how to use the constructor with `new`:

```
Stock *pstock = new Stock("Electroshock Games", 18, 19.0);
```

This statement creates a `stock` object, initializes it to the values provided by the arguments, and assigns the address of the object to the `pstock` pointer. In this case, the object doesn't have a name, but you can use the pointer to manage the object. We'll discuss pointers to objects further in Chapter 11.

Constructors are used differently from the other class methods. Normally, you use an object to invoke a method:

```
stock1.show(); // stock1 object invokes show() method
```

However, you can't use an object to invoke a constructor because until the constructor finishes its work of making the object, there is no object. Rather than being invoked by an object, the constructor is used to create the object.

## Default Constructors

A *default constructor* is a constructor that is used to create an object when you don't provide explicit initialization values. That is, it's a constructor used for declarations like this:

```
Stock fluffy_the_cat; // uses the default constructor
```

Hey, Listing 10.3 already did that! The reason this statement works is that if you fail to provide any constructors, C++ automatically supplies a default constructor. It's an implicit version of a default constructor, and it does nothing. For the `Stock` class, the default constructor would look like this:

```
Stock::Stock() { }
```

The net result is that the `fluffy_the_cat` object is created with its members uninitialized, just as the following creates `x` without providing a value for `x`:

```
int x;
```

The fact that the default constructor has no arguments reflects the fact that no values appear in the declaration.

A curious fact about default constructors is that the compiler provides one only if you don't define any constructors. After you define any constructor for a class, the responsibility for providing a default constructor for that class passes from the compiler to you. If you provide a nondefault constructor, such as `Stock(const string & co, long n, double pr)`, and don't provide your own version of a default constructor, then a declaration like this becomes an error:

```
Stock stock1; // not possible with current constructor
```

The reason for this behavior is that you might want to make it impossible to create uninitialized objects. If, however, you wish to create objects without explicit initialization, you must define your own default constructor. This is a constructor that takes no arguments. You can define a default constructor two ways. One is to provide default values for all the arguments to the existing constructor:

```
Stock(const string & co = "Error", int n = 0, double pr = 0.0);
```

The second is to use function overloading to define a second constructor, one that has no arguments:

```
Stock();
```

You can have only one default constructor, so be sure that you don't do both. Actually, you should usually initialize objects in order to ensure that all members begin with known, reasonable values. Thus, a user-provided default constructor typically provides implicit initialization for all member values. For example, this is how you might define one for the `Stock` class:

```
Stock::Stock()           // default constructor
{
    company = "no name";
    shares = 0;
    share_val = 0.0;
    total_val = 0.0;
}
```

### Tip

When you design a class, you should usually provide a default constructor that implicitly initializes all class members.

After you've used either method (no arguments or default values for all arguments) to create the default constructor, you can declare object variables without initializing them explicitly:

```
Stock first;                // calls default constructor implicitly
Stock first = Stock();     // calls it explicitly
Stock *prelief = new Stock; // calls it implicitly
```

However, you shouldn't be misled by the implicit form of the nondefault constructor:

```
Stock first("Concrete Conglomerate"); // calls constructor
Stock second();                       // declares a function
Stock third;                          // calls default constructor
```

The first declaration here calls the nondefault constructor—that is, the one that takes arguments. The second declaration states that `second()` is a function that returns a `Stock` object. When you implicitly call the default constructor, you don't use parentheses.

## Destructors

When you use a constructor to create an object, the program undertakes the responsibility of tracking that object until it expires. At that time, the program automatically calls a special member function bearing the formidable title *destructor*. The destructor should clean up any debris, so it actually serves a useful purpose. For example, if your constructor uses `new` to allocate memory, the destructor should use `delete` to free that memory. The `Stock` constructor doesn't do anything fancy like using `new`, so the `Stock` class destructor doesn't

really have any tasks to perform. In such a case, you can simply let the compiler generate an implicit, do-nothing destructor, which is exactly what the first version of the `Stock` class does. On the other hand, it's certainly worth looking into how to declare and define destructors, so let's provide one for the `Stock` class.

Like a constructor, a destructor has a special name: It is formed from the class name preceded by a tilde (~). Thus, the destructor for the `Stock` class is called `~Stock()`. Also like a constructor, a destructor can have no return value and has no declared type. Unlike a constructor, a destructor must have no arguments. Thus, the prototype for a `Stock` destructor must be this:

```
~Stock();
```

Because a `Stock` destructor has no vital duties, you can code it as a do-nothing function:

```
Stock::~~Stock()
{
}
```

However, just so that you can see when the destructor is called, let's code it this way:

```
Stock::~~Stock()    // class destructor
{
    cout << "Bye, " << company << "!\n";
}
```

When should a destructor be called? The compiler handles this decision; normally your code shouldn't explicitly call a destructor. (See the section "Looking Again at Placement `new`" in Chapter 12, "Classes and Dynamic Memory Allocation," for an exception.) If you create a static storage class object, its destructor is called automatically when the program terminates. If you create an automatic storage class object, as the examples have been doing, its destructor is called automatically when the program exits the block of code in which the object is defined. If the object is created by using `new`, it resides in heap memory, or the free store, and its destructor is called automatically when you use `delete` to free the memory. Finally, a program can create temporary objects to carry out certain operations; in that case, the program automatically calls the destructor for the object when it has finished using it.

Because a destructor is called automatically when a class object expires, there ought to be a destructor. If you don't provide one, the compiler implicitly declares a default constructor and, if it detects code that leads to the destruction of an object, it provides a definition for the destructor.

## Improving the `Stock` Class

At this point we need to incorporate the constructors and the destructor into the class and method definitions. Given the significance of adding constructors, we'll advance the name from `stock00.h` to `stock10.h`. The class methods go into a file called `stock10.cpp`. Finally, we place the program using these resources in a third file, `usestock2.cpp`.



### The Header File

Listing 10.4 shows the header file for the stock program. It adds prototypes for the constructor and destructor functions to the original class declaration. Also it dispenses with the `acquire()` function, which is no longer necessary now that the class has constructors. The file also uses the `#ifndef` technique described in Chapter 9 to protect against multiple inclusion of this file.

Listing 10.4 `stock10.h`

---

```
// stock10.h -- Stock class declaration with constructors, destructor added
#ifndef STOCK10_H_
#define STOCK10_H_
#include <string>

class Stock
{
private:
    std::string company;
    long shares;
    double share_val;
    double total_val;
    void set_tot() { total_val = shares * share_val; }
public:
// two constructors
    Stock(); // default constructor
    Stock(const std::string & co, long n = 0, double pr = 0.0);
    ~Stock(); // noisy destructor
    void buy(long num, double price);
    void sell(long num, double price);
    void update(double price);
    void show();
};

#endif
```

---

### The Implementation File

Listing 10.5 provides the method definitions for the stock program. It includes the `stock10.h` file in order to provide the class declaration. (Recall that enclosing the filename in double quotation marks instead of in brackets causes the compiler to search for it at the same location where your source files are located.) Also Listing 10.5 includes the `iostream` header file to provide I/O support. The listing also provides using declarations and qualified names (such as `std::string`) to provide access to various declarations in the header files. This file adds the constructor and destructor method definitions to the prior methods. To help you see when these methods are called, they each display a message. This

is not a usual feature of constructors and destructors, but it can help you better visualize how classes use them.

#### Listing 10.5 `stock10.cpp`

---

```
// stock10.cpp -- Stock class with constructors, destructor added
#include <iostream>
#include "stock10.h"

// constructors (verbose versions)
Stock::Stock()           // default constructor
{
    std::cout << "Default constructor called\n";
    company = "no name";
    shares = 0;
    share_val = 0.0;
    total_val = 0.0;
}

Stock::Stock(const std::string & co, long n, double pr)
{
    std::cout << "Constructor using " << co << " called\n";
    company = co;

    if (n < 0)
    {
        std::cout << "Number of shares can't be negative; "
            << company << " shares set to 0.\n";
        shares = 0;
    }
    else
        shares = n;
    share_val = pr;
    set_tot();
}

// class destructor
Stock::~Stock()         // verbose class destructor
{
    std::cout << "Bye, " << company << "!\n";
}

// other methods
void Stock::buy(long num, double price)
{
    if (num < 0)
    {
        std::cout << "Number of shares purchased can't be negative. "
```

```

        << "Transaction is aborted.\n";
    }
    else
    {
        shares += num;
        share_val = price;
        set_tot();
    }
}

void Stock::sell(long num, double price)
{
    using std::cout;
    if (num < 0)
    {
        cout << "Number of shares sold can't be negative. "
              << "Transaction is aborted.\n";
    }
    else if (num > shares)
    {
        cout << "You can't sell more than you have! "
              << "Transaction is aborted.\n";
    }
    else
    {
        shares -= num;
        share_val = price;
        set_tot();
    }
}

void Stock::update(double price)
{
    share_val = price;
    set_tot();
}

void Stock::show()
{
    using std::cout;
    using std::ios_base;
    // set format to #.###
    ios_base::fmtflags orig =
        cout.setf(ios_base::fixed, ios_base::floatfield);
    std::streamsize prec = cout.precision(3);

    cout << "Company: " << company

```

```

    << " Shares: " << shares << '\n';
cout << " Share Price: $" << share_val;
// set format to #.##
cout.precision(2);
cout << " Total Worth: $" << total_val << '\n';

// restore original format
cout.setf(orig, ios_base::floatfield);
cout.precision(prec);
}

```

---

## A Client File

Listing 10.6 provides a short program for testing the new methods in the stock program. Because it simply uses the `Stock` class, this listing is a client of the `Stock` class. Like `stock10.cpp`, it includes the `stock10.h` file to provide the class declaration. The program demonstrates constructors and destructors. It also uses the same formatting commands invoked by Listing 10.3. To compile the complete program, you use the techniques for multifile programs described in Chapters 1 and 9.

### Listing 10.6 `usestok1.cpp`

---

```

// usestok1.cpp -- using the Stock class
// compile with stock10.cpp
#include <iostream>
#include "stock10.h"

int main()
{
    {
        using std::cout;
        cout << "Using constructors to create new objects\n";
        Stock stock1("NanoSmart", 12, 20.0); // syntax 1
        stock1.show();
        Stock stock2 = Stock ("Boffo Objects", 2, 2.0); // syntax 2
        stock2.show();

        cout << "Assigning stock1 to stock2:\n";
        stock2 = stock1;
        cout << "Listing stock1 and stock2:\n";
        stock1.show();
        stock2.show();

        cout << "Using a constructor to reset an object\n";
        stock1 = Stock("Nifty Foods", 10, 50.0); // temp object
        cout << "Revised stock1:\n";
    }
}

```

```

    stock1.show();
    cout << "Done\n";
}
return 0;
}

```

---

Compiling the program represented by Listings 10.4, 10.5, and 10.6 produces an executable program. Here's one compiler's output from the executable program:

```

Using constructors to create new objects
Constructor using NanoSmart called
Company: NanoSmart Shares: 12
    Share Price: $20.00 Total Worth: $240.00
Constructor using Boffo Objects called
Company: Boffo Objects Shares: 2
    Share Price: $2.00 Total Worth: $4.00
Assigning stock1 to stock2:
Listing stock1 and stock2:
Company: NanoSmart Shares: 12
    Share Price: $20.00 Total Worth: $240.00
Company: NanoSmart Shares: 12
    Share Price: $20.00 Total Worth: $240.00
Using a constructor to reset an object
Constructor using Nifty Foods called
Bye, Nifty Foods!
Revised stock1:
Company: Nifty Foods Shares: 10
    Share Price: $50.00 Total Worth: $500.00
Done
Bye, NanoSmart!
Bye, Nifty Foods!

```

Some compilers may produce a program with the following initial output, which has one additional line:

```

Using constructors to create new objects
Constructor using NanoSmart called
Company: NanoSmart Shares: 12
    Share Price: $20.00 Total Worth: $240.00
Constructor using Boffo Objects called
Bye, Boffo Objects! << additional line
Company: Boffo Objects Shares: 2
    Share Price: $2.00 Total Worth: $4.00
...

```

The following "Program Notes" section explains the "Bye, Boffo Objects!" line of this output.

## Note

You may have noticed that Listing 10.6 has an extra brace at the beginning and near the end of `main()`. Automatic variables such as `stock1` and `stock2` expire when the program exits the block that contains their definitions. Without the extra braces, that block would be the body of `main()`, so the destructors would not be called until after `main()` completed execution. In a windowing environment, this would mean that the window would close before the last two destructor calls, preventing you from seeing the last two messages. But with the braces, the last two destructor calls occur before the return statement is reached, so the messages are displayed.

## Program Notes

In Listing 10.6, the statement

```
Stock stock1("NanoSmart", 12, 20.0);
```

creates a `Stock` object called `stock1` and initializes its data members to the indicated values:

```
Constructor using NanoSmart called  
Company: NanoSmart Shares: 12
```

The following statement uses another syntax to create and initialize an object called `stock2`:

```
Stock stock2 = Stock ("Boffo Objects", 2, 2.0);
```

The C++ Standard gives a compiler a couple ways to execute this second syntax. One is to make it behave exactly like the first syntax:

```
Constructor using Boffo Objects called  
Company: Boffo Objects Shares: 2
```

The second way is to allow the call to the constructor to create a temporary object that is then copied to `stock2`. Then the temporary object is discarded. If the compiler uses this option, the destructor is called for the temporary object, producing this output instead:

```
Constructor using Boffo Objects called  
Bye, Boffo Objects!  
Company: Boffo Objects Shares: 2
```

The compiler that produced this output disposed of the temporary object immediately, but it's possible that a compiler might wait longer, in which case the destructor message would be displayed later.

The following statement illustrates that you can assign one object to another of the same type:

```
stock2 = stock1;    // object assignment
```

As with structure assignment, class object assignment, by default, copies the members of one object to the other. In this case, the original contents of `stock2` are overwritten.

**Note**

When you assign one object to another of the same class, by default C++ copies the contents of each data member of the source object to the corresponding data member of the target object.

You can use the constructor for more than initializing a new object. For example, the program has this statement in `main()`:

```
stock1 = Stock("Nifty Foods", 10, 50.0);
```

The `stock1` object already exists. Therefore, instead of initializing `stock1`, this statement assigns new values to the object. It does so by having the constructor create a new, temporary object and then copying the contents of the new object to `stock1`. Then the program disposes of the temporary object, invoking the destructor as it does so, as illustrated by the following annotated output:

```
Using a constructor to reset an object
Constructor using Nifty Foods called >> temporary object created
Bye, Nifty Foods! >> temporary object destroyed
Revised stock1:
Company: Nifty Foods Shares: 10 >> data now copied to stock1
Share Price: $50.00 Total Worth: $500.00
```

Some compilers might dispose of the temporary object later, delaying the destructor call. Finally, at the end, the program displays this:

```
Done
Bye, NanoSmart!
Bye, Nifty Foods!
```

When the `main()` function terminates, its local variables (`stock1` and `stock2`) pass from your plane of existence. Because such automatic variables go on the stack, the last object created is the first deleted, and the first created is the last deleted. (Recall that "NanoSmart" was originally in `stock1` but was later transferred to `stock2`, and `stock1` was reset to "Nifty Foods".)

The output points out that there is a fundamental difference between the following two statements:

```
Stock stock2 = Stock ("Boffo Objects", 2, 2.0);
stock1 = Stock("Nifty Foods", 10, 50.0); // temporary object
```

The first of these statements invokes initialization; it creates an object with the indicated value, and it may or may not create a temporary object. The second statement invokes assignment. Using a constructor in an assignment statement in this fashion always causes the creation of a temporary object before assignment occurs.

**Tip**

If you can set object values either through initialization or by assignment, choose initialization. It is usually more efficient.

## C++11 List Initialization

With C++11, can you use the list-initialization syntax with classes? Yes, you can, providing the brace contents match the argument list of a constructor:

```
Stock hot_tip = {"Derivatives Plus Plus", 100, 45.0};
Stock jock {"Sport Age Storage, Inc"};
Stock temp {};
```

The braced lists in the first two declarations match the following constructor:

```
Stock::Stock(const std::string & co, long n = 0, double pr = 0.0);
```

Therefore, that constructor will be used to create the two objects. For `jock`, the default values of 0 and 0.0 will be used for the second and third arguments. The third declaration matches the default constructor, so `temp` is constructed using it.

In addition, C++11 offers a class called `std::initializer_list` that can be used as a type for a function or method parameter. This class can represent a list of arbitrary length, providing all the entries are of the same type or can be converted to the same type. Chapter 16, “The `string` Class and the Standard Template Library,” will return to this topic.

## const Member Functions

Consider the following code snippet:

```
const Stock land = Stock("Kludgehorn Properties");
land.show();
```

With current C++, the compiler should object to the second line. Why? Because the code for `show()` fails to guarantee that it won't modify the invoking object, which, because it is `const`, should not be altered. We've solved this kind of problem before by declaring a function's argument to be a `const` reference or a pointer to `const`. But there's a syntax problem: The `show()` method doesn't have any arguments for `const` to qualify. Instead, the object it uses is provided implicitly by the method invocation. What is needed is a new syntax, one that says a function promises not to modify the invoking object. The C++ solution is to place the `const` keyword after the function parentheses. That is, the `show()` declaration should look like this:

```
void show() const;           // promises not to change invoking object
```

Similarly, the beginning of the function definition should look like this:

```
void stock::show() const    // promises not to change invoking object
```

Class functions declared and defined this way are called `const` member functions. Just as you should use `const` references and pointers as formal function arguments whenever appropriate, you should make class methods `const` whenever they don't modify the invoking object. We'll follow this rule from here on out.



## Constructors and Destructors in Review

Now that we've gone through a few examples of constructors and destructors, you might want to pause and assimilate what has passed. To help you, here is a summary of these methods.

A constructor is a special class member function that's called whenever an object of that class is created. A class constructor has the same name as its class, but through the miracle of function overloading, you can have more than one constructor with the same name, provided that each has its own signature, or argument list. Also a constructor has no declared type. Usually a constructor is used to initialize members of a class object. Your initialization should match the constructor's argument list. For example, suppose the `Bozo` class has the following prototype for a class constructor:

```
Bozo(const char * fname, const char * lname); // constructor prototype
```

In this case, you can use it to initialize new objects as follows:

```
Bozo bozetta = bozo("Bozetta", "Biggens"); // primary form
Bozo fufu("Fufu", "O'Dweeb"); // short form
Bozo *pc = new Bozo("Popo", "Le Peu"); // dynamic object
```

If C++11 rules are in effect, you can use list initialization instead:

```
Bozo bozetta = {"Bozetta", "Biggens"}; // C++11
Bozo fufu{"Fufu", "O'Dweeb"} // C++11;
Bozo *pc = new Bozo{"Popo", "Le Peu"}; // C++11
```

If a constructor has just one argument, that constructor is invoked if you initialize an object to a value that has the same type as the constructor argument. For example, suppose you have this constructor prototype:

```
Bozo(int age);
```

Then you can use any of the following forms to initialize an object:

```
Bozo dribble = bozo(44); // primary form
Bozo roon(66); // secondary form
Bozo tubby = 32; // special form for one-argument constructors
```

Actually, the third example is a new point, not a review point, but it seemed like a nice time to tell you about it. Chapter 11 mentions a way to turn off this feature because it can lead to unpleasant surprises.

### Caution

A constructor that you can use with a single argument allows you to use assignment syntax to initialize an object to a value:

```
Classname object = value;
```

This feature can cause problems, but it can be blocked, as described in Chapter 11.

A default constructor has no arguments, and it is used if you create an object without explicitly initializing it. If you fail to provide any constructors, the compiler defines a default constructor for you. Otherwise, you have to supply your own default constructor. It can have no arguments or else it must have default values for all arguments:

```
Bozo(); // default constructor prototype
Bistro(const char * s = "Chez Zero"); // default for Bistro class
```

The program uses the default constructor for uninitialized objects:

```
Bozo bubu; // use default
Bozo *pb = new Bozo; // use default
```

Just as a program invokes a constructor when an object is created, it invokes a destructor when an object is destroyed. You can have only one destructor per class. It has no return type (not even `void`), it has no arguments, and its name is the class name preceded by a tilde. For example, the `Bozo` class destructor has the following prototype:

```
-Bozo(); // class destructor
```

Class destructors that use `delete` become necessary when class constructors use `new`.

## Knowing Your Objects: The `this` Pointer

You can do still more with the `Stock` class. So far each class member function has dealt with but a single object: the object that invokes it. Sometimes, however, a method might need to deal with two objects, and doing so may involve a curious C++ pointer called `this`. Let's look at how the need for `this` can unfold.

Although the `Stock` class declaration displays data, it's deficient in analytic power. For example, by looking at the `show()` output, you can tell which of your holdings has the greatest value, but the program can't tell because it can't access `total_val` directly. The most direct way of letting a program know about stored data is to provide methods to return values. Typically, you use inline code for this, as in the following example:

```
class Stock
{
private:
    ...
    double total_val;
    ...
public:
    double total() const { return total_val; }
    ...
};
```

This definition, in effect, makes `total_val` read-only memory as far as a direct program access is concerned. That is, you can use the `total_val()` method to obtain the value, but the class doesn't provide a method for specifically resetting the value of

`total_val`. (Other methods, such as `buy()`, `sell()`, and `update()`, do modify `total_val` as a by-product of resetting the `shares` and `share_val` members.)

By adding this function to the class declaration, you can let a program investigate a series of stocks to find the one with the greatest value. However, you can take a different approach, one that helps you learn about the `this` pointer. The approach is to define a member function that looks at two `Stock` objects and returns a reference to the larger of the two. Attempting to implement this approach raises some interesting questions, which we'll look into now.

First, how do you provide the member function with two objects to compare? Suppose, for example, that you decide to name the method `topval()`. Then the function call `stock1.topval()` accesses the data of the `stock1` object, whereas the message `stock2.topval()` accesses the data of the `stock2` object. If you want the method to compare two objects, you have to pass the second object as an argument. For efficiency, you can pass the argument by reference. That is, you can have the `topval()` method use a type `const Stock & argument`.

Second, how do you communicate the method's answer back to the calling program? The most direct way is to have the method return a reference to the object that has the larger total value. Thus, the comparison method should have the following prototype:

```
const Stock & topval(const Stock & s) const;
```

This function accesses one object implicitly and one object explicitly, and it returns a reference to one of those two objects. The `const` in parentheses states that the function won't modify the explicitly accessed object, and the `const` that follows the parentheses states that the function won't modify the implicitly accessed object. Because the function returns a reference to one of the two `const` objects, the return type also has to be a `const` reference.

Suppose, then, that you want to compare the `Stock` objects `stock1` and `stock2` and assign the one with the greater total value to the object `top`. You can use either of the following statements to do so:

```
top = stock1.topval(stock2);
top = stock2.topval(stock1);
```

The first form accesses `stock1` implicitly and `stock2` explicitly, whereas the second accesses `stock1` explicitly and `stock2` implicitly (see Figure 10.3). Either way, the method compares the two objects and returns a reference to the one with the higher total value.

Actually, this notation is a bit confusing. It would be clearer if you could somehow use the relational operator `>` to compare the two objects. You can do so with operator overloading, which Chapter 11 discusses.

Meanwhile, there's still the implementation of `topval()` to attend to. It raises a slight problem. Here's a partial implementation that highlights the problem:

```
const Stock & Stock::topval(const Stock & s) const
{
    if (s.total_val > total_val)
```

```

return s;           // argument object
else
return ?????;      // invoking object
}

```

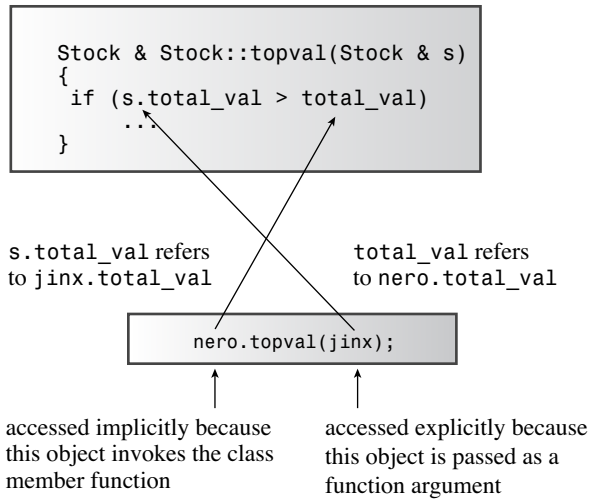

Figure 10.3 Accessing two objects by using a member function.

Here `s.total_val` is the total value for the object passed as an argument, and `total_val` is the total value for the object to which the message is sent. If `s.total_val` is greater than `total_val`, the function returns a reference to `s`. Otherwise, it returns a reference to the object used to evoke the method. (In OOP talk, that is the object to which the `topval` message is sent.) Here's the problem: What do you call that object? If you make the call `stock1.topval(stock2)`, then `s` is a reference for `stock2` (that is, an alias for `stock2`), but there is no alias for `stock1`.

The C++ solution to this problem is to use a special pointer called `this`. The `this` pointer points to the object used to invoke a member function. (Basically, `this` is passed as a hidden argument to the method.) Thus, the function call `stock1.topval(stock2)` sets `this` to the address of the `stock1` object and makes that pointer available to the `topval()` method. Similarly, the function call `stock2.topval(stock1)` sets `this` to the address of the `stock2` object. In general, all class methods have a `this` pointer set to the address of the object that invokes the method. Indeed, `total_val` in `topval()` is just shorthand notation for `this->total_val`. (Recall from Chapter 4, "Compound Types," that you use the `->` operator to access structure members via a pointer. The same is true for class members.) (See Figure 10.4.)

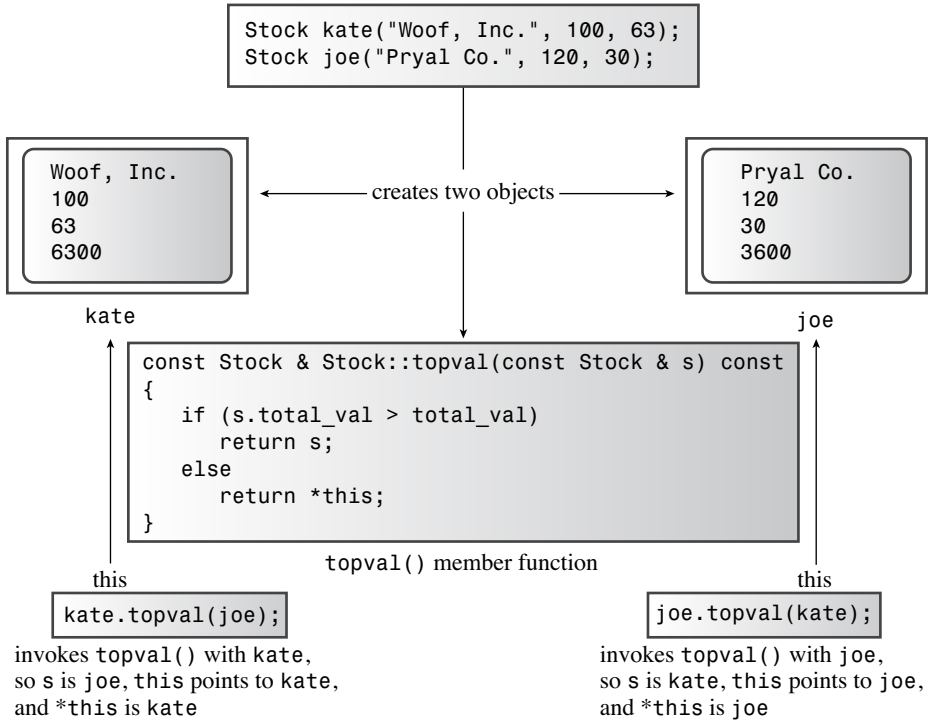

Figure 10.4 this points to the invoking object.

**Note**

Each member function, including constructors and destructors, has a `this` pointer. The special property of the `this` pointer is that it points to the invoking object. If a method needs to refer to the invoking object as a whole, it can use the expression `*this`. Using the `const` qualifier after the function argument parentheses qualifies `this` as being a pointer to `const`; in that case, you can't use `this` to change the object's value.

What you want to return, however, is not `this` because `this` is the address of the object. You want to return the object itself, and that is symbolized by `*this`. (Recall that applying the dereferencing operator `*` to a pointer yields the value to which the pointer points.) Now you can complete the method definition by using `*this` as an alias for the invoking object:

```

const Stock & Stock::topval(const Stock & s) const
{
    if (s.total_val > total_val)
        return s;           // argument object
    else
        return *this;      // invoking object
}
    
```

The fact that the return type is a reference means that the returned object is the invoking object itself rather than a copy passed by the return mechanism. Listing 10.7 shows the new header file.

#### Listing 10.7 `stock20.h`

---

```
// stock20.h -- augmented version
#ifndef STOCK20_H_
#define STOCK20_H_
#include <string>

class Stock
{
private:
    std::string company;
    int shares;
    double share_val;
    double total_val;
    void set_tot() { total_val = shares * share_val; }
public:
    Stock();           // default constructor
    Stock(const std::string & co, long n = 0, double pr = 0.0);
    ~Stock();         // do-nothing destructor
    void buy(long num, double price);
    void sell(long num, double price);
    void update(double price);
    void show()const;
    const Stock & topval(const Stock & s) const;
};

#endif
```

---

Listing 10.8 presents the revised class methods file. It includes the new `topval()` method. Also now that you've seen how the constructors and destructor work, Listing 10.8 replaces them with silent versions.

#### Listing 10.8 `stock20.cpp`

---

```
// stock20.cpp -- augmented version
#include <iostream>
#include "stock20.h"

// constructors
Stock::Stock()           // default constructor
{
    company = "no name";
    shares = 0;
```

```

        share_val = 0.0;
        total_val = 0.0;
    }

Stock::Stock(const std::string & co, long n, double pr)
{
    company = co;

    if (n < 0)
    {
        std::cout << "Number of shares can't be negative; "
                  << company << " shares set to 0.\n";
        shares = 0;
    }
    else
        shares = n;
    share_val = pr;
    set_tot();
}

// class destructor
Stock::~Stock()           // quiet class destructor
{
}

// other methods
void Stock::buy(long num, double price)
{
    if (num < 0)
    {
        std::cout << "Number of shares purchased can't be negative. "
                  << "Transaction is aborted.\n";
    }
    else
    {
        shares += num;
        share_val = price;
        set_tot();
    }
}

void Stock::sell(long num, double price)
{
    using std::cout;
    if (num < 0)
    {

```

```
        cout << "Number of shares sold can't be negative. "
            << "Transaction is aborted.\n";
    }
    else if (num > shares)
    {
        cout << "You can't sell more than you have! "
            << "Transaction is aborted.\n";
    }
    else
    {
        shares -= num;
        share_val = price;
        set_tot();
    }
}
```

```
void Stock::update(double price)
{
    share_val = price;
    set_tot();
}
```

```
void Stock::show() const
{
    using std::cout;
    using std::ios_base;
    // set format to #.###
    ios_base::fmtflags orig =
        cout.setf(ios_base::fixed, ios_base::floatfield);
    std::streamsize prec = cout.precision(3);

    cout << "Company: " << company
        << " Shares: " << shares << '\n';
    cout << " Share Price: $" << share_val;
    // set format to #.##
    cout.precision(2);
    cout << " Total Worth: $" << total_val << '\n';

    // restore original format
    cout.setf(orig, ios_base::floatfield);
    cout.precision(prec);
}
```

```
const Stock & Stock::topval(const Stock & s) const
{
    if (s.total_val > total_val)
```



```

        return s;
    else
        return *this;
}

```

---

Of course, you want to see if the `this` pointer works, and a natural place to use the new method is in a program with an array of objects, which leads us to the next topic.

## An Array of Objects

Often, as with the `Stock` examples, you want to create several objects of the same class. You can create separate object variables, as the examples have done so far in this chapter, but it might make more sense to create an array of objects. That might sound like a major leap into the unknown, but, in fact, you declare an array of objects the same way you declare an array of any of the standard types:

```
Stock mystuff[4]; // creates an array of 4 Stock objects
```

Recall that a program always calls the default class constructor when it creates class objects that aren't explicitly initialized. This declaration requires either that the class explicitly define no constructors at all, in which case the implicit do-nothing default constructor is used, or, as in this case, that an explicit default constructor be defined. Each element—`mystuff[0]`, `mystuff[1]`, and so on—is a `Stock` object and thus can be used with the `Stock` methods:

```

mystuff[0].update(); // apply update() to 1st element
mystuff[3].show(); // apply show() to 4th element
const Stock * tops = mystuff[2].topval(mystuff[1]);
    // compare 3rd and 2nd elements and set tops
    // to point at the one with a higher total value

```

You can use a constructor to initialize the array elements. In that case, you have to call the constructor for each individual element:

```

const int STKS = 4;
Stock stocks[STKS] = {
    Stock("NanoSmart", 12.5, 20),
    Stock("Boffo Objects", 200, 2.0),
    Stock("Monolithic Obelisks", 130, 3.25),
    Stock("Fleep Enterprises", 60, 6.5)
};

```

Here the code uses the standard form for initializing an array: a comma-separated list of values enclosed in braces. In this case, a call to the constructor method represents each

value. If the class has more than one constructor, you can use different constructors for different elements:

```
const int STKS = 10;
Stock stocks[STKS] = {
    Stock("NanoSmart", 12.5, 20),
    Stock(),
    Stock("Monolithic Obelisks", 130, 3.25),
};
```

This initializes `stocks[0]` and `stocks[2]` using the `Stock(const string & co, long n, double pr)` constructor as well as `stocks[1]` using the `Stock()` constructor. Because this declaration only partially initializes the array, the remaining seven members are initialized using the default constructor.

Listing 10.9 applies these principles to a short program that initializes four array elements, displays their contents, and tests the elements to find the one with the highest total value. Because `topval()` examines just two objects at a time, the program uses a `for` loop to examine the whole array. Also it uses a pointer-to-`Stock` to keep track of which element has the highest value. This listing uses the Listing 10.7 header file and the Listing 10.8 methods file.

#### Listing 10.9 `usestok2.cpp`

---

```
// usestok2.cpp -- using the Stock class
// compile with stock20.cpp
#include <iostream>
#include "stock20.h"

const int STKS = 4;
int main()
{
    // create an array of initialized objects
    Stock stocks[STKS] = {
        Stock("NanoSmart", 12, 20.0),
        Stock("Boffo Objects", 200, 2.0),
        Stock("Monolithic Obelisks", 130, 3.25),
        Stock("Fleep Enterprises", 60, 6.5)
    };

    std::cout << "Stock holdings:\n";
    int st;
    for (st = 0; st < STKS; st++)
        stocks[st].show();
    // set pointer to first element
    const Stock * top = &stocks[0];
    for (st = 1; st < STKS; st++)
        top = &top->topval(stocks[st]);
```

```
// now top points to the most valuable holding
std::cout << "\nMost valuable holding:\n";
top->show();
return 0;
}
```

---

Here is the output from the program in Listing 10.9:

```
Stock holdings:
Company: NanoSmart Shares: 12
  Share Price: $20.000 Total Worth: $240.00
Company: Boffo Objects Shares: 200
  Share Price: $2.000 Total Worth: $400.00
Company: Monolithic Obelisks Shares: 130
  Share Price: $3.250 Total Worth: $422.50
Company: Fleep Enterprises Shares: 60
  Share Price: $6.500 Total Worth: $390.00

Most valuable holding:
Company: Monolithic Obelisks Shares: 130
  Share Price: $3.250 Total Worth: $422.50
```

One thing to note about Listing 10.9 is that most of the work goes into designing the class. When that's done, writing the program itself is rather simple.

Incidentally, knowing about the `this` pointer makes it easier to see how C++ works under the skin. For example, the original Unix implementation used a C++ front-end `cfront` that converted C++ programs to C programs. To handle method definitions, all it had to do is convert a C++ method definition like

```
void Stock::show() const
{
    cout << "Company: " << company
         << " Shares: " << shares << '\n'
         << " Share Price: $" << share_val
         << " Total Worth: $" << total_val << '\n';
}
```

to the following C-style definition:

```
void show(const Stock * this)
{
    cout << "Company: " << this->company
         << " Shares: " << this->shares << '\n'
         << " Share Price: $" << this->share_val
         << " Total Worth: $" << this->total_val << '\n';
}
```

That is, it converted a `Stock::` qualifier to a function argument that is a pointer to `Stock` and then uses the pointer to access class members.

Similarly, the front end converted function calls like

```
top.show();
```

to this:

```
show(&top);
```

In this fashion, the `this` pointer is assigned the address of the invoking object. (The actual details might be more involved.)

## Class Scope

Chapter 9 discusses global (or file) scope and local (or block) scope. Recall that you can use a variable with global scope anywhere in the file that contains its definition, whereas a variable with local scope is local to the block that contains its definition. Function names, too, can have global scope, but they never have local scope. C++ classes introduce a new kind of scope: class scope.

Class scope applies to names defined in a class, such as the names of class data members and class member functions. Items that have class scope are known within the class but not outside the class. Thus, you can use the same class member names in different classes without conflict. For example, the `shares` member of the `Stock` class is distinct from the `shares` member of a `JobRide` class. Also class scope means you can't directly access members of a class from the outside world. This is true even for public function members. That is, to invoke a public member function, you have to use an object:

```
Stock sleeper("Exclusive Ore", 100, 0.25); // create object
sleeper.show(); // use object to invoke a member function
show(); // invalid -- can't call method directly
```

Similarly, you have to use the scope-resolution operator when you define member functions:

```
void Stock::update(double price)
{
    ...
}
```

In short, within a class declaration or a member function definition you can use an unadorned member name (the unqualified name), as when `sell()` calls the `set_tot()` member function. A constructor name is recognized when it is called because its name is the same as the class name. Otherwise, you must use the direct membership operator (`.`), the indirect membership operator (`->`), or the scope-resolution operator (`::`), depending on the context, when you use a class member name. The following code fragment illustrates how identifiers with class scope can be accessed:

```

class Ik
{
private:
    int fuss;          // fuss has class scope
public:
    Ik(int f = 9) {fuss = f; } // fuss is in scope
    void ViewIk() const;      // ViewIk has class scope
};

void Ik::ViewIk() const //Ik:: places ViewIk into Ik scope
{
    cout << fuss << endl; // fuss in scope within class methods
}
...
int main()
{
    Ik * pik = new Ik;
    Ik ee = Ik(8); // constructor in scope because has class name
    ee.ViewIk(); // class object brings ViewIk into scope
    pik->ViewIk(); // pointer-to-Ik brings ViewIk into scope
    ...
}

```

## Class Scope Constants

Sometimes it would be nice to have symbolic constants with class scope. For example, a class declaration might use the literal 30 to specify an array size. Because the constant is the same for all objects, it would be nice to create a single constant shared by all objects. You might think the following would be a solution:

```

class Bakery
{
private:
    const int Months = 12; // declare a constant? FAILS
    double costs[Months];
    ...
}

```

But this won't work because declaring a class describes what an object looks like but doesn't create an object. Hence, until you create an object, there's no place to store a value. (Actually, C++11 provides for member initialization, but not in a way that would make the preceding array declaration work; Chapter 12 returns to this topic.) There are, however, a couple ways to achieve essentially the same desired effect.

First, you can declare an enumeration within a class. An enumeration given in a class declaration has class scope, so you can use enumerations to provide class scope symbolic names for integer constants. That is, you can start off the `Bakery` declaration this way:

```
class Bakery
{
private:
    enum {Months = 12};
    double costs[Months];
    ...
}
```

Note that declaring an enumeration in this fashion does not create a class data member. That is, each individual object does not carry an enumeration in it. Rather, `Len` is just a symbolic name that the compiler replaces with `30` when it encounters it in code in class scope.

Because the `Bakery` class uses the enumeration merely to create a symbolic constant, with no intent of creating variables of the enumeration type, you needn't provide an enumeration tag. Incidentally, for many implementations, the `ios_base` class does something similar in its public section; that's the source of identifiers such as `ios_base::fixed`. Here `fixed` is typically an enumerator defined in the `ios_base` class.

C++ has a second way of defining a constant within a class—using the keyword `static`:

```
class Bakery
{
private:
    static const int Months = 12;
    double costs[Months];
    ...
}
```

This creates a single constant called `Months` that is stored with other static variables rather than in an object. Thus, there is only one `Months` constant shared by all `Bakery` objects. Chapter 12 looks further into static class members. In C++98 you can use this technique only for declaring static constants with integral and enumeration values. Thus, C++98 doesn't allow you to store a `double` constant this way. C++11 removes that restriction.

## Scoped Enumerations (C++11)

Traditional enumerations have some problems. One is that enumerators from two different enum definitions can conflict. Suppose you were working on a project involving eggs and T-shirts. You might try something like this:

```
enum egg {Small, Medium, Large, Jumbo};
enum t_shirt {Small, Medium, Large, Xlarge};
```

This won't fly because the `egg Small` and the `t_shirt Small` would both be in the same scope, and the names conflict. C++11 provides a new form of enumeration that avoids this problem by having class scope for its enumerators. The declarations for this form look like this:

```
enum class egg {Small, Medium, Large, Jumbo};
enum class t_shirt {Small, Medium, Large, Xlarge};
```

Alternatively, you can use the keyword `struct` instead of `class`. In either case, you now need to use the `enum` name to qualify the enumerator:

```
egg choice = egg::Large;           // the Large enumerator of the egg enum
t_shirt Floyd = t_shirt::Large; // the Large enumerator of the t_shirt enum
```

Now that the enumerators have class scope, enumerators from different `enum` definitions no longer have potential name conflicts, and your egg-and-T-shirt project can proceed.

C++11 also tightens up type security for scoped enumerations. Regular enumerations get converted to integer types automatically in some situations, such as assignment to an `int` variable or being used in a comparison expression, but scoped enumerations have no implicit conversions to integer types:

```
enum egg_old {Small, Medium, Large, Jumbo};           // unscoped
enum class t_shirt {Small, Medium, Large, Xlarge}; // scoped
egg_old one = Medium;                                // unscoped
t_shirt rolf = t_shirt::Large;                       // scoped
int king = one;                                       // implicit type conversion for unscoped
int ring = rolf;                                     // not allowed, no implicit type conversion
if (king < Jumbo) // allowed
    std::cout << "Jumbo converted to int before comparison.\n";
if (king < t_shirt::Medium) // not allowed
    std::cout << "Not allowed: < not defined for scoped enum.\n";
```

But you can do an explicit type conversion if you feel you have to:

```
int Frodo = int(t_shirt::Small); // Frodo set to 0
```

Enumerations are represented by some underlying integer type, and under C98 that choice was implementation-dependent. Thus, a structure containing an enumeration might be of different sizes on different systems. C++11 removes that dependency for scoped enumerations. By default, the underlying type for C++11 scoped enumerations is `int`. Furthermore, there's a syntax for indicating a different choice:

```
// underlying type for pizza is short
enum class : short pizza {Small, Medium, Large, XLarge};
```

The `: short` specifies the underlying type to be `short`. The underlying type has to be an integer type. Under C++11, you also can use this syntax to indicate the underlying type for an unscoped enumeration, but if you don't choose the type, the choice the compiler makes is implementation-dependent.

## Abstract Data Types

The `Stack` class is pretty specific. Often, however, programmers define classes to represent more general concepts. For example, using classes is a good way to implement what computer scientists describe as *abstract data types* (ADTs). As the name suggests, an ADT describes a data type in a general fashion without bringing in language or implementation details. Consider, for example, the stack. By using the stack, you can store data so that

data is always added to or deleted from the top of the stack. For example, C++ programs use a stack to manage automatic variables. As new automatic variables are generated, they are added to the top of the stack. When they expire, they are removed from the stack.

Let's look at the properties of a stack in a general, abstract way. First, a stack holds several items. (That property makes it a *container*, an even more general abstraction.) Next, a stack is characterized by the operations you can perform on it:

- You can create an empty stack.
- You can add an item to the top of a stack (that is, you can *push* an item).
- You can remove an item from the top (that is, you can *pop* an item).
- You can check whether the stack is full.
- You can check whether the stack is empty.

You can match this description with a class declaration in which the public member functions provide an interface that represents the stack operations. The private data members take care of storing the stack data. The class concept is a nice match to the ADT approach.

The private section has to commit itself to how to hold the data. For example, you can use an ordinary array, a dynamically allocated array, or some more advanced data structure, such as a linked list. However, the public interface should hide the exact representation. Instead, it should be expressed in general terms, such as creating a stack, pushing an item, and so on. Listing 10.10 shows one approach. It assumes that the `bool` type has been implemented. If it hasn't been implemented on your system, you can use `int`, 0, and 1 rather than `bool`, `false`, and `true`.

#### Listing 10.10 `stack.h`

---

```
// stack.h -- class definition for the stack ADT
#ifndef STACK_H_
#define STACK_H_

typedef unsigned long Item;

class Stack
{
private:
    enum {MAX = 10}; // constant specific to class
    Item items[MAX]; // holds stack items
    int top; // index for top stack item
public:
    Stack();
    bool isempty() const;
    bool isfull() const;
    // push() returns false if stack already is full, true otherwise
    bool push(const Item & item); // add item to stack
};
```



```

    // pop() returns false if stack already is empty, true otherwise
    bool pop(Item & item);          // pop top into item
};
#endif

```

---

In the example in Listing 10.10, the private section shows that the stack is implemented by using an array, but the public section doesn't reveal that fact. Thus, you can replace the array with, say, a dynamic array without changing the class interface. This means changing the stack implementation doesn't require that you recode programs that use the stack. You just recompile the stack code and link it with existing program code.

The interface is redundant in that `pop()` and `push()` return information about the stack status (full or empty) instead of being type `void`. This provides the programmer with a couple options as to how to handle exceeding the stack limit or emptying the stack. He or she can use `isempty()` and `isfull()` to check before attempting to modify the stack, or else use the return value of `push()` and `pop()` to determine whether the operation is successful.

Rather than define the stack in terms of some particular type, the class describes it in terms of a general `Item` type. In this case, the header file uses `typedef` to make `Item` the same as `unsigned long`. If you want, say, a stack of `doubles` or of a structure type, you can change the `typedef` and leave the class declaration and method definitions unaltered. Class templates (see Chapter 14, "Reusing Code in C++") provide a more powerful method for isolating from the class design the type of data stored.

Next, you need to implement the class methods. Listing 10.11 shows one possibility.

#### Listing 10.11 `stack.cpp`

---

```

// stack.cpp -- Stack member functions
#include "stack.h"
Stack::Stack()    // create an empty stack
{
    top = 0;
}

bool Stack::isempty() const
{
    return top == 0;
}

bool Stack::isfull() const
{
    return top == MAX;
}

bool Stack::push(const Item & item)
{

```

```
    if (top < MAX)
    {
        items[top++] = item;
        return true;
    }
    else
        return false;
}

bool Stack::pop(Item & item)
{
    if (top > 0)
    {
        item = items[--top];
        return true;
    }
    else
        return false;
}
```

---

The default constructor guarantees that all stacks are created empty. The code for `pop()` and `push()` guarantees that the top of the stack is managed properly. Guarantees like this are one of the things that make OOP reliable. Suppose that, instead, you create a separate array to represent the stack and an independent variable to represent the index of the top. In that case, it is your responsibility to get the code right each time you create a new stack. Without the protection that private data offers, there's always the possibility of making some program blunder that alters data unintentionally.

Let's test this stack. Listing 10.12 models the life of a clerk who processes purchase orders from the top of his in-basket, using the LIFO (last-in, first-out) approach of a stack.

---

#### Listing 10.12 `stacker.cpp`

---

```
// stacker.cpp -- testing the Stack class
#include <iostream>
#include <cctype> // or ctype.h
#include "stack.h"
int main()
{
    using namespace std;
    Stack st; // create an empty stack
    char ch;
    unsigned long po;
    cout << "Please enter A to add a purchase order,\n"
        << "P to process a PO, or Q to quit.\n";
    while (cin >> ch && toupper(ch) != 'Q')
    {
```

```

while (cin.get() != '\n')
    continue;
if (!isalpha(ch))
{
    cout << '\a';
    continue;
}
switch(ch)
{
    case 'A':
    case 'a': cout << "Enter a PO number to add: ";
              cin >> po;
              if (st.isfull())
                  cout << "stack already full\n";
              else
                  st.push(po);
              break;
    case 'P':
    case 'p': if (st.isempty())
              cout << "stack already empty\n";
              else {
                  st.pop(po);
                  cout << "PO #" << po << " popped\n";
              }
              break;
}
cout << "Please enter A to add a purchase order,\n"
      << "P to process a PO, or Q to quit.\n";
}
cout << "Bye\n";
return 0;
}

```

---

The little `while` loop in Listing 10.12 that gets rid of the rest of the line isn't absolutely necessary at this point, but it will come in handy in a modification of this program in Chapter 14. Here's a sample run:

```

Please enter A to add a purchase order,
P to process a PO, or Q to quit.

```

**A**

```

Enter a PO number to add: 17885

```

```

Please enter A to add a purchase order,
P to process a PO, or Q to quit.

```

**P**

```

PO #17885 popped

```

```

Please enter A to add a purchase order,

```

```
P to process a PO, or Q to quit.
A
Enter a PO number to add: 17965
Please enter A to add a purchase order,
P to process a PO, or Q to quit.
A
Enter a PO number to add: 18002
Please enter A to add a purchase order,
P to process a PO, or Q to quit.
P
PO #18002 popped
Please enter A to add a purchase order,
P to process a PO, or Q to quit.
P
PO #17965 popped
Please enter A to add a purchase order,
P to process a PO, or Q to quit.
P
stack already empty
Please enter A to add a purchase order,
P to process a PO, or Q to quit.
Q
Bye
```

## Summary

OOP emphasizes how a program represents data. The first step toward solving a programming problem by using the OOP approach is to describe the data in terms of its interface with the program, specifying how the data is used. Next, you need to design a class that implements the interface. Typically, private data members store the information, whereas public member functions, also called methods, provide the only access to the data. The class combines data and methods into one unit, and the private aspect accomplishes data hiding.

Usually, you separate a class declaration into two parts, typically kept in separate files. The class declaration proper goes into a header file, with the methods represented by function prototypes. The source code that defines the member functions goes into a methods file. This approach separates the description of the interface from the details of the implementation. In principle, you need to know only the public class interface to use the class. Of course, you can look at the implementation (unless it's been supplied to you in compiled form only), but your program shouldn't rely on details of the implementation, such as knowing that a particular value is stored as an `int`. As long as a program and a class communicate only through methods defining the interface, you are free to improve either part separately without worrying about unforeseen interactions.

A class is a user-defined type, and an object is an instance of a class. This means an object is a variable of that type or the equivalent of a variable, such as memory allocated by `new` according to the class specification. C++ tries to make user-defined types as similar as possible to standard types, so you can declare objects, pointers to objects, and arrays of objects. You can pass objects as arguments, return them as function return values, and assign one object to another of the same type. If you provide a constructor method, you can initialize objects when they are created. If you provide a destructor method, the program executes that method when the object expires.

Each object holds its own copies of the data portion of a class declaration, but they share the class methods. If `mr_object` is the name of a particular object and `try_me()` is a member function, you invoke the member function by using the dot membership operator: `mr_object.try_me()`. OOP terminology describes this function call as sending a `try_me` message to the `mr_object` object. Any reference to class data members in the `try_me()` method then applies to the data members of the `mr_object` object. Similarly, the function call `i_object.try_me()` accesses the data members of the `i_object` object.

If you want a member function to act on more than one object, you can pass additional objects to the method as arguments. If a method needs to refer explicitly to the object that evoked it, it can use the `this` pointer. The `this` pointer is set to the address of the evoking object, so `*this` is an alias for the object itself.

Classes are well matched to describing ADTs. The public member function interface provides the services described by an ADT, and the class's private section and the code for the class methods provide an implementation that is hidden from clients of the class.

## Chapter Review

1. What is a class?
2. How does a class accomplish abstraction, encapsulation, and data hiding?
3. What is the relationship between an object and a class?
4. In what way, aside from being functions, are class function members different from class data members?
5. Define a class to represent a bank account. Data members should include the depositor's name, the account number (use a string), and the balance. Member functions should allow the following:
  - Creating an object and initializing it.
  - Displaying the depositor's name, account number, and balance
  - Depositing an amount of money given by an argument
  - Withdrawing an amount of money given by an argument

Just show the class declaration, not the method implementations. (Programming Exercise 1 provides you with an opportunity to write the implementation.)

6. When are class constructors called? When are class destructors called?
7. Provide code for a constructor for the bank account class from Chapter Review Question 5.
8. What is a default constructor? What is the advantage of having one?
9. Modify the `stock` class definition (the version in `stock20.h`) so that it has member functions that return the values of the individual data members. Note: A member that returns the company name should not provide a weapon for altering the array. That is, it can't simply return a `string` reference. It could return a `const` reference.
10. What are `this` and `*this`?

## Programming Exercises

1. Provide method definitions for the class described in Chapter Review Question 5 and write a short program that illustrates all the features.
2. Here is a rather simple class definition:

```
class Person {
private:
    static const LIMIT = 25;
    string lname;        // Person's last name
    char fname[LIMIT];  // Person's first name
public:
    Person() {lname = ""; fname[0] = '\0'; } // #1
    Person(const string & ln, const char * fn = "Heyyou"); // #2
    // the following methods display lname and fname
    void Show() const;        // firstname lastname format
    void FormalShow() const; // lastname, firstname format
};
```

(It uses both a `string` object and a character array so that you can compare how the two forms are used.) Write a program that completes the implementation by providing code for the undefined methods. The program in which you use the class should also use the three possible constructor calls (no arguments, one argument, and two arguments) and the two display methods. Here's an example that uses the constructors and methods:

```
Person one;                // use default constructor
Person two("Smythecraft"); // use #2 with one default argument
Person three("Dimwiddy", "Sam"); // use #2, no defaults
one.Show();
cout << endl;
one.FormalShow();
// etc. for two and three
```

3. Do Programming Exercise 1 from Chapter 9 but replace the code shown there with an appropriate `golf` class declaration. Replace `setgolf(golf &, const char*`,

`int`) with a constructor with the appropriate argument for providing initial values. Retain the interactive version of `setgolf()` but implement it by using the constructor. (For example, for the code for `setgolf()`, obtain the data, pass the data to the constructor to create a temporary object, and assign the temporary object to the invoking object, which is `*this`.)

4. Do Programming Exercise 4 from Chapter 9 but convert the `sales` structure and its associated functions to a class and its methods. Replace the `setSales(Sales &, double [], int)` function with a constructor. Implement the interactive `setSales(Sales &)` method by using the constructor. Keep the class within the namespace `SALES`.
5. Consider the following structure declaration:

```
struct customer {
    char fullname[35];
    double payment;
};
```

Write a program that adds and removes customer structures from a stack, represented by a `Stack` class declaration. Each time a customer is removed, his or her payment should be added to a running total, and the running total should be reported. Note: You should be able to use the `Stack` class unaltered; just change the `typedef` declaration so that `Item` is type `customer` instead of `unsigned long`.

6. Here's a class declaration:

```
class Move
{
private:
    double x;
    double y;
public:
    Move(double a = 0, double b = 0); // sets x, y to a, b
    showmove() const; // shows current x, y values
    Move add(const Move & m) const;
    // this function adds x of m to x of invoking object to get new x,
    // adds y of m to y of invoking object to get new y, creates a new
    // move object initialized to new x, y values and returns it
    reset(double a = 0, double b = 0); // resets x,y to a, b
};
```

Create member function definitions and a program that exercises the class.

7. A Betelgeusean plorg has these properties:

### Data

A plorg has a name with no more than 19 letters.

A plorg has a contentment index (CI), which is an integer.

### Operations

A new plorg starts out with a name and a CI of 50.

A plorg's CI can change.

A plorg can report its name and CI.

The default plorg has the name "Plorga".

Write a `Plorg` class declaration (including data members and member function prototypes) that represents a plorg. Write the function definitions for the member functions. Write a short program that demonstrates all the features of the `Plorg` class.

8. You can describe a simple list as follows:

- The simple list can hold zero or more items of some particular type.
- You can create an empty list.
- You can add items to the list.
- You can determine whether the list is empty.
- You can determine whether the list is full.
- You can visit each item in the list and perform some action on it.

As you can see, this list really is simple; it doesn't allow insertion or deletion, for example.

Design a `List` class to represent this abstract type. You should provide a `list.h` header file with the class declaration and a `list.cpp` file with the class method implementations. You should also create a short program that utilizes your design.

The main reason for keeping the list specification simple is to simplify this programming exercise. You can implement the list as an array or, if you're familiar with the data type, as a linked list. But the public interface should not depend on your choice. That is, the public interface should not have array indices, pointers to nodes, and so on. It should be expressed in the general concepts of creating a list, adding



an item to the list, and so on. The usual way to handle visiting each item and performing an action is to use a function that takes a function pointer as an argument:

```
void visit(void (*pf)(Item &));
```

Here `pf` points to a function (not a member function) that takes a reference to `Item` argument, where `Item` is the type for items in the list. The `visit()` function applies this function to each item in the list. You can use the `Stack` class as a general guide.

# Working with Classes

In this chapter you'll learn about the following:

- Operator overloading
- Friend functions
- Overloading the `<<` operator for output
- State members
- Using `rand()` to generate random values
- Automatic conversions and type casts for classes
- Class conversion functions

C++ classes are feature-rich, complex, and powerful. In Chapter 10, “Objects and Classes,” you began a journey toward object-oriented programming by learning to define and use a simple class. You saw how a class defines a data type by defining the type of data to be used to represent an object and by also defining, through member functions, the operations that can be performed with that data. And you learned about two special member functions, the constructor and the destructor, that manage creating and discarding objects made to a class specification. This chapter takes you a few steps further in the exploration of class properties, concentrating on class design techniques rather than on general principles. You'll probably find some of the features covered here straightforward and some a bit more subtle. To best understand these new features, you should try the examples and experiment with them: What happens if you use a regular argument instead of a reference argument for this function? What happens if you leave something out of a destructor? Don't be afraid to make mistakes; usually you can learn more from unraveling an error than by doing something correctly but by rote. (However, don't assume that a maelstrom of mistakes inevitably leads to incredible insight.) In the end, you'll be rewarded with a fuller understanding of how C++ works and of what C++ can do for you.

This chapter starts with operator overloading, which lets you use standard C++ operators such as `=` and `+` with class objects. Then it examines friends, the C++ mechanism for letting nonmember functions access private data. Finally, it looks at how you can instruct

C++ to perform automatic type conversions with classes. As you go through this chapter and Chapter 12, “Classes and Dynamic Memory Allocation,” you’ll gain a greater appreciation of the roles class constructors and class destructors play. Also you’ll see some of the stages you may go through as you develop and improve a class design.

One difficulty with learning C++, at least by the time you’ve gotten this far into the subject, is that there is an awful lot to remember. And it’s unreasonable to expect to remember it all until you’ve logged enough experience on which to hang your memories. Learning C++, in this respect, is like learning a feature-laden word processor or spreadsheet program. No one feature is that daunting, but, in practice, most people really know well only those features they use regularly, such as searching for text or italicizing. You may recall having read somewhere how to generate alternative characters or create a table of contents, but those skills probably won’t be part of your daily repertoire until you face a situation in which you need them frequently. Probably the best approach to absorbing the wealth of material in this chapter is to begin incorporating just some of these new features into your own C++ programming. As your experiences enhance your understanding and appreciation of these features, you can begin adding other C++ features. As Bjarne Stroustrup, the creator of C++, suggested at a C++ conference for professional programmers: “Ease yourself into the language. Don’t feel you have to use all of the features, and don’t try to use them all on the first day.”

## Operator Overloading

Let’s look at a technique for giving object operations a prettier look. *Operator overloading* is an example of C++ polymorphism. In Chapter 8, “Adventures in Functions,” you saw how C++ enables you to define several functions that have the same name, provided that they have different signatures (argument lists). That is called *function overloading*, or *functional polymorphism*. Its purpose is to let you use the same function name for the same basic operation, even though you apply the operation to different data types. (Imagine how awkward English would be if you had to use a different verb form for each different type of object—for example, lift\_lft your left foot, but lift\_sp your spoon.) Operator overloading extends the overloading concept to operators, letting you assign multiple meanings to C++ operators. Actually, many C++ (and C) operators already are overloaded. For example, the \* operator, when applied to an address, yields the value stored at that address. But applying \* to two numbers yields the product of the values. C++ uses the number and type of operands to decide which action to take.

C++ lets you extend operator overloading to user-defined types, permitting you, say, to use the + symbol to add two objects. Again, the compiler uses the number and type of operands to determine which definition of addition to use. Overloaded operators can often make code look more natural. For example, a common computing task is adding two arrays. Usually, this winds up looking like the following for loop:

```
for (int i = 0; i < 20; i++)
    evening[i] = sam[i] + janet[i]; // add element by element
```

But in C++, you can define a class that represents arrays and that overloads the + operator so that you can do this:

```
evening = sam + janet;           // add two array objects
```

This simple addition notation conceals the mechanics and emphasizes what is essential, and that is another goal of OOP.

To overload an operator, you use a special function form called an *operator function*. An operator function has the following form, where *op* is the symbol for the operator being overloaded:

```
operatorop(argument-list)
```

For example, `operator+()` overloads the + operator and `operator*()` overloads the \* operator. The *op* has to be a valid C++ operator; you can't just make up a new symbol. For example, you can't have an `operator@()` function because C++ has no @ operator. But the `operator[]()` function would overload the [] operator because [] is the array-indexing operator. Suppose, for example, that you have a `Salesperson` class for which you define an `operator+()` member function to overload the + operator so that it adds sales figures of one salesperson object to another. Then, if `district2`, `sid`, and `sara` are all objects of the `Salesperson` class, you can write this equation:

```
district2 = sid + sara;
```

The compiler, recognizing the operands as belonging to the `Salesperson` class, replaces the operator with the corresponding operator function:

```
district2 = sid.operator+(sara);
```

The function then uses the `sid` object implicitly (because it invoked the method) and the `sara` object explicitly (because it's passed as an argument) to calculate the sum, which it then returns. Of course, the nice part is that you can use the nifty + operator notation instead of the clunky function notation.

C++ imposes some restrictions on operator overloading, but they're easiest to understand after you've seen how overloading works. So let's develop a few examples to clarify the process and then discuss the limitations.

## Time on Our Hands: Developing an Operator Overloading Example

If you worked on the Priggs account for 2 hours 35 minutes in the morning and 2 hours 40 minutes in the afternoon, how long did you work altogether on the account? Here's an example where the concept of addition makes sense, but the units that you are adding (a mixture of hours and minutes) don't match a built-in type. Chapter 7, "Functions: C++'s Programming Modules," handles a similar case by defining a `travel_time` structure and a `sum()` function for adding such structures. Now let's generalize that to a `Time` class, using a method to handle addition. Let's begin with an ordinary method, called

`Sum()`, and then see how to convert it to an overloaded operator. Listing 11.1 shows the class declaration.

Listing 11.1 **mytime0.h**

---

```
// mytime0.h -- Time class before operator overloading
#ifndef MYTIME0_H_
#define MYTIME0_H_

class Time
{
private:
    int hours;
    int minutes;
public:
    Time();
    Time(int h, int m = 0);
    void AddMin(int m);
    void AddHr(int h);
    void Reset(int h = 0, int m = 0);
    Time Sum(const Time & t) const;
    void Show() const;
};
#endif
```

---

The `Time` class provides methods for adjusting and resetting times, for displaying time values, and for adding two times. Listing 11.2 shows the methods definitions; note how the `AddMin()` and `Sum()` methods use integer division and the modulus operator to adjust the `minutes` and `hours` values when the total number of minutes exceeds 59. Also because the only `iostream` feature used is `cout` and because it is used only once, it seems economical to use `std::cout` rather than use the whole `std` namespace.

Listing 11.2 **mytime0.cpp**

---

```
// mytime0.cpp -- implementing Time methods
#include <iostream>
#include "mytime0.h"

Time::Time()
{
    hours = minutes = 0;
}

Time::Time(int h, int m )
{
    hours = h;
```

```
    minutes = m;
}

void Time::AddMin(int m)
{
    minutes += m;
    hours += minutes / 60;
    minutes %= 60;
}

void Time::AddHr(int h)
{
    hours += h;
}

void Time::Reset(int h, int m)
{
    hours = h;
    minutes = m;
}

Time Time::Sum(const Time & t) const
{
    Time sum;
    sum.minutes = minutes + t.minutes;
    sum.hours = hours + t.hours + sum.minutes / 60;
    sum.minutes %= 60;
    return sum;
}

void Time::Show() const
{
    std::cout << hours << " hours, " << minutes << " minutes";
}
```

---

Consider the code for the `sum()` function. Note that the argument is a reference but that the return type is not a reference. The reason for making the argument a reference is efficiency. The code would produce the same results if the `Time` object were passed by value, but it's usually faster and more memory-efficient to just pass a reference.

However, the return value cannot be a reference. The reason is that the function creates a new `Time` object (`sum`) that represents the sum of the other two `Time` objects. Returning the object, as this code does, creates a copy of the object that the calling function can use. If the return type were `Time &`, however, the reference would be to the `sum` object. But the `sum` object is a local variable and is destroyed when the function terminates, so the reference would be a reference to a non-existent object. Using a `Time` return

type, however, means the program constructs a *copy* of `sum` before destroying it, and the calling function gets the copy.

### Caution

Don't return a reference to a local variable or another temporary object. When the function terminates and the local variable or temporary object disappears, the reference becomes a reference to non-existent data.

Finally, Listing 11.3 tests the time summation part of the `Time` class.

#### Listing 11.3 `usetime0.cpp`

---

```
// usetime0.cpp -- using the first draft of the Time class
// compile usetime0.cpp and mytime0.cpp together
#include <iostream>
#include "mytime0.h"

int main()
{
    using std::cout;
    using std::endl;
    Time planning;
    Time coding(2, 40);
    Time fixing(5, 55);
    Time total;

    cout << "planning time = ";
    planning.Show();
    cout << endl;

    cout << "coding time = ";
    coding.Show();
    cout << endl;

    cout << "fixing time = ";
    fixing.Show();
    cout << endl;

    total = coding.Sum(fixing);
    cout << "coding.Sum(fixing) = ";
    total.Show();
    cout << endl;

    return 0;
}
```

---

Here is the output of the program in Listings 11.1, 11.2, and 11.3:

```
planning time = 0 hours, 0 minutes
coding time = 2 hours, 40 minutes
fixing time = 5 hours, 55 minutes
coding.Sum(fixing) = 8 hours, 35 minutes
```

## Adding an Addition Operator

It's a simple matter to convert the `Time` class to using an overloaded addition operator. You just change the name of `Sum()` to the odder-looking name `operator+()`. That's right: You just append the operator symbol (+, in this case) to the end of `operator` and use the result as a method name. This is one place where you can use a character other than a letter, a digit, or an underscore in an identifier name. Listings 11.4 and 11.5 reflect this small change.

### Listing 11.4 `mytime1.h`

---

```
// mytime1.h -- Time class before operator overloading
#ifndef MYTIME1_H_
#define MYTIME1_H_

class Time
{
private:
    int hours;
    int minutes;
public:
    Time();
    Time(int h, int m = 0);
    void AddMin(int m);
    void AddHr(int h);
    void Reset(int h = 0, int m = 0);
    Time operator+(const Time & t) const;
    void Show() const;
};
#endif
```

---

### Listing 11.5 `mytime1.cpp`

---

```
// mytime1.cpp -- implementing Time methods
#include <iostream>
#include "mytime1.h"

Time::Time()
{
```



```

        hours = minutes = 0;
    }

Time::Time(int h, int m )
{
    hours = h;
    minutes = m;
}

void Time::AddMin(int m)
{
    minutes += m;
    hours += minutes / 60;
    minutes %= 60;
}

void Time::AddHr(int h)
{
    hours += h;
}

void Time::Reset(int h, int m)
{
    hours = h;
    minutes = m;
}

Time Time::operator+(const Time & t) const
{
    Time sum;
    sum.minutes = minutes + t.minutes;
    sum.hours = hours + t.hours + sum.minutes / 60;
    sum.minutes %= 60;
    return sum;
}

void Time::Show() const
{
    std::cout << hours << " hours, " << minutes << " minutes";
}

```

---

Like `Sum()`, `operator+()` is invoked by a `Time` object, takes a second `Time` object as an argument, and returns a `Time` object. Thus, you can invoke the `operator+()` method by using the same syntax that `Sum()` uses:

```
total = coding.operator+(fixing);    // function notation
```

But naming the method `operator+()` also lets you use operator notation:

```
total = coding + fixing;           // operator notation
```

Either notation invokes the `operator+()` method. Note that with the operator notation, the object to the left of the operator (`coding`, in this case) is the invoking object, and the object to the right (`fixing`, in this case) is the one passed as an argument. Listing 11.6 illustrates this point.

#### Listing 11.6 `usetime1.cpp`

---

```
// usetime1.cpp -- using the second draft of the Time class
// compile usetime1.cpp and mytime1.cpp together
#include <iostream>
#include "mytime1.h"

int main()
{
    using std::cout;
    using std::endl;
    Time planning;
    Time coding(2, 40);
    Time fixing(5, 55);
    Time total;

    cout << "planning time = ";
    planning.Show();
    cout << endl;

    cout << "coding time = ";
    coding.Show();
    cout << endl;

    cout << "fixing time = ";
    fixing.Show();
    cout << endl;

    total = coding + fixing;
    // operator notation
    cout << "coding + fixing = ";
    total.Show();
    cout << endl;

    Time morefixing(3, 28);
    cout << "more fixing time = ";
    morefixing.Show();
    cout << endl;
    total = morefixing.operator+(total);
```

```

    // function notation
    cout << "morefixing.operator+(total) = ";
    total.Show();
    cout << endl;

    return 0;
}

```

---

Here is the output of the program in Listings 11.4, 11.5, and 11.6:

```

planning time = 0 hours, 0 minutes
coding time = 2 hours, 40 minutes
fixing time = 5 hours, 55 minutes
coding + fixing = 8 hours, 35 minutes
more fixing time = 3 hours, 28 minutes
morefixing.operator+(total) = 12 hours, 3 minutes

```

In short, the name of the `operator+()` function allows it to be invoked by using either function notation or operator notation. The compiler uses the operand types to figure out what to do:

```

int a, b, c;
Time A, B, C;
c = a + b;      // use int addition
C = A + B;     // use addition as defined for Time objects

```

Can you add more than two objects? For example, if `t1`, `t2`, `t3`, and `t4` are all `Time` objects, can you do the following?

```
t4 = t1 + t2 + t3;           // valid?
```

The way to answer this is to consider how the statement gets translated into function calls. Because addition is a left-to-right operator, the statement is first translated to this:

```
t4 = t1.operator+(t2 + t3);   // valid?
```

Then the function argument is itself translated to a function call, giving the following:

```
t4 = t1.operator+(t2.operator+(t3)); // valid? YES
```

Is this valid? Yes, it is. The function call `t2.operator+(t3)` returns a `Time` object that represents the sum of `t2` and `t3`. This object then becomes the object of the `t1.operator+()` function call, and that call returns the sum of `t1` and the `Time` object that represents the sum of `t2` and `t3`. In short, the final return value is the sum of `t1`, `t2`, and `t3`, just as desired.

## Overloading Restrictions

Most C++ operators (see Table 11.1) can be overloaded in the manner described in the preceding section. Overloaded operators (with some exceptions) don't necessarily have to be member functions. However, at least one of the operands has to be a user-defined type. Let's take a closer look at the limits C++ imposes on user-defined operator overloading:

- The overloaded operator must have at least one operand that is a user-defined type. This prevents you from overloading operators for the standard types. Thus, you can't redefine the minus operator (-) so that it yields the sum of two `double` values instead of their difference. This restriction preserves program sanity, although it may hinder creative accounting.
- You can't use an operator in a manner that violates the syntax rules for the original operator. For example, you can't overload the modulus operator (%) so that it can be used with a single operand:

```
int x;
Time shiva;
% x;          // invalid for modulus operator
% shiva;     // invalid for overloaded operator
```

Similarly, you can't alter operator precedence. So if you overload the addition operator to let you add two classes, the new operator has the same precedence as ordinary addition.

- You can't create new operator symbols. For example, you can't define an `operator**()` function to denote exponentiation.
- You cannot overload the following operators:

| Operator                      | Description                      |
|-------------------------------|----------------------------------|
| <code>sizeof</code>           | The <code>sizeof</code> operator |
| <code>.</code>                | The membership operator          |
| <code>.*</code>               | The pointer-to-member operator   |
| <code>::</code>               | The scope-resolution operator    |
| <code>?:</code>               | The conditional operator         |
| <code>typeid</code>           | An RTTI operator                 |
| <code>const_cast</code>       | A type cast operator             |
| <code>dynamic_cast</code>     | A type cast operator             |
| <code>reinterpret_cast</code> | A type cast operator             |
| <code>static_cast</code>      | A type cast operator             |

This still leaves all the operators in Table 11.1 available for overloading.

- Most of the operators in Table 11.1 can be overloaded by using either member or nonmember functions. However, you can use *only* member functions to overload the following operators:

| Operator | Description                             |
|----------|-----------------------------------------|
| =        | Assignment operator                     |
| ()       | Function call operator                  |
| []       | Subscripting operator                   |
| ->       | Class member access by pointer operator |

### Note

This chapter does not cover every operator mentioned in the list of restrictions or in Table 11.1. However, Appendix E, “Other Operators,” summarizes the operators that are not covered in the main body of this text.

Table 11.1 Operators That Can Be Overloaded

|     |    |     |        |        |           |
|-----|----|-----|--------|--------|-----------|
| +   | -  | *   | /      | %      | ^         |
| &   |    | ~   | !      | =      | <         |
| >   | += | -=  | *=     | /=     | %=        |
| ^=  | &= | =   | <<     | >>     | >>=       |
| <<= | == | !=  | <=     | >=     | &&        |
|     | ++ | --  | ,      | ->*    | ->        |
| ()  | [] | new | delete | new [] | delete [] |

In addition to these formal restrictions, you should use sensible restraint in overloading operators. For example, you shouldn’t overload the `*` operator so that it swaps the data members of two `Time` objects. Nothing in the notation would suggest what the operator did, so it would be better to define a class method with an explanatory name such as `Swap()`.

## More Overloaded Operators

Some other operations make sense for the `Time` class. For example, you might want to subtract one time from another or multiply a time by a factor. This suggests overloading the subtraction and multiplication operators. The technique is the same as for the addition operator: you create `operator-()` and `operator*()` methods. That is, you add the following prototypes to the class declaration:

```
Time operator-(const Time & t) const;
Time operator*(double n) const;
```

Listing 11.7 shows the new header file.

**Listing 11.7 mytime2.h**

---

```
// mytime2.h -- Time class after operator overloading
#ifndef MYTIME2_H_
#define MYTIME2_H_

class Time
{
private:
    int hours;
    int minutes;
public:
    Time();
    Time(int h, int m = 0);
    void AddMin(int m);
    void AddHr(int h);
    void Reset(int h = 0, int m = 0);
    Time operator+(const Time & t) const;
    Time operator-(const Time & t) const;
    Time operator*(double n) const;
    void Show() const;
};
#endif
```

---

Then you add definitions for the new methods to the implementation file, as shown in Listing 11.8.

**Listing 11.8 mytime2.cpp**

---

```
// mytime2.cpp -- implementing Time methods
#include <iostream>
#include "mytime2.h"

Time::Time()
{
    hours = minutes = 0;
}

Time::Time(int h, int m )
{
    hours = h;
    minutes = m;
}

void Time::AddMin(int m)
{
```

```
        minutes += m;
        hours += minutes / 60;
        minutes %= 60;
    }
void Time::AddHr(int h)
{
    hours += h;
}

void Time::Reset(int h, int m)
{
    hours = h;
    minutes = m;
}

Time Time::operator+(const Time & t) const
{
    Time sum;
    sum.minutes = minutes + t.minutes;
    sum.hours = hours + t.hours + sum.minutes / 60;
    sum.minutes %= 60;
    return sum;
}

Time Time::operator-(const Time & t) const
{
    Time diff;
    int tot1, tot2;
    tot1 = t.minutes + 60 * t.hours;
    tot2 = minutes + 60 * hours;
    diff.minutes = (tot2 - tot1) % 60;
    diff.hours = (tot2 - tot1) / 60;
    return diff;
}

Time Time::operator*(double mult) const
{
    Time result;
    long totalminutes = hours * mult * 60 + minutes * mult;
    result.hours = totalminutes / 60;
    result.minutes = totalminutes % 60;
    return result;
}

void Time::Show() const
{
    std::cout << hours << " hours, " << minutes << " minutes";
}

```

---

With these changes made, you can test the new definitions with the code shown in Listing 11.9.

**Listing 11.9** `usetime2.cpp`

---

```
// usetime2.cpp -- using the third draft of the Time class
// compile usetime2.cpp and mytime2.cpp together
#include <iostream>
#include "mytime2.h"

int main()
{
    using std::cout;
    using std::endl;
    Time weeding(4, 35);
    Time waxing(2, 47);
    Time total;
    Time diff;
    Time adjusted;

    cout << "weeding time = ";
    weeding.Show();
    cout << endl;

    cout << "waxing time = ";
    waxing.Show();
    cout << endl;

    cout << "total work time = ";
    total = weeding + waxing;    // use operator+()
    total.Show();
    cout << endl;

    diff = weeding - waxing;    // use operator-()
    cout << "weeding time - waxing time = ";
    diff.Show();
    cout << endl;

    adjusted = total * 1.5;      // use operator+()
    cout << "adjusted work time = ";
    adjusted.Show();
    cout << endl;

    return 0;
}
```

---



Here is the output of the program in Listings 11.7, 11.8, and 11.9:

```
weeding time = 4 hours, 35 minutes
waxing time = 2 hours, 47 minutes
total work time = 7 hours, 22 minutes
weeding time - waxing time = 1 hours, 48 minutes
adjusted work time = 11 hours, 3 minutes
```

## Introducing Friends

As you've seen, C++ controls access to the private portions of a class object. Usually, public class methods serve as the only access, but sometimes this restriction is too rigid to fit particular programming problems. In such cases, C++ provides another form of access: the *friend*. Friends come in three varieties:

- Friend functions
- Friend classes
- Friend member functions

By making a function a friend to a class, you allow the function the same access privileges that a member function of the class has. We'll look into friend functions now, leaving the other two varieties to Chapter 15, "Friends, Exceptions, and More."

Before seeing how to make friends, let's look into why they might be needed. Often, overloading a binary operator (that is, an operator with two arguments) for a class generates a need for friends. Multiplying a `Time` object by a real number provides just such a situation, so let's study that case.

In the previous `Time` class example, the overloaded multiplication operator is different from the other two overloaded operators in that it combines two different types. That is, the addition and subtraction operators each combine two `Time` values, but the multiplication operator combines a `Time` value with a `double` value. This restricts how the operator can be used. Remember, the left operand is the invoking object. That is,

```
A = B * 2.75;
```

translates to the following member function call:

```
A = B.operator*(2.75);
```

But what about the following statement?

```
A = 2.75 * B;    // cannot correspond to a member function
```

Conceptually, `2.75 * B` should be the same as `B * 2.75`, but the first expression cannot correspond to a member function because `2.75` is not a type `Time` object. Remember, the left operand is the invoking object, but `2.75` is not an object. So the compiler cannot replace the expression with a member function call.

One way around this difficulty is to tell everyone (and to remember yourself) that you can only write `B * 2.75` but never write `2.75 * B`. This is a server-friendly, client-beware solution, and that's not what OOP is about.

However, there is another possibility—using a nonmember function. (Remember, most operators can be overloaded using either member or nonmember functions.) A nonmember function is not invoked by an object; instead, any values it uses, including objects, are explicit arguments. Thus, the compiler could match the expression

```
A = 2.75 * B;    // cannot correspond to a member function
```

to the following nonmember function call:

```
A = operator*(2.75, B);
```

The function would have this prototype:

```
Time operator*(double m, const Time & t);
```

With the nonmember overloaded operator function, the left operand of an operator expression corresponds to the first argument of the operator function, and the right operand corresponds to the second argument. Meanwhile, the original member function handles operands in the opposite order—that is, a `Time` value multiplied by a `double` value.

Using a nonmember function solves the problem of getting the operands in the desired order (first `double` and then `Time`), but it raises a new problem: Nonmember functions can't directly access private data in a class. Well, at least ordinary nonmember functions lack access. But there is a special category of nonmember functions, called *friends*, that can access private members of a class.

## Creating Friends

The first step toward creating a friend function is to place a prototype in the class declaration and prefix the declaration with the keyword `friend`:

```
friend Time operator*(double m, const Time & t); // goes in class declaration
```

This prototype has two implications:

- Although the `operator*()` function is declared in the class declaration, it is not a member function. So it isn't invoked by using the membership operator.
- Although the `operator*()` function is not a member function, it has the same access rights as a member function.

The second step is to write the function definition. Because it is not a member function, you don't use the `Time::` qualifier. Also you don't use the `friend` keyword in the definition. The definition should look like this:

```
Time operator*(double m, const Time & t) // friend not used in definition
{
    Time result;
    long totalminutes = t.hours * mult * 60 + t.minutes * mult;
    result.hours = totalminutes / 60;
```

```

    result.minutes = totalminutes % 60;
    return result;
}

```

With this declaration and definition, the statement

```
A = 2.75 * B;
```

translates to the following and invokes the nonmember friend function just defined:

```
A = operator*(2.75, B);
```

In short, a friend function to a class is a nonmember function that has the same access rights as a member function.

### Are Friends Unfaithful to OOP?

At first glance, it might seem that friends violate the OOP principle of data hiding because the friend mechanism allows nonmember functions to access private data. However, that's an overly narrow view. Instead, you should think of friend functions as part of an extended interface for a class. For example, from a conceptual point of view, multiplying a `double` by a `Time` value is pretty much the same as multiplying a `Time` value by a `double`. That the first requires a friend function whereas the second can be done with a member function is the result of C++ syntax, not of a deep conceptual difference. By using both a friend function and a class method, you can express either operation with the same user interface. Also keep in mind that only a class declaration can decide which functions are friends, so the class declaration still controls which functions access private data. In short, class methods and friends are simply two different mechanisms for expressing a class interface.

Actually, you can write this particular friend function as a non-friend by altering the definition so that it switches which value comes first in the multiplication:

```

Time operator*(double m, const Time & t)
{
    return t * m;    // use t.operator*(m)
}

```

The original version accessed `t.minutes` and `t.hours` explicitly, so it had to be a friend. This version only uses the `Time` object `t` as a whole, letting a member function handle the private values, so this version doesn't have to be a friend. Nonetheless, there are reasons to make this version a friend, too. Most importantly, it ties the function in as part of the official class interface. Second, if you later find a need for the function to access private data directly, you only have to change the function definition and not the class prototype.

### Tip

If you want to overload an operator for a class and you want to use the operator with a non-class term as the first operand, you can use a friend function to reverse the operand order.

## A Common Kind of Friend: Overloading the << Operator

One very useful feature of classes is that you can overload the << operator so that you can use it with `cout` to display an object's contents. In some ways, this overloading is a bit trickier than the earlier examples, so we'll develop it in two steps instead of in one.

Suppose `trip` is a `Time` object. To display `Time` values, we've been using `Show()`. Wouldn't it be nice, however, if you could do the following?

```
cout << trip; // make cout recognize Time class?
```

You can do this because << is one of the C++ operators that can be overloaded. In fact, it already is heavily overloaded. In its most basic incarnation, the << operator is one of C and C++'s bit manipulation operators; it shifts bits left in a value (see Appendix E). But the `ostream` class overloads the operator, converting it into an output tool. Recall that `cout` is an `ostream` object and that it is smart enough to recognize all the basic C++ types. That's because the `ostream` class declaration includes an overloaded `operator<<()` definition for each of the basic types. That is, one definition uses an `int` argument, one uses a `double` argument, and so on. So one way to teach `cout` to recognize a `Time` object is to add a new function operator definition to the `ostream` class declaration. But it's a dangerous idea to alter the `iostream` file and mess around with a standard interface. Instead, use the `Time` class declaration to teach the `Time` class how to use `cout`.

### The First Version of Overloading <<

To teach the `Time` class to use `cout`, you can use a friend function. Why? Because a statement like the following uses two objects, with the `ostream` class object (`cout`) first:

```
cout << trip;
```

If you use a `Time` member function to overload <<, the `Time` object would come first, as it did when you overloaded the `*` operator with a member function. That means you would have to use the << operator this way:

```
trip << cout; // if operator<<() were a Time member function
```

This would be confusing. But by using a friend function, you can overload the operator this way:

```
void operator<<(ostream & os, const Time & t)
{
    os << t.hours << " hours, " << t.minutes << " minutes";
}
```

This lets you use

```
cout << trip;
```

to print data in the following format:

```
4 hours, 23 minutes
```

### Friend or No Friend?

The new `Time` class declaration makes the `operator<<()` function a friend function to the `Time` class. But this function, although not inimical to the `ostream` class, is not a friend to that class. The `operator<<()` function takes an `ostream` argument and a `Time` argument, so it might seem that this function has to be a friend to both classes. If you look at the code for the function, however, you'll notice that the function accesses individual members of the `Time` object but only uses the `ostream` object as a whole. Because `operator<<()` accesses private `Time` object members directly, it has to be a friend to the `Time` class. But because it does not directly access private `ostream` object members, the function does not have to be a friend to the `ostream` class. That's nice because it means you don't have to tinker with the `ostream` definition.

Note that the new `operator<<()` definition uses the `ostream` reference `os` as its first argument. Normally, `os` refers to the `cout` object, as it does in the expression `cout << trip`. But you could use the operator with other `ostream` objects, in which case `os` would refer to those objects.

### What? You Don't Know of Any Other `ostream` Objects?

Another `ostream` object is `cerr`, which routes output to the standard error stream, which, by default, is the display. But in Unix, Linux, and the Windows Command Line environment you can redirect the standard error stream to a file. Also recall that Chapter 6, "Branching Statements and Logical Operators," introduces `ofstream` objects, which can be used to send output to a file. Through the magic of inheritance (see Chapter 13, "Class Inheritance"), `ofstream` objects can use `ostream` methods. Thus you can use the `operator<<()` definition to write `Time` data to files as well as to the screen. You just pass a suitably initialized `ofstream` object instead of `cout` as the first argument.

The call `cout << trip` should use the `cout` object itself, not a copy, so the function passes the object as a reference instead of by value. Thus, the expression `cout << trip` causes `os` to be an alias for `cout`, and the expression `cerr << trip` causes `os` to be an alias for `cerr`. The `Time` object can be passed by value or by reference because either form makes the object values available to the function. Again, passing by reference uses less memory and time than passing by value.

### The Second Version of Overloading `<<`

The implementation just presented has a problem. Statements such as this work fine:

```
cout << trip;
```

But the implementation doesn't allow you to combine the redefined `<<` operator with the ones `cout` normally uses:

```
cout << "Trip time: " << trip << " (Tuesday)\n"; // can't do
```

To understand why this doesn't work and what must be done to make it work, you first need to know a bit more about how `cout` operates. Consider the following statements:

```
int x = 5;
int y = 8;
cout << x << y;
```

C++ reads the output statement from left to right, meaning it is equivalent to the following:

```
(cout << x) << y;
```

The `<<` operator, as defined in `ostream`, takes an `ostream` object to its left. Clearly, the expression `cout << x` satisfies that requirement because `cout` is an `ostream` object. But the output statement also requires that the whole expression `(cout << x)` be a type `ostream` object because that expression is to the left of `<< y`. Therefore, the `ostream` class implements the `operator<<()` function so that it returns a reference to an `ostream` object. In particular, it returns a reference to the invoking object—`cout`, in this case. Thus, the expression `(cout << x)` is itself the `ostream` object `cout`, and it can be used to the left of the `<<` operator.

You can take the same approach with the friend function. You just revise the `operator<<()` function so that it returns a reference to an `ostream` object:

```
ostream & operator<<(ostream & os, const Time & t)
{
    os << t.hours << " hours, " << t.minutes << " minutes";
    return os;
}
```

Note that the return type is `ostream &`. Recall that this means that the function returns a reference to an `ostream` object. Because a program passes an object reference to the function to begin with, the net effect is that the function's return value is just the object passed to it. That is, the statement

```
cout << trip;
```

becomes the following function call:

```
operator<<(cout, trip);
```

And that call returns the `cout` object. So now the following statement does work:

```
cout << "Trip time: " << trip << " (Tuesday)\n"; // can do
```

Let's break this into separate steps to see how it works. First, the following invokes the particular `ostream` definition of `<<` that displays a string and returns the `cout` object:

```
cout << "Trip time: "
```

So the expression `cout << "Trip time: "` displays the string and then is replaced by its return value, `cout`. This reduces the original statement to the following one:

```
cout << trip << " (Tuesday)\n";
```

Next, the program uses the `Time` declaration of `<<` to display the trip values and to return the `cout` object again. This reduces the statement to the following:

```
cout << " (Tuesday)\n";
```

The program now finishes up by using the `ostream` definition of `<<` for strings to display the final string.

As a point of interest, this version of `operator<<()` also can be used for file output:

```
#include <fstream>
...
ofstream fout;
fout.open("savetime.txt");
Time trip(12, 40);
fout << trip;
```

The last statement becomes this:

```
operator<<(fout, trip);
```

And as Chapter 8 points out, the properties of class inheritance allow an `ostream` reference to refer to `ostream` objects and to `ofstream` objects.

### Tip

In general, to overload the `<<` operator to display an object of class `c_name`, you use a friend function with a definition in this form:

```
ostream & operator<<(ostream & os, const c_name & obj)
{
    os << ... ; // display object contents
    return os;
}
```

Listing 11.10 shows the class definition as modified to include the two friend functions `operator*()` and `operator<<()`. It implements the first of these as an inline function because the code is so short. (When the definition is also the prototype, as in this case, you use the `friend` prefix.)

### Caution

You use the `friend` keyword only in the prototype found in the class declaration. You don't use it in the function definition unless the definition is also the prototype.

#### Listing 11.10 `mytime3.h`

---

```
// mytime3.h -- Time class with friends
#ifdef MYTIME3_H_
#define MYTIME3_H_
#include <iostream>

class Time
{
```

```

private:
    int hours;
    int minutes;
public:
    Time();
    Time(int h, int m = 0);
    void AddMin(int m);
    void AddHr(int h);
    void Reset(int h = 0, int m = 0);
    Time operator+(const Time & t) const;
    Time operator-(const Time & t) const;
    Time operator*(double n) const;
    friend Time operator*(double m, const Time & t)
        { return t * m; } // inline definition
    friend std::ostream & operator<<(std::ostream & os, const Time & t);
};

#endif

```

---

Listing 11.11 shows the revised set of definitions. Note again that the methods use the `Time::` qualifier, whereas the friend function does not. Also note that because `mytime3.h` includes `iostream` and provides the using declaration `std::ostream`, including `mytime3.h` in `mytime3.cpp` provides support for using `ostream` in the implementation file.

#### Listing 11.11 `mytime3.cpp`

---

```

// mytime3.cpp -- implementing Time methods
#include "mytime3.h"

Time::Time()
{
    hours = minutes = 0;
}

Time::Time(int h, int m )
{
    hours = h;
    minutes = m;
}

void Time::AddMin(int m)
{
    minutes += m;
    hours += minutes / 60;
    minutes %= 60;
}

```



```
void Time::AddHr(int h)
{
    hours += h;
}

void Time::Reset(int h, int m)
{
    hours = h;
    minutes = m;
}

Time Time::operator+(const Time & t) const
{
    Time sum;
    sum.minutes = minutes + t.minutes;
    sum.hours = hours + t.hours + sum.minutes / 60;
    sum.minutes %= 60;
    return sum;
}

Time Time::operator-(const Time & t) const
{
    Time diff;
    int tot1, tot2;
    tot1 = t.minutes + 60 * t.hours;
    tot2 = minutes + 60 * hours;
    diff.minutes = (tot2 - tot1) % 60;
    diff.hours = (tot2 - tot1) / 60;
    return diff;
}

Time Time::operator*(double mult) const
{
    Time result;
    long totalminutes = hours * mult * 60 + minutes * mult;
    result.hours = totalminutes / 60;
    result.minutes = totalminutes % 60;
    return result;
}

std::ostream & operator<<(std::ostream & os, const Time & t)
{
    os << t.hours << " hours, " << t.minutes << " minutes";
    return os;
}
```

---

Listing 11.12 shows a sample program. Technically, `usetime3.cpp` doesn't have to include `iostream` because `mytime3.h` already includes that file. However, as a user of the `Time` class, you don't necessarily know which files are included in the class code, so you would take the responsibility of declaring those header files that you know your part of the code needs.

#### Listing 11.12 `usetime3.cpp`

---

```
//usetime3.cpp -- using the fourth draft of the Time class
// compile usetime3.cpp and mytime3.cpp together
#include <iostream>
#include "mytime3.h"

int main()
{
    using std::cout;
    using std::endl;
    Time aida(3, 35);
    Time tosca(2, 48);
    Time temp;

    cout << "Aida and Tosca:\n";
    cout << aida<<" "; cout << tosca << endl;
    temp = aida + tosca; // operator+()
    cout << "Aida + Tosca: " << temp << endl;
    temp = aida * 1.17; // member operator*()
    cout << "Aida * 1.17: " << temp << endl;
    cout << "10.0 * Tosca: " << 10.0 * tosca << endl;

    return 0;
}
```

---

Here is the output of the program in Listings 11.10, 11.11, and 11.12:

```
Aida and Tosca:
3 hours, 35 minutes; 2 hours, 48 minutes
Aida + Tosca: 6 hours, 23 minutes
Aida * 1.17: 4 hours, 11 minutes
10.0 * Tosca: 28 hours, 0 minutes
```

## Overloaded Operators: Member Versus Nonmember Functions

For many operators, you have a choice between using member functions or nonmember functions to implement operator overloading. Typically, the nonmember version is a friend

function so that it can directly access the private data for a class. For example, consider the addition operator for the `Time` class. It has this prototype in the `Time` class declaration:

```
Time operator+(const Time & t) const; // member version
```

Instead, the class could use the following prototype:

```
// nonmember version
friend Time operator+(const Time & t1, const Time & t2);
```

The addition operator requires two operands. For the member function version, one is passed implicitly via the `this` pointer and the second is passed explicitly as a function argument. For the friend version, both are passed as arguments.

### Note

A nonmember version of an overloaded operator function requires as many formal parameters as the operator has operands. A member version of the same operator requires one fewer parameter because one operand is passed implicitly as the invoking object.

Either of these two prototypes matches the expression `T2 + T3`, where `T2` and `T3` are type `Time` objects. That is, the compiler can convert the statement

```
T1 = T2 + T3;
```

to either of the following:

```
T1 = T2.operator+(T3); // member function
T1 = operator+(T2, T3); // nonmember function
```

Keep in mind that you must choose one or the other form when defining a given operator, but not both. Because both forms match the same expression, defining both forms is an ambiguity error, leading to a compilation error.

Which form, then, is it best to use? For some operators, as mentioned earlier, the member function is the only valid choice. Otherwise, it often doesn't make much difference. Sometimes, depending on the class design, the nonmember version may have an advantage, particularly if you have defined type conversions for the class. The section "Conversions and Friends," near the end of this chapter, discusses this situation further.

## More Overloading: A Vector Class

Let's look at another class design that uses operator overloading and friends—a class representing vectors. This class also illustrates further aspects of class design, such as incorporating two different ways of describing the same thing into an object. Even if you don't care for vectors, you can use many of the new techniques shown here in other contexts. A *vector*, as the term is used in engineering and physics, is a quantity that has both a magnitude (size) and a direction. For example, if you push something, the effect depends on how hard you push (the magnitude) and in what direction you push. A push in one direction can save a tottering vase, whereas a push in another direction can hasten its rush to doom. To fully describe the motion of your car, you should give both the speed (the

magnitude) and the direction; arguing with the highway patrol that you were driving under the speed limit carries little weight if you were traveling in the wrong direction. (Immunologists and computer scientists may use the term *vector* differently; ignore them, at least until Chapter 16, “The `string` Class and the Standard Template Library,” which looks at a computer science version, the `vector` template class.) The following sidebar tells you more about vectors, but understanding them completely isn’t necessary for following the C++ aspects of the examples.

## Vectors

Say you’re a worker bee and have discovered a marvelous nectar cache. You rush back to the hive and announce that you’ve found nectar 120 yards away. “Not enough information,” buzz the other bees. “You have to tell us the direction, too!” You answer, “It’s 30 degrees north of the sun direction.” Knowing both the distance (magnitude) and the direction, the other bees rush to the sweet site. Bees know vectors.

Many quantities involve both a magnitude and a direction. The effect of a push, for example, depends on both its strength and direction. Moving an object on a computer screen involves a distance and a direction. You can describe such things by using vectors. For example, you can describe moving (displacing) an object onscreen with a vector, which you can visualize as an arrow drawn from the starting position to the final position. The length of the vector is its magnitude, and that describes how far the point has been displaced. The orientation of the arrow describes the direction (see Figure 11.1). A vector representing such a change in position is called a *displacement vector*.

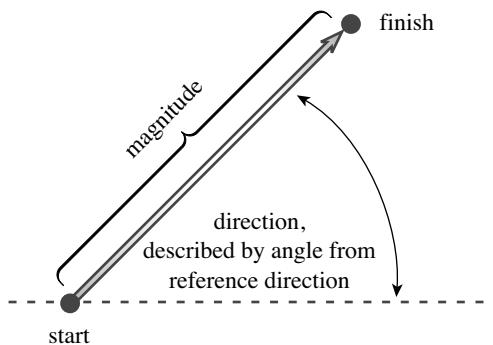

Figure 11.1 Describing a displacement with a vector.

Now say you’re Lhanappa, the great mammoth hunter. Scouts report a mammoth herd 14.1 kilometers to the northwest. But because of a southeast wind, you don’t want to approach from the southeast. So you go 10 kilometers west and then 10 kilometers north, approaching the herd from the south. You know these two displacement vectors bring you to the same location as the single 14.1-kilometer vector pointing northwest. Lhanappa, the great mammoth hunter, also knows how to add vectors.

Adding two vectors has a simple geometric interpretation. First, draw one vector. Then draw the second vector, starting from the arrow end of the first vector. Finally, draw a vector from the starting point of the first vector to the endpoint of the second vector. This third vector represents the sum of the first two (see Figure 11.2). Note that the length of the sum can be less than the sum of the individual lengths.

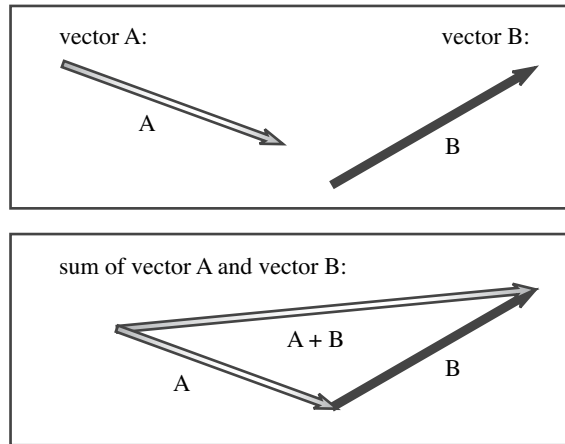

Figure 11.2 Adding two vectors.

Vectors are a natural choice for operator overloading. First, you can't represent a vector with a single number, so it makes sense to create a class to represent vectors. Second, vectors have analogs to ordinary arithmetic operations such as addition and subtraction. This parallel suggests overloading the corresponding operators so you can use them with vectors.

To keep things simple, in this section we'll implement a two-dimensional vector, such as a screen displacement, instead of a three-dimensional vector, such as might represent movement of a helicopter or a gymnast. You need just two numbers to describe a two-dimensional vector, but you have a choice of what set of two numbers:

- You can describe a vector by its magnitude (length) and direction (an angle).
- You can represent a vector by its  $x$  and  $y$  components.

The components are a horizontal vector (the  $x$  component) and a vertical vector (the  $y$  component), which add up to the final vector. For example, you can describe a motion as moving a point 30 units to the right and 40 units up (see Figure 11.3). That motion puts the point at the same spot as moving 50 units at an angle of  $53.1^\circ$  from the horizontal. Therefore, a vector with a magnitude of 50 and an angle of  $53.1^\circ$  is equivalent to a vector having a horizontal component of 30 and a vertical component of 40. What counts with displacement vectors is where you start and where you end up, not the exact

route taken to get there. This choice of representation is basically the same thing covered with the Chapter 7 program that converts between rectangular and polar coordinates.

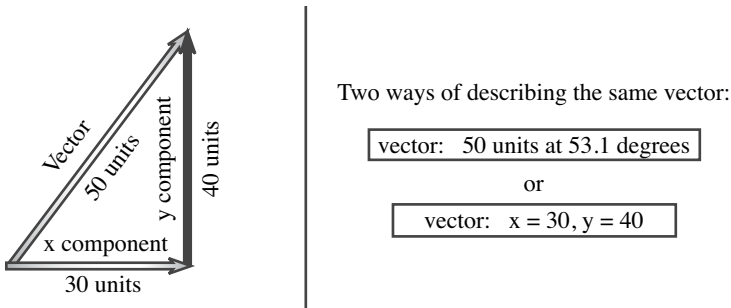

Figure 11.3 The x and y components of a vector.

Sometimes one form is more convenient, sometimes the other, so you'll incorporate both representations into the class description. (See the sidebar "Multiple Representations and Classes," later in this chapter.) Also you'll design the class so that if you alter one representation of a vector, the object automatically updates the other representation. The ability to build such intelligence into an object is another C++ class virtue. Listing 11.13 presents a class declaration. To refresh your memory about namespaces, the listing places the class declaration inside the `VECTOR` namespace. Also the program uses `enum` to create a couple constants (`RECT` and `POL`) for identifying the two representations. (We covered that technique in Chapter 10, so we may as well use it!)

#### Listing 11.13 `vect.h`

---

```
// vect.h -- Vector class with <<, mode state
#ifndef VECTOR_H_
#define VECTOR_H_
#include <iostream>
namespace VECTOR
{
    class Vector
    {
    public:
        enum Mode {RECT, POL};
        // RECT for rectangular, POL for Polar modes
    private:
        double x;           // horizontal value
        double y;           // vertical value
        double mag;         // length of vector
        double ang;         // direction of vector in degrees
        Mode mode;          // RECT or POL
    };
};
```

```

// private methods for setting values
    void set_mag();
    void set_ang();
    void set_x();
    void set_y();
public:
    Vector();
    Vector(double n1, double n2, Mode form = RECT);
    void reset(double n1, double n2, Mode form = RECT);
    ~Vector();
    double xval() const {return x;} // report x value
    double yval() const {return y;} // report y value
    double magval() const {return mag;} // report magnitude
    double angval() const {return ang;} // report angle
    void polar_mode(); // set mode to POL
    void rect_mode(); // set mode to RECT
// operator overloading
    Vector operator+(const Vector & b) const;
    Vector operator-(const Vector & b) const;
    Vector operator-() const;
    Vector operator*(double n) const;
// friends
    friend Vector operator*(double n, const Vector & a);
    friend std::ostream &
        operator<<(std::ostream & os, const Vector & v);
};

} // end namespace VECTOR
#endif

```

Notice that the four functions in Listing 11.13 that report component values are defined in the class declaration. This automatically makes them inline functions. The fact that these functions are so short makes them excellent candidates for inlining. None of them should alter object data, so they are declared using the `const` modifier. As you may recall from Chapter 10, this is the syntax for declaring a function that doesn't modify the object it implicitly accesses.

Listing 11.14 shows all the methods and friend functions declared in Listing 11.13. The listing uses the open nature of namespaces to add the method definitions to the `VECTOR` namespace. Note how the constructor functions and the `reset()` function each set both the rectangular and the polar representations of the vector. Thus, either set of values is available immediately without further calculation, should you need them. Also as mentioned in Chapter 4, "Compound Types," and Chapter 7, C++'s built-in math functions use angles in radians, so the functions build conversion to and from degrees into the methods. The `Vector` class implementation hides such things as converting from polar coordinates to rectangular coordinates or converting radians to degrees from the user.

All the user needs to know is that the class uses angles in degrees and that it makes a vector available in two equivalent representations.

**Listing 11.14 vect.cpp**

---

```
// vect.cpp -- methods for the Vector class
#include <cmath>
#include "vect.h" // includes <iostream>
using std::sqrt;
using std::sin;
using std::cos;
using std::atan;
using std::atan2;
using std::cout;

namespace VECTOR
{
    // compute degrees in one radian
    const double Rad_to_deg = 45.0 / atan(1.0);
    // should be about 57.2957795130823

    // private methods
    // calculates magnitude from x and y
    void Vector::set_mag()
    {
        mag = sqrt(x * x + y * y);
    }

    void Vector::set_ang()
    {
        if (x == 0.0 && y == 0.0)
            ang = 0.0;
        else
            ang = atan2(y, x);
    }

    // set x from polar coordinate
    void Vector::set_x()
    {
        x = mag * cos(ang);
    }

    // set y from polar coordinate
    void Vector::set_y()
    {
        y = mag * sin(ang);
    }
}
```



```

// public methods
Vector::Vector()           // default constructor
{
    x = y = mag = ang = 0.0;
    mode = RECT;
}

// construct vector from rectangular coordinates if form is r
// (the default) or else from polar coordinates if form is p
Vector::Vector(double n1, double n2, Mode form)
{
    mode = form;
    if (form == RECT)
    {
        x = n1;
        y = n2;
        set_mag();
        set_ang();
    }
    else if (form == POL)
    {
        mag = n1;
        ang = n2 / Rad_to_deg;
        set_x();
        set_y();
    }
    else
    {
        cout << "Incorrect 3rd argument to Vector() -- ";
        cout << "vector set to 0\n";
        x = y = mag = ang = 0.0;
        mode = RECT;
    }
}

// reset vector from rectangular coordinates if form is
// RECT (the default) or else from polar coordinates if
// form is POL
void Vector::reset(double n1, double n2, Mode form)
{
    mode = form;
    if (form == RECT)
    {
        x = n1;
        y = n2;
        set_mag();
    }
}

```

```
        set_ang();
    }
    else if (form == POL)
    {
        mag = n1;
        ang = n2 / Rad_to_deg;
        set_x();
        set_y();
    }
    else
    {
        cout << "Incorrect 3rd argument to Vector() -- ";
        cout << "vector set to 0\n";
        x = y = mag = ang = 0.0;
        mode = RECT;
    }
}

Vector::~Vector()    // destructor
{
}

void Vector::polar_mode()    // set to polar mode
{
    mode = POL;
}

void Vector::rect_mode()    // set to rectangular mode
{
    mode = RECT;
}

// operator overloading
// add two Vectors
Vector Vector::operator+(const Vector & b) const
{
    return Vector(x + b.x, y + b.y);
}

// subtract Vector b from a
Vector Vector::operator-(const Vector & b) const
{
    return Vector(x - b.x, y - b.y);
}

// reverse sign of Vector
```

```

Vector Vector::operator-() const
{
    return Vector(-x, -y);
}

// multiply vector by n
Vector Vector::operator*(double n) const
{
    return Vector(n * x, n * y);
}

// friend methods
// multiply n by Vector a
Vector operator*(double n, const Vector & a)
{
    return a * n;
}

// display rectangular coordinates if mode is RECT,
// else display polar coordinates if mode is POL
std::ostream & operator<<(std::ostream & os, const Vector & v)
{
    if (v.mode == Vector::RECT)
        os << "(x,y) = (" << v.x << ", " << v.y << ")";
    else if (v.mode == Vector::POL)
    {
        os << "(m,a) = (" << v.mag << ", "
            << v.ang * Rad_to_deg << ")";
    }
    else
        os << "Vector object mode is invalid";
    return os;
}

} // end namespace VECTOR

```

---

You could design the class differently. For example, the object could store the rectangular coordinates and not the polar coordinates. In that case, the computation of polar coordinates could be moved to the `magval()` and `angval()` methods. For applications in which conversions are seldom used, this could be a more efficient design. Also the `reset()` method isn't really needed. Suppose `shove` is a `Vector` object and that you have the following code:

```
shove.reset(100,300);
```

You can get the same result by using a constructor instead:

```
shove = Vector(100,300);    // create and assign a temporary object
```

However, the `set()` method alters the contents of `shove` directly, whereas using the constructor adds the extra steps of creating a temporary object and assigning it to `shove`.

These design decisions follow the OOP tradition of having the class interface concentrate on the essentials (the abstract model) while hiding the details. Thus, when you use the `Vector` class, you can think about a vector's general features, such as that they can represent displacements and that you can add two vectors. Whether you express a vector in component notation or in magnitude, direction notation becomes secondary because you can set a vector's values and display them in whichever format is most convenient at the time.

We'll look at some of the features the `Vector` class in more detail next.

## Using a State Member

The `Vector` class stores both the rectangular coordinates and the polar coordinates for a vector. It uses a member called `mode` to control which form the constructor, the `reset()` method, and the overloaded `operator<<()` function use, with the enumerations `RECT` representing the rectangular mode (the default) and `POL` the polar mode. Such a member is termed a *state member* because it describes the state an object is in. To see what this means, look at the code for the constructor:

```
Vector::Vector(double n1, double n2, Mode form)
{
    mode = form;
    if (form == RECT)
    {
        x = n1;
        y = n2;
        set_mag();
        set_ang();
    }
    else if (form == POL)
    {
        mag = n1;
        ang = n2 / Rad_to_deg;
        set_x();
        set_y();
    }
    else
    {
        cout << "Incorrect 3rd argument to Vector() -- ";
        cout << "vector set to 0\n";
    }
}
```

```

        x = y = mag = ang = 0.0;
        mode = RECT;
    }
}

```

If the third argument is `RECT` or if it is omitted (in which case the prototype assigns a default value of `RECT`), the inputs are interpreted as rectangular coordinates, whereas a value of `POL` causes them to be interpreted as polar coordinates:

```

Vector folly(3.0, 4.0);           // set x = 3, y = 4
Vector foolery(20.0, 30.0, VECTOR::Vector::POL); // set mag = 20, ang = 30

```

The identifier `POL` has class scope, so class definitions can just use the unqualified name. But the fully qualified name is `VECTOR::Vector::POL` because `POL` is defined in the `Vector` class, and `Vector` is defined in the `VECTOR` namespace. Note that the constructor uses the private methods `set_mag()` and `set_ang()` to set the magnitude and angle values if you provide `x` and `y` values, and it uses the private `set_x()` and `set_y()` methods to set `x` and `y` values if you provide magnitude and angle values. Also note that the constructor delivers a warning message and sets the state to `RECT` if something other than `RECT` or `POL` is specified.

Now it may seem rather difficult to sneak something other than `RECT` or `POL` to the constructor because the third argument is type `VECTOR::Vector::Mode`. A call such as the following won't compile because an integer like `2` can't implicitly be converted to an enum type:

```

Vector rector(20.0, 30.0, 2); // type mismatch - 2 not an enum type

```

Still, the resourceful and curious user could try something like the following to see what happens:

```

Vector rector(20.0, 30.0, VECTOR::Vector::Mode(2)); // type cast

```

In this case, he gets admonished.

Next, the `operator<<()` function uses the mode to determine how values are displayed:

```

// display rectangular coordinates if mode is RECT,
// else display polar coordinates if mode is POL
std::ostream & operator<<(std::ostream & os, const Vector & v)
{
    if (v.mode == Vector::RECT)
        os << "(x,y) = (" << v.x << ", " << v.y << ")";
    else if (v.mode == Vector::POL)
    {
        os << "(m,a) = (" << v.mag << ", "
            << v.ang * Rad_to_deg << ")";
    }
    else
        os << "Vector object mode is invalid";
    return os;
}

```

Because `operator<<()` is a friend function and not part of the class scope, it has to use `Vector::RECT` instead of just `RECT`. But it is in the `VECTOR` namespace, so it doesn't need to use the fully qualified name of `VECTOR::Vector::RECT`.

The various methods that can set the mode are careful to accept only `RECT` and `POL` as valid values, so the final `else` in this function should never be reached. Still, it's often a good idea to check; such a check can help catch an otherwise obscure programming error.

## Multiple Representations and Classes

Quantities that have different, but equivalent, representations are common. For example, you can measure gasoline consumption in miles per gallon, as done in the United States, or in liters per 100 kilometers, as done in Europe. You can represent a number in string form or numeric form, and you can represent intelligence as an IQ or in kiloturkeys. Classes lend themselves nicely to encompassing different aspects and representations of an entity in a single object. First, you can store multiple representations in one object. Second, you can write the class functions so that assigning values for one representation automatically assigns values for the other representation(s). For example, the `set_by_polar()` method for the `Vector` class sets the `mag` and `ang` members to the function arguments, but it also sets the `x` and `y` members. Or you can store a single representation and use methods to make other representations available. By handling conversions internally, a class can help you think of a quantity in terms of its essential nature rather than in terms of its representation.

## Overloading Arithmetic Operators for the Vector Class

Adding two vectors is very simple when you use `x,y` coordinates. You just add the two `x` components to get the `x` component of the answer and add the two `y` components to get the `y` component of the answer. From this description, you might be tempted to use this code:

```
Vector Vector::operator+(const Vector & b) const
{
    Vector sum;
    sum.x = x + b.x;
    sum.y = y + b.y;
    return sum;           // incomplete version
}
```

And this would be fine if the object stored only the `x` and `y` components. Unfortunately, this version of the code fails to set the polar values. You could fix this problem by adding more code:

```
Vector Vector::operator+(const Vector & b) const
{
    Vector sum;
    sum.x = x + b.x;
    sum.y = y + b.y;
    sum.set_ang(sum.x, sum.y);
}
```

```

    sum.set_mag(sum.x, sum.y);
    return sum;          // version duplicates needlessly
}

```

But it is much simpler and more reliable to let a constructor do the work:

```

Vector Vector::operator+(const Vector & b) const
{
    return Vector(x + b.x, y + b.y);    // return the constructed Vector
}

```

Here, the code hands the `Vector` constructor the two new values for the `x` and `y` components. The constructor then creates a nameless new object, using these values, and the function returns a copy of that object. This way, you guarantee that the new `Vector` object is created according to the standard rules you lay down in the constructor.

### Tip

If a method needs to compute a new class object, you should see if you can use a class constructor to do the work. Not only does that save you trouble, it ensures that the new object is constructed in the proper fashion.

## Multiplication

In visual terms, multiplying a vector by a number makes the vector longer or shorter by that factor. So multiplying a vector by 3 produces a vector with three times the length, but still pointed in the same direction. It's easy to translate that image into how the `Vector` class represents a vector. In polar terms, you multiply the magnitude and leave the angle alone. In rectangular terms, you multiply a vector by a number by multiplying its `x` and `y` components separately by the number. That is, if a vector has components of 5 and 12, multiplying by 3 makes the components 15 and 36. And that is what the overloaded multiplication operator does:

```

Vector Vector::operator*(double n) const
{
    return Vector(n * x, n * y);
}

```

As with overloaded addition, the code lets a constructor create the correct `Vector` object from the new `x` and `y` components. This handles multiplying a `Vector` value by a `double` value. Just as in the `Time` example, you can use an inline friend function to handle double times `Vector`:

```

Vector operator*(double n, const Vector & a) // friend function
{
    return a * n;    // convert double times Vector to Vector times double
}

```

### More Refinement: Overloading an Overloaded Operator

In ordinary C++, the `-` operator already has two meanings. First, when used with two operands, it's the subtraction operator. The subtraction operator is termed a *binary operator* because it has exactly two operands. Second, when used with one operand, as in `-x`, it's a minus sign operator. This form is termed a *unary operator*, meaning it has exactly one operand. Both operations—subtraction and sign reversal—make sense for vectors, too, so the `Vector` class has both.

To subtract `Vector B` from `Vector A`, you simply subtract components, so the definition for overloading subtraction is quite similar to the one for addition:

```
Vector operator-(const Vector & b) const;           // prototype
Vector Vector::operator-(const Vector & b) const   // definition
{
    return Vector(x - b.x, y - b.y); // return the constructed Vector
}
```

Here, it's important to get the correct order. Consider the following statement:

```
diff = v1 - v2;
```

It's converted to a member function call:

```
diff = v1.operator-(v2);
```

This means the vector that is passed as the explicit argument is subtracted from the implicit vector argument, so you should use `x - b.x` and not `b.x - x`.

Next, consider the unary minus operator, which takes just one operand. Applying this operator to a regular number, as in `-x`, changes the sign of the value. Thus, applying this operator to a vector reverses the sign of each component. More precisely, the function should return a new vector that is the reverse of the original. (In polar terms, negation leaves the magnitude unchanged but reverses the direction. Many politicians with little or no mathematical training nonetheless have an intuitive mastery of this operation.) Here are the prototype and definition for overloading negation:

```
Vector operator-() const;
Vector Vector::operator-() const
{
    return Vector (-x, -y);
}
```

Note that now there are two separate definitions for `operator-()`. That's fine because the two definitions have different signatures. You can define both binary and unary versions of the `-` operator because C++ provides both binary and unary versions of that operator to begin with. An operator that has only a binary form, such as division (`/`), can only be overloaded as a binary operator.



**Note**

Because operator overloading is implemented with functions, you can overload the same operator many times, as long as each operator function has a distinct signature and as long as each operator function has the same number of operands as the corresponding built-in C++ operator.

**An Implementation Comment**

The implementation described in the preceding sections stores both rectangular and polar coordinates for a vector in the `vector` object. However, the public interface doesn't depend on this fact. All the interface calls for is that both representations can be displayed and that individual values can be returned. The internal implementation could be quite different. As mentioned earlier, the object could store just the *x* and *y* components. Then, say, the `magval()` method, which returns the value of the magnitude of the vector, could calculate the magnitude from the *x* and *y* values instead of just looking up the value as stored in the object. Such an approach changes the implementation but leaves the user interface unchanged. This separation of interface from implementation is one of the goals of OOP. It lets you fine-tune an implementation without changing the code in programs that use the class.

Both of these implementations have advantages and disadvantages. Storing the data means that the object occupies more memory and that code has to be careful to update both rectangular and polar representations each time a `vector` object is changed. But data look-up is faster. If an application often needs to access both representations of a vector, the implementation used in this example would be preferable; if polar data were needed only infrequently, the other implementation would be better. You could choose to use one implementation in one program and the second implementation in another, yet retain the same user interface for both.

**Taking the `vector` Class on a Random Walk**

Listing 11.15 provides a short program that uses the revised `vector` class. It simulates the famous Drunkard's Walk problem. Actually, now that drunks are recognized as people with a serious health problem rather than as a source of amusement, it's usually called the Random Walk problem. The idea is that you place someone at a lamppost. The person begins walking, but the direction of each step varies randomly from the direction of the preceding step. One way of phrasing the problem is this: How many steps does it take the random walker to travel, say, 50 feet away from the post? In terms of vectors, this amounts to adding a bunch of randomly oriented vectors until the sum exceeds 50 feet.

Listing 11.15 lets you select the target distance to be traveled and the length of the wanderer's step. It maintains a running total that represents the position after each step (represented as a vector) and reports the number of steps needed to reach the target distance, along with the walker's location (in both formats). As you'll see, the walker's progress is quite inefficient. A journey of 1,000 steps, each 2 feet long, may carry the walker only 50 feet from the starting point. The program divides the net distance traveled (50 feet, in this case) by the number of steps to provide a measure of the walker's

inefficiency. All the random direction changes make this average much smaller than the length of a single step. To select directions randomly, the program uses the standard library functions `rand()`, `srand()`, and `time()`, described in the following “Program Notes” section. Be sure to compile Listing 11.14 along with Listing 11.15.

#### Listing 11.15 `randwalk.cpp`

---

```
// randwalk.cpp -- using the Vector class
// compile with the vect.cpp file
#include <iostream>
#include <cstdlib>      // rand(), srand() prototypes
#include <ctime>        // time() prototype
#include "vect.h"
int main()
{
    using namespace std;
    using VECTOR::Vector;
    srand(time(0));    // seed random-number generator
    double direction;
    Vector step;
    Vector result(0.0, 0.0);
    unsigned long steps = 0;
    double target;
    double dstep;
    cout << "Enter target distance (q to quit): ";
    while (cin >> target)
    {
        cout << "Enter step length: ";
        if (!(cin >> dstep))
            break;

        while (result.magval() < target)
        {
            direction = rand() % 360;
            step.reset(dstep, direction, VECTOR::POL);
            result = result + step;
            steps++;
        }
        cout << "After " << steps << " steps, the subject "
             << "has the following location:\n";
        cout << result << endl;
        result.polar_mode();
        cout << " or\n" << result << endl;
        cout << "Average outward distance per step = "
             << result.magval()/steps << endl;
        steps = 0;
        result.reset(0.0, 0.0);
    }
}
```

```

        cout << "Enter target distance (q to quit): ";
    }
    cout << "Bye!\n";
    cin.clear();
    while (cin.get() != '\n')
        continue;
    return 0;
}

```

---

Because the program has a `using` declaration bringing `Vector` into scope, the program can use `Vector::POL` instead of `VECTOR::Vector::POL`.

Here is a sample run of the program in Listings 11.13, 11.14, and 11.15:

```

Enter target distance (q to quit): 50
Enter step length: 2
After 253 steps, the subject has the following location:
(x,y) = (46.1512, 20.4902)
or
(m,a) = (50.495, 23.9402)
Average outward distance per step = 0.199587
Enter target distance (q to quit): 50
Enter step length: 2
After 951 steps, the subject has the following location:
(x,y) = (-21.9577, 45.3019)
or
(m,a) = (50.3429, 115.8593)
Average outward distance per step = 0.0529362
Enter target distance (q to quit): 50
Enter step length: 1
After 1716 steps, the subject has the following location:
(x,y) = (40.0164, 31.1244)
or
(m,a) = (50.6956, 37.8755)
Average outward distance per step = 0.0295429
Enter target distance (q to quit): q
Bye!

```

The random nature of the process produces considerable variation from trial to trial, even if the initial conditions are the same. On average, however, halving the step size quadruples the number of steps needed to cover a given distance. Probability theory suggests that, on average, the number of steps ( $N$ ) of length  $s$  needed to reach a net distance of  $D$  is given by the following equation:

$$N = (D/s)^2$$

This is just an average, but there will be considerable variations from trial to trial. For example, 1,000 trials of attempting to travel 50 feet in 2-foot steps yielded an average of 636 steps (close to the theoretical value of 625) to travel that far, but the range was from

91 to 3,951. Similarly, 1,000 trials of traveling 50 feet in 1-foot steps averaged 2,557 steps (close to the theoretical value of 2,500), with a range of 345 to 10,882. So if you find yourself walking randomly, be confident and take long steps. You still won't have any control over the direction you wind up going, but at least you'll get farther.

### Program Notes

First, let's note how painless it was to use the `VECTOR` namespace in Listing 11.15. The following `using` declaration places the name of the `vector` class in scope:

```
using VECTOR::Vector;
```

Because all the `vector` class methods have class scope, importing the class name also makes the `vector` methods available, without the need for any further `using` declarations.

Next, let's talk about random numbers. The standard ANSI C library, which also comes with C++, includes a `rand()` function that returns a random integer in the range from 0 to some implementation-dependent value. The random walk program uses the modulus operator to get an angle value in the range 0 to 359. The `rand()` function works by applying an algorithm to an initial seed value to get a random value. That value is used as the seed for the next function call, and so on. The numbers are really *pseudorandom* because 10 consecutive calls normally produce the same set of 10 random numbers. (The exact values depend on the implementation.) However, the `srand()` function lets you override the default seed value and initiate a different sequence of random numbers. This program uses the return value of `time(0)` to set the seed. The `time(0)` function returns the current calendar time, often implemented as the number of seconds since some specific date. (More generally, `time()` takes the address of a type `time_t` variable and puts the time into that variable and also returns it. Using 0 for the address argument obviates the need for an otherwise unneeded `time_t` variable.) Thus, the following statement sets a different seed each time you run the program, making the random output appear even more random:

```
srand(time(0));
```

The `cstdlib` header file (formerly `stdlib.h`) contains the prototypes for `srand()` and `rand()`, whereas `ctime` (formerly `time.h`) contains the `time()` prototype. (C++11 provides more extensive random number support with functions supported by the `random` header file.)

The program uses the `result` vector to keep track of the walker's progress. On each cycle of the inner loop, the program sets the `step` vector to a new direction and adds it to the current `result` vector. When the magnitude of `result` exceeds the target distance, the loop terminates.

By setting the vector mode, the program displays the final position in rectangular terms and in polar terms.

Incidentally, the following statement has the effect of placing `result` in the `RECT` mode, regardless of the initial modes of `result` and `step`:

```
result = result + step;
```

Here's why. First, the addition operator function creates and returns a new vector that holds the sum of the two arguments. The function creates that vector by using the default constructor, which creates vectors in the `RECT` mode. Thus, the vector being assigned to `result` is in the `RECT` mode. By default, assignment assigns each member variable individually, so `RECT` is assigned to `result.mode`. If you would prefer some other behavior, such as `result` retaining its original mode, you can override default assignment by defining an assignment operator for the class. Chapter 12 shows examples of this.

By the way, it's a simple matter to save successive positions in a file. First, you include `<fstream>`, declare an `ofstream` object, and associate the object with a file:

```
#include <fstream>
...
ofstream fout;
fout.open("thewalk.txt");
```

Then, in the loop that calculates the result, you insert something like this:

```
fout << result << endl;
```

This invokes the friend function call `operator<<(fout, result)`, causing the `os` reference parameter to refer to `fout`, thus sending output to the file. You could also use `fout` to write other information to the file, such as the summary information currently displayed by `cout`.

## Automatic Conversions and Type Casts for Classes

The next topic on the class menu is type conversion. We'll look into how C++ handles conversions to and from user-defined types. To set the stage, let's first review how C++ handles conversions for its built-in types. When you make a statement that assigns a value of one standard type to a variable of another standard type, C++ automatically converts the value to the same type as the receiving variable, provided that the two types are compatible. For example, the following statements all generate numeric type conversions:

```
long count = 8;      // int value 8 converted to type long
double time = 11;   // int value 11 converted to type double
int side = 3.33;    // double value 3.33 converted to type int 3
```

These assignments work because C++ recognizes that the diverse numeric types all represent the same basic thing—a number—and because C++ incorporates built-in rules for making the conversions. Recall from Chapter 3, “Dealing with Data,” however, that you can lose some precision in these conversions. For example, assigning 3.33 to the `int` variable `side` results in `side` getting the value 3, losing the 0.33 part.

The C++ language does not automatically convert types that are not compatible. For example, the following statement fails because the left side is a pointer type, whereas the right side is a number:

```
int * p = 10; // type clash
```

And even though a computer may represent an address internally with an integer, integers and pointers are conceptually quite different. For example, you wouldn't square a pointer. However, when automatic conversions fail, you may use a type cast:

```
int * p = (int *) 10; // ok, p and (int *) 10 both pointers
```

This sets a pointer to the address 10 by type casting 10 to type pointer-to-int (that is, type int \*). Whether this assignment makes sense is another matter.

You may define a class sufficiently related to a basic type or to another class that it makes sense to convert from one form to another. In such a case, you can tell C++ how to make such conversions automatically or, perhaps, via a type cast. To see how that works, you can recast the pounds-to-stone program from Chapter 3 into class form. First, you need to design an appropriate type. Fundamentally, you're representing one thing (a weight) two ways (pounds and stone). A class provides an excellent way to incorporate two representations of one concept into a single entity. Therefore, it makes sense to place both representations of weight into the same class and then provide class methods for expressing the weight in different forms. Listing 11.16 provides the class header.

#### Listing 11.16 `stonewt.h`

---

```
// stonewt.h -- definition for the Stonewt class
#ifndef STONEWT_H_
#define STONEWT_H_
class Stonewt
{
private:
    enum {Lbs_per_stn = 14}; // pounds per stone
    int stone; // whole stones
    double pds_left; // fractional pounds
    double pounds; // entire weight in pounds
public:
    Stonewt(double lbs); // constructor for double pounds
    Stonewt(int stn, double lbs); // constructor for stone, lbs
    Stonewt(); // default constructor
    ~Stonewt();
    void show_lbs() const; // show weight in pounds format
    void show_stn() const; // show weight in stone format
};
#endif
```

---

As mentioned in Chapter 10, enum provides a convenient way to define class-specific constants, provided that they are integers. Or you could use the following alternative:

```
static const int Lbs_per_stn = 14;
```

Note that the `Stonewt` class has three constructors. They allow you to initialize a `Stonewt` object to a floating-point number of pounds or to a combination of stone and pounds. Or you can create a `Stonewt` object without initializing it:

```
Stonewt blossom(132.5); // weight = 132.5 pounds
Stonewt buttercup(10, 2); // weight = 10 stone, 2 pounds
Stonewt bubbles; // weight = default value
```

The class doesn't really need to declare a destructor because the automatic default constructor is fine for this case. On the other hand, providing an explicit declaration prepares you for the future, when you will have to define constructors.

Also the `Stonewt` class provides two display functions. One displays the weight in pounds, and the other displays the weight in stone and pounds. Listing 11.17 shows the class methods implementation. Note that each constructor assigns values to all three private members. Thus, creating a `Stonewt` object automatically sets both representations of weight.

#### Listing 11.17 `stonewt.cpp`

---

```
// stonewt.cpp -- Stonewt methods
#include <iostream>
using std::cout;
#include "stonewt.h"

// construct Stonewt object from double value
Stonewt::Stonewt(double lbs)
{
    stone = int (lbs) / Lbs_per_stn; // integer division
    pds_left = int (lbs) % Lbs_per_stn + lbs - int (lbs);
    pounds = lbs;
}

// construct Stonewt object from stone, double values
Stonewt::Stonewt(int stn, double lbs)
{
    stone = stn;
    pds_left = lbs;
    pounds = stn * Lbs_per_stn + lbs;
}

Stonewt::Stonewt() // default constructor, wt = 0
{
    stone = pounds = pds_left = 0;
}

Stonewt::~Stonewt() // destructor
{
}
```

```
// show weight in stones
void Stonewt::show_stn() const
{
    cout << stone << " stone, " << pds_left << " pounds\n";
}

// show weight in pounds
void Stonewt::show_lbs() const
{
    cout << pounds << " pounds\n";
}
```

---

Because a `Stonewt` object represents a single weight, it makes sense to provide ways to convert an integer or a floating-point value to a `Stonewt` object. And you have already done so! In C++, any constructor that takes a single argument acts as a blueprint for converting a value of that argument type to the class type. Thus the following constructor serves as instructions for converting a type `double` value to a type `Stonewt` value:

```
Stonewt(double lbs); // template for double-to-Stonewt conversion
```

That is, you can write code like the following:

```
Stonewt myCat; // create a Stonewt object
myCat = 19.6; // use Stonewt(double) to convert 19.6 to Stonewt
```

The program uses the `Stonewt(double)` constructor to construct a temporary `Stonewt` object, using 19.6 as the initialization value. Then memberwise assignment copies the contents of the temporary object into `myCat`. This process is termed an *implicit conversion* because it happens automatically, without the need of an explicit type cast.

Only a constructor that can be used with just one argument works as a conversion function. The following constructor has two arguments, so it cannot be used to convert types:

```
Stonewt(int stn, double lbs); // not a conversion function
```

However, it would act as a guide to `int` conversion if it provided a default value for the second parameter:

```
Stonewt(int stn, double lbs = 0); // int-to-Stonewt conversion
```

Having a constructor work as an automatic type-conversion function seems like a nice feature. As programmers acquired more experience working with C++, however, they found that the automatic aspect isn't always desirable because it can lead to unexpected conversions. So C++ added a new keyword, `explicit`, to turn off the automatic aspect. That is, you can declare the constructor this way:

```
explicit Stonewt(double lbs); // no implicit conversions allowed
```

This turns off implicit conversions such as the preceding example but still allows explicit conversions—that is, conversions using explicit type casts:



```

Stonewt myCat;           // create a Stonewt object
myCat = 19.6;           // not valid if Stonewt(double) is declared as explicit
mycat = Stonewt(19.6); // ok, an explicit conversion
mycat = (Stonewt) 19.6; // ok, old form for explicit typecast

```

### Note

A C++ constructor that contains one argument defines a type conversion from the argument type to the class type. If the constructor is qualified with the keyword `explicit`, the constructor is used for explicit conversions only; otherwise, it is also used for implicit conversions.

When does the compiler use the `Stonewt(double)` function? If the keyword `explicit` is used in the declaration, `Stonewt(double)` is used only for an explicit type cast; otherwise, it is also used for the following implicit conversions:

- When you initialize a `Stonewt` object to a type `double` value
- When you assign a type `double` value to a `Stonewt` object
- When you pass a type `double` value to a function that expects a `Stonewt` argument
- When a function that's declared to return a `Stonewt` value tries to return a `double` value
- When any of the preceding situations use a built-in type that can unambiguously be converted to type `double`

Let's look at the last point in more detail. The argument-matching process provided by function prototyping lets the `Stonewt(double)` constructor act as conversions for other numerical types. That is, both of the following statements work by first converting `int` to `double` and then using the `Stonewt(double)` constructor:

```

Stonewt Jumbo(7000); // uses Stonewt(double), converting int to double
Jumbo = 7300;       // uses Stonewt(double), converting int to double

```

However, this two-step conversion process works only if there is an unambiguous choice. That is, if the class also defined a `Stonewt(long)` constructor, the compiler would reject these statements, probably pointing out that an `int` can be converted to either a `long` or a `double`, so the call is ambiguous.

Listing 11.18 uses the class constructors to initialize some `Stonewt` objects and to handle type conversions. Be sure to compile Listing 11.17 along with Listing 11.18.

#### Listing 11.18 `stone.cpp`

---

```

// stone.cpp -- user-defined conversions
// compile with stonewt.cpp
#include <iostream>
using std::cout;
#include "stonewt.h"
void display(const Stonewt & st, int n);
int main()
{

```

```
Stonewt incognito = 275; // uses constructor to initialize
Stonewt wolfe(285.7);    // same as Stonewt wolfe = 285.7;
Stonewt taft(21, 8);

cout << "The celebrity weighed ";
incognito.show_stn();
cout << "The detective weighed ";
wolfe.show_stn();
cout << "The President weighed ";
taft.show_lbs();
incognito = 276.8;      // uses constructor for conversion
taft = 325;             // same as taft = Stonewt(325);
cout << "After dinner, the celebrity weighed ";
incognito.show_stn();
cout << "After dinner, the President weighed ";
taft.show_lbs();
display(taft, 2);
cout << "The wrestler weighed even more.\n";
display(422, 2);
cout << "No stone left unearned\n";
return 0;
}

void display(const Stonewt & st, int n)
{
    for (int i = 0; i < n; i++)
    {
        cout << "Wow! ";
        st.show_stn();
    }
}
```

---

Here is the output of the program in Listing 11.18:

```
The celebrity weighed 19 stone, 9 pounds
The detective weighed 20 stone, 5.7 pounds
The President weighed 302 pounds
After dinner, the celebrity weighed 19 stone, 10.8 pounds
After dinner, the President weighed 325 pounds
Wow! 23 stone, 3 pounds
Wow! 23 stone, 3 pounds
The wrestler weighed even more.
Wow! 30 stone, 2 pounds
Wow! 30 stone, 2 pounds
No stone left unearned
```

## Program Notes

Note that when a constructor has a single argument, you can use the following form when initializing a class object:

```
// a syntax for initializing a class object when
// using a constructor with one argument
Stonewt incognito = 275;
```

This is equivalent to the other two forms shown earlier:

```
// standard syntax forms for initializing class objects
Stonewt incognito(275);
Stonewt incognito = Stonewt(275);
```

However, the last two forms can also be used with constructors that have multiple arguments.

Next, note the following two assignments from Listing 11.18:

```
incognito = 276.8;
taft = 325;
```

The first of these assignments uses the constructor with a type `double` argument to convert `276.8` to a type `Stonewt` value. This sets the `pounds` member of `incognito` to `276.8`. Because it uses the constructor, this assignment also sets the `stone` and `pds_left` members of the class. Similarly, the second assignment converts a type `int` value to type `double` and then uses `Stonewt(double)` to set all three member values in the process.

Finally, note the following function call:

```
display(422, 2); // convert 422 to double, then to Stonewt
```

The prototype for `display()` indicates that its first argument should be the `Stonewt` object. (Either a `Stonewt` or a `Stonewt &` formal parameter matches a `Stonewt` argument.) Confronted with an `int` argument, the compiler looks for a `Stonewt(int)` constructor to convert the `int` to the desired `Stonewt` type. Failing to find that constructor, the compiler looks for a constructor with some other built-in type to which an `int` can be converted. The `Stonewt(double)` constructor fits the bill. So the compiler converts `int` to `double` and then uses `Stonewt(double)` to convert the result to a `Stonewt` object.

## Conversion Functions

Listing 11.18 converts a number to a `Stonewt` object. Can you do the reverse? That is, can you convert a `Stonewt` object to a `double` value, as in the following?

```
Stonewt wolfe(285.7);
double host = wolfe; // ?? possible ??
```

The answer is that you can do this—but not by using constructors. Constructors only provide for converting another type *to* the class type. To do the reverse, you have to use a special form of a C++ operator function called a *conversion function*.

Conversion functions are user-defined type casts, and you can use them the way you would use a type cast. For example, if you define a `Stonewt-to-double` conversion function, you can use the following conversions:

```
Stonewt wolfe(285.7);
double host = double (wolfe);    // syntax #1
double thinker = (double) wolfe; // syntax #2
```

Or you can let the compiler figure out what to do:

```
Stonewt wells(20, 3);
double star = wells; // implicit use of conversion function
```

The compiler, noting that the right side is type `Stonewt` and the left side is type `double`, looks to see if you've defined a conversion function that matches this description. (If it can't find such a definition, the compiler generates an error message to the effect that it can't assign a `Stonewt` to a `double`.)

So how do you create a conversion function? To convert to type `typeName`, you use a conversion function in this form:

```
operator typeName();
```

Note the following points:

- The conversion function must be a class method.
- The conversion function must not specify a return type.
- The conversion function must have no arguments.

For example, a function to convert to type `double` would have this prototype:

```
operator double();
```

The `typeName` part (in this case `typeName` is `double`) tells the conversion the type to which to convert, so no return type is needed. The fact that the function is a class method means it has to be invoked by a particular class object, and that tells the function which value to convert. Thus, the function doesn't need arguments.

To add functions that convert `stone_wt` objects to type `int` and to type `double`, then, requires adding the following prototypes to the class declaration:

```
operator int();
operator double();
```

Listing 11.19 shows the modified class declaration.

#### Listing 11.19 `stonewt1.h`

---

```
// stonewt1.h -- revised definition for the Stonewt class
#ifndef STONEWT1_H_
#define STONEWT1_H_
class Stonewt
{
```

```

private:
    enum {Lbs_per_stn = 14};    // pounds per stone
    int stone;                 // whole stones
    double pds_left;           // fractional pounds
    double pounds;             // entire weight in pounds
public:
    Stonewt(double lbs);       // construct from double pounds
    Stonewt(int stn, double lbs); // construct from stone, lbs
    Stonewt();                 // default constructor
    ~Stonewt();
    void show_lbs() const;     // show weight in pounds format
    void show_stn() const;     // show weight in stone format
// conversion functions
    operator int() const;
    operator double() const;
};
#endif

```

---

Listing 11.20 shows Listing 11.18 modified to include the definitions for these two conversion functions. Note that each function returns the desired value, even though there is no declared return type. Also note that the `int` conversion definition rounds to the nearest integer rather than truncating. For example, if `pounds` is `114.4`, then `pounds + 0.5` is `114.9`, and `int (114.9)` is `114`. But if `pounds` is `114.6`, `pounds + 0.5` is `115.1`, and `int (115.1)` is `115`.

#### Listing 11.20 `stonewt1.cpp`

---

```

// stonewt1.cpp -- Stonewt class methods + conversion functions
#include <iostream>
using std::cout;
#include "stonewt1.h"

// construct Stonewt object from double value
Stonewt::Stonewt(double lbs)
{
    stone = int (lbs) / Lbs_per_stn;    // integer division
    pds_left = int (lbs) % Lbs_per_stn + lbs - int(lbs);
    pounds = lbs;
}

// construct Stonewt object from stone, double values
Stonewt::Stonewt(int stn, double lbs)
{
    stone = stn;
    pds_left = lbs;
    pounds = stn * Lbs_per_stn + lbs;
}

```

```
Stonewt::Stonewt()           // default constructor, wt = 0
{
    stone = pounds = pds_left = 0;
}

Stonewt::~Stonewt()         // destructor
{
}

// show weight in stones
void Stonewt::show_stn() const
{
    cout << stone << " stone, " << pds_left << " pounds\n";
}

// show weight in pounds
void Stonewt::show_lbs() const
{
    cout << pounds << " pounds\n";
}

// conversion functions
Stonewt::operator int() const
{
    return int (pounds + 0.5);
}

Stonewt::operator double()const
{
    return pounds;
}
```

---

Listing 11.21 tests the new conversion functions. The assignment statement in the program uses an implicit conversion, whereas the final `cout` statement uses an explicit type cast. Be sure to compile Listing 11.20 along with Listing 11.21.

---

**Listing 11.21 stone1.cpp**

```
// stone1.cpp -- user-defined conversion functions
// compile with stonewt1.cpp
#include <iostream>
#include "stonewt1.h"

int main()
{
```

```

using std::cout;
Stonewt poppins(9,2.8);    // 9 stone, 2.8 pounds
double p_wt = poppins;    // implicit conversion
cout << "Convert to double => ";
cout << "Poppins: " << p_wt << " pounds.\n";
cout << "Convert to int => ";
cout << "Poppins: " << int (poppins) << " pounds.\n";
return 0;
}

```

---

Here's the output from the program in Listings 11.19, 11.20, and 11.21, which shows the result of converting the type `Stonewt` object to type `double` and to type `int`:

```
Convert to double => Poppins: 128.8 pounds.
```

```
Convert to int => Poppins: 129 pounds.
```

### Applying Type Conversions Automatically

Listing 11.21 uses `int (poppins)` with `cout`. Suppose that, instead, it omitted the explicit type cast:

```
cout << "Poppins: " << poppins << " pounds.\n";
```

Would the program use an implicit conversion, as in the following statement?

```
double p_wt = poppins;
```

The answer is no. In the `p_wt` example, the context indicates that `poppins` should be converted to type `double`. But in the `cout` example, nothing indicates whether the conversion should be to `int` or to `double`. Facing this lack of information, the compiler would complain that you were using an ambiguous conversion. Nothing in the statement indicates what type to use.

Interestingly, if the class defined only the `double` conversion function, the compiler would accept the statement. That's because with only one conversion possible, there is no ambiguity.

You can have a similar situation with assignment. With the current class declarations, the compiler rejects the following statement as being ambiguous:

```
long gone = poppins;    // ambiguous
```

In C++, you can assign both `int` and `double` values to a `long` variable, so the compiler legitimately can use either conversion function. The compiler doesn't want the responsibility of choosing which. But if you eliminate one of the two conversion functions, the compiler accepts the statement. For example, suppose you omit the `double` definition. Then the compiler will use the `int` conversion to convert `poppins` to a type `int` value. Then it converts the `int` value to type `long` when assigning it to `gone`.

When the class defines two or more conversions, you can still use an explicit type cast to indicate which conversion function to use. You can use either of these type cast notations:

```
long gone = (double) poppins; // use double conversion
long gone = int (poppins); // use int conversion
```

The first of these statements converts `poppins` weight to a `double` value, and then assignment converts the `double` value to type `long`. Similarly, the second statement converts `poppins` first to type `int` and then to `long`.

Like conversion constructors, conversion functions can be a mixed blessing. The problem with providing functions that make automatic, implicit conversions is that they may make conversions when you don't expect them. Suppose, for example, that you happen to write the following code when you're sleep deprived:

```
int ar[20];
...
Stonewt temp(14, 4);
...
int Temp = 1;
...
cout << ar[temp] << "\n"; // used temp instead of Temp
```

Normally, you'd expect the compiler to catch a blunder such as using an object instead of an integer as an array index. But the `Stonewt` class defines an operator `int()`, so the `Stonewt` object `temp` is converted to the `int` `200` and be used as an array index. The moral is that often it's best to use explicit conversions and exclude the possibility of implicit conversions. In C++98, the keyword `explicit` doesn't work with conversion functions, but C++11 removes that limitation. So with C++11, you can declare a conversion operator as `explicit`:

```
class Stonewt
{
...
// conversion functions
    explicit operator int() const;
    explicit operator double() const;
};
```

With these declarations in place, you would use a type cast to invoke the operators.

Another approach is to replace a conversion function with a nonconversion function that does the same task—but only if called explicitly. That is, you can replace

```
Stonewt::operator int() { return int (pounds + 0.5); }
```

with

```
int Stonewt::Stone_to_Int() { return int (pounds + 0.5); }
```

This disallows the following:

```
int plb = poppins;
```



But if you really need a conversion, it allows the following:

```
int plb = poppins.Stone_to_Int();
```

### Caution

You should use implicit conversion functions with care. Often a function that can only be invoked explicitly is the best choice.

In summary, then, C++ provides the following type conversions for classes:

- A class constructor that has but a single argument serves as an instruction for converting a value of the argument type to the class type. For example, the `Stonewt` class constructor with a type `int` argument is invoked automatically when you assign a type `int` value to a `Stonewt` object. However, using `explicit` in the constructor declaration eliminates implicit conversions and allows only explicit conversions.
- A special class member operator function called a *conversion function* serves as an instruction for converting a class object to some other type. The conversion function is a class member, has no declared return type, has no arguments, and is called `operator typeName()`, where `typeName` is the type to which the object is to be converted. This conversion function is invoked automatically when you assign a class object to a variable of that type or use the type cast operator to that type.

## Conversions and Friends

Let's bring addition to the `Stonewt` class. As mentioned in the discussion of the `Time` class, you can use either a member function or a friend function to overload addition. (To simplify matters, assume that no conversion functions of the `operator double()` form are defined.) You can implement addition with the following member function:

```
Stonewt Stonewt::operator+(const Stonewt & st) const
{
    double pds = pounds + st.pounds;
    Stonewt sum(pds);
    return sum;
}
```

Or you can implement addition as a friend function this way:

```
Stonewt operator+(const Stonewt & st1, const Stonewt & st2)
{
    double pds = st1.pounds + st2.pounds;
    Stonewt sum(pds);
    return sum;
}
```

Remember, you can provide the method definition or the friend definition but not both. Either form lets you do the following:

```
Stonewt jennySt(9, 12);
Stonewt bennySt(12, 8);
Stonewt total;
total = jennySt + bennySt;
```

Also given the `Stonewt(double)` constructor, each form lets you do the following:

```
Stonewt jennySt(9, 12);
double kennyD = 176.0;
Stonewt total;
total = jennySt + kennyD;
```

But only the friend function lets you do this:

```
Stonewt jennySt(9, 12);
double pennyD = 146.0;
Stonewt total;
total = pennyD + jennySt;
```

To see why, you can translate each addition into the corresponding function calls. First,

```
total = jennySt + bennySt;
```

becomes

```
total = jennySt.operator+(bennySt); // member function
```

or else

```
total = operator+(jennySt, bennySt); // friend function
```

In either case, the actual argument types match the formal arguments. Also the member function is invoked, as required, by a `Stonewt` object.

Next,

```
total = jennySt + kennyD;
```

becomes

```
total = jennySt.operator+(kennyD); // member function
```

or else

```
total = operator+(jennySt, kennyD); // friend function
```

Again, the member function is invoked, as required, by a `Stonewt` object. This time, in each case, one argument (`kennyD`) is type `double`, which invokes the `Stonewt(double)` constructor to convert the argument to a `Stonewt` object.

By the way, having an `operator double()` member function defined would create confusion at this point because that would create another option for interpretation. Instead of converting `kennyD` to `double` and performing `Stonewt` addition, the compiler could convert `jennySt` to `double` and perform `double` addition. Having too many conversion functions creates ambiguities.

Finally,  
`total = pennyD + jennySt;`

becomes

```
total = operator+(pennyD, jennySt); // friend function
```

Here, both arguments are type `double`, which invokes the `Stonewt(double)` constructor to convert them to `Stonewt` objects.

However, the member function version wouldn't be able to add `jennySt` to `pennyD`. Converting the addition syntax to a function call would look like this:

```
total = pennyD.operator+(jennySt); // not meaningful
```

But this is meaningless because only a class object can invoke a member function. C++ does not attempt to convert `pennyD` to a `Stonewt` object. Conversion takes place for member function arguments, not for member function invokers.

The lesson here is that defining addition as a friend makes it easier for a program to accommodate automatic type conversions. The reason is that both operands become function arguments, so function prototyping comes into play for both operands.

### Choices in Implementing Addition

Given that you want to add `double` quantities to `Stonewt` quantities, you have a couple choices. The first, as you just saw, is to define the following as a friend function and have the `Stonewt(double)` constructor handle conversions of type `double` arguments to type `Stonewt` arguments:

```
operator+(const Stonewt &, const Stonewt &)
```

The second choice is to further overload the addition operator with functions that explicitly use one type `double` argument:

```
Stonewt operator+(double x); // member function
friend Stonewt operator+(double x, Stonewt & s);
```

That way, the following statement exactly matches the `operator+(double x)` member function:

```
total = jennySt + kennyD; // Stonewt + double
```

And the following statement exactly matches the `operator+(double x, Stonewt & s)` friend function:

```
total = pennyD + jennySt; // double + Stonewt
```

Earlier, we did something similar for `vector` multiplication.

Each choice has advantages. The first choice (relying on implicit conversions) results in a shorter program because you define fewer functions. That also implies less work for you and fewer chances to mess up. The disadvantage is the added overhead in time and memory needed to invoke the conversion constructor whenever a conversion is needed. The

second choice (additional functions explicitly matching the types), however, is the mirror image. It makes for a longer program and more work on your part, but it runs a bit faster.

If your program makes intensive use of adding `double` values to `Stonewt` objects, it may pay to overload addition to handle such cases directly. If the program uses such addition only occasionally, it's simpler to rely on automatic conversions, or if you want to be more careful, on explicit conversions.

## Summary

This chapter covers many important aspects of defining and using classes. Some of the material in this chapter may seem vague to you until your own experiences enrich your understanding.

Normally, the only way you can access private class members is by using a class method. C++ alleviates that restriction with friend functions. To make a function a friend function, you declare the function in the class declaration and preface the declaration with the keyword `friend`.

C++ extends overloading to operators by letting you define special operator functions that describe how particular operators relate to a particular class. An operator function can be a class member function or a friend function. (A few operators can only be class member functions.) C++ lets you invoke an operator function either by calling the function or by using the overloaded operator with its usual syntax. An operator function for the operator `op` has this form:

```
operatorop(argument-list)
```

*argument-list* represents operands for the operator. If the operator function is a class member function, then the first operand is the invoking object and isn't part of *argument-list*. For example, this chapter overloaded addition by defining an `operator+()` member function for the `vector` class. If `up`, `right`, and `result` are three vectors, you can use either of the following statements to invoke vector addition:

```
result = up.operator+(right);  
result = up + right;
```

For the second version, the fact that the operands `up` and `right` are type `vector` tells C++ to use the `vector` definition of addition.

When an operator function is a member function, the first operand is the object invoking the function. In the preceding statements, for example, the `up` object is the invoking object. If you want to define an operator function so that the first operand is not a class object, you must use a friend function. Then you can pass the operands to the function definition in whichever order you want.

One of the most common tasks for operator overloading is defining the `<<` operator so that it can be used in conjunction with the `cout` object to display an object's contents. To allow an `ostream` object to be the first operand, you define the operator function as a

friend. To allow the redefined operator to be concatenated with itself, you make the return type `ostream &`. Here's a general form that satisfies those requirements:

```
ostream & operator<<(ostream & os, const c_name & obj)
{
    os << ... ; // display object contents
    return os;
}
```

If, however, the class has methods that return values for the data members you want to display, you can use those methods instead of direct access in `operator<<()`. In that case, the function needn't (and shouldn't) be a friend.

C++ lets you establish conversions to and from class types. First, any class constructor that takes a single argument acts as a conversion function, converting values of the argument type to the class type. C++ invokes the constructor automatically if you assign a value of the argument type to an object. For example, suppose you have a `String` class with a constructor that takes a `char *` value as its sole argument. Then, if `bean` is a `String` object, you can use the following statement:

```
bean = "pinto"; // converts type char * to type String
```

If, however, you precede the constructor declaration with the keyword `explicit`, the constructor can be used only for explicit conversions:

```
bean = String("pinto"); // converts type char * to type String explicitly
```

To convert from a class to another type, you must define a conversion function and provide instruction about how to make the conversion. A conversion function must be a member function. If it is to convert to type `typeName`, it should have the following prototype:

```
operator typeName();
```

Note that it must have no declared return type, must have no arguments, and must (despite having no declared return type) return the converted value. For example, a function to convert type `Vector` to type `double` would have this function form:

```
Vector::operator double()
{
    ...
    return a_double_value;
}
```

Experience has shown that often it is better not to rely on such implicit conversion functions.

As you might have noticed, classes require much more care and attention to detail than do simple C-style structures. In return, they do much more for you.

## Chapter Review

1. Use a member function to overload the multiplication operator for the `Stonewt` class; have the operator multiply the data members by a type `double` value. Note that this will require carryover for the stone–pound representation. That is, twice 10 stone 8 pounds is 21 stone 2 pounds.
2. What are the differences between a friend function and a member function?
3. Does a nonmember function have to be a friend to access a class's members?
4. Use a friend function to overload the multiplication operator for the `Stonewt` class; have the operator multiply the `double` value by the `Stone` value.
5. Which operators cannot be overloaded?
6. What restriction applies to overloading the following operators? `=`, `()`, `[]`, and `->`
7. Define a conversion function for the `vector` class that converts a `vector` object to a type `double` value that represents the vector's magnitude.

## Programming Exercises

1. Modify Listing 11.15 so that it writes the successive locations of the random walker into a file. Label each position with the step number. Also have the program write the initial conditions (target distance and step size) and the summarized results to the file. The file contents might look like this:

```
Target Distance: 100, Step Size: 20
0: (x,y) = (0, 0)
1: (x,y) = (-11.4715, 16.383)
2: (x,y) = (-8.68807, -3.42232)
...
26: (x,y) = (42.2919, -78.2594)
27: (x,y) = (58.6749, -89.7309)
After 27 steps, the subject has the following location:
(x,y) = (58.6749, -89.7309)
or
(m,a) = (107.212, -56.8194)
Average outward distance per step = 3.97081
```

2. Modify the `vector` class header and implementation files (Listings 11.13 and 11.14) so that the magnitude and angle are no longer stored as data components. Instead, they should be calculated on demand when the `magval()` and `angval()` methods are called. You should leave the public interface unchanged (the same public methods with the same arguments) but alter the private section, including some of the private method and the method implementations. Test the modified version with

Listing 11.15, which should be left unchanged because the public interface of the `Vector` class is unchanged.

3. Modify Listing 11.15 so that instead of reporting the results of a single trial for a particular target/step combination, it reports the highest, lowest, and average number of steps for  $N$  trials, where  $N$  is an integer entered by the user.
4. Rewrite the final `Time` class example (Listings 11.10, 11.11, and 11.12) so that all the overloaded operators are implemented using friend functions.
5. Rewrite the `Stonewt` class (Listings 11.16 and 11.17) so that it has a state member that governs whether the object is interpreted in stone form, integer pounds form, or floating-point pounds form. Overload the `<<` operator to replace the `show_stn()` and `show_lbs()` methods. Overload the addition, subtraction, and multiplication operators so that one can add, subtract, and multiply `Stonewt` values. Test your class with a short program that uses all the class methods and friends.
6. Rewrite the `Stonewt` class (Listings 11.16 and 11.17) so that it overloads all six relational operators. The operators should compare the `pounds` members and return a type `bool` value. Write a program that declares an array of six `Stonewt` objects and initializes the first three objects in the array declaration. Then it should use a loop to read in values used to set the remaining three array elements. Then it should report the smallest element, the largest element, and how many elements are greater or equal to 11 stone. (The simplest approach is to create a `Stonewt` object initialized to 11 stone and to compare the other objects with that object.)
7. A complex number has two parts: a real part and an imaginary part. One way to write an imaginary number is this:  $(3.0, 4.0)$ . Here 3.0 is the real part and 4.0 is the imaginary part. Suppose  $a = (A, Bi)$  and  $c = (C, Di)$ . Here are some complex operations:
  - Addition:  $a + c = (A + C, (B + D)i)$
  - Subtraction:  $a - c = (A - C, (B - D)i)$
  - Multiplication:  $a \times c = (A \times C - B \times D, (A \times D + B \times C)i)$
  - Multiplication: ( $x$  a real number):  $x \times c = (x \times C, x \times Di)$
  - Conjugation:  $\sim a = (A, - Bi)$

Define a complex class so that the following program can use it with correct results:

```
#include <iostream>
using namespace std;
#include "complex0.h" // to avoid confusion with complex.h
int main()
{
    complex a(3.0, 4.0); // initialize to (3,4i)
```

```

complex c;
cout << "Enter a complex number (q to quit):\n";
while (cin >> c)
{
    cout << "c is " << c << '\n';
    cout << "complex conjugate is " << ~c << '\n';
    cout << "a is " << a << '\n';
    cout << "a + c is " << a + c << '\n';
    cout << "a - c is " << a - c << '\n';
    cout << "a * c is " << a * c << '\n';
    cout << "2 * c is " << 2 * c << '\n';
    cout << "Enter a complex number (q to quit):\n";
}
cout << "Done!\n";
return 0;
}

```

Note that you have to overload the `<<` and `>>` operators. Standard C++ already has complex support—rather more extensive than in this example—in a `complex` header file, so use `complex0.h` to avoid conflicts. Use `const` whenever warranted.

Here is a sample run of the program:

```

Enter a complex number (q to quit):
real: 10
imaginary: 12
c is (10,12i)
complex conjugate is (10,-12i)
a is (3,4i)
a + c is (13,16i)
a - c is (-7,-8i)
a * c is (-18,76i)
2 * c is (20,24i)
Enter a complex number (q to quit):
real: q
Done!

```

Note that `cin >> c`, through overloading, now prompts for real and imaginary parts.



*This page intentionally left blank*

# Classes and Dynamic Memory Allocation

In this chapter you'll learn about the following:

- Using dynamic memory allocation for class members
- Implicit and explicit copy constructors
- Implicit and explicit overloaded assignment operators
- What you must do if you use `new` in a constructor
- Using `static` class members
- Using placement `new` with objects
- Using pointers to objects
- Implementing a queue abstract data type (ADT)

This chapter looks at how to use `new` and `delete` with classes and how to deal with some of the subtle problems that using dynamic memory can cause. This may sound like a short list of topics, but these topics affect constructor design, destructor design, and operator overloading.

Let's look at a specific example of how C++ can add to your memory load. Suppose you want to create a class with a member that represents someone's last name. The simplest, most primitive way is to use a character array member to hold the name. But this has some drawbacks. You might use a 14-character array and then run into Bartholomew Smeadsbury-Crafthovingham. Or to be safer, you might use a 40-character array. But if you then create an array of 2,000 such objects, you'll waste a lot of memory with character arrays that are only partly filled. (At that point, you're adding to the computer's memory load.) There is an alternative.

Often it is much better to decide many matters, such as how much storage to use, when a program runs rather than when it's compiled. The usual C++ approach to storing a name in an object is to use the `new` operator in a class constructor to allocate the correct amount of memory while the program is running. The usual way to accomplish this is to

use the `string` class, which takes care of the memory management details for you. But you won't learn much about memory management that way, so let's attack the problem directly. Introducing `new` to a class constructor raises several new problems unless you remember to take a series of additional steps, such as expanding the class destructor, bringing all constructors into harmony with the `new` destructor, and writing additional class methods to facilitate correct initialization and assignment. (This chapter, of course, explains all these steps.)

## Dynamic Memory and Classes

What would you like for breakfast, lunch, and dinner for the next month? How many ounces of milk for dinner on the 3rd day? How many raisins in your cereal for breakfast on the 15th day? If you're like most people, you'd rather postpone some of those decisions until the actual mealtimes. Part of the strategy in C++ is to take the same attitude toward memory allocation, letting the program decide about memory during runtime rather than during compile time. That way, memory use can depend on the needs of a program instead of on a rigid set of storage-class rules. Remember that to gain dynamic control of memory, C++ utilizes the `new` and `delete` operators. Unhappily, using these operators with classes can pose some new programming problems. As you'll see, destructors can become necessary instead of merely ornamental. And sometimes you have to overload an assignment operator to get a program to behave properly. We'll look into these matters now.

### A Review Example and Static Class Members

We haven't used `new` and `delete` for a while, so let's review them with a short program. While we're at it, let's look at a new storage class: the static class member. The vehicle will be a `StringBad` class, later to be superseded by the slightly more able `String` class. (You've already seen the standard C++ `string` class, and you'll learn more about it in Chapter 16, "The `string` Class and the Standard Template Library." Meanwhile, the humble `StringBad` and `String` classes in this chapter provide some insight into what underlies such a class. A lot of programming techniques go into providing such a friendly interface.)

`StringBad` and `String` class objects will hold a pointer to a string and a value representing the string length. We'll use the `StringBad` and `String` classes primarily to give an inside look at how `new`, `delete`, and `static` class members operate. For that reason, the constructors and destructors will display messages when called so that you can follow the action. Also we'll omit several useful member and friend functions, such as overloaded `++` and `>>` operators and a conversion function, in order to simplify the class interface. (But rejoice! The review questions for this chapter give you the opportunity to add those useful support functions.) Listing 12.1 shows the class declaration.

Listing 12.1 `strngbad.h`

---

```
// strngbad.h -- flawed string class definition
#include <iostream>
#ifndef STRNGBAD_H_
#define STRNGBAD_H_
class StringBad
{
private:
    char * str;           // pointer to string
    int len;             // length of string
    static int num_strings; // number of objects
public:
    StringBad(const char * s); // constructor
    StringBad();               // default constructor
    ~StringBad();             // destructor
// friend function
    friend std::ostream & operator<<(std::ostream & os,
                                     const StringBad & st);
};
#endif
```

---

Why call the class `StringBad`? This is to remind you that `StringBad` is an example under development. It's the first stage of developing a class by using dynamic memory allocation, and it does the obvious things correctly; for example, it uses `new` and `delete` correctly in the constructors and destructor. It doesn't really do bad things, but the design omits doing some additional good things that are necessary but not at all obvious. Seeing the problems the class has should help you understand and remember the non-obvious changes you will make later, when you convert it to the more functional `String` class.

You should note two points about this declaration. First, it uses a `pointer-to-char` instead of a `char` array to represent a name. This means that the class declaration does not allocate storage space for the string itself. Instead, it uses `new` in the constructors to allocate space for the string. This arrangement avoids straitjacketing the class declaration with a predefined limit to the string size.

Second, the definition declares the `num_strings` member as belonging to the `static` storage class. A *static class member* has a special property: A program creates only one copy of a static class variable, regardless of the number of objects created. That is, a static member is shared among all objects of that class, much as a phone number might be shared among all members of a family. If, say, you create 10 `StringBad` objects, there would be 10 `str` members and 10 `len` members, but just 1 shared `num_strings` member (see Figure 12.1). This is convenient for data that should be private to a class but that should have the same value for all class objects. The `num_strings` member, for example, is intended to keep track of the number of objects created.

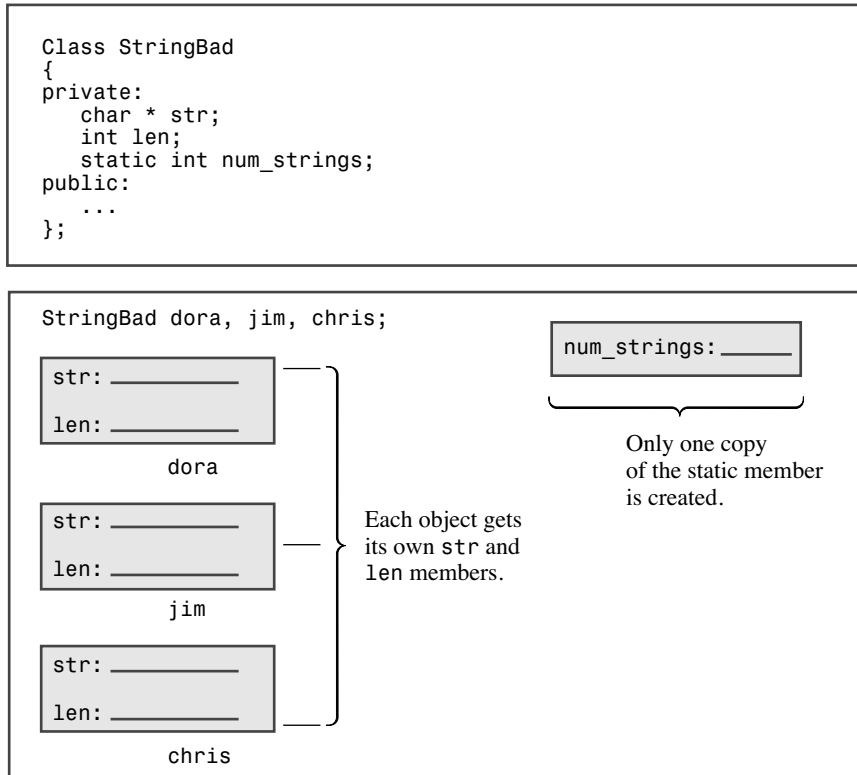

Figure 12.1 A static data member.

By the way, Listing 12.1 uses the `num_strings` member as a convenient means of illustrating static data members and as a device to point out potential programming problems. In general, a string class doesn't need such a member.

Take a look at the implementation of the class methods in Listing 12.2. Notice how it handles using a pointer and a static member.

#### Listing 12.2 `strngbad.cpp`

```

// strngbad.cpp -- StringBad class methods
#include <cstring> // string.h for some
#include "strngbad.h"
using std::cout;

// initializing static class member
int StringBad::num_strings = 0;

// class methods

```

```

// construct StringBad from C string
StringBad::StringBad(const char * s)
{
    len = std::strlen(s);           // set size
    str = new char[len + 1];       // allot storage
    std::strcpy(str, s);           // initialize pointer
    num_strings++;                 // set object count
    cout << num_strings << ": \"" << str
         << "\"" object created\n"; // For Your Information
}

StringBad::StringBad()             // default constructor
{
    len = 4;
    str = new char[4];
    std::strcpy(str, "C++");       // default string
    num_strings++;
    cout << num_strings << ": \"" << str
         << "\"" default object created\n"; // FYI
}

StringBad::~StringBad()           // necessary destructor
{
    cout << "\"" << str << "\"" object deleted, "; // FYI
    --num_strings;                // required
    cout << num_strings << " left\n"; // FYI
    delete [] str;                 // required
}

std::ostream & operator<<(std::ostream & os, const StringBad & st)
{
    os << st.str;
    return os;
}

```

---

First, notice the following statement from Listing 12.2:

```
int StringBad::num_strings = 0;
```

This statement initializes the static `num_strings` member to 0. Note that you cannot initialize a static member variable inside the class declaration. That's because the declaration is a description of how memory is to be allocated but it doesn't allocate memory. You allocate and initialize memory by creating an object using that format. In the case of a static class member, you initialize the static member independently, with a separate statement outside the class declaration. That's because the static class member is stored separately rather than as part of an object. Note that the initialization statement gives the type and uses the scope operator, but it doesn't use the static keyword.

This initialization goes in the methods file, not in the class declaration file. That's because the class declaration is in a header file, and a program may include a header file in several other files. That would result in multiple copies of the initialization statement, which is an error.

The exception to the noninitialization of a static data member inside the class declaration (see Chapter 10, "Objects and Classes") is if the static data member is a `const` of integral or enumeration type.

### Note

A static data member is declared in the class declaration and is initialized in the file containing the class methods. The scope operator is used in the initialization to indicate to which class the static member belongs. However, if the static member is a `const` integral type or an enumeration type, it can be initialized in the class declaration itself.

Next, notice that each constructor contains the expression `num_strings++`. This ensures that each time a program creates a new object, the shared variable `num_strings` increases by one, keeping track of the total number of `String` objects. Also the destructor contains the expression `--num_strings`. Thus, the `String` class also keeps track of deleted objects, keeping the value of the `num_strings` member current.

Now look at the first constructor in Listing 12.2, which initializes a `String` object with a regular C string:

```
StringBad::StringBad(const char * s)
{
    len = std::strlen(s);           // set size
    str = new char[len + 1];       // allot storage
    std::strcpy(str, s);           // initialize pointer
    num_strings++;                 // set object count
    cout << num_strings << ": \"" << str
         << "\" object created\n"; // For Your Information
}
```

Recall that the class `str` member is just a pointer, so the constructor has to provide the memory for holding a string. You can pass a string pointer to the constructor when you initialize an object:

```
String boston("Boston");
```

The constructor must then allocate enough memory to hold the string, and then it must copy the string to that location. Let's go through the process step-by-step.

First, the function initializes the `len` member, using the `strlen()` function to compute the length of the string. Next, it uses `new` to allocate sufficient space to hold the string, and then it assigns the address of the new memory to the `str` member. (Recall that `strlen()` returns the length of a string, not counting the terminating null character, so the constructor adds one to `len` to allow space for the string, including the null character.)

Next, the constructor uses `strcpy()` to copy the passed string into the new memory. Then it updates the object count. Finally, to help you monitor what's going on, the constructor displays the current number of objects and the string stored in the object. This feature will come in handy later when we deliberately lead the `StringBad` class into trouble.

To understand this approach, you should realize that the string is not stored in the object. The string is stored separately, in heap memory, and the object merely stores information that tells where to find the string.

Note that you do not use this:

```
str = s; // not the way to go
```

This merely stores the address without making a copy of the string.

The default constructor behaves similarly, except that it provides a default string of "C++".

The destructor contains the example's most important addition to the handling of classes:

```
StringBad::~StringBad()           // necessary destructor
{
    cout << "\"" << str << "\" object deleted, "; // FYI
    --num_strings;                // required
    cout << num_strings << " left\n"; // FYI
    delete [] str;                // required
}
```

The destructor begins by announcing when the destructor gets called. This part is informative but not essential. However, the `delete` statement is vital. Recall that the `str` member points to memory allocated with `new`. When a `StringBad` object expires, the `str` pointer expires. But the memory `str` pointed to remains allocated unless you use `delete` to free it. Deleting an object frees the memory occupied by the object itself, but it does not automatically free memory pointed to by pointers that were object members. For that, you must use the destructor. By placing the `delete` statement in the destructor, you ensure that the memory that a constructor allocates with `new` is freed when the object expires.

### Warning

Whenever you use `new` in a constructor to allocate memory, you should use `delete` in the corresponding destructor to free that memory. If you use `new []` (with brackets), then you should use `delete []` (with brackets).

Listing 12.3, which is taken from a program under development at *The Daily Vegetable*, illustrates when and how the `StringBad` constructors and destructors work. The program places the object declarations within an inner block because the destructor is called when execution exits the block in which an object is defined. Without the inner block, the destructors would be called after execution exits `main()`, which would prevent you in some environments from seeing the destructor messages before the execution window closes. Be sure to compile Listing 12.2 along with Listing 12.3.



Listing 12.3 `vegnews.cpp`

---

```

// vegnews.cpp -- using new and delete with classes
// compile with strngbad.cpp
#include <iostream>
using std::cout;
#include "strngbad.h"

void callme1(StringBad &); // pass by reference
void callme2(StringBad); // pass by value

int main()
{
    using std::endl;
    {
        cout << "Starting an inner block.\n";
        StringBad headline1("Celery Stalks at Midnight");
        StringBad headline2("Lettuce Prey");
        StringBad sports("Spinach Leaves Bowl for Dollars");
        cout << "headline1: " << headline1 << endl;
        cout << "headline2: " << headline2 << endl;
        cout << "sports: " << sports << endl;
        callme1(headline1);
        cout << "headline1: " << headline1 << endl;
        callme2(headline2);
        cout << "headline2: " << headline2 << endl;
        cout << "Initialize one object to another:\n";
        StringBad sailor = sports;
        cout << "sailor: " << sailor << endl;
        cout << "Assign one object to another:\n";
        StringBad knot;
        knot = headline1;
        cout << "knot: " << knot << endl;
        cout << "Exiting the block.\n";
    }
    cout << "End of main()\n";

    return 0;
}

void callme1(StringBad & rsb)
{
    cout << "String passed by reference:\n";
    cout << "    \" << rsb << "\"\n";
}

void callme2(StringBad sb)

```

```

{
    cout << "String passed by value:\n";
    cout << "    \"    << sb << "\"\n";
}

```

---

## Note

This first draft of a design for `StringBad` has some deliberate flaws that make the exact output undefined. Some compilers I used, for example, produced versions that aborted before completing. However, although the output details may differ, the basic problems and solutions (soon to be revealed!) are the same.

Here is the output produced after compiling the program in Listing 12.3 with the Borland C++ 5.5 command-line compiler:

```

Starting an inner block.
1: "Celery Stalks at Midnight" object created
2: "Lettuce Prey" object created
3: "Spinach Leaves Bowl for Dollars" object created
headline1: Celery Stalks at Midnight
headline2: Lettuce Prey
sports: Spinach Leaves Bowl for Dollars
String passed by reference:
    "Celery Stalks at Midnight"
headline1: Celery Stalks at Midnight
String passed by value:
    "Lettuce Prey"
"Lettuce Prey" object deleted, 2 left
headline2: D  
Initialize one object to another:
sailor: Spinach Leaves Bowl for Dollars
Assign one object to another:
3: "C++" default object created
knot: Celery Stalks at Midnight
Exiting the block.
"Celery Stalks at Midnight" object deleted, 2 left
"Spinach Leaves Bowl for Dollars" object deleted, 1 left
"Spinach Leaves Bowl for Doll8" object deleted, 0 left
"@g" object deleted, -1 left
"-|" object deleted, -2 left
End of main()

```

The various nonstandard characters that appear in the output will vary from system to system; they are one of the signs that `StringBad` deserves to be called bad. Another sign is the negative object count. Newer compiler/operating system combinations typically abort the program just before displaying the line about having -1 objects left, and some of them report a General Protection Fault (GPF). A GPF indicates that a program tried to access a memory location forbidden to it; this is another bad sign.

### Program Notes

The program in Listing 12.3 starts out fine, but it staggers to a strange and ultimately disastrous conclusion. Let's begin by looking at the good parts. The constructor announces that it has created three `StringBad` objects, it numbers them, and the program uses the overloaded `<<` operator to list them:

```
1: "Celery Stalks at Midnight" object created
2: "Lettuce Prey" object created
3: "Spinach Leaves Bowl for Dollars" object created
headline1: Celery Stalks at Midnight
headline2: Lettuce Prey
sports: Spinach Leaves Bowl for Dollars
```

Then the program passes `headline1` to the `callme1()` function and redisplay `headline1` after the call. Here's the code:

```
callme1(headline1);
cout << "headline1: " << headline1 << endl;
```

And here's the result:

```
String passed by reference:
  "Celery Stalks at Midnight"
headline1: Celery Stalks at Midnight
```

This section of code seems to work fine, too.

But then the program executes the following code:

```
callme2(headline2);
cout << "headline2: " << headline2 << endl;
```

Here, `callme2()` passes `headline2` by value instead of by reference, and the result indicates a serious problem:

```
String passed by value:
  "Lettuce Prey"
"Lettuce Prey" object deleted, 2 left
headline2: Dû°
```

First, passing `headline2` as a function argument somehow causes the destructor to be called. Second, although passing by value is supposed to protect the original argument from change, the function messes up the original string beyond recognition, and some nonstandard characters get displayed. (The exact text displayed will depend on what happens to sitting in memory.)

Even worse, look at the end of the output when the destructor gets called automatically for each of the objects created earlier:

```
Exiting the block.
"Celery Stalks at Midnight" object deleted, 2 left
"Spinach Leaves Bowl for Dollars" object deleted, 1 left
"Spinach Leaves Bowl for Doll8" object deleted, 0 left
```

```
"@g" object deleted, -1 left
"-|" object deleted, -2 left
End of main()
```

Because automatic storage objects are deleted in an order opposite to that in which they are created, the first three objects deleted are `knots`, `sailor`, and `sport`. The `knots` and `sailor` deletions look okay, but for `sport`, `Dollars` has become `Doll8`. The only thing the program does with `sport` is use it to initialize `sailor`, but that act appears to have altered `sport`. And the last two objects deleted, `headline2` and `headline1`, are unrecognizable. Something messes up these strings before they are deleted. Also the counting is bizarre. How can there be `-2` objects left?

Actually, the peculiar counting is a clue. Every object is constructed once and destroyed once, so the number of constructor calls should equal the number of destructor calls. Because the object count (`num_strings`) is decremented two times more than it is incremented, a constructor that doesn't increment `num_strings` must be creating two objects. The class definition declares and defines two constructors (both of which increment `num_strings`), but it turns out that the program uses three constructors! For example, consider this line:

```
StringBad sailor = sports;
```

What constructor is used here? Not the default constructor, and not the constructor with a `const char *` parameter. Remember, initialization using this form is another syntax for the following:

```
StringBad sailor = StringBad(sports); //constructor using sports
```

Because `sports` is type `StringBad`, a matching constructor could have this prototype:

```
StringBad(const StringBad &);
```

And it turns out that the compiler automatically generates this constructor (called a *copy constructor* because it makes a copy of an object) if you initialize one object to another. The automatic version would not know about updating the `num_strings` static variable, so it would mess up the counting scheme. Indeed, all the problems exhibited by this example stem from member functions that the compiler generates automatically, so let's look at that topic now.

## Special Member Functions

The problems with the `StringBad` class stem from *special member functions*. These are member functions that are defined automatically. In the case of `StringBad`, the behavior of these member functions is inappropriate to this particular class design. In particular, C++ automatically provides the following member functions:

- A default constructor if you define no constructors
- A default destructor if you don't define one
- A copy constructor if you don't define one

- An assignment operator if you don't define one
- An address operator if you don't define one

More precisely, the compiler generates definitions for the last three items if a program uses objects in such a way as to require them. For example, if you assign one object to another, the program provides a definition for the assignment operator.

It turns out that the implicit copy constructor and the implicit assignment operator cause the `StringBad` class problems.

The implicit address operator returns the address of the invoking object (that is, the value of the `this` pointer). That's fine for our purposes, and we won't discuss this member function further. The default destructor does nothing, and we won't discuss it, either, other than to point out that the class has already provided a substitute for it. But the others do warrant more discussion.

C++11 provides two more special member functions—the *move constructor* and the *move assignment operator*. Chapter 18, “Visiting with the New C++ Standard,” discusses these further.

## Default Constructors

If you fail to provide any constructors at all, C++ provides you with a default constructor. For example, suppose you define a `Klunk` class and omit any constructors. In this case, the compiler supplies the following default:

```
Klunk::Klunk() { } // implicit default constructor
```

That is, it supplies a constructor (the *defaulted* default constructor) that takes no arguments and that does nothing. It's needed because creating an object always invokes a constructor:

```
Klunk klunk; // invokes default constructor
```

The default constructor makes `klunk` like an ordinary automatic variable; that is, its value at initialization is unknown.

After you define any constructor, C++ doesn't bother to define a default constructor. If you want to create objects that aren't initialized explicitly, you then have to define a default constructor explicitly. It's a constructor with no arguments, but you can use it to set particular values:

```
Klunk::Klunk() // explicit default constructor
{
    klunk_ct = 0;
    ...
}
```

A constructor with arguments still can be a default constructor if all its arguments have default values. For example, the `Klunk` class could have the following inline constructor:

```
Klunk(int n = 0) { klunk_ct = n; }
```

However, you can have only one default constructor. That is, you can't do this:

```
Klunk() { klunk_ct = 0 }           // constructor #1
Klunk(int n = 0) { klunk_ct = n; } // ambiguous constructor #2
```

Why is this ambiguous? Consider the following two declarations:

```
Klunk kar(10); // clearly matches Klunk(int n)
Klunk bus;     // could match either constructor
```

The second declaration matches constructor #1 (no argument), but it also matches constructor #2 (using the default argument 0). This will cause the compiler to issue an error message.

## Copy Constructors

A copy constructor is used to copy an object to a newly created object. That is, it's used during initialization, including passing function arguments by value and not during ordinary assignment. A copy constructor for a class normally has this prototype:

```
Class_name(const Class_name &);
```

Note that it takes a constant reference to a class object as its argument. For example, a copy constructor for the `String` class would have this prototype:

```
StringBad(const StringBad &);
```

You must know two things about a copy constructor: when it's used and what it does.

## When a Copy Constructor Is Used

A copy constructor is invoked whenever a new object is created and initialized to an existing object of the same kind. This happens in several situations. The most obvious situation is when you explicitly initialize a new object to an existing object. For example, given that `motto` is a `StringBad` object, the following four defining declarations invoke a copy constructor:

```
StringBad ditto(motto); // calls StringBad(const StringBad &)
StringBad metoo = motto; // calls StringBad(const StringBad &)
StringBad also = StringBad(motto);
                        // calls StringBad(const StringBad &)
StringBad * pStringBad = new StringBad(motto);
                        // calls StringBad(const StringBad &)
```

Depending on the implementation, the middle two declarations may use a copy constructor directly to create `metoo` and `also`, or they may use a copy constructor to generate temporary objects whose contents are then assigned to `metoo` and `also`. The last example initializes an anonymous object to `motto` and assigns the address of the new object to the `pstring` pointer.

Less obviously, a compiler uses a copy constructor whenever a program generates copies of an object. In particular, it's used when a function passes an object by value (as `callme2()` does in Listing 12.3) or when a function returns an object. Remember, passing

by value means creating a copy of the original variable. A compiler also uses a copy constructor whenever it generates temporary objects. For example, a compiler might generate a temporary `Vector` object to hold an intermediate result when adding three `Vector` objects. Compilers vary as to when they generate temporary objects, but all invoke a copy constructor when passing objects by value and when returning them. In particular, this function call in Listing 12.3 invokes a copy constructor:

```
callme2(headline2);
```

The program uses a copy constructor to initialize `sb`, the formal `StringBad`-type parameter for the `callme2()` function.

By the way, the fact that passing an object by value involves invoking a copy constructor is a good reason for passing by reference instead. That saves the time of invoking the constructor and the space for storing the new object.

### What a Default Copy Constructor Does

The default copy constructor performs a member-by-member copy of the nonstatic members (*memberwise copying*, also sometimes called *shallow copying*). Each member is copied by value. In Listing 12.3, the statement

```
StringBad sailor = sports;
```

amounts to the following (aside from the fact that it doesn't compile because access to private members is not allowed):

```
StringBad sailor;
sailor.str = sports.str;
sailor.len = sports.len;
```

If a member is itself a class object, the copy constructor for that class is used to copy one member object to another. Static members, such as `num_strings`, are unaffected because they belong to the class as a whole instead of to individual objects. Figure 12.2 illustrates the action of an implicit copy constructor.

### Back to Stringbad: Where the Copy Constructor Goes Wrong

You are now in a position to understand the twofold weirdness of Listing 12.3. (Let's assume that the output is the one shown after the listing.) The first weirdness is that the program output indicates two more objects destroyed than constructed. The explanation is that the program does create two additional objects, using the default copy constructor. The copy constructor is used to initialize the formal parameter of `callme2()` when that function is called, and it is used to initialize the object `sailor` to `sports`. The default copy constructor doesn't vocalize its activities, so it doesn't announce its creations, and it doesn't increment the `num_strings` counter. However, the destructor does update the count, and it's invoked upon the demise of all objects, regardless of how they were constructed. This weirdness is a problem because it means the program doesn't keep an accurate object count. The solution is to provide an explicit copy constructor that does update the count:

```
StringBad::StringBad(const String & s)
{
    num_strings++;
    ...// important stuff to go here
}
```

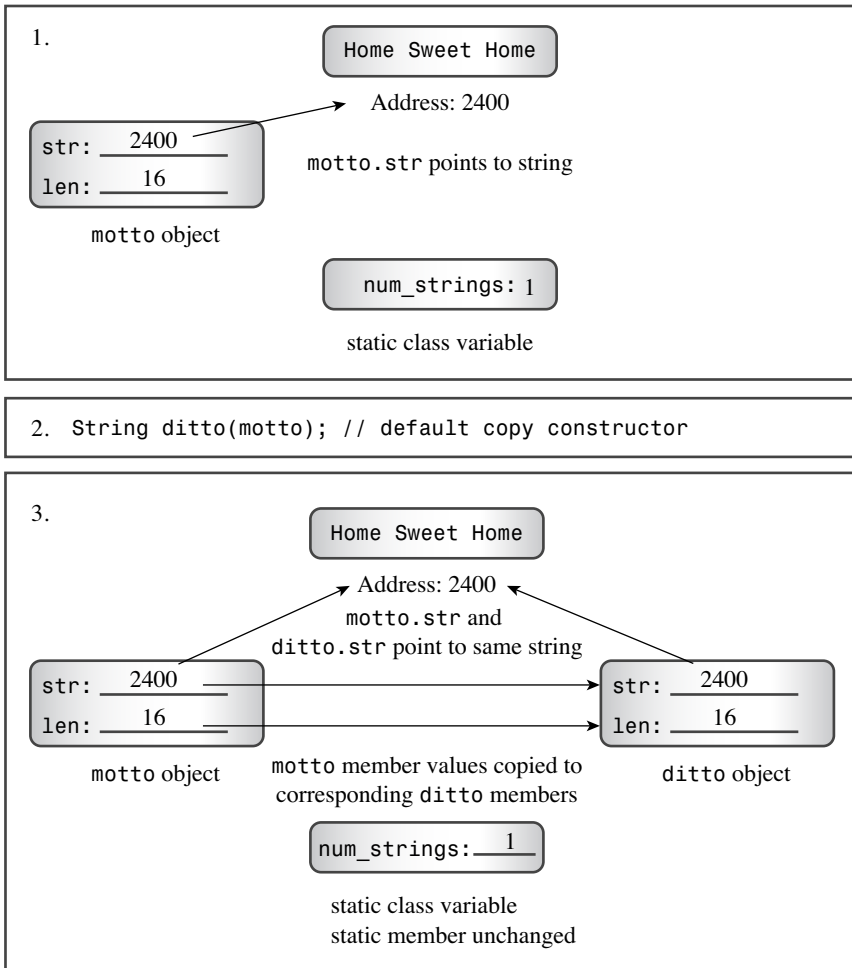

Figure 12.2 An inside look at memberwise copying.

**Tip**

If your class has a static data member whose value changes when new objects are created, you should provide an explicit copy constructor that handles the accounting.



The second weirdness is the more subtle and dangerous. One symptom is the garbled string contents:

```
headline2: Dû°
```

The cause is that the implicit copy constructor copies by value. Consider Listing 12.3, for example. The effect, recall, is this:

```
sailor.str = sport.str;
```

This does not copy the string; it copies the pointer to a string. That is, after `sailor` is initialized to `sports`, you wind up with two pointers to the same string. That's not a problem when the `operator<<()` function uses the pointer to display the string. It *is* a problem when the destructor is called. Recall that the `StringBad` destructor frees the memory pointed to by the `str` pointer. The effect of destroying `sailor` is this:

```
delete [] sailor.str; // delete the string that ditto.str points to
```

The `sailor.str` pointer points to "Spinach Leaves Bowl for Dollars" because it is assigned the value of `sports.str`, which points to that string. So the `delete` statement frees the memory occupied by the string "Spinach Leaves Bowl for Dollars".

Next, the effect of destroying `sports` is this:

```
delete [] sports.str; // effect is undefined
```

Here, `sports.str` points to the same memory location that has already been freed by the destructor for `sailor`, and this results in undefined, possibly harmful, behavior. In the case of Listing 12.3, the program produces mangled strings, which is usually a sign of memory mismanagement.

Another disturbing symptom is that attempting to delete the same memory twice can cause the program to abort. Microsoft Visual C++ 2010 (debug mode), for example, displays an error message window saying "Debug Assertion Failed!", and g++ 4.4.1 on Linux reports "double free or corruption" and aborts. Other systems might provide different messages or even no message, but the same evil lurks within the programs.

### Fixing the Problem by Defining an Explicit Copy Constructor

The cure for the problems in the class design is to make a *deep copy*. That is, rather than just copy the address of the string, the copy constructor should duplicate the string and assign the address of the duplicate to the `str` member. That way, each object gets its own string rather than referring to another object's string. And each call of the destructor frees a different string rather than making duplicate attempts at freeing the same string. Here's how you can code the `String` copy constructor:

```
StringBad::StringBad(const StringBad & st)
{
    num_strings++; // handle static member update
    len = st.len; // same length
    str = new char [len + 1]; // allot space
    std::strcpy(str, st.str); // copy string to new location
}
```

```

cout << num_strings << ": \" << str
    << "\" object created\n"; // For Your Information
}

```

What makes defining the copy constructor necessary is the fact that some class members are new-initialized pointers to data rather than the data themselves. Figure 12.3 illustrates deep copying.

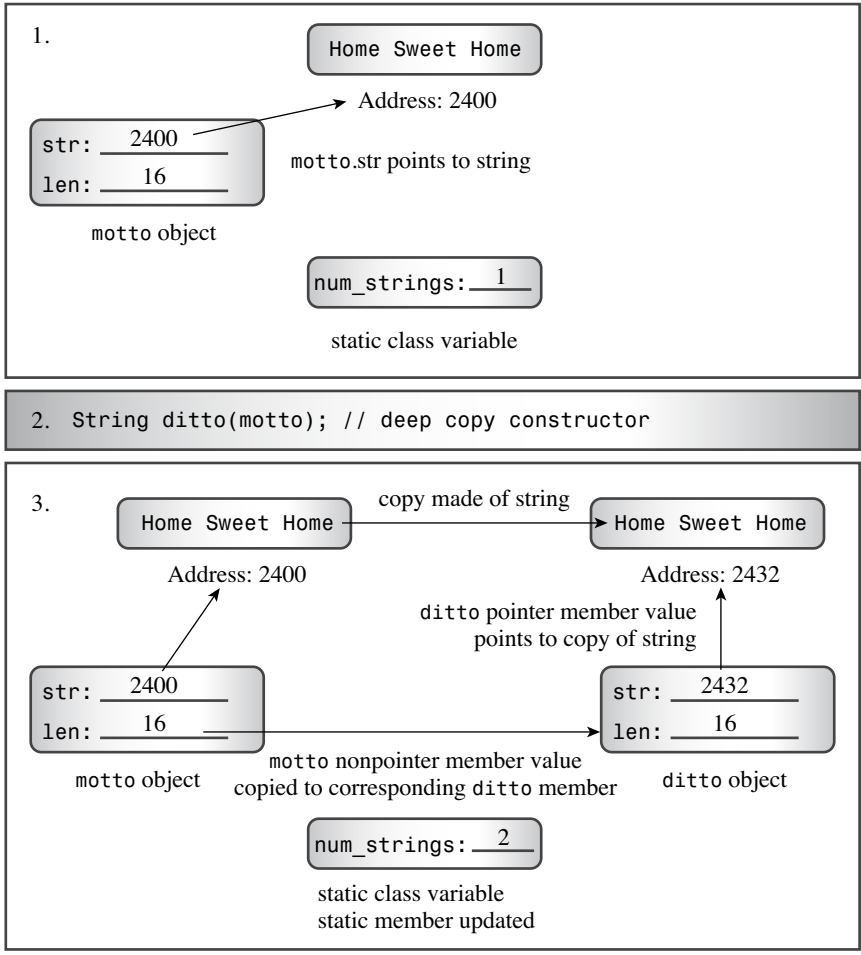

Figure 12.3 An inside look at deep copying.

**Caution**

If a class contains members that are pointers initialized by `new`, you should define a copy constructor that copies the pointed-to data instead of copying the pointers themselves. This is termed *deep copying*. The alternative form of copying (*memberwise, or shallow, copying*) just copies pointer values. A shallow copy is just that—the shallow “scraping off” of pointer information for copying, rather than the deeper “mining” required to copy the constructs referred to by the pointers.

**More StringBad Problems: Assignment Operators**

Not all the problems in Listing 12.3 can be blamed on the default copy constructor; you have to look at the default assignment operator, too. Just as ANSI C allows structure assignment, C++ allows class object assignment. It does so by automatically overloading an assignment operator for a class. This operator has the following prototype:

```
Class_name & Class_name::operator=(const Class_name &);
```

That is, it takes and returns a reference to an object of the class. For example, here’s the prototype for the `StringBad` class:

```
StringBad & StringBad::operator=(const StringBad &);
```

**When an Assignment Operator Is Used and What It Does**

An overloaded assignment operator is used when you assign one object to another existing object:

```
StringBad headline1("Celery Stalks at Midnight");
...
StringBad knot;
knot = headline1; // assignment operator invoked
```

An assignment operator is not necessarily used when initializing an object:

```
StringBad metoo = knot; // use copy constructor, possibly assignment, too
```

Here `metoo` is a newly created object being initialized to `knot`’s values; hence, the copy constructor is used. However, as mentioned before, implementations have the option of handling this statement in two steps: using the copy constructor to create a temporary object and then using assignment to copy the values to the new object. That is, initialization always invokes a copy constructor, and forms using the `=` operator may also invoke an assignment operator.

Like a copy constructor, an implicit implementation of an assignment operator performs a member-to-member copy. If a member is itself an object of some class, the program uses the assignment operator defined for that class to do the copying for that particular member. Static data members are unaffected.

## Where StringBad Assignment Goes Wrong

Listing 12.3 assigns `headline1` to `knot`:

```
knot = headline1;
```

When the destructor is called for `knot`, it displays this message:

```
"Celery Stalks at Midnight" object deleted, 2 left
```

When the destructor is called for `headline1`, it displays this message:

```
"-" object deleted, -2 left
```

(Many implementations abort before getting this far.)

Here you see the same problem that the implicit copy constructor caused: corrupted data. Once again, the problem is memberwise copying, which causes both `headline1.str` and `knot.str` to point to the same address. Thus, when the destructor is called for `knot`, it deletes the string "Celery Stalks at Midnight", and when it's called for `headline1`, it attempts to delete the previously deleted string. As mentioned earlier, the effect of attempting to delete previously deleted data is undefined, so it may change the memory contents, and it may cause a program to abort. As some like to point out, if the effect of a particular operation is undefined, your compiler can do anything it wants, including displaying the Declaration of Independence or freeing your hard disk of unsightly files. Of course, it would be a rare thing for a compiler writer to take the time to include such frivolous or destructive behavior.

## Fixing Assignment

The solution for the problems created by an inappropriate default assignment operator is to provide your own assignment operator definition, one that makes a deep copy. The implementation is similar to that of the copy constructor, but there are some differences:

- Because the target object may already refer to previously allocated data, the function should use `delete []` to free former obligations.
- The function should protect against assigning an object to itself; otherwise, the freeing of memory described previously could erase the object's contents before they are reassigned.
- The function returns a reference to the invoking object.

By returning an object, the function can emulate the way ordinary assignment for built-in types can be chained. That is, if `s0`, `s1`, and `s2` are `StringBad` objects, you can write the following:

```
s0 = s1 = s2;
```

In function notation, this becomes the following:

```
s0.operator=(s1.operator=(s2));
```

Thus, the return value of `s1.operator=(s2)` becomes the argument of the `s0.operator=()` function. Because the return value is a reference to a `String` object, it is the correct argument type.

Here's how you could write an assignment operator for the `StringBad` class:

```
StringBad & StringBad::operator=(const StringBad & st)
{
    if (this == &st)           // object assigned to itself
        return *this;         // all done
    delete [] str;             // free old string
    len = st.len;
    str = new char [len + 1]; // get space for new string
    std::strcpy(str, st.str); // copy the string
    return *this;             // return reference to invoking object
}
```

First, the code checks for self-assignment. It does so by seeing if the address of the right-hand side of the assignment (`&s`) is the same as the address of the receiving object (`this`). If so, the program returns `*this` and terminates. You may recall from Chapter 10 that the assignment operator is one of the operators that can be overloaded only by a class member function.

Otherwise, the function proceeds to free the memory that `str` pointed to. The reason for this is that shortly thereafter `str` will be assigned the address of a new string. If you don't first apply the `delete` operator, the previous string will remain in memory. Because the program no longer has a pointer to the old string, that memory will be wasted.

Next, the program proceeds like a copy constructor, allocating enough space for the new string and then copying the string from the right-hand object to the new location.

When it is finished, the program returns `*this` and terminates.

Assignment does not create a new object, so you don't have to adjust the value of the static data member `num_strings`.

Adding the copy constructor and the assignment operator described previously to the `StringBad` class clears up all the problems. Here, for example, are the last few lines of output after these changes have been made:

```
End of main()
"Celery Stalks at Midnight" object deleted, 4 left
"Spinach Leaves Bowl for Dollars" object deleted, 3 left
"Spinach Leaves Bowl for Dollars" object deleted, 2 left
"Lettuce Prey" object deleted, 1 left
"Celery Stalks at Midnight" object deleted, 0 left
```

The object counting is correct now, and none of the strings have been mangled.

## The New, Improved String Class

Now that we are a bit wiser, we can revise the `StringBad` class, renaming it `String`. First, add the copy constructor and the assignment operator just discussed so that the class correctly manages the memory used by class objects. Next, now that you've seen when objects are constructed and destroyed, we can mute the class constructors and destructors so that they no longer announce each time they are used. Also now that you're no longer watching the constructors at work, we can simplify the default constructor so that it constructs an empty string instead of "C++".

Next, we can add a few capabilities to the class. A useful `String` class would incorporate all the functionality of the standard `cstring` library of string functions, but we'll add only enough to see what happens. (Keep in mind that this `String` class is an illustrative example and that the C++ standard `string` class is much more extensive.) In particular, we'll add the following methods:

```
int length () const { return len; }
friend bool operator<(const String &st, const String &st2);
friend bool operator>(const String &st1, const String &st2);
friend bool operator==(const String &st, const String &st2);
friend operator>>(istream &is, String &st);
char & operator[] (int i);
const char & operator[] (int i) const;
static int HowMany();
```

The first new method returns the length of the stored string. The next three friend functions allow you to compare strings. The `operator>>()` function provides simple input capabilities. The two `operator[]()` functions provide array-notation access to individual characters in a string. The static class method `HowMany()` complements the static class data member `num_strings`. Let's look at some details.

### The Revised Default Constructor

The new default constructor merits notice. It looks like this:

```
String::String()
{
    len = 0;
    str = new char[1];
    str[0] = '\0';           // default string
}
```

You might wonder why the code uses

```
str = new char[1];
```

and not this:

```
str = new char;
```

Both forms allocate the same amount of memory. The difference is that the first form is compatible with the class destructor and the second is not. Recall that the destructor contains this code:

```
delete [] str;
```

Using `delete []` is compatible with pointers initialized by using `new []` and with the null pointer. So another possibility would be to replace

```
str = new char[1];
str[0] = '\0';           // default string
```

with this:

```
str = 0; // sets str to the null pointer
```

The effect of using `delete []` with any pointers initialized any other way is undefined:

```
char words[15] = "bad idea";
char * p1= words;
char * p2 = new char;
char * p3;
delete [] p1; // undefined, so don't do it
delete [] p2; // undefined, so don't do it
delete [] p3; // undefined, so don't do it
```

### C++11 Null Pointer

In C++98, the literal `0` has two meanings—it can be the numeric value `0`, and it can be the null pointer—thus making it difficult for the reader and compiler to distinguish between the two. Sometimes programmers use `(void *) 0` to identify the pointer version. (The null pointer itself may have a nonzero internal representation.) Other programmers use `NULL`, a C macro defined to represent the null pointer. However, this proved to be an incomplete solution. C++11 provides a better solution by introducing a new keyword, `nullptr`, to denote the null pointer. You still can use `0` as before—otherwise an enormous amount of existing code would be invalidated—but henceforth the recommendation is to use `nullptr` instead:

```
str = nullptr; // C++11 null pointer notation
```

### Comparison Members

Three of the methods in the `String` class perform comparisons. The `operator<()` function returns `true` if the first string comes before the second string alphabetically (or, more precisely, in the machine collating sequence). The simplest way to implement the string comparison functions is to use the standard `strcmp()` function, which returns a negative value if its first argument precedes the second alphabetically, `0` if the strings are the same, and a positive value if the first follows the second alphabetically. So you can use `strcmp()` like this:

```
bool operator<(const String &st1, const String &st2)
{
    if (std::strcmp(st1.str, st2.str) < 0)
```

```

        return true;
    else
        return false;
}

```

Because the built-in `<` operator already returns a type `bool` value, you can simplify the code further to this:

```

bool operator<(const String &st1, const String &st2)
{
    return (std::strcmp(st1.str, st2.str) < 0);
}

```

Similarly, you can code the other two comparison functions like this:

```

bool operator>(const String &st1, const String &st2)
{
    return st2 < st1;
}
bool operator==(const String &st1, const String &st2)
{
    return (std::strcmp(st1.str, st2.str) == 0);
}

```

The first definition expresses the `>` operator in terms of the `<` operator and would be a good choice for an inline function.

Making the comparison functions friends facilitates comparisons between `String` objects and regular C strings. For example, suppose `answer` is a `String` object and that you have the following code:

```
if ("love" == answer)
```

This gets translated to the following:

```
if (operator=="love", answer)
```

The compiler then uses one of the constructors to convert the code, in effect, to this:

```
if (operator==(String("love"), answer))
```

And this matches the prototype.

## Accessing Characters by Using Bracket Notation

With a standard C-style string, you can use brackets to access individual characters:

```

char city[40] = "Amsterdam";
cout << city[0] << endl; // display the letter A

```

In C++ the two bracket symbols constitute a single operator, the bracket operator, and you can overload this operator by using a method called `operator[]()`. Typically, a binary C++ operator (one with two operands) puts the operator between the two operands, as in `2 + 5`. But the bracket operator places one operand in front of the first bracket and the



other operand between the two brackets. Thus, in the expression `city[0]`, `city` is the first operand, `[]` is the operator, and `0` is the second operand.

Suppose that `opera` is a `String` object:

```
String opera("The Magic Flute");
```

If you use the expression `opera[4]`, C++ looks for a method with this name and signature:

```
String::operator[] (int i)
```

If it finds a matching prototype, the compiler replaces the expression `opera[4]` with this function call:

```
opera.operator[] (4)
```

The `opera` object invokes the method, and the array subscript `4` becomes the function argument.

Here's a simple implementation:

```
char & String::operator[] (int i)
{
    return str[i];
}
```

With this definition, the statement

```
cout << opera[4];
```

becomes this:

```
cout << opera.operator[4];
```

The return value is `opera.str[4]`, or the character `'m'`. So the public method gives access to private data.

Declaring the return type as `type char &` allows you to assign values to a particular element. For example, you can use the following:

```
String means("might");
means[0] = 'r';
```

The second statement is converted to an overloaded operator function call:

```
means.operator[] [0] = 'r';
```

This assigns `'r'` to the method's return value. But the function returns a reference to `means.str[0]`, making the code equivalent to

```
means.str[0] = 'r';
```

This last line of code violates private access, but because `operator[] ()` is a class method, it is allowed to alter the array contents. The net effect of the code is that `"might"` becomes `"right"`.

Suppose you have a constant object:

```
const String answer("futile");
```

Then, if the only available definition for `operator [] ()` is the one you've just seen, the following code is labeled an error:

```
cout << answer[1]; // compile-time error
```

The reason is that `answer` is `const`, and the method doesn't promise not to alter data. (In fact, sometimes the method's job is to alter data, so it can't promise not to.)

However, C++ distinguishes between `const` and non-`const` function signatures when overloading, so you can provide a second version of `operator [] ()` that is used just by `const String` objects:

```
// for use with const String objects
const char & String::operator[](int i) const
{
    return str[i];
}
```

With the definitions, you have read/write access to regular `String` objects and read-only access to `const String` data:

```
String text("Once upon a time");
const String answer("futile");
cout << text[1]; // ok, uses non-const version of operator [] ()
cout << answer[1]; // ok, uses const version of operator [] ()
cin >> text[1]; // ok, uses non-const version of operator [] ()
cin >> answer[1]; // compile-time error
```

## Static Class Member Functions

It's possible to declare a member function as being static. (The keyword `static` should appear in the function declaration but not in the function definition if the latter is separate.) This has two important consequences.

First, a static member function doesn't have to be invoked by an object; in fact, it doesn't even get a `this` pointer to play with. If the static member function is declared in the public section, it can be invoked using the class name and the scope-resolution operator. For instance, you can give the `String` class a static member function called `HowMany ()` with the following prototype/definition in the class declaration:

```
static int HowMany() { return num_strings; }
```

It could be invoked like this:

```
int count = String::HowMany(); // invoking a static member function
```

The second consequence is that because a static member function is not associated with a particular object, the only data members it can use are the static data members.

For example, the `HowMany()` static method can access the `num_strings` static member, but not `str` or `len`.

Similarly, a static member function can be used to set a classwide flag that controls how some aspect of the class interface behaves. For example, it can control the formatting used by a method that displays class contents.

## Further Assignment Operator Overloading

Before looking at the new listings for the `String` class example, let's consider another matter. Suppose you want to copy an ordinary string to a `String` object. For example, suppose you use `getline()` to read a string and you want to place it in a `String` object. The class methods already allow you to do the following:

```
String name;
char temp[40];
cin.getline(temp, 40);
name = temp; // use constructor to convert type
```

However, this might not be a satisfactory solution if you have to do it often. To see why, let's review how the final statement works:

1. The program uses the `String(const char *)` constructor to construct a temporary `String` object containing a copy of the string stored in `temp`. Remember from Chapter 11, "Working with Classes," that a constructor with a single argument serves as a conversion function.
2. In Listing 12.6, later in this chapter, the program uses the `String & String::operator=(const String &)` function to copy information from the temporary object to the `name` object.
3. The program calls the `~String()` destructor to delete the temporary object.

The simplest way to make the process more efficient is to overload the assignment operator so that it works directly with ordinary strings. This removes the extra steps of creating and destroying a temporary object. Here's one possible implementation:

```
String & String::operator=(const char * s)
{
    delete [] str;
    len = std::strlen(s);
    str = new char[len + 1];
    std::strcpy(str, s);
    return *this;
}
```

As usual, you must deallocate memory formerly managed by `str` and allocate enough memory for the new string.

Listing 12.4 shows the revised class declaration. In addition to the changes already mentioned, it defines the constant `CINLIM`, which is used in implementing `operator>>()`.

**Listing 12.4 string1.h**

---

```
// string1.h -- fixed and augmented string class definition

#ifndef STRING1_H_
#define STRING1_H_
#include <iostream>
using std::ostream;
using std::istream;

class String
{
private:
    char * str;           // pointer to string
    int len;             // length of string
    static int num_strings; // number of objects
    static const int CINLIM = 80; // cin input limit
public:
    // constructors and other methods
    String(const char * s); // constructor
    String();               // default constructor
    String(const String &); // copy constructor
    ~String();              // destructor
    int length () const { return len; }
    // overloaded operator methods
    String & operator=(const String &);
    String & operator=(const char *);
    char & operator[] (int i);
    const char & operator[] (int i) const;
    // overloaded operator friends
    friend bool operator<(const String &st, const String &st2);
    friend bool operator>(const String &st1, const String &st2);
    friend bool operator==(const String &st, const String &st2);
    friend ostream & operator<<(ostream & os, const String & st);
    friend istream & operator>>(istream & is, String & st);
    // static function
    static int HowMany();
};
#endif
```

---

Listing 12.5 presents the revised method definitions.

**Listing 12.5 string1.cpp**

---

```
// string1.cpp -- String class methods
#include <cstring>           // string.h for some
#include "string1.h"       // includes <iostream>
```

```

using std::cin;
using std::cout;

// initializing static class member

int String::num_strings = 0;

// static method
int String::HowMany()
{
    return num_strings;
}

// class methods
String::String(const char * s)    // construct String from C string
{
    len = std::strlen(s);        // set size
    str = new char[len + 1];     // allot storage
    std::strcpy(str, s);        // initialize pointer
    num_strings++;              // set object count
}

String::String()                 // default constructor
{
    len = 4;
    str = new char[1];
    str[0] = '\0';              // default string
    num_strings++;
}

String::String(const String & st)
{
    num_strings++;              // handle static member update
    len = st.len;              // same length
    str = new char [len + 1];   // allot space
    std::strcpy(str, st.str);   // copy string to new location
}

String::~String()               // necessary destructor
{
    --num_strings;             // required
    delete [] str;             // required
}

// overloaded operator methods

// assign a String to a String

```

```
String & String::operator=(const String & st)
{
    if (this == &st)
        return *this;
    delete [] str;
    len = st.len;
    str = new char[len + 1];
    std::strcpy(str, st.str);
    return *this;
}

// assign a C string to a String
String & String::operator=(const char * s)
{
    delete [] str;
    len = std::strlen(s);
    str = new char[len + 1];
    std::strcpy(str, s);
    return *this;
}

// read-write char access for non-const String
char & String::operator[](int i)
{
    return str[i];
}

// read-only char access for const String
const char & String::operator[](int i) const
{
    return str[i];
}

// overloaded operator friends

bool operator<(const String &st1, const String &st2)
{
    return (std::strcmp(st1.str, st2.str) < 0);
}

bool operator>(const String &st1, const String &st2)
{
    return st2 < st1;
}

bool operator==(const String &st1, const String &st2)
{

```

```

    return (std::strcmp(st1.str, st2.str) == 0);
}

// simple String output
ostream & operator<<(ostream & os, const String & st)
{
    os << st.str;
    return os;
}

// quick and dirty String input
istream & operator>>(istream & is, String & st)
{
    char temp[String::CINLIM];
    is.get(temp, String::CINLIM);
    if (is)
        st = temp;
    while (is && is.get() != '\n')
        continue;
    return is;
}

```

---

The overloaded `>>` operator provides a simple way to read a line of keyboard input into a `String` object. It assumes an input line of `String::CINLIM` or fewer characters and discards any characters beyond that limit. Keep in mind that the value of an `istream` object in an `if` condition evaluates to `false` if input fails for some reason, such as encountering an end-of-file condition, or in the case of `get(char *, int)`, reading an empty line.

Listing 12.6 exercises the `String` class with a short program that lets you enter a few strings. The program has the user enter sayings, puts the strings into `String` objects, displays them, and reports which string is the shortest and which comes first alphabetically.

#### Listing 12.6 `sayings1.cpp`

---

```

// sayings1.cpp -- using expanded String class
// compile with string1.cpp
#include <iostream>
#include "string1.h"
const int ArSize = 10;
const int MaxLen = 81;
int main()
{
    using std::cout;
    using std::cin;
    using std::endl;
    String name;

```

```
cout <<"Hi, what's your name?\n">> ";
cin >> name;

cout << name << ", please enter up to " << ArSize
    << " short sayings <empty line to quit>:\n";
String sayings[ArSize];    // array of objects
char temp[MaxLen];        // temporary string storage
int i;
for (i = 0; i < ArSize; i++)
{
    cout << i+1 << ": ";
    cin.get(temp, MaxLen);
    while (cin && cin.get() != '\n')
        continue;
    if (!cin || temp[0] == '\0')    // empty line?
        break;                    // i not incremented
    else
        sayings[i] = temp;    // overloaded assignment
}
int total = i;                // total # of lines read

if ( total > 0)
{
    cout << "Here are your sayings:\n";
    for (i = 0; i < total; i++)
        cout << sayings[i][0] << ": " << sayings[i] << endl;

    int shortest = 0;
    int first = 0;
    for (i = 1; i < total; i++)
    {
        if (sayings[i].length() < sayings[shortest].length())
            shortest = i;
        if (sayings[i] < sayings[first])
            first = i;
    }
    cout << "Shortest saying:\n" << sayings[shortest] << endl;;
    cout << "First alphabetically:\n" << sayings[first] << endl;
    cout << "This program used "<< String::HowMany()
        << " String objects. Bye.\n";
}
else
    cout << "No input! Bye.\n";
return 0;
}
```

---



**Note**

Older versions of `get(char *, int)` don't evaluate to `false` upon reading an empty line. For those versions, however, the first character in the string is a null character if an empty line is entered. This example uses the following code:

```
if (!cin || temp[0] == '\0')    // empty line?
    break;                    // i not incremented
```

If the implementation follows the current C++ Standard, the first test in the `if` statement detects an empty line, whereas the second test detects the empty line for older implementations.

The program in Listing 12.6 asks the user to enter up to 10 sayings. Each saying is read into a temporary character array and then copied to a `String` object. If the user enters a blank line, a `break` statement terminates the input loop. After echoing the input, the program uses the `length()` and `operator<()` member functions to locate the shortest string and the alphabetically earliest string. The program also uses the subscript operator (`[]`) to preface each saying with its initial character. Here's a sample run:

```
Hi, what's your name?
>> Misty Gutz
Misty Gutz, please enter up to 10 short sayings <empty line to quit>:
1: a fool and his money are soon parted
2: penny wise, pound foolish
3: the love of money is the root of much evil
4: out of sight, out of mind
5: absence makes the heart grow fonder
6: absinthe makes the hart grow fonder
7:
Here are your sayings:
a: a fool and his money are soon parted
p: penny wise, pound foolish
t: the love of money is the root of much evil
o: out of sight, out of mind
a: absence makes the heart grow fonder
a: absinthe makes the hart grow fonder
Shortest saying:
penny wise, pound foolish
First alphabetically:
a fool and his money are soon parted
This program used 11 String objects. Bye.
```

## Things to Remember When Using `new` in Constructors

By now you've noticed that you must take special care when using `new` to initialize pointer members of an object. In particular, you should do the following:

- If you use `new` to initialize a pointer member in a constructor, you should use `delete` in the destructor.
- The uses of `new` and `delete` should be compatible. You should pair `new` with `delete` and `new []` with `delete []`.
- If there are multiple constructors, all should use `new` the same way—either all with brackets or all without brackets. There's only one destructor, so all constructors have to be compatible with that destructor. However, it is permissible to initialize a pointer with `new` in one constructor and with the null pointer (`0`, or, with C++11, `nullptr`) in another constructor because it's okay to apply the `delete` operation (with or without brackets) to the null pointer.

### NULL or 0 or `nullptr`?

Historically, the null pointer can be represented by `0` or by `NULL`, a symbolic constant defined as `0` in several header files. C programmers often use `NULL` instead of `0` as a visual reminder that the value is a pointer value, just as they use `'\0'` instead of `0` for the null character as a visual reminder that this value is a character. The C++ tradition, however, has favored a simple `0` instead of the equivalent `NULL`. And, as mentioned earlier, C++11 offers the `nullptr` keyword as a better alternative.

- You should define a copy constructor that initializes one object to another by doing deep copying. Typically, the constructor should emulate the following example:

```
String::String(const String & st)
{
    num_strings++;           // handle static member update if necessary
    len = st.len;           // same length as copied string
    str = new char [len + 1]; // allot space
    std::strcpy(str, st.str); // copy string to new location
}
```

In particular, the copy constructor should allocate space to hold the copied data, and it should copy the data, not just the address of the data. Also it should update any static class members whose value would be affected by the process.

- You should define an assignment operator that copies one object to another by doing deep copying. Typically, the class method should emulate the following example:

```
String & String::operator=(const String & st)
{
    if (this == &st)           // object assigned to itself
        return *this;         // all done
    delete [] str;             // free old string
    len = st.len;
    str = new char [len + 1]; // get space for new string
    std::strcpy(str, st.str); // copy the string
    return *this;             // return reference to invoking object
}
```

In particular, the method should check for self-assignment; it should free memory formerly pointed to by the member pointer; it should copy the data, not just the address of the data; and it should return a reference to the invoking object.

## Don'ts and Dos

The following excerpt contains two examples of what not to do and one example of a good constructor:

```
String::String()
{
    str = "default string"; // oops, no new []
    len = std::strlen(str);
}

String::String(const char * s)
{
    len = std::strlen(s);
    str = new char;         // oops, no []
    std::strcpy(str, s);   // oops, no room
}

String::String(const String & st)
{
    len = st.len;
    str = new char[len + 1]; // good, allocate space
    std::strcpy(str, st.str); // good, copy value
}
```

The first constructor fails to use `new` to initialize `str`. The destructor, when called for a default object, applies `delete` to `str`. The result of applying `delete` to a pointer not initialized by `new` is undefined, but it is probably bad. Any of the following would be okay:

```
String::String()
{
    len = 0;
    str = new char[1]; // uses new with []
    str[0] = '\0';
}
```

```
String::String()
{
    len = 0;
    str = 0; // or, with C++11, str = nullptr;
}

String::String()
{
    static const char * s = "C++"; // initialized just once
    len = std::strlen(s);
    str = new char[len + 1]; // uses new with []
    std::strcpy(str, s);
}
```

Next, the second constructor in the original excerpt applies `new`, but it fails to request the correct amount of memory; hence, `new` returns a block containing space for just one character. Attempting to copy a longer string to that location is asking for memory problems. Also the use of `new` without brackets is inconsistent with the correct form of the other constructors.

The third constructor is fine.

Finally, here's a destructor that *doesn't* work correctly with the previous constructors:

```
String::~String()
{
    delete str; // oops, should be delete [] str;
}
```

The destructor uses `delete` incorrectly. Because the constructors request arrays of characters, the destructor should delete an array.

## Memberwise Copying for Classes with Class Members

Suppose you use the `String` class, or, for that matter, the standard `string` class as a type for class members:

```
class Magazine
{
private:
    String title;
    string publisher;
    ...
};
```

`String` and `string` both use dynamic memory allocation. Does that mean you need to write a copy constructor and assignment operator for the `Magazine` class? No—at least not in itself. The default memberwise copying and assignment behavior does have some smarts. If you copy or assign one `Magazine` object to another, memberwise copying uses the copy constructors and assignment operators defined for the member types. That is, the

String copy constructor will be used to copy the `title` member from one `Magazine` object to another, the `String` assignment operator will be used to assign the `title` member of one `Magazine` object to another, and so on. Things get more complicated, however, if the `Magazine` class needs a copy constructor and assignment operator for some other class member. In that case, those functions have to call the `String` and `string` copy constructors and assignment operators explicitly. But that's a tale for Chapter 13, "Class Inheritance."

## Observations About Returning Objects

When a member function or standalone function returns an object, you have choices. The function could return a reference to an object, a constant reference to an object, an object, or a constant object. By now, you've seen examples of all but the last, so it's a good time to review these options.

### Returning a Reference to a `const` Object

The usual reason for using a `const` reference is efficiency, but there are restrictions on when this choice can be used. If a function returns an object that is passed to it, either by object invocation or as a method argument, you can increase the efficiency of the method by having it return a reference. For example, suppose you wanted to write a function `Max()` that returned the larger of two `Vector` objects, where `Vector` is the class developed in Chapter 11. The function would be used in this manner:

```
Vector force1(50,60);
Vector force2(10,70);
Vector max;
max = Max(force1, force2);
```

Either of the following two implementations would work:

```
// version 1
Vector Max(const Vector & v1, const Vector & v2)
{
    if (v1.magval() > v2.magval())
        return v1;
    else
        return v2;
}

// version 2
const Vector & Max(const Vector & v1, const Vector & v2)
{
    if (v1.magval() > v2.magval())
        return v1;
    else
        return v2;
}
```

There are three important points here. First, recall that returning an object invokes the copy constructor, whereas returning a reference doesn't. Thus Version 2 does less work and is more efficient. Second, the reference should be to an object that exists when the calling function is executing. In this example, the reference is to either `force1` or `force2`, and both are objects defined in the calling function, so this requirement is met. Third, both `v1` and `v2` are declared as being `const` references, so the return type has to be `const` to match.

## Returning a Reference to a Non-const Object

Two common examples of returning a non-`const` object are overloading the assignment operator and overloading the `<<` operator for use with `cout`. The first is done for reasons of efficiency, and the second for reasons of necessity.

The return value of `operator=()` is used for chained assignment:

```
String s1("Good stuff");
String s2, s3;
s3 = s2 = s1;
```

In this code, the return value of `s2.operator=(s1)` is assigned to `s3`. Returning either a `String` object or a reference to a `String` object would work, but, as with the `Vector` example, using a reference allows the function to avoid calling the `String` copy constructor to create a new `String` object. In this case, the return type is not `const` because the `operator=()` method returns a reference to `s2`, which it does modify.

The return value of `operator<<()` is used for chained output:

```
String s1("Good stuff");
cout << s1 << "is coming!";
```

Here, the return value of `operator<<(cout, s1)` becomes the object used to display the string "is coming!". Here, the return type has to be `ostream &` and not just `ostream`. Using an `ostream` return type would require calling the `ostream` copy constructor, and, as it turns out, the `ostream` class does not have a public copy constructor. Fortunately, returning a reference to `cout` poses no problems because `cout` is already in scope in the calling function.

## Returning an Object

If the object being returned is local to the called function, then it should not be returned by reference because the local object has its destructor called when the function terminates. Thus, when control returns to the calling function, there is no object left to which the reference can refer. In these circumstances, you should return an object, not a reference. Typically, overloaded arithmetic operators fall into this category. Consider this example, which uses the `Vector` class again:

```
Vector force1(50,60);
Vector force2(10,70);
Vector net;
net = force1 + force2;
```

The value being returned is not `force1`, which should be left unaltered by the process, nor `force2`, which should also be unaltered. Thus the return value can't be a reference to an object that is already present in the calling function. Instead, the sum is a new, temporary object computed in `Vector::operator+()`, and the function shouldn't return a reference to a temporary object either. Instead, it should return an actual vector object, not a reference:

```
Vector Vector::operator+(const Vector & b) const
{
    return Vector(x + b.x, y + b.y);
}
```

There is the added expense of calling the copy constructor to create the returned object, but that is unavoidable.

One more observation: In the `Vector::operator+()` example, the constructor call `Vector(x + b.x, y + b.y)` creates an object that is accessible to the `operator+()` method; the implicit call to the copy constructor produced by the return statement, however, creates an object that is accessible to the calling program.

## Returning a const Object

The preceding definition of `Vector::operator+()` has a bizarre property. The intended use is this:

```
net = force1 + force2; // 1: three Vector objects
```

However, the definition also allows you to use the following:

```
force1 + force2 = net; // 2: dyslectic programming
cout << (force1 + force2 = net).magval() << endl; // 3: demented programming
```

Three questions immediately arise. Why would anyone write such statements? Why are they possible? What do they do?

First, there is no sensible reason for writing such code, but not all code is written for sensible reasons. People, even programmers, make mistakes. For instance, if the comparison `operator==( )` were defined for the `Vector` class, you might mistakenly type

```
if (force1 + force2 = net)
```

instead of this:

```
if (force1 + force2 == net)
```

Also programmers tend to be ingenious, and this can lead to ingeniously adventurous mistakes.

Second, this code is possible because the copy constructor constructs a temporary object to represent the return value. So in the preceding code, the expression `force1 + force2` stands for that temporary object. In Statement 1, the temporary object is assigned to `net`. In Statements 2 and 3, `net` is assigned to the temporary object.

Third, the temporary object is used and then discarded. For instance, in Statement 2, the program computes the sum of `force1` and `force2`, copies the answer into the temporary return object, overwrites the contents with the contents of `net`, and then discards the temporary object. The original vectors are all left unchanged. In Statement 3, the magnitude of the temporary object is displayed before the object is deleted.

If you are concerned about the potential for misuse and abuse created by this behavior, you have a simple recourse: Declare the return type as a `const` object. For instance, if `Vector::operator+()` is declared to have return type `const Vector`, then Statement 1 is still allowed but Statements 2 and 3 become invalid.

In summary, if a method or function returns a local object, it should return an object, not a reference. In this example, the program uses the copy constructor to generate the returned object. If a method or function returns an object of a class for which there is no public copy constructor, such as the `ostream` class, it must return a reference to an object. Finally, some methods and functions, such as the overloaded assignment operator, can return either an object or a reference to an object. In this example, the reference is preferred for reasons of efficiency.

## Using Pointers to Objects

C++ programs often use pointers to objects, so let's get in a bit of practice. Listing 12.6 uses array index values to keep track of the shortest string and of the first string alphabetically. Another approach is to use pointers to point to the current leaders in these categories. Listing 12.7 implements this approach, using two pointers to `String`. Initially, the `shortest` pointer points to the first object in the array. Each time the program finds an object with a shorter string, it resets `shortest` to point to that object. Similarly, a `first` pointer tracks the alphabetically earliest string. Note that these two pointers do not create new objects; they merely point to existing objects. Hence they don't require using `new` to allocate additional memory.

For variety, the program in Listing 12.7 uses a pointer that does keep track of a new object:

```
String * favorite = new String(sayings[choice]);
```

Here the pointer `favorite` provides the only access to the nameless object created by `new`. This particular syntax means to initialize the new `String` object by using the object `sayings[choice]`. That invokes the copy constructor because the argument type for the copy constructor (`const String &`) matches the initialization value (`sayings[choice]`). The program uses `srand()`, `rand()`, and `time()` to select a value for `choice` at random.

### Listing 12.7 `sayings2.cpp`

---

```
// sayings2.cpp -- using pointers to objects
// compile with string1.cpp
#include <iostream>
#include <cstdlib>      // (or stdlib.h) for rand(), srand()
#include <ctime>        // (or time.h) for time()
```



```

#include "string1.h"
const int ArSize = 10;
const int MaxLen = 81;
int main()
{
    using namespace std;
    String name;
    cout << "Hi, what's your name?\n>> ";
    cin >> name;

    cout << name << ", please enter up to " << ArSize
         << " short sayings <empty line to quit>:\n";
    String sayings[ArSize];
    char temp[MaxLen];           // temporary string storage
    int i;
    for (i = 0; i < ArSize; i++)
    {
        cout << i+1 << ": ";
        cin.get(temp, MaxLen);
        while (cin && cin.get() != '\n')
            continue;
        if (!cin || temp[0] == '\0') // empty line?
            break;                 // i not incremented
        else
            sayings[i] = temp;     // overloaded assignment
    }
    int total = i;                // total # of lines read

    if (total > 0)
    {
        cout << "Here are your sayings:\n";
        for (i = 0; i < total; i++)
            cout << sayings[i] << "\n";

        // use pointers to keep track of shortest, first strings
        String * shortest = &sayings[0]; // initialize to first object
        String * first = &sayings[0];
        for (i = 1; i < total; i++)
        {
            if (sayings[i].length() < shortest->length())
                shortest = &sayings[i];
            if (sayings[i] < *first) // compare values
                first = &sayings[i]; // assign address
        }
        cout << "Shortest saying:\n" << * shortest << endl;
        cout << "First alphabetically:\n" << * first << endl;
        srand(time(0));
    }
}

```

```

    int choice = rand() % total; // pick index at random
// use new to create, initialize new String object
    String * favorite = new String(sayings[choice]);
    cout << "My favorite saying:\n" << *favorite << endl;
    delete favorite;
}
else
    cout << "Not much to say, eh?\n";
cout << "Bye.\n";
return 0;
}

```

---

### Object Initialization with new

In general, if *Class\_name* is a class and if *value* is of type *Type\_name*, the statement

```
Class_name * pclass = new Class_name(value);
```

invokes this constructor:

```
Class_name(Type_name);
```

There may be trivial conversions, such as to this:

```
Class_name(const Type_name &);
```

Also the usual conversions invoked by prototype matching, such as from `int` to `double`, takes place as long as there is no ambiguity. An initialization in the following form invokes the default constructor:

```
Class_name * ptr = new Class_name;
```

Here's a sample run of the program in Listing 12.7:

```

Hi, what's your name?
>> Kirt Rood
Kirt Rood, please enter up to 10 short sayings <empty line to quit>:
1: a friend in need is a friend indeed
2: neither a borrower nor a lender be
3: a stitch in time saves nine
4: a niche in time saves stine
5: it takes a crook to catch a crook
6: cold hands, warm heart
7:
Here are your sayings:
a friend in need is a friend indeed
neither a borrower nor a lender be
a stitch in time saves nine
a niche in time saves stine
it takes a crook to catch a crook
cold hands, warm heart

```

```

Shortest saying:
cold hands, warm heart
First alphabetically:
a friend in need is a friend indeed
My favorite saying:
a stitch in time saves nine
Bye

```

Because the program selects the favorite saying randomly, different runs of the program will show different choices, even for identical input.

## Looking Again at `new` and `delete`

Note that the program generated from Listings 12.4, 12.5, and 12.7 uses `new` and `delete` on two levels. First, it uses `new` to allocate storage space for the name strings for each object that is created. This happens in the constructor functions, so the destructor function uses `delete` to free that memory. Because each string is an array of characters, the destructor uses `delete` with brackets. Thus, memory used to store the string contents is freed automatically when an object is destroyed. Second, the code in Listing 12.7 uses `new` to allocate an entire object:

```
String * favorite = new String(sayings[choice]);
```

This allocates space not for the string to be stored but for the object—that is, for the `str` pointer that holds the address of the string and for the `len` member. (It does not allocate space for the `num_strings` member because it is a static member that is stored separately from the objects.) Creating the object, in turn, calls the constructor, which allocates space for storing the string and assigns the string’s address to `str`. The program then uses `delete` to delete this object when it is finished with it. The object is a single object, so the program uses `delete` without brackets. Again, this frees only the space used to hold the `str` pointer and the `len` member. It doesn’t free the memory used to hold the string `str` points to, but the destructor takes care of that final task (see Figure 12.4).

Again, destructors are called in the following situations (refer to Figure 12.4):

- If an object is an automatic variable, the object’s destructor is called when the program exits the block in which the object is defined. Thus, in Listing 12.3 the destructor is called for `headlines[0]` and `headlines[1]` when the program exits `main()`, and the destructor for `grub` is called when the program exits `callme1()`.
- If an object is a static variable (external, static, static external, or from a namespace), its destructor is called when the program terminates. This is what happened for the `sports` object in Listing 12.3.
- If an object is created by `new`, its destructor is called only when you explicitly use `delete` on the object.

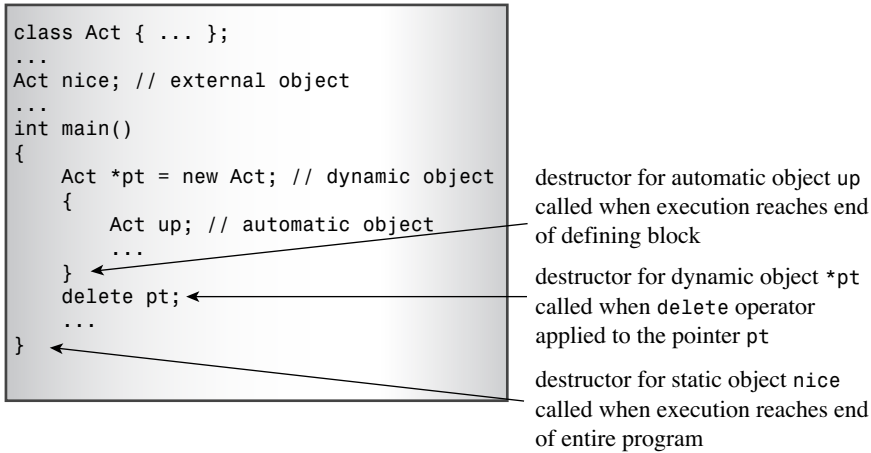

Figure 12.4 Calling destructors.

## Pointers and Objects Summary

You should note several points about using pointers to objects (refer to Figure 12.5 for a summary):

- You declare a pointer to an object by using the usual notation:
 

```
String * glamour;
```
- You can initialize a pointer to point to an existing object:
 

```
String * first = &sayings[0];
```
- You can initialize a pointer by using `new`. The following creates a new object:
 

```
String * favorite = new String(sayings[choice]);
```

Also see Figure 12.6 for a more detailed look at an example of initializing a pointer with `new`.

- Using `new` with a class invokes the appropriate class constructor to initialize the newly created object:

```
// invokes default constructor
String * gleep = new String;
```

```
// invokes the String(const char *) constructor
String * glop = new String("my my my");
```

```
// invokes the String(const String &) constructor
String * favorite = new String(sayings[choice]);
```

- You use the `->` operator to access a class method via a pointer:

```
if (sayings[i].length() < shortest->length())
```

- You apply the dereferencing operator (`*`) to a pointer to an object to obtain an object:

```
if (sayings[i] < *first)    // compare object values
    first = &sayings[i];  // assign object address
```

Declaring a pointer to a class object:

```
String * glamour;
```

Initializing a pointer to an existing object:

```
String * first = String object &sayings[0];
```

Initializing a pointer using `new` and the default class constructor:

```
String * gleep = new String;
```

Initializing a pointer using `new` and the `String(const char*)` class constructor:

```
String * glop = new String("my my my");
```

Initializing a pointer using `new` and the `String(const String &)` class constructor:

```
String * favorite = new StringString object(sayings[choice]);
```

Using the `->` operator to access a class method via a pointer:

```
if (object sayings[i].length() < pointer to object shortest->length())
```

Using the `*` dereferencing operator to obtain an object from a pointer:

```
if (object sayings[i] < pointer to object *first)
```

Figure 12.5 Pointers and objects.

```
String *pveg = new String("Cabbage Heads Home");
```

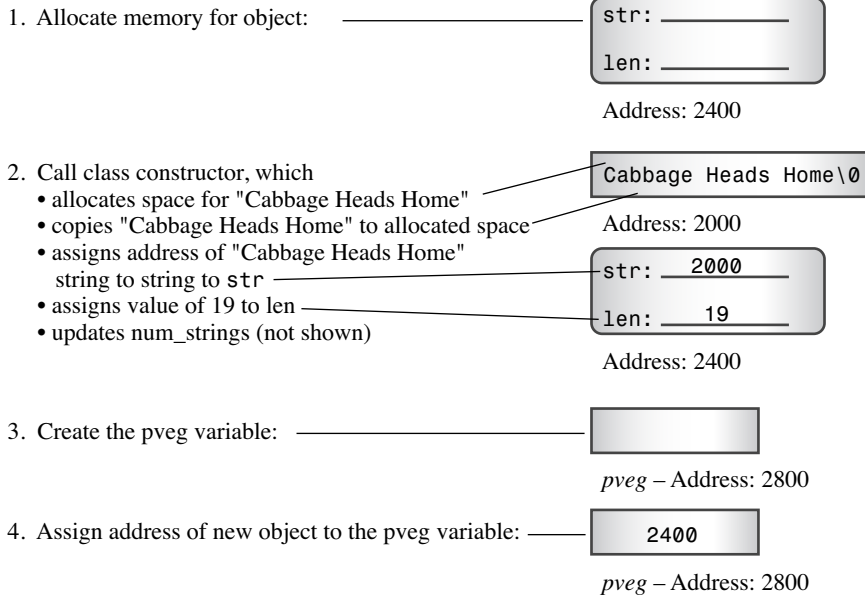

Figure 12.6 Creating an object with new.

## Looking Again at Placement new

Recall that placement new allows you to specify the memory location used to allocate memory. Chapter 9, “Memory Models and Namespaces,” discusses placement new in the context of built-in types. Using placement new with objects adds some new twists. Listing 12.8 uses placement new along with regular new to allocate memory for objects. It defines a class with a chatty constructor and destructor so that you can follow the history of objects.

### Listing 12.8 placenew1.cpp

```
// placenew1.cpp -- new, placement new, no delete
#include <iostream>
#include <string>
#include <new>
using namespace std;
const int BUF = 512;
```

```

class JustTesting
{
private:
    string words;
    int number;
public:
    JustTesting(const string & s = "Just Testing", int n = 0)
    {words = s; number = n; cout << words << " constructed\n"; }
    ~JustTesting() { cout << words << " destroyed\n";}
    void Show() const { cout << words << ", " << number << endl;}
};

int main()
{
    char * buffer = new char[BUF];          // get a block of memory

    JustTesting *pc1, *pc2;

    pc1 = new (buffer) JustTesting;        // place object in buffer
    pc2 = new JustTesting("Heap1", 20);    // place object on heap

    cout << "Memory block addresses:\n" << "buffer: "
         << (void *) buffer << "    heap: " << pc2 << endl;
    cout << "Memory contents:\n";
    cout << pc1 << ": ";
    pc1->Show();
    cout << pc2 << ": ";
    pc2->Show();

    JustTesting *pc3, *pc4;
    pc3 = new (buffer) JustTesting("Bad Idea", 6);
    pc4 = new JustTesting("Heap2", 10);

    cout << "Memory contents:\n";
    cout << pc3 << ": ";
    pc3->Show();
    cout << pc4 << ": ";
    pc4->Show();

    delete pc2;                            // free Heap1
    delete pc4;                            // free Heap2
    delete [] buffer;                      // free buffer
    cout << "Done\n";
    return 0;
}

```

---

The program in Listing 12.8 uses `new` to create a memory buffer of 512 bytes. It then uses `new` to create two objects of type `JustTesting` on the heap and attempts to use placement `new` to create two objects of type `JustTesting` in the memory buffer. Finally, it uses `delete` to free the memory allocated by `new`. Here is the output:

```
Just Testing constructed
Heap1 constructed
Memory block addresses:
buffer: 00320AB0   heap: 00320CE0
Memory contents:
00320AB0: Just Testing, 0
00320CE0: Heap1, 20
Bad Idea constructed
Heap2 constructed
Memory contents:
00320AB0: Bad Idea, 6
00320EC8: Heap2, 10
Heap1 destroyed
Heap2 destroyed
Done
```

As usual, the formatting and exact values for the memory addresses will vary from system to system.

There are a couple problems with placement `new` as used in Listing 12.8. First, when creating a second object, placement `new` simply overwrites the same location used for the first object with a new object. Not only is this rude, it means that the destructor was never called for the first object. This, of course, would create real problems if, say, the class used dynamic memory allocation for its members.

Second, using `delete` with `pc2` and `pc4` automatically invokes the destructors for the two objects that `pc2` and `pc4` point to. But using `delete []` with `buffer` does not invoke the destructors for the objects created with placement `new`.

One lesson to be learned here is the same lesson you learned in Chapter 9: It's up to you to manage the memory locations in a buffer that placement `new` populates. To use two different locations, you provide two different addresses within the buffer, making sure that the locations don't overlap. You can, for example, use this:

```
pc1 = new (buffer) JustTesting;
pc3 = new (buffer + sizeof (JustTesting)) JustTesting("Better Idea", 6);
```

Here the pointer `pc3` is offset from `pc1` by the size of a `JustTesting` object.

The second lesson to be learned here is that if you use placement `new` to store objects, you need to arrange for their destructors to be called. But how? For objects created on the heap, you can use this:

```
delete pc2; // delete object pointed to by pc2
```



But you can't use this:

```
delete pc1; // delete object pointed to by pc1? NO!
delete pc3; // delete object pointed to by pc3? NO!
```

The reason is that `delete` works in conjunction with `new` but not with placement `new`. The pointer `pc3`, for example, does not receive an address returned by `new`, so `delete pc3` throws a runtime error. The pointer `pc1`, on the other hand, has the same numeric value as `buffer`, but `buffer` is initialized using `new []`, so it's freed using `delete []`, not `delete`. Even if `buffer` were initialized by `new` instead of `new []`, `delete pc1` would free `buffer`, not `pc1`. That's because the `new/delete` system knows about the 256-byte block that is allocated, but it doesn't know anything about what placement `new` does with the block.

Note that the program does free the buffer:

```
delete [] buffer; // free buffer
```

As this comment suggests, `delete [] buffer;` deletes the entire block of memory allocated by `new`. But it doesn't call the destructors for any objects that placement `new` constructs in the block. You can tell this is so because this program uses chatty destructors, which report the demise of "Heap1" and "Heap2" but which remain silent about "Just Testing" and "Bad Idea".

The solution to this quandary is that you must call the destructor explicitly for any object created by placement `new`. Normally, destructors are called automatically; this is one of the rare cases that require an explicit call. An explicit call to a destructor requires identifying the object to be destroyed. Because there are pointers to the objects, you can use these pointers:

```
pc3->~JustTesting(); // destroy object pointed to by pc3
pc1->~JustTesting(); // destroy object pointed to by pc1
```

Listing 12.9 fixes Listing 12.8 by managing memory locations used by placement `new` and by adding appropriate uses of `delete` and of explicit destructor calls. One important fact is the proper order of deletion. The objects constructed by placement `new` should be destroyed in order opposite that in which they were constructed. The reason is that, in principle, a later object might have dependencies on an earlier object. And the buffer used to hold the objects should be freed only after all the contained objects are destroyed.

#### Listing 12.9 `placenew2.cpp`

---

```
// placenew2.cpp -- new, placement new, no delete
#include <iostream>
#include <string>
#include <new>
using namespace std;
const int BUF = 512;

class JustTesting
{
```

```
private:
    string words;
    int number;
public:
    JustTesting(const string & s = "Just Testing", int n = 0)
    {words = s; number = n; cout << words << " constructed\n"; }
    ~JustTesting() { cout << words << " destroyed\n";}
    void Show() const { cout << words << ", " << number << endl;}
};
int main()
{
    char * buffer = new char[BUF];          // get a block of memory

    JustTesting *pc1, *pc2;

    pc1 = new (buffer) JustTesting;        // place object in buffer
    pc2 = new JustTesting("Heap1", 20);    // place object on heap

    cout << "Memory block addresses:\n" << "buffer: "
         << (void *) buffer << "   heap: " << pc2 << endl;
    cout << "Memory contents:\n";
    cout << pc1 << ": ";
    pc1->Show();
    cout << pc2 << ": ";
    pc2->Show();

    JustTesting *pc3, *pc4;
// fix placement new location
    pc3 = new (buffer + sizeof (JustTesting))
           JustTesting("Better Idea", 6);
    pc4 = new JustTesting("Heap2", 10);

    cout << "Memory contents:\n";
    cout << pc3 << ": ";
    pc3->Show();
    cout << pc4 << ": ";
    pc4->Show();

    delete pc2;          // free Heap1
    delete pc4;          // free Heap2
// explicitly destroy placement new objects
    pc3->~JustTesting(); // destroy object pointed to by pc3
    pc1->~JustTesting(); // destroy object pointed to by pc1
    delete [] buffer;    // free buffer
    cout << "Done\n";
    return 0;
}
```

---

Here is the output of the program in Listing 12.9:

```

Just Testing constructed
Heap1 constructed
Memory block addresses:
buffer: 00320AB0    heap: 00320CE0
Memory contents:
00320AB0: Just Testing, 0
00320CE0: Heap1, 20
Better Idea constructed
Heap2 constructed
Memory contents:
00320AD0: Better Idea, 6
00320EC8: Heap2, 10
Heap1 destroyed
Heap2 destroyed
Better Idea destroyed
Just Testing destroyed
Done

```

The program in Listing 12.9 places the two placement new objects in adjacent location and calls the proper destructors.

## Reviewing Techniques

By now, you've encountered several programming techniques for dealing with various class-related problems, and you may be having trouble keeping track of all of them. So the following sections summarize several techniques and when they are used.

### Overloading the << Operator

To redefine the << operator so that you use it with `cout` to display an object's contents, you define a friend operator function that has the following form:

```

ostream & operator<<(ostream & os, const c_name & obj)
{
    os << ... ; // display object contents
    return os;
}

```

Here `c_name` represents the name of the class. If the class provides public methods that return the required contents, you can use those methods in the operator function and dispense with the friend status.

## Conversion Functions

To convert a single value to a class type, you create a class constructor that has the following prototype:

```
c_name(type_name value);
```

Here *c\_name* represents the class name, and *type\_name* represents the name of the type you want to convert.

To convert a class type to some other type, you create a class member function that has the following prototype:

```
operator type_name();
```

Although this function has no declared return type, it should return a value of the desired type.

Remember to use conversion functions with care. You can use the keyword `explicit` when declaring a constructor to prevent it from being used for implicit conversions.

## Classes Whose Constructors Use `new`

You need to take several precautions when designing classes that use the `new` operator to allocate memory pointed to by a class member (yes, we summarized these precautions recently, but the rules are very important to remember, particularly because the compiler does not know them and thus won't catch your mistakes):

- Any class member that points to memory allocated by `new` should have the `delete` operator applied to it in the class destructor. This frees the allocated memory.
- If a destructor frees memory by applying `delete` to a pointer that is a class member, every constructor for that class should initialize that pointer, either by using `new` or by setting the pointer to the null pointer.
- Constructors should settle on using either `new []` or `new`, but not a mixture of both. The destructor should use `delete []` if the constructors use `new []`, and it should use `delete` if the constructors use `new`.
- You should define a copy constructor that allocates new memory rather than copying a pointer to existing memory. This enables a program to initialize one class object to another. The constructor should normally have the following prototype:

```
className(const className &)
```

- You should define a class member function that overloads the assignment operator and that has a function definition with the following prototype (where *c\_pointer* is a member of the *c\_name* class and has the type `pointer-to-type_name`). The following example assumes that the constructors initialize the variable *c\_pointer* by using `new []`:

```

c_name & c_name::operator=(const c_name & cn)
{
    if (this == & cn)
        return *this;    // done if self-assignment
    delete [] c_pointer;
    // set size number of type_name units to be copied
    c_pointer = new type_name[size];
    // then copy data pointed to by cn.c_pointer to
    // location pointed to by c_pointer
    ...
    return *this;
}

```

## A Queue Simulation

Let's apply your improved understanding of classes to a programming problem. The Bank of Heather wants to open an automatic teller machine (ATM) in the Food Heap supermarket. The Food Heap management is concerned about lines at the ATM interfering with traffic flow in the market and may want to impose a limit on the number of people allowed to line up at the ATM. The Bank of Heather people want estimates of how long customers will have to wait in line. Your task is to prepare a program that simulates the situation so that management can see what the effect of the ATM might be.

A rather natural way of representing the problem is to use a queue of customers. A queue is an abstract data type (ADT) that holds an ordered sequence of items. New items are added to the rear of the queue, and items can be removed from the front. A queue is a bit like a stack, except that a stack has additions and removals at the same end. This makes a stack a LIFO (last in, first out) structure, whereas the queue is a FIFO (first in, first out) structure. Conceptually, a queue is like a line at a checkout stand or an ATM, so it's ideally suited to the task. So one part of the project is to define a `Queue` class. (In Chapter 16, you'll read about the Standard Template Library `queue` class, but you'll learn more by developing your own than by just reading about such a class.)

The items in the queue will be customers. A Bank of Heather representative tells you that, on average, a third of the customers will take one minute to be processed, a third will take two minutes, and a third will take three minutes. Furthermore, customers arrive at random intervals, but the average number of customers per hour is fairly constant. Two more parts of your project will be to design a class representing customers and to put together a program that simulates the interactions between customers and the queue (see Figure 12.7).

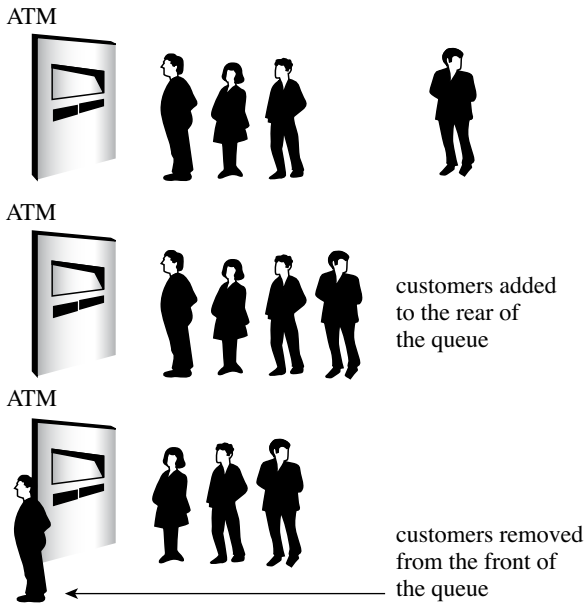

Figure 12.7 A queue.

## A Queue Class

The first order of business is to design a `Queue` class. First, you need to list the attributes of the kind of queue you'll need:

- A queue holds an ordered sequence of items.
- A queue has a limit on the number of items it can hold.
- You should be able to create an empty queue.
- You should be able to check whether a queue is empty.
- You should be able to check whether a queue is full.
- You should be able to add an item to the end of a queue.
- You should be able to remove an item from the front of a queue.
- You should be able to determine the number of items in the queue.

As usual when designing a class, you need to develop a public interface and a private implementation.

### The Queue Class Interface

The queue attributes listed in the preceding section suggest the following public interface for a queue class:

```

class Queue
{
    enum {Q_SIZE = 10};
private:
    // private representation to be developed later
public:
    Queue(int qs = Q_SIZE); // create queue with a qs limit
    ~Queue();
    bool isempty() const;
    bool isfull() const;
    int queuecount() const;
    bool enqueue(const Item &item); // add item to end
    bool dequeue(Item &item);      // remove item from front
};

```

The constructor creates an empty queue. By default, the queue can hold up to 10 items, but that can be overridden with an explicit initialization argument:

```

Queue line1;           // queue with 10-item limit
Queue line2(20);      // queue with 20-item limit

```

When using the queue, you can use a `typedef` to define `Item`. (In Chapter 14, “Reusing Code in C++,” you’ll learn how to use class templates instead.)

### The Queue Class Implementation

After you determine the interface, you can implement it. First, you have to decide how to represent the queue data. One approach is to use `new` to dynamically allocate an array with the required number of elements. However, arrays aren’t a good match to queue operations. For example, removing an item from the front of the array should be followed up by shifting every remaining element one unit closer to the front. Otherwise, you need to do something more elaborate, such as treat the array as circular. Using a linked list, however, is a reasonable fit to the requirements of a queue. A *linked list* consists of a sequence of nodes. Each *node* contains the information to be held in the list, plus a pointer to the next node in the list. For the queue in this example, each data part is a type `Item` value, and you can use a structure to represent a node:

```

struct Node
{
    Item item;           // data stored in the node
    struct Node * next; // pointer to next node
};

```

Figure 12.8 illustrates a linked list.

The example shown in Figure 12.8 is called a *singly linked list* because each node has a single link, or pointer, to another node. If you have the address of the first node, you can follow the pointers to each subsequent node in the list. Commonly, the pointer in the last node in the list is set to `NULL` (or, equivalently, to 0) to indicate that there are no further nodes. With C++11, you should use the new `nullptr` keyword. To keep track of a linked

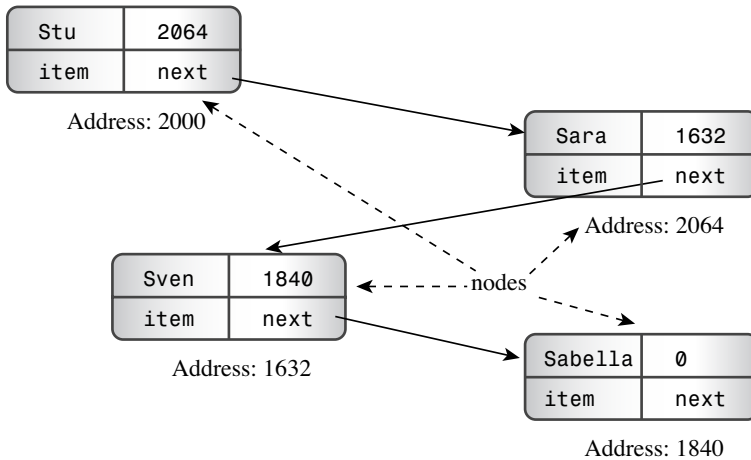

Figure 12.8 A linked list.

list, you must know the address of the first node. You can use a data member of the `Queue` class to point to the beginning of the list. In principle, that's all the information you need because you can trace down the chain of nodes to find any other node. However, because a queue always adds a new item to the end of the queue, it is convenient to have a data member point to the last node, too (see Figure 12.9). In addition, you can use data members to keep track of the maximum number of items allowed in the queue and of the current number of items. Thus, the private part of the class declaration can look like this:

```
class Queue
{
private:
// class scope definitions
    // Node is a nested structure definition local to this class
    struct Node { Item item; struct Node * next;};
    enum {Q_SIZE = 10};
// private class members
    Node * front;      // pointer to front of Queue
    Node * rear;      // pointer to rear of Queue
    int items;        // current number of items in Queue
    const int qsize;  // maximum number of items in Queue
    ...
public:
//...
};
```

The declaration uses the C++ ability to nest a structure or class declaration inside a class. By placing the `Node` declaration inside the `Queue` class, you give it class scope. That is, `Node` is a type that you can use to declare class members and as a type name in class methods, but the



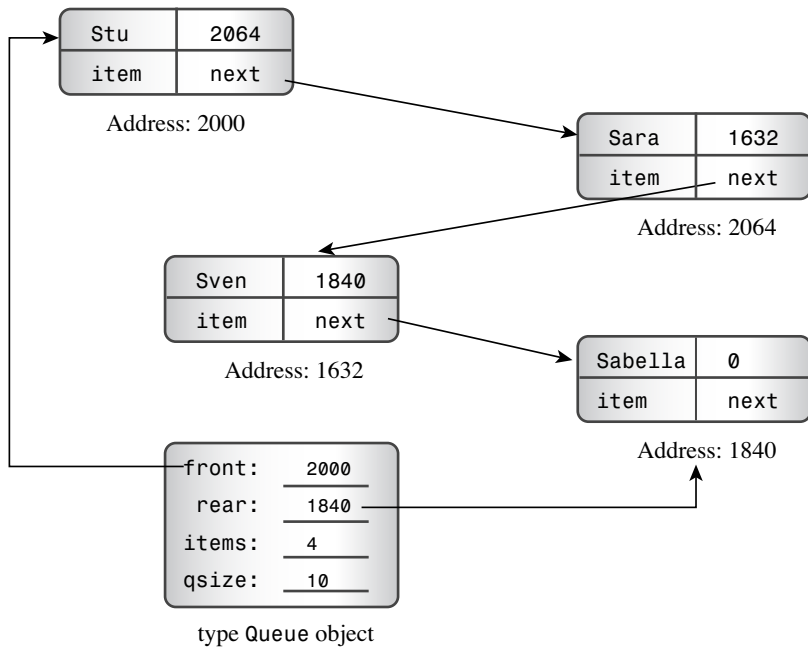

Figure 12.9 A Queue object.

type is restricted to the class. That way, you don't have to worry about this declaration of `Node` conflicting with some global declaration or with a `Node` declared inside some other class. Some obsolescent compilers do not support nested structures and classes. If yours doesn't, then you have to define a `Node` structure globally, giving it file scope.

### Nested Structures and Classes

A structure, a class, or an enumeration declared within a class declaration is said to be *nested* in the class. It has class scope. Such a declaration doesn't create a data object. Rather, it specifies a type that can be used internally within the class. If the declaration is made in the private section of the class, then the declared type can be used only within the class. If the declaration is made in the public section, then the declared type can also be used out of the class, through use of the scope-resolution operator. For example, if `Node` were declared in the public section of the `Queue` class, you could declare variables of type `Queue::Node` outside the `Queue` class.

After you settle on a data representation, the next step is to code the class methods.

### The Class Methods

A class constructor should provide values for the class members. Because the queue in this example begins in an empty state, you should set the `front` and `rear` pointers to `NULL` (or 0

or `nullptr`) and `items` to 0. Also you should set the maximum queue size `qsize` to the constructor argument `qs`. Here's an implementation that does not work:

```
Queue::Queue(int qs)
{
    front = rear = NULL;
    items = 0;
    qsize = qs;    // not acceptable!
}
```

The problem is that `qsize` is a `const`, so it can be *initialized* to a value, but it can't be *assigned* a value. Conceptually, calling a constructor creates an object before the code within the brackets is executed. Thus, calling the `Queue(int qs)` constructor causes the program to first allocate space for the four member variables. Then program flow enters the brackets and uses ordinary assignment to place values into the allocated space. Therefore, if you want to initialize a `const` data member, you have to do so when the object is created before execution reaches the body of the constructor. C++ provides a special syntax for doing just that. It's called a *member initializer list*. The member initializer list consists of a comma-separated list of initializers preceded by a colon. It's placed after the closing parenthesis of the argument list and before the opening bracket of the function body. If a data member is named `mdata` and if it's to be initialized to the value `val`, the initializer has the form `mdata(val)`. Using this notation, you can write the `Queue` constructor like this:

```
Queue::Queue(int qs) : qsize(qs)    // initialize qsize to qs
{
    front = rear = NULL;
    items = 0;
}
```

In general, the initial value can involve constants and arguments from the constructor's argument list. The technique is not limited to initializing constants; you can also write the `Queue` constructor like this:

```
Queue::Queue(int qs) : qsize(qs), front(NULL), rear(NULL), items(0)
{
}
```

Only constructors can use this initializer-list syntax. As you've seen, you have to use this syntax for `const` class members. You also have to use it for class members that are declared as references:

```
class Agency {...};
class Agent
{
private:
    Agency & belong;    // must use initializer list to initialize
    ...
};
Agent::Agent(Agency & a) : belong(a) {...}
```

That's because references, like `const` data, can be initialized only when created. For simple data members, such as `front` and `items`, it doesn't make much difference whether you use a member initializer list or use assignment in the function body. As you'll see in Chapter 14, however, it's more efficient to use the member initializer list for members that are themselves class objects.

### The Member Initializer List Syntax

If `Classy` is a class and if `mem1`, `mem2`, and `mem3` are class data members, a class constructor can use the following syntax to initialize the data members:

```
Classy::Classy(int n, int m) :mem1(n), mem2(0), mem3(n*m + 2)
{
//...
}
```

This initializes `mem1` to `n`, `mem2` to `0`, and `mem3` to `n*m + 2`. Conceptually, these initializations take place when the object is created and before any code within the brackets is executed. Note the following:

- This form can be used only with constructors.
- You must (at least, in pre-C++11) use this form to initialize a nonstatic `const` data member.
- You must use this form to initialize a reference data member.

Data members are initialized in the order in which they appear in the class declaration, not in the order in which initializers are listed.

### Caution

You can't use the member initializer list syntax with class methods other than constructors.

The parenthesized form used in the member initializer list can be used in ordinary initializations, too. That is, if you like, you can replace code such as

```
int games = 162;
double talk = 2.71828;
```

with

```
int games(162);
double talk(2.71828);
```

This allows initializing built-in types to look like initializing class objects.

### C++11 Member In-Class Initialization

C++11 allows you to do what would seem to be the intuitively obvious thing to do:

```
class Classy
{
    int mem1 = 10;           // in-class initialization
    const int mem2 = 20;    // in-class initialization
```

```
//...
};
```

This is equivalent to using a member initialization list in the constructors:

```
Classy::Classy() : mem1(10), mem2(20) {...}
```

The members `mem1` and `mem2` get initialized to 10 and 20, respectively, unless a constructor using a member initialization list is called. Then the actual list overrides these default initializations:

```
Classy::Classy(int n) : mem1(n) {...}
```

In this case, the constructor would use the value of `n` to initialize `mem1`, and `mem2` still would be set to 20.

The code for `isempty()`, `isfull()`, and `queuecount()` is simple. If `items` is 0, the queue is empty. If `items` is `qsize`, the queue is full. Returning the value of `items` answers the question of how many items are in the queue. You'll see the code later this chapter in Listing 12.11.

Adding an item to the rear of the queue (enqueueing) is more involved. Here is one approach:

```
bool Queue::enqueue(const Item & item)
{
    if (isfull())
        return false;
    Node * add = new Node; // create node
// on failure, new throws std::bad_alloc exception
    add->item = item;      // set node pointers
    add->next = NULL;      // or nullptr;
    items++;
    if (front == NULL)    // if queue is empty,
        front = add;     // place item at front
    else
        rear->next = add; // else place at rear
    rear = add;          // have rear point to new node
    return true;
}
```

In brief, the method goes through the following phases (see Figure 12.10):

1. Terminate if the queue is already full. (For this implementation, the maximum size is selected by the user via the constructor.)
2. Create a new node. If `new` can't do so, it throws an exception, which is a topic taken up in Chapter 15, "Friends, Exceptions, and More." The practical upshot is that unless one provides additional programming to handle the exception, the program terminates.

3. Place proper values into the node. In this case, the code copies an `Item` value into the data part of the node and sets the node's next pointer to `NULL` (or `0` or, in C++11, `nullptr`). This prepares the node to be the last item in the queue.
4. Increase the item count (`items`) by one.
5. Attach the node to the rear of the queue. There are two parts to this process. The first is linking the node to the other nodes in the list. This is done by having the next pointer of the currently rear node point to the new rear node. The second part is to set the `Queue` member pointer `rear` to point to the new node so that the queue can access the last node directly. If the queue is empty, you must also set the `front` pointer to point to the new node. (If there's just one node, it's both the front and the rear node.)

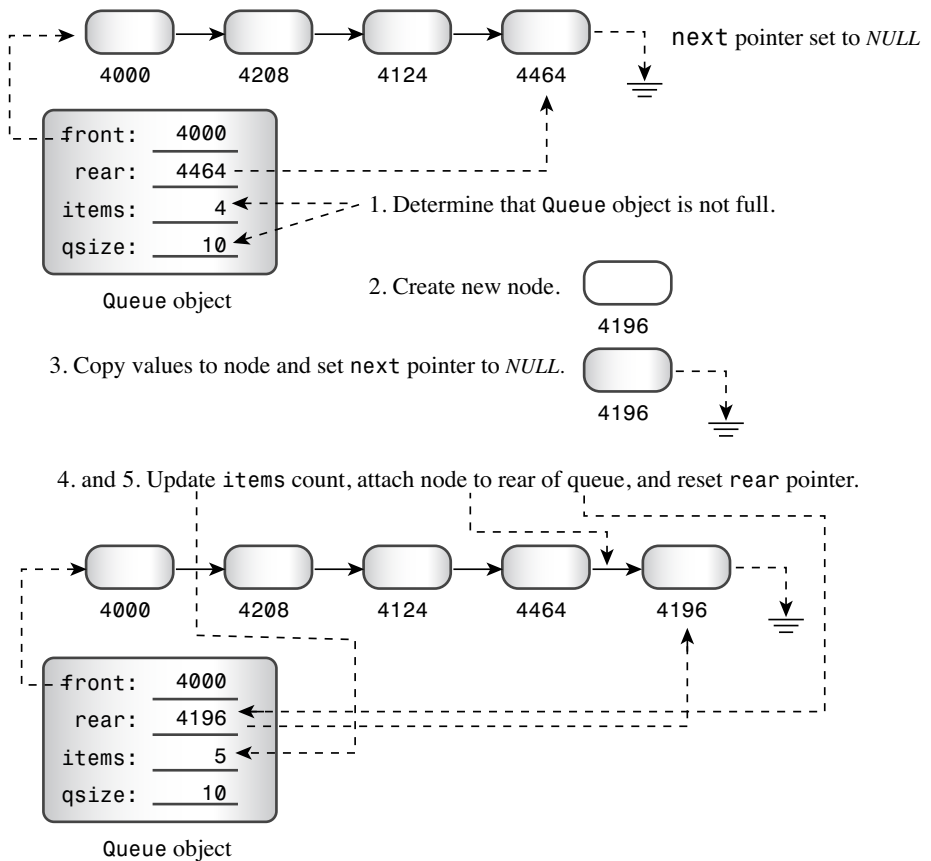

Figure 12.10 Enqueueing an item.

Removing an item from the front of the queue (dequeuing) also has several steps. Here is one approach:

```
bool Queue::dequeue(Item & item)
{
    if (front == NULL)
        return false;
    item = front->item;    // set item to first item in queue
    items--;
    Node * temp = front;  // save location of first item
    front = front->next;  // reset front to next item
    delete temp;         // delete former first item
    if (items == 0)
        rear = NULL;
    return true;
}
```

In brief, the method goes through the following phases (see Figure 12.11):

1. Terminate if the queue is already empty.
2. Provide the first item in the queue to the calling function. This is accomplished by copying the data portion of the current `front` node into the reference variable passed to the method.
3. Decrease the item count (`items`) by one.
4. Save the location of the front node for later deletion.
5. Take the node off the queue. This is accomplished by setting the `Queue` member pointer `front` to point to the next node, whose address is provided by `front->next`.
6. To conserve memory, delete the former first node.
7. If the list is now empty, set `rear` to `NULL`. (The front pointer would already be `NULL` in this case, after setting `front->next`.) Again, you can use `0` instead of `NULL`, or, with C++11, you can use `nullptr`.

Step 4 is necessary because step 5 erases the queue's memory of where the former first node is.

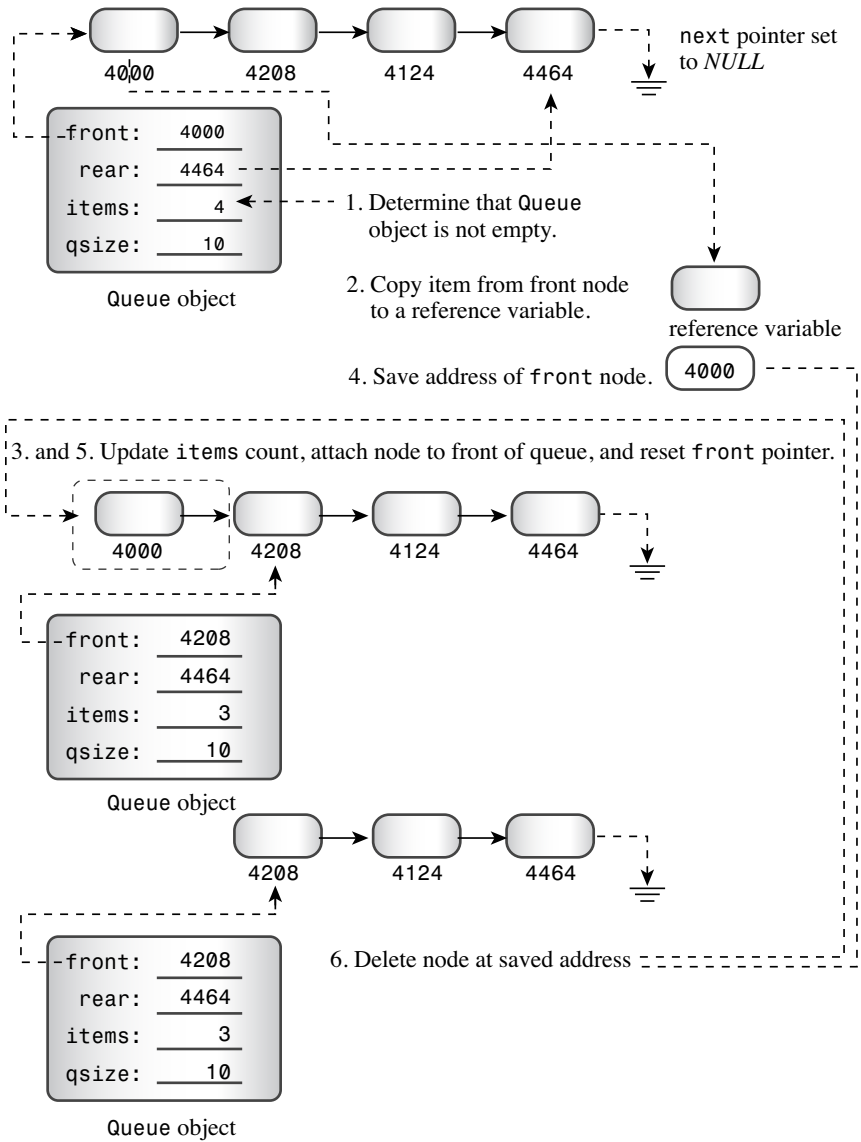

Figure 12.11 Dequeuing an item.

## Other Class Methods?

Do you need any more methods? The class constructor doesn't use `new`, so at first glance, it may appear that you don't have to worry about the special requirements of classes that do use `new` in the constructors. Of course, that first glance is misleading because adding objects to a queue does invoke `new` to create new nodes. It's true that the `dequeue()` method cleans up by deleting nodes, but there's no guarantee that a queue will be empty when it expires. Therefore, the class does require an explicit destructor—one that deletes all remaining nodes. Here's an implementation that starts at the front of the list and deletes each node in turn:

```
Queue::~Queue()
{
    Node * temp;
    while (front != NULL)    // while queue is not yet empty
    {
        temp = front;        // save address of front item
        front = front->next; // reset pointer to next item
        delete temp;        // delete former front
    }
}
```

Hmmm. You've seen that classes that use `new` usually require explicit copy constructors and assignment operators that do deep copying. Is that the case here? The first question to answer is, "Does the default memberwise copying do the right thing?" The answer is no. Memberwise copying of a `Queue` object would produce a new object that points to the front and rear of the same linked list as the original. Thus, adding an item to the copy `Queue` object changes the shared linked list. That's bad enough. What's worse is that only the copy's rear pointer gets updated, essentially corrupting the list from the standpoint of the original object. Clearly, then, cloning or copying queues requires providing a copy constructor and an assignment constructor that do deep copying.

Of course, that raises the question of why you would want to copy a queue. Well, perhaps you would want to save snapshots of a queue during different stages of a simulation. Or you would like to provide identical input to two different strategies. Actually, it might be useful to have operations that split a queue, the way supermarkets sometimes do when opening an additional checkout stand. Similarly, you might want to combine two queues into one or truncate a queue.

But suppose you don't want to do any of these things in this simulation. Can't you simply ignore those concerns and use the methods you already have? Of course you can. However, at some time in the future, you might need to use a queue again, but with copying. And you might forget that you failed to provide proper code for copying. In that case, your programs will compile and run, but they will generate puzzling results and crashes. So it would seem that it's best to provide a copy constructor and an assignment operator, even though you don't need them now.



Fortunately, there is a sneaky way to avoid doing this extra work while still protecting against future program crashes. The idea is to define the required methods as dummy private methods:

```
class Queue
{
private:
    Queue(const Queue & q) : qsize(0) { } // preemptive definition
    Queue & operator=(const Queue & q) { return *this; }
//...
};
```

This has two effects. First, it overrides the default method definitions that otherwise would be generated automatically. Second, because these methods are private, they can't be used by the world at large. That is, if `nip` and `tuck` are `Queue` objects, the compiler won't allow the following:

```
Queue snick(nip); // not allowed
tuck = nip; // not allowed
```

Therefore, instead of being faced with mysterious runtime malfunctions in the future, you'll get an easier-to-trace compiler error, stating that these methods aren't accessible. Also this trick is useful when you define a class whose objects really should not be copied.

C++11 provides an alternative way to disable a method by using the keyword `delete`; Chapter 18 returns to this topic.

Are there any other effects to note? Yes. Recall that a copy constructor is invoked when objects are passed (or returned) by value. However, this is no problem if you follow the preferred practice of passing objects as references. Also a copy constructor is used to create other temporary objects. But the `Queue` definition lacks operations that lead to temporary objects, such as overloading the addition operator.

## The Customer Class

At this point, we need to design a customer class. In general, an ATM customer has many properties, such as a name, account numbers, and account balances. However, the only properties you need for the simulation are when a customer joins the queue and the time required for the customer's transaction. When the simulation produces a new customer, the program should create a new customer object, storing in it the customer's time of arrival and a randomly generated value for the transaction time. When the customer reaches the front of the queue, the program should note the time and subtract the queue-joining time to get the customer's waiting time. Here's how you can define and implement the `Customer` class:

```
class Customer
{
private:
    long arrive; // arrival time for customer
    int processtime; // processing time for customer
```

```

public:
    Customer() { arrive = processtime = 0; }
    void set(long when);
    long when() const { return arrive; }
    int ptime() const { return processtime; }
};
void Customer::set(long when)
{
    processtime = std::rand() % 3 + 1;
    arrive = when;
}

```

The default constructor creates a null customer. The `set()` member function sets the arrival time to its argument and randomly picks a value from 1 through 3 for the processing time.

Listing 12.10 gathers together the `Queue` and `Customer` class declarations, and Listing 12.11 provides the methods.

#### Listing 12.10 `queue.h`

---

```

// queue.h -- interface for a queue
#ifndef QUEUE_H_
#define QUEUE_H_
// This queue will contain Customer items
class Customer
{
private:
    long arrive;          // arrival time for customer
    int processtime;     // processing time for customer
public:
    Customer() { arrive = processtime = 0; }
    void set(long when);
    long when() const { return arrive; }
    int ptime() const { return processtime; }
};

typedef Customer Item;

class Queue
{
private:
// class scope definitions
    // Node is a nested structure definition local to this class
    struct Node { Item item; struct Node * next; };
    enum { Q_SIZE = 10 };
// private class members
    Node * front;        // pointer to front of Queue

```

```

    Node * rear;          // pointer to rear of Queue
    int items;           // current number of items in Queue
    const int qsize;     // maximum number of items in Queue
    // preemptive definitions to prevent public copying
    Queue(const Queue & q) : qsize(0) { }
    Queue & operator=(const Queue & q) { return *this;}
public:
    Queue(int qs = Q_SIZE); // create queue with a qs limit
    ~Queue();
    bool isempty() const;
    bool isfull() const;
    int queuecount() const;
    bool enqueue(const Item &item); // add item to end
    bool dequeue(Item &item);      // remove item from front
};
#endif

```

---

#### Listing 12.11 `queue.cpp`

---

```

// queue.cpp -- Queue and Customer methods
#include "queue.h"
#include <cstdlib>          // (or stdlib.h) for rand()

// Queue methods
Queue::Queue(int qs) : qsize(qs)
{
    front = rear = NULL;   // or nullptr
    items = 0;
}

Queue::~Queue()
{
    Node * temp;
    while (front != NULL) // while queue is not yet empty
    {
        temp = front;     // save address of front item
        front = front->next; // reset pointer to next item
        delete temp;      // delete former front
    }
}

bool Queue::isempty() const
{
    return items == 0;
}

```

```
bool Queue::isfull() const
{
    return items == qsize;
}

int Queue::queuecount() const
{
    return items;
}

// Add item to queue
bool Queue::enqueue(const Item & item)
{
    if (isfull())
        return false;
    Node * add = new Node; // create node
// on failure, new throws std::bad_alloc exception
    add->item = item;      // set node pointers
    add->next = NULL;     // or nullptr;
    items++;
    if (front == NULL)   // if queue is empty,
        front = add;    // place item at front
    else
        rear->next = add; // else place at rear
    rear = add;         // have rear point to new node
    return true;
}

// Place front item into item variable and remove from queue
bool Queue::dequeue(Item & item)
{
    if (front == NULL)
        return false;
    item = front->item; // set item to first item in queue
    items--;
    Node * temp = front; // save location of first item
    front = front->next; // reset front to next item
    delete temp;        // delete former first item
    if (items == 0)
        rear = NULL;
    return true;
}

// customer method

// when is the time at which the customer arrives
// the arrival time is set to when and the processing
```

```
// time set to a random value in the range 1 - 3
void Customer::set(long when)
{
    processtime = std::rand() % 3 + 1;
    arrive = when;
}
```

---

## The ATM Simulation

You now have the tools needed for the ATM simulation. The program should allow the user to enter three quantities: the maximum queue size, the number of hours the program will simulate, and the average number of customers per hour. The program should use a loop in which each cycle represents one minute. During each minute cycle, the program should do the following:

1. Determine whether a new customer has arrived. If so, add the customer to the queue if there is room; otherwise, turn the customer away.
2. If no one is being processed, take the first person from the queue. Determine how long the person has been waiting and set a `wait_time` counter to the processing time that the new customer will need.
3. If a customer is being processed, decrement the `wait_time` counter by one minute.
4. Track various quantities, such as the number of customers served, the number of customers turned away, cumulative time spent waiting in line, and cumulative queue length.

When the simulation cycle is finished, the program should report various statistical findings.

An interesting matter is how the program determines whether a new customer has arrived. Suppose that on average, 10 customers arrive per hour. That amounts to a customer every 6 minutes. The program computes and stores that value in the variable `min_per_cust`. However, having a customer show up exactly every 6 minutes is unrealistic. What you really want (at least most of the time) is a more random process that averages to a customer every 6 minutes. The program uses this function to determine whether a customer shows up during a cycle:

```
bool newcustomer(double x)
{
    return (std::rand() * x / RAND_MAX < 1);
}
```

Here's how it works. The value `RAND_MAX` is defined in the `cstdlib` file (formerly `stdlib.h`) and represents the largest value the `rand()` function can return (0 is the lowest value). Suppose that `x`, the average time between customers, is 6. Then the value of `rand() * x / RAND_MAX` will be somewhere between 0 and 6. In particular, it will be less than

1 one-sixth of the time, on average. However, it's possible that this function might yield two customers spaced 1 minute apart one time and two customers 20 minutes apart another time. This behavior leads to the clumpiness that often distinguishes real processes from the clocklike regularity of exactly one customer every 6 minutes. This particular method breaks down if the average time between arrivals drops below 1 minute, but the simulation is not intended to handle that scenario. If you did need to deal with such a case, you'd use a finer time resolution, perhaps letting each cycle represent 10 seconds.

Listing 12.12 presents the details of the simulation. Running the simulation for a long time period provides insight into long-term averages, and running it for short times provides insight into short-term variations.

#### Listing 12.12 `bank.cpp`

---

```
// bank.cpp -- using the Queue interface
// compile with queue.cpp
#include <iostream>
#include <cstdlib> // for rand() and srand()
#include <ctime>   // for time()
#include "queue.h"
const int MIN_PER_HR = 60;

bool newcustomer(double x); // is there a new customer?

int main()
{
    using std::cin;
    using std::cout;
    using std::endl;
    using std::ios_base;
// setting things up
    std::srand(std::time(0)); // random initializing of rand()

    cout << "Case Study: Bank of Heather Automatic Teller\n";
    cout << "Enter maximum size of queue: ";
    int qs;
    cin >> qs;
    Queue line(qs); // line queue holds up to qs people

    cout << "Enter the number of simulation hours: ";
    int hours; // hours of simulation
    cin >> hours;
    // simulation will run 1 cycle per minute
    long cyclelimit = MIN_PER_HR * hours; // # of cycles

    cout << "Enter the average number of customers per hour: ";
    double perhour; // average # of arrival per hour
```

```

cin >> perhour;
double min_per_cust; // average time between arrivals
min_per_cust = MIN_PER_HR / perhour;

Item temp; // new customer data
long turnaways = 0; // turned away by full queue
long customers = 0; // joined the queue
long served = 0; // served during the simulation
long sum_line = 0; // cumulative line length
int wait_time = 0; // time until autoteller is free
long line_wait = 0; // cumulative time in line

// running the simulation
for (int cycle = 0; cycle < cyclelimit; cycle++)
{
    if (newcustomer(min_per_cust)) // have newcomer
    {
        if (line.isfull())
            turnaways++;
        else
        {
            customers++;
            temp.set(cycle); // cycle = time of arrival
            line.enqueue(temp); // add newcomer to line
        }
    }
    if (wait_time <= 0 && !line.isempty())
    {
        line.dequeue (temp); // attend next customer
        wait_time = temp.ptime(); // for wait_time minutes
        line_wait += cycle - temp.when();
        served++;
    }
    if (wait_time > 0)
        wait_time--;
    sum_line += line.queuecount();
}

// reporting results
if (customers > 0)
{
    cout << "customers accepted: " << customers << endl;
    cout << " customers served: " << served << endl;
    cout << "          turnaways: " << turnaways << endl;
    cout << "average queue size: ";
    cout.precision(2);
    cout.setf(ios_base::fixed, ios_base::floatfield);
}

```

```

        cout << (double) sum_line / cyclelimit << endl;
        cout << " average wait time: "
            << (double) line_wait / served << " minutes\n";
    }
    else
        cout << "No customers!\n";
    cout << "Done!\n";

    return 0;
}

// x = average time, in minutes, between customers
// return value is true if customer shows up this minute
bool newcustomer(double x)
{
    return (std::rand() * x / RAND_MAX < 1);
}

```

---

## Note

You might have a compiler that has not implemented `bool`. In that case, you can use `int` instead of `bool`, `0` instead of `false`, and `1` instead of `true`. You might also have to use `stdlib.h` and `time.h` instead of the newer `cstdlib` and `ctime`. You might have to define `RAND_MAX` yourself.

Here are a few sample runs of the program built from Listings 12.10, 12.11, and 12.12:

```

Case Study: Bank of Heather Automatic Teller
Enter maximum size of queue: 10
Enter the number of simulation hours: 100
Enter the average number of customers per hour: 15
customers accepted: 1485
    customers served: 1485
        turnaways: 0
average queue size: 0.15
    average wait time: 0.63 minutes
Done!

```

```

Case Study: Bank of Heather Automatic Teller
Enter maximum size of queue: 10
Enter the number of simulation hours: 100
Enter the average number of customers per hour: 30
customers accepted: 2896
    customers served: 2888
        turnaways: 101
average queue size: 4.64
    average wait time: 9.63 minutes
Done!

```



```
Case Study: Bank of Heather Automatic Teller
Enter maximum size of queue: 20
Enter the number of simulation hours: 100
Enter the average number of customers per hour: 30
customers accepted: 2943
    customers served: 2943
        turnaways: 93
average queue size: 13.06
    average wait time: 26.63 minutes
Done!
```

Note that going from 15 customers per hour to 30 customers per hour doesn't double the average wait time; it increases it by about a factor of 15. Allowing a longer queue just makes matters worse. However, the simulation doesn't allow for the fact that many customers, frustrated with a long wait, would simply leave the queue.

Here are a few more sample runs of the program in Listing 12.12; they illustrate the short-term variations you might see, even though the average number of customers per hour is kept constant:

```
Case Study: Bank of Heather Automatic Teller
Enter maximum size of queue: 10
Enter the number of simulation hours: 4
Enter the average number of customers per hour: 30
customers accepted: 114
    customers served: 110
        turnaways: 0
average queue size: 2.15
    average wait time: 4.52 minutes
Done!
```

```
Case Study: Bank of Heather Automatic Teller
Enter maximum size of queue: 10
Enter the number of simulation hours: 4
Enter the average number of customers per hour: 30
customers accepted: 121
    customers served: 116
        turnaways: 5
average queue size: 5.28
    average wait time: 10.72 minutes
Done!
```

```
Case Study: Bank of Heather Automatic Teller
Enter maximum size of queue: 10
Enter the number of simulation hours: 4
Enter the average number of customers per hour: 30
customers accepted: 112
    customers served: 109
```

```
turnaways: 0
average queue size: 2.41
average wait time: 5.16 minutes
Done!
```

## Summary

This chapter covers many important aspects of defining and using classes. Several of these aspects are subtle—even difficult—concepts. If some of them seem obscure or unusually complex to you, don't feel bad; they affect most newcomers to C++ that way. Often the way you come to really appreciate concepts such as copy constructors is through getting into trouble by ignoring them. So some of the material in this chapter may seem vague to you until your own experiences enrich your understanding.

You can use `new` in a class constructor to allocate memory for data and then assign the address of the memory to a class member. This enables a class, for example, to handle strings of various sizes without committing the class design in advance to a fixed array size. Using `new` in class constructors also raises potential problems when an object expires. If an object has member pointers pointing to memory allocated by `new`, freeing the memory used to hold the object does not automatically free the memory pointed to by the object member pointers. Therefore, if you use `new` in a class constructor to allocate memory, you should use `delete` in the class destructor to free that memory. That way, the demise of an object automatically triggers the deletion of pointed-to memory.

Objects that have members pointing to memory allocated by `new` also have problems with initializing one object to another or assigning one object to another. By default, C++ uses memberwise initialization and assignment, which means that the initialized or the assigned-to object winds up with exact copies of the original object's members. If an original member points to a block of data, the copy member points to the same block. When the program eventually deletes the two objects, the class destructor attempts to delete the same block of memory twice, which is an error. The solution is to define a special copy constructor that redefines initialization and to overload the assignment operator. In each case, the new definition should create duplicates of any pointed-to data and have the new object point to the copies. That way, both the old and the new objects refer to separate but identical data, with no overlap. The same reasoning applies to defining an assignment operator. In each case, the goal is to make a deep copy—that is, to copy the real data and not just pointers to the data.

When an object has automatic storage or external storage, the destructor for that object is called automatically when the object ceases to exist. If you allocate storage for an object by using `new` and assign its address to a pointer, the destructor for that object is called automatically when you apply `delete` to the pointer. However, if you allocate storage for class objects by using placement `new` instead of regular `new`, you also take on the responsibility of calling the destructor for that object explicitly by invoking the destructor method with a pointer to the object. C++ allows you to place structure, class, and enumeration definitions inside a class. Such nested types have class scope, meaning that they

are local to the class and don't conflict with structures, classes, and enumerations of the same name that are defined elsewhere.

C++ provides a special syntax for class constructors that can be used to initialize data members. This syntax consists of a colon followed by a comma-separated list of initializers. This is placed after the closing parenthesis of the constructor arguments and before the opening brace of the function body. Each initializer consists of the name of the member being initialized followed by parentheses containing the initialization value. Conceptually, these initializations take place when the object is created and before any statements in the function body are executed. The syntax looks like this:

```
queue(int qs) : qsize(qs), items(0), front(NULL), rear(NULL) { }
```

This form is obligatory if the data member is a nonstatic `const` member or a reference, except that C++11 in-class initialization can be used for nonstatic `const` members.

C++11 allows in-class initialization (that is, initialization in the class definition):

```
class Queue
{
private:
...
    Node * front = NULL;
    enum {Q_SIZE = 10};
    Node * rear = NULL;
    int items = 0;
    const int qsize = Q_SIZE;
...
};
```

This is equivalent to using a member initialization list. However, any constructor using a membership initialization list will override the corresponding in-class initializations.

As you might have noticed, classes require much more care and attention to detail than do simple C-style structures. In return, they do much more for you.

## Chapter Review

1. Suppose a `String` class has the following private members:

```
class String
{
private:
    char * str;    // points to string allocated by new
    int len;      // holds length of string
    //...
};
```

- a. What's wrong with this default constructor?

```
String::String() {}
```

- b. What's wrong with this constructor?

```
String::String(const char * s)
{
    str = s;
    len = strlen(s);
}
```

- c. What's wrong with this constructor?

```
String::String(const char * s)
{
    strcpy(str, s);
    len = strlen(s);
}
```

- Name three problems that may arise if you define a class in which a pointer member is initialized by using `new`. Indicate how they can be remedied.
- What class methods does the compiler generate automatically if you don't provide them explicitly? Describe how these implicitly generated functions behave.
- Identify and correct the errors in the following class declaration:

```
class nifty
{
    // data
    char personality[];
    int talents;
    // methods
    nifty();
    nifty(char * s);
    ostream & operator<<(ostream & os, nifty & n);
}
```

```
nifty:nifty()
{
    personality = NULL;
    talents = 0;
}
```

```
nifty:nifty(char * s)
{
    personality = new char [strlen(s)];
    personality = s;
    talents = 0;
}
```

```
ostream & nifty::operator<<(ostream & os, nifty & n)
{
    os << n;
}
```

5. Consider the following class declaration:

```
class Golfer
{
private:
    char * fullname;           // points to string containing golfer's name
    int games;                // holds number of golf games played
    int * scores;             // points to first element of array of golf scores
public:
    Golfer();
    Golfer(const char * name, int g= 0);
    // creates empty dynamic array of g elements if g > 0
    Golfer(const Golfer & g);
    ~Golfer();
};
```

- a. What class methods would be invoked by each of the following statements?

```
Golfer nancy;                // #1
Golfer lulu("Little Lulu");  // #2
Golfer roy("Roy Hobbs", 12); // #3
Golfer * par = new Golfer;   // #4
Golfer next = lulu;         // #5
Golfer hazzard = "Weed Thwacker"; // #6
*par = nancy;               // #7
nancy = "Nancy Putter";     // #8
```

- b. Clearly, the class requires several more methods to make it useful. What additional method does it require to protect against data corruption?

## Programming Exercises

1. Consider the following class declaration:

```
class Cow {
    char name[20];
    char * hobby;
    double weight;
public:
    Cow();
    Cow(const char * nm, const char * ho, double wt);
    Cow(const Cow c&);
```

```

    ~Cow();
    Cow & operator=(const Cow & c);
    void ShowCow() const; // display all cow data
};

```

Provide the implementation for this class and write a short program that uses all the member functions.

2. Enhance the `String` class declaration (that is, upgrade `string1.h` to `string2.h`) by doing the following:
  - a. Overload the `+` operator to allow you to join two strings into one.
  - b. Provide a `stringlow()` member function that converts all alphabetic characters in a string to lowercase. (Don't forget the `cctype` family of character functions.)
  - c. Provide a `stringup()` member function that converts all alphabetic characters in a string to uppercase.
  - d. Provide a member function that takes a `char` argument and returns the number of times the character appears in the string.

Test your work in the following program:

```

// pe12_2.cpp
#include <iostream>
using namespace std;
#include "string2.h"
int main()
{
    String s1(" and I am a C++ student.");
    String s2 = "Please enter your name: ";
    String s3;
    cout << s2; // overloaded << operator
    cin >> s3; // overloaded >> operator
    s2 = "My name is " + s3; // overloaded =, + operators
    cout << s2 << ".\n";
    s2 = s2 + s1;
    s2.stringup(); // converts string to uppercase
    cout << "The string\n" << s2 << "\ncontains " << s2.has('A')
        << " 'A' characters in it.\n";
    s1 = "red"; // String(const char *),
               // then String & operator=(const String&)
    String rgb[3] = { String(s1), String("green"), String("blue") };
    cout << "Enter the name of a primary color for mixing light: ";
    String ans;
    bool success = false;
    while (cin >> ans)

```

```

    {
        ans.stringlow();          // converts string to lowercase
        for (int i = 0; i < 3; i++)
        {
            if (ans == rgb[i]) // overloaded == operator
            {
                cout << "That's right!\n";
                success = true;
                break;
            }
        }
        if (success)
            break;
        else
            cout << "Try again!\n";
    }
    cout << "Bye\n";
    return 0;
}

```

Your output should look like this sample run:

```

Please enter your name: Fretta Farbo
My name is Fretta Farbo.
The string
MY NAME IS FRETТА FARBO AND I AM A C++ STUDENT.
contains 6 'A' characters in it.
Enter the name of a primary color for mixing light: yellow
Try again!
BLUE
That's right!
Bye

```

3. Rewrite the `Stack` class, as described in Listings 10.7 and 10.8 in Chapter 10 so that it uses dynamically allocated memory directly instead of using `string` class objects to hold the stock names. Also replace the `show()` member function with an overloaded `operator<<()` definition. Test the new definition program in Listing 10.9.
4. Consider the following variation of the `Stack` class defined in Listing 10.10:

```

// stack.h -- class declaration for the stack ADT
typedef unsigned long Item;

class Stack
{

```

```
private:
    enum {MAX = 10};           // constant specific to class
    Item * pitems;           // holds stack items
    int size;                 // number of elements in stack
    int top;                  // index for top stack item
public:
    Stack(int n = MAX);       // creates stack with n elements
    Stack(const Stack & st);
    ~Stack();
    bool isempty() const;
    bool isfull() const;
    // push() returns false if stack already is full, true otherwise
    bool push(const Item & item); // add item to stack
    // pop() returns false if stack already is empty, true otherwise
    bool pop(Item & item); // pop top into item
    Stack & operator=(const Stack & st);
};
```

As the private members suggest, this class uses a dynamically allocated array to hold the stack items. Rewrite the methods to fit this new representation and write a program that demonstrates all the methods, including the copy constructor and assignment operator.

5. The Bank of Heather has performed a study showing that ATM customers won't wait more than one minute in line. Using the simulation from Listing 12.10, find a value for number of customers per hour that leads to an average wait time of one minute. (Use at least a 100-hour trial period.)
6. The Bank of Heather would like to know what would happen if it added a second ATM. Modify the simulation in this chapter so that it has two queues. Assume that a customer will join the first queue if it has fewer people in it than the second queue and that the customer will join the second queue otherwise. Again, find a value for number of customers per hour that leads to an average wait time of one minute. (Note: This is a nonlinear problem in that doubling the number of ATMs doesn't double the number of customers who can be handled per hour with a one-minute wait maximum.)



*This page intentionally left blank*

# Class Inheritance

In this chapter you'll learn about the following:

- Inheritance as an *is-a* relationship
- How to publicly derive one class from another
- Protected access
- Constructor member initializer lists
- Upcasting and downcasting
- Virtual member functions
- Early (static) binding and late (dynamic) binding
- Abstract base classes
- Pure virtual functions
- When and how to use public inheritance

One of the main goals of object-oriented programming is to provide reusable code. When you develop a new project, particularly if the project is large, it's nice to be able to reuse proven code rather than to reinvent it. Employing old code saves time and because it has already been used and tested, can help suppress the introduction of bugs into a program. Also the less you have to concern yourself with details, the better you can concentrate on overall program strategy.

Traditional C function libraries provide reusability through predefined, precompiled functions, such as `strlen()` and `rand()`, that you can use in your programs. Many vendors furnish specialized C libraries that provide functions beyond those of the standard C library. For example, you can purchase libraries of database management functions and of screen control functions. However, function libraries have a limitation: Unless the vendor supplies the source code for its library functions (and often it doesn't), you can't extend or modify the functions to meet your particular needs. Instead, you have to shape your program to meet the workings of the library. Even if the vendor does supply the source code, you run the risk of unintentionally modifying how part of a function works or of altering the relationships among library functions as you add your changes.

C++ classes bring a higher level of reusability. Many vendors now offer class libraries, which consist of class declarations and implementations. Because a class combines data representation with class methods, it provides a more integrated package than does a function library. A single class, for example, may provide all the resources for managing a dialog box. Often class libraries are available in source code, which means you can modify them to meet your needs. But C++ has a better method than code modification for extending and modifying classes. This method, called *class inheritance*, lets you derive new classes from old ones, with the derived class inheriting the properties, including the methods, of the old class, called a *base class*. Just as inheriting a fortune is usually easier than earning one from scratch, deriving a class through inheritance is usually easier than designing a new one. Here are some things you can do with inheritance:

- You can add functionality to an existing class. For example, given a basic array class, you could add arithmetic operations.
- You can add to the data that a class represents. For example, given a basic string class, you could derive a class that adds a data member representing a color to be used when displaying the string.
- You can modify how a class method behaves. For example, given a `Passenger` class that represents the services provided to an airline passenger, you can derive a `FirstClassPassenger` class that provides a higher level of services.

Of course, you could accomplish the same aims by duplicating the original class code and modifying it, but the inheritance mechanism allows you to proceed by just providing the new features. You don't even need access to the source code to derive a class. Thus, if you purchase a class library that provides only the header files and the compiled code for class methods, you can still derive new classes based on the library classes. Conversely, you can distribute your own classes to others, keeping parts of your implementation secret, yet still giving your clients the option of adding features to your classes.

Inheritance is a splendid concept, and its basic implementation is quite simple. But managing inheritance so that it works properly in all situations requires some adjustments. This chapter looks at both the simple and the subtle aspects of inheritance.

## Beginning with a Simple Base Class

When one class inherits from another, the original class is called a *base class*, and the inheriting class is called a *derived class*. So to illustrate inheritance, let's begin with a base class. The Webtown Social Club has decided to keep track of its members who play table tennis. As head programmer for the club, you have designed the simple `TableTennisPlayer` class defined in Listings 13.1 and 13.2.

Listing 13.1 `tabtenno.h`

---

```
// tabtenno.h -- a table-tennis base class
#ifndef TABTENNO_H_
#define TABTENNO_H_
#include <string>
```

```
using std::string;
// simple base class
class TableTennisPlayer
{
private:
    string firstname;
    string lastname;
    bool hasTable;
public:
    TableTennisPlayer (const string & fn = "none",
                      const string & ln = "none", bool ht = false);

    void Name() const;
    bool HasTable() const { return hasTable; };
    void ResetTable(bool v) { hasTable = v; };
};
#endif
```

---

### Listing 13.2 `tabtenn0.cpp`

---

```
//tabtenn0.cpp -- simple base-class methods
#include "tabtenn0.h"
#include <iostream>

TableTennisPlayer::TableTennisPlayer (const string & fn,
                                       const string & ln, bool ht) : firstname(fn),
                                       lastname(ln), hasTable(ht) {}

void TableTennisPlayer::Name() const
{
    std::cout << lastname << ", " << firstname;
}
}
```

---

All the `TableTennisPlayer` class does is keep track of the players' names and whether they have tables. There are a couple of points to notice. First, the class uses the standard `string` class to hold the names. This is more convenient, flexible, and safer than using a character array. And it is rather more professional than the `String` class of Chapter 12, "Classes and Dynamic Memory Allocation." Second, the constructor uses the member initializer list syntax introduced in Chapter 12. You could also do this:

```
TableTennisPlayer::TableTennisPlayer (const string & fn,
                                       const string & ln, bool ht)
{
    firstname = fn;
    lastname = ln;
    hasTable = ht;
}
```

However, this approach has the effect of first calling the default `string` constructor for `firstname` and then invoking the `string` assignment operator to reset `firstname` to `fn`. But the member initializer list syntax saves a step by just using the `string` copy constructor to initialize `firstname` to `fn`.

Listing 13.3 shows this modest class in action.

---

Listing 13.3 `uset0.cpp`

```
// usett0.cpp -- using a base class
#include <iostream>
#include "tabtenn0.h"

int main ( void )
{
    using std::cout;
    TableTennisPlayer player1("Chuck", "Blizzard", true);
    TableTennisPlayer player2("Tara", "Boomdea", false);
    player1.Name();
    if (player1.HasTable())
        cout << ": has a table.\n";
    else
        cout << ": hasn't a table.\n";
    player2.Name();
    if (player2.HasTable())
        cout << ": has a table";
    else
        cout << ": hasn't a table.\n";

    return 0;
}
```

---

And here's the output of the program in Listings 13.1, 13.2, and 13.3:

```
Blizzard, Chuck: has a table.
Boomdea, Tara: hasn't a table.
```

Note that the program uses constructors with C-style string arguments:

```
TableTennisPlayer player1("Chuck", "Blizzard", true);
TableTennisPlayer player2("Tara", "Boomdea", false);
```

But the formal parameters for the constructor were declared as type `const string &`. This is a type mismatch, but the `string` class, much like the `String` class of Chapter 12, has a constructor with a `const char *` parameter, and that constructor is used automatically to create a `string` object initialized by the C-style string. In short, you can use either a `string` object or a C-style string as an argument to the `TableTennisPlayer` constructor. The first invokes a `string` constructor with a `const string &` parameter, and the second invokes a `string` constructor with a `const char *` parameter.

## Deriving a Class

Some members of the Webtown Social Club have played in local table tennis tournaments, and they demand a class that includes the point ratings they've earned through their play. Rather than start from scratch, you can derive a class from the `TableTennisPlayer` class. The first step is to have the `RatedPlayer` class declaration show that it derives from the `TableTennisPlayer` class:

```
// RatedPlayer derives from the TableTennisPlayer base class
class RatedPlayer : public TableTennisPlayer
{
    ...
};
```

The colon indicates that the `RatedPlayer` class is based on the `TableTennisPlayer` class. This particular heading indicates that `TableTennisPlayer` is a public base class; this is termed *public derivation*. An object of a derived class incorporates a base class object. With public derivation, the public members of the base class become public members of the derived class. The private portions of a base class become part of the derived class, but they can be accessed only through public and protected methods of the base class. (We'll get to protected members in a bit.)

What does this accomplish? If you declare a `RatedPlayer` object, it has the following special properties:

- An object of the derived type has stored within it the data members of the base type. (The derived class inherits the base-class implementation.)
- An object of the derived type can use the methods of the base type. (The derived class inherits the base-class interface.)

Thus, a `RatedPlayer` object can store the first name and last name of each player and whether the player has a table. Also a `RatedPlayer` object can use the `Name()`, `HasTable()`, and `ResetTable()` methods from the `TableTennisPlayer` class (see Figure 13.1 for another example).

What needs to be added to these inherited features?

- A derived class needs its own constructors.
- A derived class can add additional data members and member functions as needed.

In this particular case, the class needs one more data member to hold the `ratings` value. It should also have a method for retrieving the rating and a method for resetting the rating. So the class declaration could look like this:

```
// simple derived class
class RatedPlayer : public TableTennisPlayer
{
private:
    unsigned int rating;    // add a data member
```

```
public:
    RatedPlayer (unsigned int r = 0, const string & fn = "none",
                const string & ln = "none", bool ht = false);
    RatedPlayer(unsigned int r, const TableTennisPlayer & tp);
    unsigned int Rating() const { return rating; } // add a method
    void ResetRating (unsigned int r) {rating = r;} // add a method
};
```

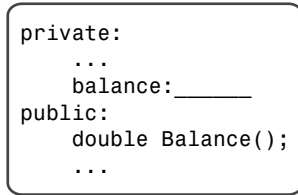

BankAccount object

```
class Overdraft : public BankAccount {...};
```

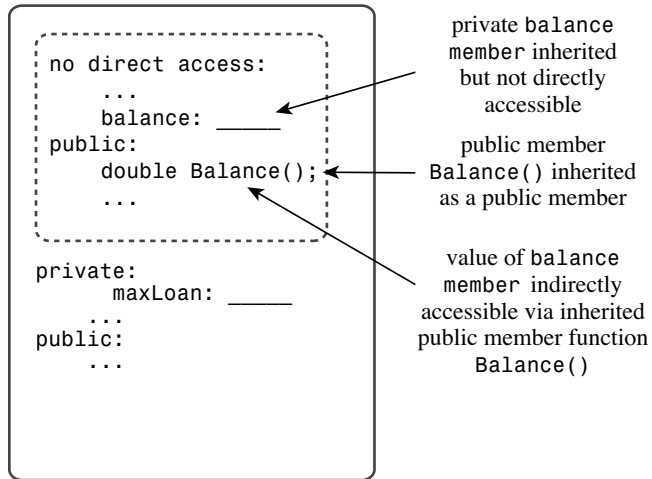

Overdraft object

Figure 13.1 Base-class and derived-class objects.

The constructors have to provide data for the new members, if any, and for the inherited members. The first `RatedPlayer` constructor uses a separate formal parameter for each member, and the second `RatedPlayer` constructor uses a `TableTennisPlayer` parameter, which bundles three items (`firstname`, `lastname`, and `hasTable`) into a single unit.

## Constructors: Access Considerations

A derived class does not have direct access to the private members of the base class; it has to work through the base-class methods. For example, the `RatedPlayer` constructors cannot directly set the inherited members (`firstname`, `lastname`, and `hasTable`). Instead, they have to use public base-class methods to access private base-class members. In particular, the derived-class constructors have to use the base-class constructors.

When a program constructs a derived-class object, it first constructs the base-class object. Conceptually, that means the base-class object should be constructed before the program enters the body of the derived-class constructor. C++ uses the member initializer list syntax to accomplish this. Here, for instance, is the code for the first `RatedPlayer` constructor:

```
RatedPlayer::RatedPlayer(unsigned int r, const string & fn,
    const string & ln, bool ht) : TableTennisPlayer(fn, ln, ht)
{
    rating = r;
}
```

The following part is the member initializer list:

```
: TableTennisPlayer(fn, ln, ht)
```

It's executable code, and it calls the `TableTennisPlayer` constructor. Suppose, for example, a program has the following declaration:

```
RatedPlayer rplayer1(1140, "Mallory", "Duck", true);
```

The `RatedPlayer` constructor assigns the actual arguments "Mallory", "Duck", and `true` to the formal parameters `fn`, `ln`, and `ht`. It then passes these parameters on as actual arguments to the `TableTennisPlayer` constructor. This constructor, in turn, creates the embedded `TableTennisPlayer` object and stores the data "Mallory", "Duck", and `true` in it. Then the program enters the body of the `RatedPlayer` constructor, completes the construction of the `RatedPlayer` object, and assigns the value of the parameter `r` (that is, 1140) to the `rating` member (see Figure 13.2 for another example).

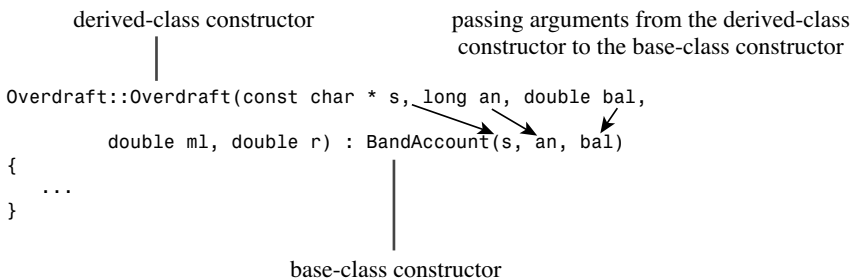

Figure 13.2 Passing arguments through to a base-class constructor.



What if you omit the member initializer list?

```
RatedPlayer::RatedPlayer(unsigned int r, const string & fn,
    const string & ln, bool ht) // what if no initializer list?
{
    rating = r;
}
```

The base-class object must be created first, so if you omit calling a base-class constructor, the program uses the default base-class constructor. Therefore, the previous code is the same as the following:

```
RatedPlayer::RatedPlayer(unsigned int r, const string & fn,
    const string & ln, bool ht) // : TableTennisPlayer()
{
    rating = r;
}
```

Unless you want the default constructor to be used, you should explicitly provide the correct base-class constructor call.

Now let's look at code for the second constructor:

```
RatedPlayer::RatedPlayer(unsigned int r, const TableTennisPlayer & tp)
    : TableTennisPlayer(tp)
{
    rating = r;
}
```

Again, the `TableTennisPlayer` information is passed on to a `TableTennisPlayer` constructor:

```
TableTennisPlayer(tp)
```

Because `tp` is type `const TableTennisPlayer &`, this call invokes the base-class copy constructor. The base class didn't define a copy constructor, but recall from Chapter 12 that the compiler automatically generates a copy constructor if one is needed and you haven't defined one already. In this case, the implicit copy constructor, which does memberwise copying, is fine because the class doesn't directly use dynamic memory allocation. (The `string` members do use dynamic memory allocation, but, recall, memberwise copying will use the `string` class copy constructors to copy the `string` members.)

You may, if you like, also use member initializer list syntax for members of the derived class. In this case, you use the member name instead of the class name in the list. Thus, the second constructor can also be written in this manner:

```
// alternative version
RatedPlayer::RatedPlayer(unsigned int r, const TableTennisPlayer & tp)
    : TableTennisPlayer(tp), rating(r)
{
}
```

These are the key points about constructors for derived classes:

- The base-class object is constructed first.
- The derived-class constructor should pass base-class information to a base-class constructor via a member initializer list.
- The derived-class constructor should initialize the data members that were added to the derived class.

This example doesn't provide explicit destructors, so the implicit destructors are used. Destroying an object occurs in the opposite order used to construct an object. That is, the body of the derived-class destructor is executed first, and then the base-class destructor is called automatically.

### Note

When creating an object of a derived class, a program first calls the base-class constructor and then calls the derived-class constructor. The base-class constructor is responsible for initializing the inherited data members. The derived-class constructor is responsible for initializing any added data members. A derived-class constructor always calls a base-class constructor. You can use the initializer list syntax to indicate *which* base-class constructor to use. Otherwise, the default base-class constructor is used.

When an object of a derived class expires, the program first calls the derived-class destructor and then calls the base-class destructor.

### Member Initializer Lists

A constructor for a derived class can use the initializer list mechanism to pass values along to a base-class constructor. Consider this example:

```
derived::derived(type1 x, type2 y) : base(x,y) // initializer list
{
    ...
}
```

Here, `derived` is the derived class, `base` is the base class, and `x` and `y` are variables used by the base-class constructor. If, say, the derived-class constructor receives the arguments 10 and 12, this mechanism then passes 10 and 12 on to the base-class constructor defined as taking arguments of these types. Except for the case of virtual base classes (see Chapter 14, "Reusing Code in C++"), a class can pass values back only to its immediate base class. However, that class can use the same mechanism to pass back information to its immediate base class, and so on. If you don't supply a base-class constructor in a member initializer list, the program uses the default base-class constructor. The member initializer list can be used *only* in constructors.

## Using a Derived Class

To use a derived class, a program needs access to the base-class declarations. Listing 13.4 places both class declarations in the same header file. You could give each class its own header file, but because the two classes are related, it makes more organizational sense to keep the class declarations together.

Listing 13.4 `tabtenn1.h`

---

```
// tabtenn1.h -- a table-tennis base class
#ifndef TABTENN1_H_
#define TABTENN1_H_
#include <string>
using std::string;
// simple base class
class TableTennisPlayer
{
private:
    string firstname;
    string lastname;
    bool hasTable;
public:
    TableTennisPlayer (const string & fn = "none",
                      const string & ln = "none", bool ht = false);
    void Name() const;
    bool HasTable() const { return hasTable; };
    void ResetTable(bool v) { hasTable = v; };
};

// simple derived class
class RatedPlayer : public TableTennisPlayer
{
private:
    unsigned int rating;
public:
    RatedPlayer (unsigned int r = 0, const string & fn = "none",
                const string & ln = "none", bool ht = false);
    RatedPlayer(unsigned int r, const TableTennisPlayer & tp);
    unsigned int Rating() const { return rating; }
    void ResetRating (unsigned int r) {rating = r;}
};

#endif
```

---

Listing 13.5 provides the method definitions for both classes. Again, you could use separate files, but it's simpler to keep the definitions together.

Listing 13.5 **tabtenn1.cpp**

---

```
//tabtenn1.cpp -- simple base-class methods
#include "tabtenn1.h"
#include <iostream>

TableTennisPlayer::TableTennisPlayer (const string & fn,
    const string & ln, bool ht) : firstname(fn),
    lastname(ln), hasTable(ht) {}

void TableTennisPlayer::Name() const
{
    std::cout << lastname << ", " << firstname;
}

// RatedPlayer methods
RatedPlayer::RatedPlayer(unsigned int r, const string & fn,
    const string & ln, bool ht) : TableTennisPlayer(fn, ln, ht)
{
    rating = r;
}

RatedPlayer::RatedPlayer(unsigned int r, const TableTennisPlayer & tp)
    : TableTennisPlayer(tp), rating(r)
{
}
```

---

Listing 13.6 creates objects of both the `TableTennisPlayer` class and the `RatedPlayer` class. Notice that objects of both classes can use the `TableTennisPlayer` class `Name()` and `HasTable()` methods.

Listing 13.6 **uset1.cpp**

---

```
// usett1.cpp -- using base class and derived class
#include <iostream>
#include "tabtenn1.h"

int main ( void )
{
    using std::cout;
    using std::endl;
    TableTennisPlayer player1("Tara", "Boomdea", false);
    RatedPlayer rplayer1(1140, "Mallory", "Duck", true);
    rplayer1.Name(); // derived object uses base method
    if (rplayer1.HasTable())
        cout << ": has a table.\n";
    else
```

```

        cout << ": hasn't a table.\n";
    player1.Name();           // base object uses base method
    if (player1.HasTable())
        cout << ": has a table";
    else
        cout << ": hasn't a table.\n";
    cout << "Name: ";
    rplayer1.Name();
    cout << "; Rating: " << rplayer1.Rating() << endl;
// initialize RatedPlayer using TableTennisPlayer object
    RatedPlayer rplayer2(1212, player1);
    cout << "Name: ";
    rplayer2.Name();
    cout << "; Rating: " << rplayer2.Rating() << endl;

    return 0;
}

```

---

Here is the output of the program in Listings 13.4, 13.5, and 13.6:

```

Duck, Mallory: has a table.
Boomdea, Tara: hasn't a table.
Name: Duck, Mallory; Rating: 1140
Name: Boomdea, Tara; Rating: 1212

```

## Special Relationships Between Derived and Base Classes

A derived class has some special relationships with the base class. One, which you've just seen, is that a derived-class object can use base-class methods, provided that the methods are not private:

```

RatedPlayer rplayer1(1140, "Mallory", "Duck", true);
rplayer1.Name(); // derived object uses base method

```

Two other important relationships are that a base-class pointer can point to a derived-class object without an explicit type cast and that a base-class reference can refer to a derived-class object without an explicit type cast:

```

RatedPlayer rplayer1(1140, "Mallory", "Duck", true);
TableTennisPlayer & rt = rplayer;
TableTennisPlayer * pt = &rplayer;
rt.Name(); // invoke Name() with reference
pt->Name(); // invoke Name() with pointer

```

However, a base-class pointer or reference can invoke just base-class methods, so you couldn't use `rt` or `pt` to invoke, say, the derived-class `ResetRanking()` method.

Ordinarily, C++ requires that references and pointer types match the assigned types, but this rule is relaxed for inheritance. However, the rule relaxation is just in one direction. You can't assign base-class objects and addresses to derived-class references and pointers:

```
TableTennisPlayer player("Betsy", "Bloop", true);
RatedPlayer & rr = player;      // NOT ALLOWED
RatedPlayer * pr = player;     // NOT ALLOWED
```

Both these sets of rules make sense. For example, consider the implications of having a base-class reference refer to a derived object. In this case, you can use the base-class reference to invoke base-class methods for the derived-class object. Because the derived class inherits the base-class methods and data members, this causes no problems. Now consider what would happen if you could assign a base-class object to a derived-class reference. The derived-class reference would be able to invoke derived-class methods for the base object, and that could cause problems. For example, applying the `RatedPlayer::Rating()` method to a `TableTennisPlayer` object makes no sense because the `TableTennisPlayer` object doesn't have a `rating` member.

The fact that base-class references and pointers can refer to derived-class objects has some interesting consequences. One is that functions defined with base-class reference or pointer arguments can be used with either base-class or derived-class objects. For instance, consider this function:

```
void Show(const TableTennisPlayer & rt)
{
    using std::cout;
    cout << "Name: ";
    rt.Name();
    cout << "\nTable: ";
    if (rt.HasTable())
        cout << "yes\n";
    else
        cout << "no\n";
}
```

The formal parameter `rt` is a reference to a base class, so it can refer to a base-class object or to a derived-class object. Thus, you can use `Show()` with either a `TableTennis` argument or a `RatedPlayer` argument:

```
TableTennisPlayer player1("Tara", "Boomdea", false);
RatedPlayer rplayer1(1140, "Mallory", "Duck", true);
Show(player1); // works with TableTennisPlayer argument
Show(rplayer1); // works with RatedPlayer argument
```

A similar relationship would hold for a function with a pointer-to-base-class formal parameter; it could be used with either the address of a base-class object or the address of a derived-class object as an actual argument:

```
void Wohs(const TableTennisPlayer * pt); // function with pointer parameter
...
TableTennisPlayer player1("Tara", "Boomdea", false);
RatedPlayer rplayer1(1140, "Mallory", "Duck", true);
Wohs(&player1); // works with TableTennisPlayer * argument
Wohs(&rplayer1); // works with RatedPlayer * argument
```

The reference compatibility property also allows you to initialize a base-class object to a derived-class object, although somewhat indirectly. Suppose you have this code:

```
RatedPlayer olaf1(1840, "Olaf", "Loaf", true);
TableTennisPlayer olaf2(olaf1);
```

The exact match for initializing `olaf2` would be a constructor with this prototype:

```
TableTennisPlayer(const RatedPlayer &); // doesn't exist
```

The class definitions don't include this constructor, but there is the implicit copy constructor:

```
// implicit copy constructor
TableTennisPlayer(const TableTennisPlayer &);
```

The formal parameter is a reference to the base type, so it can refer to a derived type. Thus, the attempt to initialize `olaf2` to `olaf1` uses this constructor, which copies the `firstname`, `lastname`, and `hasTable` members. In other words, it initializes `olaf2` to the `TableTennisPlayer` object embedded in the `RatedPlayer` object `olaf1`.

Similarly, you can assign a derived-class object to a base-class object:

```
RatedPlayer olaf1(1840, "Olaf", "Loaf", true);
TableTennisPlayer winner;
winner = olaf1; // assign derived to base object
```

In this case, the program uses the implicit overloaded assignment operator:

```
TableTennisPlayer & operator=(const TableTennisPlayer &) const;
```

Again, a base-class reference refers to a derived-class object, and just the base-class portion of `olaf1` is copied to `winner`.

## Inheritance: An *Is-a* Relationship

The special relationship between a derived class and a base class is based on an underlying model for C++ inheritance. Actually, C++ has three varieties of inheritance: public, protected, and private. Public inheritance is the most common form, and it models an *is-a* relationship. This is shorthand for saying that an object of a derived class should also be an object of the base class. Anything you do with a base-class object, you should be able to do with a derived-class object. Suppose, for example, that you have a `Fruit` class. It could store, say, the weight and caloric content of a fruit. Because a banana is a particular kind of fruit, you could derive a `Banana` class from the `Fruit` class. The new class would inherit all the data members of the original class, so a `Banana` object would have members representing the weight and caloric content of a banana. The new `Banana` class also might add

members that apply particularly to bananas and not to fruit in general, such as the Banana Institute Peel Index. Because the derived class can add features, it's probably more accurate to describe the relationship as an *is-a-kind-of* relationship, but *is-a* is the usual term.

To clarify *is-a* relationships, let's look at some examples that don't match that model. Public inheritance doesn't model a *has-a* relationship. A lunch, for example, might contain a fruit. But a lunch, in general, is not a fruit. Therefore, you should not derive a `Lunch` class from the `Fruit` class in an attempt to place fruit in a lunch. The correct way to handle putting fruit into a lunch is to consider the matter as a *has-a* relationship: A lunch has a fruit. As you'll see in Chapter 14, that's most easily modeled by including a `Fruit` object as a data member of a `Lunch` class (see Figure 13.3).

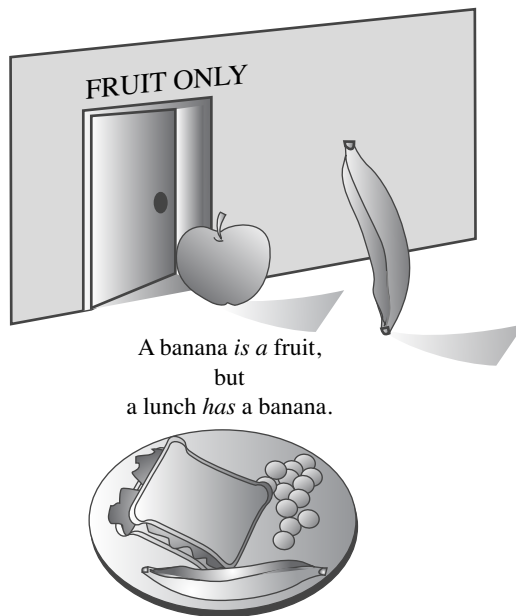

Figure 13.3 *Is-a* and *has-a* relationships.

Public inheritance doesn't model an *is-like-a* relationship—that is, it doesn't do similes. It's often pointed out that lawyers are like sharks. But it is not literally true that a lawyer is a shark. For example, sharks can live underwater. Therefore, you shouldn't derive a `Lawyer` class from a `Shark` class. Inheritance can add properties to a base class; it doesn't remove properties from a base class. In some cases, shared characteristics can be handled by designing a class encompassing those characteristics and then using that class, either in an *is-a* or *has-a* relationship, to define the related classes.



Public inheritance doesn't model an *is-implemented-as-a* relationship. For example, you could implement a stack by using an array. However, it wouldn't be proper to derive a `Stack` class from an `Array` class. A stack is not an array. For example, array indexing is not a stack property. Also a stack could be implemented in some other way, such as by using a linked list. A proper approach would be to hide the array implementation by giving the stack a private `Array` object member.

Public inheritance doesn't model a *uses-a* relationship. For example, a computer can use a laser printer, but it doesn't make sense to derive a `Printer` class from a `Computer` class, or vice versa. You might, however, devise friend functions or classes to handle communication between `Printer` objects and `Computer` objects.

Nothing in the C++ language prevents you from using public inheritance to model *has-a*, *is-implemented-as-a*, or *uses-a* relationships. However, doing so usually leads to programming problems. So let's stick to the *is-a* relationships.

## Polymorphic Public Inheritance

The `RatedPlayer` example of inheritance is a simple one. Objects of the derived class use the base-class methods without change. But you can encounter situations in which you want a method to behave differently for the derived class than it does for the base class. That is, the way a particular method behaves may depend on the object that invokes it. This more sophisticated behavior is termed *polymorphic* ("having many forms") because you can have multiple behaviors for a method, depending on the context. There are two key mechanisms for implementing polymorphic public inheritance:

- Redefining base-class methods in a derived class
- Using virtual methods

It's time for another example. You have leveraged your experience with the Webtown Social Club to become head programmer for the Pontoon National Bank. The first thing the bank asks you to do is develop two classes. One class will represent its basic checking plan, the Brass Account, and the second class will represent the Brass Plus checking account, which adds an overdraft protection feature. That is, if a user writes a check larger (but not too much larger) than his or her balance, the bank will cover the check, charging the user for the excess payment and adding a surcharge. You can characterize the two accounts in terms of data to be stored and operations to be allowed.

First, here is the information for a Brass Account checking plan:

- Client name
- Account number
- Current balance

And here are the operations to be represented:

- Creating an account
- Depositing money into the account

- Withdrawing money from the account
- Displaying the account information

For the Brass Plus Account checking plan, the Pontoon National Bank wants all the features of the Brass Account as well as the following additional items of information:

- An upper limit to the overdraft protection
- An interest rate charged for overdraft loans
- The overdraft amount currently owed to the bank

No additional operations are needed, but two operations need to be implemented differently:

- The withdrawing money operation has to incorporate overdraft protection for the Brass Plus Account
- The display operation has to show the additional information required by the Brass Plus Account

Suppose you call one class `Brass` and the second class `BrassPlus`. Should you derive `BrassPlus` publicly from `Brass`? To answer this question, first answer another: Does the `BrassPlus` class meet the *is-a* test? Sure. Everything that is true of a `Brass` object will be true for a `BrassPlus` object. Both store a client name, an account number, and a balance. With both, you can make deposits and withdrawals and display account information. Note that the *is-a* relationship is not, in general, symmetric. A fruit, in general, is not a banana; similarly, a `Brass` object won't have all the capabilities of a `BrassPlus` object.

## Developing the `Brass` and `BrassPlus` Classes

The Brass Account class information is pretty straightforward, but the bank hasn't told you enough details about how the overdraft system works. In response to your request for further information, the friendly Pontoon National Bank representative tells you the following:

- A Brass Plus Account limits how much money the bank will lend you to cover overdrafts. The default value is \$500, but some customers may start with a different limit.
- The bank may change a customer's overdraft limit.
- A Brass Plus Account charges interest on the loan. The default value is 11.125%, but some customers may start with a different rate.
- The bank may change a customer's interest rate.
- The account keeps track of how much the customer owes the bank (overdraft loans plus interest). The user cannot pay off this amount through a regular deposit or

through a transfer from another account. Instead, he or she must pay in cash to a special bank officer, who will, if necessary, seek out the customer. When the debt is paid, the account can reset the amount owed to 0.

The last feature is an unusual way for a bank to do business, but it has the fortunate side effect of keeping the programming problem simpler.

This list suggests that the new class needs constructors that provide account information and that include a debt limit with a default value of \$500 and an interest rate with a default value of 10%. Also there should be methods for resetting the debt limit, interest rate, and current debt. These are all things to be added to the `Brass` class, and they will be declared in the `BrassPlus` class declaration.

The information about the two classes suggests class declarations like those in Listing 13.7.

#### Listing 13.7 `brass.h`

---

```
// brass.h -- bank account classes
#ifndef BRASS_H_
#define BRASS_H_
#include <string>
// Brass Account Class
class Brass
{
private:
    std::string fullName;
    long acctNum;
    double balance;
public:
    Brass(const std::string & s = "Nullbody", long an = -1,
          double bal = 0.0);
    void Deposit(double amt);
    virtual void Withdraw(double amt);
    double Balance() const;
    virtual void ViewAcct() const;
    virtual ~Brass() {}
};

//Brass Plus Account Class
class BrassPlus : public Brass
{
private:
    double maxLoan;
    double rate;
    double owesBank;
public:
    BrassPlus(const std::string & s = "Nullbody", long an = -1,
              double bal = 0.0, double ml = 500,
```

```

        double r = 0.11125);
BrassPlus(const Brass & ba, double ml = 500,
          double r = 0.11125);
virtual void ViewAcct()const;
virtual void Withdraw(double amt);
void ResetMax(double m) { maxLoan = m; }
void ResetRate(double r) { rate = r; };
void ResetOwes() { owesBank = 0; }
};

#endif

```

---

There are several points to notice in Listing 13.7:

- The `BrassPlus` class adds three new private data members and three new public member functions to the `Brass` class.
- Both the `Brass` class and the `BrassPlus` class declare the `ViewAcct()` and `Withdraw()` methods; these are the methods that will behave differently for a `BrassPlus` object than they do with a `Brass` object.
- The `Brass` class uses the new keyword `virtual` in declaring `ViewAcct()` and `Withdraw()`. These methods are now termed *virtual methods*.
- The `Brass` class also declares a virtual destructor, even though the destructor does nothing.

The first point in the list is nothing new. The `RatedPlayer` class did something similar when it added a new data member and two new methods to the `TableTennisPlayer` class.

The second point in the list is how the declarations specify that methods are to behave differently for the derived class. The two `ViewAcct()` prototypes indicate that there will be two separate method definitions. The qualified name for the base-class version is `Brass::ViewAcct()`, and the qualified name for the derived-class version is `BrassPlus::ViewAcct()`. A program will use the object type to determine which version to use:

```

Brass dom("Dominic Banker", 11224, 4183.45);
BrassPlus dot("Dorothy Banker", 12118, 2592.00);
dom.ViewAcct();           // use Brass::ViewAcct()
dot.ViewAcct();          // use BrassPlus::ViewAcct()

```

Similarly, there will be two versions of `Withdraw()`: one that's used by `Brass` objects and one that's used by `BrassPlus` objects. Methods that behave the same for both classes, such as `Deposit()` and `Balance()`, are declared only in the base class.

The third point (the use of `virtual`) is more involved than the first two points. It determines which method is used if the method is invoked by a reference or a pointer instead of by an object. If you don't use the keyword `virtual`, the program chooses a method based on the reference type or pointer type. If you do use the keyword `virtual`,

the program chooses a method based on the type of object the reference or pointer refers to. Here is how a program behaves if `ViewAcct()` is not virtual:

```
// behavior with non-virtual ViewAcct()
// method chosen according to reference type
Brass dom("Dominic Banker", 11224, 4183.45);
BrassPlus dot("Dorothy Banker", 12118, 2592.00);
Brass & b1_ref = dom;
Brass & b2_ref = dot;
b1_ref.ViewAcct();      // use Brass::ViewAcct()
b2_ref.ViewAcct();      // use Brass::ViewAcct()
```

The reference variables are type `Brass`, so `Brass::ViewAccount()` is chosen. Using pointers to `Brass` instead of references results in similar behavior.

In contrast, here is the behavior if `ViewAcct()` is virtual:

```
// behavior with virtual ViewAcct()
// method chosen according to object type
Brass dom("Dominic Banker", 11224, 4183.45);
BrassPlus dot("Dorothy Banker", 12118, 2592.00);
Brass & b1_ref = dom;
Brass & b2_ref = dot;
b1_ref.ViewAcct();      // use Brass::ViewAcct()
b2_ref.ViewAcct();      // use BrassPlus::ViewAcct()
```

In this case, both references are type `Brass`, but `b2_ref` refers to a `BrassPlus` object, so `BrassPlus::ViewAcct()` is used for it. Using pointers to `Brass` instead of references results in similar behavior.

It turns out, as you'll see in a bit, that this behavior of virtual functions is very handy. Therefore, it is the common practice to declare as virtual in the base class those methods that might be redefined in a derived class. When a method is declared virtual in a base class, it is automatically virtual in the derived class, but it is a good idea to document which functions are virtual by using the keyword `virtual` in the derived class declarations, too.

The fourth point is that the base class declares a virtual destructor. This is to make sure that the correct sequence of destructors is called when a derived object is destroyed. We'll discuss this point in more detail later in this chapter.

### Note

If you redefine a base-class method in a derived class, the usual practice is to declare the base-class method as virtual. This makes the program choose the method version based on object type instead of the type of a reference or pointer. It's also the usual practice to declare a virtual destructor for the base class.

## Class Implementations

The next step is to prepare the class implementation. Part of this has been done already by the inline function definitions in the header file. Listing 13.8 provides the remaining method definitions. Note that the keyword `virtual` is used just in the method prototypes in the class declaration, not in the method definitions in Listing 13.8.

### Listing 13.8 `brass.cpp`

---

```
// brass.cpp -- bank account class methods
#include <iostream>
#include "brass.h"
using std::cout;
using std::endl;
using std::string;

// formatting stuff
typedef std::ios_base::fmtflags format;
typedef std::streamsize precis;
format setFormat();
void restore(format f, precis p);

// Brass methods

Brass::Brass(const string & s, long an, double bal)
{
    fullName = s;
    acctNum = an;
    balance = bal;
}

void Brass::Deposit(double amt)
{
    if (amt < 0)
        cout << "Negative deposit not allowed; "
              << "deposit is cancelled.\n";
    else
        balance += amt;
}

void Brass::Withdraw(double amt)
{
    // set up ###.## format
    format initialState = setFormat();
    precis prec = cout.precision(2);

    if (amt < 0)
        cout << "Withdrawal amount must be positive; "
```

```

        << "withdrawal canceled.\n";
    else if (amt <= balance)
        balance -= amt;
    else
        cout << "Withdrawal amount of $" << amt
            << " exceeds your balance.\n"
            << "Withdrawal canceled.\n";
    restore(initialState, prec);
}
double Brass::Balance() const
{
    return balance;
}

void Brass::ViewAcct() const
{
    // set up ###.## format
    format initialState = setFormat();
    precis prec = cout.precision(2);
    cout << "Client: " << fullName << endl;
    cout << "Account Number: " << acctNum << endl;
    cout << "Balance: $" << balance << endl;
    restore(initialState, prec); // restore original format
}

// BrassPlus Methods
BrassPlus::BrassPlus(const string & s, long an, double bal,
                    double ml, double r) : Brass(s, an, bal)
{
    maxLoan = ml;
    owesBank = 0.0;
    rate = r;
}

BrassPlus::BrassPlus(const Brass & ba, double ml, double r)
    : Brass(ba) // uses implicit copy constructor
{
    maxLoan = ml;
    owesBank = 0.0;
    rate = r;
}

// redefine how ViewAcct() works
void BrassPlus::ViewAcct() const
{
    // set up ###.## format
    format initialState = setFormat();

```

```

    precis prec = cout.precision(2);

    Brass::ViewAcct(); // display base portion
    cout << "Maximum loan: $" << maxLoan << endl;
    cout << "Owed to bank: $" << owesBank << endl;
    cout.precision(3); // ###.### format
    cout << "Loan Rate: " << 100 * rate << "%\n";
    restore(initialState, prec);
}

// redefine how Withdraw() works
void BrassPlus::Withdraw(double amt)
{
    // set up ###.## format
    format initialState = setFormat();
    precis prec = cout.precision(2);

    double bal = Balance();
    if (amt <= bal)
        Brass::Withdraw(amt);
    else if (amt <= bal + maxLoan - owesBank)
    {
        double advance = amt - bal;
        owesBank += advance * (1.0 + rate);
        cout << "Bank advance: $" << advance << endl;
        cout << "Finance charge: $" << advance * rate << endl;
        Deposit(advance);
        Brass::Withdraw(amt);
    }
    else
        cout << "Credit limit exceeded. Transaction cancelled.\n";
    restore(initialState, prec);
}

format setFormat()
{
    // set up ###.## format
    return cout.setf(std::ios_base::fixed,
                    std::ios_base::floatfield);
}

void restore(format f, precis p)
{
    cout.setf(f, std::ios_base::floatfield);
    cout.precision(p);
}

```

---



Before looking at details of Listing 13.8, such as handling of formatting in some of the methods, let's examine the aspects that relate directly to inheritance. Keep in mind that the derived class does not have direct access to private base-class data; the derived class has to use base-class public methods to access that data. The means of access depends on the method. Constructors use one technique, and other member functions use a different technique.

The technique that derived-class constructors use to initialize base-class private data is the member initializer list syntax. The `RatedPlayer` class constructors use that technique, and so do the `BrassPlus` constructors:

```
BrassPlus::BrassPlus(const string & s, long an, double bal,
                    double ml, double r) : Brass(s, an, bal)
{
    maxLoan = ml;
    owesBank = 0.0;
    rate = r;
}

BrassPlus::BrassPlus(const Brass & ba, double ml, double r)
    : Brass(ba) // uses implicit copy constructor
{
    maxLoan = ml;
    owesBank = 0.0;
    rate = r;
}
```

Each of these constructors uses the member initializer list syntax to pass base-class information to a base-class constructor and then uses the constructor body to initialize the new data items added by the `BrassPlus` class.

Non-constructors can't use the member initializer list syntax. But a derived-class method can call a public base-class method. For instance, ignoring the formatting aspect, the core of the `BrassPlus` version of `ViewAcct()` is this:

```
// redefine how ViewAcct() works
void BrassPlus::ViewAcct() const
{
    ...
    Brass::ViewAcct(); // display base portion
    cout << "Maximum loan: $" << maxLoan << endl;
    cout << "Owed to bank: $" << owesBank << endl;
    cout << "Loan Rate: " << 100 * rate << "%\n";
    ...
}
```

In other words, `BrassPlus::ViewAcct()` displays the added `BrassPlus` data members and calls on the base-class method `Brass::ViewAcct()` to display the base-class data members. Using the scope-resolution operator in a derived-class method to invoke a base-class method is a standard technique.

It's vital that the code use the scope-resolution operator. Suppose that, instead, you wrote the code this way:

```
// redefine erroneously how ViewAcct() works
void BrassPlus::ViewAcct() const
{
...
    ViewAcct(); // oops! recursive call
...
}
```

If the code doesn't use the scope-resolution operator, the compiler assumes that `ViewAcct()` is `BrassPlus::ViewAcct()`, and this creates a recursive function that has no termination—not a good thing.

Next, consider the `BrassPlus::Withdraw()` method. If the client withdraws an amount larger than the balance, the method should arrange for a loan. It can use `Brass::Withdraw()` to access the balance member, but `Brass::Withdraw()` issues an error message if the withdrawal amount exceeds the balance. This implementation avoids the message by using the `Deposit()` method to make the loan and then calling `Brass::Withdraw()` when sufficient funds are available:

```
// redefine how Withdraw() works
void BrassPlus::Withdraw(double amt)
{
...
    double bal = Balance();
    if (amt <= bal)
        Brass::Withdraw(amt);
    else if (amt <= bal + maxLoan - owesBank)
    {
        double advance = amt - bal;
        owesBank += advance * (1.0 + rate);
        cout << "Bank advance: $" << advance << endl;
        cout << "Finance charge: $" << advance * rate << endl;
        Deposit(advance);
        Brass::Withdraw(amt);
    }
    else
        cout << "Credit limit exceeded. Transaction cancelled.\n";
...
}
```

Note that the method uses the base-class `Balance()` function to determine the original balance. The code doesn't have to use the scope-resolution operator for `Balance()` because this method has not been redefined in the derived class.

The `ViewAcct()` and the `Withdraw()` methods use the `setf()` and `precision()` formatting methods to set the output mode for floating-point values to fixed-point, two

places to the right of the decimal. When these modes are set, output stays in that mode, so the polite thing for these methods to do is to reset the formatting mode to its state prior to calling the methods. Listings 8.8 and 10.5 use similar approaches. To avoid some code duplication, the program moves some of the formatting actions to helper functions:

```
// formatting stuff
typedef std::ios_base::fmtflags format;
typedef std::streamsize precis;
format setFormat();
void restore(format f, precis p);
```

The `setFormat()` function sets fixed-point notation and returns the previous flag setting:

```
format setFormat()
{
    // set up ###.## format
    return cout.setf(std::ios_base::fixed,
                    std::ios_base::floatfield);
}
```

And the `restore()` function resets the format and the precision:

```
void restore(format f, precis p)
{
    cout.setf(f, std::ios_base::floatfield);
    cout.precision(p);
}
```

You can find more details about formatting in Chapter 17, “Input, Output, and Files.”

### Using the Brass and BrassPlus Classes

Listing 13.9 shows the class definitions with a `Brass` object and a `BrassPlus` object.

#### Listing 13.9 `usebrass1.cpp`

---

```
// usebrass1.cpp -- testing bank account classes
// compile with brass.cpp
#include <iostream>
#include "brass.h"

int main()
{
    using std::cout;
    using std::endl;

    Brass Piggy("Porcelot Pigg", 381299, 4000.00);
    BrassPlus Hoggy("Horatio Hogg", 382288, 3000.00);
    Piggy.ViewAcct();
    cout << endl;
```

```
Hoggy.ViewAcct();
cout << endl;
cout << "Depositing $1000 into the Hogg Account:\n";
Hoggy.Deposit(1000.00);
cout << "New balance: $" << Hoggy.Balance() << endl;
cout << "Withdrawing $4200 from the Pigg Account:\n";
Piggy.Withdraw(4200.00);
cout << "Pigg account balance: $" << Piggy.Balance() << endl;
cout << "Withdrawing $4200 from the Hogg Account:\n";
Hoggy.Withdraw(4200.00);
Hoggy.ViewAcct();

return 0;
}
```

---

In the following output of the program in Listing 13.9, note that Hogg gets overdraft protection and Pigg does not:

```
Client: Porcelot Pigg
Account Number: 381299
Balance: $4000.00
```

```
Client: Horatio Hogg
Account Number: 382288
Balance: $3000.00
Maximum loan: $500.00
Owed to bank: $0.00
Loan Rate: 11.125%
```

```
Depositing $1000 into the Hogg Account:
New balance: $4000
Withdrawing $4200 from the Pigg Account:
Withdrawal amount of $4200.00 exceeds your balance.
Withdrawal canceled.
Pigg account balance: $4000
Withdrawing $4200 from the Hogg Account:
Bank advance: $200.00
Finance charge: $22.25
Client: Horatio Hogg
Account Number: 382288
Balance: $0.00
Maximum loan: $500.00
Owed to bank: $222.25
Loan Rate: 11.125%
```

### Showing Virtual Method Behavior

In Listing 13.9 the methods are invoked by objects, not pointers or references, so this program doesn't use the virtual method feature. Let's look at an example for which the virtual methods do come into play. Suppose you would like to manage a mixture of `Brass` and `BrassPlus` accounts. It would be nice if you could have a single array that holds a mixture of `Brass` and `BrassPlus` objects, but that's not possible. Every item in an array has to be of the same type, and `Brass` and `BrassPlus` are two separate types. However, you can create an array of pointers-to-`Brass`. In that case, every element is of the same type, but because of the public inheritance model, a pointer-to-`Brass` can point to either a `Brass` or a `BrassPlus` object. Thus, in effect, you have a way of representing a collection of more than one type of object with a single array. This is polymorphism, and Listing 13.10 shows a simple example.

#### Listing 13.10 `usebrass2.cpp`

---

```
// usebrass2.cpp -- polymorphic example
// compile with brass.cpp
#include <iostream>
#include <string>
#include "brass.h"
const int CLIENTS = 4;

int main()
{
    using std::cin;
    using std::cout;
    using std::endl;

    Brass * p_clients[CLIENTS];
    std::string temp;
    long tempnum;
    double tempbal;
    char kind;

    for (int i = 0; i < CLIENTS; i++)
    {
        cout << "Enter client's name: ";
        getline(cin,temp);
        cout << "Enter client's account number: ";
        cin >> tempnum;
        cout << "Enter opening balance: $";
        cin >> tempbal;
        cout << "Enter 1 for Brass Account or "
            << "2 for BrassPlus Account: ";
        while (cin >> kind && (kind != '1' && kind != '2'))
            cout <<"Enter either 1 or 2: ";
```

```

if (kind == '1')
    p_clients[i] = new Brass(temp, tempnum, tempbal);
else
{
    double tmax, trate;
    cout << "Enter the overdraft limit: $";
    cin >> tmax;
    cout << "Enter the interest rate "
        << "as a decimal fraction: ";
    cin >> trate;
    p_clients[i] = new BrassPlus(temp, tempnum, tempbal,
                                tmax, trate);
}
while (cin.get() != '\n')
    continue;
}
cout << endl;
for (int i = 0; i < CLIENTS; i++)
{
    p_clients[i]->ViewAcct();
    cout << endl;
}

for (int i = 0; i < CLIENTS; i++)
{
    delete p_clients[i]; // free memory
}
cout << "Done.\n";
return 0;
}

```

---

The program in Listing 13.10 lets user input determine the type of account to be added and then uses `new` to create and initialize an object of the proper type. You may recall that `getline(cin, temp)` reads a line of input from `cin` and stores it in the `string` object `temp`.

Here is a sample run of the program in Listing 13.10:

```

Enter client's name: Harry Fishsong
Enter client's account number: 112233
Enter opening balance: $1500
Enter 1 for Brass Account or 2 for BrassPlus Account: 1
Enter client's name: Dinah Otternoe
Enter client's account number: 121213
Enter opening balance: $1800
Enter 1 for Brass Account or 2 for BrassPlus Account: 2
Enter the overdraft limit: $350
Enter the interest rate as a decimal fraction: 0.12

```

```

Enter client's name: Brenda Birdherd
Enter client's account number: 212118
Enter opening balance: $5200
Enter 1 for Brass Account or 2 for BrassPlus Account: 2
Enter the overdraft limit: $800
Enter the interest rate as a decimal fraction: 0.10
Enter client's name: Tim Turtletop
Enter client's account number: 233255
Enter opening balance: $688
Enter 1 for Brass Account or 2 for BrassPlus Account: 1

```

```

Client: Harry Fishsong
Account Number: 112233
Balance: $1500.00

```

```

Client: Dinah Otternoe
Account Number: 121213
Balance: $1800.00
Maximum loan: $350.00
Owed to bank: $0.00
Loan Rate: 12.00%

```

```

Client: Brenda Birdherd
Account Number: 212118
Balance: $5200.00
Maximum loan: $800.00
Owed to bank: $0.00
Loan Rate: 10.00%

```

```

Client: Tim Turtletop
Account Number: 233255
Balance: $688.00

```

Done.

The polymorphic aspect is provided by the following code:

```

for (i = 0; i < CLIENTS; i++)
{
    p_clients[i]->ViewAcct();
    cout << endl;
}

```

If the array member points to a `Brass` object, `Brass::ViewAcct()` is invoked; if the array member points to a `BrassPlus` object, `BrassPlus::ViewAcct()` is invoked. If `Brass::ViewAcct()` were been declared as `virtual`, `Brass::ViewAcct()` would be invoked in all cases.

## The Need for Virtual Destructors

The code in Listing 13.10 that uses `delete` to free the objects allocated by `new` illustrates why the base class should have a virtual destructor, even if no destructor appears to be needed. If the destructors are not virtual, then just the destructor corresponding to the pointer type is called. In Listing 13.10, this means that only the `Brass` destructor would be called, even if the pointer pointed to a `BrassPlus` object. If the destructors are virtual, the destructor corresponding to the object type is called. So if a pointer points to a `BrassPlus` object, the `BrassPlus` destructor is called. And when a `BrassPlus` destructor finishes, it automatically calls the base-class constructor. Thus, using virtual destructors ensures that the correct sequence of destructors is called. In Listing 13.10, this correct behavior isn't essential because the destructors do nothing. But if, say, `BrassPlus` had a do-something destructor, it would be vital for `Brass` to have a virtual destructor, even if it did nothing.

## Static and Dynamic Binding

Which block of executable code gets used when a program calls a function? The compiler has the responsibility of answering this question. Interpreting a function call in the source code as executing a particular block of function code is termed *binding* the function name. With C, the task is simple because each function name corresponds to a distinct function. With C++, the task is more complex because of function overloading. The compiler has to look at the function arguments as well as the function name to figure out which function to use. Nonetheless, this kind of binding is a task a C or C++ compiler could perform during the compiling process; binding that takes place during compilation is called *static binding* (or *early binding*). However, virtual functions make the job more difficult yet. As shown in Listing 13.10, the decision of which function to use can't be made at compile time because the compiler doesn't know which kind of object the user is going to choose to make. Therefore, the compiler has to generate code that allows the correct virtual method to be selected as the program runs; this is called *dynamic binding* (or *late binding*).

Now that you've seen virtual methods at work, let's look at this process in greater depth, beginning with how C++ handles pointer and reference type compatibility.

## Pointer and Reference Type Compatibility

Dynamic binding in C++ is associated with methods invoked by pointers and references, and this is governed, in part, by the inheritance process. One way public inheritance models the *is-a* relationship is in how it handles pointers and references to objects. Normally, C++ does not allow you to assign an address of one type to a pointer of another type. Nor does it let a reference to one type refer to another type:

```
double x = 2.5;
int * pi = &x;    // invalid assignment, mismatched pointer types
long & r1 = x;    // invalid assignment, mismatched reference type
```



However, as you've seen, a reference or a pointer to a base class can refer to a derived-class object without using an explicit type cast. For example, the following initializations are allowed:

```
BrassPlus dilly ("Annie Dill", 493222, 2000);
Brass * pb = &dilly;    // ok
Brass & rb = dilly;    // ok
```

Converting a derived-class reference or pointer to a base-class reference or pointer is called *upcasting*, and it is always allowed for public inheritance without the need for an explicit type cast. This rule is part of expressing the *is-a* relationship. A `BrassPlus` object is a `Brass` object in that it inherits all the data members and member functions of a `Brass` object. Therefore, anything that you can do to a `Brass` object, you can do to a `BrassPlus` object. So a function designed to handle a `Brass` reference can, without fear of creating problems, perform the same acts on a `BrassPlus` object. The same idea applies if you pass a pointer to an object as a function argument. Upcasting is transitive. That is, if you derive a `BrassPlusPlus` class from `BrassPlus`, then a `Brass` pointer or reference can refer to a `Brass` object, a `BrassPlus` object, or a `BrassPlusPlus` object.

The opposite process, converting a base-class pointer or reference to a derived-class pointer or reference, is called *downcasting*, and it is not allowed without an explicit type cast. The reason for this restriction is that the *is-a* relationship is not, in general, symmetric. A derived class could add new data members, and the class member functions that used these data members wouldn't apply to the base class. For example, suppose you derive a `Singer` class from an `Employee` class, adding a data member representing a singer's vocal range and a member function, called `range()`, that reports the value for the vocal range. It wouldn't make sense to apply the `range()` method to an `Employee` object. But if implicit downcasting were allowed, you could accidentally set a pointer-to-`Singer` to the address of an `Employee` object and use the pointer to invoke the `range()` method (see Figure 13.4).

Upcasting also takes place for function calls with base-class references or pointers as parameters. Consider the following code fragment, and suppose each function calls upon the virtual method `ViewAcct()`:

```
void fr(Brass & rb); // uses rb.ViewAcct()
void fp(Brass * pb); // uses pb->ViewAcct()
void fv(Brass b);   // uses b.ViewAcct()
int main()
{
    Brass b("Billy Bee", 123432, 10000.0);
    BrassPlus bp("Betty Beep", 232313, 12345.0);
    fr(b); // uses Brass::ViewAcct()
    fr(bp); // uses BrassPlus::ViewAcct()
    fp(b); // uses Brass::ViewAcct()
    fp(bp); // uses BrassPlus::ViewAcct()
```

```

fv(b); // uses Brass::ViewAcct()
fv(bp); // uses Brass::ViewAcct()
...
}

```

Passing by value causes only the `Brass` component of a `BrassPlus` object to be passed to the `fv()` function. But the implicit upcasting that occurs with references and pointers causes the `fr()` and `fp()` functions to use `Brass::ViewAcct()` for `Brass` objects and `BrassPlus::ViewAcct()` for `BrassPlus` objects.

Implicit upcasting makes it possible for a base-class pointer or reference to refer to either a base-class object or a derived-class object, and that produces the need for dynamic binding. Virtual member functions are the C++ answer to that need.

## Virtual Member Functions and Dynamic Binding

Let's revisit the process of invoking a method with a reference or pointer. Consider the following code:

```

BrassPlus ophelia; // derived-class object
Brass * bp; // base-class pointer
bp = &ophelia; // Brass pointer to BrassPlus object
bp->ViewAcct(); // which version?

```

As discussed before, if `ViewAcct()` is not declared as virtual in the base class, `bp->ViewAcct()` goes by the pointer type (`Brass *`) and invokes `Brass::ViewAcct()`. The pointer type is known at compile time, so the compiler can bind `ViewAcct()` to `Brass::ViewAcct()` at compile time. In short, the compiler uses static binding for non-virtual methods.

But if `ViewAcct()` is declared as virtual in the base class, `bp->ViewAcct()` goes by the object type (`BrassPlus`) and invokes `BrassPlus::ViewAcct()`. In this example, you can see that the object type is `BrassPlus`, but, in general, (as in Listing 13.10) the object type might only be determined when the program is running. Therefore, the compiler generates code that binds `ViewAcct()` to `Brass::ViewAcct()` or `BrassPlus::ViewAcct()`, depending on the object type, while the program executes. In short, the compiler uses dynamic binding for virtual methods.

In most cases, dynamic binding is a good thing because it allows a program to choose the method designed for a particular type. Given this fact, you might be wondering about the following:

- Why have two kinds of binding?
- If dynamic binding is so good, why isn't it the default?
- How does it work?

We'll look at answers to these questions next.

## Why Two Kinds of Binding and Why Static Is the Default

If dynamic binding allows you to redefine class methods but static binding makes a partial botch of it, why have static binding at all? There are two reasons: efficiency and a conceptual model.

First, let's consider efficiency. For a program to be able to make a runtime decision, it has to have some way to keep track of what sort of object a base-class pointer or reference refers to, and that entails some extra processing overhead. (You'll see one method of dynamic binding later.) If, for example, you design a class that won't be used as a base class for inheritance, you don't need dynamic binding. Similarly, if you have a derived class, such as the `RatedPlayer` example, that does not redefine any methods, you don't need dynamic binding. In these cases, it makes sense to use static binding and gain a little efficiency. The fact that static binding is more efficient is the reason it is the default choice for C++. Stroustrup says that one of the guiding principles of C++ is that you shouldn't have to pay (in memory usage or processing time) for features you don't use. You should therefore go to virtual functions only if the program design needs them.

Next, let's consider the conceptual model. When you design a class, you may have member functions that you don't want redefined in derived classes. For example, the `Brass::Balance()` function, which returns the account balance, seems like a function that shouldn't be redefined. By making this function nonvirtual, you accomplish two things. First, you make it more efficient. Second, you announce that it is your intention that this function not be redefined. That suggests reserving the virtual label just for methods you expect to be redefined.

### Tip

If a method in a base class will be redefined in a derived class, you should make it virtual. If the method should not be redefined, you should make it nonvirtual.

Of course, when you design a class, it's not always obvious into which category a method falls. Like many aspects of real life, class design is not a linear process.

## How Virtual Functions Work

C++ specifies how virtual functions should behave, but it leaves the implementation up to the compiler writer. You don't need to know the implementation method to use virtual functions, but seeing how it is done may help you understand the concepts better, so let's take a look.

The usual way compilers handle virtual functions is to add a hidden member to each object. The hidden member holds a pointer to an array of function addresses. Such an array is usually termed a *virtual function table* (*vtbl*). The vtbl holds the addresses of the virtual functions declared for objects of that class. For example, an object of a base class contains a pointer to a table of addresses of all the virtual functions for that class. An object of a derived class contains a pointer to a separate table of addresses. If the derived class provides a new definition of a virtual function, the vtbl holds the address of the new function.

If the derived class doesn't redefine the virtual function, the vtbl holds the address of the original version of the function. If the derived class defines a new function and makes it virtual, its address is added to the vtbl (see Figure 13.5). Note that whether you define 1 or 10 virtual functions for a class, you add just one address member to an object; it's the table size that varies.

```

class Scientist{
{
    ...
    char name[40];
public:
    virtual void show_name();
    virtual void show_all();
    ...
};
class Physicist : public Scientist
{
    ...
    char field[40];
public:
    void show_all(); // redefined
    virtual void show_field(); // new
    ...
};
    
```

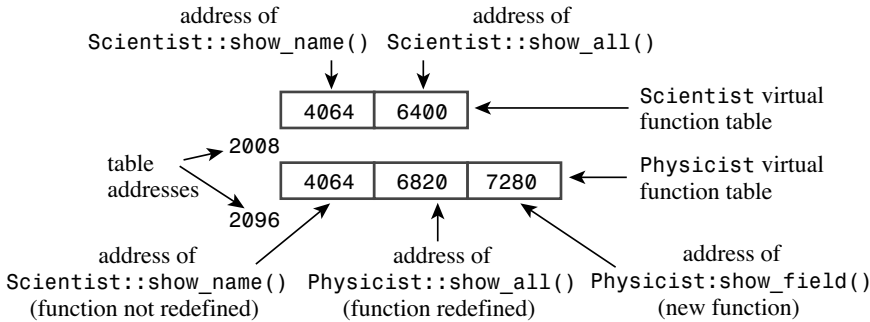

|     |             |      |  |
|-----|-------------|------|--|
| ... | Sophie Fant | 2008 |  |
| ... | name        | vptr |  |

|     |              |      |                   |
|-----|--------------|------|-------------------|
| ... | Adam Crusher | 2096 | nuclear structure |
| ... | name         | vptr | field             |

Scientist object with hidden pointer member vptr, which points to Scientist virtual function table

Physicist object with hidden pointer member vptr, which points to Physicist virtual function table

```

Physicist adam("Adam Crusher", "nuclear structure");
Scientist * psc = &adam;
psc->show_all();
    
```

1. Find value of psc->vptr, which is 2096.
2. Go to table at 2096.
3. Find address of second function in table, which is 6820.
4. Go to that address (6820) and execute the function found there.

Figure 13.5 A virtual function mechanism.

When you call a virtual function, the program looks at the vtbl address stored in an object and goes to the corresponding table of function addresses. If you use the first virtual function defined in the class declaration, the program uses the first function address in the array and executes the function that has that address. If you use the third virtual function in the class declaration, the program uses the function whose address is in the third element of the array.

In short, using virtual functions has the following modest costs in memory and execution speed:

- Each object has its size increased by the amount needed to hold an address.
- For each class, the compiler creates a table (an array) of addresses of virtual functions.
- For each function call, there's an extra step of going to a table to look up an address.

Keep in mind that although nonvirtual functions are slightly more efficient than virtual functions, they don't provide dynamic binding.

## Things to Know About Virtual Methods

We've already discussed the main points about virtual methods:

- Beginning a class method declaration with the keyword `virtual` in a base class makes the function virtual for the base class and all classes derived from the base class, including classes derived from the derived classes, and so on.
- If a virtual method is invoked by using a reference to an object or by using a pointer to an object, the program uses the method defined for the object type rather than the method defined for the reference or pointer type. This is called *dynamic, or late, binding*. This behavior is important because it's always valid for a base-class pointer or reference to refer to an object of a derived type.
- If you're defining a class that will be used as a base class for inheritance, you should declare as virtual functions the class methods that may have to be redefined in derived classes.

There are several other things you may need to know about virtual methods, some of which have been mentioned in passing already. Let's look at them next.

## Constructors

Constructors can't be virtual. Creating a derived object invokes a derived-class constructor, not a base-class constructor. The derived-class constructor then uses a base-class constructor, but this sequence is distinct from the inheritance mechanism. Thus, a derived class doesn't inherit the base-class constructors, so usually there's not much point to making them virtual, anyway.

## Destructors

Destructors should be virtual unless a class isn't to be used as a base class. For example, suppose `Employee` is a base class and `Singer` is a derived class that adds a `char *` member

that points to memory allocated by `new`. Then, when a `Singer` object expires, it's vital that the `~Singer()` destructor be called to free that memory.

Now consider the following code:

```
Employee * pe = new Singer; // legal because Employee is base for Singer
...
delete pe;                // ~Employee() or ~Singer()?
```

If the default static binding applies, the `delete` statement invokes the `~Employee()` destructor. This frees memory pointed to by the `Employee` components of the `Singer` object but not memory pointed to by the new class members. However, if the destructors are virtual, the same code invokes the `~Singer()` destructor, which frees memory pointed to by the `Singer` component, and then calls the `~Employee()` destructor to free memory pointed to by the `Employee` component.

Note that this implies that even if a base class doesn't require the services of an explicit destructor, you shouldn't rely on the default constructor. Instead, you should provide a virtual destructor, even if it has nothing to do:

```
virtual ~BaseClass() { }
```

By the way, it's not an error for a class to have a virtual destructor even if it is not intended to be a base class; it's just a matter of efficiency.

### Tip

Normally, you should provide a base class with a virtual destructor even if the class doesn't need a destructor.

### Friends

Friends can't be virtual functions because friends are not class members, and only members can be virtual functions. If this poses a problem for a design, you might be able to sidestep it by having the friend function use virtual member functions internally.

### No Redefinition

If a derived class fails to redefine a function (virtual or not), the class will use the base class version of the function. If a derived class is part of a long chain of derivations, it will use the most recently defined version of the function. The exception is if the base versions are hidden, as described next.

### Redefinition Hides Methods

Suppose you create something like the following:

```
class Dwelling
{
public:
    virtual void showperks(int a) const;
    ...
};
class Hovel : public Dwelling
```

```

{
public:
    virtual void showperks() const;
...
};

```

This causes a problem. You might get a compiler warning similar to the following:

```
Warning: Hovel::showperks(void) hides Dwelling::showperks(int)
```

Or perhaps you won't get a warning. Either way, the code has the following implications:

```

Hovel trump;
trump.showperks();      // valid
trump.showperks(5);    // invalid

```

The new definition defines a `showperks()` function that takes no arguments. Rather than resulting in two overloaded versions of the function, this redefinition *hides* the base class version that takes an `int` argument. In short, redefining inherited methods is not a variation of overloading. If you redefine a function in a derived class, it doesn't just override the base class declaration with the same function signature. Instead, it hides *all* base-class methods of the same name, regardless of the argument signatures.

This fact of life leads to a couple rules of thumb. First, if you redefine an inherited method, you need to make sure you match the original prototype exactly. One relatively new exception to this rule is that a return type that is a reference or pointer to a base class can be replaced by a reference or pointer to the derived class. This feature is termed *covariance of return type* because the return type is allowed to vary in parallel with the class type:

```

class Dwelling
{
public:
// a base method
    virtual Dwelling & build(int n);
    ...
};
class Hovel : public Dwelling
{
public:
// a derived method with a covariant return type
    virtual Hovel & build(int n); // same function signature
    ...
};

```

Note that this exception applies only to return values, not to arguments.

Second, if the base class declaration is overloaded, you need to redefine all the base-class versions in the derived class:

```

class Dwelling
{
public:
// three overloaded showperks()
    virtual void showperks(int a) const;
    virtual void showperks(double x) const;
    virtual void showperks() const;
    ...
};
class Hovel : public Dwelling
{
public:
// three redefined showperks()
    virtual void showperks(int a) const;
    virtual void showperks(double x) const;
    virtual void showperks() const;
    ...
};

```

If you redefine just one version, the other two become hidden and cannot be used by objects of the derived class. Note that if no change is needed, the redefinition can simply call the base-class version:

```
void Hovel::showperks() const {Dwelling::showperks();}
```

## Access Control: protected

So far the class examples in this book have used the keywords `public` and `private` to control access to class members. There is one more access category, denoted with the keyword `protected`. The `protected` keyword is like `private` in that the outside world can access class members in a `protected` section only by using public class members. The difference between `private` and `protected` comes into play only within classes derived from the base class. Members of a derived class can access `protected` members of a base class directly, but they cannot directly access `private` members of the base class. So members in the `protected` category behave like `private` members as far as the outside world is concerned but behave like `public` members as far as derived classes are concerned.

For example, suppose the `Brass` class declared the `balance` member as `protected`:

```

class Brass
{
protected:
    double balance;
    ...
};

```

In this case, the `BrassPlus` class could access `balance` directly without using `Brass` methods. For example, the core of `BrassPlus::Withdraw()` could be written this way:



```

void BrassPlus::Withdraw(double amt)
{
    if (amt < 0)
        cout << "Withdrawal amount must be positive; "
                << "withdrawal canceled.\n";
    else if (amt <= balance)           // access balance directly
        balance -= amt;
    else if (amt <= balance + maxLoan - owesBank)
    {
        double advance = amt - balance;
        owesBank += advance * (1.0 + rate);
        cout << "Bank advance: $" << advance << endl;
        cout << "Finance charge: $" << advance * rate << endl;
        Deposit(advance);
        balance -= amt;
    }
    else
        cout << "Credit limit exceeded. Transaction cancelled.\n";
}

```

Using protected data members may simplify writing the code, but it has a design defect. For example, continuing with the `BrassPlus` example, if `balance` were protected, you could write code like this:

```

void BrassPlus::Reset(double amt)
{
    balance = amt;
}

```

The `Brass` class was designed so that the `Deposit()` and `Withdraw()` interface provides the only means for altering `balance`. But the `Reset()` method essentially makes `balance` a public variable as far as `BrassPlus` objects are concerned, ignoring, for example, the safeguards found in `Withdraw()`.

### Caution

You should prefer private to protected access control for class data members, and you should use base-class methods to provide derived classes access to base-class data.

However, protected access control can be quite useful for member functions, giving derived classes access to internal functions that are not available publicly.

## Abstract Base Classes

So far you've seen simple inheritance and the more intricate polymorphic inheritance. The next step in increasing sophistication is the abstract base class (ABC). Let's look at some programming situations that provide the background for ABCs.

Sometimes applying the *is-a* rule is not as simple as it might appear. Suppose, for example, you are developing a graphics program that is supposed to represent, among other things, circles and ellipses. A circle is a special case of an ellipse: It's an ellipse whose long axis is the same as its short axis. Therefore, all circles are ellipses, and it is tempting to derive a `Circle` class from an `Ellipse` class. But when you get to the details, you may find problems.

To see this, first consider what you might include as part of an `Ellipse` class. Data members could include the coordinates of the center of the ellipse, the semimajor axis (half the long diameter), the semiminor axis (half the short diameter), and an orientation angle that gives the angle from the horizontal coordinate axis to the semimajor axis. Also the class could include methods to move the ellipse, to return the area of the ellipse, to rotate the ellipse, and to scale the semimajor and semiminor axes:

```
class Ellipse
{
private:
    double x;      // x-coordinate of the ellipse's center
    double y;      // y-coordinate of the ellipse's center
    double a;      // semimajor axis
    double b;      // semiminor axis
    double angle; // orientation angle in degrees
    ...
public:
    ...
    void Move(int nx, ny) { x = nx; y = ny; }
    virtual double Area() const { return 3.14159 * a * b; }
    virtual void Rotate(double nang) { angle += nang; }
    virtual void Scale(double sa, double sb) { a *= sa; b *= sb; }
    ...
};
```

Now suppose you derive a `Circle` class from the `Ellipse` class:

```
class Circle : public Ellipse
{
    ...
};
```

Although a circle is an ellipse, this derivation is awkward. For example, a circle needs only a single value, its radius, to describe its size and shape instead of having a semimajor axis (*a*) and semiminor axis (*b*). The `Circle` constructors can take care of that by assigning the same value to both the *a* and *b* members, but then you have redundant representation of the same information. The `angle` parameter and the `Rotate()` method don't really make sense for a circle, and the `Scale()` method, as it stands, can change a circle to a non-circle by scaling the two axes differently. You can try fixing things with tricks, such as putting a redefined `Rotate()` method in the private section of the `Circle` class so that

`Rotate()` can't be used publicly with a circle, but, on the whole, it seems simpler to define a `Circle` class without using inheritance:

```
class Circle      // no inheritance
{
private:
    double x;     // x-coordinate of the circle's center
    double y;     // y-coordinate of the circle's center
    double r;     // radius
    ...
public:
    ...
    void Move(int nx, ny) { x = nx; y = ny; }
    double Area() const { return 3.14159 * r * r; }
    void Scale(double sr) { r *= sr; }
    ...
};
```

Now the class has only the members it needs. Yet this solution also seems weak. The `Circle` and `Ellipse` classes have a lot in common, but defining them separately ignores that fact.

There is another solution: You can abstract from the `Ellipse` and `Circle` classes what they have in common and place those features in an `ABC`. Next, you derive both the `Circle` and `Ellipse` classes from the `ABC`. Then, for example, you can use an array of base-class pointers to manage a mixture of `Ellipse` and `Circle` objects—that is, you can use a polymorphic approach. In this case, what the two classes have in common are the coordinates of the center of the shape; a `Move()` method, which is the same for both; and an `Area()` method, which works differently for the two classes. Indeed, the `Area()` method can't even be implemented for the `ABC` because it doesn't have the necessary data members. C++ has a way to provide an unimplemented function by using a *pure virtual function*. A pure virtual function has `= 0` at the end of its declaration, as shown for the `Area()` method:

```
class BaseEllipse // abstract base class
{
private:
    double x;     // x-coordinate of center
    double y;     // y-coordinate of center
    ...
public:
    BaseEllipse(double x0 = 0, double y0 = 0) : x(x0), y(y0) {}
    virtual ~BaseEllipse() {}
    void Move(int nx, ny) { x = nx; y = ny; }
    virtual double Area() const = 0; // a pure virtual function
    ...
}
```

When a class declaration contains a pure virtual function, you can't create an object of that class. The idea is that classes with pure virtual functions exist solely to serve as base classes. For a class to be a genuine ABC, it has to have at least one pure virtual function. It is the `= 0` in the prototype that makes a virtual function a pure virtual function. In the case of the `Area()` method, the function has no definition, but C++ allows even a pure virtual function to have a definition. For example, perhaps all the base methods are like `Move()` in that they can be defined for the base class, but you still need to make the class abstract. You could then make the prototype virtual:

```
void Move(int nx, ny) = 0;
```

This makes the base class abstract. But then you could still provide a definition in the implementation file:

```
void BaseEllipse::Move(int nx, ny) { x = nx; y = ny; }
```

In short, the `= 0` in the prototype indicates that the class is an abstract base class and that the class doesn't necessarily have to define the function.

Now you can derive the `Ellipse` class and `Circle` class from the `BaseEllipse` class, adding the members needed to complete each class. One point to note is that the `Circle` class always represents circles, whereas the `Ellipse` class represents ellipses that can also be circles. However, an `Ellipse` class circle can be rescaled to a non-circle, whereas a `Circle` class circle must remain a circle.

A program using these classes would be able to create `Ellipse` objects and `Circle` objects but no `BaseEllipse` objects. Because `Circle` and `Ellipse` objects have the same base class, a collection of such objects can be managed with an array of `BaseEllipse` pointers. Classes such as `Circle` and `Ellipse` are sometimes termed *concrete* classes to indicate that you can create objects of those types.

In short, an ABC describes an interface that uses at least one pure virtual function, and classes derived from an ABC use regular virtual functions to implement the interface in terms of the properties of the particular derived class.

## Applying the ABC Concept

You'd probably like to see a complete example of an ABC, so let's apply the concept to representing the `Brass` and `BrassPlus` accounts, starting with an ABC called `AcctABC`. This class should contain all methods and data members that are common to both the `Brass` and the `BrassPlus` classes. The methods that are to work differently for the `BrassPlus` class than they do for the `Brass` class should be declared as virtual functions. At least one virtual function should be a pure virtual function in order to make the `AcctABC` class abstract.

Listing 13.11 is a header file that declares the `AcctABC` class (an ABC) and the `Brass` and `BrassPlus` classes (both concrete classes). To facilitate derived class access to base class data, `AcctABC` provides some protected methods. Recall that protected methods are methods that derived-class methods can call but that are not part of the public interface for derived-class objects. `AcctABC` also provides a protected member function to handle the

formatting previously handled by nonmember functions. Also the `AcctABC` class has two pure virtual functions, so it is, indeed, an abstract class.

Listing 13.11 `acctabc.h`

---

```
// acctabc.h -- bank account classes
#ifndef ACCTABC_H_
#define ACCTABC_H_
#include <iostream>
#include <string>

// Abstract Base Class
class AcctABC
{
private:
    std::string fullName;
    long acctNum;
    double balance;
protected:
    struct Formatting
    {
        std::ios_base::fmtflags flag;
        std::streamsize pr;
    };
    const std::string & FullName() const {return fullName;}
    long AcctNum() const {return acctNum;}
    Formatting SetFormat() const;
    void Restore(Formatting & f) const;
public:
    AcctABC(const std::string & s = "Nullbody", long an = -1,
            double bal = 0.0);
    void Deposit(double amt) ;
    virtual void Withdraw(double amt) = 0; // pure virtual function
    double Balance() const {return balance;};
    virtual void ViewAcct() const = 0;    // pure virtual function
    virtual ~AcctABC() {}
};

// Brass Account Class
class Brass :public AcctABC
{
public:
    Brass(const std::string & s = "Nullbody", long an = -1,
          double bal = 0.0) : AcctABC(s, an, bal) { }
    virtual void Withdraw(double amt);
    virtual void ViewAcct() const;
    virtual ~Brass() {}
};
```

```
//Brass Plus Account Class
class BrassPlus : public AcctABC
{
private:
    double maxLoan;
    double rate;
    double owesBank;
public:
    BrassPlus(const std::string & s = "Nullbody", long an = -1,
              double bal = 0.0, double ml = 500,
              double r = 0.10);
    BrassPlus(const Brass & ba, double ml = 500, double r = 0.1);
    virtual void ViewAcct()const;
    virtual void Withdraw(double amt);
    void ResetMax(double m) { maxLoan = m; }
    void ResetRate(double r) { rate = r; };
    void ResetOwes() { owesBank = 0; }
};
#endif
```

---

The next step is to implement the methods that don't already have inline definitions. Listing 13.12 does that.

#### Listing 13.12 **acctabc.cpp**

---

```
// acctabc.cpp -- bank account class methods
#include <iostream>
#include "acctabc.h"
using std::cout;
using std::ios_base;
using std::endl;
using std::string;

// Abstract Base Class
AcctABC::AcctABC(const string & s, long an, double bal)
{
    fullName = s;
    acctNum = an;
    balance = bal;
}

void AcctABC::Deposit(double amt)
{
    if (amt < 0)
        cout << "Negative deposit not allowed; "
              << "deposit is cancelled.\n";
```

```

        else
            balance += amt;
    }

void AcctABC::Withdraw(double amt)
{
    balance -= amt;
}

// protected methods for formatting
AcctABC::Formatting AcctABC::SetFormat() const
{
    // set up ###.## format
    Formatting f;
    f.flag =
        cout.setf(ios_base::fixed, ios_base::floatfield);
    f.pr = cout.precision(2);
    return f;
}

void AcctABC::Restore(Formatting & f) const
{
    cout.setf(f.flag, ios_base::floatfield);
    cout.precision(f.pr);
}

// Brass methods
void Brass::Withdraw(double amt)
{
    if (amt < 0)
        cout << "Withdrawal amount must be positive; "
            << "withdrawal canceled.\n";
    else if (amt <= Balance())
        AcctABC::Withdraw(amt);
    else
        cout << "Withdrawal amount of $" << amt
            << " exceeds your balance.\n"
            << "Withdrawal canceled.\n";
}

void Brass::ViewAcct() const
{
    Formatting f = SetFormat();
    cout << "Brass Client: " << FullName() << endl;
    cout << "Account Number: " << AcctNum() << endl;
}

```

```
    cout << "Balance: $" << Balance() << endl;
    Restore(f);
}

// BrassPlus Methods
BrassPlus::BrassPlus(const string & s, long an, double bal,
                    double ml, double r) : AcctABC(s, an, bal)
{
    maxLoan = ml;
    owesBank = 0.0;
    rate = r;
}

BrassPlus::BrassPlus(const Brass & ba, double ml, double r)
    : AcctABC(ba) // uses implicit copy constructor
{
    maxLoan = ml;
    owesBank = 0.0;
    rate = r;
}

void BrassPlus::ViewAcct() const
{
    Formatting f = SetFormat();

    cout << "BrassPlus Client: " << FullName() << endl;
    cout << "Account Number: " << AcctNum() << endl;
    cout << "Balance: $" << Balance() << endl;
    cout << "Maximum loan: $" << maxLoan << endl;
    cout << "Owed to bank: $" << owesBank << endl;
    cout.precision(3);
    cout << "Loan Rate: " << 100 * rate << "%\n";
    Restore(f);
}

void BrassPlus::Withdraw(double amt)
{
    Formatting f = SetFormat();

    double bal = Balance();
    if (amt <= bal)
        AcctABC::Withdraw(amt);
    else if (amt <= bal + maxLoan - owesBank)
    {
        double advance = amt - bal;
        owesBank += advance * (1.0 + rate);
    }
}
```



```

        cout << "Bank advance: $" << advance << endl;
        cout << "Finance charge: $" << advance * rate << endl;
        Deposit(advance);
        AcctABC::Withdraw(amt);
    }
    else
        cout << "Credit limit exceeded. Transaction cancelled.\n";
    Restore(f);
}

```

---

The `FullName()` and `AcctNum()` protected methods provide read-only access to the `fullName` and `acctNum` data members and make it possible to customize `ViewAcct()` a little more individually for each derived class.

This version makes a couple of improvements in the implementation of the formatting. The previous version used two function calls to set the formatting and one to restore it:

```

format initialState = setFormat();
precis prec = cout.precision(2);
...
restore(initialState, prec); // restore original format

```

The new version defines a structure to hold the two formatting values and uses that structure to set and restore formats with just two calls:

```

struct Formatting
{
    std::ios_base::fmtflags flag;
    std::streamsize pr;
};
...
Formatting f = SetFormat();
...
Restore(f);

```

It's a neater look.

A problem with the older version was that the original `setFormat()` and `restore()` were standalone functions, so those function names would conflict with client-defined functions of the same name. There are several ways to solve that problem. One is to declare both functions `static`, making them private to the `brass.cpp` file or to its successor, `acctabc.cpp`. A second is to place both functions and the `struct Formatting` definition into a namespace. But one of the topics for this example is protected access, so this example places the structure definition and the functions in the protected part of the class definition. This makes them available to the base class and the derived class while hiding them from the outside world.

This new implementation of the `Brass` and `BrassPlus` accounts can be used in the same manner as the old one because the class methods have the same names and interfaces as before. For example, to convert Listing 13.10 to use the new implementation, you just need to take these steps to convert `usebrass2.cpp` to a `usebrass3.cpp` file:

- Link `usebrass2.cpp` with `acctabc.cpp` instead of with `brass.cpp`.
- Include `acctabc.h` instead of `brass.h`.
- Replace

```
Brass * p_clients[CLIENTS];
```

with

```
AcctABC * p_clients[CLIENTS];
```

Listing 13.13 shows the resulting file, renamed `usebrass3.cpp`.

#### Listing 13.13 `usebrass3.cpp`

---

```
// usebrass3.cpp -- polymorphic example using an abstract base class
// compile with acctabc.cpp
#include <iostream>
#include <string>
#include "acctabc.h"
const int CLIENTS = 4;

int main()
{
    using std::cin;
    using std::cout;
    using std::endl;

    AcctABC * p_clients[CLIENTS];
    std::string temp;
    long tempnum;
    double tempbal;
    char kind;

    for (int i = 0; i < CLIENTS; i++)
    {
        cout << "Enter client's name: ";
        getline(cin,temp);
        cout << "Enter client's account number: ";
        cin >> tempnum;
        cout << "Enter opening balance: $";
        cin >> tempbal;
        cout << "Enter 1 for Brass Account or "
            << "2 for BrassPlus Account: ";
```

```

while (cin >> kind && (kind != '1' && kind != '2'))
    cout <<"Enter either 1 or 2: ";
if (kind == '1')
    p_clients[i] = new Brass(temp, tempnum, tempbal);
else
{
    double tmax, trate;
    cout << "Enter the overdraft limit: $";
    cin >> tmax;
    cout << "Enter the interest rate "
        << "as a decimal fraction: ";
    cin >> trate;
    p_clients[i] = new BrassPlus(temp, tempnum, tempbal,
                                tmax, trate);
}
while (cin.get() != '\n')
    continue;
}
cout << endl;
for (int i = 0; i < CLIENTS; i++)
{
    p_clients[i]->ViewAcct();
    cout << endl;
}

for (int i = 0; i < CLIENTS; i++)
{
    delete p_clients[i]; // free memory
}
cout << "Done.\n";

return 0;
}

```

---

The program itself behaves the same as the non-abstract base class version, so given the same input as for Listing 13.10, the output would be the same.

## ABC Philosophy

The ABC methodology is a much more systematic, disciplined way to approach inheritance than the more ad hoc, spur-of-the-moment approach used by the `RatedPlayer` example. Before designing an ABC, you first have to develop a model of what classes are needed to represent a programming problem and how they relate to one another. One school of thought holds that if you design an inheritance hierarchy of classes, the only concrete classes should be those that never serve as a base class. This approach tends to produce cleaner designs with fewer complications.

One way of thinking about ABCs is to consider them an enforcement of interface. An ABC demands that its pure virtual functions be overridden in any concrete derived classes—forcing the derived class to obey the rules of interface the ABC has set. This model is common in component-based programming paradigms, in which the use of ABCs allows the component designer to create an “interface contract” where all components derived from the ABC are guaranteed to uphold *at least* the common functionality specified by the ABC.

## Inheritance and Dynamic Memory Allocation

How does inheritance interact with dynamic memory allocation (the use of `new` and `delete`)? For example, if a base class uses dynamic memory allocation and redefines assignment and a copy constructor, how does that affect the implementation of the derived class? The answer depends on the nature of the derived class. If the derived class does not itself use dynamic memory allocation, you needn't take any special steps. If the derived class does also use dynamic memory allocation, then there are a couple new tricks to learn. Let's look at these two cases.

### Case 1: Derived Class Doesn't Use `new`

Suppose you begin with the following base class that uses dynamic memory allocation:

```
// Base Class Using DMA
class baseDMA
{
private:
    char * label;
    int rating;

public:
    baseDMA(const char * l = "null", int r = 0);
    baseDMA(const baseDMA & rs);
    virtual ~baseDMA();
    baseDMA & operator=(const baseDMA & rs);
    ...
};
```

The declaration contains the special methods that are required when constructors use `new`: a destructor, a copy constructor, and an overloaded assignment operator.

Now suppose you derive a `lackDMA` class from `baseDMA` and that `lackDMA` does not use `new` or have other unusual design features that require special treatment:

```
// derived class without DMA
class lacksDMA :public baseDMA
{
private:
    char color[40];
```

```
public:
...
};
```

Do you now have to define an explicit destructor, copy constructor, and assignment operator for the `lackDMA` class? The answer is no.

First, consider the need for a destructor. If you don't define one, the compiler defines a default destructor that does nothing. Actually, the default destructor for a derived class always does something; it calls the base-class destructor after executing its own code. Because the `lackDMA` members, we assume, don't require any special action, the default destructor is fine.

Next, consider the copy constructor. As you saw in Chapter 12, the default copy constructor does memberwise copying, which is inappropriate for dynamic memory allocation. However, memberwise copying is fine for the new `lackSDMA` member. That leaves the matter of the inherited `baseDMA` object. What you need to know is that memberwise copying uses the form of copying that is defined for the data type in question. So copying a `long` to a `long` is done using ordinary assignment. But copying a class member or an inherited class component is done using the copy constructor for that class. Thus, the default copy constructor for the `lackSDMA` class uses the explicit `baseDMA` copy constructor to copy the `baseDMA` portion of a `lackSDMA` object. So the default copy constructor is fine for the new `lackSDMA` member, and it's also fine for the inherited `baseDMA` object.

Essentially the same situation holds for assignment. The default assignment operator for a class automatically uses the base-class assignment operator for the base-class component. So it, too, is fine.

These properties of inherited objects also hold true for class members that are themselves objects. For example, Chapter 10, "Objects and Classes," implements the `stock` class by using a `string` object to represent the company name. The standard `string` class, like our `String` example, uses dynamic memory allocation. Now you see why this wouldn't create problems. The default `stock` copy constructor would use the `string` copy constructor to copy the `company` member of an object, the default `stock` assignment operator would use the `string` assignment operator to assign the `company` member of an object, and the `stock` destructor (default or otherwise) would automatically call the `string` destructor.

## Case 2: Derived Class Does Use `new`

Suppose that the derived class uses `new`:

```
// derived class with DMA
class hasDMA :public baseDMA
{
private:
    char * style; // use new in constructors
public:
...
};
```

In this case, of course, you do have to define an explicit destructor, copy constructor, and assignment operator for the derived class. Let's consider these methods in turn.

A derived class destructor automatically calls the base-class destructor, so its own responsibility is to clean up after what the derived-class constructors do. Thus, the `hasDMA` destructor has to free the memory managed by the `style` pointer and can rely on the `baseDMA` destructor to free the memory managed by the `label` pointer:

```
baseDMA::~~baseDMA() // takes care of baseDMA stuff
{
    delete [] label;
}

hasDMA::~~hasDMA() // takes care of hasDMA stuff
{
    delete [] style;
}
```

Next, consider copy constructors. The `baseDMA` copy constructor follows the usual pattern for arrays of `char`. That is, they use `strlen()` to find the length needed to hold the C-style string, allocate sufficient memory (the number of characters plus one byte for the null character), and use the `strcpy()` function to copy the original string to the target:

```
baseDMA::baseDMA(const baseDMA & rs)
{
    label = new char[std::strlen(rs.label) + 1];
    std::strcpy(label, rs.label);
    rating = rs.rating;
}
```

The `hasDMA` copy constructor only has access to `hasDMA` data, so it must invoke the `baseDMA` copy constructor to handle the `baseDMA` share of the data:

```
hasDMA::hasDMA(const hasDMA & hs)
    : baseDMA(hs)
{
    style = new char[std::strlen(hs.style) + 1];
    std::strcpy(style, hs.style);
}
```

The point to note is that the member initializer list passes a `hasDMA` reference to a `baseDMA` constructor. There is no `baseDMA` constructor with a type `hasDMA` reference parameter, but none is needed. That's because the `baseDMA` copy constructor has a `baseDMA` reference parameter, and a base class reference can refer to a derived type. Thus, the `baseDMA` copy constructor uses the `baseDMA` portion of the `hasDMA` argument to construct the `baseDMA` portion of the new object.

Next, consider assignment operators. The `baseDMA` assignment operator follows the usual pattern:

```
baseDMA & baseDMA::operator=(const baseDMA & rs)
{
    if (this == &rs)
        return *this;
    delete [] label;
    label = new char[std::strlen(rs.label) + 1];
    std::strcpy(label, rs.label);
    rating = rs.rating;
    return *this;
}
```

Because `hasDMA` also uses dynamic memory allocation, it, too, needs an explicit assignment operator. Being a `hasDMA` method, it only has direct access to `hasDMA` data. Nonetheless, an explicit assignment operator for a derived class also has to take care of assignment for the inherited base class `baseDMA` object. You can accomplish this by explicitly calling the base class assignment operator, as shown here:

```
hasDMA & hasDMA::operator=(const hasDMA & hs)
{
    if (this == &hs)
        return *this;
    baseDMA::operator=(hs); // copy base portion
    delete [] style;       // prepare for new style
    style = new char[std::strlen(hs.style) + 1];
    std::strcpy(style, hs.style);
    return *this;
}
```

The following statement might look a little odd:

```
baseDMA::operator=(hs); // copy base portion
```

But using function notation instead of operator notation lets you use the scope-resolution operator. In effect, the statement means the following:

```
*this = hs; // use baseDMA::operator=()
```

But, of course, the compiler ignores comments, so if you used the latter code, the compiler would use `hasDMA::operator=()` instead and create a recursive call. Using function notation gets the correct assignment operator called.

In summary, when both the base class and the derived class use dynamic memory allocation, the derived-class destructor, copy constructor, and assignment operator all must use their base-class counterparts to handle the base-class component. This common requirement is accomplished three different ways. For a destructor, it is done automatically. For a constructor, it is accomplished by invoking the base-class copy constructor in the member initialization list, or else the default constructor is invoked automatically. For the assignment operator, it is accomplished by using the scope-resolution operator in an explicit call of the base-class assignment operator.





```

// derived class with DMA
class hasDMA :public baseDMA
{
private:
    char * style;
public:
    hasDMA(const char * s = "none", const char * l = "null",
           int r = 0);
    hasDMA(const char * s, const baseDMA & rs);
    hasDMA(const hasDMA & hs);
    ~hasDMA();
    hasDMA & operator=(const hasDMA & rs);
    friend std::ostream & operator<<(std::ostream & os,
                                     const hasDMA & rs);
};

#endif

```

---

Listing 13.15 provides the method definitions for the `baseDMA`, `lacksDMA`, and `hasDMA` classes.

#### Listing 13.15 `dma.cpp`

---

```

// dma.cpp --dma class methods

#include "dma.h"
#include <cstring>

// baseDMA methods
baseDMA::baseDMA(const char * l, int r)
{
    label = new char[std::strlen(l) + 1];
    std::strcpy(label, l);
    rating = r;
}

baseDMA::baseDMA(const baseDMA & rs)
{
    label = new char[std::strlen(rs.label) + 1];
    std::strcpy(label, rs.label);
    rating = rs.rating;
}

baseDMA::~baseDMA()
{
    delete [] label;
}

```

```

baseDMA & baseDMA::operator=(const baseDMA & rs)
{
    if (this == &rs)
        return *this;
    delete [] label;
    label = new char[std::strlen(rs.label) + 1];
    std::strcpy(label, rs.label);
    rating = rs.rating;
    return *this;
}

std::ostream & operator<<(std::ostream & os, const baseDMA & rs)
{
    os << "Label: " << rs.label << std::endl;
    os << "Rating: " << rs.rating << std::endl;
    return os;
}

// lacksDMA methods
lacksDMA::lacksDMA(const char * c, const char * l, int r)
    : baseDMA(l, r)
{
    std::strncpy(color, c, 39);
    color[39] = '\0';
}

lacksDMA::lacksDMA(const char * c, const baseDMA & rs)
    : baseDMA(rs)
{
    std::strncpy(color, c, COL_LEN - 1);
    color[COL_LEN - 1] = '\0';
}

std::ostream & operator<<(std::ostream & os, const lacksDMA & ls)
{
    os << (const baseDMA &) ls;
    os << "Color: " << ls.color << std::endl;
    return os;
}

// hasDMA methods
hasDMA::hasDMA(const char * s, const char * l, int r)
    : baseDMA(l, r)
{
    style = new char[std::strlen(s) + 1];
    std::strcpy(style, s);
}

```

```

hasDMA::hasDMA(const char * s, const baseDMA & rs)
    : baseDMA(rs)
{
    style = new char[std::strlen(s) + 1];
    std::strcpy(style, s);
}

hasDMA::hasDMA(const hasDMA & hs)
    : baseDMA(hs) // invoke base class copy constructor
{
    style = new char[std::strlen(hs.style) + 1];
    std::strcpy(style, hs.style);
}

hasDMA::~hasDMA()
{
    delete [] style;
}

hasDMA & hasDMA::operator=(const hasDMA & hs)
{
    if (this == &hs)
        return *this;
    baseDMA::operator=(hs); // copy base portion
    delete [] style; // prepare for new style
    style = new char[std::strlen(hs.style) + 1];
    std::strcpy(style, hs.style);
    return *this;
}

std::ostream & operator<<(std::ostream & os, const hasDMA & hs)
{
    os << (const baseDMA &) hs;
    os << "Style: " << hs.style << std::endl;
    return os;
}

```

---

The new feature to note in Listings 13.14 and 13.15 is how derived classes can make use of a friend to a base class. Consider, for example, the following friend to the `hasDMA` class:

```

friend std::ostream & operator<<(std::ostream & os,
                                const hasDMA & rs);

```

Being a friend to the `hasDMA` class gives this function access to the `style` member. But there's a problem: This function is not a friend to the `baseDMA` class, so how can it access the `label` and `rating` members? The solution is to use the `operator<<()` function that

is a friend to the `baseDMA` class. The next problem is that because friends are not member functions, you can't use the scope-resolution operator to indicate which function to use. The solution to this problem is to use a type cast so that prototype matching will select the correct function. Thus, the code type casts the type `const hasDMA &` parameter to a type `const baseDMA &` argument:

```
std::ostream & operator<<(std::ostream & os, const hasDMA & hs)
{
// type cast to match operator<<(ostream & , const baseDMA &)
  os << (const baseDMA &) hs;
  os << "Style: " << hs.style << endl;
  return os;
}
```

Listing 13.16 tests the `baseDMA`, `lacksDMA`, and `hasDMA` classes in a short program.

#### Listing 13.16 `usedma.cpp`

---

```
// usedma.cpp -- inheritance, friends, and DMA
// compile with dma.cpp
#include <iostream>
#include "dma.h"
int main()
{
  using std::cout;
  using std::endl;

  baseDMA shirt("Portabelly", 8);
  lacksDMA balloon("red", "Blimpo", 4);
  hasDMA map("Mercator", "Buffalo Keys", 5);
  cout << "Displaying baseDMA object:\n";
  cout << shirt << endl;
  cout << "Displaying lacksDMA object:\n";
  cout << balloon << endl;
  cout << "Displaying hasDMA object:\n";
  cout << map << endl;
  lacksDMA balloon2(balloon);
  cout << "Result of lacksDMA copy:\n";
  cout << balloon2 << endl;
  hasDMA map2;
  map2 = map;
  cout << "Result of hasDMA assignment:\n";
  cout << map2 << endl;
  return 0;
}
```

---

Here's the output of the program in Listings 13.14, 13.15, and 13.16:

```
Displaying baseDMA object:
Label: Portabelly
Rating: 8

Displaying lacksDMA object:
Label: Blimpo
Rating: 4
Color: red

Displaying hasDMA object:
Label: Buffalo Keys
Rating: 5
Style: Mercator

Result of lacksDMA copy:
Label: Blimpo
Rating: 4
Color: red

Result of hasDMA assignment:
Label: Buffalo Keys
Rating: 5
Style: Mercator
```

## Class Design Review

C++ can be applied to a wide variety of programming problems, and you can't reduce class design to some paint-by-numbers routine. However, there are some guidelines that often apply, and this is as good a time as any to go over them by reviewing and amplifying earlier discussions.

### Member Functions That the Compiler Generates for You

As first discussed in Chapter 12, the compiler automatically generates certain public member functions, termed *special member functions*. The fact that it does so suggests that these special member functions are particularly important. Let's look again at some of them now.

#### Default Constructors

A default constructor is one that has no arguments, or else one for which all the arguments have default arguments. If you don't define any constructors, the compiler defines a default constructor for you. Its existence allows you to create objects. For example, suppose `Star` is a class. You need a default constructor to use the following:

```
Star rigel;           // create an object without explicit initialization
Star pleiades[6];    // create an array of objects
```

One more thing an automatic default constructor does is call the default constructors for any base classes and for any members that are objects of another class.

Also if you write a derived-class constructor without explicitly invoking a base-class constructor in the member initializer list, the compiler uses the base class default constructor to construct the base class portion of the new object. If there is no base-class default constructor, you get a compile-time error in this situation.

If you define a constructor of any kind, the compiler does not define a default constructor for you. In that case, it's up to you to provide a default constructor if one is needed.

Note that one of the motivations for having constructors is to ensure that objects are always properly initialized. Also if a class has any pointer members, they certainly should be initialized. Thus, it's a good idea to supply an explicit default constructor that initializes all class data members to reasonable values.

## Copy Constructors

A copy constructor for a class is a constructor that takes an object of the class type as its argument. Typically, the declared parameter is a constant reference to the class type. For example, the copy constructor for a `Star` class would have this prototype:

```
Star(const Star &);
```

A class copy constructor is used in the following situations:

- When a new object is initialized to an object of the same class
- When an object is passed to a function by value
- When a function returns an object by value
- When the compiler generates a temporary object

If a program doesn't use a copy constructor (explicitly or implicitly), the compiler provides a prototype but not a function definition. Otherwise, the program defines a copy constructor that performs memberwise initialization. That is, each member of the new object is initialized to the value of the corresponding member of the original object. If a member is itself a class object, then memberwise initialization uses the copy constructor defined for that particular class.

In some cases, memberwise initialization is undesirable. For example, member pointers initialized with `new` generally require that you institute deep copying, as with the `baseDMA` class example. Or a class may have a static variable that needs to be modified. In such cases, you need to define your own copy constructor.

## Assignment Operators

A default assignment operator handles assigning one object to another object of the same class. Don't confuse assignment with initialization. If a statement creates a new object, it's using initialization, and if a statement alters the value of an existing object, it's assignment:

```

Star sirius;
Star alpha = sirius;    // initialization (one notation)
Star dogstar;
dogstar = sirius;      // assignment

```

Default assignment uses memberwise assignment. If a member is itself a class object, then default memberwise assignment uses the assignment operator defined for that particular class. If you need to define a copy constructor explicitly, you also need, for the same reasons, to define the assignment operator explicitly. The prototype for a `Star` class assignment operator is this:

```
Star & Star::operator=(const Star &);
```

Note that the assignment operator function returns a reference to a `Star` object. The `baseDMA` class shows a typical example of an explicit assignment operator function.

The compiler doesn't generate assignment operators for assigning one type to another. Suppose you want to be able to assign a string to a `Star` object. One approach is to define such an operator explicitly:

```
Star & Star::operator=(const char *) {...}
```

A second approach is to rely on a conversion function (see "Conversion Considerations" in the next section) to convert a string to a `Star` object and use the `Star`-to-`Star` assignment function. The first approach runs more quickly but requires more code. The conversion function approach can lead to compiler-befuddling situations.

Chapter 18, "Visiting with the New C++ Standard," discusses two more special methods added by C++11: the move constructor and the move assignment operator.

## Other Class Method Considerations

There are several other points to keep in mind as you define a class. The following sections list some of them.

### Constructor Considerations

Constructors are different from other class methods in that they create new objects, whereas other methods are invoked by existing objects. This is one reason constructors aren't inherited. Inheritance means a derived object can use a base-class method, but, in the case of constructors, the object doesn't exist until after the constructor has done its work.

### Destructor Considerations

You need to remember to define an explicit destructor that deletes any memory allocated by `new` in the class constructors and takes care of any other special bookkeeping that destroying a class object requires. If the class is to be used as a base class, you should provide a virtual destructor even if the class doesn't require a destructor.

## Conversion Considerations

Any constructor that can be invoked with exactly one argument defines conversion from the argument type to the class type. For example, consider the following constructor prototypes for a `Star` class:

```
Star(const char *); // converts char * to Star
Star(const Spectral &, int members = 1); // converts Spectral to Star
```

Conversion constructors are used, for example, when a convertible type is passed to a function that is defined as taking a `Star` argument. For instance, suppose you have the following:

```
Star north;
north = "polaris";
```

The second statement would invoke the `Star::operator=(const Star &)` function, using `Star::Star(const char *)` to generate a `Star` object to be used as an argument for the assignment operator function. This assumes that you haven't defined a `(char *)`-to-`Star` assignment operator.

Using `explicit` in the prototype for a one-argument constructor disables implicit conversions but still allows explicit conversions:

```
class Star
{
...
public:
    explicit Star(const char *);
...
};
...
Star north;
north = "polaris"; // not allowed
north = Star("polaris"); // allowed
```

To convert from a class object to some other type, you define a conversion function (see Chapter 11, “Working with Classes”). A conversion function is a class member function with no arguments or declared return type that has the name of the type to be converted to. Despite having no declared return type, the function should return the desired conversion value. Here are some examples:

```
Star::Star double() {...} // converts star to double
Star::Star const char * () {...} // converts to const char
```

You should be judicious with such functions, only using them if they make good sense. Also with some class designs, having conversion functions increases the likelihood of writing ambiguous code. For example, suppose you define a `double` conversion for the `Vector` type of Chapter 11, and suppose you have the following code:

```
Vector ius(6.0, 0.0);
Vector lux = ius + 20.2; // ambiguous
```



The compiler could convert `ius` to `double` and use `double` addition, or else it could convert `20.2` to `vector` (using one of the constructors) and use `vector` addition. Instead, it would do neither and inform you of an ambiguous construction.

C++11 provides the option of using the keyword `explicit` with conversion functions. As with constructors, `explicit` allows explicit conversions using type casts, but disallows implicit conversions.

### Passing an Object by Value Versus Passing a Reference

In general, if you write a function using an object argument, you should pass the object by reference rather than by value. One reason for this is efficiency. Passing an object by value involves generating a temporary copy, which means calling the copy constructor and then later calling the destructor. Calling these functions takes time, and copying a large object can be quite a bit slower than passing a reference. If the function doesn't modify the object, you should declare the argument as a `const` reference.

Another reason for passing objects by reference is that, in the case of inheritance using virtual functions, a function defined as accepting a base-class reference argument can also be used successfully with derived classes, as you saw earlier in this chapter. (Also see the section "Virtual Methods," later in this chapter.)

### Returning an Object Versus Returning a Reference

Some class methods return objects. You've probably noticed that some members return objects directly whereas others return references. Sometimes a method must return an object, but if it isn't necessary, you should use a reference instead. Let's look at this more closely.

First, the only coding difference between returning an object directly and returning a reference is in the function prototype and header:

```
Star nova1(const Star &);    // returns a Star object
Star & nova2(const Star &); // returns a reference to a Star
```

Next, the reason you should return a reference rather than an object is that returning an object involves generating a temporary copy of the returned object. It's the copy that is made available to the calling program. Thus, returning an object involves the time cost of calling a copy constructor to generate the copy and the time cost of calling the destructor to get rid of the copy. Returning a reference saves time and memory use. Returning an object directly is analogous to passing an object by value: Both processes generate temporary copies. Similarly, returning a reference is analogous to passing an object by reference: Both the calling and the called function operate on the same object.

However, it's not always possible to return a reference. A function shouldn't return a reference to a temporary object created in the function because the reference becomes invalid when the function terminates and the object disappears. In this case, the code should return an object in order to generate a copy that will be available to the calling program.

As a rule of thumb, if a function returns a temporary object created in the function, you shouldn't use a reference. For example, the following method uses a constructor to create a new object, and it then returns a copy of that object:

```
Vector Vector::operator+(const Vector & b) const
{
    return Vector(x + b.x, y + b.y);
}
```

If a function returns an object that was passed to it via a reference or pointer, you should return the object by reference. For example, the following code returns, by reference, either the object that invokes the function or else the object passed as an argument:

```
const Stock & Stock::topval(const Stock & s) const
{
    if (s.total_val > total_val)
        return s;           // argument object
    else
        return *this;       // invoking object
}
```

## Using const

You need to be alert to opportunities to use `const`. You can use it to guarantee that a method doesn't modify an argument:

```
Star::Star(const char * s) {...} // won't change the string to which s points
```

You can use `const` to guarantee that a method won't modify the object that invokes it:

```
void Star::show() const {...} // won't change invoking object
```

Here `const` means `const Star * this`, where `this` points to the invoking object.

Normally, a function that returns a reference can be on the left side of an assignment statement, which really means you can assign a value to the object referred to. But you can use `const` to ensure that a reference or pointer return value can't be used to modify data in an object:

```
const Stock & Stock::topval(const Stock & s) const
{
    if (s.total_val > total_val)
        return s;           // argument object
    else
        return *this;       // invoking object
}
```

Here the method returns a reference either to `this` or to `s`. Because `this` and `s` are both declared `const`, the function is not allowed to change them, which means the returned reference also must be declared `const`.

Note that if a function declares an argument as a reference or pointer to a `const`, it cannot pass along that argument to another function unless that function also guarantees not to change the argument.

## Public Inheritance Considerations

Naturally, adding inheritance to a program brings up a number of considerations. Let's look at a few.

### *Is-a* Relationship Considerations

You should be guided by the *is-a* relationship. If your proposed derived class is not a particular kind of the base class, you shouldn't use public derivation. For example, you shouldn't derive a `Programmer` class from a `Brain` class. If you want to represent the belief that a programmer has a brain, you should use a `Brain` class object as a member of the `Programmer` class.

In some cases the best approach may be to create an abstract data class with pure virtual functions and to derive other classes from it.

Remember that one expression of the *is-a* relationship is that a base class pointer can point to a derived-class object and that a base-class reference can refer to a derived-class object without an explicit type cast. Also remember that the reverse is not true; thus, you cannot have a derived-class pointer or reference refer to a base-class object without an explicit type cast. Depending on the class declarations, such an explicit type cast (a down-cast) may or may not make sense. (You might want to review Figure 13.4.)

### What's Not Inherited

Constructors are not inherited. That is, creating a derived object requires calling a derived-class constructor. However, derived-class constructors typically use the member-initializer list syntax to call on base-class constructors to construct the base class portion of a derived object. If the derived-class constructor doesn't explicitly call a base-class constructor by using the member-initializer list syntax, it uses the base class's default constructor. In an inheritance chain, each class can use a member initializer list to pass back information to its immediate base class. C++11 adds a mechanism that enables the inheriting of constructors. However, the default behavior is still that constructors are not inherited.

Destructors are not inherited either. However, when an object is destroyed, the program first calls the derived destructor and then the base destructor. If there is a default base class destructor, the compiler generates a default derived class destructor. Generally speaking, if a class serves as a base class, its destructor should be virtual.

Assignment operators are not inherited. The reason is simple. An inherited method has the same function signature in a derived class as it does in the base class. However, an assignment operator has a function signature that changes from class to class because it has a formal parameter that is the class type. Assignment operators do have some interesting properties, which we'll look at next.

```

class Employee
{
private:
    char name[40];
    ...
public:
    void show_name();
    ...
};
class Singer : public Employee
{
    ...
public:
    void range();
    ...
};
...
Employee veep;
Singer trala;
...
Employee * pe = &trala;
Singer * ps = (Singer *) &veep;
...
pe->show_name();
ps->range();

```

← upcast—implicit type cast allowed  
 ← downcast—explicit type cast required  
 ← Upcasting leads to a safe operation because a Singer is an Employee (every Singer inherits name).  
 ← Downcasting can lead to an unsafe operation because an Employee isn't a Singer (an Employee need not have a range() method).

Figure 13.4 Upcasting and downcasting.

### Assignment Operator Considerations

If the compiler detects that a program assigns one object to another of the same class, it automatically supplies that class with an assignment operator. The default, or implicit, version of this operator uses memberwise assignment, with each member of the target object being assigned the value of the corresponding member of the source object. However, if the object belongs to a derived class, the compiler uses the base-class assignment operator to handle assignment for the base-class portion of the derived-class object. If you've explicitly provided an assignment operator for the base class, that operator is used. Similarly, if a class contains a member that is an object of another class, the assignment operator for that class is used for that member.

As you've seen several times, you need to provide an explicit assignment operator if class constructors use `new` to initialize pointers. Because C++ uses the base-class assignment operator for the base part of derived objects, you don't need to redefine the assignment operator for a derived class *unless* it adds data members that require special care. For example, the `baseDMA` class defines assignment explicitly, but the derived `lackDMA` class uses the implicit assignment operator generated for that class.

Suppose, however, that a derived class does use `new`, and you have to provide an explicit assignment operator. The operator must provide for every member of the class, not just the new members. The `hasDMA` class illustrates how this can be done:

```
hasDMA & hasDMA::operator=(const hasDMA & hs)
{
    if (this == &hs)
        return *this;
    baseDMA::operator=(hs); // copy base portion
    delete [] style;        // prepare for new style
    style = new char[std::strlen(hs.style) + 1];
    std::strcpy(style, hs.style);
    return *this;
}
```

What about assigning a derived-class object to a base-class object? (Note that this is not the same as initializing a base-class reference to a derived-class object.) Take a look at this example:

```
Brass blips; // base class
BrassPlus snips("Rafe Plosh", 91191,3993.19, 600.0, 0.12); // derived class
blips = snips; // assign derived object to base object
```

Which assignment operator is used? Remember that the assignment statement is translated into a method that is invoked by the left-hand object:

```
blips.operator=(snips);
```

Here the left-hand object is a `Brass` object, so it invokes the `Brass::operator=(const Brass &)` function. The *is-a* relationship allows the `Brass` reference to refer to a derived-class object, such as `snips`. The assignment operator only deals with base-class members, so the `maxLoan` member and other `BrassPlus` members of `snips` are ignored in the assignment. In short, you can assign a derived object to a base object, and only the base-class members are involved.

What about the reverse? Can you assign a base-class object to a derived object? Take a look at this example:

```
Brass gp("Griff Hexbait", 21234, 1200); // base class
BrassPlus temp; // derived class
temp = gp; // possible?
```

Here the assignment statement would be translated as follows:

```
temp.operator=(gp);
```

The left-hand object is a `BrassPlus` object, so it invokes the `BrassPlus::operator=(const BrassPlus &)` function. However, a derived-class reference cannot automatically refer to a base-class object, so this code *won't* run unless there is *also* a conversion constructor:

```
BrassPlus(const Brass &);
```

It could be, as is the case for the `BrassPlus` class, that the conversion constructor is a constructor with a base-class argument plus additional arguments, provided that the additional arguments have default values:

```
BrassPlus(const Brass & ba, double ml = 500, double r = 0.1);
```

If there is a conversion constructor, the program uses this constructor to create a temporary `BrassPlus` object from `gp`, which is then used as an argument to the assignment operator.

Alternatively, you could define an assignment operator for assigning a base class to a derived class:

```
BrassPlus & BrassPlus ::operator=(const Brass &) { ... }
```

Here the types match the assignment statement exactly, and no type conversions are needed.

In short, the answer to the question “Can you assign a base-class object to a derived object?” is “Maybe.” You can if the derived class has a constructor that defines the conversion of a base-class object to a derived-class object. And you can if the derived class defines an assignment operator for assigning a base-class object to a derived object. If neither of these two conditions holds, then you can’t make the assignment unless you use an explicit type cast.

## Private Versus Protected Members

Remember that protected members act like public members as far as a derived class is concerned, but they act like private members for the world at large. A derived class can access protected members of a base class directly, but it can access private members only via base-class member functions. Thus, making base-class members private offers more security, whereas making them protected simplifies coding and speeds up access. Stroustrup, in his book *The Design and Evolution of C++*, indicates that it’s better to use private data members than protected data members but that protected methods are useful.

## Virtual Method Considerations

When you design a base class, you have to decide whether to make class methods virtual. If you want a derived class to be able to redefine a method, you define the method as virtual in the base class. This enables late, or dynamic, binding. If you don’t want the method to be redefined, you don’t make it virtual. This doesn’t prevent someone from redefining the method, but it should be interpreted as meaning that you don’t want it redefined.

Note that inappropriate code can circumvent dynamic binding. Consider, for example, the following two functions:

```
void show(const Brass & rba)
{
    rba.ViewAcct();
    cout << endl;
}
```

```
void inadequate(Brass ba)
{
    ba.ViewAcct();
    cout << endl;
}
```

The first function passes an object by reference, and the second passes an object by value. Now show you use each with a derived class argument:

```
BrassPlus buzz("Buzz Parsec", 00001111, 4300);
show(buzz);
inadequate(buzz);
```

The `show()` function call results in the `rba` argument being a reference to the `BrassPlus` object `buzz`, so `rba.ViewAcct()` is interpreted as the `BrassPlus` version, as it should be. But in the `inadequate()` function, which passes an object by value, `ba` is a `Brass` object constructed by the `Brass(const Brass &)` constructor. (Automatic upcasting allows the constructor argument to refer to a `BrassPlus` object.) Thus, in `inadequate()`, `ba.ViewAcct()` is the `Brass` version, so only the `Brass` component of `buzz` is displayed.

### Destructor Considerations

As mentioned earlier, a base class destructor should be virtual. That way, when you delete a derived object via a base-class pointer or reference to the object, the program uses the derived-class destructor followed by the base-class destructor rather than using only the base-class destructor.

### Friend Considerations

Because a friend function is not actually a class member, it's not inherited. However, you might still want a friend to a derived class to use a friend to the base class. The way to accomplish this is to type cast a derived-class reference or pointer to the base-class equivalent and to then use the type cast reference or pointer to invoke the base-class friend:

```
ostream & operator<<(ostream & os, const hasDMA & hs)
{
    // type cast to match operator<<(ostream & , const baseDMA &)
    os << (const baseDMA &) hs;
    os << "Style: " << hs.style << endl;
    return os;
}
```

You can also use the `dynamic_cast<>` operator, discussed in Chapter 15, “Friends, Exceptions, and More,” for the type cast:

```
os << dynamic_cast<const baseDMA &>(hs);
```

For reasons discussed in Chapter 15, this would be the preferred form of type cast.

## Observations on Using Base-Class Methods

Publicly derived objects can use base-class methods in many ways:

- A derived object automatically uses inherited base-class methods if the derived class hasn't redefined the method.
- A derived-class destructor automatically invokes the base-class constructor.
- A derived-class constructor automatically invokes the base-class default constructor if you don't specify another constructor in a member-initialization list.
- A derived-class constructor explicitly invokes the base-class constructor specified in a member-initialization list.
- Derived-class methods can use the scope-resolution operator to invoke public and protected base-class methods.
- Friends to a derived class can type cast a derived-class reference or pointer to a base-class reference or pointer and then use that reference or pointer to invoke a friend to the base class.

## Class Function Summary

C++ class functions come in many variations. Some can be inherited, and some can't. Some operator functions can be either member functions or friends, and others can only be member functions. Table 13.1, based on a similar table from *The Annotated C++ Reference Manual*, summarizes these properties. In it, the notation *op=* stands for assignment operators of the form *+=*, *\*=*, and so on. Note that the properties for the *op=* operators are no different from those of the “other operators” category. The reason for listing *op=* separately is to point out that these operators don't behave like the *=* operator.

Table 13.1 Member Function Properties

| Function    | Inherited | Member or Friend | Generated by Default | Can Be Virtual | Can Have a Return Type |
|-------------|-----------|------------------|----------------------|----------------|------------------------|
| Constructor | No        | Member           | Yes                  | No             | No                     |
| Destructor  | No        | Member           | Yes                  | Yes            | No                     |
| =           | No        | Member           | Yes                  | Yes            | Yes                    |
| &           | Yes       | Either           | Yes                  | Yes            | Yes                    |
| Conversion  | Yes       | Member           | No                   | Yes            | No                     |
| ()          | Yes       | Member           | No                   | Yes            | Yes                    |
| []          | Yes       | Member           | No                   | Yes            | Yes                    |
| ->          | Yes       | Member           | No                   | Yes            | Yes                    |
| <i>op=</i>  | Yes       | Either           | No                   | Yes            | Yes                    |



Table 13.1 Member Function Properties

| Function            | Inherited | Member or Friend | Generated by Default | Can Be Virtual | Can Have a Return Type |
|---------------------|-----------|------------------|----------------------|----------------|------------------------|
| <code>new</code>    | Yes       | Static member    | No                   | No             | <code>void *</code>    |
| <code>delete</code> | Yes       | Static member    | No                   | No             | <code>void</code>      |
| Other operators     | Yes       | Either           | No                   | Yes            | Yes                    |
| Other members       | Yes       | Member           | No                   | Yes            | Yes                    |
| Friends             | No        | Friend           | No                   | No             | Yes                    |

## Summary

Inheritance enables you to adapt programming code to your particular needs by defining a new class (a derived class) from an existing class (the base class). Public inheritance models an *is-a* relationship, meaning that a derived-class object should also be a kind of base-class object. As part of the *is-a* model, a derived class inherits the data members and most methods of the base class. However, a derived class doesn't inherit the base-class constructors, destructors, and assignment operators. A derived class can access the public and protected members of the base class directly and the private base-class members via the public and protected base-class methods. You can then add new data members and methods to the class, and you can use the derived class as a base class for further development. Each derived class requires its own constructors. When a program creates a derived-class object, it first calls a base-class constructor and then the derived-class constructor. When a program deletes an object, it first calls the derived-class destructor and then the base-class destructor.

If a class is meant to be a base class, you may choose to use protected members instead of private members so that derived classes can access those members directly. However, using private members, in general, reduces the scope for programming bugs. If you intend that a derived class can redefine a base-class method, you should make it a virtual function by declaring it with the keyword `virtual`. This enables objects accessed by pointers or references to be handled on the basis of the object type rather than on the basis of the reference type or pointer type. In particular, the destructor for a base class should normally be virtual.

You might want to define an ABC that defines an interface without getting into implementation matters. For example, you could define an abstract `Shape` class from which particular shape classes, such as `Circle` and `Square`, will be derived. An ABC must include at least one pure virtual method. You declare a pure virtual method by placing `= 0` before the closing semicolon of the declaration:

```
virtual double area() const = 0;
```

You don't have to define pure virtual methods, and you can't create an object of a class that contains pure virtual members. Instead, pure virtual methods serve to define a common interface to be used by derived classes.

## Chapter Review

1. What does a derived class inherit from a base class?
2. What doesn't a derived class inherit from a base class?
3. Suppose the return type for the `baseDMA::operator=()` function were defined as `void` instead of `baseDMA &`. What effect, if any, would that have? What if the return type were `baseDMA` instead of `baseDMA &`?
4. In what order are class constructors and class destructors called when a derived-class object is created and deleted?
5. If a derived class doesn't add any data members to the base class, does the derived class require constructors?
6. Suppose a base class and a derived class both define a method with the same name and a derived-class object invokes the method. What method is called?
7. When should a derived class define an assignment operator?
8. Can you assign the address of an object of a derived class to a pointer to the base class? Can you assign the address of an object of a base class to a pointer to the derived class?
9. Can you assign an object of a derived class to an object of the base class? Can you assign an object of a base class to an object of the derived class?
10. Suppose you define a function that takes a reference to a base-class object as an argument. Why can this function also use a derived-class object as an argument?
11. Suppose you define a function that takes a base-class object as an argument (that is, the function passes a base-class object by value). Why can this function also use a derived-class object as an argument?
12. Why is it usually better to pass objects by reference than by value?
13. Suppose `Corporation` is a base class and `PublicCorporation` is a derived class. Also suppose that each class defines a `head()` member function, that `ph` is a pointer to the `Corporation` type, and that `ph` is assigned the address of a `PublicCorporation` object. How is `ph->head()` interpreted if the base class defines `head()` as a
  - a. Regular nonvirtual method
  - b. Virtual method

14. What's wrong, if anything, with the following code?

```
class Kitchen
{
private:
    double kit_sq_ft;
public:
    Kitchen() {kit_sq_ft = 0.0; }
    virtual double area() const { return kit_sq_ft * kit_sq_ft; }
};
class House : public Kitchen
{
private:
    double all_sq_ft;
public:
    House() {all_sq_ft += kit_sq_ft;}
    double area(const char *s) const { cout << s; return all_sq_ft; }
};
```

## Programming Exercises

1. Start with the following class declaration:

```
// base class
class Cd { // represents a CD disk
private:
    char performers[50];
    char label[20];
    int selections; // number of selections
    double playtime; // playing time in minutes
public:
    Cd(char * s1, char * s2, int n, double x);
    Cd(const Cd & d);
    Cd();
    ~Cd();
    void Report() const; // reports all CD data
    Cd & operator=(const Cd & d);
};
```

Derive a `Classic` class that adds an array of `char` members that will hold a string identifying the primary work on the CD. If the base class requires that any functions be virtual, modify the base-class declaration to make it so. If a declared method is not needed, remove it from the definition. Test your product with the following program:

```
#include <iostream>
using namespace std;
#include "classic.h" // which will contain #include cd.h
```

```

void Bravo(const Cd & disk);
int main()
{
    Cd c1("Beatles", "Capitol", 14, 35.5);
    Classic c2 = Classic("Piano Sonata in B flat, Fantasia in C",
                       "Alfred Brendel", "Philips", 2, 57.17);
    Cd *pcd = &c1;

    cout << "Using object directly:\n";
    c1.Report();    // use Cd method
    c2.Report();    // use Classic method

    cout << "Using type cd * pointer to objects:\n";
    pcd->Report(); // use Cd method for cd object
    pcd = &c2;
    pcd->Report(); // use Classic method for classic object

    cout << "Calling a function with a Cd reference argument:\n";
    Bravo(c1);
    Bravo(c2);

    cout << "Testing assignment: ";
    Classic copy;
    copy = c2;
    copy.Report()

    return 0;
}

void Bravo(const Cd & disk)
{
    disk.Report();
}

```

2. Do Programming Exercise 1 but use dynamic memory allocation instead of fixed-size arrays for the various strings tracked by the two classes.
3. Revise the `baseDMA-lacksDMA-hasDMA` class hierarchy so that all three classes are derived from an ABC. Test the result with a program similar to the one in Listing 13.10. That is, it should feature an array of pointers to the ABC and allow the user to make runtime decisions as to what types of objects are created. Add virtual `view()` methods to the class definitions to handle displaying the data.
4. The Benevolent Order of Programmers maintains a collection of bottled port. To describe it, the BOP Portmaster has devised a `port` class, as declared here:

```

#include <iostream>
using namespace std;
class Port
{
private:
    char * brand;
    char style[20]; // i.e., tawny, ruby, vintage
    int bottles;
public:
    Port(const char * br = "none", const char * st = "none", int b = 0);
    Port(const Port & p); // copy constructor
    virtual ~Port() { delete [] brand; }
    Port & operator=(const Port & p);
    Port & operator+=(int b); // adds b to bottles
    Port & operator-=(int b); // subtracts b from bottles, if
available
    int BottleCount() const { return bottles; }
    virtual void Show() const;
    friend ostream & operator<<(ostream & os, const Port & p);
};

```

The Show() method presents information in the following format:

```

Brand: Gallo
Kind: tawny
Bottles: 20

```

The operator<<() function presents information in the following format (with no newline character at the end):

```

Gallo, tawny, 20

```

The Portmaster completed the method definitions for the Port class and then derived the VintagePort class as follows before being relieved of his position for accidentally routing a bottle of '45 Cockburn to someone preparing an experimental barbecue sauce:

```

class VintagePort : public Port // style necessarily = "vintage"
{
private:
    char * nickname; // i.e., "The Noble" or "Old Velvet", etc.
    int year; // vintage year
public:
    VintagePort();
    VintagePort(const char * br, int b, const char * nn, int y);
    VintagePort(const VintagePort & vp);
    ~VintagePort() { delete [] nickname; }
    VintagePort & operator=(const VintagePort & vp);
};

```

```
void Show() const;
friend ostream & operator<<(ostream & os, const VintagePort & vp);
};
```

You get the job of completing the `VintagePort` work.

- a. Your first task is to re-create the `Port` method definitions because the former Portmaster immolated his upon being relieved.
- b. Your second task is to explain why certain methods are redefined and others are not.
- c. Your third task is to explain why `operator=()` and `operator<<()` are not virtual.
- d. Your fourth task is to provide definitions for the `VintagePort` methods.

*This page intentionally left blank*

# Reusing Code in C++

In this chapter you'll learn about the following:

- *Has-a* relationships
- Classes with member objects (containment)
- The `valarray` template class
- Private and protected inheritance
- Multiple inheritance
- Virtual base classes
- Creating class templates
- Using class templates
- Template specializations

One of the main goals of C++ is to facilitate the reuse of code. Public inheritance is one mechanism for achieving this goal, but it's not the only one. This chapter investigates other choices. One technique is to use class members that are themselves objects of another class. This is referred to as *containment* or *composition* or *layering*. Another option is to use private or protected inheritance. Containment, private inheritance, and protected inheritance are typically used to implement *has-a* relationships—that is, relationships for which the new class has an object of another class. For example, a `HomeTheater` class might have a `BluRayPlayer` object. Multiple inheritance lets you create classes that inherit from two or more base classes, combining their functionality.

Chapter 10, “Objects and Classes,” introduces function templates. In this chapter we'll look at class templates, which provide another way of reusing code. A class template lets you define a class in generic terms. Then you can use the template to create specific classes defined for specific types. For example, you could define a general stack template and then use the template to create one class that represents a stack of `int` values and another class that represents a stack of `double` values. You could even generate a class that represents a stack of stacks.



## Classes with Object Members

Let's begin with classes that include class objects as members. Some classes, such as the `string` class or the standard C++ class templates discussed in Chapter 16, "The `string` Class and the Standard Template Library," offer convenient ways of representing components of a more extensive class. Let's look at a particular example now.

What is a student? Someone enrolled in a school? Someone engaged in thoughtful investigation? A refugee from the harsh exigencies of the real world? Someone with an identifying name and a set of quiz scores? Clearly, the last definition is a totally inadequate characterization of a person, but it is well suited for a simple computer representation. So let's develop a `student` class based on that definition.

Simplifying a student to a name and a set of quiz scores suggests using a class with two members: one to represent the name and one to represent the scores. For the name, you could use a character array, but that puts a size limitation on the name. Or you could use a `char` pointer and dynamic memory allocation. However, as Chapter 12, "Classes and Dynamic Memory Allocation," illustrates, that requires a lot of supporting code. Better yet, you could use an object of a class for which someone has already done all the work. For example, you could use an object of the `string` class (see Chapter 12) or of the standard C++ `string` class. The simpler choice is the `string` class because the C++ library already provides all the implementation code as well as a superior implementation. (To use the `string` class, you'd have to make the `string1.cpp` implementation file part of your project.)

Representing the quiz scores presents similar choices. You could use a fixed-size array, which places a size limitation. You could use dynamic memory allocation and provide a large body of supporting code. You could use your own design of a class, using dynamic memory allocation to represent an array. You could look for a standard C++ library class that is capable of representing the data.

Developing your own class is not out of the question. A simple version wouldn't be that difficult because an array of `double` shares many similarities with an array of `char`, so you could base the design of an array-of-`double` class on the `string` class design. And in fact, that is what earlier editions of this book do.

But, of course, it is even easier if the library already provides a suitable class, and it does: the `valarray` class.

### The `valarray` Class: A Quick Look

The `valarray` class is supported by the `valarray` header file. As its name suggests, the class is targeted to deal with numeric values (or with classes with similar properties), so it supports operations such as summing the contents and finding the largest and smallest values in an array. So that it can handle different data types, `valarray` is defined as a template class. Later, this chapter goes into how to define template classes, but all you need to know now is how to use one.

The template aspect means that you have to provide a specific type when declaring an object. To do so when declaring an object, you follow the identifier `valarray` with angle brackets that contain the desired type:

```
valarray<int> q_values;    // an array of int
valarray<double> weights; // an array of double
```

You've seen this syntax before in Chapter 4, "Compound Types," with the `vector` and `array` classes, and it's pretty easy. (Those template classes also can hold numbers, but they don't provide all the arithmetic support the `valarray` class does.)

The class aspect means that to use `valarray` objects, you need to know something about class constructors and other class methods. Here are several examples that use some of the constructors:

```
double gpa[5] = {3.1, 3.5, 3.8, 2.9, 3.3};
valarray<double> v1;           // an array of double, size 0
valarray<int> v2(8);          // an array of 8 int elements
valarray<int> v3(10,8);        // an array of 8 int elements,
                               // each set to 10
valarray<double> v4(gpa, 4);   // an array of 4 elements
                               // initialized to the first 4 elements of gpa
```

As you can see, you can create an empty array of zero size, an empty array of a given size, an array with all elements initialized to the same value, and an array initialized using the values from an ordinary array. With C++11, you also can use an initializer list:

```
valarray<int> v5 = {20, 32, 17, 9}; // C++11
```

Next, here are a few of the methods:

- The `operator[]()` method provides access to individual elements.
- The `size()` method returns the number of elements.
- The `sum()` method returns the sum of the elements.
- The `max()` method returns the largest element.
- The `min()` method returns the smallest element.

There are many more methods, some of which are presented in Chapter 16, but you've already seen more than enough to proceed with this example.

## The Student Class Design

At this point, the design plan for the `Student` class is to use a `string` object to represent the name and a `valarray<double>` object to represent the quiz scores. How should this be done? You might be tempted to publicly derive a `Student` class from these two classes. That would be an example of multiple public inheritance, which C++ allows, but it would be inappropriate here. The reason is that the relationship of a student to these classes doesn't fit the *is-a* model. A student is not a name. A student is not an array of quiz

scores. What you have here is a *has-a* relationship. A student has a name, and a student has an array of quiz scores. The usual C++ technique for modeling *has-a* relationships is to use composition or containment—that is, to create a class composed of, or containing, members that are objects of another class. For example, you can begin a `Student` class declaration like this:

```
class Student
{
private:
    string name;           // use a string object for name
    valarray<double> scores; // use a valarray<double> object for scores
    ...
};
```

As usual, the class makes the data members private. This implies that the `Student` class member functions can use the public interfaces of the `string` and `valarray<double>` classes to access and modify the `name` and `scores` objects, but the outside world cannot do so. The only access the outside world will have to `name` and `scores` is through the public interface defined for the `Student` class (see Figure 14.1). A common way of describing this is to say that the `Student` class acquires the implementation of its member objects but doesn't inherit the interface. For example, a `Student` object uses the `string` implementation rather than a `char * name` or a `char name[26]` implementation for holding the name. But a `Student` object does not innately have the ability to use the `string operator+=()` function for appending.

### Interfaces and Implementations

With public inheritance, a class inherits an interface, and, perhaps, an implementation. (Pure virtual functions in a base class can provide an interface without an implementation.) Acquiring the interface is part of the *is-a* relationship. With composition, on the other hand, a class acquires the implementation without the interface. Not inheriting the interface is part of the *has-a* relationship.

The fact that a class object doesn't automatically acquire the interface of a contained object is a good thing for a *has-a* relationship. For example, `string` overloads the `+` operator to allow concatenating two strings, but, conceptually, it doesn't make sense to concatenate two `Student` objects. That's one reason not to use public inheritance in this case. On the other hand, parts of the interface for the contained class may make sense for the new class. For example, you might want to use the `operator<()` method from the `string` interface to sort `Student` objects by name. You can do so by defining a `Student::operator<()` member function that internally uses the `string::operator<()` function. Let's move on to some details.

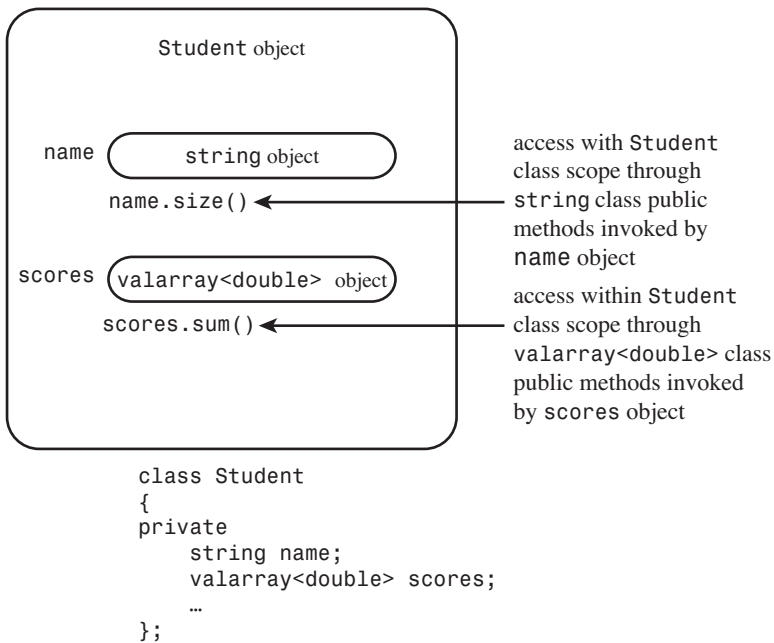

Figure 14.1 Objects within objects: containment.

## The Student Class Example

At this point you need to provide the `Student` class declaration. It should, of course, include constructors and at least a few functions to provide an interface for the `Student` class. Listing 14.1 does this, defining all the constructors inline. It also supplies some friends for input and output.

### Listing 14.1 `studentc.h`

```
// studentc.h -- defining a Student class using containment
#ifndef STUDENTC_H_
#define STUDENTC_H_

#include <iostream>
#include <string>
#include <valarray>
class Student
{
private:
    typedef std::valarray<double> ArrayDb;
    std::string name;          // contained object
    ArrayDb scores;          // contained object
    // private method for scores output
```

```

        std::ostream & arr_out(std::ostream & os) const;
public:
    Student() : name("Null Student"), scores() {}
    explicit Student(const std::string & s)
        : name(s), scores() {}
    explicit Student(int n) : name("Nully"), scores(n) {}
    Student(const std::string & s, int n)
        : name(s), scores(n) {}
    Student(const std::string & s, const ArrayDb & a)
        : name(s), scores(a) {}
    Student(const char * str, const double * pd, int n)
        : name(str), scores(pd, n) {}
    ~Student() {}
    double Average() const;
    const std::string & Name() const;
    double & operator[](int i);
    double operator[](int i) const;
// friends
    // input
    friend std::istream & operator>>(std::istream & is,
                                     Student & stu); // 1 word
    friend std::istream & getline(std::istream & is,
                                  Student & stu); // 1 line

    // output
    friend std::ostream & operator<<(std::ostream & os,
                                     const Student & stu);
};

#endif

```

---

In order to simplify notation, the `Student` class contains this typedef:

```
typedef std::valarray<double> ArrayDb;
```

This enables the remaining code to use the more convenient notation `ArrayDb` instead of `std::valarray<double>`. Thus, methods and friends can refer to the `ArrayDb` type. Placing this typedef in the private portion of the class definition means that it can be used internally in the `Student` implementation but not by outside users of the `Student` class.

Note the use of the keyword `explicit`:

```
explicit Student(const std::string & s)
    : name(s), scores() {}
explicit Student(int n) : name("Nully"), scores(n) {}

```

Recall that a constructor that can be called with one argument serves as an implicit conversion function from the argument type to the class type. This often is not a good idea. In the second constructor, for instance, the first argument represents the number of elements in an array rather than a value for the array, so having the constructor serve as an

`int-to-Student` conversion function does not make sense. Using `explicit` turns off implicit conversions. If this keyword were omitted, code like the following would be possible:

```
Student doh("Homer", 10); // store "Homer", create array of 10 elements
doh = 5; // reset name to "Nully", reset to empty array of 5 elements
```

Here, the inattentive programmer typed `doh` instead of `doh[0]`. If the constructor omitted `explicit`, `5` would be converted to a temporary `Student` object, using the constructor call `Student(5)`, with the value of "Nully" being used to set the name member. Then assignment would replace the original `doh` with the temporary object. With `explicit` in place, the compiler will catch the assignment operator as an error.

### C++ and Constraints

C++ is full of features that allow programmers to constrain programmatic constructs to certain limits—`explicit` to remove the implicit conversion of single-argument constructors, `const` to constrain the use of methods to modify data, and more. The underlying motive is simply this: Compile-time errors are better than runtime errors.

### Initializing Contained Objects

Note that constructors all use the by-now-familiar member initializer list syntax to initialize the `name` and `scores` member objects. In some cases earlier in this book, such as the following, the constructors use it to initialize members that are built-in types:

```
Queue::Queue(int qs) : qsize(qs) {...} // initialize qsize to qs
```

This code uses the name of the data member (`qsize`) in a member initializer list. Also constructors from previous examples, such as the following, use a member initializer list to initialize the base-class portion of a derived object:

```
hasDMA::hasDMA(const hasDMA & hs) : baseDMA(hs) {...}
```

For *inherited* objects, constructors use the *class* name in the member initializer list to invoke a specific base-class constructor. For *member* objects, constructors use the *member* name. For example, look at the last constructor in Listing 14.1:

```
Student(const char * str, const double * pd, int n)
    : name(str), scores(pd, n) {}
```

Because it initializes member objects, not inherited objects, this constructor uses the member names, not the class names, in the initialization list. Each item in this initialization list invokes the matching constructor. That is, `name(str)` invokes the `string(const char *)` constructor, and `scores(pd, n)` invokes the `ArrayDb(const double *, int)` constructor, which, because of the typedef, really is the `valarray<double>(const double *, int)` constructor.

What happens if you don't use the initialization list syntax? As with inherited components, C++ requires that all member objects be constructed before the rest of an object is constructed. So if you omit the initialization list, C++ uses the default constructors defined for the member objects' classes.

### Initialization Order

When you have a member initializer list that initializes more than one item, the items are initialized in the order in which they were declared, not in the order in which they appear in the initializer list. For example, suppose you write a `Student` constructor this way:

```
Student(const char * str, const double * pd, int n)
    : scores(pd, n), name(str) {}
```

The `name` member would still be initialized first because it is declared first in the class definition. The exact initialization order is not important for this example, but it would be important if the code used the value of one member as part of the initialization expression for a second member.

### Using an Interface for a Contained Object

The interface for a contained object isn't public, but it can be used within the class methods. For example, here is how you can define a function that returns the average of a student's scores:

```
double Student::Average() const
{
    if (scores.size() > 0)
        return scores.sum()/scores.size();
    else
        return 0;
}
```

This defines a method that can be invoked by a `Student` object. Internally, it uses the `valarray` `size()` and `sum()` methods. That's because `scores` is a `valarray` object, so it can invoke the member functions of the `valarray` class. In short, the `Student` object invokes a `Student` method, and the `Student` method uses the contained `valarray` object to invoke `valarray` methods.

Similarly, you can define a friend function that uses the `string` version of the `<<` operator:

```
// use string version of operator<<()
ostream & operator<<(ostream & os, const Student & stu)
{
    os << "Scores for " << stu.name << ":\n";
    ...
}
```

Because `stu.name` is a `string` object, it invokes the `operator<<(ostream &, const string &)` function, which is provided as part of the `string` class package. Note that the `operator<<(ostream & os, const Student & stu)` function has to be a friend to the `Student` class so that it can access the `name` member. (Alternatively, the function could use the public `Name()` method instead of the private `name` data member.)

Similarly, the function could use the `valarray` implementation of `<<` for output; unfortunately, there is none. Therefore, the class defines a private helper method to handle this task:

```
// private method
ostream & Student::arr_out(ostream & os) const
{
    int i;
    int lim = scores.size();
    if (lim > 0)
    {
        for (i = 0; i < lim; i++)
        {
            os << scores[i] << " ";
            if (i % 5 == 4)
                os << endl;
        }
        if (i % 5 != 0)
            os << endl;
    }
    else
        os << " empty array ";
    return os;
}
```

Using a helper like this gathers the messy details together in one place and makes the coding of the friend function neater:

```
// use string version of operator<<()
ostream & operator<<(ostream & os, const Student & stu)
{
    os << "Scores for " << stu.name << ":\n";
    stu.arr_out(os); // use private method for scores
    return os;
}
```

The helper function could also act as a building block for other user-level output functions, should you choose to provide them.

Listing 14.2 shows the class methods file for the `student` class. It includes methods that allow you to use the `[]` operator to access individual scores in a `student` object.

#### Listing 14.2 `studentc.cpp`

---

```
// studentc.cpp -- Student class using containment
#include "studentc.h"
using std::ostream;
using std::endl;
using std::istream;
using std::string;
```



```
//public methods
double Student::Average() const
{
    if (scores.size() > 0)
        return scores.sum()/scores.size();
    else
        return 0;
}

const string & Student::Name() const
{
    return name;
}

double & Student::operator[](int i)
{
    return scores[i];          // use valarray<double>::operator[]()
}

double Student::operator[](int i) const
{
    return scores[i];
}

// private method
ostream & Student::arr_out(ostream & os) const
{
    int i;
    int lim = scores.size();
    if (lim > 0)
    {
        for (i = 0; i < lim; i++)
        {
            os << scores[i] << " ";
            if (i % 5 == 4)
                os << endl;
        }
        if (i % 5 != 0)
            os << endl;
    }
    else
        os << " empty array ";
    return os;
}

// friends
```

```
// use string version of operator>>()
istream & operator>>(istream & is, Student & stu)
{
    is >> stu.name;
    return is;
}

// use string friend getline(ostream &, const string &)
istream & getline(istream & is, Student & stu)
{
    getline(is, stu.name);
    return is;
}

// use string version of operator<<()
ostream & operator<<(ostream & os, const Student & stu)
{
    os << "Scores for " << stu.name << ":\n";
    stu.arr_out(os); // use private method for scores
    return os;
}
```

---

Aside from the private helper method, Listing 14.2 doesn't require much new code. Using containment allows you to take advantage of the code you or someone else has already written.

### Using the New Student Class

Let's put together a small program to test the new `Student` class. To keep things simple, it should use an array of just three `Student` objects, each holding five quiz scores. And it should use an unsophisticated input cycle that doesn't verify input and that doesn't let you cut the input process short. Listing 14.3 presents the test program. Be sure to compile it along with `studentc.cpp`.

#### Listing 14.3 `use_stuc.cpp`

---

```
// use_stuc.cpp -- using a composite class
// compile with studentc.cpp
#include <iostream>
#include "studentc.h"
using std::cin;
using std::cout;
using std::endl;

void set(Student & sa, int n);
```

```

const int pupils = 3;
const int quizzes = 5;

int main()
{
    Student ada[pupils] =
        {Student(quizzes), Student(quizzes), Student(quizzes)};

    int i;
    for (i = 0; i < pupils; ++i)
        set(ada[i], quizzes);
    cout << "\nStudent List:\n";
    for (i = 0; i < pupils; ++i)
        cout << ada[i].Name() << endl;
    cout << "\nResults:";
    for (i = 0; i < pupils; ++i)
    {
        cout << endl << ada[i];
        cout << "average: " << ada[i].Average() << endl;
    }
    cout << "Done.\n";
    return 0;
}

void set(Student & sa, int n)
{
    cout << "Please enter the student's name: ";
    getline(cin, sa);
    cout << "Please enter " << n << " quiz scores:\n";
    for (int i = 0; i < n; i++)
        cin >> sa[i];
    while (cin.get() != '\n')
        continue;
}

```

---

Here is a sample run of the program in Listings 14.1, 14.2, and 14.3:

```

Please enter the student's name: Gil Bayts
Please enter 5 quiz scores:
92 94 96 93 95
Please enter the student's name: Pat Roone
Please enter 5 quiz scores:
83 89 72 78 95
Please enter the student's name: Fleur O'Day
Please enter 5 quiz scores:
92 89 96 74 64

```

```
Student List:
Gil Bayts
Pat Roone
Fleur O'Day

Results:
Scores for Gil Bayts:
92 94 96 93 95
average: 94

Scores for Pat Roone:
83 89 72 78 95
average: 83.4

Scores for Fleur O'Day:
92 89 96 74 64
average: 83
Done.
```

## Private Inheritance

C++ has a second means of implementing the *has-a* relationship: private inheritance. With *private inheritance*, public and protected members of the base class become private members of the derived class. This means the methods of the base class do not become part of the public interface of the derived object. They can be used, however, inside the member functions of the derived class.

Let's look at the interface topic more closely. With public inheritance, the public methods of the base class become public methods of the derived class. In short, the derived class inherits the base-class interface. This is part of the *is-a* relationship. With private inheritance, the public methods of the base class become private methods of the derived class. In short, the derived class does not inherit the base-class interface. As you saw with contained objects, this lack of inheritance is part of the *has-a* relationship.

With private inheritance, a class does inherit the implementation. For example, if you base a `Student` class on a `string` class, the `Student` class winds up with an inherited `string` class component that can be used to store a string. Furthermore, the `Student` methods can use the `string` methods internally to access the `string` component.

Containment adds an object to a class as a named member object, whereas private inheritance adds an object to a class as an unnamed inherited object. This book uses the term *subobject* to denote an object added by inheritance or by containment.

Private inheritance, then, provides the same features as containment: Acquire the implementation, don't acquire the interface. Therefore it, too, can be used to implement a *has-a* relationship. In fact, you can produce a `Student` class that uses private inheritance and has the same public interface as the containment version. Thus the differences between the two approaches affect the implementation, not the interface. Let's see how you can use private inheritance to redesign the `Student` class.

## A New Version of the Student Class Example

To get private inheritance, use the keyword `private` instead of `public` when defining the class. (Actually, `private` is the default, so omitting an access qualifier also leads to private inheritance.) The `Student` class should inherit from two classes, so the declaration should list both:

```
class Student : private std::string, private std::valarray<double>
{
public:
    ...
};
```

Having more than one base class is called *multiple inheritance* (MI). In general, MI, particularly public MI, can lead to problems that have to be resolved with additional syntax rules. We'll talk about such matters later in this chapter. But in this particular case, MI causes no problems.

Note that the new class doesn't need private data. That's because the two inherited base classes already provide all the needed data members. The containment version of this example provides two explicitly named objects as members. Private inheritance, however, provides two nameless subobjects as inherited members. This is the first of the main differences in the two approaches.

### Initializing Base-Class Components

Having implicitly inherited components instead of member objects affects the coding of this example because you can no longer use `name` and `scores` to describe the objects. Instead, you have to go back to the techniques you used for public inheritance. For example, consider constructors. Containment uses this constructor:

```
Student(const char * str, const double * pd, int n)
    : name(str), scores(pd, n) {} // use object names for containment
```

The new version should use the member initializer list syntax for inherited classes, which uses the *class* name instead of a *member* name to identify a constructor:

```
Student(const char * str, const double * pd, int n)
    : std::string(str), ArrayDb(pd, n) {} // use class names for inheritance
```

Here, as in the preceding example, `ArrayDb` is a typedef for `std::valarray<double>`. Be sure to note that the member initializer list uses terms such as `std::string(str)` instead of `name(str)`. This is the second main difference in the two approaches.

Listing 14.4 shows the new class declaration. The only changes are the omission of explicit object names and the use of class names instead of member names in the inline constructors.

Listing 14.4 `studenti.h`

---

```

// studenti.h -- defining a Student class using private inheritance
#ifndef STUDENTC_H_
#define STUDENTC_H_

#include <iostream>
#include <valarray>
#include <string>
class Student : private std::string, private std::valarray<double>
{
private:
    typedef std::valarray<double> ArrayDb;
    // private method for scores output
    std::ostream & arr_out(std::ostream & os) const;
public:
    Student() : std::string("Null Student"), ArrayDb() {}
    explicit Student(const std::string & s)
        : std::string(s), ArrayDb() {}
    explicit Student(int n) : std::string("Nully"), ArrayDb(n) {}
    Student(const std::string & s, int n)
        : std::string(s), ArrayDb(n) {}
    Student(const std::string & s, const ArrayDb & a)
        : std::string(s), ArrayDb(a) {}
    Student(const char * str, const double * pd, int n)
        : std::string(str), ArrayDb(pd, n) {}
    ~Student() {}
    double Average() const;
    double & operator[](int i);
    double operator[](int i) const;
    const std::string & Name() const;
// friends
    // input
    friend std::istream & operator>>(std::istream & is,
                                    Student & stu); // 1 word
    friend std::istream & getline(std::istream & is,
                                 Student & stu); // 1 line

    // output
    friend std::ostream & operator<<(std::ostream & os,
                                    const Student & stu);
};

#endif

```

---

### Accessing Base-Class Methods

Private inheritance limits the use of base-class methods to within derived-class methods. Sometimes, however, you might like to make a base-class facility available publicly. For example, the `Student` class declaration suggests the ability to use an `Average()` function. As with containment, the technique for doing this is to use the `valarray::size()` and `sum()` methods within a public `Student::average()` function (see Figure 14.2). Containment invoked the methods with an object:

```
double Student::Average() const
{
    if (scores.size() > 0)
        return scores.sum()/scores.size();
    else
        return 0;
}
```

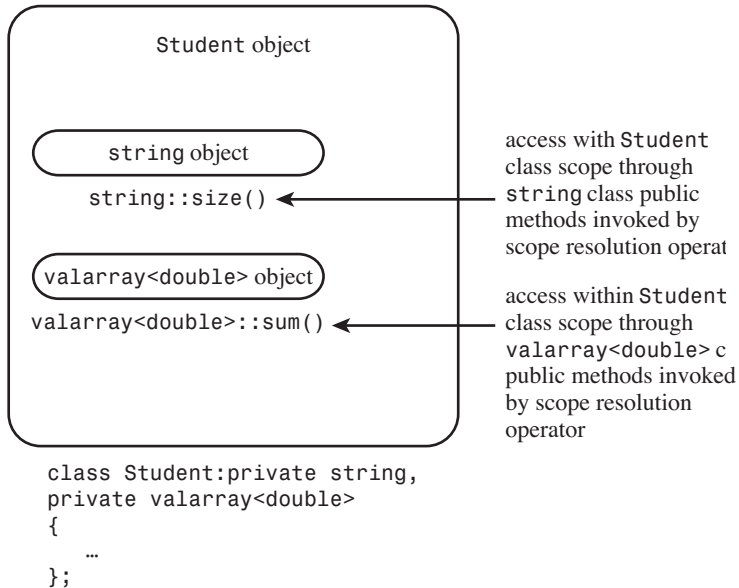

Figure 14.2 Objects within objects: private inheritance.

Here, however, inheritance lets you use the class name and the scope-resolution operator to invoke base-class methods:

```
double Student::Average() const
{
    if (ArrayDb::size() > 0)
        return ArrayDb::sum()/ArrayDb::size();
}
```

```

else
    return 0;
}

```

In short, the containment approach uses object names to invoke a method, whereas private inheritance uses the class name and the scope-resolution operator instead.

### Accessing Base-Class Objects

The scope-resolution operator allows you access to a base-class method, but what if you need the base-class object itself? For example, the containment version of the `Student` class implements the `Name()` method by having the method return the `name` member `string` object. But with private inheritance, the `string` object has no name. How, then, can `Student` code access the inner `string` object?

The answer is to use a type cast. Because `Student` is derived from `string`, it's possible to type cast a `Student` object to a `string` object; the result is the inherited `string` object. Recall that the `this` pointer points to the invoking object, so `*this` is the invoking object—in this case, a type `Student` object. To avoid invoking constructors to create new objects, you use the type cast to create a reference:

```

const string & Student::Name() const
{
    return (const string &) *this;
}

```

This code returns a reference to the inherited `string` object residing in the invoking `Student` object.

### Accessing Base-Class Friends

The technique of explicitly qualifying a function name with its class name doesn't work for friend functions because a friend function doesn't belong to a class. However, you can use an explicit type cast to the base class to invoke the correct functions. This is basically the same technique used to access a base-class object in a class method, but with friends you have a name for the `Student` object, so the code uses the name instead of `*this`. For example, consider the following friend function definition:

```

ostream & operator<<(ostream & os, const Student & stu)
{
    os << "Scores for " << (const String &) stu << ":\n";
    ...
}

```

If `plato` is a `Student` object, then the following statement invokes that function, with `stu` being a reference to `plato` and `os` being a reference to `cout`:

```

cout << plato;

```



Consider the following line of code:

```
os << "Scores for " << (const String &) stu << ":\n";
```

The typecast explicitly converts `stu` to a reference to a type `string` object; that type, in turn, invokes the `operator<<(ostream &, const String &)` function.

The reference `stu` doesn't get converted automatically to a `string` reference. The fundamental reason is that with private inheritance, a reference or pointer to a base class cannot be assigned a reference or pointer to a derived class without an explicit type cast.

However, even if the example used public inheritance, it would have to use explicit type casts. One reason is that without a type cast, code like the following matches the friend function prototype, leading to a recursive call:

```
os << stu;
```

A second reason is that because the class uses MI, the compiler can't tell which base class to convert to if both base classes happen to provide an `operator<<()` function. Listing 14.5 shows all the `Student` class methods, other than those defined inline in the class declaration.

#### Listing 14.5 `studenti.cpp`

---

```
// studenti.cpp -- Student class using private inheritance
#include "studenti.h"
using std::ostream;
using std::endl;
using std::istream;
using std::string;

// public methods
double Student::Average() const
{
    if (ArrayDb::size() > 0)
        return ArrayDb::sum()/ArrayDb::size();
    else
        return 0;
}

const string & Student::Name() const
{
    return (const string &) *this;
}

double & Student::operator[](int i)
{
    return ArrayDb::operator[](i); // use ArrayDb::operator[]()
}
```

```
double Student::operator[](int i) const
{
    return ArrayDb::operator[](i);
}

// private method
ostream & Student::arr_out(ostream & os) const
{
    int i;
    int lim = ArrayDb::size();
    if (lim > 0)
    {
        for (i = 0; i < lim; i++)
        {
            os << ArrayDb::operator[](i) << " ";
            if (i % 5 == 4)
                os << endl;
        }
        if (i % 5 != 0)
            os << endl;
    }
    else
        os << " empty array ";
    return os;
}

// friends
// use String version of operator>>()
istream & operator>>(istream & is, Student & stu)
{
    is >> (string &)stu;
    return is;
}

// use string friend getline(ostream &, const string &)
istream & getline(istream & is, Student & stu)
{
    getline(is, (string &)stu);
    return is;
}

// use string version of operator<<()
ostream & operator<<(ostream & os, const Student & stu)
{
    os << "Scores for " << (const string &) stu << ":\n";
    stu.arr_out(os); // use private method for scores
    return os;
}
```

---

Again, because the example reuses the `string` and `valarray` code, relatively little new code is needed, aside from the private helper method.

### Using the Revised Student Class

Once again, it's time to test a new class. Note that the two versions of the `Student` class have exactly the same public interface, so you can test the two versions with exactly the same program. The only difference is that you have to include `studenti.h` instead of `studentc.h`, and you have to link the program with `studenti.cpp` instead of with `studentc.cpp`. Listing 14.6 shows the program. Be sure to compile it along with `studenti.cpp`.

Listing 14.6 `use_stui.cpp`

---

```
// use_stui.cpp -- using a class with private inheritance
// compile with studenti.cpp
#include <iostream>
#include "studenti.h"
using std::cin;
using std::cout;
using std::endl;

void set(Student & sa, int n);

const int pupils = 3;
const int quizzes = 5;

int main()
{
    Student ada[pupils] =
        {Student(quizzes), Student(quizzes), Student(quizzes)};

    int i;
    for (i = 0; i < pupils; i++)
        set(ada[i], quizzes);
    cout << "\nStudent List:\n";
    for (i = 0; i < pupils; ++i)
        cout << ada[i].Name() << endl;
    cout << "\nResults:";
    for (i = 0; i < pupils; i++)
    {
        cout << endl << ada[i];
        cout << "average: " << ada[i].Average() << endl;
    }
    cout << "Done.\n";
    return 0;
}
```

```
void set(Student & sa, int n)
{
    cout << "Please enter the student's name: ";
    getline(cin, sa);
    cout << "Please enter " << n << " quiz scores:\n";
    for (int i = 0; i < n; i++)
        cin >> sa[i];
    while (cin.get() != '\n')
        continue;
}
```

---

Here is a sample run of the program in Listing 14.6:

```
Please enter the student's name: Gil Bayts
Please enter 5 quiz scores:
92 94 96 93 95
Please enter the student's name: Pat Roone
Please enter 5 quiz scores:
83 89 72 78 95
Please enter the student's name: Fleur O'Day
Please enter 5 quiz scores:
92 89 96 74 64
```

```
Student List:
Gil Bayts
Pat Roone
Fleur O'Day
```

```
Results:
Scores for Gil Bayts:
92 94 96 93 95
average: 94
```

```
Scores for Pat Roone:
83 89 72 78 95
average: 83.4
```

```
Scores for Fleur O'Day:
92 89 96 74 64
average: 83
Done.
```

The same input as before leads to the same output that the containment version produces.

## Containment or Private Inheritance?

Given that you can model a *has-a* relationship either with containment or with private inheritance, which should you use? Most C++ programmers prefer containment. First, it's easier to follow. When you look at the class declaration, you see explicitly named objects representing the contained classes, and your code can refer to these objects by name. Using inheritance makes the relationship appear more abstract. Second, inheritance can raise problems, particularly if a class inherits from more than one base class. You may have to deal with issues such as separate base classes having methods with the same name or of separate base classes sharing a common ancestor. All in all, you're less likely to run into trouble using containment. Also containment allows you to include more than one subobject of the same class. If a class needs three `string` objects, you can declare three separate `string` members by using the containment approach. But inheritance limits you to a single object. (It is difficult to tell objects apart when they are all nameless.)

However, private inheritance does offer features beyond those provided by containment. Suppose, for example, that a class has protected members, which could either be data members or member functions. Such members are available to derived classes but not to the world at large. If you include such a class in another class by using composition, the new class is part of the world at large, not a derived class. Hence it can't access protected members. But using inheritance makes the new class a derived class, so it can access protected members.

Another situation that calls for using private inheritance is if you want to redefine virtual functions. Again, this is a privilege accorded to a derived class but not to a containing class. With private inheritance, the redefined functions would be usable just within the class, not publicly.

### Tip

In general, you should use containment to model a *has-a* relationship. You should use private inheritance if the new class needs to access protected members in the original class or if it needs to redefine virtual functions.

## Protected Inheritance

Protected inheritance is a variation on private inheritance. It uses the keyword `protected` when listing a base class:

```
class Student : protected std::string,  
                protected std::valarray<double>  
{...};
```

With protected inheritance, public and protected members of a base class become protected members of the derived class. As with private inheritance, the interface for the base class is available to the derived class but not to the outside world. The main difference between private and protected inheritance occurs when you derive another class from the derived class. With private inheritance, this third-generation class doesn't get the internal use of the base-class interface. That's because the public base-class methods become

private in the derived class, and private members and methods can't be directly accessed by the next level of derivation. With protected inheritance, public base-class methods become protected in the second generation and so are available internally to the next level of derivation.

Table 14.1 summarizes public, private, and protected inheritance. The term *implicit upcasting* means that you can have a base-class pointer or reference refer to a derived class object without using an explicit type cast.

Table 14.1 Varieties of Inheritance

| Property                 | Public Inheritance                               | Protected Inheritance                            | Private Inheritance                              |
|--------------------------|--------------------------------------------------|--------------------------------------------------|--------------------------------------------------|
| Public members become    | Public members of the derived class              | Protected members of the derived class           | Private members of the derived class             |
| Protected members become | Protected members of the derived class           | Protected members of the derived class           | Private members of the derived class             |
| Private members become   | Accessible only through the base-class interface | Accessible only through the base-class interface | Accessible only through the base-class interface |
| Implicit upcasting       | Yes                                              | Yes (but only the derived class) within          | No                                               |

## Redefining Access with using

Public members of a base class become protected or private when you use protected or private derivation. Suppose you want to make a particular base-class method available publicly in the derived class. One option is to define a derived-class method that uses the base-class method. For example, suppose you want the `Student` class to be able to use the `valarray sum()` method. You can declare a `sum()` method in the class declaration and then define the method this way:

```
double Student::sum() const    // public Student method
{
    return std::valarray<double>::sum(); // use privately-inherited method
}
```

Then a `Student` object can invoke `Student::sum()`, which, in turn, applies the `valarray<double>::sum()` method to the embedded `valarray` object. (If the `ArrayDb` typedef is in scope, you can use `ArrayDb` instead of `std::valarray<double>`.)

There is an alternative to wrapping one function call in another: use a `using` declaration (such as those used with namespaces) to announce that a particular base-class member can be used by the derived class, even though the derivation is private. For example, suppose you want to be able to use the `valarray min()` and `max()` methods with the

Student class. In this case, in `studenti.h`, you can add `using` declarations to the public section:

```
class Student : private std::string, private std::valarray<double>
{
    ...
public:
    using std::valarray<double>::min;
    using std::valarray<double>::max;
    ...
};
```

The `using` declaration makes the `valarray<double>::min()` and `valarray<double>::max()` methods available as if they were public Student methods:

```
cout << "high score: " << ada[i].max() << endl;
```

Note that the `using` declaration just uses the member name—no parentheses, no function signatures, no return types. For example, to make the `valarray operator [] ()` method available to the Student class, you'd place the following `using` declaration in the public section of the Student class declaration:

```
using std::valarray<double>::operator[];
```

This would make both versions (const and non-const) available. You could then remove the existing prototypes and definitions for `Student::operator [] ()`. The `using` declaration approach works only for inheritance and not for containment.

There is an older way to redeclare base-class methods in a privately derived class: You place the method name in the public section of the derived class. Here's how you would do that:

```
class Student : private std::string, private std::valarray<double>
{
public:
    std::valarray<double>::operator[]; // redeclare as public, just use name
    ...
};
```

This looks like a `using` declaration without the `using` keyword. This approach is *deprecated*, meaning that the intention is to phase it out. So if your compiler supports the `using` declaration, you can use it to make a method from a private base class available to the derived class.

## Multiple Inheritance

MI describes a class that has more than one immediate base class. As with single inheritance, public MI should express an *is-a* relationship. For example, if you have a `waiter` class and a `singer` class, you could derive a `singingwaiter` class from the two:

```
class SingingWaiter : public Waiter, public Singer {...};
```

Note that you must qualify each base class with the keyword `public`. That's because the compiler assumes private derivation unless instructed otherwise:

```
class SingingWaiter : public Waiter, Singer {...}; // Singer is a private base
```

As discussed earlier in this chapter, private and protected MI can express a *has-a* relationship; the `student.h` implementation of the `Student` class is an example. We'll concentrate on public inheritance now.

MI can introduce new problems for programmers. The two chief problems are inheriting different methods with the same name from two different base classes and inheriting multiple instances of a class via two or more related immediate base classes. Solving these problems involves introducing a few new rules and syntax variations. Thus, using MI can be more difficult and problem-prone than using single inheritance. For this reason, many in the C++ community object strongly to MI; some want it removed from the language. Others love MI and argue that it's very useful, even necessary, for particular projects. Still others suggest using MI cautiously and in moderation.

Let's explore a particular example and see what the problems and solutions are. You need several classes to create an MI situation. For this example, we'll define an abstract `Worker` base class and derive a `Waiter` class and a `Singer` class from it. Then we can use MI to derive a `SingingWaiter` class from the `Waiter` and `Singer` classes (see Figure 14.3). This is a case in which a base class (`Worker`) is inherited via two separate derivations, which is the circumstance that causes the most difficulties with MI. We start with declarations for the `Worker`, `Waiter`, and `Singer` classes, as shown in Listing 14.7.

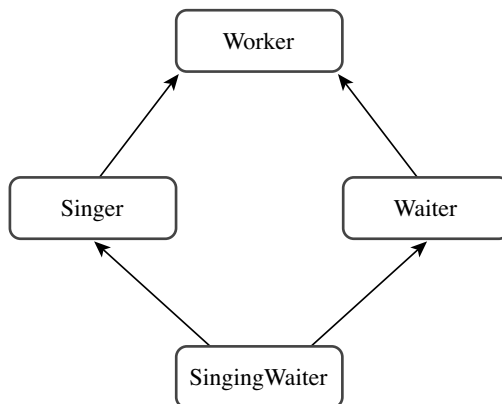

Figure 14.3 MI with a shared ancestor.



Listing 14.7 `worker0.h`

---

```

// worker0.h -- working classes
#ifndef WORKERO_H_
#define WORKERO_H_

#include <string>

class Worker // an abstract base class
{
private:
    std::string fullname;
    long id;
public:
    Worker() : fullname("no one"), id(0L) {}
    Worker(const std::string & s, long n)
        : fullname(s), id(n) {}
    virtual ~Worker() = 0; // pure virtual destructor
    virtual void Set();
    virtual void Show() const;
};

class Waiter : public Worker
{
private:
    int panache;
public:
    Waiter() : Worker(), panache(0) {}
    Waiter(const std::string & s, long n, int p = 0)
        : Worker(s, n), panache(p) {}
    Waiter(const Worker & wk, int p = 0)
        : Worker(wk), panache(p) {}
    void Set();
    void Show() const;
};

class Singer : public Worker
{
protected:
    enum {other, alto, contralto, soprano,
        bass, baritone, tenor};
    enum {Vtypes = 7};
private:
    static char *pv[Vtypes]; // string equivs of voice types
    int voice;
public:
    Singer() : Worker(), voice(other) {}

```

```

    Singer(const std::string & s, long n, int v = other)
        : Worker(s, n), voice(v) {}
    Singer(const Worker & wk, int v = other)
        : Worker(wk), voice(v) {}
    void Set();
    void Show() const;
};

#endif

```

---

The class declarations in Listing 14.7 include some internal constants that represent voice types. An enumeration makes `alto`, `contralto`, and so on symbolic constants for voice types, and the static array `pv` holds pointers to the C-style string equivalents. The implementation file, shown in Listing 14.8, initializes this array and provides method definitions.

#### Listing 14.8 `worker0.cpp`

---

```

// worker0.cpp -- working class methods
#include "worker0.h"
#include <iostream>
using std::cout;
using std::cin;
using std::endl;
// Worker methods

// must implement virtual destructor, even if pure
Worker::~Worker() {}

void Worker::Set()
{
    cout << "Enter worker's name: ";
    getline(cin, fullname);
    cout << "Enter worker's ID: ";
    cin >> id;
    while (cin.get() != '\n')
        continue;
}

void Worker::Show() const
{
    cout << "Name: " << fullname << "\n";
    cout << "Employee ID: " << id << "\n";
}

// Waiter methods
void Waiter::Set()

```

```

{
    Worker::Set();
    cout << "Enter waiter's panache rating: ";
    cin >> panache;
    while (cin.get() != '\n')
        continue;
}

void Waiter::Show() const
{
    cout << "Category: waiter\n";
    Worker::Show();
    cout << "Panache rating: " << panache << "\n";
}

// Singer methods

char * Singer::pv[] = {"other", "alto", "contralto",
                      "soprano", "bass", "baritone", "tenor"};

void Singer::Set()
{
    Worker::Set();
    cout << "Enter number for singer's vocal range:\n";
    int i;
    for (i = 0; i < Vtypes; i++)
    {
        cout << i << ": " << pv[i] << " ";
        if ( i % 4 == 3)
            cout << endl;
    }
    if (i % 4 != 0)
        cout << endl;
    while (cin >> voice && (voice < 0 || voice >= Vtypes) )
        cout << "Please enter a value >= 0 and < " << Vtypes << endl;

    while (cin.get() != '\n')
        continue;
}

void Singer::Show() const
{
    cout << "Category: singer\n";
    Worker::Show();
    cout << "Vocal range: " << pv[voice] << endl;
}

```

---

Listing 14.9 provides a brief test of the classes, using a polymorphic array of pointers.

Listing 14.9 **worktest.cpp**

---

```
// worktest.cpp -- test worker class hierarchy
#include <iostream>
#include "worker0.h"
const int LIM = 4;
int main()
{
    Waiter bob("Bob Apple", 314L, 5);
    Singer bev("Beverly Hills", 522L, 3);
    Waiter w_temp;
    Singer s_temp;

    Worker * pw[LIM] = {&bob, &bev, &w_temp, &s_temp};

    int i;
    for (i = 2; i < LIM; i++)
        pw[i]->Set();
    for (i = 0; i < LIM; i++)
    {
        pw[i]->Show();
        std::cout << std::endl;
    }

    return 0;
}
```

---

Here is the output of the program in Listings 14.7, 14.8, and 14.9:

```
Enter waiter's name: Waldo Dropmaster
Enter worker's ID: 442
Enter waiter's panache rating: 3
Enter singer's name: Sylvie Sirenne
Enter worker's ID: 555
Enter number for singer's vocal range:
0: other  1: alto  2: contralto  3: soprano
4: bass  5: baritone  6: tenor
3
Category: waiter
Name: Bob Apple
Employee ID: 314
Panache rating: 5

Category: singer
Name: Beverly Hills
```

```
Employee ID: 522
Vocal range: soprano
```

```
Category: waiter
Name: Waldo Dropmaster
Employee ID: 442
Panache rating: 3
```

```
Category: singer
Name: Sylvie Sirene
Employee ID: 555
Vocal range: soprano
```

The design seems to work, with pointers to `Waiter` invoking `Waiter::Show()` and `Waiter::Set()`, and pointers to `Singer` invoking `Singer::Show()` and `Singer::Set()`. However, it leads to some problems if you add a `SingingWaiter` class derived from both the `Singer` class and `Waiter` class. In particular, you'll need to face the following questions:

- How many workers?
- Which method?

## How Many Workers?

Suppose you begin by publicly deriving `SingingWaiter` from `Singer` and `Waiter`:

```
class SingingWaiter: public Singer, public Waiter {...};
```

Because both `Singer` and `Waiter` inherit a `Worker` component, `SingingWaiter` winds up with two `Worker` components (see Figure 14.4).

As you might expect, this raises problems. For example, ordinarily you can assign the address of a derived-class object to a base-class pointer, but this becomes ambiguous now:

```
SingingWaiter ed;
Worker * pw = &ed; // ambiguous
```

Normally, such an assignment sets a base-class pointer to the address of the base-class object within the derived object. But `ed` contains two `Worker` objects, so there are two addresses from which to choose. You could specify which object by using a type cast:

```
Worker * pw1 = (Waiter *) &ed; // the Worker in Waiter
Worker * pw2 = (Singer *) &ed; // the Worker in Singer
```

This certainly complicates the technique of using an array of base-class pointers to refer to a variety of objects (polymorphism).

Having two copies of a `Worker` object causes other problems, too. However, the real issue is why should you have two copies of a `Worker` object at all? A singing waiter, like any other worker, should have just one name and one ID. When C++ added MI to its bag of tricks, it added a virtual base class to make this possible.

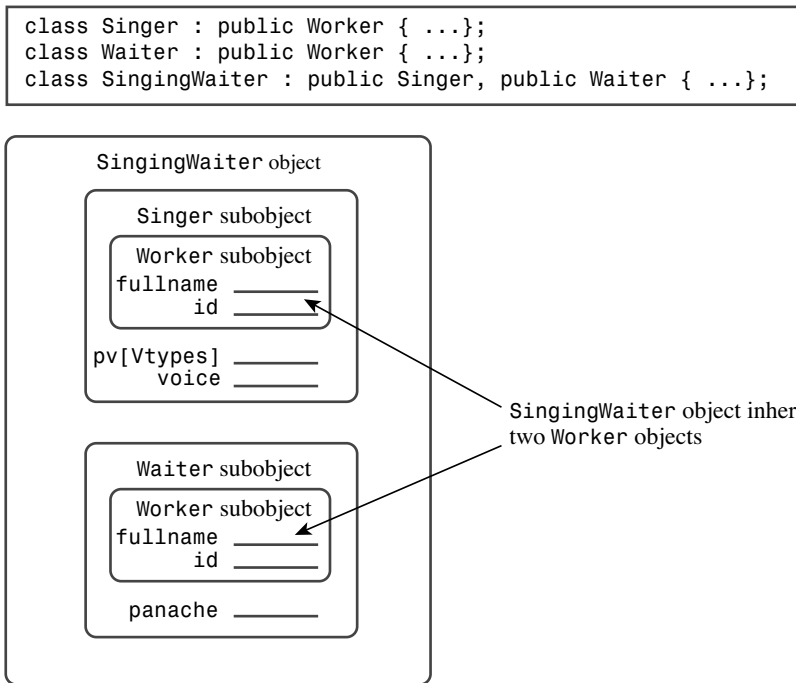

Figure 14.4 Inheriting two base-class objects.

### Virtual Base Classes

Virtual base classes allow an object derived from multiple bases that themselves share a common base to inherit just one object of that shared base class. For this example, you would make `Worker` a virtual base class to `Singer` and `Waiter` by using the keyword `virtual` in the class declarations (`virtual` and `public` can appear in either order):

```

class Singer : virtual public Worker { ...};
class Waiter : public virtual Worker { ...};

```

Then you would define `SingingWaiter` as before:

```

class SingingWaiter: public Singer, public Waiter { ...};

```

Now a `SingingWaiter` object will contain a single copy of a `Worker` object. In essence, the inherited `Singer` and `Waiter` objects share a common `Worker` object instead of each bringing in its own copy (see Figure 14.5). Because `SingingWaiter` now contains one `Worker` subobject, you can use polymorphism again.

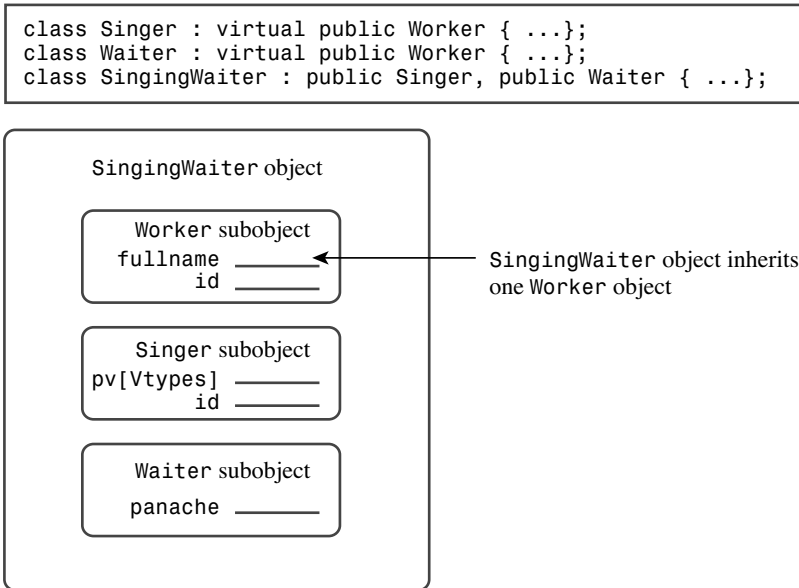

Figure 14.5 Inheritance with a virtual base class.

Let's look at some questions you might have:

- Why the term *virtual*?
- Why don't we dispense with declaring base classes virtual and make virtual behavior the norm for MI?
- Are there any catches?

First, why the term *virtual*? After all, there doesn't seem to be an obvious connection between the concepts of virtual functions and virtual base classes. There is strong pressure from the C++ community to resist the introduction of new keywords. It would be awkward, for example, if a new keyword corresponded to the name of some important function or variable in a major program. So C++ merely recycled the keyword `virtual` for the new facility—a bit of keyword overloading.

Next, why don't we dispense with declaring base classes virtual and make virtual behavior the norm for MI? First, there are cases in which you might want multiple copies of a base. Second, making a base class virtual requires that a program do some additional accounting, and you shouldn't have to pay for that facility if you don't need it. Third, there are the disadvantages presented in the next paragraph.

Finally, are there catches? Yes. Making virtual base classes work requires adjustments to C++ rules, and you have to code some things differently. Also using virtual base classes may involve changing existing code. For example, adding the `SingingWaiter` class to the

Worker hierarchy requires that you go back and add the `virtual` keyword to the `Singer` and `Waiter` classes.

## New Constructor Rules

Having virtual base classes requires a new approach to class constructors. With nonvirtual base classes, the *only* constructors that can appear in an initialization list are constructors for the immediate base classes. But these constructors can, in turn, pass information on to their bases. For example, you can have the following organization of constructors:

```
class A
{
    int a;
public:
    A(int n = 0) : a(n) {}
    ...
};
class B: public A
{
    int b;
public:
    B(int m = 0, int n = 0) : A(n), b(m) {}
    ...
};
class C : public B
{
    int c;
public:
    C(int q = 0, int m = 0, int n = 0) : B(m, n), c(q) {}
    ...
};
```

A `C` constructor can invoke only constructors from the `B` class, and a `B` constructor can invoke only constructors from the `A` class. Here the `C` constructor uses the `q` value and passes the values of `m` and `n` back to the `B` constructor. The `B` constructor uses the value of `m` and passes the value of `n` back to the `A` constructor.

This automatic passing of information doesn't work if `Worker` is a virtual base class. For example, consider the following possible constructor for the MI example:

```
SingingWaiter(const Worker & wk, int p = 0, int v = Singer::other)
    : Waiter(wk,p), Singer(wk,v) {} // flawed
```

The problem is that automatic passing of information would pass `wk` to the `Worker` object via two separate paths (`waiter` and `singer`). To avoid this potential conflict, C++ disables the automatic passing of information through an intermediate class to a base class *if* the base class is virtual. Thus, the previous constructor will initialize the `panache` and `voice` members, but the information in the `wk` argument *won't* get to the `waiter` subobject. However, the compiler must construct a base object component before constructing derived objects; in this case, it will use the default `Worker` constructor.



If you want to use something other than the default constructor for a virtual base class, you need to invoke the appropriate base constructor explicitly. Thus, the constructor should look like this:

```
SingingWaiter(const Worker & wk, int p = 0, int v = Singer::other)
    : Worker(wk), Waiter(wk,p), Singer(wk,v) {}
```

Here the code explicitly invokes the `Worker(const Worker &)` constructor. Note that this usage is legal and often necessary for virtual base classes, and it is illegal for nonvirtual base classes.

### Caution

If a class has an indirect virtual base class, a constructor for that class should explicitly invoke a constructor for the virtual base class unless all that is needed is the default constructor for the virtual base class.

## Which Method?

In addition to introducing changes in class constructor rules, MI often requires other coding adjustments. Consider the problem of extending the `Show()` method to the `SingingWaiter` class. Because a `SingingWaiter` object has no new data members, you might think the class could just use the inherited methods. This brings up the first problem. Suppose you do omit a new version of `Show()` and try to use a `SingingWaiter` object to invoke an inherited `Show()` method:

```
SingingWaiter newhire("Elise Hawks", 2005, 6, soprano);
newhire.Show(); // ambiguous
```

With single inheritance, failing to redefine `Show()` results in using the most recent ancestral definition. In this case, each direct ancestor has a `Show()` function, which makes this call ambiguous.

### Caution

Multiple Inheritance can result in ambiguous function calls. For example, a `BadDude` class could inherit two quite different `Draw()` methods from a `Gunslinger` class and a `PokerPlayer` class.

You can use the scope-resolution operator to clarify what you mean:

```
SingingWaiter newhire("Elise Hawks", 2005, 6, soprano);
newhire.Singer::Show(); // use Singer version
```

However, a better approach is to redefine `Show()` for `SingingWaiter` and to have it specify which `Show()` to use. For example, if you want a `SingingWaiter` object to use the `Singer` version, you could use this:

```
void SingingWaiter::Show()
{
    Singer::Show();
}
```

This method of having the derived method call the base method works well enough for single inheritance. For example, suppose that the `HeadWaiter` class derives from the `Waiter` class. You could use a sequence of definitions like this, with each derived class adding to the information displayed by its base class:

```
void Worker::Show() const
{
    cout << "Name: " << fullname << "\n";
    cout << "Employee ID: " << id << "\n";
}

void Waiter::Show() const
{
    Worker::Show();
    cout << "Panache rating: " << panache << "\n";
}

void HeadWaiter::Show() const
{
    Waiter::Show();
    cout << "Presence rating: " << presence << "\n";
}
```

This incremental approach fails for the `SingingWaiter` case, however. The following method fails because it ignores the `Waiter` component:

```
void SingingWaiter::Show()
{
    Singer::Show();
}
```

You can remedy that by calling the `waiter` version also:

```
void SingingWaiter::Show()
{
    Singer::Show();
    Waiter::Show();
}
```

However, this displays a person's name and ID twice because `Singer::Show()` and with `Waiter::Show()` both call `Worker::Show()`.

How can you fix this? One way is to use a modular approach instead of an incremental approach. That is, you can provide a method that displays only `Worker` components, another method that displays only `Waiter` components (instead of `Waiter` plus `Worker` components), and another that displays only `Singer` components. Then the

`SingingWaiter::Show()` method can put those components together. For example, you could use this:

```
void Worker::Data() const
{
    cout << "Name: " << fullname << "\n";
    cout << "Employee ID: " << id << "\n";
}

void Waiter::Data() const
{
    cout << "Panache rating: " << panache << "\n";
}

void Singer::Data() const
{
    cout << "Vocal range: " << pv[voice] << "\n";
}

void SingingWaiter::Data() const
{
    Singer::Data();
    Waiter::Data();
}

void SingingWaiter::Show() const
{
    cout << "Category: singing waiter\n";
    Worker::Data();
    Data();
}
```

Similarly, the other `Show()` methods would be built from the appropriate `Data()` components.

With this approach, objects would still use the `Show()` method publicly. The `Data()` methods, on the other hand, should be internal to the classes; they should be helper methods used to facilitate the public interface. However, making the `Data()` methods private would prevent, say, `Waiter` code from using `Worker::Data()`. Here is just the kind of situation for which the protected access class is useful. If the `Data()` methods are protected, they can be used internally by all the classes in the hierarchy while being kept hidden from the outside world.

Another approach would be to make all the data components protected instead of private, but using protected methods instead of protected data puts tighter control on the allowable access to the data.

The `Set()` methods, which solicit data for setting object values, present a similar problem. For example, `SingingWaiter::Set()` should ask for `Worker` information once, not

twice. The same solution used for `Show()` works. You can provide protected `Get()` methods that solicit information for just a single class, and then you can put together `Set()` methods that use the `Get()` methods as building blocks.

In short, introducing MI with a shared ancestor requires introducing virtual base classes, altering the rules for constructor initialization lists, and possibly recoding the classes if they were written with MI in mind. Listing 14.10 shows the modified class declarations with these changes institutes, and Listing 14.11 shows the implementation.

#### Listing 14.10 `workermi.h`

---

```
// workermi.h -- working classes with MI
#ifndef WORKERMI_H_
#define WORKERMI_H_

#include <string>

class Worker // an abstract base class
{
private:
    std::string fullname;
    long id;
protected:
    virtual void Data() const;
    virtual void Get();
public:
    Worker() : fullname("no one"), id(0L) {}
    Worker(const std::string & s, long n)
        : fullname(s), id(n) {}
    virtual ~Worker() = 0; // pure virtual function
    virtual void Set() = 0;
    virtual void Show() const = 0;
};

class Waiter : virtual public Worker
{
private:
    int panache;
protected:
    void Data() const;
    void Get();
public:
    Waiter() : Worker(), panache(0) {}
    Waiter(const std::string & s, long n, int p = 0)
        : Worker(s, n), panache(p) {}
    Waiter(const Worker & wk, int p = 0)
        : Worker(wk), panache(p) {}
};
```

```

        void Set();
        void Show() const;
};

class Singer : virtual public Worker
{
protected:
enum {other, alto, contralto, soprano,
      bass, baritone, tenor};
    enum {Vtypes = 7};
    void Data() const;
    void Get();
private:
    static char *pv[Vtypes];    // string equivs of voice types
    int voice;
public:
    Singer() : Worker(), voice(other) {}
    Singer(const std::string & s, long n, int v = other)
        : Worker(s, n), voice(v) {}
    Singer(const Worker & wk, int v = other)
        : Worker(wk), voice(v) {}
    void Set();
    void Show() const;
};

// multiple inheritance
class SingingWaiter : public Singer, public Waiter
{
protected:
    void Data() const;
    void Get();
public:
    SingingWaiter() {}
    SingingWaiter(const std::string & s, long n, int p = 0,
                  int v = other)
        : Worker(s,n), Waiter(s, n, p), Singer(s, n, v) {}
    SingingWaiter(const Worker & wk, int p = 0, int v = other)
        : Worker(wk), Waiter(wk,p), Singer(wk,v) {}
    SingingWaiter(const Waiter & wt, int v = other)
        : Worker(wt),Waiter(wt), Singer(wt,v) {}
    SingingWaiter(const Singer & wt, int p = 0)
        : Worker(wt),Waiter(wt,p), Singer(wt) {}
    void Set();
    void Show() const;
};

#endif

```

---

Listing 14.11 `workermi.cpp`

---

```
// workermi.cpp -- working class methods with MI
#include "workermi.h"
#include <iostream>
using std::cout;
using std::cin;
using std::endl;
// Worker methods
Worker::~Worker() { }

// protected methods
void Worker::Data() const
{
    cout << "Name: " << fullname << endl;
    cout << "Employee ID: " << id << endl;
}

void Worker::Get()
{
    getline(cin, fullname);
    cout << "Enter worker's ID: ";
    cin >> id;
    while (cin.get() != '\n')
        continue;
}

// Waiter methods
void Waiter::Set()
{
    cout << "Enter waiter's name: ";
    Worker::Get();
    Get();
}

void Waiter::Show() const
{
    cout << "Category: waiter\n";
    Worker::Data();
    Data();
}

// protected methods
void Waiter::Data() const
{
    cout << "Panache rating: " << panache << endl;
}
```

```

void Waiter::Get()
{
    cout << "Enter waiter's panache rating: ";
    cin >> panache;
    while (cin.get() != '\n')
        continue;
}

// Singer methods

char * Singer::pv[Singer::Vtypes] = {"other", "alto", "contralto",
    "soprano", "bass", "baritone", "tenor"};

void Singer::Set()
{
    cout << "Enter singer's name: ";
    Worker::Get();
    Get();
}

void Singer::Show() const
{
    cout << "Category: singer\n";
    Worker::Data();
    Data();
}

// protected methods
void Singer::Data() const
{
    cout << "Vocal range: " << pv[voice] << endl;
}

void Singer::Get()
{
    cout << "Enter number for singer's vocal range:\n";
    int i;
    for (i = 0; i < Vtypes; i++)
    {
        cout << i << ": " << pv[i] << " ";
        if (i % 4 == 3)
            cout << endl;
    }
    if (i % 4 != 0)
        cout << '\n';
    cin >> voice;
}

```

```
        while (cin.get() != '\n')
            continue;
    }

// SingingWaiter methods
void SingingWaiter::Data() const
{
    Singer::Data();
    Waiter::Data();
}

void SingingWaiter::Get()
{
    Waiter::Get();
    Singer::Get();
}

void SingingWaiter::Set()
{
    cout << "Enter singing waiter's name: ";
    Worker::Get();
    Get();
}

void SingingWaiter::Show() const
{
    cout << "Category: singing waiter\n";
    Worker::Data();
    Data();
}
```

---

Of course, curiosity demands that you test these classes, and Listing 14.12 provides code to do so. Note that the program makes use of polymorphism by assigning the addresses of various kinds of classes to base-class pointers. Also the program uses the C-style string library function `strchr()` in the following test:

```
while (strchr("wstq", choice) == NULL)
```

This function returns the address of the first occurrence of the `choice` character value in the string `"wstq"`; the function returns the `NULL` pointer if the character isn't found. This test is simpler to write than an `if` statement that compares `choice` to each letter individually.

Be sure to compile Listing 14.12 along with `workermi.cpp`.



Listing 14.12 `workmi.cpp`

---

```
// workmi.cpp -- multiple inheritance
// compile with workermi.cpp
#include <iostream>
#include <cstring>
#include "workermi.h"
const int SIZE = 5;

int main()
{
    using std::cin;
    using std::cout;
    using std::endl;
    using std::strchr;

    Worker * lolas[SIZE];

    int ct;
    for (ct = 0; ct < SIZE; ct++)
    {
        char choice;
        cout << "Enter the employee category:\n"
             << "w: waiter s: singer "
             << "t: singing waiter q: quit\n";
        cin >> choice;
        while (strchr("wstq", choice) == NULL)
        {
            cout << "Please enter a w, s, t, or q: ";
            cin >> choice;
        }
        if (choice == 'q')
            break;
        switch(choice)
        {
            case 'w': lolas[ct] = new Waiter;
                     break;
            case 's': lolas[ct] = new Singer;
                     break;
            case 't': lolas[ct] = new SingingWaiter;
                     break;
        }
        cin.get();
        lolas[ct]->Set();
    }

    cout << "\nHere is your staff:\n";
```

```
int i;
for (i = 0; i < ct; i++)
{
    cout << endl;
    lolas[i]->Show();
}
for (i = 0; i < ct; i++)
    delete lolas[i];
cout << "Bye.\n";
return 0;
}
```

---

Here is a sample run of the program in Listings 14.10, 14.11, and 14.12:

```
Enter the employee category:
w: waiter  s: singer  t: singing waiter  q: quit
w
Enter waiter's name: Wally Slipshod
Enter worker's ID: 1040
Enter waiter's panache rating: 4
Enter the employee category:
w: waiter  s: singer  t: singing waiter  q: quit
s
Enter singer's name: Sinclair Parma
Enter worker's ID: 1044
Enter number for singer's vocal range:
0: other  1: alto  2: contralto  3: soprano
4: bass   5: baritone  6: tenor
5
Enter the employee category:
w: waiter  s: singer  t: singing waiter  q: quit
t
Enter singing waiter's name: Natasha Gargalova
Enter worker's ID: 1021
Enter waiter's panache rating: 6
Enter number for singer's vocal range:
0: other  1: alto  2: contralto  3: soprano
4: bass   5: baritone  6: tenor
3
Enter the employee category:
w: waiter  s: singer  t: singing waiter  q: quit
q

Here is your staff:

Category: waiter
Name: Wally Slipshod
```

```
Employee ID: 1040
Panache rating: 4
```

```
Category: singer
Name: Sinclair Parma
Employee ID: 1044
Vocal range: baritone
```

```
Category: singing waiter
Name: Natasha Gargalova
Employee ID: 1021
Vocal range: soprano
Panache rating: 6
Bye.
```

Let's look at a few more matters concerning MI.

### Mixed Virtual and Nonvirtual Bases

Let's consider again the case of a derived class that inherits a base class by more than one route. If the base class is virtual, the derived class contains one subobject of the base class. If the base class is not virtual, the derived class contains multiple subobjects. What if there is a mixture? Suppose, for example, that class `B` is a virtual base class to classes `C` and `D` and a nonvirtual base class to classes `X` and `Y`. Furthermore, suppose class `M` is derived from `C`, `D`, `X`, and `Y`. In this case, class `M` contains one class `B` subobject for all the virtually derived ancestors (that is, classes `C` and `D`) and a separate class `B` subobject for each nonvirtual ancestor (that is, classes `X` and `Y`). So, all told, it would contain three class `B` subobjects. When a class inherits a particular base class through several virtual paths and several nonvirtual paths, the class has one base-class subobject to represent all the virtual paths and a separate base-class subobject to represent each nonvirtual path.

### Virtual Base Classes and Dominance

Using virtual base classes alters how C++ resolves ambiguities. With nonvirtual base classes, the rules are simple. If a class inherits two or more members (data or methods) with the same name from different classes, using that name without qualifying it with a class name is ambiguous. If virtual base classes are involved, however, such a use may or may not be ambiguous. In this case, if one name *dominates* all others, it can be used unambiguously without a qualifier.

So how does one member name dominate another? A name in a derived class dominates the same name in any ancestor class, whether direct or indirect. For example, consider the following definitions:

```
class B
{
public:
    short q();
    ...
}
```

```

};

class C : virtual public B
{
public:
    long q();
    int omg()
    ...
};

class D : public C
{
    ...
};

class E : virtual public B
{
private:
    int omg();
    ...
};

class F: public D, public E
{
    ...
};

```

Here the definition of `q()` in class `C` dominates the definition in class `B` because `C` is derived from `B`. Thus, methods in `F` can use `q()` to denote `C::q()`. On the other hand, neither definition of `omg()` dominates the other because neither `C` nor `E` is a base class to the other. Therefore, an attempt by `F` to use an unqualified `omg()` would be ambiguous.

The virtual ambiguity rules pay no attention to access rules. That is, even though `E::omg()` is private and hence not directly accessible to class `F`, using `omg()` is ambiguous. Similarly, even if `C::q()` were private, it would dominate `D::q()`. In that case, you could call `B::q()` in class `F`, but an unqualified `q()` for that would refer to the inaccessible `C::q()`.

## Multiple Inheritance Synopsis

First, let's review MI without virtual base classes. This form of MI imposes no new rules. However, if a class inherits two members with the same name but from different classes, you need to use class qualifiers in the derived class to distinguish between the two members. That is, methods in the `BadDude` class, derived from `Gunslinger` and `PokerPlayer`, would use `Gunslinger::draw()` and `PokerPlayer::draw()` to distinguish between `draw()` methods inherited from the two classes. Otherwise, the compiler should complain about ambiguous usage.

If one class inherits from a nonvirtual base class by more than one route, then the class inherits one base-class object for each nonvirtual instance of the base class. In some cases, this may be what you want, but more often, multiple instances of a base class are a problem.

Next, let's look at MI with virtual base classes. A class becomes a virtual base class when a derived class uses the keyword `virtual` when indicating derivation:

```
class marketing : public virtual reality { ... };
```

The main change, and the reason for virtual base classes, is that a class that inherits from one or more instances of a virtual base class inherits just one base-class object. Implementing this feature entails other requirements:

- A derived class with an indirect virtual base class should have its constructors invoke the indirect base-class constructors directly, which is illegal for indirect non-virtual base classes.
- Name ambiguity is resolved via the dominance rule.

As you can see, MI can introduce programming complexities. However, most of these complexities arise when a derived class inherits from the same base class by more than one route. If you avoid that situation, about the only thing you need to watch for is qualifying inherited names when necessary.

## Class Templates

Inheritance (public, private, or protected) and containment aren't always the solution when you want to reuse code. Consider, for example, the `stack` class (see Chapter 10) and the `queue` class (see Chapter 12). These are examples of *container classes*, which are classes designed to hold other objects or data types. The `stack` class from Chapter 10, for example, stores `unsigned long` values. You could just as easily define a `stack` class for storing `double` values or `string` objects. The code would be identical except for the type of object stored. However, rather than write new class declarations, it would be nice if you could define a `stack` in a generic (that is, type-independent) fashion and then provide a specific type as a parameter to the class. Then you could use the same generic code to produce stacks of different kinds of values. In Chapter 10, the `stack` example uses `typedef` as a first pass at dealing with this desire. However, that approach has a couple drawbacks. First, you have to edit the header file each time you change the type. Second, you can use the technique to generate just one kind of `stack` per program. That is, you can't have a `typedef` represent two different types simultaneously, so you can't use the method to define a `stack` of `ints` and a `stack` of `strings` in the same program.

C++'s class templates provide a better way to generate generic class declarations. (C++ originally did not support templates, and since their introduction, templates have continued to evolve, so it is possible that your compiler, if old, may not support all the features presented here.) Templates provide *parameterized* types—that is, they are capable of passing a type name as an argument to a recipe for building a class or a function. By feeding the

type name `int` to a `Queue` template, for example, you can get the compiler to construct a `Queue` class for queuing `ints`.

The C++ library provides several template classes. Earlier in this chapter, you worked with the `valarray` template class, and Chapter 4 introduced the `vector` and `array` template classes. C++'s Standard Template Library (STL), which Chapter 16 discusses in part, provides powerful and flexible template implementations of several container classes. This chapter explores designs of a more elementary nature.

## Defining a Class Template

Let's use the `Stack` class from Chapter 10 as a model from which to build a template. Here's the original class declaration:

```
typedef unsigned long Item;

class Stack
{
private:
    enum {MAX = 10};    // constant specific to class
    Item items[MAX];   // holds stack items
    int top;           // index for top stack item
public:
    Stack();
    bool isempty() const;
    bool isfull() const;
    // push() returns false if stack already is full, true otherwise
    bool push(const Item & item); // add item to stack
    // pop() returns false if stack already is empty, true otherwise
    bool pop(Item & item);       // pop top into item
};
```

The template approach will replace the `Stack` definition with a template definition and the `Stack` member functions with template member functions. As with template functions, you preface a template class with code that has the following form:

```
template <class Type>
```

The keyword `template` informs the compiler that you're about to define a template. The part in angle brackets is analogous to an argument list to a function. You can think of the keyword `class` as serving as a type name for a variable that accepts a type as a value, and of `Type` as representing a name for this variable.

Using `class` here doesn't mean that `Type` must be a class; it just means that `Type` serves as a generic type specifier for which a real type will be substituted when the template is used. Newer C++ implementations allow you to use the less confusing keyword `typename` instead of `class` in this context:

```
template <typename Type> // newer choice
```

You can use your choice of generic type name in the `Type` position; the name rules are the same as those for any other identifier. Popular choices include `T` and `Type`; in this case, we'll use the latter. When a template is invoked, `Type` will be replaced with a specific type value, such as `int` or `string`. Within the template definition, you can use the generic type name to identify the type to be stored in the stack. For the `Stack` case, that would mean using `Type` wherever the old declaration formerly used the `typedef` identifier `Item`. For example,

```
Item items[MAX]; // holds stack items
```

becomes the following:

```
Type items[MAX]; // holds stack items
```

Similarly, you can replace the class methods of the original class with template member functions. Each function heading will be prefaced with the same template announcement:

```
template <class Type>
```

Again, you should replace the `typedef` identifier `Item` with the generic type name `Type`. One more change is that you need to change the class qualifier from `Stack::` to `Stack<Type>::`. For example,

```
bool Stack::push(const Item & item)
{
    ...
}
```

becomes the following:

```
template <class Type>                // or template <typename Type>
bool Stack<Type>::push(const Type & item)
{
    ...
}
```

If you define a method within the class declaration (an inline definition), you can omit the template preface and the class qualifier.

Listing 14.13 shows the combined class and member function templates. It's important to realize that these templates are not class and member function definitions. Rather, they are instructions to the C++ compiler about how to generate class and member function definitions. A particular actualization of a template, such as a stack class for handling `string` objects, is called an *instantiation* or a *specialization*. Placing the template member functions in a separate implementation file won't work. (For a while, the standard did provide the keyword `export` to allow such a separate implementation file. But not many vendors implemented it. C++11 discontinues that use of `export` but reserves the `export` keyword for possible future use.) Because the templates aren't functions, they can't be compiled separately. Templates have to be used in conjunction with requests for particular instantiations of templates. The simplest way to make this work is to place all the template

information in a header file and to include the header file in the file that will use the templates.

#### Listing 14.13 `stacktp.h`

---

```
// stacktp.h -- a stack template
#ifndef STACKTP_H_
#define STACKTP_H_
template <class Type>
class Stack
{
private:
    enum {MAX = 10}; // constant specific to class
    Type items[MAX]; // holds stack items
    int top; // index for top stack item
public:
    Stack();
    bool isempty();
    bool isfull();
    bool push(const Type & item); // add item to stack
    bool pop(Type & item); // pop top into item
};

template <class Type>
Stack<Type>::Stack()
{
    top = 0;
}

template <class Type>
bool Stack<Type>::isempty()
{
    return top == 0;
}

template <class Type>
bool Stack<Type>::isfull()
{
    return top == MAX;
}

template <class Type>
bool Stack<Type>::push(const Type & item)
{
    if (top < MAX)
    {
```



```

        items[top++] = item;
        return true;
    }
    else
        return false;
}

template <class Type>
bool Stack<Type>::pop(Type & item)
{
    if (top > 0)
    {
        item = items[--top];
        return true;
    }
    else
        return false;
}

#endif

```

---

## Using a Template Class

Merely including a template in a program doesn't generate a template class. You have to ask for an instantiation. To do this, you declare an object of the template class type, replacing the generic type name with the particular type you want. For example, here's how you would create two stacks, one for stacking ints and one for stacking string objects:

```

Stack<int> kernels;      // create a stack of ints
Stack<string> colonels; // create a stack of string objects

```

Seeing these two declarations, the compiler will follow the `Stack<Type>` template to generate two separate class declarations and two separate sets of class methods. The `Stack<int>` class declaration will replace `Type` throughout with `int`, and the `Stack<string>` class declaration will replace `Type` throughout with `string`. Of course, the algorithms you use have to be consistent with the types. The `Stack` class, for example, assumes that you can assign one item to another. This assumption is true for basic types, structures, and classes (unless you make the assignment operator private) but not for arrays.

Generic type identifiers such as `Type` in the example are called *type parameters*, meaning that they act something like variables, but instead of assigning a numeric value to a type parameter, you assign a type to it. So in the `kernel` declaration, the type parameter `Type` has the value `int`.

Notice that you have to provide the desired type explicitly. This is different from ordinary function templates, for which the compiler can use the argument types to a function to figure out what kind of function to generate:

```

template <class T>
void simple(T t) { cout << t << '\n';}
...
simple(2);          // generate void simple(int)
simple("two");     // generate void simple(const char *)

```

Listing 14.14 modifies the original stack-testing program (Listing 10.12) to use string purchase order IDs instead of unsigned long values.

#### Listing 14.14 **stacktem.cpp**

---

```

// stacktem.cpp -- testing the template stack class
#include <iostream>
#include <string>
#include <cctype>
#include "stacktp.h"
using std::cin;
using std::cout;

int main()
{
    Stack<std::string> st;    // create an empty stack
    char ch;
    std::string po;
    cout << "Please enter A to add a purchase order,\n"
         << "P to process a PO, or Q to quit.\n";
    while (cin >> ch && std::toupper(ch) != 'Q')
    {
        while (cin.get() != '\n')
            continue;
        if (!std::isalpha(ch))
        {
            cout << '\a';
            continue;
        }
        switch(ch)
        {
            case 'A':
            case 'a': cout << "Enter a PO number to add: ";
                    cin >> po;
                    if (st.isfull())
                        cout << "stack already full\n";
                    else
                        st.push(po);
                    break;
            case 'P':
            case 'p': if (st.isempty())
                    cout << "stack already empty\n";

```

```

        else {
            st.pop(po);
            cout << "PO #" << po << " popped\n";
            break;
        }
    }
    cout << "Please enter A to add a purchase order,\n"
        << "P to process a PO, or Q to quit.\n";
}
cout << "Bye\n";
return 0;
}

```

---

Here's a sample run of the program in Listing 14.14:

```

Please enter A to add a purchase order,
P to process a PO, or Q to quit.
A
Enter a PO number to add: red911porsche
Please enter A to add a purchase order,
P to process a PO, or Q to quit.
A
Enter a PO number to add: blueR8audi
Please enter A to add a purchase order,
P to process a PO, or Q to quit.
A
Enter a PO number to add: silver747boeing
Please enter A to add a purchase order,
P to process a PO, or Q to quit.
P
PO #silver747boeing popped
Please enter A to add a purchase order,
P to process a PO, or Q to quit.
P
PO #blueR8audi popped
Please enter A to add a purchase order,
P to process a PO, or Q to quit.
P
PO #red911porsche popped
Please enter A to add a purchase order,
P to process a PO, or Q to quit.
P
stack already empty
Please enter A to add a purchase order,
P to process a PO, or Q to quit.
Q
Bye

```

## A Closer Look at the Template Class

You can use a built-in type or a class object as the type for the `Stack<Type>` class template. What about a pointer? For example, can you use a pointer to a `char` instead of a `string` object in Listing 14.14? After all, such pointers are the built-in way for handling C-style strings. The answer is that you can create a stack of pointers, but it won't work very well without major modifications in the program. The compiler can create the class, but it's your task to see that it's used sensibly. Let's see why such a stack of pointers doesn't work very well with Listing 14.14, and then let's look at an example where a stack of pointers is useful.

### Using a Stack of Pointers Incorrectly

Let's quickly look at three simple, but flawed, attempts to adapt Listing 14.14 to use a stack of pointers. These attempts illustrate the lesson that you should keep the design of a template in mind and not just use it blindly. All three examples begin with this perfectly valid invocation of the `Stack<Type>` template:

```
Stack<char *> st; // create a stack for pointers-to-char
```

Version 1 then replaces

```
string po;
```

in listing 14.14 with

```
char * po;
```

The idea is to use a `char` pointer instead of a `string` object to receive the keyboard input. This approach fails immediately because merely creating a pointer doesn't create space to hold the input strings. (The program would compile, but it would quite possibly crash after `cin` tried to store input in some inappropriate location.)

Version 2 replaces

```
string po;
```

with

```
char po[40];
```

This allocates space for an input string. Furthermore, `po` is of type `char *`, so it can be placed on the stack. But an array is fundamentally at odds with the assumptions made for the `pop()` method:

```
template <class Type>
bool Stack<Type>::pop(Type & item)
{
    if (top > 0)
    {
        item = items[--top];
        return true;
    }
}
```

```

    else
        return false;
}

```

First, the reference variable `item` has to refer to an lvalue of some sort, not to an array name. Second, the code assumes that you can assign to `item`. Even if `item` could refer to an array, you can't assign to an array name. So this approach fails, too.

Version 3 replaces

```
string po;
```

with

```
char * po = new char[40];
```

This allocates space for an input string. Furthermore, `po` is a variable and hence compatible with the code for `pop()`. Here, however, you come up against the most fundamental problem: There is only one `po` variable, and it always points to the same memory location. True, the contents of the memory change each time a new string is read, but every push operation puts exactly the same address onto the stack. So when you pop the stack, you always get the same address back, and it always refers to the last string read into memory. In particular, the stack is not storing each new string separately as it comes in, and it serves no useful purpose.

### Using a Stack of Pointers Correctly

One way to use a stack of pointers is to have the calling program provide an array of pointers, with each pointer pointing to a different string. Putting these pointers on a stack then makes sense because each pointer will refer to a different string. Note that it is the responsibility of the calling program, not the stack, to create the separate pointers. The stack's job is to manage the pointers, not create them.

For example, suppose you have to simulate the following situation. Someone has delivered a cart of folders to Plodson. If Plodson's in-basket is empty, he removes the top folder from the cart and places it in his in-basket. If his in-basket is full, Plodson removes the top file from the basket, processes it, and places it in his out-basket. If the in-basket is neither empty nor full, Plodson may process the top file in the in-basket, or he may take the next file from the cart and put it into his in-basket. In what he secretly regards as a bit of mad-cap self-expression, he flips a coin to decide which of these actions to take. You'd like to investigate the effects of his method on the original file order.

You can model this with an array of pointers to strings representing the files on the cart. Each string will contain the name of the person described by the file. You can use a stack to represent the in-basket, and you can use a second array of pointers to represent the out-basket. Adding a file to the in-basket is represented by pushing a pointer from the input array onto the stack, and processing a file is represented by popping an item from the stack and adding it to the out-basket.

Given the importance of examining all aspects of this problem, it would be useful to be able to try different stack sizes. Listing 14.15 redefines the `Stack<Type>` class slightly so that the `Stack` constructor accepts an optional size argument. This involves using a dynamic array internally, so the class now needs a destructor, a copy constructor, and an assignment operator. Also the definition shortens the code by making several of the methods inline.

**Listing 14.15** `stcktp1.h`

---

```
// stcktp1.h -- modified Stack template
#ifndef STCKTP1_H_
#define STCKTP1_H_

template <class Type>
class Stack
{
private:
    enum {SIZE = 10};    // default size
    int stacksize;
    Type * items;       // holds stack items
    int top;           // index for top stack item
public:
    explicit Stack(int ss = SIZE);
    Stack(const Stack & st);
    ~Stack() { delete [] items; }
    bool isempty() { return top == 0; }
    bool isfull() { return top == stacksize; }
    bool push(const Type & item);    // add item to stack
    bool pop(Type & item);          // pop top into item
    Stack & operator=(const Stack & st);
};

template <class Type>
Stack<Type>::Stack(int ss) : stacksize(ss), top(0)
{
    items = new Type [stacksize];
}

template <class Type>
Stack<Type>::Stack(const Stack & st)
{
    stacksize = st.stacksize;
    top = st.top;
    items = new Type [stacksize];
    for (int i = 0; i < top; i++)
        items[i] = st.items[i];
}
}
```

```

template <class Type>
bool Stack<Type>::push(const Type & item)
{
    if (top < stacksize)
    {
        items[top++] = item;
        return true;
    }
    else
        return false;
}

template <class Type>
bool Stack<Type>::pop(Type & item)
{
    if (top > 0)
    {
        item = items[--top];
        return true;
    }
    else
        return false;
}

template <class Type>
Stack<Type> & Stack<Type>::operator=(const Stack<Type> & st)
{
    if (this == &st)
        return *this;
    delete [] items;
    stacksize = st.stacksize;
    top = st.top;
    items = new Type [stacksize];
    for (int i = 0; i < top; i++)
        items[i] = st.items[i];
    return *this;
}

#endif

```

---

Notice that the prototype declares the return type for the assignment operator function to be a reference to `Stack`, and the actual template function definition identifies the type as `Stack<Type>`. The former is an abbreviation for the latter, but it can be used only within the class scope. That is, you can use `Stack` inside the template declaration and inside the template function definitions, but outside the class, as when identifying return

types and when using the scope-resolution operator, you need to use the full `Stack<Type>` form.

The program in Listing 14.16 uses the new stack template to implement the Plodson simulation. It uses `rand()`, `srand()`, and `time()` in the same way previous simulations have used them to generate random numbers. In this case, randomly generating a 0 or a 1 simulates the coin toss.

#### Listing 14.16 `stkoptr1.cpp`

---

```
// stkoptr1.cpp -- testing stack of pointers
#include <iostream>
#include <cstdlib>    // for rand(), srand()
#include <ctime>      // for time()
#include "stcktpl.h"
const int Num = 10;
int main()
{
    std::srand(std::time(0)); // randomize rand()
    std::cout << "Please enter stack size: ";
    int stacksize;
    std::cin >> stacksize;
    // create an empty stack with stacksize slots
    Stack<const char *> st(stacksize);

    // in basket
    const char * in[Num] = {
        " 1: Hank Gilgamesh", " 2: Kiki Ishtar",
        " 3: Betty Rocker", " 4: Ian Flagranti",
        " 5: Wolfgang Kibble", " 6: Portia Koop",
        " 7: Joy Almondo", " 8: Xaverie Paprika",
        " 9: Juan Moore", "10: Misha Mache"
    };

    // out basket
    const char * out[Num];

    int processed = 0;
    int nextin = 0;
    while (processed < Num)
    {
        if (st.isempty())
            st.push(in[nextin++]);
        else if (st.isfull())
            st.pop(out[processed++]);
        else if (std::rand() % 2 && nextin < Num)    // 50-50 chance
            st.push(in[nextin++]);
        else
            st.pop(out[processed++]);
    }
}
```



```

    }
    for (int i = 0; i < Num; i++)
        std::cout << out[i] << std::endl;

    std::cout << "Bye\n";
    return 0;
}

```

---

Two sample runs of the program in Listing 14.16 follow (note that, thanks to the randomizing feature, the final file ordering can differ quite a bit from one trial to the next, even when the stack size is kept unaltered):

Please enter stack size: 5

```

2: Kiki Ishtar
1: Hank Gilgamesh
3: Betty Rocker
5: Wolfgang Kibble
4: Ian Flagranti
7: Joy Almondo
9: Juan Moore
8: Xaverie Paprika
6: Portia Koop
10: Misha Mache
Bye

```

Please enter stack size: 5

```

3: Betty Rocker
5: Wolfgang Kibble
6: Portia Koop
4: Ian Flagranti
8: Xaverie Paprika
9: Juan Moore
10: Misha Mache
7: Joy Almondo
2: Kiki Ishtar
1: Hank Gilgamesh
Bye

```

### Program Notes

The strings in Listing 14.16 never move. Pushing a string onto the stack really creates a new pointer to an existing string. That is, it creates a pointer whose value is the address of an existing string. And popping a string off the stack copies that address value into the out array.

The program uses `const char *` as a type because the array of pointers is initialized to a set of string constants.

What effect does the stack destructor have on the strings? None. The class constructor uses `new` to create an array for holding pointers. The class destructor eliminates that array, not the strings to which the array elements pointed.

## An Array Template Example and Non-Type Arguments

Templates are frequently used for container classes because the idea of type parameters matches well with the need to apply a common storage plan to a variety of types. Indeed, the desire to provide reusable code for container classes was the main motivation for introducing templates, so let's look at another example and explore a few more facets of template design and use. In particular, let's look at non-type, or expression, arguments and at using an array to handle an inheritance family.

Let's begin with a simple array template that lets you specify an array size. One technique, which the last version of the `Stack` template uses, is to use a dynamic array within the class and a constructor argument to provide the number of elements. Another approach is to use a template argument to provide the size for a regular array. That is what the new C++11 array template does. Listing 14.17 shows a more modest version of how this can be done.

Listing 14.17 `arraytp.h`

---

```
//arraytp.h -- Array Template
#ifndef ARRAYTP_H_
#define ARRAYTP_H_

#include <iostream>
#include <cstdlib>

template <class T, int n>
class ArrayTP
{
private:
    T ar[n];
public:
    ArrayTP() {}
    explicit ArrayTP(const T & v);
    virtual T & operator[](int i);
    virtual T operator[](int i) const;
};

template <class T, int n>
ArrayTP<T,n>::ArrayTP(const T & v)
{
    for (int i = 0; i < n; i++)
        ar[i] = v;
}
```

```

template <class T, int n>
T & ArrayTP<T,n>::operator[] (int i)
{
    if (i < 0 || i >= n)
    {
        std::cerr << "Error in array limits: " << i
            << " is out of range\n";
        std::exit(EXIT_FAILURE);
    }
    return ar[i];
}

template <class T, int n>
T ArrayTP<T,n>::operator[] (int i) const
{
    if (i < 0 || i >= n)
    {
        std::cerr << "Error in array limits: " << i
            << " is out of range\n";
        std::exit(EXIT_FAILURE);
    }
    return ar[i];
}

#endif

```

---

Note the template heading in Listing 14.17:

```
template <class T, int n>
```

The keyword `class` (or, equivalently in this context, `typename`) identifies `T` as a type parameter, or type argument. `int` identifies `n` as being an `int` type. This second kind of parameter, one that specifies a particular type instead of acting as a generic name for a type, is called a *non-type*, or *expression, argument*. Suppose you have the following declaration:

```
ArrayTP<double, 12> eggweights;
```

This causes the compiler to define a class called `ArrayTP<double, 12>` and to create an `eggweights` object of that class. When defining the class, the compiler replaces `T` with `double` and `n` with `12`.

Expression arguments have some restrictions. An expression argument can be an integer type, an enumeration type, a reference, or a pointer. Thus, `double m` is ruled out, but `double & rm` and `double * pm` are allowed. Also the template code can't alter the value of the argument or take its address. Thus, in the `ArrayTP` template, expressions such as `n++` or `&n` would not be allowed. Also when you instantiate a template, the value used for the expression argument should be a constant expression.

This approach for sizing an array has one advantage over the constructor approach used in `stack`. The constructor approach uses heap memory managed by `new` and `delete`, whereas the expression argument approach uses the memory stack maintained for automatic variables. This provides faster execution time, particularly if you have a lot of small arrays.

The main drawback to the expression argument approach is that each array size generates its own template. That is, the following declarations generate two separate class declarations:

```
ArrayTP<double, 12> eggweights;
ArrayTP<double, 13> donuts;
```

But the following declarations generate just one class declaration, and the size information is passed to the constructor for that class:

```
Stack<int> eggs(12);
Stack<int> dunkers(13);
```

Another difference is that the constructor approach is more versatile because the array size is stored as a class member rather than being hard-coded into the definition. This makes it possible, for example, to define assignment from an array of one size to an array of another size or to build a class that allows resizable arrays.

## Template Versatility

You can apply the same techniques to template classes as you do to regular classes. Template classes can serve as base classes, and they can be component classes. They can themselves be type arguments to other templates. For example, you can implement a stack template by using an array template. Or you can have an array template that is used to construct an array whose elements are stacks based on a stack template. That is, you can have code along the following lines:

```
template <typename T>    // or <class T>
class Array
{
private:
    T entry;
    ...
};

template <typename Type>
class GrowArray : public Array<Type> {...}; // inheritance

template <typename Tp>
class Stack
{
    Array<Tp> ar;    // use an Array<> as a component
    ...
};
```

```
};
...
Array < Stack<int> > asi; // an array of stacks of int
```

In the last statement, C++98 required separating the two > symbols by at least one white space character in order to avoid confusion with the >> operator. C++11 removes this requirement.

### Using a Template Recursively

Another example of template versatility is that you can use templates recursively. For example, given the earlier definition of an array template, you can use it as follows:

```
ArrayTP< ArrayTP<int,5>, 10> twodee;
```

This makes `twodee` an array of 10 elements, each of which is an array of five ints. The equivalent ordinary array would have this declaration:

```
int twodee[10][5];
```

Note that the syntax for templates presents the dimensions in the opposite order from that of the equivalent ordinary two-dimensional array. The program in Listing 14.18 tries this idea. It also uses the `ArrayTP` template to create one-dimensional arrays to hold the sum and average value of each of the 10 sets of five numbers. The method call `cout.width(2)` causes the next item to be displayed to use a field width of two characters, unless a larger width is needed to show the whole number.

#### Listing 14.18 `twod.cpp`

---

```
// twod.cpp -- making a 2-d array
#include <iostream>
#include "arraytp.h"
int main(void)
{
    using std::cout;
    using std::endl;
    ArrayTP<int, 10> sums;
    ArrayTP<double, 10> aves;
    ArrayTP< ArrayTP<int,5>, 10> twodee;

    int i, j;

    for (i = 0; i < 10; i++)
    {
        sums[i] = 0;
        for (j = 0; j < 5; j++)
        {
            twodee[i][j] = (i + 1) * (j + 1);
```

```

        sums[i] += twodee[i][j];
    }
    aves[i] = (double) sums[i] / 10;
}
for (i = 0; i < 10; i++)
{
    for (j = 0; j < 5; j++)
    {
        cout.width(2);
        cout << twodee[i][j] << ' ';
    }
    cout << ": sum = ";
    cout.width(3);
    cout << sums[i] << ", average = " << aves[i] << endl;
}

cout << "Done.\n";

return 0;
}

```

---

The output of the program in Listing 14.18 has one line for each of the 10 elements of `twodee`, each of which is a five-element array. Each line shows the values, sum, and average of an element of `twodee`:

```

1 2 3 4 5 : sum = 15, average = 1.5
2 4 6 8 10 : sum = 30, average = 3
3 6 9 12 15 : sum = 45, average = 4.5
4 8 12 16 20 : sum = 60, average = 6
5 10 15 20 25 : sum = 75, average = 7.5
6 12 18 24 30 : sum = 90, average = 9
7 14 21 28 35 : sum = 105, average = 10.5
8 16 24 32 40 : sum = 120, average = 12
9 18 27 36 45 : sum = 135, average = 13.5
10 20 30 40 50 : sum = 150, average = 15
Done.

```

### Using More Than One Type Parameter

You can have a template with more than one type parameter. For example, suppose you want a class that holds two kinds of values. You can create and use a `Pair` template class for holding two disparate values. (Incidentally, the STL provides a similar template called `pair`.) The short program in Listing 14.19 shows an example. In it, the `first()` `const` and `second()` `const` methods report the stored values, and the `first()` and `second()` methods, by virtue of returning references to the `Pair` data members, allow you to reset the stored values by using assignment.

Listing 14.19 `pairs.cpp`

---

```
// pairs.cpp -- defining and using a Pair template
#include <iostream>
#include <string>
template <class T1, class T2>
class Pair
{
private:
    T1 a;
    T2 b;
public:
    T1 & first();
    T2 & second();
    T1 first() const { return a; }
    T2 second() const { return b; }
    Pair(const T1 & aval, const T2 & bval) : a(aval), b(bval) { }
    Pair() {}
};

template<class T1, class T2>
T1 & Pair<T1,T2>::first()
{
    return a;
}
template<class T1, class T2>
T2 & Pair<T1,T2>::second()
{
    return b;
}

int main()
{
    using std::cout;
    using std::endl;
    using std::string;
    Pair<string, int> ratings[4] =
    {
        Pair<string, int>("The Purpled Duck", 5),
        Pair<string, int>("Jaquie's Frisco Al Fresco", 4),
        Pair<string, int>("Cafe Souffle", 5),
        Pair<string, int>("Bertie's Eats", 3)
    };

    int joints = sizeof(ratings) / sizeof (Pair<string, int>);
    cout << "Rating:\t Eatery\n";
    for (int i = 0; i < joints; i++)
```

```

        cout << ratings[i].second() << ":\t "
            << ratings[i].first() << endl;
    cout << "Oops! Revised rating:\n";
    ratings[3].first() = "Bertie's Fab Eats";
    ratings[3].second() = 6;
    cout << ratings[3].second() << ":\t "
        << ratings[3].first() << endl;
    return 0;
}

```

---

One thing to note about Listing 14.19 is that in `main()`, you have to use `Pair<string, int>` to invoke the constructors and as an argument for `sizeof`. That's because `Pair<string, int>` and not `Pair` is the class name. Also `Pair<char *, double>` would be the name of an entirely different class.

Here's the output of the program in Listing 14.19:

```

Rating:  Eatery
5:      The Purpled Duck
4:      Jaquie's Frisco Al Fresco
5:      Cafe Souffle
3:      Bertie's Eats
Oops! Revised rating:
6:      Bertie's Fab Eats

```

## Default Type Template Parameters

Another new class template feature is that you can provide default values for type parameters:

```
template <class T1, class T2 = int> class Topo {...};
```

This causes the compiler to use `int` for the type `T2` if a value for `T2` is omitted:

```

Topo<double, double> m1; // T1 is double, T2 is double
Topo<double> m2;        // T1 is double, T2 is int

```

The STL (discussed in Chapter 16) often uses this feature, with the default type being a class.

Although you can provide default values for class template type parameters, you can't do so for function template parameters. However, you can provide default values for non-type parameters for both class and function templates.

## Template Specializations

Class templates are like function templates in that you can have implicit instantiations, explicit instantiations, and explicit specializations, collectively known as *specializations*.



That is, a template describes a class in terms of a general type, whereas a specialization is a class declaration generated by using a specific type.

### Implicit Instantiations

The template examples you have seen so far in this chapter use *implicit instantiations*. That is, they declare one or more objects indicating the desired type, and the compiler generates a specialized class definition, using the recipe provided by the general template:

```
ArrayTP<int, 100> stuff; // implicit instantiation
```

The compiler doesn't generate an implicit instantiation of the class until it needs an object:

```
ArrayTP<double, 30> * pt; // a pointer, no object needed yet
pt = new ArrayTP<double, 30>; // now an object is needed
```

The second statement causes the compiler to generate a class definition and also an object that is created according to that definition.

### Explicit Instantiations

The compiler generates an *explicit instantiation* of a class declaration when you declare a class by using the keyword `template` and indicating the desired type or types. The declaration should be in the same namespace as the template definition. For example, the following declaration declares `ArrayTP<string, 100>` to be a class:

```
template class ArrayTP<string, 100>; // generate ArrayTP<string, 100> class
```

In this case, the compiler generates the class definition, including method definitions, even though no object of the class has yet been created or mentioned. Just as with the implicit instantiation, the general template is used as a guide to generate the specialization.

### Explicit Specializations

An *explicit specialization* is a definition for a particular type or types that is to be used instead of the general template. Sometimes you might need or want to modify a template to behave differently when instantiated for a particular type; in that case, you can create an explicit specialization. Suppose, for example, that you've defined a template for a class that represents a sorted array for which items are sorted as they are added to the array:

```
template <typename T>
class SortedArray
{
    ...// details omitted
};
```

Also suppose the template uses the `>` operator to compare values. This works well for numbers. It will work if `T` represents a class type, too, provided that you've defined a `T::operator>()` method. But it won't work if `T` is a string represented by type `const char *`. Actually, the template will work, but the strings will wind up sorted by address

rather than alphabetically. What is needed is a class definition that uses `strcmp()` instead of `>`. In such a case, you can provide an explicit template specialization. This takes the form of a template defined for one specific type instead of for a general type. When faced with the choice of a specialized template and a general template that both match an instantiation request, the compiler uses the specialized version.

A specialized class template definition has the following form:

```
template <> class Classname<specialized-type-name> { ... };
```

Older compilers may only recognize the older form, which dispenses with the `template <>` prefix:

```
class Classname<specialized-type-name> { ... };
```

To provide a `SortedArray` template specialized for the `const char *` type, using the current notation, you would use code like the following:

```
template <> class SortedArray<const char *>
{
    ...// details omitted
};
```

Here the implementation code would use `strcmp()` instead of `>` to compare array values. Now, requests for a `SortedArray` template of `const char *` will use this specialized definition instead of the more general template definition:

```
SortedArray<int> scores;           // use general definition
SortedArray<const char *> dates; // use specialized definition
```

## Partial Specializations

C++ allows for *partial specializations*, which partially restrict the generality of a template. For example, a partial specialization can provide a specific type for one of the type parameters:

```
// general template
template <class T1, class T2> class Pair {...};
// specialization with T2 set to int
template <class T1> class Pair<T1, int> {...};
```

The `<>` following the keyword `template` declares the type parameters that are still unspecialized. So the second declaration specializes `T2` to `int` but leaves `T1` open. Note that specifying all the types leads to an empty bracket pair and a complete explicit specialization:

```
// specialization with T1 and T2 set to int
template <> class Pair<int, int> {...};
```

The compiler uses the most specialized template if there is a choice. Here's what would happen given the preceding three templates:

```
Pair<double, double> p1; // use general Pair template
Pair<double, int> p2;   // use Pair<T1, int> partial specialization
Pair<int, int> p3;     // use Pair<int, int> explicit specialization
```

Or you can partially specialize an existing template by providing a special version for pointers:

```
template<class T>      // general version
class Feeb { ... };
template<class T*>    // pointer partial specialization
class Feeb { ... };  // modified code
```

If you provide a non-pointer type, the compiler uses the general version; if you provide a pointer, the compiler uses the pointer specialization:

```
Feeb<char> fb1;      // use general Feeb template, T is char
Feeb<char *> fb2;    // use Feeb T* specialization, T is char
```

Without the partial specialization, the second declaration would use the general template, interpreting `T` as type `char *`. With the partial specialization, it uses the specialized template, interpreting `T` as `char`.

The partial specialization feature allows for making a variety of restrictions. For example, you can use the following:

```
// general template
    template <class T1, class T2, class T3> class Trio{...};
// specialization with T3 set to T2
    template <class T1, class T2> class Trio<T1, T2, T2> {...};
// specialization with T3 and T2 set to T1*
    template <class T1> class Trio<T1, T1*, T1*> {...};
```

Given these declarations, the compiler would make the following choices:

```
Trio<int, short, char *> t1; // use general template
Trio<int, short> t2; // use Trio<T1, T2, T2>
Trio<char, char *, char *> t3; use Trio<T1, T1*, T1*>
```

## Member Templates

A template can be a member of a structure, class, or template class. The STL requires this feature to fully implement its design. Listing 14.20 provides a short example of a template class with a nested template class and a template function as members.

Listing 14.20 `tempmemb.cpp`

---

```
// tempmemb.cpp -- template members
#include <iostream>
using std::cout;
using std::endl;
```

```

template <typename T>
class beta
{
private:
    template <typename V> // nested template class member
    class hold
    {
private:
        V val;
public:
        hold(V v = 0) : val(v) {}
        void show() const { cout << val << endl; }
        V Value() const { return val; }
    };
    hold<T> q;           // template object
    hold<int> n;         // template object
public:
    beta( T t, int i) : q(t), n(i) {}
    template<typename U> // template method
    U blab(U u, T t) { return (n.Value() + q.Value()) * u / t; }
    void Show() const { q.show(); n.show();}
};

int main()
{
    beta<double> guy(3.5, 3);
    cout << "T was set to double\n";
    guy.Show();
    cout << "V was set to T, which is double, then V was set to int\n";
    cout << guy.blab(10, 2.3) << endl;
    cout << "U was set to int\n";
    cout << guy.blab(10.0, 2.3) << endl;
    cout << "U was set to double\n";
    cout << "Done\n";
    return 0;
}

```

---

The `hold` template is declared in the private section in Listing 14.20, so it is accessible only within the `beta` class scope. The `beta` class uses the `hold` template to declare two data members:

```

hold<T> q;           // template object
hold<int> n;         // template object

```

n is a hold object based on the `int` type, and the `q` member is a hold object based on the `T` type (the beta template parameter). In `main()`, the following declaration makes `T` represent `double`, making `q` type `hold<double>`:

```
beta<double> guy(3.5, 3);
```

The `blab()` method has one type (`U`) that is determined implicitly by the argument value when the method is called and one type (`T`) that is determined by the instantiation type of the object. In this example, the declaration for `guy` sets `T` to type `double`, and the first argument in the method call in the following sets `U` to type `int`, matching the value 10:

```
cout << guy.blab(10, 2.5) << endl;
```

Thus, although the automatic type conversions brought about by mixed types cause the calculation in `blab()` to be done as type `double`, the return value, being type `U`, is an `int`. Hence, it is truncated to 28, as the following program output shows:

```
T was set to double
3.5
3
V was set to T, which is double, then V was set to int
28
U was set to int
28.2609
U was set to double
Done
```

Note that replacing 10 with 10.0 in the call to `guy.blab()` causes `U` to be set to `double`, making the return type `double`, which is reflected in 28.2609 being displayed.

As mentioned previously, the type of the second parameter is set to `double` by the declaration of the `guy` object. Unlike the first parameter, then, the type of the second parameter is not set by the function call. For instance, the following statement would still implement `blab()` as `blab(int, double)`, and the 3 would be converted to type `double` by the usual function prototype rules:

```
cout << guy.blab(10, 3) << endl;
```

You can declare the `hold` class and `blab` method in the beta template and define them outside the beta template. However, sufficiently old compilers won't accept template members at all, and others that accept them as shown in Listing 14.20 don't accept definitions outside the class. However, if your compiler is willing and able, here's how defining the template methods outside the beta template would look:

```
template <typename T>
class beta
{
private:
    template <typename V> // declaration
```

```

class hold;
hold<T> q;
hold<int> n;
public:
    beta( T t, int i) : q(t), n(i) {}
    template<typename U> // declaration
    U blab(U u, T t);
    void Show() const { q.show(); n.show();}
};

// member definition
template <typename T>
template<typename V>
class beta<T>::hold
{
private:
    V val;
public:
    hold(V v = 0) : val(v) {}
    void show() const { std::cout << val << std::endl; }
    V Value() const { return val; }
};

// member definition
template <typename T>
template <typename U>
U beta<T>::blab(U u, T t)
{
    return (n.Value() + q.Value()) * u / t;
}

```

The definitions have to identify `T`, `v`, and `U` as template parameters. Because the templates are nested, you have to use the

```

template <typename T>
template <typename V>

```

syntax instead of this syntax:

```

template<typename T, typename V>

```

The definitions also must indicate that `hold` and `blab` are members of the `beta<T>` class, and they use the scope-resolution operator to do so.

## Templates As Parameters

You've seen that a template can have type parameters, such as `typename T`, and non-type parameters, such as `int n`. A template can also have a parameter that is itself a

template. Such parameters are yet another template feature addition that is used to implement the STL.

Listing 14.21 shows an example that begins with these lines:

```
template <template <typename T> class Thing>
class Crab
```

The template parameter is `template <typename T> class Thing`. Here `template <typename T> class` is the type, and `Thing` is the parameter. What does this imply? Suppose you have this declaration:

```
Crab<King> legs;
```

For this to be accepted, the template argument `King` has to be a template class whose declaration matches that of the template parameter `Thing`:

```
template <typename T>
class King {...};
```

The `Crab` declaration in Listing 14.21 declares two objects:

```
Thing<int> s1;
Thing<double> s2;
```

The previous declaration for `legs` would then result in substituting `King<int>` for `Thing<int>` and `King<double>` for `Thing<double>`. However, Listing 14.21 has this declaration:

```
Crab<Stack> nebula;
```

Hence, in this case, `Thing<int>` is instantiated as `Stack<int>`, and `Thing<double>` is instantiated as `Stack<double>`. In short, the template parameter `Thing` is replaced by whatever template type is used as a template argument in declaring a `Crab` object.

The `Crab` class declaration makes three further assumptions about the template class represented by `Thing`. The class should have a `push()` method, the class should have a `pop()` method, and these methods should have a particular interface. The `Crab` class can use any template class that matches the `Thing` type declaration and that has the prerequisite `push()` and `pop()` methods. This chapter happens to have one such class, the `Stack` template defined in `stacktp.h`, so the example uses that class.

#### Listing 14.21 `tempparm.cpp`

---

```
// tempparm.cpp - templates as parameters
#include <iostream>
#include "stacktp.h"

template <template <typename T> class Thing>
class Crab
{
private:
    Thing<int> s1;
```

```

    Thing<double> s2;
public:
    Crab() {};
    // assumes the thing class has push() and pop() members
    bool push(int a, double x) { return s1.push(a) && s2.push(x); }
    bool pop(int & a, double & x){ return s1.pop(a) && s2.pop(x); }
};

int main()
{
    using std::cout;
    using std::cin;
    using std::endl;
    Crab<Stack> nebula;
// Stack must match template <typename T> class thing
    int ni;
    double nb;
    cout << "Enter int double pairs, such as 4 3.5 (0 0 to end):\n";
    while (cin>> ni >> nb && ni > 0 && nb > 0)
    {
        if (!nebula.push(ni, nb))
            break;
    }

    while (nebula.pop(ni, nb))
        cout << ni << ", " << nb << endl;
    cout << "Done.\n";

    return 0;
}

```

---

Here is a sample run of the program in Listing 14.21:

```

Enter int double pairs, such as 4 3.5 (0 0 to end):
50 22.48
25 33.87
60 19.12
0 0
60, 19.12
25, 33.87
50, 22.48
Done.

```

You can mix template parameters with regular parameters. For example, the Crab class declaration could start out like this:

```

template <template <typename T> class Thing, typename U, typename V>
class Crab

```



```
{
private:
    Thing<U> s1;
    Thing<V> s2;
...

```

Now the types to be stored in the members `s1` and `s2` are generic types instead of hard-coded types. This would require the declaration of `nebula` in the program to be changed to this:

```
Crab<Stack, int, double> nebula; // T=Stack, U=int, V=double
```

The `template` parameter `T` represents a template type, and the type parameters `U` and `V` represent non-template types.

## Template Classes and Friends

Template class declarations can have friends, too. You can classify friends of templates into three categories:

- Non-template friends
- Bound template friends, meaning the type of the friend is determined by the type of the class when a class is instantiated
- Unbound template friends, meaning that all specializations of the friend are friends to each specialization of the class

Let's look at examples of each.

### Non-Template Friend Functions to Template Classes

Let's declare an ordinary function in a template class as a friend:

```
template <class T>
class HasFriend
{
public:
    friend void counts();    // friend to all HasFriend instantiations
    ...
};
```

This declaration makes the `counts()` function a friend to all possible instantiations of the template. For example, it would be a friend to the `HasFriend<int>` class and the `HasFriend<string>` class.

The `counts()` function is not invoked by an object (it's a friend, not a member function), and it has no object parameters, so how does it access a `HasFriend` object? There are several possibilities. It could access a global object; it could access nonglobal objects by using a global pointer; it could create its own objects; and it could access static data members of a template class, which exist separately from an object.

Suppose you want to provide a template class argument to a friend function. Can you have a friend declaration like this, for example?

```
friend void report(HasFriend &); // possible?
```

The answer is no. The reason is that there is no such thing as a `HasFriend` object. There are only particular specializations, such as `HasFriend<short>`. To provide a template class argument, then, you have to indicate a specialization. For example, you can use this:

```
template <class T>
class HasFriend
{
    friend void report(HasFriend<T> &); // bound template friend
    ...
};
```

To understand what this does, imagine the specialization produced if you declare an object of a particular type:

```
HasFriend<int> hf;
```

The compiler would replace the template parameter `T` with `int`, giving the friend declaration this form:

```
class HasFriend<int>
{
    friend void report(HasFriend<int> &); // bound template friend
    ...
};
```

That is, `report()` with a `HasFriend<int>` parameter becomes a friend to the `HasFriend<int>` class. Similarly, `report()` with a `HasFriend<double>` parameter would be an overloaded version of `report()` that is a friend to the `HasFriend<double>` class.

Note that `report()` is not itself a template function; it just has a parameter that is a template. This means that you have to define explicit specializations for the friends you plan to use:

```
void report(HasFriend<short> &) {...}; // explicit specialization for short
void report(HasFriend<int> &) {...}; // explicit specialization for int
```

Listing 14.22 illustrates these points. The `HasFriend` template has a static member `ct`. Note that this means that each particular specialization of the class has its own static member. The `counts()` method, which is a friend to all `HasFriend` specializations, reports the value of `ct` for two particular specializations: `HasFriend<int>` and `HasFriend<double>`. The program also provides two `report()` functions, each of which is a friend to one particular `HasFriend` specialization.

Listing 14.22 `frnd2tmp.cpp`

---

```

// frnd2tmp.cpp -- template class with non-template friends
#include <iostream>
using std::cout;
using std::endl;

template <typename T>
class HasFriend
{
private:
    T item;
    static int ct;
public:
    HasFriend(const T & i) : item(i) {ct++;}
    ~HasFriend() {ct--;}
    friend void counts();
    friend void reports(HasFriend<T> &); // template parameter
};

// each specialization has its own static data member
template <typename T>
int HasFriend<T>::ct = 0;

// non-template friend to all HasFriend<T> classes
void counts()
{
    cout << "int count: " << HasFriend<int>::ct << " ";
    cout << "double count: " << HasFriend<double>::ct << endl;
}

// non-template friend to the HasFriend<int> class
void reports(HasFriend<int> & hf)
{
    cout << "HasFriend<int>: " << hf.item << endl;
}

// non-template friend to the HasFriend<double> class
void reports(HasFriend<double> & hf)
{
    cout << "HasFriend<double>: " << hf.item << endl;
}

int main()
{
    cout << "No objects declared: ";
    counts();
}

```

```

HasFriend<int> hfi1(10);
cout << "After hfi1 declared: ";
counts();
HasFriend<int> hfi2(20);
cout << "After hfi2 declared: ";
counts();
HasFriend<double> hfdb(10.5);
cout << "After hfdb declared: ";
counts();
reports(hfi1);
reports(hfi2);
reports(hfdb);

return 0;
}

```

---

Some compilers will warn about using a non-template friend. Here is the output of the program in Listing 14.22:

```

No objects declared: int count: 0; double count: 0
After hfi1 declared: int count: 1; double count: 0
After hfi2 declared: int count: 2; double count: 0
After hfdb declared: int count: 2; double count: 1
HasFriend<int>: 10
HasFriend<int>: 20
HasFriend<double>: 10.5

```

### Bound Template Friend Functions to Template Classes

You can modify the preceding example by making the friend functions templates themselves. In particular, you can set things up for bound template friends, so each specialization of a class gets a matching specialization for a friend. The technique is a bit more complex than for non-template friends and involves three steps.

For the first step, you declare each template function before the class definition:

```

template <typename T> void counts();
template <typename T> void report(T &);

```

Next, you declare the templates again as friends inside the function. These statements declare specializations based on the class template parameter type:

```

template <typename TT>
class HasFriendT
{
...
    friend void counts<TT>();
    friend void report<>(HasFriendT<TT> &);
};

```

The `<>` in the declarations identifies these as template specializations. In the case of `report()`, the `<>` can be left empty because the following template type argument can be deduced from the function argument:

```
HasFriendT<TT>
```

You could, however, use this instead:

```
report<HasFriendT<TT> >(HasFriendT<TT> &)
```

However, the `counts()` function has no parameters, so you have to use the template argument syntax (`<TT>`) to indicate its specialization. Note, too, that `TT` is the parameter type for the `HasFriendT` class.

Again, the best way to understand these declarations is to imagine what they become when you declare an object of a particular specialization. For example, suppose you declare this object:

```
HasFriendT<int> squack;
```

Then the compiler substitutes `int` for `TT` and generates the following class definition:

```
class HasFriendT<int>
{
...
    friend void counts<int>();
    friend void report<>(HasFriendT<int> &);
};
```

One specialization is based on `TT`, which becomes `int`, and the other is based on `HasFriendT<TT>`, which becomes `HasFriendT<int>`. Thus, the template specializations `counts<int>()` and `report<HasFriendT<int> >()` are declared as friends to the `HasFriendT<int>` class.

The third requirement the program must meet is to provide template definitions for the friends. Listing 14.23 illustrates these three aspects. Note that Listing 14.22 has one `count()` function that is a friend to all `HasFriend` classes, whereas Listing 14.23 has two `count()` functions, one of which is a friend to each of the instantiated class types. Because the `count()` function calls have no function parameter from which the compiler can deduce the desired specialization, these calls use the `count<int>()` and `count<double>()` forms to indicate the specialization. For the calls to `report()`, however, the compiler can use the argument type to deduce the specialization. You could use the `<>` form to the same effect:

```
report<HasFriendT<int> >(hfi2); // same as report(hfi2);
```

#### Listing 14.23 `tmp2tmp.cpp`

---

```
// tmp2tmp.cpp -- template friends to a template class
#include <iostream>
using std::cout;
using std::endl;
```

```
// template prototypes
template <typename T> void counts();
template <typename T> void report(T &);

// template class
template <typename TT>
class HasFriendT
{
private:
    TT item;
    static int ct;
public:
    HasFriendT(const TT & i) : item(i) {ct++;}
    ~HasFriendT() { ct--; }
    friend void counts<TT>();
    friend void report<>(HasFriendT<TT> &);
};

template <typename T>
int HasFriendT<T>::ct = 0;

// template friend functions definitions
template <typename T>
void counts()
{
    cout << "template size: " << sizeof(HasFriendT<T>) << " ";
    cout << "template counts(): " << HasFriendT<T>::ct << endl;
}

template <typename T>
void report(T & hf)
{
    cout << hf.item << endl;
}

int main()
{
    counts<int>();
    HasFriendT<int> hf1(10);
    HasFriendT<int> hf2(20);
    HasFriendT<double> hfdb(10.5);
    report(hf1); // generate report(HasFriendT<int> &)
    report(hf2); // generate report(HasFriendT<int> &)
    report(hfdb); // generate report(HasFriendT<double> &)
    cout << "counts<int>() output:\n";
    counts<int>();
}
```

```

    cout << "counts<double>() output:\n";
    counts<double>();

    return 0;
}

```

---

Here is the output of the program in Listing 14.23:

```

template size: 4; template counts(): 0
10
20
10.5
counts<int>() output:
template size: 4; template counts(): 2
counts<double>() output:
template size: 8; template counts(): 1

```

As you can see, `counts<double>` reports a different template size from `counts<int>`, demonstrating that each `T` type now gets its own `count()` friend.

### Unbound Template Friend Functions to Template Classes

The bound template friend functions in the preceding section are template specializations of a template declared outside a class. An `int` class specialization gets an `int` function specialization, and so on. By declaring a template inside a class, you can create unbound friend functions for which every function specialization is a friend to every class specialization. For unbound friends, the friend template type parameters are different from the template class type parameters:

```

template <typename T>
class ManyFriend
{
    ...
    template <typename C, typename D> friend void show2(C &, D &);
};

```

Listing 14.24 shows an example that uses an unbound friend. In it, the function call `show2(hfi1, hfi2)` gets matched to the following specialization:

```

void show2<ManyFriend<int> &, ManyFriend<int> &>
    (ManyFriend<int> &c, ManyFriend<int> &d);

```

Because it is a friend to all specializations of `ManyFriend`, this function has access to the `item` members of all specializations. But it only uses access to `ManyFriend<int>` objects.

Similarly, `show2(hfd, hfi2)` gets matched to this specialization:

```

void show2<ManyFriend<double> &, ManyFriend<int> &>
    (ManyFriend<double> &c, ManyFriend<int> &d);

```

It, too, is a friend to all `ManyFriend` specializations, and it uses its access to the `item` member of a `ManyFriend<int>` object and to the `item` member of a `ManyFriend<double>` object.

**Listing 14.24** `manyfrnd.cpp`

---

```
// manyfrnd.cpp -- unbound template friend to a template class
#include <iostream>
using std::cout;
using std::endl;

template <typename T>
class ManyFriend
{
private:
    T item;
public:
    ManyFriend(const T & i) : item(i) {}
    template <typename C, typename D> friend void show2(C &, D &);
};

template <typename C, typename D> void show2(C & c, D & d)
{
    cout << c.item << ", " << d.item << endl;
}

int main()
{
    ManyFriend<int> hfi1(10);
    ManyFriend<int> hfi2(20);
    ManyFriend<double> hfdb(10.5);
    cout << "hfi1, hfi2: ";
    show2(hfi1, hfi2);
    cout << "hfdb, hfi2: ";
    show2(hfdb, hfi2);

    return 0;
}
```

---

Here's the output of the program in Listing 14.24:

```
hfi1, hfi2: 10, 20
hfdb, hfi2: 10.5, 20
```



## Template Aliases (C++11)

It can be convenient, especially in template design, to create aliases for types. You can use `typedef` to create aliases for template specializations:

```
// define three typedef aliases
typedef std::array<double, 12> arrd;
typedef std::array<int, 12> arri;
typedef std::array<std::string, 12> arrst;
arrd gallons; // gallons is type std::array<double, 12>
arri days;    // days is type std::array<int, 12>
arrst months; // months is type std::array<std::string, 12>
```

But if you find yourself writing code similar to the preceding `typedefs`, over and over, you might wonder if you've forgotten some language feature that simplifies the task or if the language has forgotten to supply such a feature. In this case, C++11 provides a feature previously missing—a way to use a template to provide a family of aliases. Here's what the approach looks like:

```
template<typename T>
using arrtype = std::array<T,12>; // template to create multiple aliases
```

This makes `arrtype` a template alias that can be used as a type, as follows:

```
arrtype<double> gallons; // gallons is type std::array<double, 12>
arrtype<int> days;      // days is type std::array<int, 12>
arrtype<std::string> months; // months is type std::array<std::string, 12>
```

In short, `arrtype<T>` means type `std::array<T,12>`.

C++11 extends the `using =` syntax to non-templates too. In that case, it becomes equivalent to an ordinary `typedef`:

```
typedef const char * pc1; // typedef syntax
using pc2 = const char *; // using = syntax
typedef const int *(*pa1)[10]; // typedef syntax
using pa2 = const int *(*)[10]; // using = syntax
```

As you get used to it, you may find the new form more readable because it separates the type name from type information more clearly.

Another C++11 addition to templates is the *variadic template*, which allows you to define a template class or function that can take a variable number of initializers. Chapter 18, “Visiting with the New C++ Standard,” looks into this topic.

## Summary

C++ provides several means for reusing code. Public inheritance, described in Chapter 13, “Class Inheritance,” enables you to model *is-a* relationships, with derived classes being able to reuse the code of base classes. Private and protected inheritance also let you reuse base-class code, this time modeling *has-a* relationships. With private inheritance, public

and protected members of the base class become private members of the derived class. With protected inheritance, public and protected members of the base class become protected members of the derived class. Thus, in either case, the public interface of the base class becomes an internal interface for the derived class. This is sometimes described as inheriting the implementation but not the interface because a derived object can't explicitly use the base-class interface. Thus, you can't view a derived object as a kind of base object. Because of this, a base-class pointer or reference is not allowed to refer to a derived object without an explicit type cast.

You can also reuse class code by developing a class with members that are themselves objects. This approach, called *containment*, *layering*, or *composition*, also models the *has-a* relationship. Containment is simpler to implement and use than private or protected inheritance, so it is usually preferred. However, private and protected inheritance have slightly different capabilities. For example, inheritance allows a derived class access to protected members of a base class. Also it allows a derived class to redefine a virtual function inherited from the base class. Because containment is not a form of inheritance, neither of these capabilities are options when you reuse class code via containment. On the other hand, containment is more suitable if you need several objects of a given class. For example, a `State` class could contain an array of `County` objects.

Multiple inheritance (MI) allows you to reuse code for more than one class in a class design. Private or protected MI models the *has-a* relationship, and public MI models the *is-a* relationship. MI can create problems with multidefined names and multi-inherited bases. You can use class qualifiers to resolve name ambiguities and virtual base classes to avoid multi-inherited bases. However, using virtual base classes introduces new rules for writing initialization lists for constructors and for resolving ambiguities.

Class templates let you create a generic class design in which a type, usually a member type, is represented by a type parameter. A typical template looks like this:

```
template <class T>
class Ic
{
    T v;
    ...
public:
    Ic(const T & val) : v(val) { }
    ...
};
```

Here `T` is the type parameter, and it acts as a stand-in for a real type to be specified at a later time. (This parameter can have any valid C++ name, but `T` and `Type` are common choices.) You can also use `typename` instead of `class` in this context:

```
template <typename T> // same as template <class T>
class Rev { ... } ;
```

Class definitions (instantiations) are generated when you declare a class object and specify a particular type. For example, the following declaration causes the compiler to

generate a class declaration in which every occurrence of the type parameter `T` in the template is replaced by the actual type `short` in the class declaration:

```
class Ic<short> sic; // implicit instantiation
```

In this case, the class name is `Ic<short>`, not `Ic`. `Ic<short>` is termed a *specialization* of the template. In particular, it is an implicit instantiation.

An explicit instantiation occurs when you declare a specific specialization of the class, using the keyword `template`:

```
template class IC<int>; // explicit instantiation
```

In this situation, the compiler uses the general template to generate an `int` specialization `Ic<int>`, even though no objects have yet been requested of that class.

You can provide explicit specializations, which are specialized class declarations that override a template definition. You just define the class, starting with `template<>`, and then you use the template class name, followed by angle brackets containing the type for which you want a specialization. For example, you could provide a specialized `Ic` class for character pointers as follows:

```
template <> class Ic<char *>.
{
    char * str;
    ...
public:
    Ic(const char * s) : str(s) { }
    ...
};
```

Then a declaration of the following form would use the specialized definition for `chic` rather than using the general template:

```
class Ic<char *> chic;
```

A class template can specify more than one generic type and can also have non-type parameters:

```
template <class T, class TT, int n>
class Pals {...};
```

The following declaration would generate an implicit instantiation using `double` for `T`, `string` for `TT`, and `6` for `n`:

```
Pals<double, string, 6> mix;
```

A class template can also have parameters that are templates:

```
template < template <typename T> class CL, typename U, int z>
class Trophy {...};
```

Here `z` stands for an `int` value, `U` stands for the name of a type, and `CL` stands for a class template declared using `template <typename T>`.

Class templates can be partially specialized:

```
template <class T> Pals<T, T, 10> {...};
template <class T, class TT> Pals<T, TT, 100> {...};
template <class T, int n> Pals <T, T*, n> {...};
```

The first example here creates a specialization in which both types are the same and  $n$  has the value 6. Similarly, the second creates a specialization for  $n$  equal to 100, and the third creates a specialization for which the second type is a pointer to the first type.

Template classes can be members of other classes, structures, and templates.

The goal of all these methods is to allow programmers to reuse tested code without having to copy it manually. This simplifies the programming task and makes programs more reliable.

## Chapter Review

- For each of the following sets of classes, indicate whether public or private derivation is more appropriate for Column B:

| A                              | B                    |
|--------------------------------|----------------------|
| class Bear                     | class PolarBear      |
| class Kitchen                  | class Home           |
| class Person                   | class Programmer     |
| class Person                   | class HorseAndJockey |
| class Person, class Automobile | class Driver         |

- Suppose you have the following definitions:

```
class Frabjous {
private:
    char fab[20];
public:
    Frabjous(const char * s = "C++") : fab(s) { }
    virtual void tell() { cout << fab; }
};

class Gloam {
private:
    int glip;
    Frabjous fb;
public:
    Gloam(int g = 0, const char * s = "C++");
    Gloam(int g, const Frabjous & f);
    void tell();
};
```

Given that the `Gloam` version of `tell()` should display the values of `glip` and `fab`, provide definitions for the three `Gloam` methods.

3. Suppose you have the following definitions:

```
class Frabjous {
private:
    char fab[20];
public:
    Frabjous(const char * s = "C++") : fab(s) { }
    virtual void tell() { cout << fab; }
};

class Gloam : private Frabjous{
private:
    int glip;
public:
    Gloam(int g = 0, const char * s = "C++");
    Gloam(int g, const Frabjous & f);
    void tell();
};
```

Given that the `Gloam` version of `tell()` should display the values of `glip` and `fab`, provide definitions for the three `Gloam` methods.

4. Suppose you have the following definition, based on the `stack` template of Listing 14.13 and the `worker` class of Listing 14.10:

```
Stack<Worker *> sw;
```

Write out the class declaration that will be generated. Just do the class declaration, not the non-inline class methods.

5. Use the template definitions in this chapter to define the following:

- An array of `string` objects
- A stack of arrays of `double`
- An array of stacks of pointers to `worker` objects

How many template class definitions are produced in Listing 14.18?

6. Describe the differences between virtual and nonvirtual base classes.

## Programming Exercises

1. The `Wine` class has a `string` class object member (see Chapter 4) that holds the name of a wine and a `Pair` object (as discussed in this chapter) of `valarray<int>` objects (as discussed in this chapter). The first member of each `Pair` object holds the vintage years, and the second member holds the numbers of bottles owned for the corresponding particular vintage year. For example, the first `valarray` object of the `Pair` object might hold the years 1988, 1992, and 1996, and the second `valarray` object might hold the bottle counts 24, 48, and 144. It may be convenient for `Wine` to have an `int` member that stores the number of years. Also some `typedefs` might be useful to simplify the coding:

```
typedef std::valarray<int> ArrayInt;
typedef Pair<ArrayInt, ArrayInt> PairArray;
```

Thus, the `PairArray` type represents type `Pair<std::valarray<int>, std::valarray<int> >`. Implement the `Wine` class by using containment. The class should have a default constructor and at least the following constructors:

```
// initialize label to l, number of years to y,
// vintage years to yr[], bottles to bot[]
Wine(const char * l, int y, const int yr[], const int bot[]);
// initialize label to l, number of years to y,
// create array objects of length y
Wine(const char * l, int y);
```

The `Wine` class should have a method `GetBottles()` that, given a `Wine` object with `y` years, prompts the user to enter the corresponding number of vintage years and bottle counts. A method `Label()` should return a reference to the wine name. A method `sum()` should return the total number of bottles in the second `valarray<int>` object in the `Pair` object.

The program should prompt the user to enter a wine name, the number of elements of the array, and the year and bottle count information for each array element. The program should use this data to construct a `Wine` object and then display the information stored in the object. For guidance, here's a sample test program:

```
// pe14-1.cpp -- using Wine class with containment
#include <iostream>
#include "winec.h"

int main ( void )
{
    using std::cin;
    using std::cout;
    using std::endl;

    cout << "Enter name of wine: ";
    char lab[50];
```

```

    cin.getline(lab, 50);
    cout << "Enter number of years: ";
    int yrs;
    cin >> yrs;

    Wine holding(lab, yrs); // store label, years, give arrays yrs elements
    holding.GetBottles(); // solicit input for year, bottle count
    holding.Show();      // display object contents

    const int YRS = 3;
    int y[YRS] = {1993, 1995, 1998};
    int b[YRS] = { 48, 60, 72};
    // create new object, initialize using data in arrays y and b
    Wine more("Gushing Grape Red", YRS, y, b);
    more.Show();
    cout << "Total bottles for " << more.Label() // use Label() method
         << ": " << more.sum() << endl;      // use sum() method
    cout << "Bye\n";
    return 0;
}

```

And here's some sample output:

```

Enter name of wine: Gully Wash
Enter number of years: 4
Enter Gully Wash data for 4 year(s):
Enter year: 1988
Enter bottles for that year: 42
Enter year: 1994
Enter bottles for that year: 58
Enter year: 1998
Enter bottles for that year: 122
Enter year: 2001
Enter bottles for that year: 144
Wine: Gully Wash
    Year   Bottles
    1988   42
    1994   58
    1998  122
    2001  144
Wine: Gushing Grape Red
    Year   Bottles
    1993   48
    1995   60
    1998   72
Total bottles for Gushing Grape Red: 180
Bye

```

2. This exercise is the same as Programming Exercise 1, except that you should use private inheritance instead of containment. Again, a few `typedefs` might prove handy. Also you might contemplate the meaning of statements such as the following:

```
PairArray::operator=(PairArray(ArrayInt(),ArrayInt()));
cout << (const string &)(*this);
```

The class should work with the same test program as shown in Programming Exercise 1.

3. Define a `QueueTp` template. Test it by creating a queue of pointers-to-`Worker` (as defined in Listing 14.10) and using the queue in a program similar to that in Listing 14.12.
4. A `Person` class holds the first name and the last name of a person. In addition to its constructors, it has a `Show()` method that displays both names. A `Gunslinger` class derives virtually from the `Person` class. It has a `Draw()` member that returns a `double` value representing a gunslinger's draw time. The class also has an `int` member representing the number of notches on a gunslinger's gun. Finally, it has a `Show()` function that displays all this information.

A `PokerPlayer` class derives virtually from the `Person` class. It has a `Draw()` member that returns a random number in the range 1 through 52, representing a card value. (Optionally, you could define a `Card` class with suit and face value members and use a `Card` return value for `Draw()`.) The `PokerPlayer` class uses the `Person` `show()` function. The `BadDude` class derives publicly from the `Gunslinger` and `PokerPlayer` classes. It has a `Gdraw()` member that returns a bad dude's draw time and a `Cdraw()` member that returns the next card drawn. It has an appropriate `Show()` function. Define all these classes and methods, along with any other necessary methods (such as methods for setting object values) and test them in a simple program similar to that in Listing 14.12.

5. Here are some class declarations:

```
// emp.h -- header file for abstr_emp class and children

#include <iostream>
#include <string>

class abstr_emp
{
private:
    std::string fname;    // abstr_emp's first name
    std::string lname;   // abstr_emp's last name
    std::string job;
```



```

public:
    abstr_emp();
    abstr_emp(const std::string & fn, const std::string & ln,
              const std::string & j);
    virtual void ShowAll() const;    // labels and shows all data
    virtual void SetAll();          // prompts user for values
    friend std::ostream &
        operator<<(std::ostream & os, const abstr_emp & e);
    // just displays first and last name
    virtual ~abstr_emp() = 0;        // virtual base class
};

class employee : public abstr_emp
{
public:
    employee();
    employee(const std::string & fn, const std::string & ln,
             const std::string & j);
    virtual void ShowAll() const;
    virtual void SetAll();
};

class manager: virtual public abstr_emp
{
private:
    int inchargeof;                // number of abstr_emps managed
protected:
    int InChargeOf() const { return inchargeof; } // output
    int & InChargeOf(){ return inchargeof; }      // input
public:
    manager();
    manager(const std::string & fn, const std::string & ln,
            const std::string & j, int ico = 0);
    manager(const abstr_emp & e, int ico);
    manager(const manager & m);
    virtual void ShowAll() const;
    virtual void SetAll();
};

class fink: virtual public abstr_emp
{
private:
    std::string reportsto;         // to whom fink reports
protected:
    const std::string ReportsTo() const { return reportsto; }
    std::string & ReportsTo(){ return reportsto; }
};

```

```

public:
    fink();
    fink(const std::string & fn, const std::string & ln,
          const std::string & j, const std::string & rpo);
    fink(const abstr_emp & e, const std::string & rpo);
    fink(const fink & e);
    virtual void ShowAll() const;
    virtual void SetAll();
};

class highfink: public manager, public fink // management fink
{
public:
    highfink();
    highfink(const std::string & fn, const std::string & ln,
              const std::string & j, const std::string & rpo,
              int ico);
    highfink(const abstr_emp & e, const std::string & rpo, int ico);
    highfink(const fink & f, int ico);
    highfink(const manager & m, const std::string & rpo);
    highfink(const highfink & h);
    virtual void ShowAll() const;
    virtual void SetAll();
};

```

Note that the class hierarchy uses MI with a virtual base class, so keep in mind the special rules for constructor initialization lists for that case. Also note the presence of some protected-access methods. This simplifies the code for some of the `highfink` methods. (Note, for example, that if `highfink::ShowAll()` simply calls `fink::ShowAll()` and `manager::ShowAll()`, it winds up calling `abstr_emp::ShowAll()` twice.) Provide the class method implementations and test the classes in a program. Here is a minimal test program:

```

// pe14-5.cpp
// useemp1.cpp -- using the abstr_emp classes

#include <iostream>
using namespace std;
#include "emp.h"

int main(void)
{
    employee em("Trip", "Harris", "Thumper");
    cout << em << endl;
    em.ShowAll();
}

```

```

manager ma("Amorphia", "Spindragon", "Nuancer", 5);
cout << ma << endl;
ma.ShowAll();

fink fi("Matt", "Oggs", "Oiler", "Juno Barr");
cout << fi << endl;
fi.ShowAll();
highfink hf(ma, "Curly Kew"); // recruitment?
hf.ShowAll();
cout << "Press a key for next phase:\n";
cin.get();
highfink hf2;
hf2.SetAll();

cout << "Using an abstr_emp * pointer:\n";
abstr_emp * tri[4] = {&em, &fi, &hf, &hf2};
for (int i = 0; i < 4; i++)
    tri[i]->ShowAll();

return 0;
}

```

Why is no assignment operator defined?

Why are ShowAll() and SetAll() virtual?

Why is abstr\_emp a virtual base class?

Why does the highfink class have no data section?

Why is only one version of operator<<() needed?

What would happen if the end of the program were replaced with this code?

```

abstr_emp tri[4] = {em, fi, hf, hf2};
for (int i = 0; i < 4; i++)
    tri[i].ShowAll();

```

# Friends, Exceptions, and More

In this chapter you'll learn about the following:

- Friend classes
- Friend class methods
- Nested classes
- Throwing exceptions, `try` blocks, and `catch` blocks
- Exception classes
- Runtime type identification (RTTI)
- `dynamic_cast` and `typeid`
- `static_cast`, `const_cast`, and `reinterpret_cast`

This chapter ties up some loose ends and ventures into some of the later additions to the C++ language. The loose ends include friend classes, friend member functions, and nested classes, which are classes declared within other classes. The later additions discussed here are exceptions, runtime type identification (RTTI), and improved type cast control. C++ exception handling provides a mechanism for dealing with unusual occurrences that otherwise would bring a program to a halt. RTTI is a mechanism for identifying object types. The new type cast operators improve the safety of type casts. These last three facilities are fairly new to C++, and older compilers do not support them.

## Friends

Several examples in this book so far use friend functions as part of the extended interface for a class. Such functions are not the only kinds of friends a class can have. A class also can be a friend. In that case, any method of the friend class can access private and protected members of the original class. Also you can be more restrictive and designate just particular member functions of a class to be friends to another class. A class defines which functions, member functions, or classes are friends; friendship cannot be imposed from the outside. Thus, although friends do grant outside access to a class's private portion, they

don't really violate the spirit of object-oriented programming. Instead, they provide more flexibility to the public interface.

## Friend Classes

When might you want to make one class a friend to another? Let's look at an example. Suppose you must program a simple simulation of a television and a remote control. You decide to define a `TV` class representing a television and a `Remote` class representing a remote control. Clearly, there should be some sort of relationship between these classes, but what kind? A remote control is not a television and vice versa, so the *is-a* relationship of public inheritance doesn't apply. Nor is either a component of the other, so the *has-a* relationship of containment or of private or protected inheritance doesn't apply. What is true is that a remote control can modify the state of a television, and this suggests making the `Remote` class a friend to the `TV` class.

Let's define the `TV` class. You can represent a television with a set of state members—that is, variables that describe various aspects of the television. Here are some of the possible states:

- On/off
- Channel setting
- Volume setting
- Cable or antenna tuning mode
- TV tuner or A/V input

The tuning mode reflects the fact that, in the United States, the spacing between channels for channels 14 and up is different for cable reception than it is for UHF broadcast reception. The input selection chooses between TV, which could be either cable or broadcast TV, and a DVD. Some sets may offer more choices, such as multiple DVD/Blu-ray inputs, but this list is enough for the purposes of this example.

Also a television has some parameters that aren't state variables. For example, televisions vary in the number of channels they can receive, and you can include a member to track that value.

Next, you must provide the class with methods for altering the settings. Many television sets these days hide their controls behind panels, but it's still possible with most televisions to change channels, and so on, without a remote control. However, often you can go up or down one channel at a time but can't select a channel at random. Similarly, there's usually a button for increasing the volume and one for decreasing the volume.

A remote control should duplicate the controls built in to the television. Many of its methods can be implemented by using `TV` methods. In addition, a remote control typically provides random access channel selection. That is, you can go directly from channel 2 to channel 20 without going through all the intervening channels. Also many remotes can work in two or more modes, for example, as a television controller and as a DVD controller.

These considerations suggest a definition like that shown in Listing 15.1. The definition includes several constants defined as enumerations. The following statement makes `Remote` a friend class:

```
friend class Remote;
```

A friend declaration can appear in a public, private, or protected section; the location makes no difference. Because the `Remote` class mentions the `Tv` class, the compiler has to know about the `Tv` class before it can handle the `Remote` class. The simplest way to accomplish this is to define the `Tv` class first. Alternatively, you can use a forward declaration; we'll discuss that option soon.

#### Listing 15.1 `tv.h`

---

```
// tv.h -- Tv and Remote classes
#ifndef TV_H_
#define TV_H_

class Tv
{
public:
    friend class Remote; // Remote can access Tv private parts
    enum {Off, On};
    enum {MinVal,MaxVal = 20};
    enum {Antenna, Cable};
    enum {TV, DVD};

    Tv(int s = Off, int mc = 125) : state(s), volume(5),
        maxchannel(mc), channel(2), mode(Cable), input(TV) {}
    void onoff() {state = (state == On)? Off : On;}
    bool ison() const {return state == On;}
    bool volup();
    bool voldown();
    void chanup();
    void chandown();
    void set_mode() {mode = (mode == Antenna)? Cable : Antenna;}
    void set_input() {input = (input == TV)? DVD : TV;}
    void settings() const; // display all settings
private:
    int state; // on or off
    int volume; // assumed to be digitized
    int maxchannel; // maximum number of channels
    int channel; // current channel setting
    int mode; // broadcast or cable
    int input; // TV or DVD
};
```

```

class Remote
{
private:
    int mode;           // controls TV or DVD
public:
    Remote(int m = Tv::TV) : mode(m) {}
    bool volup(Tv & t) { return t.volup(); }
    bool voldown(Tv & t) { return t.voldown(); }
    void onoff(Tv & t) { t.onoff(); }
    void chanup(Tv & t) { t.chanup(); }
    void chandown(Tv & t) { t.chandown(); }
    void set_chan(Tv & t, int c) { t.channel = c; }
    void set_mode(Tv & t) { t.set_mode(); }
    void set_input(Tv & t) { t.set_input(); }
};
#endif

```

---

Most of the class methods in Listing 15.1 are defined inline. Note that each `Remote` method other than the constructor takes a reference to a `Tv` object as an argument. This reflects that a remote has to be aimed at a particular TV. Listing 15.2 shows the remaining definitions. The volume-setting functions change the volume member by one unit unless the sound has reached its minimum or maximum setting. The channel selection functions use wraparound, with the lowest channel setting, taken to be 1, immediately following the highest channel setting, `maxchannel`.

Many of the methods use the conditional operator to toggle a state between two settings:

```
void onoff() {state = (state == On)? Off : On;}
```

Provided that the two state values are `true` and `false`, or, equivalently, 0 and 1, this can be done more compactly by using the combined bitwise exclusive OR and assignment operator (`^=`), as discussed in Appendix E, “Other Operators”:

```
void onoff() {state ^= 1;}
```

In fact, you could store up to eight bivalent state settings in a single unsigned `char` variable and toggle them individually, but that’s another story, one made possible by the bitwise operators discussed in Appendix E.

---

### Listing 15.2 `tv.cpp`

```

// tv.cpp -- methods for the Tv class (Remote methods are inline)
#include <iostream>
#include "tv.h"

bool Tv::volup()
{

```

```

    if (volume < MaxVal)
    {
        volume++;
        return true;
    }
    else
        return false;
}
bool Tv::voldown()
{
    if (volume > MinVal)
    {
        volume--;
        return true;
    }
    else
        return false;
}

void Tv::chanup()
{
    if (channel < maxchannel)
        channel++;
    else
        channel = 1;
}

void Tv::chandown()
{
    if (channel > 1)
        channel--;
    else
        channel = maxchannel;
}

void Tv::settings() const
{
    using std::cout;
    using std::endl;
    cout << "TV is " << (state == Off? "Off" : "On") << endl;
    if (state == On)
    {
        cout << "Volume setting = " << volume << endl;
        cout << "Channel setting = " << channel << endl;
        cout << "Mode = "
            << (mode == Antenna? "antenna" : "cable") << endl;
    }
}

```



```

        cout << "Input = "
            << (input == TV? "TV" : "DVD") << endl;
    }
}

```

---

Listing 15.3 is a short program that tests some of the features of the program so far. The same controller is used to control two separate televisions.

### Listing 15.3 `use_tv.cpp`

---

```

//use_tv.cpp -- using the Tv and Remote classes
#include <iostream>
#include "tv.h"

int main()
{
    using std::cout;
    Tv s42;
    cout << "Initial settings for 42\" TV:\n";
    s42.settings();
    s42.onoff();
    s42.chanup();
    cout << "\nAdjusted settings for 42\" TV:\n";
    s42.settings();

    Remote grey;

    grey.set_chan(s42, 10);
    grey.volup(s42);
    grey.volup(s42);
    cout << "\n42\" settings after using remote:\n";
    s42.settings();

    Tv s58(Tv::On);
    s58.set_mode();
    grey.set_chan(s58, 28);
    cout << "\n58\" settings:\n";
    s58.settings();
    return 0;
}

```

---

Here is the output of the program in Listings 15.1, 15.2, and 15.3:

```

Initial settings for 42" TV:
TV is Off

```

Adjusted settings for 42" TV:

```
TV is On
Volume setting = 5
Channel setting = 3
Mode = cable
Input = TV
```

42" settings after using remote:

```
TV is On
Volume setting = 7
Channel setting = 10
Mode = cable
Input = TV
```

58" settings:

```
TV is On
Volume setting = 5
Channel setting = 28
Mode = antenna
Input = TV
```

The main point to this exercise is that class friendship is a natural idiom in which to express some relationships. Without some form of friendship, you would either have to make the private parts of the `Tv` class public or else construct some awkward, larger class that encompasses both a television and a remote control. And that solution wouldn't reflect the fact that a single remote control can be used with several televisions.

## Friend Member Functions

Looking at the code for the last example, you may notice that most of the `Remote` methods are implemented by using the public interface for the `Tv` class. This means that those methods don't really need friend status. Indeed, the only `Remote` method that accesses a private `Tv` member directly is `Remote::set_chan()`, so that's the only method that needs to be a friend. You do have the option of making just selected class members friends to another class rather than making the entire class a friend, but that's a bit more awkward. You need to be careful about the order in which you arrange the various declarations and definitions. Let's look at why.

The way to make `Remote::set_chan()` a friend to the `Tv` class is to declare it as a friend in the `Tv` class declaration:

```
class Tv
{
    friend void Remote::set_chan(Tv & t, int c);
    ...
};
```

However, for the compiler to process this statement, it needs to have already seen the `Remote` definition. Otherwise, it won't know that `Remote` is a class and that `set_chan()` is a method of that class. This suggests putting the `Remote` definition above the `Tv` definition. But the fact that `Remote` methods mention `Tv` objects means that the `Tv` definition should appear above the `Remote` definition. Part of the way around the circular dependence is to use a *forward declaration*. To do so, you insert the following statement above the `Remote` definition:

```
class Tv;                // forward declaration
```

This provides the following arrangement:

```
class Tv; // forward declaration
class Remote { ... };
class Tv { ... };
```

Could you use the following arrangement instead?

```
class Remote;          // forward declaration
class Tv { ... };
class Remote { ... };
```

The answer is no. The reason, as mentioned earlier, is that when the compiler sees that a `Remote` method is declared as a friend in the `Tv` class declaration, the compiler needs to have already viewed the declaration of the `Remote` class in general and of the `set_chan()` method in particular.

Another difficulty remains. In Listing 15.1, the `Remote` declaration contains inline code such as the following:

```
void onoff(Tv & t) { t.onoff(); }
```

Because this calls a `Tv` method, the compiler needs to have seen the `Tv` class declaration at this point so that it knows what methods `Tv` has. But as you've seen, that declaration necessarily follows the `Remote` declaration. The solution to this problem is to restrict `Remote` to method *declarations* and to place the actual *definitions* after the `Tv` class. This leads to the following ordering:

```
class Tv;                // forward declaration
class Remote { ... };    // Tv-using methods as prototypes only
class Tv { ... };
// put Remote method definitions here
```

The `Remote` prototypes look like this:

```
void onoff(Tv & t);
```

All the compiler needs to know when inspecting this prototype is that `Tv` is a class, and the forward declaration supplies that information. By the time the compiler reaches the actual method definitions, it has already read the `Tv` class declaration and has the added information needed to compile those methods. By using the `inline` keyword in the

method definitions, you can still make the methods inline methods. Listing 15.4 shows the revised header file.

#### Listing 15.4 `tvfm.h`

---

```
// tvfm.h -- Tv and Remote classes using a friend member
#ifndef TVFM_H_
#define TVFM_H_

class Tv;                                // forward declaration

class Remote
{
public:
    enum State{Off, On};
    enum {MinVal,MaxVal = 20};
    enum {Antenna, Cable};
    enum {TV, DVD};
private:
    int mode;
public:
    Remote(int m = TV) : mode(m) {}
    bool volup(Tv & t);                // prototype only
    bool voldown(Tv & t);
    void onoff(Tv & t) ;
    void chanup(Tv & t) ;
    void chandown(Tv & t) ;
    void set_mode(Tv & t) ;
    void set_input(Tv & t);
    void set_chan(Tv & t, int c);
};

class Tv
{
public:
    friend void Remote::set_chan(Tv & t, int c);
    enum State{Off, On};
    enum {MinVal,MaxVal = 20};
    enum {Antenna, Cable};
    enum {TV, DVD};

    Tv(int s = Off, int mc = 125) : state(s), volume(5),
        maxchannel(mc), channel(2), mode(Cable), input(TV) {}
    void onoff() {state = (state == On)? Off : On;}
    bool ison() const {return state == On;}
    bool volup();
};
```

```

    bool voldown();
    void chanup();
    void chardown();
    void set_mode() {mode = (mode == Antenna)? Cable : Antenna;}
    void set_input() {input = (input == TV)? DVD : TV;}
    void settings() const;
private:
    int state;
    int volume;
    int maxchannel;
    int channel;
    int mode;
    int input;
};

// Remote methods as inline functions
inline bool Remote::volup(Tv & t) { return t.volup();}
inline bool Remote::voldown(Tv & t) { return t.voldown();}
inline void Remote::onoff(Tv & t) { t.onoff(); }
inline void Remote::chanup(Tv & t) {t.chanup();}
inline void Remote::chardown(Tv & t) {t.chardown();}
inline void Remote::set_mode(Tv & t) {t.set_mode();}
inline void Remote::set_input(Tv & t) {t.set_input();}
inline void Remote::set_chan(Tv & t, int c) {t.channel = c;}
#endif

```

If you include `tvfm.h` instead of `tv.h` in `tv.cpp` and `use_tv.cpp`, the resulting program behaves the same as the original. The difference is that just one `Remote` method—instead of all the `Remote` methods—is a friend to the `Tv` class. Figure 15.1 illustrates this difference.

Recall that inline functions have internal linkage, which means the function definition must be in the file that uses the function. Here, the inline definitions are in the header file, so including the header file in the file that uses the definitions places the definition in the right place. You could place the definitions in the implementation file instead, provided that you remove the `inline` keyword, thus giving the functions external linkage.

By the way, making the entire `Remote` class a friend doesn't need a forward declaration because the friend statement itself identifies `Remote` as a class:

```
friend class Remote;
```

## Other Friendly Relationships

Other combinations of friends and classes besides the ones discussed so far in this chapter are possible. Let's take a brief look at some of them now.

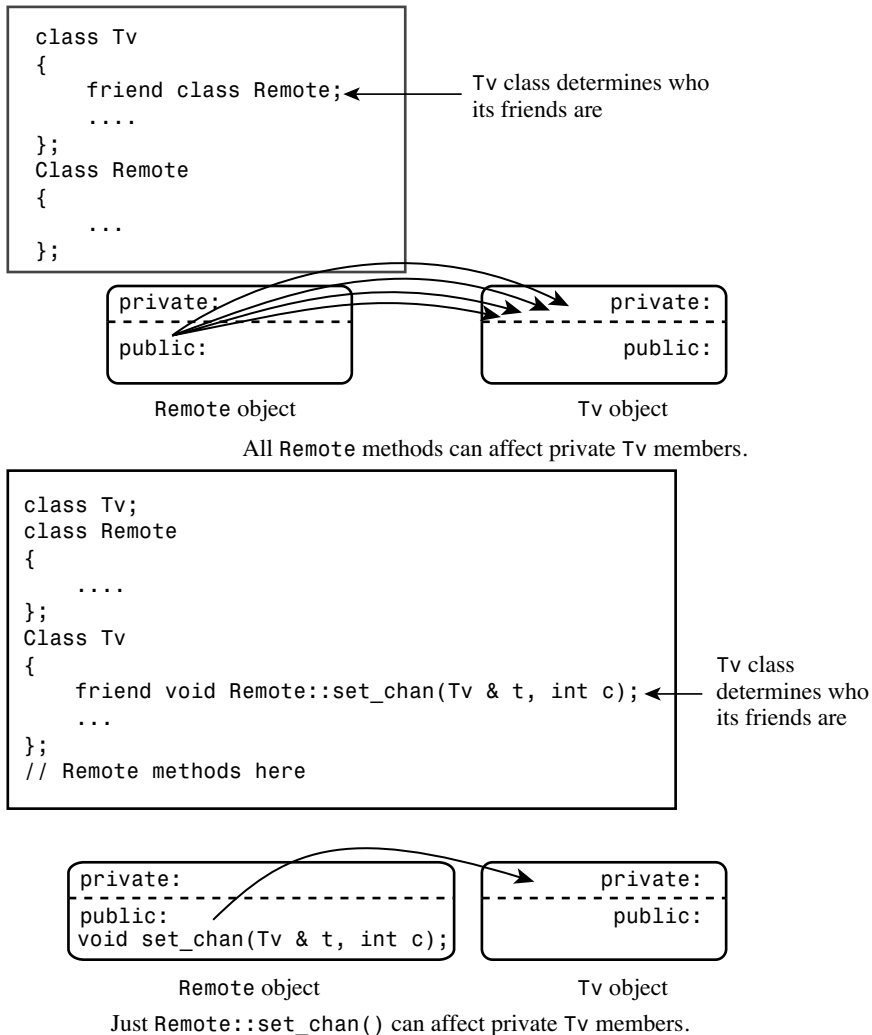

Figure 15.1 Class friends versus class member friends.

Suppose the advance of technology brings interactive remote controls. For example, an interactive remote control unit might let you enter a response to some question posed on a television program, and the television might activate a buzzer in your remote control if your response is wrong. Ignoring the possibility of television using such facilities to program the viewers, let's just look at the C++ programming aspects. The new setup would benefit from mutual friendship, with some Remote methods being able to affect a Tv

object, as before, and with some `Tv` methods being able to affect a `Remote` object. This can be accomplished by making the classes friends to each other. That is, `Tv` will be a friend to `Remote` in addition to `Remote` being a friend to `Tv`. One point to keep in mind is that a `Tv` method that uses a `Remote` object can be prototyped *before* the `Remote` class declaration but must be defined *after* the declaration so that the compiler will have enough information to compile the method. The setup would look like this:

```
class Tv
{
friend class Remote;
public:
    void buzz(Remote & r);
    ...
};
class Remote
{
friend class Tv;
public:
    void Bool volup(Tv & t) { t.volup(); }
    ...
};
inline void Tv::buzz(Remote & r)
{
    ...
}
```

Because the `Remote` declaration follows the `Tv` declaration, `Remote::volup()` can be defined in the class declaration. However, the `Tv::buzz()` method has to be defined outside the `Tv` declaration so that the definition can follow the `Remote` declaration. If you don't want `buzz()` to be inline, you need to define it in a separate method definitions file.

## Shared Friends

Another use for friends is when a function needs to access private data in two separate classes. Logically, such a function should be a member function of each class, but that's impossible. It could be a member of one class and a friend to the other, but sometimes it's more reasonable to make the function a friend to both. Suppose, for example, that you have a `Probe` class that represents some sort of programmable measuring device and an `Analyzer` class that represents some sort of programmable analyzing device. Each has an internal clock, and you would like to be able to synchronize the two clocks. You could use something along the following lines:

```
class Analyzer; // forward declaration
class Probe
{
    friend void sync(Analyzer & a, const Probe & p); // sync a to p
    friend void sync(Probe & p, const Analyzer & a); // sync p to a
    ...
}
```

```
};  
class Analyzer  
{  
    friend void sync(Analyzer & a, const Probe & p); // sync a to p  
    friend void sync(Probe & p, const Analyzer & a); // sync p to a  
    ...  
};  
  
// define the friend functions  
inline void sync(Analyzer & a, const Probe & p)  
{  
    ...  
}  
inline void sync(Probe & p, const Analyzer & a)  
{  
    ...  
}
```

The forward declaration enables the compiler to know that `Analyzer` is a type when it reaches the friend declarations in the `Probe` class declaration.

## Nested Classes

In C++, you can place a class declaration inside another class. The class declared within another is called a *nested class*, and it helps avoid name clutter by giving the new type class scope. Member functions of the class containing the declaration can create and use objects of the nested class. The outside world can use the nested class only if the declaration is in the public section and if you use the scope-resolution operator. (Older versions of C++ either don't allow nested classes or implement the concept incompletely.)

Nesting classes is not the same as containment. Recall that containment means having a class object as a member of another class. Nesting a class, on the other hand, does not create a class member. Instead, it defines a type that is known just locally to the class that contains the nested class declaration.

The usual reasons for nesting a class are to assist in the implementation of another class and to avoid name conflicts. The `Queue` class example in Listing 12.10 in Chapter 12, “Classes and Dynamic Memory Allocation,” provides a disguised case of nested classes by nesting a structure definition:

```
class Queue  
{  
private:  
    // class scope definitions  
    // Node is a nested structure definition local to this class  
    struct Node {Item item; struct Node * next;};  
    ...  
};
```



Because a structure is a class whose members are public by default, `Node` really is a nested class. However, this definition doesn't take advantage of class abilities. In particular, it lacks an explicit constructor. Let's remedy that now.

First, you need to find where `Node` objects are created in the `Queue` example. Examining the class declaration (see Listing 12.10) and the methods definitions (see Listing 12.11) reveals that the only place in which `Node` objects are created is in the `enqueue()` method:

```
bool Queue::enqueue(const Item & item)
{
    if (isfull())
        return false;
    Node * add = new Node; // create node
    // on failure, new throws std::bad_alloc exception
    add->item = item;      // set node pointers
    add->next = NULL;
    ...
}
```

This code explicitly assigns values to the `Node` members after creating a `Node`. This is the sort of work that is more properly done by a constructor.

Knowing now where and how a constructor should be used, you can provide an appropriate constructor definition:

```
class Queue
{
    // class scope definitions
    // Node is a nested class definition local to this class
    class Node
    {
    public:
        Item item;
        Node * next;
        Node(const Item & i) : item(i), next(0) { }
    };
    ...
};
```

This constructor initializes the node's `item` member to `i` and sets the `next` pointer to 0, which is one way of writing the null pointer in C++. (Using `NULL` would require including a header file that defines `NULL`. Users of a C++11-compliant compiler can use `nullptr`.) Because all nodes created by the `Queue` class have `next` initially set to the null pointer, this is the only constructor the class needs.

Next, you need to rewrite `enqueue()` by using the constructor

```
bool Queue::enqueue(const Item & item)
{
    if (isfull())
        return false;
```

```

    Node * add = new Node(item); // create, initialize node
// on failure, new throws std::bad_alloc exception
    ...
}

```

This makes the code for `enqueue()` a bit shorter and a bit safer because it automates initialization rather than requiring the programmer to correctly remember what should be done.

This example defines the constructor in the class declaration. Suppose you wanted to define it in a methods file, instead. In that case, the definition must reflect that the `Node` class is defined within the `Queue` class. This is accomplished by using the scope-resolution operator twice:

```

Queue::Node::Node(const Item & i) : item(i), next(0) { }

```

## Nested Classes and Access

Two kinds of access pertain to nested classes. First, where a nested class is declared controls the scope of the nested class; that is, it establishes which parts of a program can create objects of that class. Second, as with any class, the `public`, `protected`, and `private` sections of a nested class provide access control to class members. Where and how a nested class can be used depends on both scope and access control. Let's examine these points further.

### Scope

If a nested class is declared in a `private` section of a second class, it is known only to that second class. This applies, for example, to the `Node` class nested in the `Queue` declaration in the preceding example. Hence, `Queue` members can use `Node` objects and pointers to `Node` objects, but other parts of a program don't even know that the `Node` class exists. If you were to derive a class from `Queue`, `Node` would be invisible to that class, too, because a derived class can't directly access the `private` parts of a base class.

If the nested class is declared in a `protected` section of a second class, it is visible to that class but invisible to the outside world. However, in this case, a derived class would know about the nested class and could directly create objects of that type.

If a nested class is declared in a `public` section of a second class, it is available to the second class, to classes derived from the second class, and, because it's `public`, to the outside world. However, because the nested class has class scope, it has to be used with a class qualifier in the outside world. For example, suppose you have this declaration:

```

class Team
{
public:
    class Coach { ... };
    ...
};

```

Now suppose you have an unemployed coach, one who belongs to no team. To create a `Coach` object outside the `Team` class, you can use this:

```
Team::Coach forhire; // create a Coach object outside the Team class
```

These same scope considerations apply to nested structures and enumerations, too. Indeed, many programmers use public enumerations to provide class constants that can be used by client programmers. For example, the many implementations of classes defined to support the `iostream` facility use this technique to provide various formatting options, as you've already seen (and will explore more fully in Chapter 17, "Input, Output, and Files"). Table 15.1 summarizes scope properties for nested classes, structures, and enumerations.

Table 15.1 Scope Properties for Nested Classes, Structures, and Enumerations

| Where Declared in Nesting Class | Available to Nesting Class | Available to Classes           |                                |
|---------------------------------|----------------------------|--------------------------------|--------------------------------|
|                                 |                            | Derived from the Nesting Class | Available to the Outside World |
| Private section                 | Yes                        | No                             | No                             |
| Protected section               | Yes                        | Yes                            | No                             |
| Public section                  | Yes                        | Yes                            | Yes, with class qualifier      |

### Access Control

After a class is in scope, access control comes into play. The same rules govern access to a nested class that govern access to a regular class. Declaring the `Node` class in the `Queue` class declaration does not grant the `Queue` class any special access privileges to the `Node` class, nor does it grant the `Node` class any special access privileges to the `Queue` class. Thus, a `Queue` class object can access only the public members of a `Node` object explicitly. For that reason, the `Queue` example makes all the members of the `Node` class public. This violates the usual practice of making data members private, but the `Node` class is an internal implementation feature of the `Queue` class and is not visible to the outside world. That's because the `Node` class is declared in the private section of the `Queue` class. Thus, although `Queue` methods can access `Node` members directly, a client using the `Queue` class cannot do so.

In short, the location of a class declaration determines the scope or visibility of a class. Given that a particular class is in scope, the usual access control rules (public, protected, private, friend) determine the access a program has to members of the nested class.

### Nesting in a Template

You've seen that templates are a good choice for implementing container classes such as the `Queue` class. You may be wondering whether having a nested class poses any problems to converting the `Queue` class definition to a template. The answer is no. Listing 15.5

shows how this conversion can be made. As is common for class templates, the header file includes the class template, along with method function templates.

#### Listing 15.5 `queuetp.h`

---

```
// queuetp.h -- queue template with a nested class
#ifndef QUEUETP_H_
#define QUEUETP_H_

template <class Item>
class QueueTP
{
private:
    enum {Q_SIZE = 10};
    // Node is a nested class definition
    class Node
    {
public:
        Item item;
        Node * next;
        Node(const Item & i):item(i), next(0){ }
    };
    Node * front;        // pointer to front of Queue
    Node * rear;        // pointer to rear of Queue
    int items;          // current number of items in Queue
    const int qsize;    // maximum number of items in Queue
    QueueTP(const QueueTP & q) : qsize(0) {}
    QueueTP & operator=(const QueueTP & q) { return *this; }
public:
    QueueTP(int qs = Q_SIZE);
    ~QueueTP();
    bool isempty() const
    {
        return items == 0;
    }
    bool isfull() const
    {
        return items == qsize;
    }
    int queuecount() const
    {
        return items;
    }
    bool enqueue(const Item &item); // add item to end
    bool dequeue(Item &item);      // remove item from front
};
```

```

// QueueTP methods
template <class Item>
QueueTP<Item>::QueueTP(int qs) : qsize(qs)
{
    front = rear = 0;
    items = 0;
}

template <class Item>
QueueTP<Item>::~~QueueTP()
{
    Node * temp;
    while (front != 0)    // while queue is not yet empty
    {
        temp = front;    // save address of front item
        front = front->next; // reset pointer to next item
        delete temp;    // delete former front
    }
}

// Add item to queue
template <class Item>
bool QueueTP<Item>::enqueue(const Item & item)
{
    if (isfull())
        return false;
    Node * add = new Node(item);    // create node
    // on failure, new throws std::bad_alloc exception
    items++;
    if (front == 0)    // if queue is empty,
        front = add;    // place item at front
    else
        rear->next = add;    // else place at rear
    rear = add;    // have rear point to new node
    return true;
}

// Place front item into item variable and remove from queue
template <class Item>
bool QueueTP<Item>::dequeue(Item & item)
{
    if (front == 0)
        return false;
    item = front->item;    // set item to first item in queue
    items--;
    Node * temp = front;    // save location of first item

```

```

    front = front->next;    // reset front to next item
    delete temp;          // delete former first item
    if (items == 0)
        rear = 0;
    return true;
}

#endif

```

---

One interesting thing about the template in Listing 15.5 is that `Node` is defined in terms of the generic type `Item`. Thus, a declaration like the following leads to a `Node` defined to hold type `double` values:

```
QueueTp<double> dq;
```

And the following declaration leads to a `Node` defined to hold type `char` values:

```
QueueTp<char> cq;
```

These two `Node` classes are defined in two separate `QueueTP` classes, so there is no name conflict between the two. That is, one node is type `QueueTP<double>::Node`, and the other is type `QueueTP<char>::Node`.

Listing 15.6 offers a short program for testing the new class.

#### Listing 15.6 `nested.cpp`

---

```

// nested.cpp -- using a queue that has a nested class
#include <iostream>

#include <string>
#include "queuetp.h"

int main()
{
    using std::string;
    using std::cin;
    using std::cout;

    QueueTP<string> cs(5);
    string temp;

    while(!cs.isfull())
    {
        cout << "Please enter your name. You will be "
              "served in the order of arrival.\n"
              "name: ";
        getline(cin, temp);
        cs.enqueue(temp);
    }
}

```

```

    }
    cout << "The queue is full. Processing begins!\n";

    while (!cs.isempty())
    {
        cs.dequeue(temp);
        cout << "Now processing " << temp << "... \n";
    }
    return 0;
}

```

---

Here is a sample run of the program in Listings 15.5 and 15.6:

```

Please enter your name. You will be served in the order of arrival.
name: Kinsey Millhone
Please enter your name. You will be served in the order of arrival.
name: Adam Dalgliesh
Please enter your name. You will be served in the order of arrival.
name: Andrew Dalziel
Please enter your name. You will be served in the order of arrival.
name: Kay Scarpetta
Please enter your name. You will be served in the order of arrival.
name: Richard Jury
The queue is full. Processing begins!
Now processing Kinsey Millhone...
Now processing Adam Dalgliesh...
Now processing Andrew Dalziel...
Now processing Kay Scarpetta...
Now processing Richard Jury...

```

## Exceptions

Programs sometimes encounter runtime problems that prevent them from continuing normally. For example, a program may try to open an unavailable file, or it may request more memory than is available, or it may encounter values it cannot abide. Usually, programmers try to anticipate such calamities. C++ exceptions provide a powerful and flexible tool for dealing with these situations. Exceptions are a relatively recent addition to C++, so some older compilers haven't implemented them. Also some compilers turn this feature off by default, so you may have to use the compiler options to turn it on.

Before examining exceptions, let's look at some of the more rudimentary options available to programmers. As a test case, let's look at a function that calculates the harmonic mean of two numbers. The *harmonic mean* of two numbers is defined as the inverse of the average of the inverses. This can be reduced to the following expression:

$$2.0 \times x \times y / (x + y)$$

Note that if  $y$  is the negative of  $x$ , this formula results in division by zero, a rather undesirable operation. Many newer compilers handle division by zero by generating a special floating-point value that represents infinity; `cout` displays this value as `Inf`, `inf`, `INF`, or something similar. Other compilers may produce programs that crash when division by zero occurs. It is best to write code that behaves in the same controlled fashion on all systems.

## Calling `abort()`

One way to handle this is to have the function call the `abort()` function if one argument is the negative of the other. The `abort()` function has its prototype in the `cstdlib` (or `stdlib.h`) header file. A typical implementation, if called, sends a message such as “abnormal program termination” to the standard error stream (the same as the one used by `cerr`) and terminates the program. It also returns an implementation-dependent value that indicates failure to the operating system or, if the program was initiated by another program, to the parent process. Whether `abort()` flushes file buffers (that is, memory areas used to store material for transfers to and from files) depends on the implementation. If you prefer, you can use `exit()`, which does flush file buffers, but without displaying a message. Listing 15.7 shows a short program that uses `abort()`.

### Listing 15.7 `error1.cpp`

---

```
//error1.cpp -- using the abort() function
#include <iostream>
#include <cstdlib>
double hmean(double a, double b);

int main()
{
    double x, y, z;

    std::cout << "Enter two numbers: ";
    while (std::cin >> x >> y)
    {
        z = hmean(x,y);
        std::cout << "Harmonic mean of " << x << " and " << y
            << " is " << z << std::endl;
        std::cout << "Enter next set of numbers <q to quit>: ";
    }
    std::cout << "Bye!\n";
    return 0;
}

double hmean(double a, double b)
{
```



```

    if (a == -b)
    {
        std::cout << "untenable arguments to hmean()\n";
        std::abort();
    }
    return 2.0 * a * b / (a + b);
}

```

---

Here's a sample run of the program in Listing 15.7:

```

Enter two numbers: 3 6
Harmonic mean of 3 and 6 is 4
Enter next set of numbers <q to quit>: 10 -10
untenable arguments to hmean()
abnormal program termination

```

Note that calling the `abort()` function from `hmean()` terminates the program directly, without returning first to `main()`. In general, different compilers issue different abort messages. Here is another such message:

```

This application has requested the Runtime to terminate it
in an unusual way. Please contact the application's support
team for more information.

```

(You may, perhaps, enjoy the conceit that our little program has a support team.) The program could avoid aborting by checking the values of `x` and `y` before calling the `hmean()` function. However, it's not safe to rely on a programmer to know (or care) enough to perform such a check.

## Returning an Error Code

A more flexible approach than aborting is to use a function's return value to indicate a problem. For example, the `get(void)` member of the `ostream` class ordinarily returns the ASCII code for the next input character, but it returns the special value `EOF` if it encounters the end-of-file. This approach doesn't work for `hmean()`. Any numeric value could be a valid return value, so there's no special value available to indicate a problem. In this kind of situation, you can use a pointer argument or a reference argument to get a value back to the calling program and use the function return value to indicate success or failure. The `istream` family of overloaded `>>` operators uses a variant of this technique. By informing the calling program of the success or failure, you give the program the option of taking actions other than aborting. Listing 15.8 shows an example of this approach. It redefines `hmean()` as a `bool` function whose return value indicates success or failure. It adds a third argument for obtaining the answer.

Listing 15.8 `error2.cpp`

---

```
//error2.cpp -- returning an error code
#include <iostream>
#include <cfloat> // (or float.h) for DBL_MAX

bool hmean(double a, double b, double * ans);

int main()
{
    double x, y, z;

    std::cout << "Enter two numbers: ";
    while (std::cin >> x >> y)
    {
        if (hmean(x,y,&z))
            std::cout << "Harmonic mean of " << x << " and " << y
                << " is " << z << std::endl;
        else
            std::cout << "One value should not be the negative "
                << "of the other - try again.\n";
        std::cout << "Enter next set of numbers <q to quit>: ";
    }
    std::cout << "Bye!\n";
    return 0;
}

bool hmean(double a, double b, double * ans)
{
    if (a == -b)
    {
        *ans = DBL_MAX;
        return false;
    }
    else
    {
        *ans = 2.0 * a * b / (a + b);
        return true;
    }
}
```

---

Here's a sample run of the program in Listing 15.8:

```
Enter two numbers: 3 6
Harmonic mean of 3 and 6 is 4
Enter next set of numbers <q to quit>: 10 -10
One value should not be the negative of the other - try again.
```

```
Enter next set of numbers <q to quit>: 1 19
Harmonic mean of 1 and 19 is 1.9
Enter next set of numbers <q to quit>: q
Bye!
```

### Program Notes

In Listing 15.8, the program design allows the user to continue, bypassing the effects of bad input. Of course, the design does rely on the user to check the function return value, something that programmers don't always do. For example, to keep the sample programs short, the listings in this book don't check to see if `cout` was successful in handling output.

You could use either a pointer or a reference for the third arguments. Many programmers prefer using pointers for arguments of the built-in types because that makes it obvious which argument is being used for the answer.

Another variation on the idea of storing a return condition somewhere is to use a global variable. The function with the potential problem could set the global variable to a particular value if things go wrong, and the calling program could check the variable. This is the method used by the traditional C math library, which uses the global variable `errno` for this purpose. You have to make sure, of course, that some other function doesn't try to use a global variable of the same name for some other purpose.

## The Exception Mechanism

Now let's see how you can handle problems by using the exception mechanism. A C++ *exception* is a response to an exceptional circumstance that arises while a program is running, such as an attempt to divide by zero. Exceptions provide a way to transfer control from one part of a program to another. Handling an exception has three components:

- Throwing an exception
- Catching an exception with a handler
- Using a `try` block

A program throws an exception when a problem shows up. For example, you can modify `hmean()` in Listing 15.7 to throw an exception instead of call the `abort()` function. A `throw` statement, in essence, is a jump; that is, it tells a program to jump to statements at another location. The `throw` keyword indicates the throwing of an exception. It's followed by a value, such as a character string or an object, that indicates the nature of the exception.

A program catches an exception with an *exception handler* at the place in the program where you want to handle the problem. The `catch` keyword indicates the catching of an exception. A handler begins with the keyword `catch`, followed by a type declaration (in parentheses) that indicates the type of exception to which it responds. That, in turn, is followed by a brace-enclosed block of code that indicates the actions to take. The `catch` keyword, along with the exception type, serves as a label that identifies the point in a

program to which execution should jump when an exception is thrown. An exception handler is also called a *catch block*.

A *try block* identifies a block of code for which particular exceptions will be activated. It's followed by one or more *catch blocks*. The `try` block itself is indicated by the keyword `try`, followed by a brace-enclosed block of code indicating the code for which exceptions will be noticed.

The easiest way to see how these three elements fit together is to look at a short example, such as the one in Listing 15.9.

---

#### Listing 15.9 `error3.cpp`

---

```
// error3.cpp -- using an exception
#include <iostream>
double hmean(double a, double b);

int main()
{
    double x, y, z;

    std::cout << "Enter two numbers: ";
    while (std::cin >> x >> y)
    {
        try {
            // start of try block
            z = hmean(x,y);
        }
        // end of try block
        catch (const char * s) // start of exception handler
        {
            std::cout << s << std::endl;
            std::cout << "Enter a new pair of numbers: ";
            continue;
        }
        // end of handler
        std::cout << "Harmonic mean of " << x << " and " << y
            << " is " << z << std::endl;
        std::cout << "Enter next set of numbers <q to quit>: ";
    }
    std::cout << "Bye!\n";
    return 0;
}

double hmean(double a, double b)
{
    if (a == -b)
        throw "bad hmean() arguments: a = -b not allowed";
    return 2.0 * a * b / (a + b);
}
```

---

Here's a sample run of the program in Listing 15.9:

```
Enter two numbers: 3 6
Harmonic mean of 3 and 6 is 4
Enter next set of numbers <q to quit>: 10 -10
bad hmean() arguments: a = -b not allowed
Enter a new pair of numbers: 1 19
Harmonic mean of 1 and 19 is 1.9
Enter next set of numbers <q to quit>: q
Bye!
```

### Program Notes

The `try` block in Listing 15.9 looks like this:

```
try {
    z = hmean(x,y);
} // end of try block
```

If any statement in this block leads to an exception being thrown, the `catch` blocks after this block will handle the exception. If the program calls `hmean()` somewhere else outside this (and any other) `try` block, it won't have the opportunity to handle an exception.

Throwing an exception looks like this:

```
if (a == -b)
    throw "bad hmean() arguments: a = -b not allowed";
```

In this case, the thrown exception is the string `"bad hmean() arguments: a = -b not allowed"`. The exception type can be a string, as in this case, or other C++ types. A class type is the usual choice, as later examples in this chapter illustrate.

Executing the `throw` is a bit like executing a `return` statement in that it terminates function execution. However, instead of returning control to the calling program, a `throw` causes a program to back up through the sequence of current function calls until it finds the function that contains the `try` block. In Listing 15.9, that function is the same as the calling function. Soon you'll see an example involving backing up more than one function. Meanwhile, in this case, the `throw` passes program control back to `main()`. There, the program looks for an exception handler (following the `try` block) that matches the type of exception thrown.

The handler, or `catch` block, looks like this:

```
catch (char * s) // start of exception handler
{
    std::cout << s << std::endl;
    std::cout << "Enter a new pair of numbers: ";
    continue;
} // end of handler
```

The `catch` block looks a bit like a function definition, but it's not. The keyword `catch` identifies this as a handler, and `char * s` means that this handler matches a thrown exception that is a string. This declaration of `s` acts much like a function argument definition in that a matching thrown exception is assigned to `s`. Also, if an exception does match this handler, the program executes the code within the braces.

If a program completes executing statements in a `try` block without any exceptions being thrown, it skips the `catch` block or blocks after the `try` block and goes to the first statement following the handlers. So when the sample run of the program in Listing 15.9 processes the values 3 and 6, program execution goes directly to the output statement and reports the result.

Let's trace through the events in the sample run that occur after the values 10 and -10 are passed to the `hmean()` function. The `if` test causes `hmean()` to throw an exception. This terminates execution of `hmean()`. Searching back, the program determines that `hmean()` was called from within a `try` block in `main()`. It then looks for a `catch` block with a type that matches the exception type. The single `catch` block present has a `char *` parameter, so it does match. Detecting the match, the program assigns the string "bad `hmean()` arguments: a = -b not allowed" to the variable `s`. Next, the program executes the code in the handler. First, it prints `s`, which is the caught exception. Then it prints instructions to the user to enter new data. Finally, it executes a `continue` statement, which causes the program to skip the rest of the `while` loop and jump to its beginning again. The fact that the `continue` statement takes the program to the beginning of the loop illustrates the fact that handler statements are part of the loop and that the `catch` line acts like a label directing program flow (see Figure 15.2).

You might wonder what happens if a function throws an exception and there's no `try` block or else no matching handler. By default, the program eventually calls the `abort()` function, but you can modify that behavior. We'll return to this topic later in this chapter.

## Using Objects as Exceptions

Typically, functions that throw exceptions throw objects. One important advantage of this is that you can use different exception types to distinguish among different functions and situations that produce exceptions. Also an object can carry information with it, and you can use this information to help identify the conditions that caused the exception to be thrown. Also in principle a `catch` block could use that information to decide which course of action to pursue. Here, for example, is one possible design for an exception to be thrown by the `hmean()` function:

```
class bad_hmean
{
private:
    double v1;
    double v2;
public:
    bad_hmean(int a = 0, int b = 0) : v1(a), v2(b){}
```

```

    void mesg();
};

inline void bad_hmean::mesg()
{
    std::cout << "hmean(" << v1 << ", " << v2 <<"): "
              << "invalid arguments: a = -b\n";
}

```

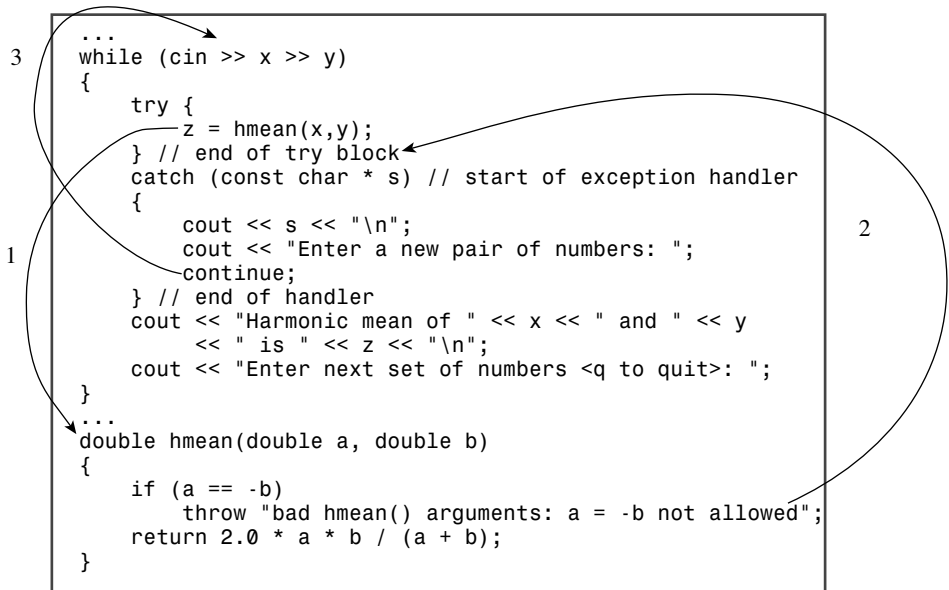

1. The program calls `hmean()` within a try block.
2. `hmean()` throws an exception, transferring execution to the catch block, and assigning the exception string to `s`.
3. The catch block transfers execution back to the while loop.

Figure 15.2 Program flow with exceptions.

A `bad_hmean` object can be initialized to the values passed to `hmean()`, and the `mesg()` method can be used to report the problem, including the values. The `hmean()` function can use code like this:

```

if (a == -b)
    throw bad_hmean(a,b);

```

This calls the `bad_hmean()` constructor, initializing the object to hold the argument values.

Listings 15.10 and 15.11 add a second exception class, `bad_gmean`, and a second function, called `gmean()`, that throws a `bad_gmean` exception. The `gmean()` function calculates the geometric mean of two numbers, which is the square root of their product. This function is defined if both arguments are non-negative, so it throws an exception if it detects negative arguments. Listing 15.10 is a header file that holds the exception class definitions, and Listing 15.11 is a sample program that uses that header file. Note that the `try` block is followed by two consecutive `catch` blocks:

```
try {
    // start of try block
    ...
} // end of try block
catch (bad_hmean & bg) // start of catch block
{
    ...
}
catch (bad_gmean & hg)
{
    ...
} // end of catch block
```

If, say, `hmean()` throws a `bad_hmean` exception, the first `catch` block catches it. If `gmean()` throws a `bad_gmean` exception, the exception falls through the first `catch` block and gets caught by the second.

#### Listing 15.10 `exc_mean.h`

---

```
// exc_mean.h -- exception classes for hmean(), gmean()
#include <iostream>

class bad_hmean
{
private:
    double v1;
    double v2;
public:
    bad_hmean(double a = 0, double b = 0) : v1(a), v2(b) {}
    void mesg();
};

inline void bad_hmean::mesg()
{
    std::cout << "hmean(" << v1 << ", " << v2 << "): "
        << "invalid arguments: a = -b\n";
}
```



```

class bad_gmean
{
public:
    double v1;
    double v2;
    bad_gmean(double a = 0, double b = 0) : v1(a), v2(b){}
    const char * mesg();
};

inline const char * bad_gmean::mesg()
{
    return "gmean() arguments should be >= 0\n";
}

```

---

#### Listing 15.11 `error4.cpp`

---

```

//error4.cpp - using exception classes
#include <iostream>
#include <cmath> // or math.h, unix users may need -lm flag
#include "exc_mean.h"
// function prototypes
double hmean(double a, double b);
double gmean(double a, double b);
int main()
{
    using std::cout;
    using std::cin;
    using std::endl;

    double x, y, z;

    cout << "Enter two numbers: ";
    while (cin >> x >> y)
    {
        try {
            // start of try block
            z = hmean(x,y);
            cout << "Harmonic mean of " << x << " and " << y
                << " is " << z << endl;
            cout << "Geometric mean of " << x << " and " << y
                << " is " << gmean(x,y) << endl;
            cout << "Enter next set of numbers <q to quit>: ";
        } // end of try block
        catch (bad_hmean & bg) // start of catch block
        {
            bg.mesg();
            cout << "Try again.\n";
        }
    }
}

```

```

        continue;
    }
    catch (bad_gmean & hg)
    {
        cout << hg.mesg();
        cout << "Values used: " << hg.v1 << ", "
            << hg.v2 << endl;
        cout << "Sorry, you don't get to play any more.\n";
        break;
    } // end of catch block
}
cout << "Bye!\n";
return 0;
}

double hmean(double a, double b)
{
    if (a == -b)
        throw bad_hmean(a,b);
    return 2.0 * a * b / (a + b);
}

double gmean(double a, double b)
{
    if (a < 0 || b < 0)
        throw bad_gmean(a,b);
    return std::sqrt(a * b);
}

```

---

Here's a sample run of the program, one that gets terminated by bad input for the `gmean()` function:

```

Enter two numbers: 4 12
Harmonic mean of 4 and 12 is 6
Geometric mean of 4 and 12 is 6.9282
Enter next set of numbers <q to quit>: 5 -5
hmean(5, -5): invalid arguments: a = -b
Try again.
5 -2
Harmonic mean of 5 and -2 is -6.66667
gmean() arguments should be >= 0
Values used: 5, -2
Sorry, you don't get to play any more.
Bye!

```

One point to notice is that the `bad_hmean` handler uses a `continue` statement, whereas the `bad_gmean` handler uses a `break` statement. Thus, bad input to `hmean()` leads the

program to skip the rest of the loop and start the next loop cycle. But bad input for `gmean()` terminates the loop. This illustrates how a program can determine which exception is thrown (by the exception type) and tailor the response to the exception.

A second point to notice is that the `bad_gmean` design illustrates techniques that are different from what `bad_hmean` uses. In particular, `bad_gmean` uses public data and a method that returns a C-style string.

## Exception Specifications Meet C++11

Sometimes an idea that seems promising in principle doesn't work out so well in practice. Such is the story of *exception specifications*, a feature added by C++98 and then deprecated by C++11. That means the feature still is in the standard, but it may not be in the future, so you are encouraged not to use it.

However, before you ignore exception specifications, you at least should know what they look like. They look like this:

```
double harm(double a) throw(bad_thing); // may throw bad_thing exception
double marm(double) throw();           // doesn't throw an exception
```

The `throw()` part, with or without a list of types, is the exception specification, and it would appear in both the prototype and the function definition.

One reason for exception specifications was to alert the user to the possible need of a `try` block. However, that can be accomplished just as easily with a comment. A second reason was to allow the compiler to add code to do runtime checks to see if the exception specification was violated. This can happen fairly easily. For instance, `marm()` might not throw an exception, but it might call a function that calls a function that throws an exception. And maybe that function didn't throw an exception when you wrote the code, but after a library update, it now does. Anyway, the consensus that developed in the programming community, particularly among those who worked most diligently in writing exception-safe code, was that this feature is best ignored. And now you, too, can ignore exception specifications with the blessings of C++11.

However, C++11 does allow for one special specification—the new keyword `noexcept` can be used to indicate a function that does not throw an exception:

```
double marm() noexcept; // marm() doesn't throw an exception
```

There is some debate about the necessity and usefulness of this specification, with some feeling it's better to avoid using it (at least, in most cases). But others felt strongly enough about the need to introduce a new keyword. It's thought that knowing that a function shouldn't throw an exception can help the compiler optimize code. This usage should be thought of as a promise made by the programmer of the function.

There also is a `noexcept()` operator (see Appendix E) that reports on whether or not its operand could throw an exception.

## Unwinding the Stack

Suppose a `try` block doesn't contain a direct call to a function that throws an exception but that it calls a function that calls a function that throws an exception. Execution still jumps from the function in which the exception is thrown to the function that contains the `try` block and handlers. Doing so involves *unwinding the stack*, which we'll discuss now.

First, let's look at how C++ normally handles function calls and returns. C++ typically handles function calls by placing information on a stack (see Chapter 9, "Memory Models and Namespaces"). In particular, a program places the address of a calling function instruction (a *return address*) on the stack. When the called function completes, the program uses that address to determine where to continue with program execution. Also the function call places any function arguments on the stack, where they are treated as automatic variables. If the called function creates any new automatic variables, they, too, are added to the stack. If a called function calls another function, its information is added to the stack, and so on. When a function terminates, program execution passes to the address stored when the function was called, and the top of the stack is freed. Thus a function normally returns to the function that called it, with each function liberating its automatic variables as it terminates. If an automatic variable is a class object, then the class destructor, if any, is called.

Now suppose a function terminates via a thrown exception instead of via a return call. Again, the program frees memory from the stack. But instead of stopping at the first return address on the stack, the program continues freeing the stack until it reaches a return address that resides in a `try` block (see Figure 15.3). Control then passes to the exception handlers at the end of the block rather than to the first statement following the function call. This process is called *unwinding the stack*. One very important feature of the `throw` mechanism is that, just as with function returns, the class destructors are called for any automatic class objects on the stack. However, a function return just processes objects put on the stack by that function, whereas the `throw` statement processes objects put on the stack by the entire sequence of function calls between the `try` block and the `throw`. Without the unwinding-the-stack feature, a `throw` would leave destructors uncalled for automatic class objects placed on the stack by intermediate function calls.

Listing 15.12 provides an example of unwinding the stack. In it, `main()` calls `means()`, which in turn calls `hmean()` and `gmean()`. The `means()` function, for the lack of anything better to do, calculates the mean of the arithmetic, harmonic, and geometric means. Both `main()` and `means()` create objects of the `demo` type (a babbling class that announces when its constructor and destructor are used) so that you can see what happens to those objects when exceptions are thrown. The `try` block in `main()` catches both `bad_hmean` and `bad_gmean` exceptions, and the `try` block in `means()` catches just the `bad_hmean` exception. This `catch` block has the following code:

```
catch (bad_hmean & bg) // start of catch block
{
    bg.mesg();
    std::cout << "Caught in means()\n";
    throw; // rethrows the exception
}
```

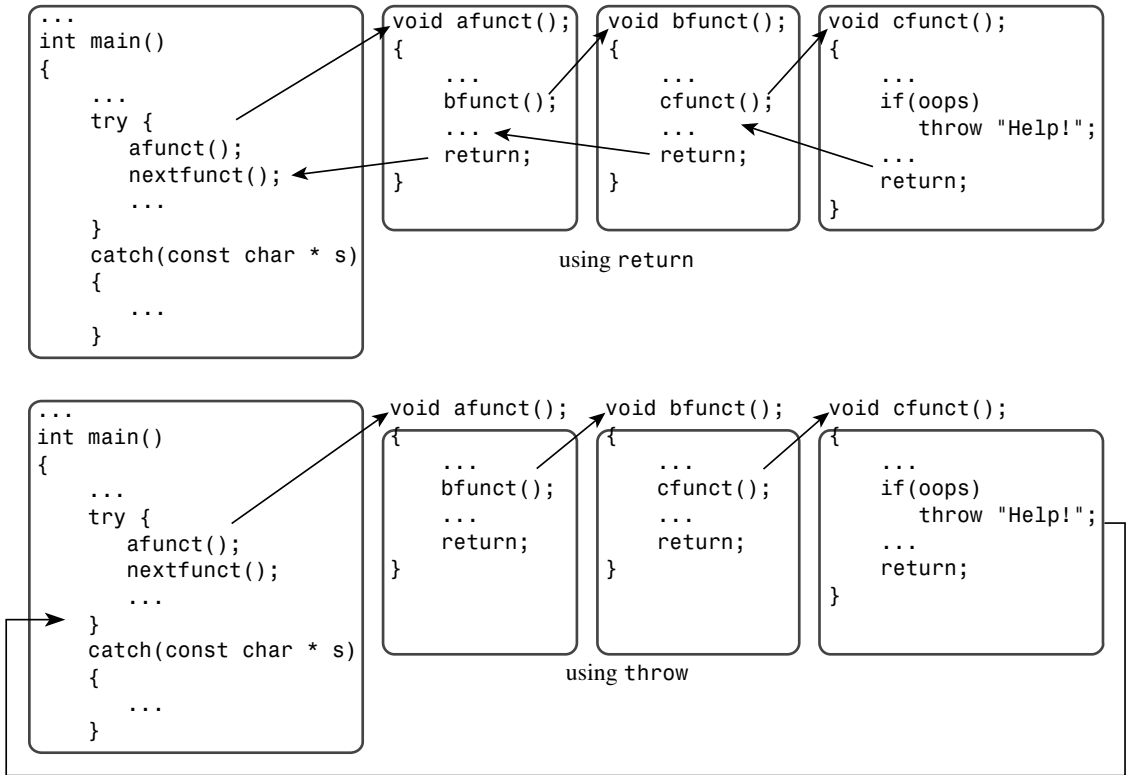

Figure 15.3 throw versus return.

After the code responds by displaying messages, it rethrows the exception, which means, in this case, sending the exception on up to `main()`. (In general, a rethrown exception rises to the next `try-catch` combination that catches that particular type of exception. If no handler is found, the program, by default, aborts.) Listing 15.12 uses the same header file (`exc_mean.h` in listing 15.10) as Listing 15.11.

**Listing 15.12 error5.cpp**

```
//error5.cpp -- unwinding the stack
#include <iostream>
#include <cmath> // or math.h, unix users may need -lm flag
#include <string>
#include "exc_mean.h"

class demo
{
private:
    std::string word;
public:
    demo (const std::string & str)
```

```

{
    word = str;
    std::cout << "demo " << word << " created\n";
}
~demo()
{
    std::cout << "demo " << word << " destroyed\n";
}
void show() const
{
    std::cout << "demo " << word << " lives!\n";
}
};

// function prototypes
double hmean(double a, double b);
double gmean(double a, double b);
double means(double a, double b);

int main()
{
    using std::cout;
    using std::cin;
    using std::endl;

    double x, y, z;
    {
        demo d1("found in block in main()");
        cout << "Enter two numbers: ";
        while (cin >> x >> y)
        {
            try {
                // start of try block
                z = means(x,y);
                cout << "The mean mean of " << x << " and " << y
                    << " is " << z << endl;
                cout << "Enter next pair: ";
            } // end of try block
            catch (bad_hmean & bg) // start of catch block
            {
                bg.mesg();
                cout << "Try again.\n";
                continue;
            }
            catch (bad_gmean & hg)
            {
                cout << hg.mesg();
            }
        }
    }
}

```

```

        cout << "Values used: " << hg.v1 << ", "
              << hg.v2 << endl;
        cout << "Sorry, you don't get to play any more.\n";
        break;
    } // end of catch block
}
d1.show();
}
cout << "Bye!\n";
cin.get();
cin.get();
return 0;
}

double hmean(double a, double b)
{
    if (a == -b)
        throw bad_hmean(a,b);
    return 2.0 * a * b / (a + b);
}

double gmean(double a, double b)
{
    if (a < 0 || b < 0)
        throw bad_gmean(a,b);
    return std::sqrt(a * b);
}

double means(double a, double b)
{
    double am, hm, gm;
    demo d2("found in means()");
    am = (a + b) / 2.0;    // arithmetic mean
    try
    {
        hm = hmean(a,b);
        gm = gmean(a,b);
    }
    catch (bad_hmean & bg) // start of catch block
    {
        bg.mesg();
        std::cout << "Caught in means()\n";
        throw;            // rethrows the exception
    }
    d2.show();
    return (am + hm + gm) / 3.0;
}

```

---

Here's a sample run of the program:

```
demo found in block in main() created
Enter two numbers: 6 12
demo found in means() created
demo found in means() lives!
demo found in means() destroyed
The mean mean of 6 and 12 is 8.49509
6 -6
demo found in means() created
hmean(6, -6): invalid arguments: a = -b
Caught in means()
demo found in means() destroyed
hmean(6, -6): invalid arguments: a = -b
Try again.
6 -8
demo found in means() created
demo found in means() destroyed
gmean() arguments should be >= 0
Values used: 6, -8
Sorry, you don't get to play any more.
demo found in block in main() lives!
demo found in block in main() destroyed
Bye!
```

## Program Notes

Let's trace through the course of the sample run shown in the preceding section. First, as the `demo` constructor announces, an object is created in the block in `main()`. Next, `means()` is called, and another `demo` object is created. The `means()` function passes the values 6 and 12 on to `hmean()` and `gmean()`, and those functions return values to `means()`, which calculates a result and returns it. Before returning the result, `means()` invokes `d2.show()`. After returning the result, `means()` terminates, and the destructor for `d2` is called automatically:

```
demo found in means() lives!
demo found in means() destroyed
```

The next input cycle sends the values 6 and -6 to `means()`, and then `means()` creates a new `demo` object and relays the values to `hmean()`. The `hmean()` function then throws a `bad_hmean` exception, which is caught by the `catch` block in `means()`, as is shown by the following output:

```
hmean(6, -6): invalid arguments: a = -b
Caught in means()
```



The `throw` statement in this block then terminates `means()` and sends the exception up to `main()`. The fact that `d2.show()` isn't called demonstrates that the execution of `means()` is terminated. But note that the destructor for `d2` is called:

```
demo found in means() destroyed
```

This illustrates an extremely important aspect of exceptions: As the program unwinds the stack to reach where an exception is caught, it frees automatic storage class variables on the stack. If a variable happens to be a class object, then the destructor for that object is called.

Meanwhile, the rethrown exception reaches `main()`, where the appropriate `catch` block catches and handles it:

```
hmean(6, -6): invalid arguments: a = -b
Try again.
```

Now the third input cycle begins, with `6` and `-8` sent on to `means()`. Once again, `means()` creates a new `demo` object. It passes `6` and `-8` to `hmean()`, which processes them without a problem. Then `means()` passes `6` and `-8` to `gmean()`, which throws a `bad_gmean` exception. Because `means()` doesn't catch `bad_gmean` exceptions, the exception is passed on up to `main()`, and no further code in `means()` is executed. However, once again, as the program unwinds the stack, it frees local automatic variables, so the destructor for `d2` is called:

```
demo found in means() destroyed
```

Finally, the `bad_gmean` handler in `main()` catches the exception and terminates the loop:

```
gmean() arguments should be >= 0
Values used: 6, -8
Sorry, you don't get to play any more.
```

Then the program terminates normally, displaying a few messages and automatically calling the destructor for `d1`. If the `catch` block used, say, `exit(EXIT_FAILURE)` instead of `break`, the program would terminate immediately, so you wouldn't see these messages:

```
demo found in main() lives!
Bye!
```

However, you would still see this message:

```
demo found in main() destroyed
```

Again, the exception mechanism would attend to freeing automatic variables on the stack.

## More Exception Features

Although the `throw-catch` mechanism is similar to function arguments and the function return mechanism, there are a few differences. One, which you've already encountered, is that a `return` statement in a function `fun()` transfers execution to the function that called

`fun()`, but a `throw` transfers execution all the way up to the first function having a `try-catch` combination that catches the exception. For example, in Listing 15.12, when `hmean()` throws an exception, control passes up to `means()`, but when `gmean()` throws an exception, control passes up to `main()`.

Another difference is that the compiler always creates a temporary copy when throwing an exception, even if the exception specifier and `catch` blocks specify a reference. For instance, consider this code:

```
class problem {...};
...
void super() throw (problem)
{
    ...
    if (oh_no)
    {
        problem oops; // construct object
        throw oops;   // throw it
    }
    ...
}
...
try {
    super();
}
catch(problem & p)
{
    // statements
}
```

Here, `p` would refer to a copy of `oops` rather than to `oops`. That's a good thing because `oops` no longer exists after `super()` terminates. By the way, it is simpler to combine construction with the `throw`:

```
throw problem(); // construct and throw default problem object
```

At this point you might wonder why the code uses a reference if the `throw` generates a copy. After all, the usual reason for using a reference return value is the efficiency of not having to make a copy. The answer is that references have another important property: A base-class reference can also refer to derived-class objects. Suppose you have a collection of exception types that are related by inheritance. In that case, the exception specification need only list a reference to the base type, and that would also match any derived objects thrown.

Suppose you have a class hierarchy of exceptions and you want to handle the different types separately. A base-class reference can catch all objects of a family, but a derived-class object can only catch that object and objects of classes derived from that class. A thrown object is caught by the first `catch` block that matches it. This suggests arranging the `catch` blocks in inverse order of derivation:

```

class bad_1 {...};
class bad_2 : public bad_1 {...};
class bad_3 : public bad_2 {...};
...
void duper()
{
    ...
    if (oh_no)
        throw bad_1();
    if (rats)
        throw bad_2();
    if (drat)
        throw bad_3();
}
...
try {
    duper();
}
catch(bad_3 &be)
{ // statements }
catch(bad_2 &be)
{ // statements }
catch(bad_1 &be)
{ // statements }

```

If the `bad_1` handler were first, it would catch the `bad_1`, `bad_2`, and `bad_3` exceptions. With the inverse order, a `bad_3` exception would be caught by the `bad_3` handler.

### Tip

If you have an inheritance hierarchy of exception classes, you should arrange the order of the `catch` blocks so that the exception of the most-derived class (that is, the class furthest down the class hierarchy sequence) is caught first and the base-class exception is caught last.

Arranging `catch` blocks in the proper sequence allows you to be selective about how each type of exception is handled. But sometimes you might not know what type of exception to expect. For instance, say you write a function that calls another function, and you don't know whether that other function throws exceptions. You can still catch the exception even if you don't know the type. The trick to catching any exception is to use an ellipsis for the exception type:

```
catch (...) { // statements } // catches any type exception
```

If you do know some exceptions that are thrown, you can place this catchall form at the end of the catch block sequence, a bit like the default case for a switch:

```
try {
    duper();
}
catch (bad_3 &be)
{ // statements }
catch (bad_2 &be)
{ // statements }
catch (bad_1 &be)
{ // statements }
catch (bad_hmean & h)
{ // statements }
catch (...)          // catch whatever is left
{ // statements }
```

You can set up a handler to catch an object instead of a reference. A base-class object will catch a derived class object, but the derived aspects will be stripped off. Thus, base-class versions of virtual methods will be used.

## The exception Class

The main intent for C++ exceptions is to provide language-level support for designing fault-tolerant programs. That is, exceptions make it easier to incorporate error handling into a program design so you don't have to tack on some more rigid form of error handling as an afterthought. The flexibility and relative convenience of exceptions should encourage programmers to integrate fault handling into the program design process, if appropriate. In short, exceptions are the kind of feature that, like classes, can modify your approach to programming.

Newer C++ compilers are incorporating exceptions into the language. For example, the exception header file (formerly `exception.h` or `except.h`) defines an exception class that C++ uses as a base class for other exception classes used to support the language. Your code, too, can throw an exception object or use the exception class as a base class. One virtual member function is named `what()`, and it returns a string, the nature of which is implementation dependent. However, because this method is virtual, you can redefine it in a class derived from `exception`:

```
#include <exception>
class bad_hmean : public std::exception
{
public:
    const char * what() { return "bad arguments to hmean()"; }
    ...
};
class bad_gmean : public std::exception
{
```

```
public:
    const char * what() { return "bad arguments to gmean()"; }
    ...
};
```

If you don't want to handle these derived exceptions differently from one another, you can catch them with the same base-class handler:

```
try {
    ...
}
catch(std::exception & e)
{
    cout << e.what() << endl;
    ...
}
```

Or you could catch the different types separately.

The C++ library defines many exception types based on `exception`.

### The `stdexcept` Exception Classes

The `stdexcept` header file defines several more exception classes. First, the file defines the `logic_error` and `runtime_error` classes, both of which derive publicly from `exception`:

```
class logic_error : public exception {
public:
    explicit logic_error(const string& what_arg);
    ...
};

class domain_error : public logic_error {
public:
    explicit domain_error(const string& what_arg);
    ...
};
```

Note that the constructors take a `string` object as an argument; this argument provides the character data returned as a C-style string by the `what()` method.

These two new classes serve, in turn, as bases for two families of derived classes. The `logic_error` family describes, as you might expect, typical logic errors. In principle, sound programming could avoid such errors, but in practice, such errors might show up. The name of each class indicates the sort of error it is intended to report:

```
domain_error
invalid_argument
length_error
out_of_bounds
```

Each class has a constructor like that of `logic_error` that allows you to provide the string to be returned by the `what()` method.

Perhaps a little amplification might be helpful. A mathematical function has a domain and a range. The domain consists of the values for which the function is defined, and the range consists of the values that a function returns. For example, the domain of the sine function is from negative infinity to positive infinity because the sine is defined for all real numbers. But the range of the sine function is from  $-1$  to  $+1$  because those are the extreme possible values of the sine of an angle. On the other hand, the domain of the inverse function arcsine is  $-1$  to  $+1$ , while its range is  $[-\pi]$  to  $[\pi]$ . If you wrote a function that passed an argument to the `std::sin()` function, you could have your function throw a `domain_error` object if the argument were outside the  $-1$  to  $+1$  domain.

The `invalid_argument` exception alerts you that an unexpected value has been passed to a function. For example, if a function expects to receive a string for which each character is either a `'0'` or `'1'`, it could throw the `invalid_argument` exception if some other character appeared in the string.

The `length_error` exception is used to indicate that not enough space is available for the desired action. For example, the `string` class has an `append()` method that throws a `length_error` exception if the resulting string would be larger than the maximum possible string length.

The `out_of_bounds` exception is typically used to indicate indexing errors. For example, you could define an array-like class for which `operator() []` throws the `out_of_bounds` exception if the index used is invalid for that array.

Next, the `runtime_error` family describes errors that might show up during runtime but that could not easily be predicted and prevented. The name of each class indicates the sort of error it is intended to report:

```
range_error
overflow_error
underflow_error
```

Each class has a constructor like that of `runtime_error` that allows you to provide the string to be returned by the `what()` method.

An underflow error can occur in floating-point calculations. In general, there is a smallest nonzero magnitude that a floating-point type can represent. A calculation that would produce a smaller value would cause an underflow error. An overflow error can occur with either integer or floating-point types when the magnitude of the result of a calculation would exceed the largest representable value for that type. A computational result can lie outside the valid range of a function without being an underflow or overflow, and you can use the `range_error` exception for such situations.

In general, an exception of the `logic_error` family indicates a problem that is susceptible to a programming fix, whereas a `runtime_error` family exception is just a bit of unavoidable trouble. All these error classes have the same general characteristics. The main distinction is that the different class names allow you to handle each type of exception

individually. On the other hand, the inheritance relationships allow you to lump them together if you prefer. For example, the following code catches the `out_of_bounds` exception individually, treats the remaining `logic_error` family of exceptions as a group and treats exception objects, the `runtime_error` family of objects and any remaining exception types derived from `exception` collectively:

```
try {
    ...
}
catch(out_of_bounds & oe) // catch out_of_bounds error
{...}
catch(logic_error & oe)   // catch remaining logic_error family
{...}
catch(exception & oe)    // catch runtime_error, exception objects
{...}
```

If one of these library classes doesn't meet your needs, it makes sense to derive an exception class from `logic_error` or `runtime_error` so that you can fit your exceptions into the same general hierarchy.

### The `bad_alloc` Exception and `new`

The current C++ way to handle memory allocation problems with `new` is to have `new` throw a `bad_alloc` exception. The `new` header includes a declaration for the `bad_alloc` class, which is publicly derived from the `exception` class. In the days of yore, however, `new` returned a null pointer when it couldn't allocate the requested amount of memory.

Listing 15.13 demonstrates the current approach. If the exception is caught, the program displays the implementation-dependent message returned by the inherited `what()` method and terminates early.

#### Listing 15.13 `newexcp.cpp`

---

```
// newexcp.cpp -- the bad_alloc exception
#include <iostream>
#include <new>
#include <cstdlib> // for exit(), EXIT_FAILURE
using namespace std;

struct Big
{
    double stuff[20000];
};

int main()
{
    Big * pb;
    try {
```

```

    cout << "Trying to get a big block of memory:\n";
    pb = new Big[10000]; // 1,600,000,000 bytes
    cout << "Got past the new request:\n";
}
catch (bad_alloc & ba)
{
    cout << "Caught the exception!\n";
    cout << ba.what() << endl;
    exit(EXIT_FAILURE);
}
cout << "Memory successfully allocated\n";
pb[0].stuff[0] = 4;
cout << pb[0].stuff[0] << endl;
delete [] pb;
return 0;
}

```

---

Here's the output for one system:

```

Trying to get a big block of memory:
Caught the exception!
std::bad_alloc

```

In this case, the `what()` method returns the string `"std::bad_alloc"`.

If the program runs without allocation problems on your system, you can try increasing the amount of memory requested.

## The Null Pointer and `new`

Much code was written when `new` (the old `new`) returned a null pointer upon failure. Some compilers handled the transition to the new `new` by letting the user set a flag or switch to choose which behavior she wanted. Currently, the standard provides for an alternative form of `new` that still returns a null pointer. Its use looks like this:

```

int * pi = new (std::nothrow) int;
int * pa = new (std::nothrow) int[500];

```

Using this form, you could rewrite the core of Listing 15.13 this way:

```

Big * pb;

pb = new (std::nothrow) Big[10000]; // 1,600,000,000 bytes
if (pb == 0)
{
    cout << "Could not allocate memory. Bye.\n";
    exit(EXIT_FAILURE);
}

```



## Exceptions, Classes, and Inheritance

Exceptions, classes, and inheritance interact in a couple ways. First, you can derive one exception class from another, as the standard C++ library does. Second, you can incorporate exceptions into classes by nesting exception class declarations inside a class definition. Third, such nested declarations can be inherited and can serve as base classes themselves.

Listing 15.14 starts us on the way to exploring some of these possibilities. This header file declares a rudimentary `Sales` class that holds a year value and an array of 12 monthly sales figures. The `LabeledSales` class derives from `Sales` and adds a member to hold a label for the data.

Listing 15.14 `sales.h`

---

```
// sales.h -- exceptions and inheritance
#include <stdexcept>
#include <string>

class Sales
{
public:
    enum {MONTHS = 12}; // could be a static const
    class bad_index : public std::logic_error
    {
private:
        int bi; // bad index value
public:
        explicit bad_index(int ix,
            const std::string & s = "Index error in Sales object\n");
        int bi_val() const {return bi;}
        virtual ~bad_index() throw() {}
    };
    explicit Sales(int yy = 0);
    Sales(int yy, const double * gr, int n);
    virtual ~Sales() { }
    int Year() const { return year; }
    virtual double operator[](int i) const;
    virtual double & operator[](int i);
private:
    double gross[MONTHS];
    int year;
};

class LabeledSales : public Sales
{
public:
    class nbad_index : public Sales::bad_index
    {
```

```

private:
    std::string lbl;
public:
    nbad_index(const std::string & lb, int ix,
               const std::string & s = "Index error in LabeledSales object\n");
    const std::string & label_val() const {return lbl;}
    virtual ~nbad_index() throw() {}
};
explicit LabeledSales(const std::string & lb = "none", int yy = 0);
LabeledSales(const std::string & lb, int yy, const double * gr, int n);
virtual ~LabeledSales() { }
const std::string & Label() const {return label;}
virtual double operator[](int i) const;
virtual double & operator[](int i);
private:
    std::string label;
};

```

---

Let's examine a few details of Listing 15.14. First, the symbolic constant `MONTHS` is in the protected section of `Sales`; this makes the value available to derived classes, such as `LabeledSales`.

Next, the `bad_index` class is nested in the public section of `Sales`; this makes the class available as a type to client catch blocks. Note that the outside world requires the type to be identified as `Sales::bad_index`. This class derives from the standard `logic_error` class. The `bad_index` class has the ability to store and report an out-of-bounds value for an array index.

The `nbad_index` class is nested in the public section of `LabeledSales`, making it available to client code as `LabeledSales::nbad_index`. It derives from `bad_index`, adding the ability to store and report the label of a `LabeledSales` object. Because `bad_index` derives from `logic_error`, `nbad_index` also ultimately derives from `logic_error`.

Both classes have overloaded `operator[]()` methods that are designed to access the individual array elements stored in an object and to throw an exception if an index is out of bounds.

Both the `bad_index` and `nbad_index` classes use the `throw()` exception specification. The reason is that both eventually inherit from the `exception` base class, and its virtual destructor uses the `throw()` exception specification. This is a C++98 feature; under C++11, the `exception` destructor doesn't have an exception specification.

Listing 15.15 shows the implementation of the methods that weren't already defined inline in Listing 15.14. Note that nested classes require using the scope-resolution operator more than once. Also note that the `operator[]()` functions throw exceptions if the array index is out of bounds.

Listing 15.15 `sales.cpp`

---

```

// sales.cpp -- Sales implementation
#include "sales.h"
using std::string;

Sales::bad_index::bad_index(int ix, const string & s )
    : std::logic_error(s), bi(ix)
{
}

Sales::Sales(int yy)
{
    year = yy;
    for (int i = 0; i < MONTHS; ++i)
        gross[i] = 0;
}

Sales::Sales(int yy, const double * gr, int n)
{
    year = yy;
    int lim = (n < MONTHS)? n : MONTHS;
    int i;
    for (i = 0; i < lim; ++i)
        gross[i] = gr[i];
    // for i > n and i < MONTHS
    for ( ; i < MONTHS; ++i)
        gross[i] = 0;
}

double Sales::operator[](int i) const
{
    if(i < 0 || i >= MONTHS)
        throw bad_index(i);
    return gross[i];
}

double & Sales::operator[](int i)
{
    if(i < 0 || i >= MONTHS)
        throw bad_index(i);
    return gross[i];
}

LabeledSales::nbad_index::nbad_index(const string & lb, int ix,
    const string & s ) : Sales::bad_index(ix, s)
{

```

```

    lbl = lb;
}

LabeledSales::LabeledSales(const string & lb, int yy)
    : Sales(yy)
{
    label = lb;
}

LabeledSales::LabeledSales(const string & lb, int yy,
                           const double * gr, int n)
    : Sales(yy, gr, n)
{
    label = lb;
}

double LabeledSales::operator[](int i) const
{
    if(i < 0 || i >= MONTHS)
        throw nbad_index(Label(), i);
    return Sales::operator[](i);
}

double & LabeledSales::operator[](int i)
{
    if(i < 0 || i >= MONTHS)
        throw nbad_index(Label(), i);
    return Sales::operator[](i);
}

```

---

Listing 15.16 uses the classes in a program that first tries to go beyond the end of the array in the `LabeledSales` object `sales2` and then beyond the end of the array in the `Sales` object `sales1`. These attempts are made in two separate `try` blocks that test for each kind of exception.

#### Listing 15.16 `use_sales.cpp`

---

```

// use_sales.cpp -- nested exceptions
#include <iostream>
#include "sales.h"

int main()
{
    using std::cout;
    using std::cin;
    using std::endl;

```

```

double vals1[12] =
{
    1220, 1100, 1122, 2212, 1232, 2334,
    2884, 2393, 3302, 2922, 3002, 3544
};

double vals2[12] =
{
    12, 11, 22, 21, 32, 34,
    28, 29, 33, 29, 32, 35
};

Sales sales1(2011, vals1, 12);
LabeledSales sales2("Blogstar",2012, vals2, 12 );

cout << "First try block:\n";
try
{
    int i;
    cout << "Year = " << sales1.Year() << endl;
    for (i = 0; i < 12; ++i)
    {

        cout << sales1[i] << ' ';
        if (i % 6 == 5)
            cout << endl;
    }
    cout << "Year = " << sales2.Year() << endl;
    cout << "Label = " << sales2.Label() << endl;
    for (i = 0; i <= 12; ++i)
    {

        cout << sales2[i] << ' ';
        if (i % 6 == 5)
            cout << endl;
    }
    cout << "End of try block 1.\n";
}
catch(LabeledSales::nbad_index & bad)
{
    cout << bad.what();
    cout << "Company: " << bad.label_val() << endl;
    cout << "bad index: " << bad.bi_val() << endl;
}
catch(Sales::bad_index & bad)
{
    cout << bad.what();
}

```

```
        cout << "bad index: " << bad.bi_val() << endl;
    }
    cout << "\nNext try block:\n";
    try
    {
        sales2[2] = 37.5;
        sales1[20] = 23345;
        cout << "End of try block 2.\n";
    }
    catch(LabeledSales::nbad_index & bad)
    {
        cout << bad.what();
        cout << "Company: " << bad.label_val() << endl;
        cout << "bad index: " << bad.bi_val() << endl;
    }
    catch(Sales::bad_index & bad)
    {
        cout << bad.what();
        cout << "bad index: " << bad.bi_val() << endl;
    }
    cout << "done\n";

    return 0;
}
```

---

Here is the output of the program in Listings 15.14, 15.15, and 15.16:

First try block:

Year = 2011

1220 1100 1122 2212 1232 2334

2884 2393 3302 2922 3002 3544

Year = 2012

Label = Blogstar

12 11 22 21 32 34

28 29 33 29 32 35

Index error in LabeledSales object

Company: Blogstar

bad index: 12

Next try block:

Index error in Sales object

bad index: 20

done

## When Exceptions Go Astray

After an exception is thrown, it has two opportunities to cause problems. First, if it is thrown in a function that has an exception specification, it has to match one of the types in the specification list. (Remember that in an inheritance hierarchy, a class type matches objects of that type and of types descended from it.) If the exception doesn't match the specification, the unmatched exception is branded an *unexpected exception*, and, by default, it causes the program to abort. (Although C++11 deprecates exception specifications, they still remain in the language and in some existing code.) If the exception passes this first hurdle (or avoids it because the function lacks an exception specification), it then has to be caught. If it isn't, which can happen if there is no containing `try` block or no matching `catch` block, the exception is branded an *uncaught exception*, and by default, it causes the program to abort. However, you can alter a program's response to unexpected and uncaught exceptions. Let's see how, beginning with uncaught exceptions.

An uncaught exception doesn't initiate an immediate abort. Instead, the program first calls a function called `terminate()`. By default, `terminate()` calls the `abort()` function. You can modify the behavior of `terminate()` by *registering* a function that `terminate()` should call instead of `abort()`. To do this, you call the `set_terminate()` function. Both `set_terminate()` and `terminate()` are declared in the exception header file:

```
typedef void (*terminate_handler)();
terminate_handler set_terminate(terminate_handler f) throw(); // C++98
terminate_handler set_terminate(terminate_handler f) noexcept; // C++11
void terminate(); // C++98
void terminate() noexcept; // C++11
```

Here the `typedef` makes `terminate_handler` the type name for a pointer to a function that has no arguments and no return value. The `set_terminate()` function takes, as its argument, the name of a function (that is, its address) that has no arguments and the `void` return type. It returns the address of the previously registered function. If you call the `set_terminate()` function more than once, `terminate()` calls the function set by the most recent call to `set_terminate()`.

Let's look at an example. Suppose you want an uncaught exception to cause a program to print a message to that effect and then call the `exit()` function, providing an exit status value of 5. First, you include the exception header file. You can make its declarations available with a `using` directive or appropriate `using` declarations, or you can use the `std::` qualifier:

```
#include <exception>
using namespace std;
```

Next, you design a function that does the two required actions and has the proper prototype:

```
void myQuit()
{
    cout << "Terminating due to uncaught exception\n";
```

```
    exit(5);
}
```

Finally, at the start of the program, you designate this function as your chosen termination action:

```
set_terminate(myQuit);
```

Now, if an exception is thrown and not caught, the program calls `terminate()`, and `terminate()` calls `MyQuit()`.

Next, let's look at unexpected exceptions. By using exception specifications for a function, you provide the means for users of the functions to know which exceptions to catch. That is, suppose you have the following prototype:

```
double Argh(double, double) throw(out_of_bounds);
```

Then you might use the function this way:

```
try {
    x = Argh(a, b);
}
catch(out_of_bounds & ex)
{
    ...
}
```

It's good to know which exceptions to catch; recall that an uncaught exception, by default, aborts the program.

However, there's a bit more to the story. In principle, the exception specification should include exceptions thrown by functions called by the function in question. For example, if `Argh()` calls a `Duh()` function that can throw a `retort` object exception, then `retort` should appear in the `Argh()` exception specification as well as in the `Duh()` exception specification. Unless you write all the functions yourself and are careful, there's no guarantee that this will get done correctly. You might, for example, use an older commercial library whose functions don't have exception specifications. This suggests that you should look more closely at what happens if a function throws an exception that is not in its exception specification. (It also suggests that the whole exception specification mechanism might be unwieldy, which is part of the reason C++11 deprecates it.)

The behavior is much like that for uncaught exceptions. If there is an unexpected exception, the program calls the `unexpected()` function. (You didn't expect the `unexpected()` function? No one expects the `unexpected()` function!) This function, in turn, calls `terminate()`, which, by default, calls `abort()`. Just as there is a `set_terminate()` function that modifies the behavior of `terminate()`, there is a `set_unexpected()` function that modifies the behavior of `unexpected()`. These new functions are also declared in the exception header file:

```
typedef void (*unexpected_handler)();
unexpected_handler set_unexpected(unexpected_handler f) throw(); // C++98
unexpected_handler set_unexpected(unexpected_handler f) noexcept; // C++11
```



```
void unexpected();           // C++98
void unexpected() noexcept; // C++0x
```

However, the behavior of the function you supply for `set_unexpected()` is more regulated than that of a function for `set_terminate()`. In particular, the `unexpected_handler` function has the following choices:

- It can end the program by calling `terminate()` (the default behavior), `abort()`, or `exit()`.
- It can throw an exception.

The result of throwing an exception (the second choice here) depends on the exception thrown by the replacement `unexpected_handler` function and the original exception specification for the function that threw the unexpected type:

- If the newly thrown exception matches the original exception specification, then the program proceeds normally from there; that is, it will look for a `catch` block that matches the newly thrown exception. Basically, this approach replaces an exception of an unexpected type to an exception of an expected type.
- If the newly thrown exception does not match the original exception specification and if the exception specification *does not* include the `std::bad_exception` type, the program calls `terminate()`. The `bad_exception` type derives from the `exception` type and is declared in the `exception` header file.
- If the newly thrown exception does not match the original exception specification and if the original exception specification *does* include the `std::bad_exception` type, the unmatched exception is replaced with an exception of the `std::bad_exception` type.

In short, if you'd like to catch all exceptions, expected or otherwise, you can do something like the following. First, you make sure the exception header file declarations are available:

```
#include <exception>
using namespace std;
```

Next, you design a replacement function that converts unexpected exceptions to the `bad_exception` type and that has the proper prototype:

```
void myUnexpected()
{
    throw std::bad_exception(); //or just throw;
}
```

Just using `throw` without an exception causes the original exception to be rethrown. However, the exception will be replaced with a `bad_exception` object if the exception specification includes that type.

Next, at the start of the program, you designate this function as your chosen unexpected exception action:

```
set_unexpected(myUnexpected);
```

Finally, you include the `bad_exception` type in exception specifications and catch block sequences:

```
double Argh(double, double) throw(out_of_bounds, bad_exception);
...
try {
    x = Argh(a, b);
}
catch(out_of_bounds & ex)
{
    ...
}
catch(bad_exception & ex)
{
    ...
}
```

## Exception Cautions

From the preceding discussion of using exceptions, you might gather (and gather correctly) that exception handling should be designed into a program rather than tacked on. Doing this has some disadvantages, though. For example, using exceptions adds to the size and subtracts from the speed of a program. Exception specifications don't work well with templates because template functions might throw different kinds of exceptions, depending on the particular specialization used. Exceptions and dynamic memory allocation don't always work that well together.

Let's look a little further at dynamic memory allocation and exceptions. First, consider the following function:

```
void test1(int n)
{
    string msg("I'm trapped in an endless loop");
    ...
    if (oh_no)
        throw exception();
    ...
    return;
}
```

The `string` class uses dynamic memory allocation. Normally, the `string` destructor for `msg` would be called when the function reached `return` and terminated. Thanks to stack unwinding, the `throw` statement, even though it terminates the function prematurely, still allows the destructor to be called. So in this case, memory is managed properly.

Now consider this function:

```
void test2(int n)
{
    double * ar = new double[n];
    ...
    if (oh_no)
        throw exception();
    ...
    delete [] ar;
    return;
}
```

Here there is a problem. Unwinding the stack removes the variable `ar` from the stack. But the premature termination of the function means that the `delete []` statement at the end of the function is skipped. The pointer is gone, but the memory block it pointed to is still intact and inaccessible. In short, there is a memory leak.

The leak can be avoided. For example, you can catch the exception in the same function that throws it, put some cleanup code into the `catch` block, and rethrow the exception:

```
void test3(int n)
{
    double * ar = new double[n];
    ...
    try {
        if (oh_no)
            throw exception();
    }
    catch(exception & ex)
    {
        delete [] ar;
        throw;
    }
    ...
    delete [] ar;
    return;
}
```

However, this clearly enhances the opportunities for oversights and other errors. Another solution is to use one of the smart pointer templates discussed in Chapter 16, “The `string` Class and the Standard Template Library.”

In short, although exception handling is extremely important for some projects, it does have costs in terms of programming effort, program size, and program speed. On the other hand, the cost of no error checking can be much worse.

## Exception Handling

In modern libraries, exception handling can appear to reach new levels of complexity—much of it due to undocumented or poorly documented exception-handling routines. Anyone familiar with the use of a modern operating system has surely seen the errors and problems caused by unhandled exceptions. The programmers behind these errors often face an uphill battle, learning the complexity that lies within the libraries: what exceptions are thrown, why and when they occur, and how to handle them.

A novice programmer quickly finds that the research battle to understand exception handling in a library is as difficult as the struggle to learn the language itself; modern libraries can contain routines and paradigms as alien and difficult as any C++ syntax detail. Exposure to and understanding of the intricacies of libraries and classes is, for good software, as necessary as the time you spend learning C++ itself. The exception and error-handling details you decipher from your libraries' documentation and source code will always serve you and your software in good stead.

## Runtime Type Identification

*Runtime type identification (RTTI)* is one of the more recent additions to C++, and it isn't supported by many older implementations. Other implementations may have compiler settings for turning RTTI on and off. The intent of RTTI is to provide a standard way for a program to determine the type of object during runtime. Many class libraries have already provided ways to do so for their own class objects, but in the absence of built-in support in C++, each vendor's mechanism is typically incompatible with those of other vendors. Creating a language standard for RTTI should allow future libraries to be compatible with each other.

### What Is RTTI For?

Suppose you have a hierarchy of classes descended from a common base class. You can set a base-class pointer to point to an object of any of the classes in this hierarchy. Next, you call a function that, after processing some information, selects one of these classes, creates an object of that type, and returns its address, which gets assigned to a base-class pointer. How can you tell what kind of object it points to?

Before answering this question, you need to think about why you would want to know the type. Perhaps you want to invoke the correct version of a class method. If that's the case, you don't really need to know the object type, as long as that function is a virtual function possessed by all members of the class hierarchy. But it could be that a derived object has an uninherited method. In that case, only some objects could use the method. Or maybe, for debugging purposes, you would like to keep track of which kinds of objects were generated. For these last two cases, RTTI provides an answer.

## How Does RTTI Work?

C++ has three components supporting RTTI:

- The `dynamic_cast` operator generates a pointer to a derived type from a pointer to a base type, if possible. Otherwise, the operator returns 0, the null pointer.
- The `typeid` operator returns a value identifying the exact type of an object.
- A `type_info` structure holds information about a particular type.

You can use RTTI only with a class hierarchy that has virtual functions. The reason for this is that these are the only class hierarchies for which you should be assigning the addresses of derived objects to base-class pointers.

### Caution

RTTI works only for classes that have virtual functions.

Let's examine the three components of RTTI.

### The `dynamic_cast` Operator

The `dynamic_cast` operator is intended to be the most heavily used RTTI component. It doesn't answer the question of what type of object a pointer points to. Instead, it answers the question of whether you can safely assign the address of an object to a pointer of a particular type. Let's look at what that means. Suppose you have the following hierarchy:

```
class Grand { // has virtual methods};
class Superb : public Grand { ... };
class Magnificent : public Superb { ... };
```

Next, suppose you have the following pointers:

```
Grand * pg = new Grand;
Grand * ps = new Superb;
Grand * pm = new Magnificent;
```

Finally, consider the following type casts:

```
Magnificent * p1 = (Magnificent *) pm;           // #1
Magnificent * p2 = (Magnificent *) pg;           // #2
Superb * p3 = (Magnificent *) pm;                // #3
```

Which of these type casts are safe? Depending on the class declarations, all of them could be safe, but the only ones guaranteed to be safe are the ones in which the pointer is the same type as the object or else a direct or indirect base type for the object. For example, Type Cast #1 is safe because it sets a type `Magnificent` pointer to point to a type `Magnificent` object. Type Cast #2 is not safe because it assigns the address of a base-class object (`Grand`) to a derived-class (`Magnificent`) pointer. Thus, the program would expect the base-class object to have derived-class properties, and that, in general, is false. A `Magnificent` object, for example, might have data members that a `Grand` object would

lack. Type Cast #3, however, is safe because it assigns the address of a derived-class object to a base-class pointer. That is, public derivation promises that a `Magnificent` object also is a `Superb` object (direct base) and a `Grand` object (indirect base). Thus, it's safe to assign its address to pointers of all three types. Virtual functions ensure that using pointers of any of the three types to a `Magnificent` object will invoke `Magnificent` methods.

Note that the question of whether a type conversion is safe is both more general and more useful than the question of what kind of object is pointed to. The usual reason for wanting to know the type is so that you can know if it's safe to invoke a particular method. You don't necessarily need an exact type match to invoke a method. The type can be a base type for which a virtual version of the method is defined. The next example illustrates this point.

First, however, let's look at the `dynamic_cast` syntax. The operator is used like this, where `pg` points to an object:

```
Superb * pm = dynamic_cast<Superb *>(pg);
```

This code asks whether the pointer `pg` can be type cast safely (as described previously) to the type `Superb *`. If it can, the operator returns the address of the object. Otherwise it returns 0, the null pointer.

### Note

In general, the following expression converts the pointer `pt` to a pointer of type `Type *` if the pointed-to object (`*pt`) is of type `Type` or else derived directly or indirectly from type `Type`:

```
dynamic_cast<Type *>(pt)
```

Otherwise, the expression evaluates to 0, the null pointer.

Listing 15.17 illustrates the process. First it defines three classes, coincidentally named `Grand`, `Superb`, and `Magnificent`. The `Grand` class defines a virtual `Speak()` function, which each of the other classes redefines. The `Superb` class defines a virtual `Say()` function, which `Magnificent` redefines (see Figure 15.4). The program defines a `GetOne()` function that randomly creates and initializes an object of one of these three types and then returns the address as a type `Grand *` pointer. (The `GetOne()` function simulates an interactive user making decisions.) A loop assigns this pointer to a type `Grand *` variable called `pg` and then uses `pg` to invoke the `Speak()` function. Because this function is virtual, the code correctly invokes the `Speak()` version that is appropriate to the pointed-to object:

```
for (int i = 0; i < 5; i++)
{
    pg = GetOne();
    pg->Speak();
    ...
}
```

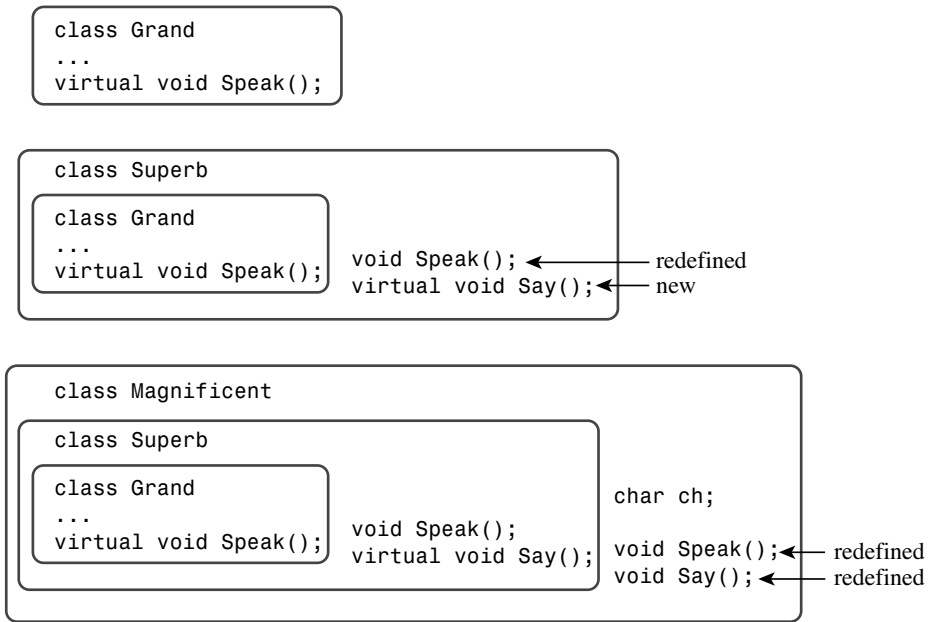

Figure 15.4 The Grand family of classes.

You can't use this exact approach (using a pointer-to-`Grand`) to invoke the `Say()` function; it's not defined for the `Grand` class. However, you can use the `dynamic_cast` operator to see if `pg` can be type cast to a pointer to `Superb`. This will be true if the object is either type `Superb` or `Magnificent`. In either case, you can invoke the `Say()` function safely:

```
if (ps = dynamic_cast<Superb *>(pg))
    ps->Say();
```

Recall that the value of an assignment expression is the value of its left-hand side. Thus, the value of the `if` condition is `ps`. If the type cast succeeds, `ps` is nonzero, or true. If the type cast fails, which it will if `pg` points to a `Grand` object, `ps` is zero, or false. Listing 15.17 shows the full code. (By the way, some compilers, noting that programmers usually use the `==` operator in an `if` statement condition, may issue a warning about unintended assignment.)

#### Listing 15.17 `rtti1.cpp`

```
// rtti1.cpp -- using the RTTI dynamic_cast operator
#include <iostream>
#include <cstdlib>
#include <ctime>

using std::cout;
```

```
class Grand
{
private:
    int hold;
public:
    Grand(int h = 0) : hold(h) {}
    virtual void Speak() const { cout << "I am a grand class!\n"; }
    virtual int Value() const { return hold; }
};

class Superb : public Grand
{
public:
    Superb(int h = 0) : Grand(h) {}
    void Speak() const {cout << "I am a superb class!!\n"; }
    virtual void Say() const
        { cout << "I hold the superb value of " << Value() << "!\n"; }
};

class Magnificent : public Superb
{
private:
    char ch;
public:
    Magnificent(int h = 0, char c = 'A') : Superb(h), ch(c) {}
    void Speak() const {cout << "I am a magnificent class!!!\n"; }
    void Say() const {cout << "I hold the character " << ch <<
        " and the integer " << Value() << "!\n"; }
};

Grand * GetOne();

int main()
{
    std::srand(std::time(0));
    Grand * pg;
    Superb * ps;
    for (int i = 0; i < 5; i++)
    {
        pg = GetOne();
        pg->Speak();
        if( ps = dynamic_cast<Superb *>(pg))
            ps->Say();
    }
    return 0;
}
```



```

Grand * GetOne()    // generate one of three kinds of objects randomly
{
    Grand * p;
    switch( std::rand() % 3)
    {
        case 0: p = new Grand(std::rand() % 100);
                break;
        case 1: p = new Superb(std::rand() % 100);
                break;
        case 2: p = new Magnificent(std::rand() % 100,
                                     'A' + std::rand() % 26);
                break;
    }
    return p;
}

```

---

### Note

Even if your compiler supports RTTI, it might have that feature turned off by default. If the feature is inactive, the program may still compile but produce runtime errors. If you find this to be the case, you should check your documentation or explore the menu options.

The program in Listing 15.17 illustrates an important point. You should use virtual functions when possible and RTTI only when necessary. Here is some sample output:

```

I am a superb class!!
I hold the superb value of 68!
I am a magnificent class!!!
I hold the character R and the integer 68!
I am a magnificent class!!!
I hold the character D and the integer 12!
I am a magnificent class!!!
I hold the character V and the integer 59!
I am a grand class!

```

As you can see, the `Say()` methods were invoked just for the `Superb` and `Magnificent` classes. (The output will vary from run to run because the program uses `rand()` to select the object type.)

You can use `dynamic_cast` with references, too. The usage is slightly different; there is no reference value corresponding to the null-pointer type, so there's no special reference value that can be used to indicate failure. Instead, when goaded by an improper request, `dynamic_cast` throws a type `bad_cast` exception, which is derived from the `exception` class and defined in the `typeinfo` header file. Thus, the operator can be used as follows, where `rg` is a reference to a `Grand` object:

```

#include <typeinfo> // for bad_cast
...
try {

```

```
    Superb & rs = dynamic_cast<Superb &>(rg);
    ...
}
catch(bad_cast &){
    ...
};
```

## The typeid Operator and type\_info Class

The `typeid` operator lets you determine whether two objects are the same type. Somewhat like `sizeof`, it accepts two kinds of arguments:

- The name of a class
- An expression that evaluates to an object

The `typeid` operator returns a reference to a `type_info` object, where `type_info` is a class defined in the `typeinfo` header file (formerly `typeinfo.h`). The `type_info` class overloads the `==` and `!=` operators so that you can use these operators to compare types. For example, the following expression evaluates to the `bool` value `true` if `pg` points to a `Magnificent` object and to `false` otherwise:

```
typeid(Magnificent) == typeid(*pg)
```

If `pg` happens to be a null pointer, the program throws a `bad_typeid` exception. This exception type is derived from the `exception` class and is declared in the `typeinfo` header file.

The implementation of the `type_info` class varies among vendors, but it includes a `name()` member that returns an implementation-dependent string that is typically (but not necessarily) the name of the class. For example, the following program displays the string defined for the class of the object to which the pointer `pg` points:

```
cout << "Now processing type " << typeid(*pg).name() << ".\n";
```

Listing 15.18 modifies Listing 15.17 so that it uses the `typeid` operator and the `name()` member function. Note that they are used for situations that `dynamic_cast` and `virtual` functions don't handle. The `typeid` test is used to select an action that isn't even a class method, so it can't be invoked by a class pointer. The `name()` method statement shows how the method can be used in debugging. Note that the program includes the `typeinfo` header file.

### Listing 15.18 `rtti2.cpp`

---

```
// rtti2.cpp -- using dynamic_cast, typeid, and type_info
#include <iostream>
#include <cstdlib>
#include <ctime>
#include <typeinfo>
using namespace std;
```

```

class Grand
{
private:
    int hold;
public:
    Grand(int h = 0) : hold(h) {}
    virtual void Speak() const { cout << "I am a grand class!\n"; }
    virtual int Value() const { return hold; }
};

class Superb : public Grand
{
public:
    Superb(int h = 0) : Grand(h) {}
    void Speak() const {cout << "I am a superb class!!\n"; }
    virtual void Say() const
        { cout << "I hold the superb value of " << Value() << "!\n"; }
};

class Magnificent : public Superb
{
private:
    char ch;
public:
    Magnificent(int h = 0, char cv = 'A') : Superb(h), ch(cv) {}
    void Speak() const {cout << "I am a magnificent class!!!\n"; }
    void Say() const {cout << "I hold the character " << ch <<
        " and the integer " << Value() << "!\n"; }
};

Grand * GetOne();
int main()
{
    srand(time(0));
    Grand * pg;
    Superb * ps;
    for (int i = 0; i < 5; i++)
    {
        pg = GetOne();
        cout << "Now processing type " << typeid(*pg).name() << ".\n";
        pg->Speak();
        if ( ps = dynamic_cast<Superb *>(pg))
            ps->Say();
        if (typeid(Magnificent) == typeid(*pg))
            cout << "Yes, you're really magnificent.\n";
    }
    return 0;
}

```

```
}

Grand * GetOne()
{
    Grand * p;

    switch( rand() % 3)
    {
        case 0: p = new Grand(rand() % 100);
                break;
        case 1: p = new Superb(rand() % 100);
                break;
        case 2: p = new Magnificent(rand() % 100, 'A' + rand() % 26);
                break;
    }
    return p;
}
```

---

Here's a sample run of the program in Listing 15.18:

```
Now processing type Magnificent.
I am a magnificent class!!!
I hold the character P and the integer 52!
Yes, you're really magnificent.
Now processing type Superb.
I am a superb class!!
I hold the superb value of 37!
Now processing type Grand.
I am a grand class!
Now processing type Superb.
I am a superb class!!
I hold the superb value of 18!
Now processing type Grand.
I am a grand class!
```

As with the preceding example, the exact output will vary from run to run because the program uses `rand()` to select types. Also some compilers may provide different output when `name()` is called, for example, `5Grand` instead of `Grand`.

## Misusing RTTI

RTTI has many vocal critics within the C++ community. They view RTTI as unnecessary, a potential source of program inefficiency, and a possible contributor to bad programming practices. Without delving into the debate over RTTI, let's look at the sort of programming that you should avoid.

Consider the core of Listing 15.17:

```
Grand * pg;
Superb * ps;
for (int i = 0; i < 5; i++)
{
    pg = GetOne();
    pg->Speak();
    if ( ps = dynamic_cast<Superb *>(pg))
        ps->Say();
}
```

By using `typeid` and ignoring `dynamic_cast` and virtual functions, you can rewrite this code as follows:

```
Grand * pg;
Superb * ps;
Magnificent * pm;
for (int i = 0; i < 5; i++)
{
    pg = GetOne();
    if (typeid(Magnificent) == typeid(*pg))
    {
        pm = (Magnificent *) pg;
        pm->Speak();
        pm->Say();
    }
    else if (typeid(Superb) == typeid(*pg))
    {
        ps = (Superb *) pg;
        ps->Speak();
        ps->Say();
    }
    else
        pg->Speak();
}
```

Not only is this uglier and longer than the original, it has the serious flaw of naming each class explicitly. Suppose, for example, that you find it necessary to derive an `Insufferable` class from the `Magnificent` class. And suppose the new class redefines `Speak()` and `Say()`. With the version that uses `typeid` to test explicitly for each type, you would have to modify the `for` loop code, adding a new `else if` section. The original version, however, requires no changes at all. The following statement works for all classes derived from `Grand`:

```
pg->Speak();
```

And this statement works for all classes derived from `Superb`:

```
if ( ps = dynamic_cast<Superb *>(pg))
    ps->Say();
```

**Tip**

If you find yourself using `typeid` in an extended series of `if else` statements, you should check whether you should instead use virtual functions and `dynamic_cast`.

## Type Cast Operators

The C type cast operator, in Bjarne Stroustrup's view, is too lax. For example, consider the following:

```
struct Data
{
    double data[200];
};

struct Junk
{
    int junk[100];
};

Data d = {2.5e33, 3.5e-19, 20.2e32};
char * pch = (char *) (&d);    // type cast #1 - convert to string
char ch = char (&d);          // type cast #2 - convert address to a char
Junk * pj = (Junk *) (&d);    // type cast #3 - convert to Junk pointer
```

First, which of these three type casts makes any sense? Unless you resort to the implausible, none of them make much sense. Second, which of these three type casts are allowed? In C, all of them are. Stroustrup's response to this laxity was to tighten up what is allowable for a general type cast and to add four type cast operators that provide more discipline for the casting process:

```
dynamic_cast
const_cast
static_cast
reinterpret_cast
```

Instead of using a general type cast, you can select an operator that is suited to a particular purpose. This documents the intended reason for the type cast and gives the compiler a chance to check that you did what you thought you did.

You've already seen the `dynamic_cast` operator. To summarize, suppose `High` and `Low` are two classes, that `ph` is type `High *`, and that `p1` is type `Low *`. Then the following statement assigns a `Low *` pointer to `p1` only if `Low` is an accessible base class (direct or indirect) to `High`:

```
p1 = dynamic_cast<Low *> ph;
```

Otherwise, the statement assigns the null pointer to `p1`. In general, the operator has this syntax:

```
dynamic_cast < type-name > (expression)
```

The purpose of this operator is to allow upcasts within a class hierarchy (such type casts being safe because of the *is-a* relationship) and to disallow other casts.

The `const_cast` operator is for making a type cast with the sole purpose of changing whether a value is `const` or `volatile`. It has the same syntax as the `dynamic_cast` operator:

```
const_cast < type-name > (expression)
```

The result of making such a type cast is an error if any other aspect of the type is altered. That is, `type_name` and `expression` must be of the same type, except that they can differ in the presence or absence of `const` or `volatile`. Again, suppose `High` and `Low` are two classes:

```
High bar;
const High * pbar = &bar;
...
High * pb = const_cast<High *> (pbar);    // valid
const Low * pl = const_cast<const Low *> (pbar);    // invalid
```

The first type cast makes `*pb` a pointer that can be used to alter the value of the `bar` object; it removes the `const` label. The second type cast is invalid because it attempts to change the type from `const High *` to `const Low *`.

The reason for this operator is that occasionally you may have a need for a value that is constant most of the time but that can be changed occasionally. In such a case, you can declare the value as `const` and use `const_cast` when you need to alter the value. This could be done using the general type cast, but the general type cast can also simultaneously change the type:

```
High bar;
const High * pbar = &bar;
...
High * pb = (High *) (pbar);    // valid
Low * pl = (Low *) (pbar);    // also valid
```

Because the simultaneous change of type and constantness may be an unintentional programming slip, using the `const_cast` operator is safer.

The `const_cast` is not all powerful. It can change the pointer access to a quantity, but the effect of attempting to change a quantity that is declared `const` is undefined. Let's clarify this statement with the short example shown in Listing 15.19.

#### Listing 15.19 `constcast.cpp`

---

```
// constcast.cpp -- using const_cast<>
#include <iostream>
using std::cout;
using std::endl;
```

```

void change(const int * pt, int n);

int main()
{
    int pop1 = 38383;
    const int pop2 = 2000;

    cout << "pop1, pop2: " << pop1 << ", " << pop2 << endl;
    change(&pop1, -103);
    change(&pop2, -103);
    cout << "pop1, pop2: " << pop1 << ", " << pop2 << endl;
    return 0;
}

void change(const int * pt, int n)
{
    int * pc;

    pc = const_cast<int *>(pt);
    *pc += n;
}

```

---

The `const_cast` operator can remove the `const` from `const int * pt`, thus allowing the compiler to accept the following statement in `change()`:

```
*pc += n;
```

However, because `pop2` is declared as `const`, the compiler may protect it from any change, as is shown by the following sample output:

```

pop1, pop2: 38383, 2000
pop1, pop2: 38280, 2000

```

As you can see, the calls to `change()` alter `pop1` but not `pop2`. The pointer in `change()` is declared as `const int *`, so it can't be used to change the value of the pointed-to `int`. The pointer `pc` has the `const` cast away, so it can be used to change the pointed-to value, but only if that value wasn't itself `const`. Therefore, `pc` can be used to alter `pop1` but not `pop2`.

The `static_cast` operator has the same syntax as the other operators:

```
static_cast < type-name > (expression)
```

It's valid only if `type_name` can be converted implicitly to the same type that `expression` has, or vice versa. Otherwise, the type cast is an error. Suppose that `High` is a base class to `Low` and that `Pond` is an unrelated class. Then conversions from `High` to `Low` and `Low` to `High` are valid, but a conversion from `Low` to `Pond` is disallowed:

```

High bar;
Low blow;
...

```



```
High * pb = static_cast<High *> (&blow);    // valid upcast
Low * pl = static_cast<Low *> (&bar);      // valid downcast
Pond * pmer = static_cast<Pond *> (&blow); // invalid, Pond unrelated
```

The first conversion here is valid because an upcast can be done explicitly. The second conversion, from a base-class pointer to a derived-class pointer, can't be done without an explicit type conversion. But because the type cast in the other direction can be made without a type cast, it's valid to use `static_cast` for a downcast.

Similarly, because an enumeration value can be converted to an integral type without a type cast, an integral type can be converted to an enumeration value with `static_cast`. Also you can use `static_cast` to convert `double` to `int`, to convert `float` to `long`, and to perform the various other numeric conversions.

The `reinterpret_cast` operator is for inherently risky type casts. It doesn't let you cast away `const`, but it does allow other unsavory things. Sometimes a programmer has to do implementation-dependent, unsavory things, and using the `reinterpret_cast` operator makes it simpler to keep track of such acts. It has the same syntax as the other three operators:

```
reinterpret_cast < type-name > (expression)
```

Here is a sample use:

```
struct dat {short a; short b;};
long value = 0xA224B118;
dat * pd = reinterpret_cast< dat *> (&value);
cout << hex << pd->a;    // display first 2 bytes of value
```

Typically, such type casts would be used for low-level, implementation-dependent programming and would not be portable. For example, one system may store the bytes in a multibyte value in a different order than does a second system.

The `reinterpret_cast` operator doesn't allow just anything, however. For example, you can cast a pointer type to an integer type that's large enough to hold the pointer representation, but you can't cast a pointer to a smaller integer type or to a floating-point type. Another restriction is that you can't cast a function pointer to a data pointer or vice versa.

The plain type cast in C++ is also restricted. Basically, it can do anything the other type casts can do, plus some combinations, such as a `static_cast` or `reinterpret_cast` followed by a `const_cast`, but it can't do anything else. Thus, the following type cast is allowed in C but, typically, not in C++ because for most C++ implementations the `char` type is too small to hold a pointer implementation:

```
char ch = char (&d);    // type cast #2 - convert address to a char
```

These restrictions make sense, but if you find such enforced good judgment oppressive, you still have C available.

## Summary

Friends allow you to develop a more flexible interface for classes. A class can have other functions, other classes, and member functions of other classes as friends. In some cases, you may need to use forward declarations and to exert care in the ordering of class declarations and methods in order to get friends to mesh properly.

Nested classes are classes that are declared within other classes. Nested classes facilitate the design of helper classes that implement other classes but needn't be part of a public interface.

The C++ exception mechanism provides a flexible way to deal with awkward programming events such as inappropriate values, failed I/O attempts, and the like. Throwing an exception terminates the function currently executing and transfers control to a matching `catch` block. `catch` blocks immediately follow a `try` block, and for an exception to be caught, the function call that directly or indirectly led to the exception must be in the `try` block. The program then executes the code in the `catch` block. This code may attempt to fix the problem, or it can terminate the program. A class can be designed with nested exception classes that can be thrown when problems specific to the class are detected. A function can include an exception specification that identifies the exceptions that can be thrown in that function, although C++11 deprecates that feature. Uncaught exceptions (those with no matching `catch` block) by default terminate a program. So do unexpected exceptions (those not matching an exception specification.)

The RTTI features allow a program to detect the type of an object. The `dynamic_cast` operator is used to cast a derived-class pointer to a base-class pointer; its main purpose is to ensure that it's okay to invoke a virtual function call. The `typeid` operator returns a `type_info` object. Two `typeid` return values can be compared to determine whether an object is of a specific type, and the returned `type_info` object can be used to obtain information about an object.

The `dynamic_cast`, `static_cast`, `const_cast`, and `reinterpret_cast` operators provide safer, better-documented type casts than the general type cast mechanism.

## Chapter Review

1. What's wrong with the following attempts at establishing friends?

```
a. class snap {
    friend clas;
    ...
};
class clas { ... };
```

b. class cuff {  
public:  
 void snip(muff &) { ... }  
 ...

```
};
class muff {
    friend void cuff::snip(muff &);
    ...
};
```

```
c. class muff {
    friend void cuff::snip(muff &);
    ...
};
class cuff {
public:
    void snip(muff &) { ... }
    ...
};
```

2. You've seen how to create mutual class friends. Can you create a more restricted form of friendship in which only some members of Class B are friends to Class A and some members of A are friends to B? Explain.
3. What problems might the following nested class declaration have?

```
class Ribs
{
private:
    class Sauce
    {
        int soy;
        int sugar;
    public:
        Sauce(int s1, int s2) : soy(s1), sugar(s2) { }
    };
    ...
};
```

4. How does `throw` differ from `return`?
5. Suppose you have a hierarchy of exception classes that are derived from a base exception class. In what order should you place `catch` blocks?
6. Consider the `Grand`, `Superb`, and `Magnificent` classes defined in this chapter. Suppose `pg` is a type `Grand *` pointer that is assigned the address of an object of one of these three classes and that `ps` is a type `Superb *` pointer. What is the difference in how the following two code samples behave?

```
if (ps = dynamic_cast<Superb *>(pg))
    ps->say(); // sample #1
```

```
if (typeid(*pg) == typeid(Superb))
    (Superb *) pg->say(); // sample #2
```

7. How is the `static_cast` operator different from the `dynamic_cast` operator?

## Programming Exercises

1. Modify the `Tv` and `Remote` classes as follows:
  - a. Make them mutual friends.
  - b. Add a state variable member to the `Remote` class that describes whether the remote control is in normal or interactive mode.
  - c. Add a `Remote` method that displays the mode.
  - d. Provide the `Tv` class with a method for toggling the new `Remote` member. This method should work only if the TV is in the on state.

Write a short program that tests these new features.

2. Modify Listing 15.11 so that the two exception types are classes derived from the `logic_error` class provided by the `<stdexcept>` header file. Have each `what()` method report the function name and the nature of the problem. The exception objects need not hold the bad values; they should just support the `what()` method.
3. This exercise is the same as Programming Exercise 2, except that the exceptions should be derived from a base class (itself derived from `logic_error`) that stores the two argument values, the exceptions should have a method that reports these values as well as the function name, and a single `catch` block that catches the base-class exemption should be used for both exceptions, with either exception causing the loop to terminate.
4. Listing 15.16 uses two `catch` blocks after each `try` block so that the `nbad_index` exception leads to the `label_val()` method being invoked. Modify the program so that it uses a single `catch` block after each `try` block and uses RTTI to handle invoking `label_val()` only when appropriate.

*This page intentionally left blank*

# The `string` Class and the Standard Template Library

In this chapter you'll learn about the following:

- The standard C++ `string` class
- The `auto_ptr`, `unique_ptr`, and `shared_ptr` templates
- The Standard Template Library (STL)
- Container classes
- Iterators
- Function objects (functors)
- STL algorithms
- The `initializer_list` template

By now you are familiar with the C++ goal of reusable code. One of the big payoffs is when you can reuse code written by others. That's where class libraries come in. There are many commercially available C++ class libraries, and there are also libraries that come as part of the C++ package. For example, you've been using the input/output classes supported by the `ostream` header file. This chapter looks at other reusable code available for your programming pleasure.

You've already encountered the `string` class, and this chapter examines it more extensively. Then the chapter looks at "smart pointer" template classes that make managing dynamic memory a bit easier. Next, the chapter looks at the Standard Template Library (STL), a collection of useful templates for handling various kinds of container objects. The STL exemplifies the programming paradigm called *generic programming*. Finally, the chapter looks at the `initializer_list` template class, the C++11 addition that enables using initializer-list syntax with STL objects.

## The `string` Class

Many programming applications need to process strings. C provides some support with its `string.h` (`cstring` in C++) family of string functions, and many early C++ implementations provide home-grown classes to handle strings. Chapter 4, “Compound Types,” introduced the ANSI/ISO C++ `string` class. Chapter 12, “Classes and Dynamic Memory Allocation,” with its modest `String` class, illustrates some aspects of designing a class to represent strings.

Recall that the `string` class is supported by the `string` header file. (Note that the `string.h` and `cstring` header files support the C library string functions for C-style strings, not the `string` class.) The key to using a class is knowing its public interface, and the `string` class has an extensive set of methods, including several constructors, overloaded operators for assigning strings, concatenating strings, comparing strings, and accessing individual elements, as well as utilities for finding characters and substrings in a string, and more. In short, the `string` class has lots to offer.

### Constructing a String

Let’s look at the `string` constructors. After all, one of the most important things to know about a class is what your options are when creating objects of that class. Listing 16.1 uses seven of the `string` constructors (labeled `ctor`, the traditional C++ abbreviation for *constructor*). Table 16.1 briefly describes the constructors. The table begins with the seven constructors used in Listing 16.1, in that order. It also lists a couple of C++11 additions. The constructor representations are simplified in that they conceal the fact that `string` really is a `typedef` for a template specialization `basic_string<char>` and that they omit an optional argument relating to memory management. (This aspect is discussed later this chapter and in Appendix F, “The `string` Template Class.”) The type `size_type` is an implementation-dependent integral type defined in the `string` header file. The class defines `string::npos` as the maximum possible length of the string. Typically, this would equal the maximum value of an `unsigned int`. Also the table uses the common abbreviation NBTS for null-byte-terminated string—that is, the traditional C string, which is terminated with a null character.

Table 16.1 `string` Class Constructors

| Constructor                                 | Description                                                                                                         |
|---------------------------------------------|---------------------------------------------------------------------------------------------------------------------|
| <code>string(const char * s)</code>         | Initializes a <code>string</code> object to the NBTS pointed to by <code>s</code> .                                 |
| <code>string(size_type n, char c)</code>    | Creates a <code>string</code> object of <code>n</code> elements, each initialized to the character <code>c</code> . |
| <code>string(const string &amp; str)</code> | Initializes a <code>string</code> object to the <code>string</code> object <code>str</code> (copy constructor).     |

Table 16.1 **string** Class Constructors

| Constructor                                                                    | Description                                                                                                                                                                                                                                                                    |
|--------------------------------------------------------------------------------|--------------------------------------------------------------------------------------------------------------------------------------------------------------------------------------------------------------------------------------------------------------------------------|
| <code>string()</code>                                                          | Creates a default <code>string</code> object of 0 size (default constructor).                                                                                                                                                                                                  |
| <code>string(const char * s, size_type n)</code>                               | Initializes a <code>string</code> object to the NBTS pointed to by <code>s</code> and continues for <code>n</code> characters, even if that exceeds the size of the NBTS.                                                                                                      |
| <code>template&lt;class Iter&gt;<br/>string(Iter begin, Iter end)</code>       | Initializes a <code>string</code> object to the values in the range <code>[begin, end)</code> , where <code>begin</code> and <code>end</code> act like pointers and specify locations; the range includes <code>begin</code> and is up to but not including <code>end</code> . |
| <code>string(const string &amp; str, size_type pos, size_type n = npos)</code> | Initializes a <code>string</code> object to the object <code>str</code> , starting at position <code>pos</code> in <code>str</code> and going to the end of <code>str</code> or using <code>n</code> characters, whichever comes first.                                        |
| <code>string(string &amp;&amp; str) noexcept<br/>(C++11)</code>                | Initializes a <code>string</code> object to the <code>string</code> object <code>str</code> ; <code>str</code> may be altered (move constructor).                                                                                                                              |
| <code>string(initializer_list&lt;char&gt; il)<br/>(C++11)</code>               | Initializes a <code>string</code> object to the characters in the initializer list <code>il</code> .                                                                                                                                                                           |

Listing 16.1 **str1.cpp**

```
// str1.cpp -- introducing the string class
#include <iostream>
#include <string>
// using string constructors

int main()
{
    using namespace std;
    string one("Lottery Winner!");    // ctor #1
    cout << one << endl;              // overloaded <<
    string two(20, '$');              // ctor #2
    cout << two << endl;
    string three(one);                // ctor #3
    cout << three << endl;
    one += " Oops!";                  // overloaded +=
    cout << one << endl;
    two = "Sorry! That was ";
    three[0] = 'P';
    string four;                      // ctor #4
```



```

    four = two + three;           // overloaded +, =
    cout << four << endl;
    char alls[] = "All's well that ends well";
    string five(alls,20);        // ctor #5
    cout << five << "!\n";
    string six(alls+6, alls + 10); // ctor #6
    cout << six << ", ";
    string seven(&five[6], &five[10]); // ctor #6 again
    cout << seven << "... \n";
    string eight(four, 7, 16);   // ctor #7
    cout << eight << " in motion!" << endl;
    return 0;
}

```

---

The program in Listing 16.1 also uses the overloaded += operator, which appends one string to another, the overloaded = operator for assigning one string to another, the overloaded << operator for displaying a string object, and the overloaded [] operator for accessing an individual character in a string.

Here is the output of the program in Listing 16.1:

```

Lottery Winner!
$$$$$$$$$$$$$$$$$$$$
Lottery Winner!
Lottery Winner! Oops!
Sorry! That was Pottery Winner!
All's well that ends!
well, well...
That was Pottery in motion!

```

### Program Notes

The start of the program in Listing 16.1 illustrates that you can initialize a string object to a regular C-style string and display it by using the overloaded << operator:

```

string one("Lottery Winner!"); // ctor #1
cout << one << endl;          // overloaded <<

```

The next constructor initializes the string object two to a string consisting of 20 \$ characters:

```

string two(20, '$');          // ctor #2

```

The copy constructor initializes the string object three to the string object one:

```

string three(one);           // ctor #3

```

The overloaded += operator appends the string " Oops!" to the string one:

```

one += " Oops!";            // overloaded +=

```

This particular example appends a C-style string to a `string` object. However, the `+=` operator is multiply overloaded so that you can also append `string` objects and single characters:

```
one += two;    // append a string object (not in program)
one += '!';   // append a type char value (not in program)
```

Similarly, the `=` operator is overloaded so that you can assign a `string` object to a `string` object, a C-style string to a `string` object, or a simple char value to a `string` object:

```
two = "Sorry! That was "; // assign a C-style string
two = one;                // assign a string object (not in program)
two = '?';                // assign a char value (not in program)
```

Overloading the `[]` operator, as the `String` example in Chapter 12 does, permits access to individual characters in a `string` object by using array notation:

```
three[0] = 'P';
```

A default constructor creates an empty string that can later be given a value:

```
string four;                // ctor #4
four = two + three;        // overloaded +, =
```

The second line here uses the overloaded `+` operator to create a temporary `string` object, which is then assigned, using the overloaded `=` operator, to the `four` object. As you might expect, the `+` operator concatenates its two operands into a single `string` object. The operator is multiply overloaded, so the second operand can be a `string` object or a C-style string or a char value.

The fifth constructor takes a C-style string and an integer as arguments, with the integer indicating how many characters to copy:

```
char alls[] = "All's well that ends well";
string five(alls,20);    // ctor #5
```

Here, as the output shows, just the first 20 characters ("All's well that ends") are used to initialize the `five` object. As Table 16.1 notes, if the character count exceeds the length of the C-style string, the requested number of characters is still copied. So replacing 20 with 40 in the preceding example would result in 15 junk characters being copied at the end of `five`. (That is, the constructor would interpret the contents in memory following the string "All's well that ends well" as character codes.)

The sixth constructor has a template argument:

```
template<class Iter> string(Iter begin, Iter end);
```

The intent is that `begin` and `end` act like pointers pointing to two locations in memory. (In general, `begin` and `end` can be iterators, generalizations of pointers extensively used in the STL.) The constructor then uses the values between the locations pointed to by `begin` and `end` to initialize the `string` object it constructs. The notation `[begin, end)`, borrowed from mathematics, means the range includes `begin` but doesn't include `end`.

That is, `end` points to a location one past the last value to be used. Consider the following statement:

```
string six(alls+6, alls + 10); // ctor #6
```

Because the name of an array is a pointer, both `alls + 6` and `alls + 10` are type `char *`, so the template is used with `Iter` replaced by type `char *`. The first argument points to the first `w` in the `alls` array, and the second argument points to the space following the first `well`. Thus, `six` is initialized to the string "well". Figure 16.1 shows how the constructor works.

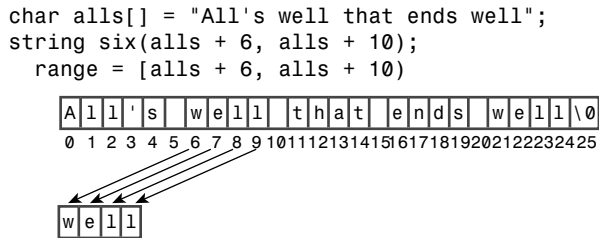

Figure 16.1 A string constructor using a range.

Now suppose you want to use this constructor to initialize an object to part of another string object—say, the object `five`. The following does not work:

```
string seven(five + 6, five + 10);
```

The reason is that the name of an object, unlike the name of an array, is not treated as the address of an object, hence `five` is not a pointer and `five + 6` is meaningless. However, `five[6]` is a `char` value, so `&five[6]` is an address and can be used as an argument to the constructor:

```
string seven(&five[6], &five[10]); // ctor #6 again
```

The seventh constructor copies a portion of one string object to the constructed object:

```
string eight(four, 7, 16); // ctor #7
```

This statement copies 16 characters from `four` to `eight`, starting at position 7 (the eighth character) in `four`.

## C++11 Constructors

The `string(string && str)` `noexcept` constructor is similar to the copy constructor in that the new `string` is a copy of `str`. However, unlike the copy constructor, it doesn't guarantee that `str` will be treated as `const`. This form of constructor is termed a *move constructor*. The compiler can use it in some situations instead of the copy constructor to

optimize performance. Chapter 18, “Visiting with the New C++ Standard,” discusses this topic in the section “Move Semantics and the rvalue Reference.”

The `string(initializer_list<char> il)` constructor enables list-initialization for the `string` class. That is, it makes declarations like the following possible:

```
string piano_man = {'L', 'i', 's', 'z', 't'};
string comp_lang {'L', 'i', 's', 'p'};
```

This may not be that useful for the `string` class because using C-style strings is easier, but it does satisfy the intent to make the list-initialization syntax universal. This chapter will discuss the `initializer_list` template further later on.

## The string Class Input

Another useful thing to know about a class is what input options are available. For C-style strings, recall, you have three options:

```
char info[100];
cin >> info;           // read a word
cin.getline(info, 100); // read a line, discard \n
cin.get(info, 100);   // read a line, leave \n in queue
```

For `string` objects, recall, you have two options:

```
string stuff;
cin >> stuff;           // read a word
getline(cin, stuff);   // read a line, discard \n
```

Both versions of `getline()` allow for an optional argument that specifies which character to use to delimit input:

```
cin.getline(info, 100, ':'); // read up to :, discard :
getline(stuff, ':');        // read up to :, discard :
```

The main operational difference is that the `string` versions automatically size the target `string` object to hold the input characters:

```
char fname[10];
string lname;
cin >> fname; // could be a problem if input size > 9 characters
cin >> lname; // can read a very, very long word
cin.getline(fname, 10); // may truncate input
getline(cin, fname); // no truncation
```

The automatic sizing feature allows the `string` version of `getline()` to dispense with the numeric parameter that limits the number of input characters to be read.

A design difference is that the C-style string input facilities are methods of the `istream` class, whereas the `string` versions are standalone functions. That’s why `cin` is an invoking object for C-style string input and a function argument for `string` object input. This applies to the `>>` form, too, which is evident if the code is written in function form:

```
cin.operator>>(fname);    // ostream class method
operator>>(cin, lname);  // regular function
```

Let's examine the `string` input functions a bit more closely. Both, as mentioned, size the target string to fit the input. There are limits. The first limiting factor is the maximum allowable size for a string, represented by the constant `string::npos`. This, typically, is the maximum value of an `unsigned int`, so it doesn't pose a practical limit for ordinary, interactive input. It could be a factor, however, if you attempt to read the contents of an entire file into a single `string` object. The second limiting factor is the amount of memory available to a program.

The `getline()` function for the `string` class reads characters from the input and stores them in a `string` object until one of three things occurs:

- The end-of-file is encountered, in which case `eofbit` of the input stream is set, implying that both the `fail()` and `eof()` methods will return `true`.
- The delimiting character (`\n`, by default) is reached, in which case it is removed from the input stream but not stored.
- The maximum possible number of characters (the lesser of `string::npos` and the number of bytes in memory available for allocation) is read, in which case `failbit` of the input stream is set, implying that the `fail()` method will return `true`.

(An input stream object has an accounting system to keep track of the error state of the stream. In this system, setting `eofbit` registers detecting the end-of-file; setting `failbit` registers detecting an input error; setting `badbit` registers some unrecognized failure, such as a hardware failure; and setting `goodbit` indicates that all is well. Chapter 17, "Input, Output, and Files," discusses this further.)

The `operator>>()` function for the `string` class behaves similarly, except that instead of reading to and discarding a delimiting character, it reads up to a white space character and leaves that character in the input queue. A white space character is a space, newline, or tab character or more generally, any character for which `isspace()` returns `true`.

So far in this book, you've seen several examples of console `string` input. Because the input functions for `string` objects work with streams and recognize the end-of-file, you can also use them for file input. Listing 16.2 shows a short example that reads strings from the file. It assumes that the file contains strings separated by the colon character and uses the `getline()` method of specifying a delimiter. It then numbers and displays the strings, one string to an output line.

---

#### Listing 16.2 `strfile.cpp`

```
// strfile.cpp -- read strings from a file
#include <iostream>
#include <fstream>
#include <string>
#include <cstdlib>
int main()
```

```
{
    using namespace std;
    ifstream fin;
    fin.open("tobuy.txt");
    if (fin.is_open() == false)
    {
        cerr << "Can't open file. Bye.\n";
        exit(EXIT_FAILURE);
    }
    string item;
    int count = 0;
    getline(fin, item, ':');
    while (fin) // while input is good
    {
        ++count;
        cout << count << ": " << item << endl;
        getline(fin, item, ':');
    }
    cout << "Done\n";
    fin.close();
    return 0;
}
```

---

Here is a sample `tobuy.txt` file:

```
sardines:chocolate ice cream:pop corn:leeks:
cottage cheese:olive oil:butter:tofu:
```

Typically, for the program to find the text file, the text file should be in the same directory as the executable program or sometimes in the same directory as the project file. Or you can provide the full path name. On a Windows system, keep in mind that in a C-style string the escape sequence `\\` represents a single backslash:

```
fin.open("C:\\CPP\\Progs\\tobuy.txt"); // file = C:\\CPP\\Progs\\tobuy.txt
```

Here is the output of the program in Listing 16.2:

```
1: sardines
2: chocolate ice cream
3: pop corn
4: leeks
5:
cottage cheese
6: olive oil
7: butter
8: tofu
9:
```

Done

Note that with `:` specified as the delimiting character, the newline character becomes just another regular character. Thus, the newline character at the end of the first line of the file becomes the first character of the string that continues as "cottage cheese". Similarly, the newline character at the end of the second input line, if present, becomes the sole content of the ninth input string.

## Working with Strings

So far, you've learned that you can create `string` objects in a variety of ways, display the contents of a `string` object, read data into a `string` object, append to a `string` object, assign to a `string` object, and concatenate two `string` objects. What else can you do?

You can compare strings. All six relational operators are overloaded for `string` objects, with one object being considered less than another if it occurs earlier in the machine collating sequence. If the machine collating sequence is the ASCII code, that implies that digits are less than uppercase characters and uppercase characters are less than lowercase characters. Each relational operator is overloaded three ways so that you can compare a `string` object with another `string` object, compare a `string` object with a C-style string, and compare a C-style string with a `string` object:

```
string snake1("cobra");
string snake2("coral");
char snake3[20] = "anaconda";
if (snake1 < snake2)           // operator<(const string &, const string &)
    ...
if (snake1 == snake3)         // operator==(const string &, const char *)
    ...
if (snake3 != snake2)         // operator!=(const char *, const string &)
    ...
```

You can determine the size of a string. Both the `size()` and `length()` member functions return the number of characters in a string:

```
if (snake1.length() == snake2.size())
    cout << "Both strings have the same length.\n"
```

Why two functions that do the same thing? The `length()` member comes from earlier versions of the `string` class, and `size()` was added for STL compatibility.

You can search a string for a given substring or character in a variety of ways. Table 16.2 provides a short description of four variations of a `find()` method. Recall that `string::npos` is the maximum possible number of characters in a string, typically the largest unsigned int or unsigned long value.

Table 16.2 The Overloaded `find()` Method

| Method Prototype                                                             | Description                                                                                                                                                                                                                                                                                  |
|------------------------------------------------------------------------------|----------------------------------------------------------------------------------------------------------------------------------------------------------------------------------------------------------------------------------------------------------------------------------------------|
| <code>size_type find(const string &amp; str, size_type pos = 0) const</code> | Finds the first occurrence of the substring <i>str</i> , starting the search at location <i>pos</i> in the invoking string. Returns the index of the first character of the substring if found and returns <code>string::npos</code> otherwise.                                              |
| <code>size_type find(const char * s, size_type pos = 0) const</code>         | Finds the first occurrence of the substring <i>s</i> , starting the search at location <i>pos</i> in the invoking string. Returns the index of the first character of the substring if found and returns <code>string::npos</code> otherwise.                                                |
| <code>size_type find(const char * s, size_type pos = 0, size_type n)</code>  | Finds the first occurrence of the substring consisting of the first <i>n</i> characters in <i>s</i> , starting the search at location <i>pos</i> in the invoking string. Returns the index of the first character of the substring if found and returns <code>string::npos</code> otherwise. |
| <code>size_type find(char ch, size_type pos = 0) const</code>                | Finds the first occurrence of the character <i>ch</i> , starting the search at location <i>pos</i> in the invoking string. Returns the index of the character if found and returns <code>string::npos</code> otherwise.                                                                      |

The `string` library also provides the related methods `rfind()`, `find_first_of()`, `find_last_of()`, `find_first_not_of()`, and `find_last_not_of()`, each with the same set of overloaded function signatures as the `find()` method. The `rfind()` method finds the last occurrence of a substring or character. The `find_first_of()` method finds the first occurrence in the invoking string of any of the characters in the argument. For example, the following statement would return the location of the `r` in "cobra" (that is, the index 3) because that's the first occurrence of any of the letters in "hark" in "cobra":

```
int where = snake1.find_first_of("hark");
```

The `find_last_of()` method works the same, except it finds the last occurrence. Thus, the following statement would return the location of the `a` in "cobra":

```
int where = snake1.last_first_of("hark");
```

The `find_first_not_of()` method finds the first character in the invoking string that is not a character in the argument. So the following would return the location of the `c` in `cobra` because `c` is not found in `hark`:

```
int where = snake1.find_first_not_of("hark");
```

(You'll learn about `find_last_not_of()` in an exercise at the end of this chapter.)



There are many more methods, but these are enough to put together a sample program that's a graphically impaired version of the word game Hangman. The game stores a list of words in an array of `string` objects, picks a word at random, and lets you guess letters in the word. Six wrong guesses, and you lose. The program uses the `find()` function to check your guesses and the `+=` operator to build a `string` object to keep track of your wrong guesses. To keep track of your good guesses, the program creates a word the same length as the mystery word but consisting of hyphens. The hyphens are then replaced by correct guesses. Listing 16.3 shows the program.

### Listing 16.3 `hangman.cpp`

---

```
// hangman.cpp -- some string methods
#include <iostream>
#include <string>
#include <cstdlib>
#include <ctime>
#include <cctype>
using std::string;
const int NUM = 26;
const string wordlist[NUM] = {"apiary", "beetle", "cereal",
    "danger", "ensign", "florid", "garage", "health", "insult",
    "jackal", "keeper", "loaner", "manage", "nonce", "onset",
    "plaid", "quilt", "remote", "stolid", "train", "useful",
    "valid", "whence", "xenon", "yearn", "zippy"};

int main()
{
    using std::cout;
    using std::cin;
    using std::tolower;
    using std::endl;
    std::srand(std::time(0));
    char play;
    cout << "Will you play a word game? <y/n> ";
    cin >> play;
    play = tolower(play);
    while (play == 'y')
    {
        string target = wordlist[std::rand() % NUM];
        int length = target.length();
        string attempt(length, '-');
        string badchars;
        int guesses = 6;
        cout << "Guess my secret word. It has " << length
            << " letters, and you guess\n"
            << "one letter at a time. You get " << guesses
```

```

    << " wrong guesses.\n";
cout << "Your word: " << attempt << endl;
while (guesses > 0 && attempt != target)
{
    char letter;
    cout << "Guess a letter: ";
    cin >> letter;
    if (badchars.find(letter) != string::npos
        || attempt.find(letter) != string::npos)
    {
        cout << "You already guessed that. Try again.\n";
        continue;
    }
    int loc = target.find(letter);
    if (loc == string::npos)
    {
        cout << "Oh, bad guess!\n";
        --guesses;
        badchars += letter; // add to string
    }
    else
    {
        cout << "Good guess!\n";
        attempt[loc]=letter;
        // check if letter appears again
        loc = target.find(letter, loc + 1);
        while (loc != string::npos)
        {
            attempt[loc]=letter;
            loc = target.find(letter, loc + 1);
        }
    }
    cout << "Your word: " << attempt << endl;
    if (attempt != target)
    {
        if (badchars.length() > 0)
            cout << "Bad choices: " << badchars << endl;
        cout << guesses << " bad guesses left\n";
    }
}
if (guesses > 0)
    cout << "That's right!\n";
else
    cout << "Sorry, the word is " << target << ".\n";

```

```

        cout << "Will you play another? <y/n> ";
        cin >> play;
        play = tolower(play);
    }

    cout << "Bye\n";

    return 0;
}

```

---

Here's a sample run of the program in Listing 16.3:

```

Will you play a word game? <y/n> y
Guess my secret word. It has 6 letters, and you guess
one letter at a time. You get 6 wrong guesses.
Your word: -----
Guess a letter: e
Oh, bad guess!
Your word: -----
Bad choices: e
5 bad guesses left
Guess a letter: a
Good guess!
Your word: a--a--
Bad choices: e
5 bad guesses left
Guess a letter: t
Oh, bad guess!
Your word: a--a--
Bad choices: et
4 bad guesses left
Guess a letter: r
Good guess!
Your word: a--ar-
Bad choices: et
4 bad guesses left
Guess a letter: y
Good guess!
Your word: a--ary
Bad choices: et
4 bad guesses left
Guess a letter: i
Good guess!
Your word: a-iary
Bad choices: et
4 bad guesses left
Guess a letter: p

```

```

Good guess!
Your word: apiary
That's right!
Will you play another? <y/n> n
Bye

```

## Program Notes

In Listing 16.3, the fact that the relational operators are overloaded lets you treat strings in the same fashion you would treat numeric variables:

```
while (guesses > 0 && attempt != target)
```

This is easier to follow than, say, using `strcmp()` with C-style strings.

The program uses `find()` to check whether a character was selected earlier; if it was already selected, it will be found in either the `badchars` string (bad guesses) or in the `attempt` string (good guesses):

```
if (badchars.find(letter) != string::npos
    || attempt.find(letter) != string::npos)
```

The `npos` variable is a static member of the `string` class. Its value, recall, is the maximum allowable number of characters for a `string` object. Therefore, because indexing begins at zero, it is one greater than the largest possible index and can be used to indicate failure to find a character or a string.

The program makes use of the fact that one of the overloaded versions of the `+=` operator lets you append individual characters to a string:

```
badchars += letter; // append a char to a string object
```

The heart of the program begins by checking whether the chosen letter is in the mystery word:

```
int loc = target.find(letter);
```

If `loc` is a valid value, the letter can be placed in the corresponding location in the answer string:

```
attempt[loc]=letter;
```

However, a given letter might occur more than once in the mystery word, so the program has to keep checking. The program uses the optional second argument to `find()`, which specifies a starting place in the string from which to begin the search. Because the letter was found at location `loc`, the next search should begin at `loc + 1`. A `while` loop keeps the search going until no more occurrences of that character are found. Note that `find()` indicates failure if `loc` is after the end of the string:

```
// check if letter appears again
loc = target.find(letter, loc + 1);
while (loc != string::npos)
{
```

```

    attempt[loc]=letter;
    loc = target.find(letter, loc + 1);
}

```

## What Else Does the `string` Class Offer?

The `string` library supplies many other facilities. There are functions for erasing part or all of a string, for replacing part or all of one string with part or all of another string, for inserting material into a string or removing material from a string, for comparing part or all of one string with part or all of another string, and for extracting a substring from a string. There's a function for copying part of one string to another string, and there's a function for swapping the contents of two strings. Most of these functions are overloaded so that they can work with C-style strings as well as with `string` objects. Appendix F describes the `string` library function briefly, but let's talk about a few more features here.

First, think about the automatic sizing feature. In Listing 16.3, what happens each time the program appends a letter to a string? It can't necessarily just grow the string in place because it might run into neighboring memory that is already in use. So it may have to allocate a new block and then copy the old contents to a new location. It would be inefficient to do this a lot, so many C++ implementations allocate a block of memory larger than the actual string, giving the string room to grow. Then if the string eventually exceeds that size, the program allocates a new block twice the size to afford more room to grow without continuous resizing. The `capacity()` method returns the size of the current block, and the `reserve()` method allows you to request a minimum size for the block. Listing 16.4 shows an example that uses these methods.

### Listing 16.4 `str2.cpp`

---

```

// str2.cpp -- capacity() and reserve()
#include <iostream>
#include <string>
int main()
{
    using namespace std;
    string empty;
    string small = "bit";
    string larger = "Elephants are a girl's best friend";
    cout << "Sizes:\n";
    cout << "\tempty: " << empty.size() << endl;
    cout << "\tsmall: " << small.size() << endl;
    cout << "\tlarger: " << larger.size() << endl;
    cout << "Capacities:\n";
    cout << "\tempty: " << empty.capacity() << endl;
    cout << "\tsmall: " << small.capacity() << endl;
    cout << "\tlarger: " << larger.capacity() << endl;
    empty.reserve(50);
}

```

```

cout << "Capacity after empty.reserve(50): "
    << empty.capacity() << endl;
return 0;
}

```

---

Here is the output of the program in Listing 16.4 for one C++ implementation:

```

Sizes:
    empty: 0
    small: 3
    larger: 34
Capacities:
    empty: 15
    small: 15
    larger: 47
Capacity after empty.reserve(50): 63

```

Note that this implementation uses a minimum capacity of 15 characters and seems to use 1 less than multiples of 16 as standard choices for capacities. Other implementations may make different choices.

What if you have a `string` object but need a C-style string? For example, you might want to open a file whose name is in a `string` object:

```

string filename;
cout << "Enter file name: ";
cin >> filename;
ofstream fout;

```

The bad news is that the `open()` method requires a C-style string argument. The good news is that the `c_str()` method returns a pointer to a C-style string that has the same contents as the invoking `string` object. So you can use this:

```

fout.open(filename.c_str());

```

## String Varieties

This section treats the `string` class as if it were based on the `char` type. In fact, as mentioned earlier, the `string` library really is based on a template class:

```

template<class charT, class traits = char_traits<charT>,
        class Allocator = allocator<charT> >
basic_string {...};

```

The `basic_string` template comes with four specializations, each of which has a typedef name:

```

typedef basic_string<char> string;
typedef basic_string<wchar_t> wstring;
typedef basic_string<char16_t> u16string; // C++11
typedef basic_string<char32_t> u32string ; // C++11

```

This allows you to use strings based on the `wchar_t`, `char16_t`, and `char32_t` types as well as the `char` type. You could even develop some sort of character-like class and use the `basic_string` class template with it, provided that your class met certain requirements. The `traits` class describes specific facts about the chosen character type, such as how to compare values. There are predefined specializations of the `char_traits` template for the `char`, `wchar_t`, `char16_t`, and `char32_t` types, and these are the default values for `traits`. The `Allocator` class represents a class to manage memory allocation. There are predefined specializations of the `allocator` template for the various character types, and these are the defaults. They use `new` and `delete`.

## Smart Pointer Template Classes

A *smart pointer* is a class object that acts like a pointer but has additional features. Here we'll look at three smart pointer templates that can help with managing the use of dynamic memory allocation. Let's begin by taking a look at what might be needed and how it can be accomplished. Consider the following function:

```
void remodel(std::string & str)
{
    std::string * ps = new std::string(str);
    ...
    str = *ps;
    return;
}
```

You probably see its flaw. Each time the function is called, it allocates memory from the heap but never frees the memory, thus creating a memory leak. You also know the solution—just remember to free the allocated memory by adding the following statement just before the `return` statement:

```
delete ps;
```

However, a solution involving the phrase “just remember to” is seldom the best solution. Sometimes you won't remember. Or you will remember but accidentally remove or comment out the code. And even if you do remember, there can still be problems. Consider the following variation:

```
void remodel(std::string & str)
{
    std::string * ps = new std::string(str);
    ...
    if (weird_thing())
        throw exception();
    str = *ps;
    delete ps;
    return;
}
```





```

void demo1()
{
    double * pd = new double; // #1
    *pd = 25.5;                // #2
    return;                    // #3
}

```

#1: Creates storage for pd and a double value, saves address:

```

pd   [10000]   [ ]
      4000     10000

```

#2: Copies value into dynamic memory:

```

pd   [10000]   [25.5]
      4000     10000

```

#3: Discards pd, leaves value in dynamic memory:

```

      [25.5]
      10000

```

```

void demo2()
{
    auto_ptr<double> ap(new double); // #1
    *ap = 25.5;                      // #2
    return;                            // #3
}

```

#1: Creates storage for ap and a double value, saves address:

```

ap   [10080]   [ ]
      6000     10080

```

#2: Copies value into dynamic memory:

```

ap   [10080]   [25.5]
      6000     10000

```

#3: Discards ap, and ap's destructor frees dynamic memory.

Figure 16.2 A regular pointer versus `auto_ptr`.

Here `new double` is a pointer returned by `new` to a newly allocated chunk of memory. It is the argument to the `auto_ptr<double>` constructor; that is, it is the actual argument corresponding to the formal parameter `p` in the prototype. Similarly, `new string` is also an actual argument for a constructor. The other two smart pointers use the same syntax:

```

unique_ptr<double> pdu(new double); // pdu an unique_ptr to double
shared_ptr<string> pss(new string); // pss a shared_ptr to string

```

Thus, to convert the `remodel()` function, you would follow these three steps:

1. Include the memory header file.
2. Replace the pointer-to-string with a smart pointer object that points to string.
3. Remove the `delete` statement.

Here's the function with those changes made using `auto_ptr`:

```
#include <memory>
void remodel(std::string & str)
{
    std::auto_ptr<std::string> ps (new std::string(str));
    ...
    if (weird_thing())
        throw exception();
    str = *ps;
    // delete ps; NO LONGER NEEDED
    return;
}
```

Note that smart pointers belong to the `std` namespace. Listing 16.5 presents a simple program using all three of these smart pointers. (Your compiler will need to support the C++11 `shared_ptr` and `unique_ptr` classes.) Each use is placed inside a block so that the pointer expires when execution leaves the block. The `Report` class uses verbose methods to report when an object is created or destroyed.

#### Listing 16.5 `smrtptrs.cpp`

---

```
// smrtptrs.cpp -- using three kinds of smart pointers
// requires support of C++11 shared_ptr and unique_ptr
#include <iostream>
#include <string>
#include <memory>

class Report
{
private:
    std::string str;
public:
    Report(const std::string s) : str(s)
        { std::cout << "Object created!\n"; }
    ~Report() { std::cout << "Object deleted!\n"; }
    void comment() const { std::cout << str << "\n"; }
};

int main()
{
```

```

    {
        std::auto_ptr<Report> ps (new Report("using auto_ptr"));
        ps->comment(); // use -> to invoke a member function
    }
    {
        std::shared_ptr<Report> ps (new Report("using shared_ptr"));
        ps->comment();
    }
    {
        std::unique_ptr<Report> ps (new Report("using unique_ptr"));
        ps->comment();
    }
    return 0;
}

```

---

Here is the output:

```

Object created!
using auto_ptr
Object deleted!
Object created!
using shared_ptr
Object deleted!
Object created!
using unique_ptr
Object deleted!

```

Each of these classes has an explicit constructor taking a pointer as an argument. Thus, there is no automatic type cast from a pointer to a smart pointer object:

```

shared_ptr<double> pd;
double *p_reg = new double;
pd = p_reg; // not allowed (implicit conversion)
pd = shared_ptr<double>(p_reg); // allowed (explicit conversion)
shared_ptr<double> pshared = p_reg; // not allowed (implicit conversion)
shared_ptr<double> pshared(p_reg); // allowed (explicit conversion)

```

The smart pointer template classes are defined so that in most respects a smart pointer object acts like a regular pointer. For example, given that `ps` is a smart pointer object, you can dereference it (`*ps`), use it to access structure members (`ps->puffIndex`), and assign it to a regular pointer that points to the same type. You can also assign one smart pointer object to another of the same type, but that raises an issue that the next section faces.

But first, here's something you should avoid with all three of these smart pointers:

```

string vacation("I wandered lonely as a cloud.");
shared_ptr<string> pvac(&vacation); // NO!

```

When `pvac` expires, the program would apply the `delete` operator to non-heap memory, which is wrong.

If Listing 16.5 represents the pinnacle of your programming aspirations, any of these three smart pointers will serve your purposes. But there is more to the story.

## Smart Pointer Considerations

Why three smart pointers? (Actually, there are four, but we won't discuss `weak_ptr`.) And why is `auto_ptr` being deprecated?

Begin by considering assignment:

```
auto_ptr<string> ps (new string("I reigned lonely as a cloud."));
auto_ptr<string> vocation;
vocation = ps;
```

What should the assignment statement accomplish? If `ps` and `vocation` were ordinary pointers, the result would be two pointers pointing to the same `string` object. That is not acceptable here because the program would wind up attempting to delete the same object twice—once when `ps` expires, and once when `vocation` expires. There are ways to avoid this problem:

- Define the assignment operator so that it makes a deep copy. This results in two pointers pointing to two distinct objects, one of which is a copy of the other.
- Institute the concept of *ownership*, with only one smart pointer allowed to own a particular object. Only if the smart pointer owns the object will its destructor delete the object. Then have assignment transfer ownership. This is the strategy used for `auto_ptr` and for `unique_ptr`, although `unique_ptr` is somewhat more restrictive.
- Create an even smarter pointer that keeps track of how many smart pointers refer to a particular object. This is called *reference counting*. Assignment, for example, would increase the count by one, and the expiration of a pointer would decrease the count by one. Only when the final pointer expires would `delete` be invoked. This is the `shared_ptr` strategy.

The same strategies we've discussed for assignment, of course, would also apply to the copy constructors.

Each approach has its uses. Listing 16.6 shows an example for which `auto_ptr` is poorly suited.

### Listing 16.6 `fowl.cpp`

---

```
// fowl.cpp -- auto_ptr a poor choice
#include <iostream>
#include <string>
#include <memory>

int main()
{
    using namespace std;
    auto_ptr<string> films[5] =
```

```

    {
        auto_ptr<string> (new string("Fowl Balls")),
        auto_ptr<string> (new string("Duck Walks")),
        auto_ptr<string> (new string("Chicken Runs")),
        auto_ptr<string> (new string("Turkey Errors")),
        auto_ptr<string> (new string("Goose Eggs"))
    };
    auto_ptr<string> pwin;
    pwin = films[2]; // films[2] loses ownership

    cout << "The nominees for best avian baseball film are\n";
    for (int i = 0; i < 5; i++)
        cout << *films[i] << endl;
    cout << "The winner is " << *pwin << "!\n";
    cin.get();
    return 0;
}

```

---

Here is some sample output:

```

The nominees for best avian baseball film are
Fowl Balls
Duck Walks
Segmentation fault (core dumped)

```

The “core dumped” message should help fix in your memory that a misused `auto_ptr` can be a problem. (The behavior for this sort of code is undefined, so you might encounter different behavior, depending on your system.) Here the problem is that the following statement transfers ownership from `films[2]` to `pwin`:

```
pwin = films[2]; // films[2] loses ownership
```

That causes `films[2]` to no longer refer to the string. After an `auto_ptr` gives up ownership of an object, it no longer provides access to the object. When the program goes to print the string pointed to by `films[2]`, it finds the null pointer, which apparently is an unpleasant surprise.

Suppose you go back to Listing 16.6 but use `shared_ptr` instead of `auto_ptr`. (You’ll need a compiler that supports the C++11 `shared_ptr` class.) Then the program runs fine and gives this output:

```

The nominees for best avian baseball film are
Fowl Balls
Duck Walks
Chicken Runs
Turkey Errors
Goose Eggs
The winner is Chicken Runs!

```

The difference occurs in this part of the program:

```
shared_ptr<string> pwin;
pwin = films[2];
```

This time both `pwin` and `films[2]` point to the same object, and the reference count is upped from 1 to 2. At the end of the program, `pwin`, which was declared last, is the first object to have its destructor called. The destructor decreases the reference count to 1. Then the members of the array of `shared_ptr`s are freed. The destructor for `films[2]` decrements the count to 0 and frees the previously allocated space.

So with `shared_ptr`, Listing 16.6 runs fine. With `auto_ptr` it experienced a runtime crash. What happens if you use `unique_ptr`? Like `auto_ptr`, `unique_ptr` incorporates the ownership model. Yet instead of crashing, the `unique_ptr` version yields a compile-time error objecting to this line:

```
pwin = films[2];
```

Clearly, it is time to look further into the differences between these last two types.

## Why `unique_ptr` Is Better than `auto_ptr`

Consider the following statements:

```
auto_ptr<string> p1(new string("auto")); // #1
auto_ptr<string> p2; // #2
p2 = p1; // #3
```

When, in statement #3, `p2` takes over ownership of the `string` object, `p1` is stripped of ownership. This, recall, is good because it prevents the destructors for both `p1` and `p2` from trying to delete the same object. But it also is bad if the program subsequently tries to use `p1` because `p1` no longer points to valid data.

Now consider the `unique_ptr` equivalent:

```
unique_ptr<string> p3(new string("auto")); // #4
unique_ptr<string> p4; // #5
p4 = p3; // #6
```

In this case, the compiler does not allow statement #6, so we avoid the problem of `p3` not pointing to valid data. Hence, `unique_ptr` is safer (compile-time error versus potential program crash) than `auto_ptr`.

But there are times when assigning one smart pointer to another doesn't leave a dangerous orphan behind. Suppose we have this function definition:

```
unique_ptr<string> demo(const char * s)
{
    unique_ptr<string> temp(new string(s));
    return temp;
}
```

And suppose we then have this code:

```
unique_ptr<string> ps;
ps = demo("Uniquely special");
```

Here, `demo()` returns a temporary `unique_ptr`, and then `ps` takes over ownership of the object originally owned by the returned `unique_ptr`. Then the returned `unique_ptr` is destroyed. That's okay because `ps` now has ownership of the `string` object. But another good thing has happened. Because the temporary `unique_ptr` returned by `demo()` is soon destroyed, there's no possibility of it being misused in an attempt to access invalid data. In other words, there is no reason to forbid assignment in this case. And, miraculously enough, the compiler does allow it!

In short, if a program attempts to assign one `unique_ptr` to another, the compiler allows it if the source object is a temporary rvalue and disallows it if the source object has some duration:

```
using namespace std;
unique_ptr< string> pu1(new string "Hi ho!");
unique_ptr< string> pu2;
pu2 = pu1;                               // #1 not allowed
unique_ptr<string> pu3;
pu3 = unique_ptr<string>(new string "Yo!"); // #2 allowed
```

Assignment #1 would leave a dangling `unique_ptr` behind (that is, `pu1`), a possible source of mischief. Assignment #2 leaves no `unique_ptr` behind because it invokes the `unique_ptr` constructor, which constructs a temporary object that is destroyed when ownership is transferred to `pu3`. This selective behavior is one indication that `unique_ptr` is superior to `auto_ptr`, which would allow both forms of assignment. It's also the reason that `auto_ptr`s are banned (by recommendation, not by the compiler) from being used in container objects, whereas `unique_ptr`s are allowed. If a container algorithm tries to do something along the lines of assignment #1 to the contents of a container of `unique_ptr`s, you get a compile-time error. If the algorithm tries to do something like assignment #2, that's okay, and the program proceeds. With `auto_ptr`s, cases like assignment #1 could lead to undefined behavior and mysterious crashes.

Of course, it could be possible that you really want to do something like statement #1. The assignment is unsafe only if you use the abandoned smart pointer in an unsmart manner, such as dereferencing it. But you could safely reuse the pointer by assigning a new value to it. C++ has a standard library function called `std::move()` that lets you assign one `unique_ptr` to another. Here is an example using the previously defined `demo()` function, which returns a `unique_ptr<string>` object:

```
using namespace std;
unique_ptr<string> ps1, ps2;
ps1 = demo("Uniquely special");
ps2 = move(ps1);           // enable assignment
ps1 = demo(" and more");
cout << *ps2 << *ps1 << endl;
```

You may be wondering how `unique_ptr`, unlike `auto_ptr`, is able to discriminate between safe and possibly unsafe uses. The answer is that it uses the C++11 additions of move constructors and rvalue references, as discussed in Chapter 18.

Also `unique_ptr` has another advantage over `auto_ptr`. It has a variant that can be used with arrays. Remember, you must pair `delete` with `new` and `delete []` with `new []`. The `auto_ptr` template uses `delete`, not `delete []`, so it can only be used with `new`, not with `new []`. But `unique_ptr` has a `new[], delete[]` version:

```
std::unique_ptr< double[]>pda(new double(5)); // will use delete []
```

### Caution

You should use an `auto_ptr` or `shared_ptr` object only for memory allocated by `new`, not for memory allocated by `new []`. You should not use `auto_ptr`, `shared_ptr`, or `unique_ptr` for memory not allocated via `new` or, in the case of `unique_ptr`, via `new` or `new []`.

## Selecting a Smart Pointer

Which pointer type should you use? If the program uses more than one pointer to an object, `shared_ptr` is your choice. For instance, you may have an array of pointers and use some auxiliary pointers to identify particular elements, such as the largest and the smallest. Or you could have two kinds of objects that contain pointers to the same third object. Or you might have an STL container of pointers. Many of the STL algorithms include copy or assignment operations that will work with `shared_ptr` but not with `unique_ptr` (you'll get a compiler warning) or `auto_ptr` (you'll get undefined behavior). If your compiler doesn't offer `shared_ptr`, you can get a version from the Boost library.

If the program doesn't need multiple pointers to the same object, `unique_ptr` works. It's a good choice for the return type for a function that returns a pointer to memory allocated by `new`. That way, ownership is transferred to the `unique_ptr` assigned the return value, and that smart pointer takes on the responsibility of calling `delete`. You can store `unique_ptr` objects in an STL container providing you don't invoke methods or algorithms, such as `sort()`, that copy or assign one `unique_ptr` to another. For example, assuming the proper includes and using statements, code fragments like the following could be used in a program:

```
unique_ptr<int> make_int(int n)
{
    return unique_ptr<int>(new int(n));
}
void show(unique_ptr<int> & pi) // pass by reference
{
    cout << *a << ' ';
}
int main()
{
    ...
```



```

vector<unique_ptr<int> > vp(size);
for (int i = 0; i < vp.size(); i++)
    vp[i] = make_int(rand() % 1000); // copy temporary unique_ptr
vp.push_back(make_int(rand() % 1000)) // ok because arg is temporary
for_each(vp.begin(), vp.end(), show); // use for_each()
...
}

```

The call to `push_back()` works because it passes a temporary `unique_ptr` to be assigned to a `unique_ptr` in `vp`. Also note the `for_each()` statement would fail if `show()` were passed an object by value instead of by reference because then it would be necessary to initialize `pi` to a nontemporary `unique_ptr` from `vp`, which isn't allowed. As mentioned before, the compiler will catch attempts to use `unique_ptr` inappropriately.

You can assign a `unique_ptr` to `shared_ptr` under the same conditions that you can assign one `unique_ptr` to another—the source has to be an rvalue. As previously, in the following code `make_int()` is a function with a `unique_ptr<int>` return type:

```

unique_ptr<int> pup(make_int(rand() % 1000)); // ok
shared_ptr<int> spp(pup); // not allowed, pup an lvalue
shared_ptr<int> spr(make_int(rand() % 1000)); // ok

```

The `shared_ptr` template includes an explicit constructor for converting an rvalue `unique_ptr` to a `shared_ptr`. The `shared_ptr` takes over ownership of the object previously owned by the `unique_ptr`.

You would use `auto_ptr` in the same situation as `unique_ptr`, but the latter is preferred. If your compiler doesn't provide `unique_ptr`, you might consider the BOOST library `scoped_ptr`, which is similar.

## The Standard Template Library

The STL provides a collection of templates representing containers, iterators, function objects, and algorithms. A container is a unit, like an array, that can hold several values. STL containers are homogeneous; that is, they hold values all of the same kind. Algorithms are recipes for accomplishing particular tasks, such as sorting an array or finding a particular value in a list. Iterators are objects that let you move through a container much as pointers let you move through an array; they are generalizations of pointers. Function objects are objects that act like functions; they can be class objects or function pointers (including function names because a function name acts as a pointer). The STL lets you construct a variety of containers, including arrays, queues, and lists, and it lets you perform a variety of operations, including searching, sorting, and randomizing.

Alex Stepanov and Meng Lee developed STL at Hewlett-Packard Laboratories, releasing the implementation in 1994. The ISO/ANSI C++ committee voted to incorporate it as a part of the C++ Standard. The STL is not an example of object-oriented programming. Instead, it represents a different programming paradigm called *generic programming*. This makes STL interesting both in terms of what it does and in terms of its approach.

There's too much information about the STL to present in a single chapter, so we'll look at some representative examples and examine the spirit of the generic programming approach. We'll begin by looking at a few specific examples. Then, when you have a hands-on appreciation for containers, iterators, and algorithms, we'll look at the underlying design philosophy and then take an overview of the whole STL. Appendix G, "The STL Methods and Functions," summarizes the various STL methods and functions.

## The vector Template Class

Chapter 4 touched briefly on the `vector` class. We'll look more closely at it now. In computing, the term *vector* corresponds to an array rather than to the mathematical vector discussed in Chapter 11, "Working with Classes." (Mathematically, an N-dimensional mathematical vector can be represented by a set of N components, so in that aspect, a mathematical vector is like an N-dimensional array. However, a mathematical vector has additional properties, such as inner and outer products, that a computer vector doesn't necessarily have.) A computing-style vector holds a set of like values that can be accessed randomly. That is, you can use, say, an index to directly access the 10th element of a vector without having to access the preceding 9 elements first. So a `vector` class would provide operations similar to those of the `valarray` and `ArrayTP` classes introduced in Chapter 14 and to those of the `array` class introduced in Chapter 4. That is, you could create a `vector` object, assign one `vector` object to another, and use the `[]` operator to access `vector` elements. To make the class generic, you make it a template class. That's what the STL does, defining a `vector` template in the `vector` (formerly `vector.h`) header file.

To create a `vector` template object, you use the usual `<type>` notation to indicate the type to be used. Also the `vector` template uses dynamic memory allocation, and you can use an initialization argument to indicate how many `vector` elements you want:

```
#include vector
using namespace std;
vector<int> ratings(5);      // a vector of 5 ints
int n;
cin >> n;
vector<double> scores(n);  // a vector of n doubles
```

After you create a `vector` object, operator overloading for `[]` makes it possible to use the usual array notation for accessing individual elements:

```
ratings[0] = 9;
for (int i = 0; i < n; i++)
    cout << scores[i] << endl;
```

### Allocators Again

Like the `string` class, the various STL container templates take an optional template argument that specifies what allocator object to use to manage memory. For example, the `vector` template begins like this:

```
template <class T, class Allocator = allocator<T> >
    class vector {...
```

If you omit a value for this template argument, the container template uses the `allocator<T>` class by default. This class uses `new` and `delete`.

Listing 16.7 uses this class in an undemanding application. This particular program creates two vector objects, one an `int` specialization and one a `string` specialization; each has five elements.

#### Listing 16.7 vect1.cpp

---

```
// vect1.cpp -- introducing the vector template
#include <iostream>
#include <string>
#include <vector>

const int NUM = 5;
int main()
{
    using std::vector;
    using std::string;
    using std::cin;
    using std::cout;
    using std::endl;

    vector<int> ratings(NUM);
    vector<string> titles(NUM);
    cout << "You will do exactly as told. You will enter\n"
         << NUM << " book titles and your ratings (0-10).\n";
    int i;
    for (i = 0; i < NUM; i++)
    {
        cout << "Enter title #" << i + 1 << ": ";
        getline(cin,titles[i]);
        cout << "Enter your rating (0-10): ";
        cin >> ratings[i];
        cin.get();
    }
    cout << "Thank you. You entered the following:\n"
         << "Rating\tBook\n";
    for (i = 0; i < NUM; i++)
    {
        cout << ratings[i] << "\t" << titles[i] << endl;
    }

    return 0;
}
```

---

Here's a sample run of the program in Listing 16.7:

```
You will do exactly as told. You will enter
5 book titles and your ratings (0-10).
Enter title #1: The Cat Who Knew C++
Enter your rating (0-10): 6
Enter title #2: Felonious Felines
Enter your rating (0-10): 4
Enter title #3: Warlords of Wonk
Enter your rating (0-10): 3
Enter title #4: Don't Touch That Metaphor
Enter your rating (0-10): 5
Enter title #5: Panic Oriented Programming
Enter your rating (0-10): 8
Thank you. You entered the following:
Rating Book
6      The Cat Who Knew C++
4      Felonious Felines
3      Warlords of Wonk
5      Don't Touch That Metaphor
8      Panic Oriented Programming
```

All this program does is use the `vector` template as a convenient way to create a dynamically allocated array. The next section shows an example that uses more of the class methods.

## Things to Do to Vectors

Besides allocating storage, what else can the `vector` template do for you? All the STL containers provide certain basic methods, including `size()`, which returns the number of elements in a container, `swap()`, which exchanges the contents of two containers, `begin()`, which returns an iterator that refers to the first element in a container, and `end()`, which returns an iterator that represents past-the-end for the container.

What's an iterator? It's a generalization of a pointer. In fact, it can be a pointer. Or it can be an object for which pointer-like operations such as dereferencing (for example, `operator*()`) and incrementing (for example, `operator++()`) have been defined. As you'll see later, generalizing pointers to iterators allows the STL to provide a uniform interface for a variety of container classes, including ones for which simple pointers wouldn't work. Each container class defines a suitable iterator. The type name for this iterator is a class scope typedef called `iterator`. For example, to declare an iterator for a type `double` specialization of `vector`, you would use this:

```
vector<double>::iterator pd; // pd an iterator
```

Suppose `scores` is a `vector<double>` object:

```
vector<double> scores;
```

Then you can use the iterator `pd` in code like the following:

```
pd = scores.begin(); // have pd point to the first element
*pd = 22.3;          // dereference pd and assign value to first element
++pd;               // make pd point to the next element
```

As you can see, an iterator behaves like a pointer. By the way, here's another place the C++11 automatic type deduction can be useful. Instead of, say,

```
vector<double>::iterator pd = scores.begin();
```

you can use this:

```
auto pd = scores.begin(); // C++11 automatic type deduction
```

Returning to the example, what's *past-the-end*? It is an iterator that refers to an element one past the last element in a container. The idea is similar to the idea of the null character being one element past the last actual character in a C-style string, except that the null character is the value in the element, and past-the-end is a pointer (or iterator) to the element. The `end()` member function identifies the past-the-end location. If you set an iterator to the first element in a container and keep incrementing it, eventually it will reach past-the-end, and you will have traversed the entire contents of the container. Thus, if `scores` and `pd` are defined as in the preceding example, you can display the contents with this code:

```
for (pd = scores.begin(); pd != scores.end(); pd++)
    cout << *pd << endl;
```

All containers have the methods just discussed. The `vector` template class also has some methods that only some STL containers have. One handy method, called `push_back()`, adds an element to the end of a `vector`. While doing so, it attends to memory management so that the `vector` size increases to accommodate added members. This means you can write code like the following:

```
vector<double> scores; // create an empty vector
double temp;
while (cin >> temp && temp >= 0)
    scores.push_back(temp);
cout << "You entered " << scores.size() << " scores.\n";
```

Each loop cycle adds one more element to the `scores` object. You don't have to pick the number of element when you write the program or when you run the program. As long as the program has access to sufficient memory, it will expand the size of `scores` as necessary.

The `erase()` method removes a given range of a `vector`. It takes two iterator arguments that define the range to be removed. It's important that you understand how the STL defines ranges using two iterators. The first iterator refers to the beginning of the range, and the second iterator is one beyond the end of the range. For example, the



Listing 16.8 illustrates the use of `size()`, `begin()`, `end()`, `push_back()`, `erase()`, and `insert()`. To simplify data handling, the `rating` and `title` components of Listing 16.7 are incorporated into a single `Review` structure, and `FillReview()` and `ShowReview()` functions provide input and output facilities for `Review` objects.

#### Listing 16.8 vect2.cpp

---

```
// vect2.cpp -- methods and iterators
#include <iostream>
#include <string>
#include <vector>

struct Review {
    std::string title;
    int rating;
};
bool FillReview(Review & rr);
void ShowReview(const Review & rr);

int main()
{
    using std::cout;
    using std::vector;
    vector<Review> books;
    Review temp;
    while (FillReview(temp))
        books.push_back(temp);
    int num = books.size();
    if (num > 0)
    {
        cout << "Thank you. You entered the following:\n"
              << "Rating\tBook\n";
        for (int i = 0; i < num; i++)
            ShowReview(books[i]);
        cout << "Reprising:\n"
              << "Rating\tBook\n";
        vector<Review>::iterator pr;
        for (pr = books.begin(); pr != books.end(); pr++)
            ShowReview(*pr);
        vector <Review> oldlist(books);    // copy constructor used
        if (num > 3)
        {
            // remove 2 items
            books.erase(books.begin() + 1, books.begin() + 3);
            cout << "After erasure:\n";
            for (pr = books.begin(); pr != books.end(); pr++)
                ShowReview(*pr);
        }
    }
}
```

```
        // insert 1 item
        books.insert(books.begin(), oldlist.begin() + 1,
                    oldlist.begin() + 2);
        cout << "After insertion:\n";
        for (pr = books.begin(); pr != books.end(); pr++)
            ShowReview(*pr);
    }
    books.swap(oldlist);
    cout << "Swapping oldlist with books:\n";
    for (pr = books.begin(); pr != books.end(); pr++)
        ShowReview(*pr);
}
else
    cout << "Nothing entered, nothing gained.\n";
return 0;
}

bool FillReview(Review & rr)
{
    std::cout << "Enter book title (quit to quit): ";
    std::getline(std::cin,rr.title);
    if (rr.title == "quit")
        return false;
    std::cout << "Enter book rating: ";
    std::cin >> rr.rating;
    if (!std::cin)
        return false;
    // get rid of rest of input line
    while (std::cin.get() != '\n')
        continue;
    return true;
}

void ShowReview(const Review & rr)
{
    std::cout << rr.rating << "\t" << rr.title << std::endl;
}
}
```

---

Here is a sample run of the program in Listing 16.8:

```
Enter book title (quit to quit): The Cat Who Knew Vectors
Enter book rating: 5
Enter book title (quit to quit): Candid Canines
Enter book rating: 7
Enter book title (quit to quit): Warriors of Wonk
Enter book rating: 4
Enter book title (quit to quit): Quantum Manners
```



```

Enter book rating: 8
Enter book title (quit to quit): quit
Thank you. You entered the following:
Rating Book
5      The Cat Who Knew Vectors
7      Candid Canines
4      Warriors of Wonk
8      Quantum Manners
Reprising:
Rating Book
5      The Cat Who Knew Vectors
7      Candid Canines
4      Warriors of Wonk
8      Quantum Manners
After erasure:
5      The Cat Who Knew Vectors
8      Quantum Manners
After insertion:
7      Candid Canines
5      The Cat Who Knew Vectors
8      Quantum Manners
Swapping oldlist with books:
5      The Cat Who Knew Vectors
7      Candid Canines
4      Warriors of Wonk
8      Quantum Manners

```

## More Things to Do to Vectors

There are many things programmers commonly do with arrays, such as search them, sort them, randomize the order, and so on. Does the vector template class have methods for these common operations? No! The STL takes a broader view, defining *nonmember* functions for these operations. Thus, instead of defining a separate `find()` member function for each container class, it defines a single `find()` nonmember function that can be used for all container classes. This design philosophy saves a lot of duplicate work. For example, suppose you had 8 container classes and 10 operations to support. If each class had its own member function, you'd need  $8 \times 10$ , or 80, separate member function definitions. But with the STL approach, you'd need just 10 separate nonmember function definitions. And if you defined a new container class, provided that you followed the proper guidelines, it too could use the existing 10 nonmember functions to find, sort, and so on.

On the other hand, the STL sometimes defines a member function even if it also defines a nonmember function for the same task. The reason is that for some actions, there is a class-specific algorithm that is more efficient than the more general algorithm. Therefore, the vector `swap()` will be more efficient than the nonmember `swap()`. On the other

hand, the nonmember version will allow you swap contents between two different kinds of containers.

Let's examine three representative STL functions: `for_each()`, `random_shuffle()`, and `sort()`. The `for_each()` function can be used with any container class. It takes three arguments. The first two are iterators that define a range in the container, and the last is a pointer to a function. (More generally, the last argument is a function object; you'll learn about function objects shortly.) The `for_each()` function then applies the pointed-to function to each container element in the range. The pointed-to function must not alter the value of the container elements. You can use the `for_each()` function instead of a `for` loop. For example, you can replace the code

```
vector<Review>::iterator pr;
for (pr = books.begin(); pr != books.end(); pr++)
    ShowReview(*pr);
```

with the following:

```
for_each(books.begin(), books.end(), ShowReview);
```

This enables you to avoid dirtying your hands (and code) with explicit use of iterator variables.

The `random_shuffle()` function takes two iterators that specify a range and rearranges the elements in that range in random order. For example, the following statement randomly rearranges the order of all the elements in the `books` vector:

```
random_shuffle(books.begin(), books.end());
```

Unlike `for_each`, which works with any container class, this function requires that the container class allow random access, which the `vector` class does.

The `sort()` function, too, requires that the container support random access. It comes in two versions. The first version takes two iterators that define a range, and it sorts that range by using the `<` operator defined for the type element stored in the container. For example, the following sorts the contents of `coolstuff` in ascending order, using the built-in `<` operator to compare values:

```
vector<int> coolstuff;
...
sort(coolstuff.begin(), coolstuff.end());
```

If the container elements are user-defined objects, then there has to be an `operator<()` function defined that works with that type of object in order to use `sort()`. For example, you could sort a vector containing `Review` objects if you provided either a `Review` member function or a nonmember function for `operator<()`. Because `Review` is a structure, its members are public, and a nonmember function like this would serve:

```
bool operator<(const Review & r1, const Review & r2)
{
    if (r1.title < r2.title)
        return true;
```

```

    else if (r1.title == r2.title && r1.rating < r2.rating)
        return true;
    else
        return false;
}

```

With a function like this in place, you could then sort a vector of `Review` objects (such as `books`):

```
sort(books.begin(), books.end());
```

This version of the `operator<()` function sorts in lexicographic order of the title members. If two objects have the same title members, they are then sorted in ratings order. But suppose you want to sort in decreasing order or in order of ratings instead of titles. In such a case, you can use the second form of `sort()`. It takes three arguments. The first two, again, are iterators that indicate the range. The final argument is a pointer to a function (more generally, a function object) to be used instead of `operator<()` for making the comparison. The return value should be convertible to `bool`, with `false` meaning the two arguments are in the wrong order. Here's an example of such a function:

```
bool WorseThan(const Review & r1, const Review & r2)
{
    if (r1.rating < r2.rating)
        return true;
    else
        return false;
}

```

With this function in place, you can use the following statement to sort the `books` vector of `Review` objects in order of increasing rating values:

```
sort(books.begin(), books.end(), WorseThan);
```

Note that the `WorseThan()` function does a less complete job than `operator<()` of ordering `Review` objects. If two objects have the same title member, the `operator<()` function sorts by using the rating member. But if two objects have the same rating member, `WorseThan()` treats them as equivalent. The first kind of ordering is called *total ordering*, and the second kind is called *strict weak ordering*. With total ordering, if both  $a < b$  and  $b < a$  are false, then  $a$  and  $b$  must be identical. With strict weak ordering, that's not so. They might be identical, or they might just have one aspect that is the same, such as the rating member in the `WorseThan()` example. So instead of saying the two objects are identical, the best you can say for strict weak ordering is that they are *equivalent*.

Listing 16.9 illustrates the use of these STL functions.

#### Listing 16.9 `vect3.cpp`

---

```

// vect3.cpp -- using STL functions
#include <iostream>
#include <string>

```

```
#include <vector>
#include <algorithm>

struct Review {
    std::string title;
    int rating;
};

bool operator<(const Review & r1, const Review & r2);
bool worseThan(const Review & r1, const Review & r2);
bool FillReview(Review & rr);
void ShowReview(const Review & rr);
int main()
{
    using namespace std;

    vector<Review> books;
    Review temp;
    while (FillReview(temp))
        books.push_back(temp);
    if (books.size() > 0)
    {
        cout << "Thank you. You entered the following "
              << books.size() << " ratings:\n"
              << "Rating\tBook\n";
        for_each(books.begin(), books.end(), ShowReview);

        sort(books.begin(), books.end());
        cout << "Sorted by title:\nRating\tBook\n";
        for_each(books.begin(), books.end(), ShowReview);

        sort(books.begin(), books.end(), worseThan);
        cout << "Sorted by rating:\nRating\tBook\n";
        for_each(books.begin(), books.end(), ShowReview);

        random_shuffle(books.begin(), books.end());
        cout << "After shuffling:\nRating\tBook\n";
        for_each(books.begin(), books.end(), ShowReview);
    }
    else
        cout << "No entries. ";
    cout << "Bye.\n";
    return 0;
}

bool operator<(const Review & r1, const Review & r2)
{
```

```

    if (r1.title < r2.title)
        return true;
    else if (r1.title == r2.title && r1.rating < r2.rating)
        return true;
    else
        return false;
}

bool worseThan(const Review & r1, const Review & r2)
{
    if (r1.rating < r2.rating)
        return true;
    else
        return false;
}

bool FillReview(Review & rr)
{
    std::cout << "Enter book title (quit to quit): ";
    std::getline(std::cin, rr.title);
    if (rr.title == "quit")
        return false;
    std::cout << "Enter book rating: ";
    std::cin >> rr.rating;
    if (!std::cin)
        return false;
    // get rid of rest of input line
    while (std::cin.get() != '\n')
        continue;
    return true;
}

void ShowReview(const Review & rr)
{
    std::cout << rr.rating << "\t" << rr.title << std::endl;
}

```

---

Here's a sample run of the program in Listing 16.9:

```

Enter book title (quit to quit): The Cat Who Can Teach You Weight Loss
Enter book rating: 8
Enter book title (quit to quit): The Dogs of Dharma
Enter book rating: 6
Enter book title (quit to quit): The Wimps of Wonk
Enter book rating: 3
Enter book title (quit to quit): Farewell and Delete
Enter book rating: 7

```

```

Enter book title (quit to quit): quit
Thank you. You entered the following 4 ratings:
Rating Book
8      The Cat Who Can Teach You Weight Loss
6      The Dogs of Dharma
3      The Wimps of Wonk
7      Farewell and Delete
Sorted by title:
Rating Book
7      Farewell and Delete
8      The Cat Who Can Teach You Weight Loss
6      The Dogs of Dharma
3      The Wimps of Wonk
Sorted by rating:
Rating Book
3      The Wimps of Wonk
6      The Dogs of Dharma
7      Farewell and Delete
8      The Cat Who Can Teach You Weight Loss
After shuffling:
Rating Book
7      Farewell and Delete
3      The Wimps of Wonk
6      The Dogs of Dharma
8      The Cat Who Can Teach You Weight Loss
Bye.

```

## The Range-Based for Loop (C++11)

The range-based for loop, mentioned in Chapter 5, “Loops and Relational Expressions,” is designed to work with the STL. To review, here’s the first example from Chapter 5:

```

double prices[5] = {4.99, 10.99, 6.87, 7.99, 8.49};
for (double x : prices)
    cout << x << std::endl;

```

The contents of the parentheses for the `for` loop declare a variable of the type stored in a container and then the name of the container. Next, the body of the loop uses the named variable to access each container element in turn. Consider, for instance, this statement from Listing 16.9:

```

for_each(books.begin(), books.end(), ShowReview);

```

It can be replaced with the following range-based for loop:

```

for (auto x : books) ShowReview(x);

```

The compiler will use the type of `books`, which is `vector<Review>`, to deduce that `x` is type `Review`, and the loop will pass each `Review` object in `books` to `ShowReview()` in turn.

Unlike `for_each()`, the range-based `for` can alter the contents of a container. The trick is to specify a reference parameter. For example, suppose we have this function:

```
void InflateReview(Review &r) {r.rating++;}
```

You could apply this function to each element in `books` with the following loop:

```
for (auto & x : books) InflateReview(x);
```

## Generic Programming

Now that you have some experience using the STL, let's look at the underlying philosophy. The STL is an example of *generic programming*. Object-oriented programming concentrates on the data aspect of programming, whereas generic programming concentrates on algorithms. The main things the two approaches have in common are abstraction and the creation of reusable code, but the philosophies are quite different.

A goal of generic programming is to write code that is independent of data types. Templates are the C++ tools for creating generic programs. Templates, of course, let you define a function or class in terms of a generic type. The STL goes further by providing a generic representation of algorithms. Templates make this possible, but not without the added element of careful and conscious design. To see how this mixture of templates and design works, let's look at why iterators are needed.

### Why Iterators?

Understanding iterators is perhaps the key to understanding the STL. Just as templates make algorithms independent of the type of data stored, iterators make the algorithms independent of the type of container used. Thus, they are an essential component of the STL's generic approach.

To see why iterators are needed, let's look at how you might implement a `find` function for two different data representations and then see how you could generalize the approach. First, let's consider a function that searches an ordinary array of `double` for a particular value. You could write the function like this:

```
double * find_ar(double * ar, int n, const double & val)
{
    for (int i = 0; i < n; i++)
        if (ar[i] == val)
            return &ar[i];
    return 0; // or, in C++11, return nullptr;
}
```

If the function finds the value in the array, it returns the address in the array where the value is found; otherwise, it returns the null pointer. It uses subscript notation to move through the array. You could use a template to generalize to arrays of any type having an `==` operator. Nonetheless, this algorithm is still tied to one particular data structure—the array.

So let's look at searching another kind of data structure, the linked list. (Chapter 12 uses a linked list to implement a `Queue` class.) The list consists of linked `Node` structures:

```
struct Node
{
    double item;
    Node * p_next;
};
```

Suppose you have a pointer that points to the first node in the list. The `p_next` pointer in each node points to the next node, and the `p_next` pointer for the last node in the list is set to 0. You could write a `find_ll()` function this way:

```
Node* find_ll(Node * head, const double & val)
{
    Node * start;
    for (start = head; start != 0; start = start->p_next)
        if (start->item == val)
            return start;
    return 0;
}
```

Again, you could use a template to generalize this to lists of any data type supporting the `==` operator. Nonetheless, this algorithm is still tied to one particular data structure—the linked list.

If you consider details of implementation, the two `find` functions use different algorithms: One uses array indexing to move through a list of items, and the other resets `start` to `start->p_next`. But broadly, the two algorithms are the same: Compare the value with each value in the container in sequence until you find a match.

The goal of generic programming in this case would be to have a single `find` function that would work with arrays or linked lists or any other container type. That is, not only should the function be independent of the data type stored in the container, it should be independent of the data structure of the container itself. Templates provide a generic representation for the data type stored in a container. What's needed is a generic representation of the process of moving through the values in a container. The iterator is that generalized representation.

What properties should an iterator have in order to implement a `find` function? Here's a short list:

- You should be able to dereference an iterator in order to access the value to which it refers. That is, if `p` is an iterator, `*p` should be defined.
- You should be able to assign one iterator to another. That is, if `p` and `q` are iterators, the expression `p = q` should be defined.
- You should be able to compare one iterator to another for equality. That is, if `p` and `q` are iterators, the expressions `p == q` and `p != q` should be defined.



- You should be able to move an iterator through all the elements of a container. This can be satisfied by defining `++p` and `p++` for an iterator `p`.

There are more things an iterator could do, but nothing more it need do—at least, not for the purposes of a `find` function. Actually, the STL defines several levels of iterators of increasing capabilities, and we'll return to that matter later. Note, by the way, that an ordinary pointer meets the requirements of an iterator. Hence, you can rewrite the `find_arr()` function like this:

```
typedef double * iterator;
iterator find_ar(iterator ar, int n, const double & val)
{
    for (int i = 0; i < n; i++, ar++)
        if (*ar == val)
            return ar;
    return 0;
}
```

Then you can alter the function parameter list so that it takes a pointer to the beginning of the array and a pointer to one past-the-end of the array as arguments to indicate a range. (Listing 7.8 in Chapter 7, “Functions: C++’s Programming Modules,” does something similar.) And the function can return the end pointer as a sign the value was not found. The following version of `find_ar()` makes these changes:

```
typedef double * iterator;
iterator find_ar(iterator begin, iterator end, const double & val)
{
    iterator ar;
    for (ar = begin; ar != end; ar++)
        if (*ar == val)
            return ar;
    return end; // indicates val not found
}
```

For the `find_ll()` function, you can define an iterator class that defines the `*` and `++` operators:

```
struct Node
{
    double item;
    Node * p_next;
};

class iterator
{
    Node * pt;
public:
    iterator() : pt(0) {}
    iterator (Node * pn) : pt(pn) {}
}
```

```

double operator*() { return pt->item;}
iterator& operator++()    // for ++it
{
    pt = pt->p_next;
    return *this;
}
iterator operator++(int) // for it++
{
    iterator tmp = *this;
    pt = pt->p_next;
    return tmp;
}
// ... operator==(), operator!=(), etc.
};

```

(To distinguish between the prefix and postfix versions of the ++ operator, C++ adopted the convention of letting `operator++()` be the prefix version and `operator++(int)` be the suffix version; the argument is never used and hence needn't be given a name.)

The main point here is not how, in detail, to define the `iterator` class, but that with such a class, the second `find` function can be written like this:

```

iterator find_ll(iterator head, const double & val)
{
    iterator start;
    for (start = head; start != 0; ++start)
        if (*start == val)
            return start;
    return 0;
}

```

This is very nearly the same as `find_ar()`. The point of difference is in how the two functions determine whether they've reached the end of the values being searched. The `find_ar()` function uses an iterator to one-past-the-end, whereas `find_ll()` uses a null value stored in the final node. Remove that difference, and you can make the two functions identical. For example, you could require that the linked list have one additional element after the last official element. That is, you could have both the array and the linked list have a past-the-end element, and you could end the search when the iterator reaches the past-the-end position. Then `find_ar()` and `find_ll()` would have the same way of detecting the end of data and become identical algorithms. Note that requiring a past-the-end element moves from making requirements on iterators to making requirements on the container class.

The STL follows the approach just outlined. First, each container class (`vector`, `list`, `deque`, and so on) defines an iterator type appropriate to the class. For one class, the iterator might be a pointer; for another, it might be an object. Whatever the implementation, the iterator will provide the needed operations, such as `*` and `++`. (Some classes may need

more operations than others.) Next, each container class will have a past-the-end marker, which is the value assigned to an iterator when it has been incremented one past the last value in the container. Each container class will have `begin()` and `end()` methods that return iterators to the first element in a container and to the past-the-end position. And each container class will have the `++` operation take an iterator from the first element to past-the-end, visiting every container element en route.

To use a container class, you don't need to know how its iterators are implemented nor how past-the-end is implemented. It's enough to know that it does have iterators, that `begin()` returns an iterator to the first element, and that `end()` returns an iterator to past-the-end. For example, suppose you want to print the values in a `vector<double>` object. In that case, you can use this:

```
vector<double>::iterator pr;
for (pr = scores.begin(); pr != scores.end(); pr++)
    cout << *pr << endl;
```

Here the following line identifies `pr` as the iterator type defined for the `vector<double>` class:

```
vector<double>::iterator pr;
```

If you used the `list<double>` class template instead to store scores, you could use this code:

```
list<double>::iterator pr;
for (pr = scores.begin(); pr != scores.end(); pr++)
    cout << *pr << endl;
```

The only change is in the type declared for `pr`. Thus, by having each class define appropriate iterators and designing the classes in a uniform fashion, the STL lets you write the same code for containers that have quite dissimilar internal representations.

With C++ automatic type deduction, you can simplify further and use the following code with either the `vector` or the `list`:

```
for (auto pr = scores.begin(); pr != scores.end(); pr++)
    cout << *pr << endl;
```

Actually, as a matter of style, it's better to avoid using the iterators directly; instead, if possible, you should use an STL function, such as `for_each()`, that takes care of the details for you. Alternatively, use the C++11 range-based `for` loop:

```
for (auto x : scores) cout << x << endl;
```

So to summarize the STL approach, you start with an algorithm for processing a container. You express it in as general terms as possible, making it independent of data type and container type. To make the general algorithm work with specific cases, you define iterators that meet the needs of the algorithm and place requirements on the container design. That is, basic iterator properties and container properties stem from requirements placed on the algorithm.

## Kinds of Iterators

Different algorithms have different requirements for iterators. For example, a find algorithm needs the ++ operator to be defined so the iterator can step through the entire container. It needs read access to data but not write access. (It just looks at data and doesn't change it.) The usual sorting algorithm, on the other hand, requires random access so that it can swap two non-adjacent elements. If `iter` is an iterator, you can get random access by defining the + operator so that you can use expressions such as `iter + 10`. Also a sort algorithm needs to be able to both read and write data.

The STL defines five kinds of iterators and describes its algorithms in terms of which kinds of iterators it needs. The five kinds are the input iterator, output iterator, forward iterator, bidirectional iterator, and random access iterator. For example, the `find()` prototype looks like this:

```
template<class InputIterator, class T>
InputIterator find(InputIterator first, InputIterator last, const T& value);
```

This tells you that this algorithm requires an input iterator. Similarly, the following prototype tells you that the sort algorithm requires a random access iterator:

```
template<class RandomAccessIterator>
void sort(RandomAccessIterator first, RandomAccessIterator last);
```

All five kinds of iterators can be dereferenced (that is, the \* operator is defined for them) and can be compared for equality (using the == operator, possibly overloaded) and inequality (using the != operator, possibly overloaded). If two iterators test as equal, then dereferencing one should produce the same value as dereferencing the second. That is, if

```
iter1 == iter2
```

is true, then the following is also true:

```
*iter1 == *iter2
```

Of course, these properties hold true for built-in operators and pointers, so these requirements are guides for what you must do when overloading these operators for an iterator class. Now let's look at other iterator properties.

### Input Iterators

The term *input* is used from the viewpoint of a program. That is, information going from the container to the program is considered input, just as information from a keyboard to the program is considered input. So an *input iterator* is one that a program can use to read values from a container. In particular, dereferencing an input iterator must allow a program to read a value from a container, but it needn't allow a program to alter that value. So algorithms that require an input iterator are algorithms that don't change values held in a container.

An input iterator has to allow you to access all the values in a container. It does so by supporting the ++ operator, both in prefix and suffix form. If you set an input operator to the first element in a container and increment it until it reaches past-the-end, it will point

to every container item once en route. Incidentally, there is no guarantee that traversing a container a second time with an input iterator will move through the values in the same order. Also after an input iterator has been incremented, there is no guarantee that its prior value can still be dereferenced. Any algorithm based on an input iterator, then, should be a single-pass algorithm that doesn't rely on iterator values from a previous pass or on earlier iterator values from the same pass.

Note that an input iterator is a one-way iterator; it can increment, but it can't back up.

### Output Iterators

In STL usage, the term *output* indicates that the iterator is used for transferring information from a program to a container. (Thus the output for the program is input for the container.) An output iterator is similar to an input iterator, except that dereferencing is guaranteed to allow a program to alter a container value but not to read it. If the ability to write without reading seems strange, keep in mind that this property also applies to output sent to your display; `cout` can modify the stream of characters sent to the display, but it can't read what's onscreen. The STL is general enough that its containers can represent output devices, so you can run into the same situation with containers. Also if an algorithm modifies the contents of a container (for example, by generating new values to be stored) without reading the contents, there's no reason to require that it use an iterator that can read the contents.

In short, you can use an input iterator for single-pass, read-only algorithms and an output operator for single-pass, write-only algorithms.

### Forward Iterators

Like input and output iterators, forward iterators use only the `++` operators for navigating through a container. So a forward iterator can only go forward through a container one element at a time. However, unlike input and output iterators, it necessarily goes through a sequence of values in the same order each time you use it. Also after you increment a forward iterator, you can still dereference the prior iterator value, if you've saved it, and get the same value. These properties make multiple-pass algorithms possible.

A forward iterator can allow you to both read and modify data, or it can allow you just to read it:

```
int * pirw;          // read-write iterator
const int * pir;    // read-only iterator
```

### Bidirectional Iterators

Suppose you have an algorithm that needs to be able to traverse a container in both directions. For example, a reverse function could swap the first and last elements, increment the pointer to the first element, decrement the pointer to a second element, and repeat the process. A bidirectional iterator has all the features of a forward iterator and adds support for the two decrement operators (prefix and postfix).

## Random Access Iterators

Some algorithms, such as standard sort and binary search, require the ability to jump directly to an arbitrary element of a container. This is termed *random access*, and it requires a random access iterator. This type of iterator has all the features of a bidirectional iterator, plus it adds operations (such as pointer addition) that support random access and relational operators for ordering the elements. Table 16.3 lists the operations a random access iterator has beyond those of a bidirectional iterator. In this table,  $x$  represents a random iterator type,  $T$  represents the type pointed to,  $a$  and  $b$  are iterator values,  $n$  is an integer, and  $r$  is a random iterator variable or reference.

Table 16.3 Random Access Iterator Operations

| Expression | Description                                               |
|------------|-----------------------------------------------------------|
| $a + n$    | Points to the $n$ th element after the one $a$ points to  |
| $n + a$    | Same as $a + n$                                           |
| $a - n$    | Points to the $n$ th element before the one $a$ points to |
| $r += n$   | Equivalent to $r = r + n$                                 |
| $r -= n$   | Equivalent to $r = r - n$                                 |
| $a[n]$     | Equivalent to $*(a + n)$                                  |
| $b - a$    | The value of $n$ such that $b == a + n$                   |
| $a < b$    | True if $b - a > 0$                                       |
| $a > b$    | True if $b < a$                                           |
| $a >= b$   | True if ! ( $a < b$ )                                     |
| $a <= b$   | True if ! ( $a > b$ )                                     |

Expressions such as  $a + n$  are valid only if both  $a$  and  $a + n$  lie within the range of the container (including past-the-end).

## Iterator Hierarchy

You have probably noticed that the iterator kinds form a hierarchy. A forward iterator has all the capabilities of an input iterator and of an output iterator, plus its own capabilities. A bidirectional iterator has all the capabilities of a forward iterator, plus its own capabilities. And a random access iterator has all the capabilities of a forward iterator, plus its own capabilities. Table 16.4 summarizes the main iterator capabilities. In it,  $i$  is an iterator, and  $n$  is an integer.

Table 16.4 Iterator Capabilities

| Iterator Capability | Input | Output | Forward | Bidirectional | Random Access |
|---------------------|-------|--------|---------|---------------|---------------|
| Dereferencing read  | Yes   | No     | Yes     | Yes           | Yes           |
| Dereferencing write | No    | Yes    | Yes     | Yes           | Yes           |

Table 16.4 Iterator Capabilities

| Iterator Capability               | Input | Output | Forward | Bidirectional | Random Access |
|-----------------------------------|-------|--------|---------|---------------|---------------|
| Fixed and repeatable order        | No    | No     | Yes     | Yes           | Yes           |
| <code>++i</code> <code>i++</code> | Yes   | Yes    | Yes     | Yes           | Yes           |
| <code>--i</code> <code>i--</code> | No    | No     | No      | Yes           | Yes           |
| <code>i[n]</code>                 | No    | No     | No      | No            | Yes           |
| <code>i + n</code>                | No    | No     | No      | No            | Yes           |
| <code>i - n</code>                | No    | No     | No      | No            | Yes           |
| <code>i += n</code>               | No    | No     | No      | No            | Yes           |
| <code>i -=n</code>                | No    | No     | No      | No            | Yes           |

An algorithm written in terms of a particular kind of iterator can use that kind of iterator or any other iterator that has the required capabilities. So a container with, say, a random access iterator can use an algorithm written for an input iterator.

Why all these different kinds of iterators? The idea is to write an algorithm using the iterator with the fewest requirements possible, allowing it to be used with the largest range of containers. Thus, the `find()` function, by using a lowly input iterator, can be used with any container that contains readable values. The `sort()` function, however, by requiring a random access iterator, can be used just with containers that support that kind of iterator.

Note that the various iterator kinds are not defined types; rather, they are conceptual characterizations. As mentioned earlier, each container class defines a class scope `typedef` name called `iterator`. So the `vector<int>` class has iterators of type `vector<int>::iterator`. But the documentation for this class would tell you that `vector` iterators are random access iterators. That, in turn, allows you to use algorithms based on any iterator type because a random access iterator has all the iterator capabilities. Similarly, a `list<int>` class has iterators of type `list<int>::iterator`. The STL implements a doubly linked list, so it uses a bidirectional iterator. Thus, it can't use algorithms based on random access iterators, but it can use algorithms based on less demanding iterators.

## Concepts, Refinements, and Models

The STL has several features, such as kinds of iterators, that aren't expressible in the C++ language. That is, although you can design, say, a class that has the properties of a forward iterator, you can't have the compiler restrict an algorithm to using only that class. The reason is that the forward iterator is a set of requirements, not a type. The requirements could be satisfied by an iterator class you've designed, but they could also be satisfied by an ordinary pointer. An STL algorithm works with any iterator implementation that meets its requirements. STL literature uses the word *concept* to describe a set of requirements. Thus, there is an input iterator concept, a forward iterator concept, and so on. By the way, if you do need iterators for, say, a container class you're designing, you can look to the STL, which include iterator templates for the standard varieties.

Concepts can have an inheritance-like relationship. For example, a bidirectional iterator inherits the capabilities of a forward iterator. However, you can't apply the C++ inheritance mechanism to iterators. For example, you might implement a forward iterator as a class and a bidirectional iterator as a regular pointer. So in terms of the C++ language, this particular bidirectional iterator, being a built-in type, couldn't be derived from a class. Conceptually, however, it does inherit. Some STL literature uses the term *refinement* to indicate this conceptual inheritance. Thus, a bidirectional iterator is a refinement of the forward iterator concept.

A particular implementation of a concept is termed a *model*. Thus, an ordinary pointer-to-int is a model of the concept random access iterator. It's also a model of a forward iterator, for it satisfies all the requirements of that concept.

### The Pointer As Iterator

Iterators are generalizations of pointers, and a pointer satisfies all the iterator requirements. Iterators form the interface for STL algorithms, and pointers are iterators, so STL algorithms can use pointers to operate on non-STL containers that are based on pointers. For example, you can use STL algorithms with arrays. Suppose `Receipts` is an array of double values, and you would like to sort in ascending order:

```
const int SIZE = 100;
double Receipts[SIZE];
```

The STL `sort()` function, recall, takes as arguments an iterator pointing to the first element in a container and an iterator pointing to past-the-end. Well, `&Receipts[0]` (or just `Receipts`) is the address of the first element, and `&Receipts[SIZE]` (or just `Receipts + SIZE`) is the address of the element following the last element in the array. Thus, the following function call sorts the array:

```
sort(Receipts, Receipts + SIZE);
```

C++ guarantees that the expression `Receipts + n` is defined as long as the result lies in the array or one past-the-end. Thus, C++ supports the "one-past-the-end" concept for pointers into an array, and this makes it possible to apply STL algorithms to ordinary arrays. Thus, the fact that pointers are iterators and that algorithms are iterator based makes it possible to apply STL algorithms to ordinary arrays. Similarly, you can apply STL algorithms to data forms of your own design, provided that you supply suitable iterators (which may be pointers or objects) and past-the-end indicators.

### `copy()`, `ostream_iterator`, and `istream_iterator`

The STL provides some predefined iterators. To see why, let's establish some background. There is an algorithm called `copy()` for copying data from one container to another. This algorithm is expressed in terms of iterators, so it can copy from one kind of container to another or even from or to an array, because you can use pointers into an array as iterators. For example, the following copies an array into a vector:



```
int casts[10] = {6, 7, 2, 9, 4, 11, 8, 7, 10, 5};
vector<int> dice[10];
copy(casts, casts + 10, dice.begin()); // copy array to vector
```

The first two iterator arguments to `copy()` represent a range to be copied, and the final iterator argument represents the location to which the first item is copied. The first two arguments must be input iterators (or better), and the final argument must be an output iterator (or better). The `copy()` function overwrites existing data in the destination container, and the container has to be large enough to hold the copied elements. So you can't use `copy()` to place data in an empty vector—at least not without resorting to a trick that is revealed later in this chapter.

Now suppose you want to copy information to the display. You could use `copy()` if there was an iterator representing the output stream. The STL provides such an iterator with the `ostream_iterator` template. Using STL terminology, this template is a *model* of the output iterator concept. It is also an example of an *adapter*—a class or function that converts some other interface to an interface used by the STL. You can create an iterator of this kind by including the `iterator` (formerly `iterator.h`) header file and making a declaration:

```
#include <iterator>
...
ostream_iterator<int, char> out_iter(cout, " ");
```

The `out_iter` iterator now becomes an interface that allows you to use `cout` to display information. The first template argument (`int`, in this case) indicates the data type being sent to the output stream. The second template argument (`char`, in this case) indicates the character type used by the output stream. (Another possible value would be `wchar_t`.) The first constructor argument (`cout`, in this case) identifies the output stream being used. It could also be a stream used for file output. The final character string argument is a separator to be displayed after each item sent to the output stream.

You could use the iterator like this:

```
*out_iter++ = 15; // works like cout << 15 << " ";
```

For a regular pointer, this would mean assigning the value 15 to the pointed-to location and then incrementing the pointer. For this `ostream_iterator`, however, the statement means send 15 and then a string consisting of a space to the output stream managed by `cout`. Then it should get ready for the next output operation. You could use the iterator with `copy()` as follows:

```
copy(dice.begin(), dice.end(), out_iter); // copy vector to output stream
```

This would mean to copy the entire range of the `dice` container to the output stream—that is, to display the contents of the container.

Or you could skip creating a named iterator and construct an anonymous iterator instead. That is, you could use the adapter like this:

```
copy(dice.begin(), dice.end(), ostream_iterator<int, char>(cout, " ") );
```

Similarly, the `iterator` header file defines an `istream_iterator` template for adapting `istream` input to the iterator interface. It is a model of the input iterator concept. You could use two `istream_iterator` objects to define an input range for `copy()`:

```
copy(istream_iterator<int, char>(cin),
     istream_iterator<int, char>(), dice.begin());
```

Like `ostream_iterator`, `istream_iterator` uses two template arguments. The first indicates the data type to be read, and the second indicates the character type used by the input stream. Using a constructor argument of `cin` means to use the input stream managed by `cin`. Omitting the constructor argument indicates input failure, so the previous code means to read from the input stream until end-of-file, type mismatch, or some other input failure.

### Other Useful Iterators

The `iterator` header file provides some other special-purpose predefined iterator types in addition to `ostream_iterator` and `istream_iterator`. They are `reverse_iterator`, `back_inserter_iterator`, `front_inserter_iterator`, and `insert_iterator`.

Let's start with seeing what a reverse iterator does. In essence, incrementing a reverse iterator causes it to decrement. Why not just decrement a regular iterator? The main reason is to simplify using existing functions. Suppose you want to display the contents of the `dice` container. As you just saw, you can use `copy()` and `ostream_iterator` to copy the contents to the output stream:

```
ostream_iterator<int, char> out_iter(cout, " ");
copy(dice.begin(), dice.end(), out_iter); // display in forward order
```

Now suppose you want to print the contents in reverse order. (Perhaps you are performing time-reversal studies.) There are several approaches that don't work, but rather than wallow in them, let's go to one that does. The `vector` class has a member function called `rbegin()` that returns a reverse iterator pointing to past-the-end and a member `rend()` that returns a reverse iterator pointing to the first element. Because incrementing a reverse iterator makes it decrement, you can use the following statement to display the contents backward:

```
copy(dice.rbegin(), dice.rend(), out_iter); // display in reverse order
```

You don't even have to declare a reverse iterator.

#### Note

Both `rbegin()` and `end()` return the same value (past-the-end), but as a different type (`reverse_iterator` versus `iterator`). Similarly, both `rend()` and `begin()` return the same value (an iterator to the first element), but as a different type.

Reverse pointers have to make a special compensation. Suppose `rp` is a reverse pointer initialized to `dice.rbegin()`. What should `*rp` be? Because `rbegin()` returns past-the-end, you shouldn't try to dereference that address. Similarly, if `rend()` is really the location of the first element, `copy()` stops one location earlier because the end of the range is not

in a range. Reverse pointers solve both problems by decrementing first and then dereferencing. That is, `*rp` dereferences the iterator value immediately preceding the current value of `*rp`. If `rp` points to position six, `*rp` is the value of position five, and so on. Listing 16.10 illustrates using `copy()`, an ostream iterator, and a reverse iterator.

---

Listing 16.10 `copyit.cpp`

```
// copyit.cpp -- copy() and iterators
#include <iostream>
#include <iterator>
#include <vector>

int main()
{
    using namespace std;

    int casts[10] = {6, 7, 2, 9, 4, 11, 8, 7, 10, 5};
    vector<int> dice(10);
    // copy from array to vector
    copy(casts, casts + 10, dice.begin());
    cout << "Let the dice be cast!\n";
    // create an ostream iterator
    ostream_iterator<int, char> out_iter(cout, " ");
    // copy from vector to output
    copy(dice.begin(), dice.end(), out_iter);
    cout << endl;
    cout << "Implicit use of reverse iterator.\n";
    copy(dice.rbegin(), dice.rend(), out_iter);
    cout << endl;
    cout << "Explicit use of reverse iterator.\n";
    vector<int>::reverse_iterator ri;
    for (ri = dice.rbegin(); ri != dice.rend(); ++ri)
        cout << *ri << ' ';
    cout << endl;

    return 0;
}
```

---

Here is the output of the program in Listing 16.10:

```
Let the dice be cast!
6 7 2 9 4 11 8 7 10 5
Implicit use of reverse iterator.
5 10 7 8 11 4 9 2 7 6
Explicit use of reverse iterator.
5 10 7 8 11 4 9 2 7 6
```

If you have the choice of explicitly declaring iterators or using STL functions to handle the matter internally, for example, by passing an `rbegin()` return value to a function, you should take the latter course. It's one less thing to do and one less opportunity to experience human fallibility.

The other three iterators (`back_insert_iterator`, `front_insert_iterator`, and `insert_iterator`) also increase the generality of the STL algorithms. Many STL functions are like `copy()` in that they send their results to a location indicated by an output iterator. Recall that the following copies values to the location beginning at `dice.begin()`:

```
copy(casts, casts + 10, dice.begin());
```

These values overwrite the prior contents in `dice`, and the function assumes that `dice` has enough room to hold the values. That is, `copy()` does not automatically adjust the size of the destination to fit the information sent to it. Listing 16.10 takes care of that situation by declaring `dice` to have 10 elements, but suppose you don't know in advance how big `dice` should be. Or suppose you want to add elements to `dice` rather than overwrite existing ones.

The three insert iterators solve these problems by converting the copying process to an insertion process. Insertion adds new elements without overwriting existing data, and it uses automatic memory allocation to ensure that the new information fits. A `back_insert_iterator` inserts items at the end of the container, and a `front_insert_iterator` inserts items at the front. Finally, the `insert_iterator` inserts items in front of the location specified as an argument to the `insert_iterator` constructor. All three of these iterators are models of the output container concept.

There are restrictions. A `back_insert_iterator` can be used only with container types that allow rapid insertion at the end. (*Rapid* refers to a constant time algorithm; the section "Container Concepts," later in this chapter, discusses the constant time concept further.) The `vector` class qualifies. A `front_insert_iterator` can be used only with container types that allow constant time insertion at the beginning. Here the `vector` class doesn't qualify, but the `queue` class does. The `insert_iterator` doesn't have these restrictions. Thus, you can use it to insert material at the front of a `vector`. However, a `front_insert_iterator` does so faster for the container types that support it.

### Tip

You can use an `insert_iterator` to convert an algorithm that copies data into one that inserts data.

These iterators take the container type as a template argument and the actual container identifier as a constructor argument. That is, to create a `back_insert_iterator` for a `vector<int>` container called `dice`, you use this:

```
back_insert_iterator<vector<int> > back_iter(dice);
```

The reason you have to declare the container type is that the iterator has to make use of the appropriate container method. The code for the `back_insert_iterator`

constructor will assume that a `push_back()` method exists for the type passed to it. The `copy()` function, being a standalone function, doesn't have the access rights to resize a container. But the declaration just shown allows `back_iter` to use the `vector<int>::push_back()` method, which does have access rights.

Declaring a `front_insert_iterator` has the same form. An `insert_iterator` declaration has an additional constructor argument to identify the insertion location:

```
insert_iterator<vector<int> > insert_iter(dice, dice.begin() );
```

Listing 16.11 illustrates using two of these iterators. Also it uses `for_each()` instead of an ostream iterator for output.

---

**Listing 16.11** `inserts.cpp`

---

```
// inserts.cpp -- copy() and insert iterators
#include <iostream>
#include <string>
#include <iterator>
#include <vector>
#include <algorithm>

void output(const std::string & s) {std::cout << s << " ";}

int main()
{
    using namespace std;
    string s1[4] = {"fine", "fish", "fashion", "fate"};
    string s2[2] = {"busy", "bats"};
    string s3[2] = {"silly", "singers"};
    vector<string> words(4);
    copy(s1, s1 + 4, words.begin());
    for_each(words.begin(), words.end(), output);
    cout << endl;
    // construct anonymous back_insert_iterator object
    copy(s2, s2 + 2, back_insert_iterator<vector<string> >(words));
    for_each(words.begin(), words.end(), output);
    cout << endl;

    // construct anonymous insert_iterator object
    copy(s3, s3 + 2, insert_iterator<vector<string> >(words,
  words.begin()));
    for_each(words.begin(), words.end(), output);
    cout << endl;
    return 0;
}
```

---

Here is the output of the program in Listing 16.11:

```
fine fish fashion fate
fine fish fashion fate busy bats
silly singers fine fish fashion fate busy bats
```

The first `copy()` copies the four strings from `s1` into `words`. This works in part because `words` is declared to hold four strings, which equals the number of strings being copied. Then the `back_insert_iterator` inserts the strings from `s2` just in front of the end of the `words` array, expanding the size of `words` to six elements. Finally, the `insert_iterator` inserts the two strings from `s3` just in front of the first element of `words`, expanding the size of `words` to eight elements. If the program attempted to copy `s2` and `s3` into `words` by using `words.end()` and `words.begin()` as iterators, there would be no room in `words` for the new data, and the program would probably abort because of memory violations.

If you're feeling overwhelmed by all the iterator varieties, keep in mind that using them will make them familiar. Also keep in mind that these predefined iterators expand the generality of the STL algorithms. Thus, not only can `copy()` copy information from one container to another, it can copy information from a container to the output stream and from the input stream to a container. And you can also use `copy()` to insert material into another container. So you wind up with a single function doing the work of many. And because `copy()` is just one of several STL functions that use an output iterator, these predefined iterators multiply the capabilities of those functions, too.

## Kinds of Containers

The STL has both container concepts and container types. The concepts are general categories with names such as container, sequence container, and associative container. The container types are templates you can use to create specific container objects. The original 11 container types are `deque`, `list`, `queue`, `priority_queue`, `stack`, `vector`, `map`, `multimap`, `set`, `multiset`, and `bitset`. (This chapter doesn't discuss `bitset`, which is a container for dealing with data at the bit level.) C++11 adds `forward_list`, `unordered_map`, `unordered_multimap`, `unordered_set`, and `unordered_multiset`, and it moves `bitset` from the container category into its own separate category. Because the concepts categorize the types, let's start with them.

## Container Concepts

No type corresponds to the basic container concept, but the concept describes elements common to all the container classes. It's sort of a conceptual abstract base class—conceptual because the container classes don't actually use the inheritance mechanism. Or to put it another way, the container concept lays down a set of requirements that all STL container classes must satisfy.

A *container* is an object that stores other objects, which are all of a single type. The stored objects may be objects in the OOP sense, or they may be values of built-in types. Data stored in a container is *owned* by the container. That means when a container

expires, so does the data stored in the container. (However, if the data are pointers, the pointed-to data does not necessarily expire.)

You can't store just any kind of object in a container. In particular, the type has to be *copy constructable* and *assignable*. Basic types satisfy these requirements, as do class types—unless the class definition makes one or both of the copy constructor and the assignment operator private or protected. (C++11 refines the concepts, adding terms such as *CopyInsertable* and *MoveInsertable*, but we'll take a more simplified, if less precise, overview.)

The basic container doesn't guarantee that its elements are stored in any particular order or that the order doesn't change, but refinements to the concept may add such guarantees. All containers provide certain features and operations. Table 16.5 summarizes several of these common features. In the table, `X` represents a container type (such as `vector`), `T` represents the type of object stored in the container, `a` and `b` represent values of type `X`, `r` is a value of type `X&`, and `u` represents an identifier of type `X` (that is, if `X` represents `vector<int>`, then `u` is a `vector<int>` object).

Table 16.5 Some Basic Container Properties

| Expression                      | Return Type                              | Description                                                            | Complexity   |
|---------------------------------|------------------------------------------|------------------------------------------------------------------------|--------------|
| <code>X::iterator</code>        | Iterator type pointing to <code>T</code> | Any iterator category satisfying forward iterator requirements         | Compile time |
| <code>X::value_type</code>      | <code>T</code>                           | The type for <code>T</code>                                            | Compile time |
| <code>X u;</code>               |                                          | Creates an empty container called <code>u</code>                       | Constant     |
| <code>X();</code>               |                                          | Creates an empty anonymous container                                   | Constant     |
| <code>X u(a);</code>            |                                          | Copy constructor post condition:<br><code>u == a</code>                | Linear       |
| <code>X u = a;</code>           |                                          | Same effect as <code>X u(a);</code>                                    | Linear       |
| <code>r = a;</code>             | <code>X&amp;</code>                      | Copy assignment post condition:<br><code>r == a</code>                 | Linear       |
| <code>(&amp;a)-&gt;~X();</code> | <code>void</code>                        | Applies destructor to every element of a container                     | Linear       |
| <code>a.begin();</code>         | iterator                                 | Returns an iterator referring to the first element of the container    | Constant     |
| <code>a.end();</code>           | iterator                                 | Returns an iterator that is a past-the-end value                       | Constant     |
| <code>a.size();</code>          | unsigned integral type                   | Returns a number of elements equal to <code>a.end() - a.begin()</code> | Constant     |
| <code>a.swap(b);</code>         | <code>void</code>                        | Swaps contents of <code>a</code> and <code>b</code>                    | Constant     |

Table 16.5 Some Basic Container Properties

| Expression          | Return Type                      | Description                                                                                                                                                                                                                | Complexity |
|---------------------|----------------------------------|----------------------------------------------------------------------------------------------------------------------------------------------------------------------------------------------------------------------------|------------|
| <code>a == b</code> | convertible to <code>bool</code> | Returns <code>true</code> if <code>a</code> and <code>b</code> have the same size and each element in <code>a</code> is equivalent to ( <code>==</code> is <code>true</code> ) the corresponding element in <code>b</code> | Linear     |
| <code>a != b</code> | convertible to <code>bool</code> | Returns <code>!(a == b)</code>                                                                                                                                                                                             | Linear     |

The Complexity column in Table 16.5 describes the time needed to perform an operation. This table lists three possibilities, which, from fastest to slowest, are as follows:

- Compile time
- Constant time
- Linear time

If the complexity is compile time, the action is performed during compilation and uses no execution time. A constant complexity means the operation takes place during runtime but doesn't depend on the number of elements in an object. A linear complexity means the time is proportional to the number of elements. Thus, if `a` and `b` are containers, `a == b` has linear complexity because the `==` operation may have to be applied to each element of the container. Actually, that is a worst-case scenario. If two containers have different sizes, no individual comparisons need to be made.

### Constant-Time and Linear-Time Complexity

Imagine a long, narrow box filled with large packages arranged in a line, and suppose the box is open at just one end. Suppose your task is to unload the package at the open end. This is a constant time task. Whether there are 10 packages or 1,000 packages behind the one at the end makes no difference.

Now suppose your task is to fetch the package at the closed end of the box. This is a linear time task. If there are 10 packages altogether, you have to unload 10 packages to get the one at the closed end. If there are 100 packages, you have to unload 100 packages at the end. Assuming that you are a tireless worker who can move only 1 package at a time, this task will take 10 times longer than the first one.

Now suppose your task is to fetch an arbitrary package. It might happen that the package you are supposed to get is the first one at hand. However, on the average, the number of packages you have to move is still proportional to the number of packages in the container, so the task still has linear-time complexity.

Replacing the long, narrow box with a similar box having open sides would change the task to constant-time complexity because then you could move directly to the desired package and remove it without moving the others.



The idea of time complexity describes the effect of container size on execution time but ignores other factors. If a superhero can unload packages from a box with one open end 1,000 times faster than you can, the task as executed by her still has linear-time complexity. In this case, the super hero's linear time performance with a closed box (open end) would be faster than your constant time performance with an open box, as long as the boxes didn't have too many packages.

Complexity requirements are characteristic of the STL. Although the details of an implementation may be hidden, the performance specifications should be public so that you know the computing cost of doing a particular operation.

### C++11 Additions to Container Requirements

Table 16.6 shows some additions C++11 has made to the general container requirements. The table uses the notation `rv` to denote a non-constant rvalue of type `x` (for example, the return value of a function). Also the requirement in Table 16.6 that `x::iterator` satisfy the requirements for a forward iterator is a change from the former requirement that it just not be an output iterator.

Table 16.6 Some Added Basic Container Requirements (C++11)

| Expression              | Return Type                 | Description                                                                                                   | Complexity |
|-------------------------|-----------------------------|---------------------------------------------------------------------------------------------------------------|------------|
| <code>X u(rv);</code>   |                             | Move constructor post condition: <code>u</code> has the value that <code>rv</code> had prior to construction. | Linear     |
| <code>X u = rv;</code>  |                             | Same effect as <code>X u(rv);</code> .                                                                        |            |
| <code>a = rv;</code>    | <code>X&amp;</code>         | Move assignment post condition: <code>a</code> has the value that <code>rv</code> had prior to assignment.    | Linear     |
| <code>a.cbegin()</code> | <code>const_iterator</code> | Returns a <code>const</code> iterator referring to the first element of the container.                        | Constant   |
| <code>a.cend()</code>   | <code>const_iterator</code> | Returns a <code>const</code> iterator that is a past-the-end value.                                           | Constant   |

The difference between copy construction and copy assignment on the one hand and move construction and move assignment on the other hand is that a copy operation leaves the original unchanged, whereas a move operation can alter the original, perhaps transferring ownership without doing any copying. When the source object is temporary, move operations can provide more efficient code than does regular copying. Chapter 18 discusses move semantics further.

## Sequences

You can refine the basic container concept by adding requirements. The *sequence* is an important refinement because several of the STL container types—`deque`, `forward_list` (C++11), `list`, `queue`, `priority_queue`, `stack`, and `vector`—are sequences. (Recall that a queue allows elements to be added at the rear end and removed from the front. A double-ended queue, represented by `deque`, allows addition and removal at both ends.) The requirement that the iterator be at least a forward iterator guarantees that the elements are arranged in a definite order that doesn't change from one cycle of iteration to the next. The `array` class also is classified as a sequence container, although it doesn't satisfy all the requirements.

The sequence also requires that its elements be arranged in strict linear order. That is, there is a first element, there is a last element, and each element but the first and last has exactly one element immediately ahead of it and one element immediately after it. An array and a linked list are examples of sequences, whereas a branching structure (in which each node points to two daughter nodes) is not.

Because elements in sequence have a definite order, operations such as inserting values at a particular location and erasing a particular range become possible. Table 16.7 lists these and other operations required of a sequence. The table uses the same notation as Table 16.5, with the addition of `t` representing a value of type `T`—that is, the type of value stored in the container, of `n`, an integer, and of `p`, `q`, `i`, and `j`, representing iterators.

Table 16.7 Sequence Requirements

| Expression                   | Return Type | Description                                                                                 |
|------------------------------|-------------|---------------------------------------------------------------------------------------------|
| <code>X a(n,t);</code>       |             | Declares a sequence <code>a</code> of <code>n</code> copies of value <code>t</code>         |
| <code>X(n, t)</code>         |             | Creates an anonymous sequence of <code>n</code> copies of value <code>t</code>              |
| <code>X a(i, j)</code>       |             | Declares a sequence <code>a</code> initialized to the contents of range <code>[i, j)</code> |
| <code>X(i, j)</code>         |             | Creates an anonymous sequence initialized to the contents of range <code>[i, j)</code>      |
| <code>a.insert(p,t)</code>   | iterator    | Inserts a copy of <code>t</code> before <code>p</code>                                      |
| <code>a.insert(p,n,t)</code> | void        | Inserts <code>n</code> copies of <code>t</code> before <code>p</code>                       |
| <code>a.insert(p,i,j)</code> | void        | Inserts copies of elements in the range <code>[i, j)</code> before <code>p</code>           |
| <code>a.erase(p)</code>      | iterator    | Erases the element pointed to by <code>p</code>                                             |
| <code>a.erase(p,q)</code>    | iterator    | Erases the elements in the range <code>[p, q)</code>                                        |
| <code>a.clear()</code>       | void        | Is the same as <code>erase(begin(), end())</code>                                           |

Because the `deque`, `list`, `queue`, `priority_queue`, `stack`, and `vector` template classes are all models of the sequence concept, they all support the operators in Table 16.7. In

addition, there are operations that are available to some of these six models. When allowed, they have constant-time complexity. Table 16.8 lists these additional operations.

Table 16.8 Optional Sequence Requirements

| Expression                   | Return Type         | Meaning                             | Container           |
|------------------------------|---------------------|-------------------------------------|---------------------|
| <code>a.front()</code>       | <code>T&amp;</code> | <code>*a.begin()</code>             | vector, list, deque |
| <code>a.back()</code>        | <code>T&amp;</code> | <code>*--a.end()</code>             | vector, list, deque |
| <code>a.push_front(t)</code> | <code>void</code>   | <code>a.insert(a.begin(), t)</code> | list, deque         |
| <code>a.push_back(t)</code>  | <code>void</code>   | <code>a.insert(a.end(), t)</code>   | vector, list, deque |
| <code>a.pop_front()</code>   | <code>void</code>   | <code>a.erase(a.begin())</code>     | list, deque         |
| <code>a.pop_back()</code>    | <code>void</code>   | <code>a.erase(--a.end())</code>     | vector, list, deque |
| <code>a[n]</code>            | <code>T&amp;</code> | <code>*(a.begin() + n)</code>       | vector, deque       |
| <code>a.at(n)</code>         | <code>T&amp;</code> | <code>*(a.begin() + n)</code>       | vector, deque       |

Table 16.8 merits a comment or two. First, notice that `a[n]` and `a.at(n)` both return a reference to the *n*th element (numbering from 0) in a container. The difference between the two is that `a.at(n)` does bounds checking and throws an `out_of_range` exception if *n* is outside the valid range for the container. Next, you might wonder why, say, `push_front()` is defined for `list` and `deque` and not for `vector`. Suppose you want to insert a new value at the front of a vector of 100 elements. To make room, you have to move element 99 to position 100, and then you have to move element 98 to position 99, and so on. This is an operation with linear-time complexity because moving 100 elements would take 100 times as long as moving a single element. But the operations in Table 16.8 are supposed to be implemented only if they can be performed with constant-time complexity. The design for lists and double-ended queues, however, allows an element to be added to the front without moving the other elements to new locations, so they can implement `push_front()` with constant-time complexity. Figure 16.4 illustrates `push_front()` and `push_back()`.

Let's take a closer look at the six sequence container types.

### vector

You've already seen several examples using the `vector` template, which is declared in the `vector` header file. In brief, `vector` is a class representation of an array. The class provides automatic memory management that allows the size of a `vector` object to vary dynamically, growing and shrinking as elements are added or removed. It provides random access to elements. Elements can be added to or removed from the end in constant time, but insertion and removal from the beginning and the middle are linear-time operations.

In addition to being a sequence, a `vector` container is also a model of the *reversible container* concept. This adds two more class methods: `rbegin()` returns an iterator to the first element of the reversed sequence, and `rend()` returns a past-the-end iterator for the

reversed sequence. So if `dice` is a `vector<int>` container and `Show(int)` is a function that displays an integer, the following code displays the contents of `dice` first in forward order and then in reverse order:

```
for_each(dice.begin(), dice.end(), Show); // display in order
cout << endl;
for_each(dice.rbegin(), dice.rend(), Show); // display in reversed order
cout << endl;
```

```
char word[4] = "cow";
deque<char>dword(word, word+3);

dqword: [c][o][w]

dqword.push_front('s');
      ↓
dqword: [s][c][o][w]

dqword.push_back('l');
              ↓
dqword: [s][c][o][w][l]
```

Figure 16.4 `push_front()` and `push_back()`.

The iterator returned by the two methods is of a class scope type `reverse_iterator`. Recall that incrementing such an iterator causes it to move through a reversible container in reverse order.

The `vector` template class is the simplest of the sequence types and is considered the type that should be used by default unless the program requirements are better satisfied by the particular virtues of the other types.

## deque

The `deque` template class (declared in the `deque` header file) represents a double-ended queue, a type often called a *deque* (pronounced “deck”), for short. As implemented in the STL, it’s a lot like a `vector` container, supporting random access. The main difference is that inserting and removing items from the beginning of a `deque` object are constant-time operations instead of being linear-time operations the way they are for `vector`. So if most operations take place at the beginning and ends of a sequence, you should consider using a `deque` data structure.

The goal of constant-time insertion and removal at both ends of a `deque` makes the design of a `deque` object more complex than that of a `vector` object. Thus, although both offer random access to elements and linear-time insertion and removal from the middle of a sequence, the `vector` container should allow faster execution of these operations.

**list**

The `list` template class (declared in the `list` header file) represents a doubly linked list. Each element, other than the first and last, is linked to the item before it and the item following it, implying that a list can be traversed in both directions. The crucial difference between `list` and `vector` is that `list` provides for constant-time insertion and removal of elements at any location in the list. (Recall that the `vector` template provides linear-time insertion and removal except at the end, where it provides constant-time insertion and removal.) Thus, `vector` emphasizes rapid access via random access, whereas `list` emphasizes rapid insertion and removal of elements.

Like `vector`, `list` is a reversible container. Unlike `vector`, `list` does not support array notation and random access. Unlike a `vector` iterator, a `list` iterator remains pointing to the same element even after items are inserted into or removed from a container. For example, suppose you have an iterator pointing to the fifth element of a `vector` container. Then suppose you insert an element at the beginning of the container. All the other elements have to be moved to make room, so after the insertion, the fifth element now contains the value that used to be in the fourth element. Thus, the iterator points to the same location but to different data. Inserting a new element into a list, however, doesn't move the existing elements; it just alters the link information. An iterator pointing to a certain item still points to the same item, but it may be linked to different items than before.

The `list` template class has some list-oriented member functions in addition to those that come with sequences and reversible containers. Table 16.9 lists many of them. (For a complete list of STL methods and functions, see Appendix G.) The `Alloc` template parameter is one you normally don't have to worry about because it has a default value.

Table 16.9 Some `list` Member Functions

| Function                                                       | Description                                                                                                                                                                                                  |
|----------------------------------------------------------------|--------------------------------------------------------------------------------------------------------------------------------------------------------------------------------------------------------------|
| <code>void merge(list&lt;T, Alloc&gt;&amp; x)</code>           | Merges list <code>x</code> with the invoking list. Both lists must be sorted. The resulting sorted list is in the invoking list, and <code>x</code> is left empty. This function has linear-time complexity. |
| <code>void remove(const T &amp; val)</code>                    | Removes all instances of <code>val</code> from the list. This function has linear-time complexity.                                                                                                           |
| <code>void sort()</code>                                       | Sorts the list by using the <code>&lt;</code> operator; the complexity is $N \log N$ for $N$ elements.                                                                                                       |
| <code>void splice(iterator pos, list&lt;T, Alloc&gt; x)</code> | Inserts the contents of list <code>x</code> in front of position <code>pos</code> , and <code>x</code> is left empty. This function has constant-time complexity.                                            |
| <code>void unique()</code>                                     | Collapses each consecutive group of equal elements to a single element. This function has linear-time complexity.                                                                                            |

Listing 16.12 illustrates these methods, along with the `insert()` method, which comes with all STL classes that model sequences.

#### Listing 16.12 `list.cpp`

---

```
// list.cpp -- using a list
#include <iostream>
#include <list>
#include <iterator>
#include <algorithm>

void outint(int n) {std::cout << n << " " ;}

int main()
{
    using namespace std;
    list<int> one(5, 2); // list of 5 2s
    int stuff[5] = {1,2,4,8, 6};
    list<int> two;
    two.insert(two.begin(),stuff, stuff + 5 );
    int more[6] = {6, 4, 2, 4, 6, 5};
    list<int> three(two);
    three.insert(three.end(), more, more + 6);

    cout << "List one: ";
    for_each(one.begin(),one.end(), outint);
    cout << endl << "List two: ";
    for_each(two.begin(), two.end(), outint);
    cout << endl << "List three: ";
    for_each(three.begin(), three.end(), outint);
    three.remove(2);
    cout << endl << "List three minus 2s: ";
    for_each(three.begin(), three.end(), outint);
    three.splice(three.begin(), one);
    cout << endl << "List three after splice: ";
    for_each(three.begin(), three.end(), outint);
    cout << endl << "List one: ";
    for_each(one.begin(), one.end(), outint);
    three.unique();
    cout << endl << "List three after unique: ";
    for_each(three.begin(), three.end(), outint);
    three.sort();
    three.unique();
    cout << endl << "List three after sort & unique: ";
    for_each(three.begin(), three.end(), outint);
    two.sort();
    three.merge(two);
```

```

    cout << endl << "Sorted two merged into three: ";
    for_each(three.begin(), three.end(), outint);
    cout << endl;

    return 0;
}

```

---

Here is the output of the program in Listing 16.12:

```

List one: 2 2 2 2 2
List two: 1 2 4 8 6
List three: 1 2 4 8 6 6 4 2 4 6 5
List three minus 2s: 1 4 8 6 6 4 4 6 5
List three after splice: 2 2 2 2 2 1 4 8 6 6 4 4 6 5
List one:
List three after unique: 2 1 4 8 6 4 6 5
List three after sort & unique: 1 2 4 5 6 8
Sorted two merged into three: 1 1 2 2 4 4 5 6 6 8 8

```

### Program Notes

The program in Listing 16.12 uses the `for_each()` algorithm and an `outint()` function to display the lists. With C++11, you could use the range-based `for` loop instead:

```
for (auto x : three) cout << x << " ";
```

The main difference between `insert()` and `splice()` is that `insert()` inserts a copy of the original range into the destination, whereas `splice()` moves the original range into the destination. Thus, after the contents of `one` are spliced to `three`, `one` is left empty. (The `splice()` method has additional prototypes for moving single elements and a range of elements.) The `splice()` method leaves iterators valid. That is, if you set a particular iterator to point to an element in `one`, that iterator still points to the same element after `splice()` relocates it in `three`.

Notice that `unique()` only reduces adjacent equal values to a single value. After the program executes `three.unique()`, `three` still contains two fours and two sixes that weren't adjacent. But applying `sort()` and then `unique()` does limit each value to a single appearance.

There is a nonmember `sort()` function (Listing 16.9), but it requires random access iterators. Because the trade-off for rapid insertion is to give up random access, you can't use the nonmember `sort()` function with a list. Therefore, the class includes a member version that works within the restrictions of the class.

### The list Toolbox

The `list` methods form a handy toolbox. Suppose, for example, that you have two mailing lists to organize. You could sort each list, merge them, and then use `unique()` to remove multiple entries.

The `sort()`, `merge()`, and `unique()` methods also each have a version that accepts an additional argument to specify an alternative function to be used for comparing elements. Similarly, the `remove()` method has a version with an additional argument that specifies a function used to determine whether an element is removed. These arguments are examples of predicate functions, a topic to which we'll return later.

### **forward\_list (C++11)**

C++11 adds `forward_list` as a container class. This class implements a singly linked list. In this kind of list, each item is linked just to the next item, but not to the preceding item. Therefore, the class requires just a forward iterator, not a bidirectional one. Thus, unlike `vector` and `list`, `forward_list` isn't a reversible container. Compared to `list`, `forward_list` is simpler, more compact, but with fewer features.

### **queue**

The `queue` template class (declared in the `queue`—formerly `queue.h`—header file) is an adapter class. Recall that the `ostream_iterator` template is an adapter that allows an output stream to use the iterator interface. Similarly, the `queue` template allows an underlying class (`deque`, by default) to exhibit the typical `queue` interface.

The `queue` template is more restrictive than `deque`. Not only does it not permit random access to elements of a `queue`, the `queue` class doesn't even allow you to iterate through a `queue`. Instead, it limits you to the basic operations that define a `queue`. You can add an element to the rear of a `queue`, remove an element from the front of a `queue`, view the values of the front and rear elements, check the number of elements, and test to see if a `queue` is empty. Table 16.10 lists these operations.

Note that `pop()` is a data removal method, not a data retrieval method. If you want to use a value from a `queue`, you first use `front()` to retrieve the value and then use `pop()` to remove it from the `queue`.

Table 16.10 **queue Operations**

| Method                                 | Description                                                                                    |
|----------------------------------------|------------------------------------------------------------------------------------------------|
| <code>bool empty() const</code>        | Returns <code>true</code> if the <code>queue</code> is empty and <code>false</code> otherwise. |
| <code>size_type size() const</code>    | Returns the number of elements in the <code>queue</code> .                                     |
| <code>T&amp; front()</code>            | Returns a reference to the element at the front of the <code>queue</code> .                    |
| <code>T&amp; back()</code>             | Returns a reference to the element at the back of the <code>queue</code> .                     |
| <code>void push(const T&amp; x)</code> | Inserts <code>x</code> at the back of the <code>queue</code> .                                 |
| <code>void pop()</code>                | Removes the element at the front of the <code>queue</code> .                                   |

### **priority\_queue**

The `priority_queue` template class (declared in the `queue` header file) is another adapter class. It supports the same operations as `queue`. The main difference between the two is that with `priority_queue`, the largest item gets moved to the front of the `queue`. (Life is



not always fair, and neither are queues.) An internal difference is that the default underlying class is `vector`. You can alter the comparison used to determine what gets to the head of the queue by providing an optional constructor argument:

```
priority_queue<int> pq1; // default version
priority_queue<int> pq2(greater<int>); // use greater<int> to order
```

The `greater<>()` function is a predefined function object, and it is discussed later in this chapter.

### stack

Like `queue`, `stack` (declared in the `stack`—formerly `stack.h`—header file) is an adapter class. It gives an underlying class (`vector`, by default) the typical stack interface.

The `stack` template is more restrictive than `vector`. Not only does it not permit random access to elements of a stack, the `stack` class doesn't even allow you to iterate through a stack. Instead, it limits you to the basic operations that define a stack. You can push a value onto the top of a stack, pop an element from the top of a stack, view the value at the top of a stack, check the number of elements, and test whether the stack is empty. Table 16.11 lists these operations.

Table 16.11 **stack Operations**

| Method                                 | Description                                                                       |
|----------------------------------------|-----------------------------------------------------------------------------------|
| <code>bool empty() const</code>        | Returns <code>true</code> if the stack is empty and <code>false</code> otherwise. |
| <code>size_type size() const</code>    | Returns the number of elements in the stack.                                      |
| <code>T&amp; top()</code>              | Returns a reference to the element at the top of the stack.                       |
| <code>void push(const T&amp; x)</code> | Inserts <code>x</code> at the top of the stack.                                   |
| <code>void pop()</code>                | Removes the element at the top of the stack.                                      |

Much as with `queue`, if you want to use a value from a stack, you first use `top()` to retrieve the value, and then you use `pop()` to remove it from the stack.

### array (C++11)

The `array` template class, introduced in Chapter 4 and defined in the `array` header file, is not an STL container because it has a fixed size. Thus, operations that would resize a container, such as `push_back()` and `insert()`, are not defined for `array`. But those member functions that do make sense, such as `operator[]()` and `at()`, are provided. And you can use many standard STL algorithms, such as `copy()` and `for_each()`, with `array` objects.

## Associative Containers

An *associative container* is another refinement of the container concept. An associative container associates a value with a key and uses the key to find the value. For example, the values could be structures representing employee information, such as name, address, office number, home and work phones, health plan, and so on, and the key could be a

unique employee number. To fetch the employee information, a program would use the key to locate the employee structure. Recall that for a container `x`, in general, the expression `x::value_type` indicates the type of value stored in the container. For an associative container, the expression `x::key_type` indicates the type used for the key.

The strength of an associative container is that it provides rapid access to its elements. Like a sequence, an associative container allows you to insert new elements; however, you can't specify a particular location for the inserted elements. The reason is that an associative container usually has a particular algorithm for determining where to place data so that it can retrieve information quickly.

Associative containers typically are implemented using some form of tree. A *tree* is a data structure in which a root node is linked to one or two other nodes, each of which is linked to one or two nodes, thus forming a branching structure. The node aspect makes it relatively simple to add or remove a new data item, much as with a linked list. But compared to a list, a tree offers much faster search times.

The STL provides four associative containers: `set`, `multiset`, `map`, and `multimap`. The first two types are defined in the `set` header file (formerly separately in `set.h` and `multiset.h`), and the second two types are defined in the `map` header file (formerly separately in `map.h` and `multimap.h`).

The simplest of the bunch is `set`; the value type is the same as the key type, and the keys are unique, meaning there is no more than one instance of a key in a set. Indeed, for `set`, the value is the key. The `multiset` type is like the `set` type except that it can have more than one value with the same key. For example, if the key and value type are `int`, a `multiset` object could hold, say 1, 2, 2, 2, 3, 5, 7, and 7.

For the `map` type, the value type is different from the key type, and the keys are unique, with only one value per key. The `multimap` type is similar to `map`, except one key can be associated with multiple values.

There's too much information about these types to cover in this chapter (but Appendix G does list the methods), so let's just look at a simple example that uses `set` and a simple example that uses `multimap`.

## A set Example

The STL `set` models several concepts. It is an associative set, it is reversible, it is sorted, and the keys are unique, so it can hold no more than one of any given value. Like `vector` and `list`, `set` uses a template parameter to provide the type stored:

```
set<string> A; // a set of string objects
```

An optional second template argument can be used to indicate a comparison function or object to be used to order the key. By default, the `less<>` template (discussed later) is used. Older C++ implementations may not provide a default value and thus require an explicit template parameter:

```
set<string, less<string> > A; // older implementation
```

Consider the following code:

```
const int N = 6;
string s1[N] = {"buffoon", "thinkers", "for", "heavy", "can", "for"};
set<string> A(s1, s1 + N); // initialize set A using a range from array
ostream_iterator<string, char> out(cout, " ");
copy(A.begin(), A.end(), out);
```

Like other containers, `set` has a constructor (refer to Table 16.6) that takes a range of iterators as arguments. This provides a simple way to initialize a set to the contents of an array. Remember that the last element of a range is one past-the-end, and `s1 + N` points to one position past-the-end of array `s1`. The output for this code fragment illustrates that keys are unique (the string "for" appears twice in the array but once in the set) and that the set is sorted:

```
buffoon can for heavy thinkers
```

Mathematics defines some standard operations for sets. For example, the union of two sets is a set that combines the contents of the two sets. If a particular value is common to both sets, it appears just once in the union because of the unique key feature. The intersection of two sets is a set that consists of the elements that are common to both sets. The difference between two sets is the first set minus the elements common to both sets.

The STL provides algorithms that support these operations. They are general functions rather than methods, so they aren't restricted to `set` objects. However, all `set` objects automatically satisfy the precondition for using these algorithms—namely, that the container be sorted. The `set_union()` function takes five iterators as arguments. The first two define a range in one set, the second two define a range in a second set, and the final iterator is an output iterator that identifies a location to which to copy the resultant set. For example, to display the union of sets `A` and `B`, you can use this:

```
set_union(A.begin(), A.end(), B.begin(), B.end(),
          ostream_iterator<string, char> out(cout, " "));
```

Suppose you want to place the result into a set `C` instead of displaying it. In this case, you would want the last argument to be an iterator into `C`. The obvious choice is `C.begin()`, but that doesn't work for two reasons. The first reason is that associative sets treat keys as constant values, so the iterator returned by `C.begin()` is a constant iterator and can't be used as an output iterator. The second reason not to use `C.begin()` directly is that `set_union()`, like `copy()`, overwrites existing data in a container and requires the container to have sufficient space to hold the new information. `C`, being empty, does not satisfy that requirement. But the `insert_iterator` template discussed earlier solves both problems. Earlier you saw that it converts copying to insertion. Also it models the output iterator concept, so you can use it to write to a container. So you can construct an anonymous `insert_iterator` to copy information to `C`. The constructor, recall, takes the name of the container and an iterator as arguments:

```
set_union(A.begin(), A.end(), B.begin(), B.end(),
          insert_iterator<set<string> >(C, C.begin()));
```

The `set_intersection()` and `set_difference()` functions find the set intersection and set difference of two sets, and they have the same interface as `set_union()`.

Two useful set methods are `lower_bound()` and `upper_bound()`. The `lower_bound()` method takes a key-type value as its argument and returns an iterator that points to the first member of the set that is not less than the key argument. Similarly, the `upper_bound()` method takes a key as its argument and returns an iterator that points to the first member of the set that is greater than the key argument. For example, if you had a set of strings, you could use these methods to identify a range encompassing all strings from "b" up to "f" in the set.

Because sorting determines where additions to a set go, the class has insertion methods that just specify the material to be inserted, without specifying a position. If A and B are sets of strings, for example, you can use this:

```
string s("tennis");
A.insert(s); // insert a value
B.insert(A.begin(), A.end()); // insert a range
```

Listing 16.13 illustrates these uses of sets.

#### Listing 16.13 `setops.cpp`

---

```
// setops.cpp -- some set operations
#include <iostream>
#include <string>
#include <set>
#include <algorithm>
#include <iterator>

int main()
{
    using namespace std;
    const int N = 6;
    string s1[N] = {"buffoon", "thinkers", "for", "heavy", "can", "for"};
    string s2[N] = {"metal", "any", "food", "elegant", "deliver", "for"};

    set<string> A(s1, s1 + N);
    set<string> B(s2, s2 + N);

    ostream_iterator<string, char> out(cout, " ");
    cout << "Set A: ";
    copy(A.begin(), A.end(), out);
    cout << endl;
    cout << "Set B: ";
    copy(B.begin(), B.end(), out);
    cout << endl;
```

```

    cout << "Union of A and B:\n";
    set_union(A.begin(), A.end(), B.begin(), B.end(), out);
    cout << endl;

    cout << "Intersection of A and B:\n";
    set_intersection(A.begin(), A.end(), B.begin(), B.end(), out);
    cout << endl;

    cout << "Difference of A and B:\n";
    set_difference(A.begin(), A.end(), B.begin(), B.end(), out);
    cout << endl;

    set<string> C;
    cout << "Set C:\n";
    set_union(A.begin(), A.end(), B.begin(), B.end(),
        insert_iterator<set<string> >(C, C.begin()));
    copy(C.begin(), C.end(), out);
    cout << endl;

    string s3("grungy");
    C.insert(s3);
    cout << "Set C after insertion:\n";
    copy(C.begin(), C.end(), out);
    cout << endl;

    cout << "Showing a range:\n";
    copy(C.lower_bound("ghost"), C.upper_bound("spook"), out);
    cout << endl;

    return 0;
}

```

---

Here is the output of the program in Listing 16.13:

```

Set A: buffoon can for heavy thinkers
Set B: any deliver elegant food for metal
Union of A and B:
any buffoon can deliver elegant food for heavy metal thinkers
Intersection of A and B:
for
Difference of A and B:
buffoon can heavy thinkers
Set C:
any buffoon can deliver elegant food for heavy metal thinkers
Set C after insertion:
any buffoon can deliver elegant food for grungy heavy metal thinkers
Showing a range:
grungy heavy metal

```

Like most of the examples in this chapter, the code in Listing 16.13 takes the lazy route for handling the `std` namespace:

```
using namespace std;
```

It does so in order to simplify the presentation. The examples use so many elements of the `std` namespace that using directives or the scope-resolution operators would tend to make the code look a bit fussy:

```
std::set<std::string> B(s2, s2 + N);
std::ostream_iterator<std::string, char> out(std::cout, " ");
std::cout << "Set A: ";
std::copy(A.begin(), A.end(), out);
```

### A `multimap` Example

Like `set`, `multimap` is a reversible, sorted, associative container. However, with `multimap`, the key type is different from the value type, and a `multimap` object can have more than one value associated with a particular key.

The basic `multimap` declaration specifies the key type and the type of value, stored as template arguments. For example, the following declaration creates a `multimap` object that uses `int` as the key type and `string` as the type of value stored:

```
multimap<int, string> codes;
```

An optional third template argument can be used to indicate a comparison function or an object to be used to order the key. By default, the `less<>` template (discussed later) is used with the key type as its parameter. Older C++ implementations may require this template parameter explicitly.

To keep information together, the actual value type combines the key type and the data type into a single pair. To do this, the STL uses a `pair<class T, class U>` template class for storing two kinds of values in a single object. If `keytype` is the key type and `datatype` is the type of the stored data, the value type is `pair<const keytype, datatype>`. For example, the value type for the `codes` object declared earlier is `pair<const int, string>`.

Suppose that you want to store city names, using the area code as a key. This happens to fit the `codes` declaration, which uses an `int` for a key and a `string` as a data type. One approach is to create a `pair` and then insert it into the `multimap` object:

```
pair<const int, string> item(213, "Los Angeles");
codes.insert(item);
```

Or you can create an anonymous `pair` object and insert it in a single statement:

```
codes.insert(pair<const int, string> (213, "Los Angeles"));
```

Because items are sorted by key, there's no need to identify an insertion location.

Given a pair object, you can access the two components by using the `first` and `second` members:

```
pair<const int, string> item(213, "Los Angeles");
cout << item.first << ' ' << item.second << endl;
```

What about getting information about a multimap object? The `count()` member function takes a key as its argument and returns the number of items that have that key. The `lower_bound()` and `upper_bound()` member functions take a key and work as they do for `set`. Also the `equal_range()` member function takes a key as argument and returns iterators representing the range matching that key. In order to return two values, the method packages them into a pair object, this time with both template arguments being the iterator type. For example, the following would print a list of cities in the `codes` object with area code 718:

```
pair<multimap<KeyType, string>::iterator,
     multimap<KeyType, string>::iterator> range
    = codes.equal_range(718);
cout << "Cities with area code 718:\n";
std::multimap<KeyType, std::string>::iterator it;
for (it = range.first; it != range.second; ++it)
    cout << (*it).second << endl;
```

Declarations like those just listed helped motivate the C++11 automatic type deduction feature, which allows you to simplify the code as follows:

```
auto range = codes.equal_range(718);
cout << "Cities with area code 718:\n";
for (auto it = range.first; it != range.second; ++it)
    cout << (*it).second << endl;
```

Listing 16.14 demonstrates most of these techniques. It also uses `typedef` to simplify some of the code writing.

#### Listing 16.14 `multimap.cpp`

---

```
// multimap.cpp -- use a multimap
#include <iostream>
#include <string>
#include <map>
#include <algorithm>

typedef int KeyType;
typedef std::pair<const KeyType, std::string> Pair;
typedef std::multimap<KeyType, std::string> MapCode;

int main()
{
```

```

using namespace std;
MapCode codes;

codes.insert(Pair(415, "San Francisco"));
codes.insert(Pair(510, "Oakland"));
codes.insert(Pair(718, "Brooklyn"));
codes.insert(Pair(718, "Staten Island"));
codes.insert(Pair(415, "San Rafael"));
codes.insert(Pair(510, "Berkeley"));

cout << "Number of cities with area code 415: "
     << codes.count(415) << endl;
cout << "Number of cities with area code 718: "
     << codes.count(718) << endl;
cout << "Number of cities with area code 510: "
     << codes.count(510) << endl;
cout << "Area Code  City\n";
MapCode::iterator it;
for (it = codes.begin(); it != codes.end(); ++it)
    cout << "      " << (*it).first << "      "
         << (*it).second << endl;

pair<MapCode::iterator, MapCode::iterator> range
    = codes.equal_range(718);
cout << "Cities with area code 718:\n";
for (it = range.first; it != range.second; ++it)
    cout << (*it).second << endl;

return 0;
}

```

---

Here is the output of the program in Listing 16.14:

```

Number of cities with area code 415: 2
Number of cities with area code 718: 2
Number of cities with area code 510: 2
Area Code  City
  415      San Francisco
  415      San Rafael
  510      Oakland
  510      Berkeley
  718      Brooklyn
  718      Staten Island
Cities with area code 718:
Brooklyn
Staten Island

```



## Unordered Associative Containers (C++11)

An *unordered associative container* is yet another refinement of the container concept. Like an associative container, an unordered associative container associates a value with a key and uses the key to find the value. The underlying difference is that associative containers are based on tree structures, whereas unordered associative containers are based on another form of data structure called a *hash table*. The intent is to provide containers for which adding and deleting elements is relatively quick and for which there are efficient search algorithms. The four unordered associative containers are called `unordered_set`, `unordered_multiset`, `unordered_map`, and `unordered_multimap`. Appendix G looks a bit further at these additions.

## Function Objects (a.k.a. Functors)

Many STL algorithms use *function objects*, also known as *functors*. A *functor* is any object that can be used with `()` in the manner of a function. This includes normal function names, pointers to functions, and class objects for which the `()` operator is overloaded—that is, classes for which the peculiar-looking function operator `()()` is defined. For example, you could define a class like this:

```
class Linear
{
private:
    double slope;
    double y0;
public:
    Linear(double sl_ = 1, double y_ = 0)
        : slope(sl_), y0(y_) {}
    double operator()(double x) {return y0 + slope * x; }
};
```

The overloaded `()` operator then allows you to use `Linear` objects like functions:

```
Linear f1;
Linear f2(2.5, 10.0);
double y1 = f1(12.5); // right-hand side is f1.operator()(12.5)
double y2 = f2(0.4);
```

Here `y1` is calculated using the expression  $0 + 1 * 12.5$ , and `y2` is calculated using the expression  $10.0 + 2.5 * 0.4$ . In the expression `y0 + slope * x`, the values for `y0` and `slope` come from the constructor for the object, and the value of `x` comes from the argument to `operator()()`.

Remember the `for_each` function? It applied a specified function to each member of a range:

```
for_each(books.begin(), books.end(), ShowReview);
```

In general, the third argument could be a functor, not just a regular function. Actually, this raises a question: How do you declare the third argument? You can't declare it as a function pointer because a function pointer specifies the argument type. Because a container can contain just about any type, you don't know in advance what particular argument type should be used. The STL solves that problem by using templates. The `for_each` prototype looks like this:

```
template<class InputIterator, class Function>
Function for_each(InputIterator first, InputIterator last, Function f);
```

The `ShowReview()` prototype is this:

```
void ShowReview(const Review &);
```

This makes the identifier `ShowReview` have the type `void (*)(const Review &)`, so that is the type assigned to the template argument `Function`. With a different function call, the `Function` argument could represent a class type that has an overloaded `()` operator. Ultimately, the `for_each()` code will have an expression using `f()`. In the `ShowReview()` example, `f` is a pointer to a function, and `f()` invokes the function. If the final `for_each()` argument is an object, then `f()` becomes the object that invokes its overloaded `()` operator.

## Functor Concepts

Just as the STL defines concepts for containers and iterators, it defines functor concepts:

- A *generator* is a functor that can be called with no arguments.
- A *unary function* is a functor that can be called with one argument.
- A *binary function* is a functor that can be called with two arguments.

For example, the functor supplied to `for_each()` should be a unary function because it is applied to one container element at a time.

Of course, these concepts come with refinements:

- A unary function that returns a `bool` value is a *predicate*.
- A binary function that returns a `bool` value is a *binary predicate*.

Several STL functions require predicate or binary predicate arguments. For example, Listing 16.9 uses a version of `sort()` that takes a binary predicate as its third argument:

```
bool WorseThan(const Review & r1, const Review & r2);
...
sort(books.begin(), books.end(), WorseThan);
```

The `list` template has a `remove_if()` member that takes a predicate as an argument. It applies the predicate to each member in the indicated range, removing those elements for which the predicate returns `true`. For example, the following code would remove all elements greater than 100 from the list `three`:

```
bool tooBig(int n){ return n > 100; }
list<int> scores;
...
scores.remove_if(tooBig);
```

Incidentally, this last example shows where a class functor might be useful. Suppose you want to remove every value greater than 200 from a second list. It would be nice if you could pass the cut-off value to `tooBig()` as a second argument so you could use the function with different values, but a predicate can have but one argument. If, however, you design a `TooBig` class, you can use class members instead of function arguments to convey additional information:

```
template<class T>
class TooBig
{
private:
    T cutoff;
public:
    TooBig(const T & t) : cutoff(t) {}
    bool operator()(const T & v) { return v > cutoff; }
};
```

Here one value ( $v$ ) is passed as a function argument, and the second argument (`cutoff`) is set by the class constructor. Given this definition, you can initialize different `TooBig` objects to different cut-off values to be used in calls to `remove_if()`. Listing 16.15 illustrates the technique.

---

#### Listing 16.15 `functor.cpp`

```
// functor.cpp -- using a functor
#include <iostream>
#include <list>
#include <iterator>
#include <algorithm>

template<class T> // functor class defines operator()()
class TooBig
{
private:
    T cutoff;
public:
    TooBig(const T & t) : cutoff(t) {}
    bool operator()(const T & v) { return v > cutoff; }
};

void outint(int n) {std::cout << n << " " ;}
```

```

int main()
{
    using std::list;
    using std::cout;
    using std::endl;

    TooBig<int> f100(100); // limit = 100
    int vals[10] = {50, 100, 90, 180, 60, 210, 415, 88, 188, 201};
    list<int> yadayada(vals, vals + 10); // range constructor
    list<int> etcetera(vals, vals + 10);
    // C++11 can use the following instead
    // list<int> yadayada = {50, 100, 90, 180, 60, 210, 415, 88, 188, 201};
    // list<int> etcetera {50, 100, 90, 180, 60, 210, 415, 88, 188, 201};
    cout << "Original lists:\n";
    for_each(yadayada.begin(), yadayada.end(), outint);
    cout << endl;
    for_each(etcetera.begin(), etcetera.end(), outint);
    cout << endl;
    yadayada.remove_if(f100); // use a named function object
    etcetera.remove_if(TooBig<int>(200)); // construct a function object
    cout << "Trimmed lists:\n";
    for_each(yadayada.begin(), yadayada.end(), outint);
    cout << endl;
    for_each(etcetera.begin(), etcetera.end(), outint);
    cout << endl;
    return 0;
}

```

---

One functor (`f100`) is a declared object, and the second (`TooBig<int>(200)`) is an anonymous object created by a constructor call. Here's the output of the program in Listing 16.15:

```

Original lists:
50 100 90 180 60 210 415 88 188 201
50 100 90 180 60 210 415 88 188 201
Trimmed lists:
50 100 90 60 88
50 100 90 180 60 88 188

```

Suppose that you already have a template function with two arguments:

```

template <class T>
bool tooBig(const T & val, const T & lim)
{
    return val > lim;
}

```

You can use a class to convert it to a one-argument function object:

```
template<class T>
class TooBig2
{
private:
    T cutoff;
public:
    TooBig2(const T & t) : cutoff(t) {}
    bool operator()(const T & v) { return tooBig<T>(v, cutoff); }
};
```

That is, you can use the following:

```
TooBig2<int> tB100(100);
int x;
cin >> x;
if (tB100(x)) // same as if (tooBig(x,100))
    ...
```

So the call `tB100(x)` is the same as `tooBig(x, 100)`, but the two-argument function is converted to a one-argument function object, with the second argument being used to construct the function object. In short, the class functor `TooBig2` is a function adapter that adapts a function to meet a different interface.

As noted in the listing, C++11's initializer-list feature simplifies initialization. You can replace

```
int vals[10] = {50, 100, 90, 180, 60, 210, 415, 88, 188, 201};
list<int> yadayada(vals, vals + 10); // range constructor
list<int> etcetera(vals, vals + 10);
```

with this:

```
list<int> yadayada = {50, 100, 90, 180, 60, 210, 415, 88, 188, 201};
list<int> etcetera {50, 100, 90, 180, 60, 210, 415, 88, 188, 201};
```

## Predefined Functors

The STL defines several elementary functors. They perform actions such as adding two values and comparing two values for equality. They are provided to help support STL functions that take functions as arguments. For example, consider the `transform()` function. It has two versions. The first version takes four arguments. The first two arguments are iterators that specify a range in a container. (By now you must be familiar with that approach.) The third is an iterator that specifies where to copy the result. The final is a functor that is applied to each element in the range to produce each new element in the result. For example, consider the following:

```
const int LIM = 5;
double arr1[LIM] = {36, 39, 42, 45, 48};
```

```
vector<double> gr8(arr1, arr1 + LIM);
ostream_iterator<double, char> out(cout, " ");
transform(gr8.begin(), gr8.end(), out, sqrt);
```

This code calculates the square root of each element and sends the resulting values to the output stream. The destination iterator can be in the original range. For example, replacing `out` in this example with `gr8.begin()` would copy the new values over the old values. Clearly, the functor used must be one that works with a single argument.

The second version uses a function that takes two arguments, applying the function to one element from each of two ranges. It takes an additional argument, which comes third in order, identifying the start of the second range. For example, if `m8` were a second `vector<double>` object and if `mean(double, double)` returned the mean of two values, the following would output the average of each pair of values from `gr8` and `m8`:

```
transform(gr8.begin(), gr8.end(), m8.begin(), out, mean);
```

Now suppose you want to add the two arrays. You can't use `+` as an argument because, for type `double`, `+` is a built-in operator, not a function. You could define a function to add two numbers and use it:

```
double add(double x, double y) { return x + y; }
...
transform(gr8.begin(), gr8.end(), m8.begin(), out, add);
```

But then you'd have to define a separate function for each type. It would be better to define a template, except that you don't have to because the STL already has. The `functional` (formerly `function.h`) header defines several template class function objects, including one called `plus<>()`.

Using the `plus<>` class for ordinary addition is possible, if awkward:

```
#include <functional>
...
plus<double> add; // create a plus<double> object
double y = add(2.2, 3.4); // using plus<double>::operator()()
```

But it makes it easy to provide a function object as an argument:

```
transform(gr8.begin(), gr8.end(), m8.begin(), out, plus<double>());
```

Here, rather than create a named object, the code uses the `plus<double>` constructor to construct a functor to do the adding. (The parentheses indicate calling the default constructor; what's passed to `transform()` is the constructed function object.)

The STL provides functor equivalents for all the built-in arithmetic, relational, and logical operators. Table 16.12 shows the names for these functor equivalents. They can be used with the C++ built-in types or with any user-defined type that overloads the corresponding operator.

Table 16.12 Operators and Functor Equivalents

| Operator | Functor Equivalent |
|----------|--------------------|
| +        | plus               |
| -        | minus              |
| *        | multiplies         |
| /        | divides            |
| %        | modulus            |
| -        | negate             |
| ==       | equal_to           |
| !=       | not_equal_to       |
| >        | greater            |
| <        | less               |
| >=       | greater_equal      |
| <=       | less_equal         |
| &&       | logical_and        |
|          | logical_or         |
| !        | logical_not        |

**Caution**

Older C++ implementations use the functor name `times` instead of `multiplies`.

**Adaptable Functors and Function Adapters**

The predefined functors in Table 16.12 are all *adaptable*. Actually, the STL has five related concepts: adaptable generators, adaptable unary functions, adaptable binary functions, adaptable predicates, and adaptable binary predicates.

What makes a functor adaptable is that it carries `typedef` members identifying its argument types and return type. The members are called `result_type`, `first_argument_type`, and `second_argument_type`, and they represent what they sound like. For example, the return type of a `plus<int>` object is identified as `plus<int>::result_type`, and this would be a `typedef` for `int`.

The significance of a functor being adaptable is that it can then be used by function adapter objects, which assume the existence of these `typedef` members. For example, a function with an argument that is an adaptable functor can use the `result_type` member to declare a variable that matches the function's return type.

Indeed, the STL provides function adapter classes that use these facilities. For example, suppose you want to multiply each element of the vector `gr8` by 2.5. That calls for using the `transform()` version with a unary function argument, like the example shown earlier:

```
transform(gr8.begin(), gr8.end(), out, sqrt);
```

The `multiplies()` functor can do the multiplication, but it's a binary function. So you need a function adapter that converts a functor that has two arguments to one that has one argument. The earlier `TooBig2` example shows one way, but the STL has automated the process with the `binder1st` and `binder2nd` classes, which convert adaptable binary functions to adaptable unary functions.

Let's look at `binder1st`. Suppose you have an adaptable binary function object `f2()`. You can create a `binder1st` object that binds a particular value, called `val`, to be used as the first argument to `f2()`:

```
binder1st(f2, val) f1;
```

Then, invoking `f1(x)` with its single argument returns the same value as invoking `f2()` with `val` as its first argument and `f1()`'s argument as its second argument. That is, `f1(x)` is equivalent to `f2(val, x)`, except that it is a unary function instead of a binary function. The `f2()` function has been adapted. Again, this is possible only if `f2()` is an adaptable function.

This might seem a bit awkward. However, the STL provides the `bind1st()` function to simplify using the `binder1st` class. You give it the function name and value used to construct a `binder1st` object, and it returns an object of that type. For example, you can convert the binary function `multiplies()` to a unary function that multiplies its argument by 2.5. Just do this:

```
bind1st(multiplies<double>(), 2.5)
```

Thus, the solution to multiplying every element in `gr8` by 2.5 and displaying the results is this:

```
transform(gr8.begin(), gr8.end(), out,
         bind1st(multiplies<double>(), 2.5));
```

The `binder2nd` class is similar, except that it assigns the constant to the second argument instead of to the first. It has a helper function called `bind2nd` that works analogously to `bind1st`.



Listing 16.16 incorporates some of the recent examples into a short program.

Listing 16.16 `funadap.cpp`

---

```
// funadap.cpp -- using function adapters
#include <iostream>
#include <vector>
#include <iterator>
#include <algorithm>
#include <functional>

void Show(double);
const int LIM = 6;
int main()
{
    using namespace std;
    double arr1[LIM] = {28, 29, 30, 35, 38, 59};
    double arr2[LIM] = {63, 65, 69, 75, 80, 99};
    vector<double> gr8(arr1, arr1 + LIM);
    vector<double> m8(arr2, arr2 + LIM);
    cout.setf(ios_base::fixed);
    cout.precision(1);
    cout << "gr8:\t";
    for_each(gr8.begin(), gr8.end(), Show);
    cout << endl;
    cout << "m8: \t";
    for_each(m8.begin(), m8.end(), Show);
    cout << endl;

    vector<double> sum(LIM);
    transform(gr8.begin(), gr8.end(), m8.begin(), sum.begin(),
              plus<double>());
    cout << "sum:\t";
    for_each(sum.begin(), sum.end(), Show);
    cout << endl;

    vector<double> prod(LIM);
    transform(gr8.begin(), gr8.end(), prod.begin(),
              bind1st(multiplies<double>(), 2.5));
    cout << "prod:\t";
    for_each(prod.begin(), prod.end(), Show);
    cout << endl;

    return 0;
}
```

```

void Show(double v)
{
    std::cout.width(6);
    std::cout << v << ' ';
}

```

---

Here is the output of the program in Listing 16.16:

```

gr8:      28.0   29.0   30.0   35.0   38.0   59.0
m8:       63.0   65.0   69.0   75.0   80.0   99.0
sum:      91.0   94.0   99.0  110.0  118.0  158.0
prod:     70.0   72.5   75.0   87.5   95.0  147.5

```

C++11 provides an alternative to function pointers and functors. It's called a *lambda expression*, another topic discussed in Chapter 18.

## Algorithms

The STL contains many nonmember functions for working with containers. You've seen a few of them already: `sort()`, `copy()`, `find()`, `for_each()`, `random_shuffle()`, `set_union()`, `set_intersection()`, `set_difference()`, and `transform()`. You've probably noticed that they feature the same overall design, using iterators to identify data ranges to be processed and to identify where results are to go. Some also take a function object argument to be used as part of the data processing.

There are two main generic components to the algorithm function designs. First, they use templates to provide generic types. Second, they use iterators to provide a generic representation for accessing data in a container. Thus, the `copy()` function can work with a container that holds type `double` values in an array, with a container that holds `string` values in a linked list, or with a container that stores user-defined objects in a tree structure, such as is used by `set`. Because pointers are a special case of iterators, STL functions such as `copy()` can be used with ordinary arrays.

The uniform container design allows meaningful relationships between containers of different kinds. For example, you can use `copy()` to copy values from an ordinary array to a `vector` object, from a `vector` object to a `list` object, and from a `list` object to a `set` object. You can use `==` to compare different kinds of containers—for example, `deque` and `vector`. This is possible because the overloaded `==` operator for containers uses iterators to compare contents, so a `deque` object and a `vector` object test as equal if they have the same content in the same order.

### Algorithm Groups

The STL divides the algorithm library into four groups:

- Nonmodifying sequence operations
- Mutating sequence operations

- Sorting and related operations
- Generalized numeric operations

The first three groups are described in the `algorithm` (formerly `algo.h`) header file, and the fourth group, being specifically oriented toward numeric data, gets its own header file, called `numeric`. (Formerly, they, too, were in `algo.h`.)

Nonmodifying sequence operations operate on each element in a range. These operations leave a container unchanged. For example, `find()` and `for_each()` belong to this category.

Mutating sequence operations also operate on each element in a range. As the name suggests, however, they can mutate, or change, the contents of a container. The change could be in values or in the order in which the values are stored. The `transform()`, `random_shuffle()`, and `copy()` functions fall into this category.

Sorting and related operations include several sorting functions (including `sort()`) and a variety of other functions, including the set operations.

The numeric operations include functions to sum the contents of a range, calculate the inner product of two containers, calculate partial sums, and calculate adjacent differences. Typically, these are operations that are characteristic of arrays, so `vector` is the container most likely to be used with them.

Appendix G provides a complete summary of these functions.

## General Properties of Algorithms

As you've seen again and again in this chapter, STL functions work with iterators and iterator ranges. The function prototype indicates the assumptions made about the iterators. For example, the `copy()` function has this prototype:

```
template<class InputIterator, class OutputIterator>
OutputIterator copy(InputIterator first, InputIterator last,
                   OutputIterator result);
```

Because the identifiers `InputIterator` and `OutputIterator` are template parameters, they just as easily could have been `T` and `U`. However, the STL documentation uses the template parameter names to indicate the concept that the parameter models. So this declaration tells you that the range parameters must be input iterators or better and that the iterator indicating where the result goes must be an output parameter or better.

One way of classifying algorithms is on the basis of where the result of the algorithm is placed. Some algorithms do their work in place, and others create copies. For example, when the `sort()` function is finished, the result occupies the same location that the original data did. So `sort()` is an *in-place algorithm*. The `copy()` function, however, sends the result of its work to another location, so it is a *copying algorithm*. The `transform()` function can do both. Like `copy()`, it uses an output iterator to indicate where the results go. Unlike `copy()`, `transform()` allows the output iterator to point to a location in the input range, so it can copy the transformed values over the original values.

Some algorithms come in two versions: an in-place version and a copying version. The STL convention is to append `_copy` to the name of the copying version. The latter version takes an additional output iterator parameter to specify the location to which to copy the outcome. For example, there is a `replace()` function that has this prototype:

```
template<class ForwardIterator, class T>
void replace(ForwardIterator first, ForwardIterator last,
             const T& old_value, const T& new_value);
```

It replaces each instance of `old_value` with `new_value`. This occurs in place. Because this algorithm both reads from and writes to container elements, the iterator type has to be `ForwardIterator` or better. The copying version has this prototype:

```
template<class InputIterator, class OutputIterator, class T>
OutputIterator replace_copy(InputIterator first, InputIterator last,
                           OutputIterator result,
                           const T& old_value, const T& new_value);
```

This time the resulting data is copied to a new location, given by `result`, so the read-only input iterator is sufficient for specifying the range.

Note that `replace_copy()` has an `OutputIterator` return type. The convention for copying algorithms is that they return an iterator pointing to the location one past the last value copied.

Another common variation is that some functions have a version that performs an action conditionally, depending on the result of applying a function to a container element. These versions typically append `_if` to the function name. For example, `replace_if()` replaces an old value with a new value if applying a function to the old value returns the value `true`. Here's the prototype:

```
template<class ForwardIterator, class Predicate class T>
void replace_if(ForwardIterator first, ForwardIterator last,
               Predicate pred, const T& new_value);
```

(Recall that a predicate is a unary function that returns a `bool` value.) There's also a version called `replace_copy_if()`. You can probably figure out what it does and what its prototype is like.

As with `InputIterator`, `Predicate` is a template parameter name and could just as easily be called `T` or `U`. However, the STL chooses to use `Predicate` to remind the user that the actual argument should be a model of the `Predicate` concept. Similarly, the STL uses terms such as `Generator` and `BinaryPredicate` to identify arguments that should model other function object concepts. Keep in mind that although the documentation can remind you what the iterator or functor requirements are, these names are not something the compiler can check. If you use the wrong sort of iterator, you can expect to see a long list of error messages as the compiler tries to instantiate the template.

## The STL and the string Class

The `string` class, although not part of the STL, is designed with the STL in mind. For example, it has `begin()`, `end()`, `rbegin()`, and `rend()` members. Thus, it can use the STL interface. Listing 16.17 uses the STL to show all the permutations you can form from the letters in a word. A *permutation* is a rearrangement of the order of the elements in a container. The `next_permutation()` algorithm transforms the contents of a range to the next permutation; in the case of a string, the permutations are arranged in ascending alphabetical order. The algorithm returns `true` if it succeeds and `false` if the range already is in the final sequence. To get all the permutations of a range, you should start with the elements in the earliest possible order, and the program uses the STL `sort()` algorithm for that purpose.

Listing 16.17 `strgstl.cpp`

---

```
// strgstl.cpp -- applying the STL to a string
#include <iostream>
#include <string>
#include <algorithm>

int main()
{
    using namespace std;
    string letters;
    cout << "Enter the letter grouping (quit to quit): ";
    while (cin >> letters && letters != "quit")
    {
        cout << "Permutations of " << letters << endl;
        sort(letters.begin(), letters.end());
        cout << letters << endl;
        while (next_permutation(letters.begin(), letters.end()))
            cout << letters << endl;
        cout << "Enter next sequence (quit to quit): ";
    }
    cout << "Done.\n";
    return 0;
}
```

---

Here's a sample run of the program in Listing 16.17:

```
Enter the letter grouping (quit to quit): awl
Permutations of awl
awl
awl
law
lwa
wal
```

```
wla
Enter next sequence (quit to quit): all
Permutations of all
all
lal
lla
Enter next sequence (quit to quit): quit
Done.
```

Note that the `next_permutation()` algorithm automatically provides only unique permutations, which is why the output shows more permutations for the word *awl* than for the word *all*, which has duplicate letters.

## Functions Versus Container Methods

Sometimes you have a choice between using an STL method and an STL function. Usually, the method is the better choice. First, it should be better optimized for a particular container. Second, being a member function, it can use a template class's memory management facilities and resize a container when needed.

Suppose, for example, that you have a list of numbers and you want to remove all instances of a certain value, say 4, from the list. If `la` is a `list<int>` object, you can use the `list::remove()` method:

```
la.remove(4); // remove all 4s from the list
```

After this method call, all elements with the value 4 are removed from the list, and the list is automatically resized.

There is also an STL algorithm called `remove()` (see Appendix G). Instead of being invoked by an object, it takes range arguments. So if `lb` is a `list<int>` object, a call to the function could look like this:

```
remove(lb.begin(), lb.end(), 4);
```

However, because this `remove()` is not a member, it can't adjust the size of the list. Instead, it makes sure all the nonremoved items are at the beginning of the list, and it returns an iterator to the new past-the-end value. You can then use this iterator to fix the list size. For example, you can use the `list::erase()` method to remove a range that describes the part of the list that is no longer needed. Listing 16.18 shows how this process works.

### Listing 16.18 `listrmv.cpp`

---

```
// listrmv.cpp -- applying the STL to a string
#include <iostream>
#include <list>
#include <algorithm>
```

```

void Show(int);
const int LIM = 10;
int main()
{
    using namespace std;
    int ar[LIM] = {4, 5, 4, 2, 2, 3, 4, 8, 1, 4};
    list<int> la(ar, ar + LIM);
    list<int> lb(la);
    cout << "Original list contents:\n\t";
    for_each(la.begin(), la.end(), Show);
    cout << endl;
    la.remove(4);
    cout << "After using the remove() method:\n";
    cout << "la:\t";
    for_each(la.begin(), la.end(), Show);
    cout << endl;
    list<int>::iterator last;
    last = remove(lb.begin(), lb.end(), 4);
    cout << "After using the remove() function:\n";
    cout << "lb:\t";
    for_each(lb.begin(), lb.end(), Show);
    cout << endl;
    lb.erase(last, lb.end());
    cout << "After using the erase() method:\n";
    cout << "lb:\t";
    for_each(lb.begin(), lb.end(), Show);
    cout << endl;
    return 0;
}

void Show(int v)
{
    std::cout << v << ' ';
}

```

---

Here's the output of the program in Listing 16.18:

```

Original list contents:
    4 5 4 2 2 3 4 8 1 4
After using the remove() method:
la: 5 2 2 3 8 1
After using the remove() function:
lb: 5 2 2 3 8 1 4 8 1 4
After using the erase() method:
lb: 5 2 2 3 8 1

```

As you can see, the `remove()` method reduces the list `1a` from 10 elements to 6 elements. However, list `1b` still contains 10 elements after the `remove()` function is applied to it. The last 4 elements are disposable because each is either the value 4 or a duplicate of a value moved farther to the front of the list.

Although the methods are usually better suited, the nonmethod functions are more general. As you've seen, you can use them on arrays and `string` objects as well as STL containers, and you can use them with mixed container types—for example, to save data from a vector container to a list or a set.

## Using the STL

The STL is a library whose parts are designed to work together. The STL components are tools, but they are also building blocks to create other tools. Let's illustrate this with an example. Suppose you want to write a program that lets the user enter words. At the end, you'd like a record of the words as they were entered, an alphabetical list of the words used (capitalization differences ignored), and a record of how many times each word was entered. To keep things simple, let's assume that the input contains no numbers or punctuation.

Entering and saving the list of words is simple enough. Following the example of Listings 16.8 and 16.9, you can create a `vector<string>` object and use `push_back()` to add input words to the vector:

```
vector<string> words;
string input;
while (cin >> input && input != "quit")
    words.push_back(input);
```

What about getting the alphabetic word list? You can use `sort()` followed by `unique()`, but that approach overwrites the original data because `sort()` is an in-place algorithm. There is an easier way that avoids this problem. You can create a `set<string>` object and copy (using an insert iterator) the words from the vector to the set. A set automatically sorts its contents, which means you don't have to call `sort()`, and a set allows only one copy of a key, so that takes the place of calling `unique()`. Wait! The specification called for ignoring the case differences. One way to handle that is to use `transform()` instead of `copy()` to copy data from the vector to the set. For the transformation function, you can use one that converts a string to lowercase:

```
set<string> wordset;
transform(words.begin(), words.end(),
    insert_iterator<set<string> > (wordset, wordset.begin()), ToLower);
```

The `ToLower()` function is easy to write. You just use `transform()` to apply the `tolower()` function to each element in the string, using the string both as source and destination. Remember, `string` objects, too, can use the STL functions. Passing and returning the string as a reference means the algorithm works on the original string without having to make copies. Here's the code for `ToLower()`:



```
string & ToLower(string & st)
{
    transform(st.begin(), st.end(), st.begin(), tolower);
    return st;
}
```

One possible problem is that the `tolower()` function is defined as `int tolower(int)`, and some compilers want the function to match the element type, which is `char`. One solution is to replace `tolower` with `toLowerCase` and to provide the following definition:

```
char toLowerCase(char ch) { return tolower(ch); }
```

To get the number of times each word appears in the input, you can use the `count()` function. It takes a range and a value as arguments, and it returns the number of times the value appears in the range. You can use the `vector` object to provide the range and the `set` object to provide the list of words to count. That is, for each word in the set, you can count how many times it appears in the vector. To keep the resulting count associated with the correct word, you can store the word and the count as a `pair<const string, int>` object in a `map` object. The word will be the key (just one copy), and the count will be the value. This can be done in a single loop:

```
map<string, int> wordmap;
set<string>::iterator si;
for (si = wordset.begin(); si != wordset.end(); si++)
    wordmap.insert(pair<string, int>(*si, count(words.begin(),
        words.end(), *si)));
```

The `map` class has an interesting feature: You can use array notation with keys that serve as indexes to access the stored values. For example, `wordmap["the"]` would represent the value associated with the key "the", which in this case is the number of occurrences of the string "the". Because the `wordset` container holds all the keys used by `wordmap`, you can use the following code as an alternative and more attractive way of storing results:

```
for (si = wordset.begin(); si != wordset.end(); si++)
    wordmap[*si] = count(words.begin(), words.end(), *si);
```

Because `si` points to a string in the `wordset` container, `*si` is a string and can serve as a key for `wordmap`. This code places both keys and values into the `wordmap` map.

Similarly, you can use the array notation to report results:

```
for (si = wordset.begin(); si != wordset.end(); si++)
    cout << *si << ": " << wordmap[*si] << endl;
```

If a key is invalid, the corresponding value is 0.

Listing 16.19 puts these ideas together and includes code to display the contents of the three containers (a vector with the input, a set with a word list, and a map with a word count).

## Listing 16.19 usealgo.cpp

---

```

//usealgo.cpp -- using several STL elements
#include <iostream>
#include <string>
#include <vector>
#include <set>
#include <map>
#include <iterator>
#include <algorithm>
#include <cctype>
using namespace std;

char toLower(char ch) { return tolower(ch); }
string & ToLower(string & st);
void display(const string & s);

int main()
{
    vector<string> words;
    cout << "Enter words (enter quit to quit):\n";
    string input;
    while (cin >> input && input != "quit")
        words.push_back(input);

    cout << "You entered the following words:\n";
    for_each(words.begin(), words.end(), display);
    cout << endl;

    // place words in set, converting to lowercase
    set<string> wordset;
    transform(words.begin(), words.end(),
        insert_iterator<set<string> > (wordset, wordset.begin()),
        ToLower);
    cout << "\nAlphabetic list of words:\n";
    for_each(wordset.begin(), wordset.end(), display);
    cout << endl;

    // place word and frequency in map
    map<string, int> wordmap;
    set<string>::iterator si;
    for (si = wordset.begin(); si != wordset.end(); si++)
        wordmap[*si] = count(words.begin(), words.end(), *si);

    // display map contents
    cout << "\nWord frequency:\n";

```

```

    for (si = wordset.begin(); si != wordset.end(); si++)
        cout << *si << ": " << wordmap[*si] << endl;

    return 0;
}

string & ToLower(string & st)
{
    transform(st.begin(), st.end(), st.begin(), toLower);
    return st;
}

void display(const string & s)
{
    cout << s << " ";
}

```

---

Here is a sample run of the program in Listing 16.19:

```

Enter words (enter quit to quit):
The dog saw the cat and thought the cat fat
The cat thought the cat perfect
quit
You entered the following words:
The dog saw the cat and thought the cat fat The cat thought the cat perfect

Alphabetic list of words:
and cat dog fat perfect saw the thought

Word frequency:
and: 1
cat: 4
dog: 1
fat: 1
perfect: 1
saw: 1
the: 5
thought: 2

```

The moral here is that your attitude when using the STL should be to avoid writing as much code as possible. STL's generic and flexible design should save you lots of work. Also the STL designers are algorithm people who are very much concerned with efficiency. So the algorithms are well chosen and inline.

## Other Libraries

C++ provides some other class libraries that are more specialized than the examples covered so far in this chapter. For instance, the `complex` header file provides a `complex` class template for complex numbers, with specializations for `float`, `long`, and `long double`. The class provides standard complex number operations, along with standard functions that can be used with complex numbers. The C++11 `random` header file extends random number functionality.

Chapter 14 introduced another example, the `valarray` template class, supported by the `valarray` header file. This class template is designed to represent numeric arrays and provides support for a variety of numeric array operations, such as adding the contents of one array to another, applying math functions to each element of an array and applying linear algebra operations to arrays.

### vector, valarray, and array

Perhaps you are wondering why C++ has three array templates: `vector`, `valarray`, and `array`. These classes were developed by different groups for different purposes. The `vector` template class is part of a system of container classes and algorithms. The `vector` class supports container-oriented activities, such as sorting, insertion, rearrangement, searching, transferring data to other containers, and other manipulations. The `valarray` class template, on the other hand, is oriented toward numeric computation, and it is not part of the STL. It doesn't have `push_back()` and `insert()` methods, for example, but it does provide a simple, intuitive interface for many mathematical operations. Finally, `array` is designed as a substitute for the built-in array type, combining the compactness and efficiency of that type with a better, safer interface. Being of fixed size, `array` doesn't support `push_back()` and `insert()`, but it does offer several other STL methods. These include `begin()`, `end()`, `rbegin()`, and `rend()`, making it easy to apply STL algorithms to array objects.

Suppose, for example, that you have these declarations:

```
vector<double> ved1(10), ved2(10), ved3(10);
array<double, 10> vod1, vod2, vod3;
valarray<double> vad1(10), vad2(10), vad3(10);
```

Furthermore, assume that `ved1`, `ved2`, `vod1`, `vod2`, `vad1`, and `vad2` all acquire suitable values. Suppose you want to assign the sum of the first elements of two arrays to the first element of a third array, and so on. With the `vector` class, you would do this:

```
transform(ved1.begin(), ved1.end(), ved2.begin(), ved3.begin(),
         plus<double>());
```

You can do the same with the `array` class:

```
transform(vod1.begin(), vod1.end(), vod2.begin(), vod3.begin(),
         plus<double>());
```

However, the `valarray` class overloads all the arithmetic operators to work with `valarray` objects, so you would use this:

```
vad3 = vad1 + vad2;    // + overloaded
```

Similarly, the following would result in each element of `vad3` being the product of the corresponding elements in `vad1` and `vad2`:

```
vad3 = vad1 * vad2;    // * overloaded
```

Suppose you want to replace every value in an array with that value multiplied by 2.5. The STL approach is this:

```
transform(vad3.begin(), vad3.end(), vad3.begin(),
          bind1st(multiplies<double>(), 2.5));
```

The `valarray` class overloads multiplying a `valarray` object by a single value, and it also overloads the various computed assignment operators, so you could use either of the following:

```
vad3 = 2.5 * vad3;    // * overloaded
vad3 *= 2.5;         // *= overloaded
```

Suppose you want to take the natural logarithm of every element of one array and store the result in the corresponding element of a second array. The STL approach is this:

```
transform(vad1.begin(), vad1.end(), vad3.begin(),
          log);
```

The `valarray` class overloads the usual math functions to take a `valarray` argument and to return a `valarray` object, so you can use this:

```
vad3 = log(vad1);    // log() overloaded
```

Or you could use the `apply()` method, which also works for non-overloaded functions:

```
vad3 = vad1.apply(log);
```

The `apply()` method doesn't alter the invoking object; instead, it returns a new object that contains the resulting values.

The simplicity of the `valarray` interface is even more apparent when you do a multi-step calculation:

```
vad3 = 10.0 * ((vad1 + vad2) / 2.0 + vad1 * cos(vad2));
```

The `vector`-STL version is left as an exercise for the motivated reader.

The `valarray` class also provides a `sum()` method that sums the contents of a `valarray` object, a `size()` method that returns the number of elements, a `max()` method that returns the largest value in an object, and a `min()` method that returns the smallest value.

As you can see, `valarray` has a clear notational advantage over `vector` for mathematical operations, but it is also much less versatile. The `valarray` class does have a `resize()`

method, but there's no automatic resizing of the sort you get when you use the `vector::push_back()` method. There are no methods for inserting values, searching, sorting, and the like. In short, the `valarray` class is more limited than the `vector` class, but its narrower focus allows a much simpler interface.

Does the simpler interface that `valarray` provides translate to better performance? In most cases, no. The simple notation is typically implemented with the same sort of loops you would use with ordinary arrays. However, some hardware designs allow vector operations in which the values in an array are loaded simultaneously into an array of registers and then processed simultaneously. In principle, `valarray` operations could be implemented to take advantage of such designs.

Can you use the STL with `valarray` objects? Answering this question provides a quick review of some STL principles. Suppose you have a `valarray<double>` object that has 10 elements:

```
valarray<double> vad(10);
```

After the array has been filled with numbers, can you, say, use the STL sort function on it? The `valarray` class doesn't have `begin()` and `end()` methods, so you can't use them as the range arguments:

```
sort(vad.begin(), vad.end()); // NO, no begin(), end()
```

Also `vad` is an object, not a pointer, so you can't imitate ordinary array usage and provide `vad` and `vad + 10`, as the following code attempts to do:

```
sort(vad, vad + 10); // NO, vad an object, not an address
```

You can use the address operator:

```
sort(&vad[0], &vad[10]); // maybe?
```

But the behavior of using a subscript one past the end is undefined for `valarray`. This doesn't necessarily mean using `&vad[10]` won't work. (In fact, it did work for all six compilers used to test this code.) But it does mean that it might not work. For the code to fail, you probably would need a very unlikely circumstance, such as the array being butted against the end of the block of memory set aside for the heap. But, if a \$385-million mission depended on your code, you might not want to risk that failure.

C++11 remedies the situation by providing `begin()` and `end()` template functions that take a `valarray` object as an argument. So you would use `begin(vad)` instead of `vad.begin()`. These functions return values that are compatible with STL range requirements:

```
sort(begin(vad), end(vad)); // C++11 fix!
```

Listing 16.20 illustrates some of the relative strengths of the `vector` and `valarray` classes. It uses `push_back()` and the automatic sizing feature of `vector` to collect data. Then after sorting the numbers, the program copies them from the `vector` object to a `valarray` object of the same size and does a few math operations.

Listing 16.20 `valvect.cpp`

---

```

// valvect.cpp -- comparing vector and valarray
#include <iostream>
#include <valarray>
#include <vector>
#include <algorithm>
int main()
{
    using namespace std;
    vector<double> data;
    double temp;

    cout << "Enter numbers (<=0 to quit):\n";
    while (cin >> temp && temp > 0)
        data.push_back(temp);
    sort(data.begin(), data.end());
    int size = data.size();
    valarray<double> numbers(size);
    int i;
    for (i = 0; i < size; i++)
        numbers[i] = data[i];
    valarray<double> sq_rts(size);
    sq_rts = sqrt(numbers);
    valarray<double> results(size);
    results = numbers + 2.0 * sq_rts;
    cout.setf(ios_base::fixed);
    cout.precision(4);
    for (i = 0; i < size; i++)
    {
        cout.width(8);
        cout << numbers[i] << ": ";
        cout.width(8);
        cout << results[i] << endl;
    }
    cout << "done\n";
    return 0;
}

```

---

Here is a sample run of the program in Listing 16.20:

```

Enter numbers (<=0 to quit):
3.3 1.8 5.2 10 14.4 21.6 26.9 0
1.8000:  4.4833
3.3000:  6.9332
5.2000:  9.7607
10.0000: 16.3246

```

```

14.4000: 21.9895
21.6000: 30.8952
26.9000: 37.2730
done

```

The `valarray` class has many features besides the ones discussed so far. For example, if `numbers` is a `valarray<double>` object, the following statement creates an array of `bool` values, with `vbool[i]` set to the value of `numbers[i] > 9`—that is, to `true` or `false`:

```
valarray<bool> vbool = numbers > 9;
```

There are extended versions of subscripting. Let's look at one—the `slice` class. A `slice` class object can be used as an array index, in which case it represents, in general, not just one value but a subset of values. A `slice` object is initialized to three integer values: the *start*, the *number*, and the *stride*. The *start* indicates the index of the first element to be selected, the *number* indicates the number of elements to be selected, and the *stride* represents the spacing between elements. For example, the object constructed by `slice(1, 4, 3)` means select the four elements whose indexes are 1, 4, 7, and 10. That is, start with the start element, add the stride to get the next element, and so on until four elements are selected. If, say, `varint` is a `vararray<int>` object, then the following statement would set elements 1, 4, 7, and 10 to the value 10:

```
varint[slice(1,4,3)] = 10; // set selected elements to 10
```

This special subscripting facility allows you to use a one-dimensional `valarray` object to represent two-dimensional data. For example, suppose you want to represent an array with 4 rows and 3 columns. You can store the information in a 12-element `valarray` object. Then a `slice(0, 3, 1)` object used as a subscript would represent elements 0, 1, and 2—that is, the first row. Similarly, a `slice(0, 4, 3)` subscript would represent elements 0, 3, 6, and 9—that is, the first column. Listing 16.21 illustrates some features of `slice`.

#### Listing 16.21 `vslice.cpp`

---

```

// vslice.cpp -- using valarray slices
#include <iostream>
#include <valarray>
#include <cstdlib>

const int SIZE = 12;
typedef std::valarray<int> vint; // simplify declarations
void show(const vint & v, int cols);
int main()
{
    using std::slice; // from <valarray>
    using std::cout;
    vint valint(SIZE); // think of as 4 rows of 3

    int i;

```



```

    for (i = 0; i < SIZE; ++i)
        valint[i] = std::rand() % 10;
    cout << "Original array:\n";
    show(valint, 3);
    vint vcol(valint[slice(1,4,3)]); // extract 2nd column
    cout << "Second column:\n";
    show(vcol, 1);
    vint vrow(valint[slice(3,3,1)]); // extract 2nd row
    cout << "Second row:\n";
    show(vrow, 3);
    valint[slice(2,4,3)] = 10; // assign to 2nd column
    cout << "Set last column to 10:\n";
    show(valint, 3);
    cout << "Set first column to sum of next two:\n";
    // + not defined for slices, so convert to valarray<int>
    valint[slice(0,4,3)] = vint(valint[slice(1,4,3)])
        + vint(valint[slice(2,4,3)]);

    show(valint, 3);
    return 0;
}

void show(const vint & v, int cols)
{
    using std::cout;
    using std::endl;

    int lim = v.size();
    for (int i = 0; i < lim; ++i)
    {
        cout.width(3);
        cout << v[i];
        if (i % cols == cols - 1)
            cout << endl;
        else
            cout << ' ';
    }
    if (lim % cols != 0)
        cout << endl;
}

```

---

The + operator is defined for valarray objects, such as valint, and it's defined for a single int element, such as valint[1]. But as the code in Listing 16.21 notes, the + operator isn't defined for slice-subscripted valarray units, such as valint[slice(1,4,3)]. Therefore, the program constructs full objects from the slices to enable addition:

```
vint(valint[slice(1,4,3)]) // calls a slice-based constructor
```

The `valarray` class provides constructors just for this purpose.

Here is a sample run of the program in Listing 16.21:

```
Original array:
0  3  3
2  9  0
8  2  6
6  9  1
Second column:
3
9
2
9
Second row:
2  9  0
Set last column to 10:
0  3  10
2  9  10
8  2  10
6  9  10
Set first column to sum of next two:
13  3  10
19  9  10
12  2  10
19  9  10
```

Because values are set using `rand()`, different implementations of `rand()` will result in different values.

There's more, including the `gslice` class to represent multidimensional slices, but this should be enough to give you a sense of what `valarray` is about.

## The `initializer_list` Template (C++11)

The `initializer_list` template is another C++11 addition to the C++ library. You can use the `initializer-list` syntax to initialize an STL container to a list of values:

```
std::vector<double> payments {45.99, 39.23, 19.95, 89.01};
```

This would create a container for four elements and initialize the elements to the four values in the list. What makes this possible is that the container classes now have constructors taking an `initializer_list<T>` argument. A `vector<double>` object, for example, has a constructor that accepts an `initializer_list<double>` argument, and the previous declaration is the same as this:

```
std::vector<double> payments({45.99, 39.23, 19.95, 89.01});
```

Here, the list is written explicitly as a constructor argument.

Normally, as part of the C++11 universal initialization syntax, you can invoke a class constructor using `{}` instead of `()` notation:

```
shared_ptr<double> pd {new double}; // ok to use {} instead of ()
```

But this would create problems if there also is an `initializer_list` constructor:

```
std::vector<int> vi{10}; // ??
```

Which constructor does this invoke?

```
std::vector<int> vi(10); // case A: 10 uninitialized elements
std::vector<int> vi({10}); // case B: 1 element set to 10
```

The answer is that if the class does have a constructor accepting an `initializer_list` argument, then using the `{}` syntax invokes that particular constructor. So in this example, case B applies.

The `initializer_list` elements should all be of one type. However, the compiler will do conversions to match the type:

```
std::vector<double> payments {45.99, 39.23, 19, 89};
// same as std::vector<double> payments {45.99, 39.23, 19.0, 89.0};
```

Here, because the `vector` element type is `double`, the list is type `initializer_list<double>`, and 19 and 89 are converted to `double`.

The usual list restrictions on narrowing apply:

```
std::vector<int> values = {10, 8, 5.5}; // narrowing, compile-time error
```

Here, the element type is `int`, and the implied conversion of 5.5 to `int` is not allowed.

It doesn't make sense to provide an `initializer_list` constructor unless the class is meant to handle lists of varying sizes. For instance, you don't want an `initializer_list` constructor for a class taking a fixed number of values. For example, the following declaration does not provide an `initializer_list` constructor for the three data members:

```
class Position
{
private:
    int x;
    int y;
    int z;
public:
    Position(int xx = 0, int yy = 0, int zz = 0)
        : x(xx), y(yy), z(zz) {}
    // no initializer_list constructor
    ...
};
```

This allows you to use the `{}` syntax with the `Position(int, int, int)` constructor:

```
Position A = {20, -3}; // uses Position(20,-3,0)
```

## Using `initializer_list`

You can use `initializer_list` objects in your code by including the `initializer_list` header file. The template class has `begin()` and `end()` members, and you can use them to access list elements. It also has a `size()` member that returns the number of elements. Listing 16.22 shows a simple example using `initializer_list`. It requires a compiler that supports this C++11 feature.

### Listing 16.22 `ilist.cpp`

---

```
// ilist.cpp -- use initializer_list (C++11 feature)
#include <iostream>
#include <initializer_list>

double sum(std::initializer_list<double> il);
double average(const std::initializer_list<double> & ril);

int main()
{
    using std::cout;

    cout << "List 1: sum = " << sum({2,3,4})
         << ", ave = " << average({2,3,4}) << '\n';
    std::initializer_list<double> dl = {1.1, 2.2, 3.3, 4.4, 5.5};
    cout << "List 2: sum = " << sum(dl)
         << ", ave = " << average(dl) << '\n';
    dl = {16.0, 25.0, 36.0, 40.0, 64.0};
    cout << "List 3: sum = " << sum(dl)
         << ", ave = " << average(dl) << '\n';
    return 0;
}

double sum(std::initializer_list<double> il)
{
    double tot = 0;
    for (auto p = il.begin(); p != il.end(); p++)
        tot += *p;
    return tot;
}

double average(const std::initializer_list<double> & ril)
{
    double tot = 0;
```

```

    int n = ril.size();
    double ave = 0.0;
    if (n > 0)
    {
        for (auto p = ril.begin(); p !=ril.end(); p++)
            tot += *p;
        ave = tot / n;
    }
    return ave;
}

```

---

Here's a sample run:

```

List 1: sum = 9, ave = 3
List 2: sum = 16.5, ave = 3.3
List 3: sum = 181, ave = 36.2

```

## Program Notes

You can pass an `initializer_list` object by value or by reference, as shown by `sum()` and `average()`. The object itself is small, typically two pointers (one to the beginning and one past end) or a pointer to the beginning and an integer representing the size, so the choice is not a major performance issue. (The STL passes them by value.)

The function argument can be a list literal, like `{2, 3, 4}`, or it can be a list variable, like `d1`.

The iterator types for `initializer_list` are `const`, so you can't change the values in a list:

```
*d1.begin() = 2011.6;           // not allowed
```

But, as Listing 16.22 shows, you can attach a list variable to a different list:

```
d1 = {16.0, 25.0, 36.0, 40.0, 64.0}; // allowed
```

However, the intended use of the `initializer_list` class is to pass a list of values to a constructor or some other function.

## Summary

C++ includes a powerful set of libraries that provide solutions to many common programming problems and the tools to simplify many more problems. The `string` class provides a convenient means to handle strings as objects as well as automatic memory management and a host of methods and functions for working with strings. For example, these methods and functions allow you to concatenate strings, insert one string into another, reverse a string, search a string for characters or substrings, and perform input and output operations.

Smart pointer templates such as `auto_ptr` and C++11's `shared_ptr` and `unique_ptr` make it easier to manage memory allocated by `new`. If you use one of these smart pointers instead of a regular pointer to hold the address returned by `new`, you don't have to remember to use the `delete` operator later. When the smart pointer object expires, its destructor calls the `delete` operator automatically.

The STL is a collection of container class templates, iterator class templates, function object templates, and algorithm function templates that feature a unified design based on generic programming principles. The algorithms use templates to make them generic in terms of type of stored object and an iterator interface to make them generic in terms of the type of container. Iterators are generalizations of pointers.

The STL uses the term *concept* to denote a set of requirements. For example, the concept of forward iterators includes the requirements that a forward iterator object can be dereferenced for reading and writing and that it can be incremented. Actual implementations of the concept are said to *model* the concept. For example, the forward iterator concept could be modeled by an ordinary pointer or by an object designed to navigate a linked list. Concepts based on other concepts are termed *refinements*. For example, the bidirectional iterator is a refinement of the forward iterator concept.

Container classes, such as `vector` and `set`, are models of container concepts, such as containers, sequences, and associative containers. The STL defines several container class templates: `vector`, `deque`, `list`, `set`, `multiset`, `map`, `multimap`, and `bitset`. It also defines the adapter class templates `queue`, `priority_queue`, and `stack`; these classes adapt an underlying container class to give it the characteristic interface suggested by the adapter class template name. Thus, `stack`, although based, by default, on `vector`, allows insertion and removal only at the top of the stack. C++11 adds `forward_list`, `unordered_set`, `unordered_multiset`, `unordered_map`, and `unordered_multimap`.

Some algorithms are expressed as container class methods, but the bulk are expressed as general, nonmember functions. This is made possible by using iterators as the interface between containers and algorithms. One advantage to this approach is that there needs to be just one `for_each()` or `copy()` function, and so on, instead of a separate version for each container. A second advantage is that STL algorithms can be used with non-STL containers, such as ordinary arrays, `string` objects, `array` objects, and any classes you design consistent with the STL iterator and container idiom.

Both containers and algorithms are characterized by the type of iterator they provide or need. You should check that a container features an iterator concept that supports the algorithm's needs. For example, the `for_each()` algorithm uses an input iterator, whose minimal requirements are met by all the STL container class types. But `sort()` requires random access iterators, which not all container classes support. A container class may offer a specialized method as an option if it doesn't meet the requirements for a particular algorithm. For example, the `list` class has a `sort()` method that is based on bidirectional iterators, so it can use that method instead of the general function.

The STL also provides function objects, or functors, that are classes for which the `()` operator is overloaded—that is, for which the `operator()()` method is defined.

Objects of such classes can be invoked by using function notation but can carry additional information. Adaptable functors, for example, have `typedef` statements that identify the argument types and the return value type for the functor. This information can be used by other components, such as function adapters.

By representing common container types and providing a variety of common operations implemented with efficient algorithms, all done in a generic manner, the STL provides an excellent source of reusable code. You may be able to solve a programming problem directly with the STL tools, or you may be able to use them as building blocks to construct the solution you need.

The `complex` and `valarray` template classes support numeric operations for complex numbers and arrays.

## Chapter Review

1. Consider the following class declaration:

```
class RQ1
{
private:
    char * st;          // points to C-style string
public:
    RQ1() { st = new char [1]; strcpy(st, ""); }
    RQ1(const char * s)
    { st = new char [strlen(s) + 1]; strcpy(st, s); }
    RQ1(const RQ1 & rq)
    { st = new char [strlen(rq.st) + 1]; strcpy(st, rq.st); }
    ~RQ1() { delete [] st; }
    RQ & operator=(const RQ & rq);
    // more stuff
};
```

Convert this to a declaration that uses a `string` object instead. What methods no longer need explicit definitions?

2. Name at least two advantages `string` objects have over C-style strings in terms of ease-of-use.
3. Write a function that takes a reference to a `string` object as an argument and that converts the `string` object to all uppercase.
4. Which of the following are not examples of correct usage (conceptually or syntactically) of `auto_ptr`? (Assume that the needed header files have been included.)

```
auto_ptr<int> pia(new int[20]);
auto_ptr<string> (new string);
int rigue = 7;
auto_ptr<int>pr(&rigue);
auto_ptr dbl (new double);
```

5. If you could make the mechanical equivalent of a stack that held golf clubs instead of numbers, why would it (conceptually) be a bad golf bag?
6. Why would a `set` container be a poor choice for storing a hole-by-hole record of your golf scores?
7. Because a pointer is an iterator, why didn't the STL designers simply use pointers instead of iterators?
8. Why didn't the STL designers simply define a base iterator class, use inheritance to derive classes for the other iterator types, and express the algorithms in terms of those iterator classes?
9. Give at least three examples of convenience advantages that a `vector` object has over an ordinary array.
10. If Listing 16.9 were implemented with `list` instead of `vector`, what parts of the program would become invalid? Could the invalid part be fixed easily? If so, how?
11. Consider the `TooBig` functor in Listing 16.15. What does the following code do, and what values get assigned to `bo`?

```
bool bo = TooBig<int>(10)(15);
```

## Programming Exercises

1. A *palindrome* is a string that is the same backward as it is forward. For example, “tot” and “otto” are rather short palindromes. Write a program that lets a user enter a string and that passes to a `bool` function a reference to the string. The function should return `true` if the string is a palindrome and `false` otherwise. At this point, don't worry about complications such as capitalization, spaces, and punctuation. That is, this simple version should reject “Otto” and “Madam, I'm Adam.” Feel free to scan the list of string methods in Appendix F for methods to simplify the task.
2. Do the same problem as given in Programming Exercise 1 but do worry about complications such as capitalization, spaces, and punctuation. That is, “Madam, I'm Adam” should test as a palindrome. For example, the testing function could reduce the string to “madamimadam” and then test whether the reverse is the same. Don't forget the useful `cctype` library. You might find an STL function or two useful although not necessary.
3. Redo Listing 16.3 so that it gets its words from a file. One approach is to use a `vector<string>` object instead of an array of `string`. Then you can use `push_back()` to copy how ever many words are in your data file into the `vector<string>` object and use the `size()` member to determine the length of the word list. Because the program should read one word at a time from the file, you should use the `>>` operator rather than `getline()`. The file itself should contain words separated by spaces, tabs, or new lines.



4. Write a function with an old-style interface that has this prototype:

```
int reduce(long ar[], int n);
```

The actual arguments should be the name of an array and the number of elements in the array. The function should sort an array, remove duplicate values, and return a value equal to the number of elements in the reduced array. Write the function using STL functions. (If you decide to use the general `unique()` function, note that it returns the end of the resulting range.) Test the function in a short program.

5. Do the same problem as described in Programming Exercise 4, except make it a template function:

```
template <class T>
int reduce(T ar[], int n);
```

Test the function in a short program, using both a `long` instantiation and a `string` instantiation.

6. Redo the example shown in Listing 12.12, using the STL `queue` template class instead of the `Queue` class described in Chapter 12.
7. A common game is the lottery card. The card has numbered spots of which a certain number are selected at random. Write a `Lotto()` function that takes two arguments. The first should be the number of spots on a lottery card, and the second should be the number of spots selected at random. The function should return a `vector<int>` object that contains, in sorted order, the numbers selected at random. For example, you could use the function as follows:

```
vector<int> winners;
winners = Lotto(51,6);
```

This would assign to `winners` a vector that contains six numbers selected randomly from the range 1 through 51. Note that simply using `rand()` doesn't quite do the job because it may produce duplicate values. Suggestion: Have the function create a vector that contains all the possible values, use `random_shuffle()`, and then use the beginning of the shuffled vector to obtain the values. Also write a short program that lets you test the function.

8. Mat and Pat want to invite their friends to a party. They ask you to write a program that does the following:
- Allows Mat to enter a list of his friends' names. The names are stored in a container and then displayed in sorted order.
  - Allows Pat to enter a list of her friends' names. The names are stored in a second container and then displayed in sorted order.
  - Creates a third container that merges the two lists, eliminates duplicates, and displays the contents of this container.

9. Compared to an array, a linked list features easier addition and removal of elements but is slower to sort. This raises a possibility: Perhaps it might be faster to copy a list to an array, sort the array, and copy the sorted result back to the list than to simply use the list algorithm for sorting. (But it also could use more memory.) Test the speed hypothesis with the following approach:
- Create a large `vector<int>` object `vi0`, using `rand()` to provide initial values.
  - Create a second `vector<int>` object `vi` and a `list<int>` object `li` of the same size as the original and initialize them to values in the original vector.
  - Time how long the program takes to sort `vi` using the STL `sort()` algorithm, then time how long it takes to sort `li` using the `list::sort()` method.
  - Reset `li` to the unsorted contents of `vi0`. Time the combined operation of copying `li` to `vi`, sorting `vi`, and copying the result back to `li`.

To time these operations, you can use `clock()` from the `ctime` library. As in Listing 5.14, you can use this statement to start the first timing:

```
clock_t start = clock();
```

Then use the following at the end of the operation to get the elapsed time:

```
clock_t end = clock();
cout << (double)(end - start)/CLOCKS_PER_SEC;
```

This is by no means a definitive test because the results will depend on a variety of factors, including available memory, whether multiprocessing is going on, and the size of the array or list. (One would expect the relative efficiency advantage of the array over the list to increase with the number of elements being sorted.) Also if you have a choice between a default build and a release build, use the release build for the measurement. With today's speedy computers, you probably will need to use as large an array as possible to get meaningful readings. You might try, for example, 100,000 elements, 1,000,000 elements, and 10,000,000 elements.

10. Modify Listing 16.9 (`vect3.cpp`) as follows:
- Add a `price` member to the `Review` structure.
  - Instead of using a `vector` of `Review` objects to hold the input, use a `vector` of `shared_ptr<Review>` objects. Remember that a `shared_ptr` has to be initialized with a pointer returned by `new`.
  - Follow the input stage with a loop that allows the user the following options for displaying books: in original order, in alphabetical order, in order of increasing ratings, in order of decreasing ratings, in order of increasing price, in order of decreasing price, and quitting.

Here's one possible approach. After getting the initial input, create another vector of `shared_ptr`s initialized to the original array. Define an `operator<()` function that compares pointed-to structures and use it to sort the second vector so that the `shared_ptr`s are in the order of the book names stored in the pointed-to objects. Repeat the process to get vectors of `shared_ptr`s sorted by `rating` and by `price`. Note that `rbegin()` and `rend()` save you the trouble of also creating vectors of reversed order.

# Input, Output, and Files

In this chapter you'll learn about the following:

- The C++ view of input and output
- The `iostream` family of classes
- Redirection
- `ostream` class methods
- Formatting output
- `istream` class methods
- Stream states
- File I/O
- Using the `ifstream` class for input from files
- Using the `ofstream` class for output to files
- Using the `fstream` class file input and output
- Command-line processing
- Binary files
- Random file access
- Incore formatting

Discussing C++ input and output (I/O) poses a problem. On the one hand, practically every program uses input and output, and learning how to use them is one of the first tasks facing someone learning a computer language. On the other hand, C++ uses many of its more advanced language features to implement input and output, including classes, derived classes, function overloading, virtual functions, templates, and multiple inheritance. Thus, to really understand C++ I/O, you must know a lot of C++. To get you started, the early chapters of this book outline the basic ways for using the `istream` class object `cin` and the `ostream` class object `cout` for input and output, and, to a lesser degree, using `ifstream` and `ofstream` objects for file input and output. This chapter takes a

longer look at C++’s input and output classes, showing how they are designed and explaining how to control the output format. (If you’ve skipped a few chapters just to learn advanced formatting, you can read the sections on formatting, noting the techniques and ignoring the explanations.)

The C++ facilities for file input and output are based on the same basic class definitions that `cin` and `cout` are based on, so this chapter uses the discussion of console I/O (keyboard and screen) as a springboard to investigating file I/O.

The ANSI/ISO C++ standards committee has worked to make C++ I/O more compatible with existing C I/O, and this has produced some changes from traditional C++ practices.

## An Overview of C++ Input and Output

Most computer languages build input and output into the language itself. For example, if you look through the lists of keywords for languages such as BASIC and Pascal, you see that `PRINT` statements, `writeln` statements, and the like are part of the language vocabulary. But neither C nor C++ has built input and output into the language. If you look through the keywords for these languages, you find `for` and `if` but nothing relating to I/O. C originally left I/O to compiler implementers. One reason for this was to give implementers the freedom to design I/O functions that best fit the hardware requirements of the target computer. In practice, most implementers based I/O on a set of library functions originally developed for the Unix environment. ANSI C formalized recognition of this I/O package, called the Standard Input/Output package, by making it a mandatory component of the standard C library. C++ also recognizes this package, so if you’re familiar with the family of C functions declared in the `stdio.h` file, you can use them in C++ programs. (Newer implementations use the `cstdio` header file to support these functions.)

However, C++ relies on a C++ solution rather than a C solution to I/O, and that solution is a set of classes defined in the `iostream` (formerly `iostream.h`) and `fstream` (formerly `fstream.h`) header files. This class library is not part of the formal language definition (`cin` and `istream` are not keywords); after all, a computer language defines rules for how to do things, such as create classes, and doesn’t define what you should create by following those rules. But just as C implementations come with a standard library of functions, C++ comes with a standard library of classes. At first, that standard class library was an informal standard consisting solely of the classes defined in the `iostream` and `fstream` header files. The ANSI/ISO C++ committee decided to formalize this library as a standard class library and to add a few more standard classes, such as those discussed in Chapter 16, “The `string` Class and the Standard Template Library.” This chapter discusses standard C++ I/O. But first, let’s examine the conceptual framework for C++ I/O.

## Streams and Buffers

A C++ program views input or output as a stream of bytes. On input, a program extracts bytes from an input stream, and on output, a program inserts bytes into the output stream. For a text-oriented program, each byte can represent a character. More generally, the bytes can form a binary representation of character or numeric data. The bytes in an input stream can come from the keyboard, but they can also come from a storage device, such as a hard disk, or from another program. Similarly, the bytes in an output stream can flow to the display, to a printer, to a storage device, or to another program. A stream acts as an intermediary between the program and the stream's source or destination. This approach enables a C++ program to treat input from a keyboard in the same manner it treats input from a file; the C++ program merely examines the stream of bytes without needing to know where the bytes come from. Similarly, by using streams, a C++ program can process output in a manner independent of where the bytes are going. Managing input, then, involves two stages:

- Associating a stream with an input to a program
- Connecting the stream to a file

In other words, an input stream needs two connections, one at each end. The file-end connection provides a source for the stream, and the program-end connection dumps the stream outflow into the program. (The file-end connection can be a file, but it can also be a device, such as a keyboard.) Similarly, managing output involves connecting an output stream to the program and associating some output destination with the stream. It's like plumbing with bytes instead of water (see Figure 17.1).

Usually, input and output can be handled more efficiently by using a buffer. A *buffer* is a block of memory used as an intermediate, temporary storage facility for the transfer of information from a device to a program or from a program to a device. Typically, devices such as disk drives transfer information in blocks of 512 bytes or more, whereas programs often process information 1 byte at a time. The buffer helps match these two disparate rates of information transfer. For example, assume that a program is supposed to count the number of dollar signs in a hard-disk file. The program could read one character from the file, process it, read the next character from the file, and so on. Reading a file a character at a time from a disk requires a lot of hardware activity and is slow. The buffered approach is to read a large chunk from the disk, store the chunk in the buffer, and read the buffer one character at a time. Because it is much quicker to read individual bytes of data from memory than from a hard disk, this approach is much faster as well as easier on the hardware. Of course, after the program reaches the end of the buffer, the program should then read another chunk of data from the disk. The principle is similar to that of a water reservoir that collects megagallons of runoff water during a big storm and then feeds water to your home at a more civilized rate of flow (see Figure 17.2). Similarly, on output, a program can first fill the buffer and then transfer the entire block of data to a hard disk, clearing the buffer for the next batch of output. This is called *flushing the buffer*. Perhaps you can come up with your own plumbing-based analogy for that process.

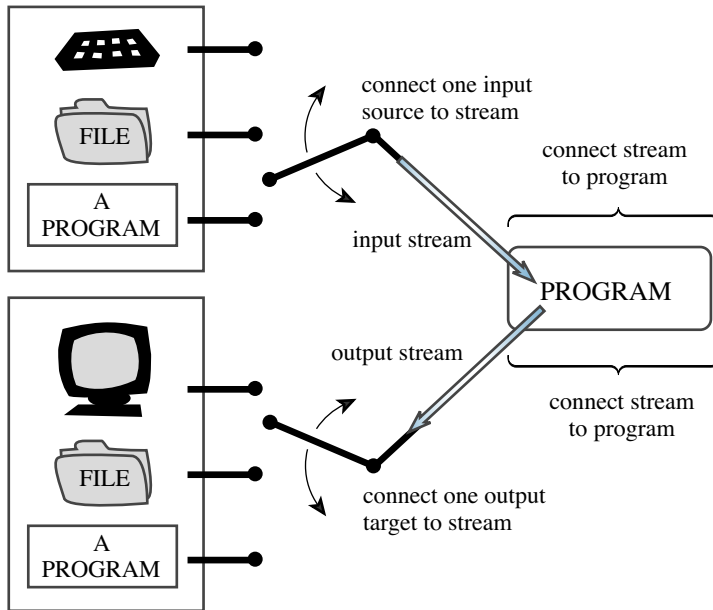

Figure 17.1 C++ input and output.

Keyboard input provides one character at a time, so in that case, a program doesn't need a buffer to help match different data transfer rates. However, buffered keyboard input allows the user to back up and correct input before transmitting it to a program. A C++ program normally flushes the input buffer when you press Enter. That's why the examples in this book don't begin processing input until you press Enter. For output to the display, a C++ program normally flushes the output buffer when you transmit a newline character. Depending on the implementation, a program may flush input on other occasions, too, such as at impending input. That is, when a program reaches an input statement, it flushes any output currently in the output buffer. C++ implementations that are consistent with ANSI C should behave in that manner.

## Streams, Buffers, and the `iostream` File

The business of managing streams and buffers can get a bit complicated, but including the `iostream` (formerly `iostream.h`) file brings in several classes designed to implement and manage streams and buffers for you. The C++98 version of C++ I/O defines class templates in order to support both `char` and `wchar_t` data. C++11 adds `char16_t` and `char32_t` specializations. By using the `typedef` facility, C++ makes the `char` specializations of these templates mimic the traditional non-template I/O implementation. Here are some of those classes (see Figure 17.3):

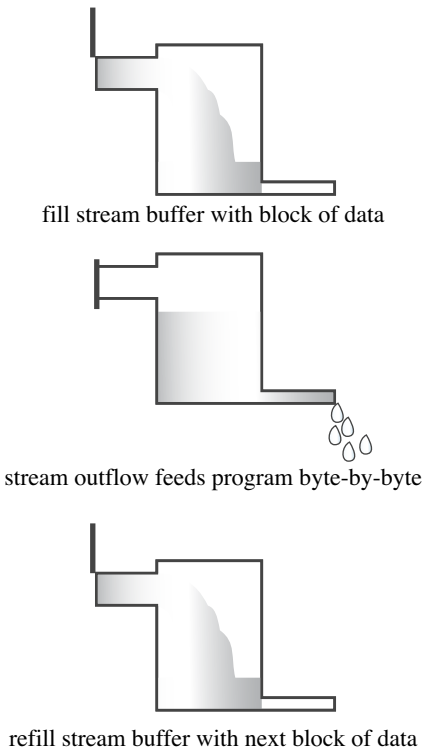

Figure 17.2 A stream with a buffer.

- The `streambuf` class provides memory for a buffer, along with class methods for filling the buffer, accessing buffer contents, flushing the buffer, and managing the buffer memory.
- The `ios_base` class represents general properties of a stream, such as whether it's open for reading and whether it's a binary or a text stream.
- The `ios` class is based on `ios_base`, and it includes a pointer member to a `streambuf` object.
- The `ostream` class derives from the `ios` class and provides output methods.
- The `istream` class derives from the `ios` class and provides input methods.
- The `iostream` class is based on the `istream` and `ostream` classes and thus inherits both input and output methods.

To use these facilities, you use objects of the appropriate classes. For example, you use an `ostream` object such as `cout` to handle output. Creating such an object opens a stream, automatically creates a buffer, and associates it with the stream. It also makes the class member functions available to you.



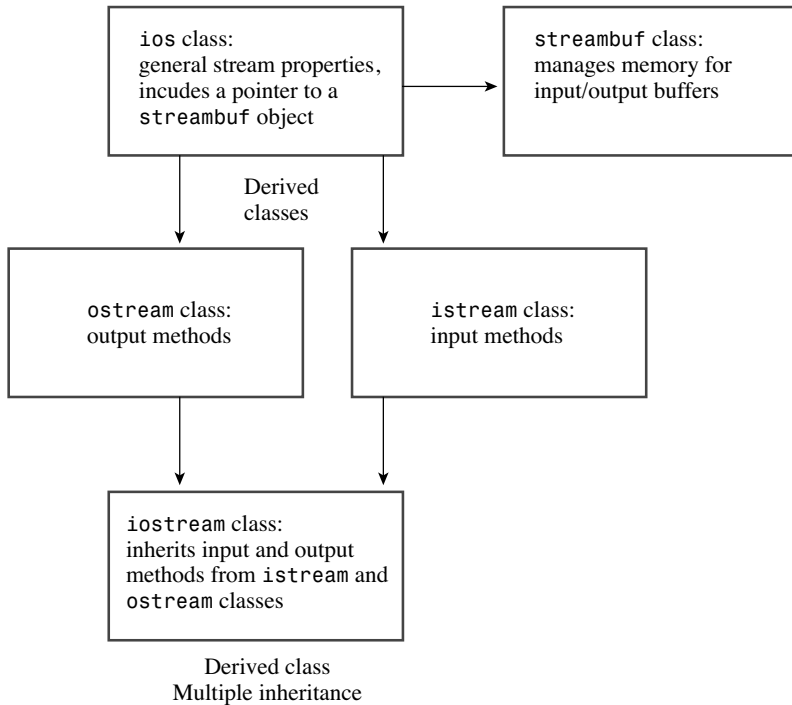

Figure 17.3 Some I/O classes.

## Redefining I/O

The ISO/ANSI C++98 Standard revised I/O a couple ways. First, there's the change from `ostream.h` to `ostream`, with `ostream` placing the classes in the `std` namespace. Second, the I/O classes have been rewritten. To be an international language, C++ has to be able to handle international character sets that require a 16-bit or wider character type. So the language added the `wchar_t` (or "wide") character type to the traditional 8-bit `char` (or "narrow") type. C++11 adds `char16_t` and `char32_t` types. Each type needs its own I/O facilities. Rather than develop two (or, now, four) separate sets of classes, the standards committee developed a template set of I/O classes, including `basic_istream<charT, traits<charT> >` and `basic_ostream<charT, traits<charT> >`. The `traits<charT>` template, in turn, is a template class that defines particular traits for a character type, such as how to compare for equality and its EOF value. The C++11 Standard provides `char` and `wchar_t` specializations of the I/O classes. For example, `istream` and `ostream` are typedefs for `char` specializations. Similarly, `wistream` and `wostream` are `wchar_t` specializations. For example, there is a `wcout` object for outputting wide character streams. The `ostream` header file contains these definitions.

Certain type-independent information that used to be kept in the `ios` base class has been moved to the new `ios_base` class. This includes the various formatting constants such as `ios::fixed`, which is now `ios_base::fixed`. Also `ios_base` contains some options that aren't available in the old `ios`.

The C++ `iostream` class library takes care of many details for you. For example, including the `iostream` file in a program creates eight stream objects (four for narrow character streams and four for wide character streams) automatically:

- The `cin` object corresponds to the standard input stream. By default, this stream is associated with the standard input device, typically a keyboard. The `wcin` object is similar but works with the `wchar_t` type.
- The `cout` object corresponds to the standard output stream. By default, this stream is associated with the standard output device, typically a monitor. The `wcout` object is similar but works with the `wchar_t` type.
- The `cerr` object corresponds to the standard error stream, which you can use for displaying error messages. By default, this stream is associated with the standard output device, typically a monitor, and the stream is unbuffered. This means that information is sent directly to the screen, without waiting for a buffer to fill or for a newline character. The `wcerr` object is similar but works with the `wchar_t` type.
- The `clog` object also corresponds to the standard error stream. By default, this stream is associated with the standard output device, typically a monitor, and the stream is buffered. The `wclog` object is similar but works with the `wchar_t` type.

What does it mean to say that an object represents a stream? Well, for example, when the `iostream` file declares a `cout` object for a program, that object has data members holding information relating to output, such as the field widths to be used in displaying data, the number of places after the decimal to use, what number base to use for displaying integers, and the address of a `streambuf` object that describes the buffer used to handle the output flow. A statement such as the following places the characters from the string "Bjarne free" into the buffer managed by `cout` via the pointed-to `streambuf` object:

```
cout << "Bjarne free";
```

The `ostream` class defines the `operator<<()` function used in this statement, and the `ostream` class also supports the `cout` data members with a variety of other class methods, such as the ones this chapter discusses later. Furthermore, C++ sees to it that the output from the buffer is directed to the standard output, usually a monitor, provided by the operating system. In short, one end of a stream is connected to the program, the other end is connected to the standard output, and the `cout` object, with the help of a type `streambuf` object, manages the flow of bytes through the stream.

## Redirection

The standard input and output streams normally connect to the keyboard and the screen. But many operating systems, including Unix, Linux, and Windows, support redirection, a facility that lets you change the associations for the standard input and the standard output. Suppose, for example, that you have an executable Windows command prompt C++ program called `counter.exe` that counts the number of characters in its input and reports the result. (From most versions of Windows you can select Start, Programs and then click the Command Prompt icon to open a command-prompt window.) A sample run might look like this:

```
C>counter
Hello
and goodbye!
Control-Z      << simulated end-of-file
Input contained 19 characters.
C>
```

In this case, input came from the keyboard, and output went to the screen.

With input redirection (<) and output redirection (>), you can use the same program to count the number of characters in the `oklahoma` file and to place the results in the `cow_cnt` file:

```
C>counter <oklahoma >cow_cnt
C>
```

The `<oklahoma` part of the command line associates the standard input with the `oklahoma` file, causing `cin` to read input from that file instead of the keyboard. In other words, the operating system changes the connection at the inflow end of the input stream, while the outflow end remains connected to the program. The `>cow_cnt` part of the command line associates the standard output with the `cow_cnt` file, causing `cout` to send output to that file instead of to the screen. That is, the operating system changes the outflow end connection of the output stream, leaving its inflow end still connected to the program. DOS, Windows command-prompt mode, Linux, and Unix automatically recognize this redirection syntax. (All of these other than early forms of DOS permit optional space characters between the redirection operators and the filenames.)

The standard output stream, represented by `cout`, is the normal channel for program output. The standard error streams (represented by `cerr` and `clog`) are intended for a program's error messages. By default, all three of these objects are typically sent to the monitor. But redirecting the standard output doesn't affect `cerr` or `clog`; thus, if you use one of these objects to print an error message, a program will display the error message on the screen even if the regular `cout` output is redirected elsewhere. For example, consider this code fragment:

```
if (success)
    std::cout << "Here come the goodies!\n";
else
{
    std::cerr << "Something horrible has happened.\n";
    exit(1);
}
```

If redirection is not in effect, whichever message is selected is displayed onscreen. If, however, the program output has been redirected to a file, the first message, if selected, would go to the file but the second message, if selected, would go to the screen. By the way, some operating systems permit redirecting the standard error, too. In Unix and Linux, for example, the `2>` operator redirects the standard error.

## Output with `cout`

As mentioned previously, C++ considers output to be a stream of bytes. (Depending on the implementation and platform, these may be 8-bit, 16-bit, or 32-bit bytes, but they're bytes nonetheless.) But many kinds of data in a program are organized into larger units than a single byte. An `int` type, for example, may be represented by a 16-bit or 32-bit binary value. And a `double` value may be represented by 64 bits of binary data. But when you send a stream of bytes to a screen, you want each byte to represent a character value. That is, to display the number `-2.34` onscreen, you should send the five characters `-, 2, ., 3,` and `4` to the screen, and not the internal 64-bit floating-point representation of that value. Therefore, one of the most important tasks facing the `ostream` class is converting numeric types, such as `int` or `float`, into a stream of characters that represents the values in text form. That is, the `ostream` class translates the internal representation of data as binary bit patterns to an output stream of character bytes. (Some day we may have bionic implants to enable us to interpret binary data directly. I leave that development as another exercise for the reader.) To perform these translation tasks, the `ostream` class provides several class methods. We'll look at them now, summarizing methods used throughout the book and describing additional methods that provide finer control over the appearance of the output.

### The Overloaded `<<` Operator

Most often, this book has used `cout` with the `<<` operator, also called the *insertion* operator:

```
int clients = 22;
cout << clients;
```

In C++, as in C, by default the `<<` operator is used as the bitwise left-shift operator (see Appendix E, "Other Operators"). An expression such as `x<<3` means to take the binary representation of `x` and shift all the bits three units to the left. Obviously, this doesn't have a lot to do with output. But the `ostream` class redefines the `<<` operator through overloading to output for the `ostream` class. In this guise, the `<<` operator is called the insertion operator instead of the left-shift operator. (The left-shift operator earned this new role through its visual aspect, which suggests a flow of information to the left.) The insertion operator is overloaded to recognize all the basic C++ types:

- `unsigned char`
- `signed char`
- `char`
- `short`
- `unsigned short`
- `int`
- `unsigned int`

- `long`
- `unsigned long`
- `long long` (C++11)
- `unsigned long long` (C++11)
- `float`
- `double`
- `long double`

The `ostream` class provides a definition for the `operator<<()` function for each of these data types. (Functions that have *operator* in their names are used to overload operators, as discussed in Chapter 11, “Working with Classes.”) Thus, if you use a statement of the following form, and if `value` is one of the preceding types, a C++ program can match it to an operator function with the corresponding signature:

```
cout << value;
```

For example, the expression `cout << 88` matches the following method prototype:

```
ostream & operator<<(int);
```

Recall that this prototype indicates that the `operator<<()` function takes one type `int` argument. That’s the part that matches the `88` in the previous statement. The prototype also indicates that the function returns a reference to an `ostream` object. That property makes it possible to concatenate output, as in the following old rock hit:

```
cout << "I'm feeling sedimental over " << boundary << "\n";
```

If you’re a C programmer who has suffered through C’s multitudinous `%` type specifiers and the problems that arise when you mismatch a specifier type to a value, using `cout` is almost sinfully easy. (And C++ input, of course, *is* cinfully easy.)

## Output and Pointers

The `ostream` class defines insertion operator functions for the following pointer types:

- `const signed char *`
- `const unsigned char *`
- `const char *`
- `void *`

C++ represents a string, don’t forget, by using a pointer to the location of the string. The pointer can take the form of the name of an array of `char` or of an explicit `pointer-to-char` or of a quoted string. Thus, all the following `cout` statements display strings:

```
char name[20] = "Dudly Diddlemore";
char * pn = "Violet D'Amore";
cout << "Hello!";
```

```
cout << name;
cout << pn;
```

The methods use the terminating null character in the string to determine when to stop displaying characters.

C++ matches a pointer of any other type with type `void *` and prints a numeric representation of the address. If you want the address of the string, you have to type cast it to another type, as shown in the following code fragment:

```
int eggs = 12;
char * amount = "dozen";
cout << &eggs;           // prints address of eggs variable
cout << amount;          // prints the string "dozen"
cout << (void *) amount; // prints the address of the "dozen" string
```

## Output Concatenation

All the incarnations of the insertion operator are defined to return type `ostream &`. That is, the prototypes have this form:

```
ostream & operator<<(type);
```

(Here, *type* is the type to be displayed.) The `ostream &` return type means that using this operator returns a reference to an `ostream` object. Which object? The function definitions say that the reference is to the object used to evoke the operator. In other words, an operator function's return value is the same object that evokes the operator. For example, `cout << "potluck"` returns the `cout` object. That's the feature that lets you concatenate output by using insertion. For example, consider the following statement:

```
cout << "We have " << count << " unhatched chickens.\n";
```

The expression `cout << "We have "` displays the string and returns the `cout` object, reducing the statement to the following:

```
cout << count << " unhatched chickens.\n";
```

Then the expression `cout << count` displays the value of the `count` variable and returns `cout`, which can then handle the final argument in the statement (see Figure 17.4). This design technique really is a nice feature, which is why the examples of overloading the `<<` operator in the previous chapters shamelessly imitate it.

## The Other `ostream` Methods

Besides the various `operator<<()` functions, the `ostream` class provides the `put()` method for displaying characters and the `write()` method for displaying strings.

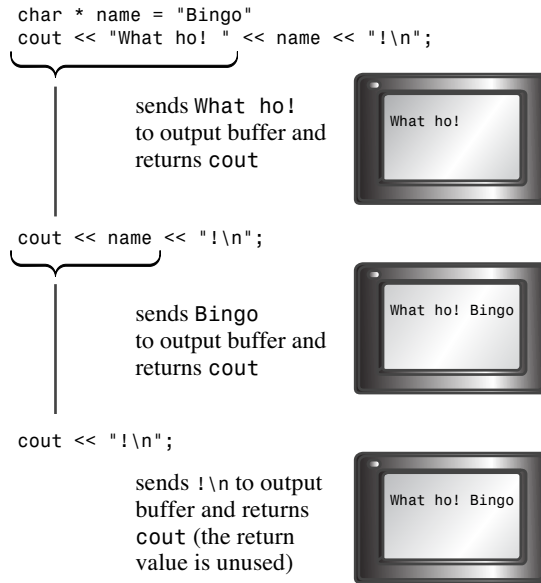

Figure 17.4 Output concatenation.

Originally, the `put()` method had the following prototype:

```
ostream & put(char);
```

The current standard is equivalent, except it's templated to allow for `wchar_t`. You invoke it by using the usual class method notation:

```
cout.put('W'); // display the W character
```

Here `cout` is the invoking object and `put()` is the class member function. Like the `<<` operator functions, this function returns a reference to the invoking object, so you can concatenate output with it:

```
cout.put('I').put('t'); // displaying It with two put() calls
```

The function call `cout.put('I')` returns `cout`, which then acts as the invoking object for the `put('t')` call.

Given the proper prototype, you can use `put()` with arguments of numeric types other than `char`, such as `int`, and let function prototyping automatically convert the argument to the correct type `char` value. For example, you could use the following:

```
cout.put(65); // display the A character
cout.put(66.3); // display the B character
```

The first statement converts the `int` value 65 to a `char` value and then displays the character having 65 as its ASCII code. Similarly, the second statement converts the type `double` value 66.3 to a type `char` value 66 and displays the corresponding character.

This behavior comes in handy with versions prior to Release 2.0 C++; in those versions, the language represents character constants with type `int` values. Thus, a statement such as the following would interpret 'W' as an `int` value and hence display it as the integer 87, the ASCII value for the character:

```
cout << 'W';
```

But the following statement works fine:

```
cout.put('W');
```

Because current C++ represents `char` constants as type `char`, you can now use either method.

Some compilers erroneously overload `put()` for three argument types: `char`, `unsigned char`, and `signed char`. This makes using `put()` with an `int` argument ambiguous because an `int` can be converted to any one of those three types.

The `write()` method writes an entire string and has the following template prototype:

```
basic_ostream<charT,traits> write(const char_type* s, streamsize n);
```

The first argument to `write()` provides the address of the string to be displayed, and the second argument indicates how many characters to display. Using `cout` to invoke `write()` invokes the `char` specialization, so the return type is `ostream &`. Listing 17.1 shows how the `write()` method works.

#### Listing 17.1 write.cpp

---

```
// write.cpp -- using cout.write()
#include <iostream>
#include <cstring> // or else string.h

int main()
{
    using std::cout;
    using std::endl;
    const char * state1 = "Florida";
    const char * state2 = "Kansas";
    const char * state3 = "Euphoria";
    int len = std::strlen(state2);
    cout << "Increasing loop index:\n";
    int i;
    for (i = 1; i <= len; i++)
    {
        cout.write(state2,i);
        cout << endl;
    }
}
```



```

// concatenate output
cout << "Decreasing loop index:\n";
for (i = len; i > 0; i--)
    cout.write(state2,i) << endl;

// exceed string length
cout << "Exceeding string length:\n";
cout.write(state2, len + 5) << endl;

return 0;
}

```

---

Some compilers may observe that the program defines but doesn't use the arrays `state1` and `state3`. That's okay because those two arrays are there just to provide data before and after the `state2` array so that you can see what happens when the program miscodes access to `state2`. Here is the output of the program in Listing 17.1:

```

Increasing loop index:
K
Ka
Kan
Kans
Kansa
Kansas
Decreasing loop index:
Kansas
Kansa
Kans
Kan
Ka
K
Exceeding string length:
Kansas Euph

```

Note that the `cout.write()` call returns the `cout` object. This is because the `write()` method returns a reference to the object that invokes it, and in this case, the `cout` object invokes it. This makes it possible to concatenate output because `cout.write()` is replaced by its return value, `cout`:

```
cout.write(state2,i) << endl;
```

Also, note that the `write()` method doesn't stop printing characters automatically when it reaches the null character. It simply prints how many characters you tell it to, even if that goes beyond the bounds of a particular string! In this case, the program brackets the string "Kansas" with two other strings so that adjacent memory locations would contain data. Compilers differ in the order in which they store data in memory and in how they align memory. For example, "Kansas" occupies 6 bytes, but this particular compiler

appears to align strings by using multiples of 4 bytes, so "Kansas" is padded out to 8 bytes. Some compilers store "Florida" after "Kansas". So because of compiler differences, you may get a different result for the final line of output.

The `write()` method can also be used with numeric data. You would pass it the address of a number, type cast to `char *`:

```
long val = 560031841;
cout.write( (char *) &val, sizeof (long));
```

This doesn't translate a number to the correct characters; instead, it transmits the bit representation as stored in memory. For example, a 4-byte `long` value such as 560031841 would be transmitted as 4 separate bytes. An output device such as a monitor would then try to interpret each byte as if it were ASCII (or whatever) code. So 560031841 would appear onscreen as some 4-character combination, most likely gibberish. (But maybe not; try it and see.) However, `write()` does provide a compact, accurate way to store numeric data in a file. We'll return to this possibility later in this chapter.

## Flushing the Output Buffer

Consider what happens as a program uses `cout` to send bytes on to the standard output. Because the `ostream` class buffers output handled by the `cout` object, output isn't sent to its destination immediately. Instead, it accumulates in the buffer until the buffer is full. Then the program *flushes* the buffer, sending the contents on and clearing the buffer for new data. Typically, a buffer is 512 bytes or an integral multiple thereof. Buffering is a great time-saver when the standard output is connected to a file on a hard disk. After all, you don't want a program to access the hard disk 512 times to send 512 bytes. It's much more effective to collect 512 bytes in a buffer and write them to a hard disk in a single disk operation.

For screen output, however, filling the buffer first is less critical. Indeed, it would be inconvenient if you had to reword the message "Press any key to continue" so that it consumed the prerequisite 512 bytes to fill a buffer. Fortunately, in the case of screen output, the program doesn't necessarily wait until the buffer is full. Sending a newline character to the buffer, for example, normally flushes the buffer. Also as mentioned before, most C++ implementations flush the buffer when input is pending. That is, suppose you have the following code:

```
cout << "Enter a number: ";
float num;
cin >> num;
```

The fact that the program expects input causes it to display the `cout` message (that is, flush the "Enter a number: " message) immediately, even though the output string lacks a newline character. Without this feature, the program would wait for input without prompting the user with the `cout` message.

If your implementation doesn't flush output when you want it to, you can force flushing by using one of two manipulators. The `flush` manipulator flushes the buffer, and the

`endl` manipulator flushes the buffer and inserts a newline character. You use these manipulators the way you would use a variable name:

```
cout << "Hello, good-looking! " << flush;
cout << "Wait just a moment, please." << endl;
```

Manipulators are, in fact, functions. For example, you can flush the `cout` buffer by calling the `flush()` function directly:

```
flush(cout);
```

However, the `ostream` class overloads the `<<` insertion operator in such a way that the following expression gets replaced with the `flush(cout)` function call:

```
cout << flush
```

Thus, you can use the more convenient insertion notation to flush with success.

## Formatting with `cout`

The `ostream` insertion operators convert values to text form. By default, they format values as follows:

- A type `char` value, if it represents a printable character, is displayed as a character in a field one character wide.
- Numeric integer types are displayed as decimal integers in a field just wide enough to hold the number and, if present, a minus sign.
- Strings are displayed in a field equal in width to the length of the string.

The default behavior for floating-point types has changed. The following are the differences between ancient and current C++ implementations:

- **New style**—Floating-point types are displayed with a total of six digits, except that trailing zeros aren't displayed. (Note that the number of digits displayed has no connection with the precision to which the number is stored.) The number is displayed in fixed-point notation or else in E notation (see Chapter 3, "Dealing with Data"), depending on the value of the number. In particular, E notation is used if the exponent is 6 or larger or -5 or smaller. Again, the field is just wide enough to hold the number and, if present, a minus sign. The default behavior corresponds to using the standard C library function `fprintf()` with a `%g` specifier.
- **Old style**—Floating-point types are displayed with six places to the right of the decimal, except that trailing zeros aren't displayed. (Note that the number of digits displayed has no connection with the precision to which the number is stored.) The number is displayed in fixed-point notation or else in E notation (see Chapter 3), depending on the value of the number. Again, the field is just wide enough to hold the number and, if present, a minus sign.

Because each value is displayed in a width equal to its size, you have to provide spaces between values explicitly; otherwise, consecutive values would run together.

Listing 17.2 illustrates the output defaults. It displays a colon (:) after each value so you can see the width of the field used in each case. The program uses the expression  $1.0 / 9.0$  to generate a nonterminating fraction so you can see how many places get printed.

### Note

Not all compilers generate output formatted in accordance with the current C++ Standard. Also the current standard does allow for regional variations. For example, a European implementation can follow the continental fashion of using a comma instead of a period for displaying decimal fractions. That is, it may write 2,54 instead of 2.54. The locale library (header file `locale`) provides a mechanism for *imbuing* an input or output stream with a particular style, so a single compiler can offer more than one locale choice. This chapter uses the U.S. locale.

### Listing 17.2 defaults.cpp

---

```
// defaults.cpp -- cout default formats
#include <iostream>

int main()
{
    using std::cout;
    cout << "12345678901234567890\n";
    char ch = 'K';
    int t = 273;
    cout << ch << ":\n";
    cout << t << ":\n";
    cout << -t << ":\n";

    double f1 = 1.200;
    cout << f1 << ":\n";
    cout << (f1 + 1.0 / 9.0) << ":\n";

    double f2 = 1.67E2;
    cout << f2 << ":\n";
    f2 += 1.0 / 9.0;
    cout << f2 << ":\n";
    cout << (f2 * 1.0e4) << ":\n";

    double f3 = 2.3e-4;
    cout << f3 << ":\n";
    cout << f3 / 10 << ":\n";

    return 0;
}
```

---

Here is the output of the program in Listing 17.2:

```
12345678901234567890
K:
273:
-273:
1.2:
1.311111:
167:
167.111:
1.67111e+006:
0.00023:
2.3e-005:
```

Each value fills its field. Note that the trailing zeros of 1.200 are not displayed but that floating-point values without terminating zeros have six places displayed. Also this particular implementation displays three digits in the exponent; others might use two.

### Changing the Number Base Used for Display

The `ostream` class inherits from the `ios` class, which inherits from the `ios_base` class. The `ios_base` class stores information that describes the format state. For example, certain bits in one class member determine the number base used, whereas another member determines the field width. By using *manipulators*, you can control the number base used to display integers. By using `ios_base` member functions, you can control the field width and the number of places displayed to the right of the decimal. Because the `ios_base` class is an indirect base class for `ostream`, you can use its methods with `ostream` objects (or descendants), such as `cout`.

#### Note

The members and methods found in the `ios_base` class were formerly found in the `ios` class. Now `ios_base` is a base class to `ios`. In the new system, `ios` is a template class with `char` and `wchar_t` specializations, and `ios_base` contains the nontemplate features.

Let's look at how to set the number base to be used in displaying integers. To control whether integers are displayed in base 10, base 16, or base 8, you can use the `dec`, `hex`, and `oct` manipulators. For example, the following function call sets the number base format state for the `cout` object to hexadecimal:

```
hex(cout);
```

After you do this, a program will print integer values in hexadecimal form until you set the format state to another choice. Note that the manipulators are not member functions, hence they don't have to be invoked by an object.

Although the manipulators really are functions, you normally see them used this way:

```
cout << hex;
```

The `ostream` class overloads the `<<` operator to make this usage equivalent to the function call `hex(cout)`. The manipulators are in the `std` namespace. Listing 17.3 illustrates using these manipulators. It shows the value of an integer and its square in three different number bases. Note that you can use a manipulator separately or as part of a series of insertions.

### Listing 17.3 `manip.cpp`

---

```
// manip.cpp -- using format manipulators
#include <iostream>
int main()
{
    using namespace std;
    cout << "Enter an integer: ";
    int n;
    cin >> n;

    cout << "n      n*n\n";
    cout << n << "      " << n * n << " (decimal)\n";
// set to hex mode
    cout << hex;
    cout << n << "      ";
    cout << n * n << " (hexadecimal)\n";

// set to octal mode
    cout << oct << n << "      " << n * n << " (octal)\n";

// alternative way to call a manipulator
    dec(cout);
    cout << n << "      " << n * n << " (decimal)\n";

    return 0;
}
```

---

Here is some sample output from the program in Listing 17.3:

```
Enter an integer: 13
n      n*n
13      169 (decimal)
d      a9 (hexadecimal)
15      251 (octal)
13      169 (decimal)
```

## Adjusting Field Widths

You probably noticed that the columns in output from Listing 17.3 don't line up; that's because the numbers have different field widths. You can use the `width` member function to place differently sized numbers in fields that have equal widths. The method has these prototypes:

```
int width();
int width(int i);
```

The first form returns the current setting for field width. The second sets the field width to `i` spaces and returns the previous field width value. This allows you to save the previous value in case you want to restore the width to that value later.

The `width()` method affects only the next item displayed, and the field width reverts to the default value afterward. For example, consider the following statements:

```
cout << '#';
cout.width(12);
cout << 12 << "#" << 24 << "#\n";
```

Because `width()` is a member function, you have to use an object (`cout`, in this case) to invoke it. The output statement produces the following display:

```
#          12#24#
```

The 12 is placed in a field 12 characters wide at the right end of the field. This is called right-justification. After that, the field width reverts to the default, and the two # characters and the 24 are printed in fields equal to their own size.

### Caution

The `width()` method affects only the next item displayed, and the field width reverts to the default value afterward.

C++ never truncates data, so if you attempt to print a seven-digit value in a field with a width of two, C++ expands the field to fit the data. (Some languages just fill the field with asterisks if the data doesn't fit. The C/C++ philosophy is that showing all the data is more important than keeping the columns neat; C++ puts substance before form.) Listing 17.4 shows how the `width()` member function works.

#### Listing 17.4 `width.cpp`

---

```
// width.cpp -- using the width method
#include <iostream>

int main()
{
    using std::cout;
    int w = cout.width(30);
    cout << "default field width = " << w << ":\n";
```

```

cout.width(5);
cout << "N" <<':';
cout.width(8);
cout << "N * N" << ":\n";

for (long i = 1; i <= 100; i *= 10)
{
    cout.width(5);
    cout << i <<':';
    cout.width(8);
    cout << i * i << ":\n";
}

return 0;
}

```

---

Here is the output of the program in Listing 17.4:

```

default field width = 0:
N:  N * N:
1:   1:
10:  100:
100: 10000:

```

The output displays values right-justified in their fields. The output is padded with spaces. That is, `cout` achieves the full field width by adding spaces. With right-justification, the spaces are inserted to the left of the values. The character used for padding is termed the *fill character*. Right-justification is the default.

Note that the program in Listing 17.4 applies the field width of 30 to the string displayed by the first `cout` statement but not to the value of `w`. This is because the `width()` method affects only the next single item displayed. Also note that `w` has the value 0. This is because `cout.width(30)` returns the previous field width, not the width to which it was just set. The fact that `w` is 0 means that zero is the default field width. Because C++ always expands a field to fit the data, this one size fits all. Finally, the program uses `width()` to align column headings and data by using a width of five characters for the first column and a width of eight characters for the second column.

### Fill Characters

By default, `cout` fills unused parts of a field with spaces. You can use the `fill()` member function to change that. For example, the following call changes the fill character to an asterisk:

```
cout.fill('*');
```

That can be handy for, say, printing checks so that recipients can't easily add a digit or two. Listing 17.5 illustrates using this member function.



Listing 17.5 `fill.cpp`

---

```
// fill.cpp -- changing fill character for fields
#include <iostream>

int main()
{
    using std::cout;
    cout.fill('*');
    const char * staff[2] = { "Waldo Whipsnade", "Wilmarie Wooper" };
    long bonus[2] = {900, 1350};

    for (int i = 0; i < 2; i++)
    {
        cout << staff[i] << ": $";
        cout.width(7);
        cout << bonus[i] << "\n";
    }

    return 0;
}
```

---

Here's the output of the program in Listing 17.5:

```
Waldo Whipsnade: $****900
Wilmarie Wooper: $***1350
```

Note that, unlike the field width, the new fill character stays in effect until you change it.

### Setting Floating-Point Display Precision

The meaning of floating-point *precision* depends on the output mode. In the default mode, it means the total number of digits displayed. In the fixed and scientific modes, to be discussed soon, *precision* means the number of digits displayed to the right of the decimal place. The precision default for C++, as you've seen, is 6. (Recall, however, that trailing zeros are dropped.) The `precision()` member function lets you select other values. For example, the following statement causes `cout` to set the precision to 2:

```
cout.precision(2);
```

Unlike the case with `width()`, but like the case for `fill()`, a new precision setting stays in effect until it is reset. Listing 17.6 demonstrates precisely this point.

Listing 17.6 `precise.cpp`

---

```
// precise.cpp -- setting the precision
#include <iostream>

int main()
```

```

{
    using std::cout;
    float price1 = 20.40;
    float price2 = 1.9 + 8.0 / 9.0;

    cout << "\"Furry Friends\" is $" << price1 << "!\n";
    cout << "\"Fiery Fiends\" is $" << price2 << "!\n";

    cout.precision(2);
    cout << "\"Furry Friends\" is $" << price1 << "!\n";
    cout << "\"Fiery Fiends\" is $" << price2 << "!\n";

    return 0;
}

```

---

Here is the output of the program in Listing 17.6:

```

"Furry Friends" is $20.4!
"Fiery Fiends" is $2.78889!
"Furry Friends" is $20!
"Fiery Fiends" is $2.8!

```

Note that the third line of this output doesn't include a trailing decimal point. Also the fourth line displays a total of two digits.

### Printing Trailing Zeros and Decimal Points

Certain forms of output, such as prices or numbers in columns, look better if trailing zeros are retained. For example, the output to Listing 17.6 would look better as \$20.40 than as \$20.4. The `iostream` family of classes doesn't provide a function whose sole purpose is to accomplish that. However, the `ios_base` class provides a `setf()` (for *set flag*) function that controls several formatting features. The class also defines several constants that can be used as arguments to this function. For example, the following function call causes `cout` to display trailing decimal points:

```
cout.setf(ios_base::showpoint);
```

In the default floating-point format, it also causes trailing zeros to be displayed. That is, instead of displaying 2.00 as 2, `cout` will display it as 2.00000 if the default precision of 6 is in effect. Listing 17.7 adds this statement to Listing 17.6.

In case you're wondering about the notation `ios_base::showpoint`, `showpoint` is a class-scope static constant that is defined in the `ios_base` class declaration. Class scope means that you have to use the scope-resolution operator (`::`) with the constant name if you use the name outside a member function definition. So `ios_base::showpoint` names a constant defined in the `ios_base` class.

Listing 17.7 `showpt.cpp`

---

```
// showpt.cpp -- setting the precision, showing trailing point
#include <iostream>

int main()
{
    using std::cout;
    using std::ios_base;

    float price1 = 20.40;
    float price2 = 1.9 + 8.0 / 9.0;

    cout.setf(ios_base::showpoint);
    cout << "\"Furry Friends\" is $" << price1 << "!\n";
    cout << "\"Fiery Fiends\" is $" << price2 << "!\n";

    cout.precision(2);
    cout << "\"Furry Friends\" is $" << price1 << "!\n";
    cout << "\"Fiery Fiends\" is $" << price2 << "!\n";

    return 0;
}
```

---

Here is the output of the program in Listing 17.7, using the current C++ formatting:

```
"Furry Friends" is $20.4000!
"Fiery Fiends" is $2.78889!
"Furry Friends" is $20.!
"Fiery Fiends" is $2.8!
```

This output shows the trailing zeros for the first line. The third line shows the decimal point but no trailing zeros because the precision has been set to 2 and two digits already have been displayed.

### More About `setf()`

The `setf()` method controls several other formatting choices besides when the decimal point is displayed, so let's take a closer look at it. The `ios_base` class has a protected data member in which individual bits (called *flags* in this context) control different formatting aspects, such as the number base and whether trailing zeros are displayed. Turning a flag on is called *setting the flag* (or bit) and means setting the bit to 1. (Bit flags are the programming equivalent to setting DIP switches to configure computer hardware.) The `hex`, `dec`, and `oct` manipulators, for example, adjust the three flag bits that control the number base. The `setf()` function provides another means of adjusting flag bits.

The `setf()` function has two prototypes. The first is this:

```
fmtflags setf(fmtflags);
```

Here `fmtflags` is a `typedef` name for a *bitmask* type (see the following Note) used to hold the format flags. The name is defined in the `ios_base` class. This version of `setf()` is used for setting format information controlled by a single bit. The argument is a `fmtflags` value that indicates which bit to set. The return value is a `fmtflags` number that indicates the former settings of all the flags. You can then save that value if you later want to restore the original settings. What value do you pass to `setf()`? If you want to set bit number 11 to 1, you pass a number that has its number 11 bit set to 1. The return value would have its number 11 bit assigned the prior value for that bit. Keeping track of bits sounds (and is) tedious. However, you don't have to do that job; the `ios_base` class defines constants that represent the bit values. Table 17.1 shows some of these definitions.

Table 17.1 **Formatting Constants**

| Constant                         | Meaning                                                                                 |
|----------------------------------|-----------------------------------------------------------------------------------------|
| <code>ios_base::boolalpha</code> | Input and output <code>bool</code> values as <code>true</code> and <code>false</code> . |
| <code>ios_base::showbase</code>  | Use C++ base prefixes (0,0x) on output.                                                 |
| <code>ios_base::showpoint</code> | Show trailing decimal point.                                                            |
| <code>ios_base::uppercase</code> | Use uppercase letters for hex output, E notation.                                       |
| <code>ios_base::showpos</code>   | Use + before positive numbers.                                                          |

### Note

A *bitmask type* is a type that is used to store individual bit values. It could be an integer type, an `enum`, or an STL `bitset` container. The main idea is that each bit is individually accessible and has its own meaning. The `iostream` package uses bitmask types to store state information.

Because these formatting constants are defined within the `ios_base` class, you must use the scope-resolution operator with them. That is, you must use `ios_base::uppercase`, not just `uppercase`. If you don't use a `using` directive or `using` declaration, you can use the scope-resolution operator to indicate that these names are in the `std` namespace. That is, you can use `std::ios_base::showpos`, and so on. Changes remain in effect until they are overridden. Listing 17.8 illustrates using some of these constants.

Listing 17.8 **setf.cpp**

```
// setf.cpp -- using setf() to control formatting
#include <iostream>

int main()
{
    using std::cout;
    using std::endl;
    using std::ios_base;

    int temperature = 63;
```

```

    cout << "Today's water temperature: ";
    cout.setf(ios_base::showpos);    // show plus sign
    cout << temperature << endl;

    cout << "For our programming friends, that's\n";
    cout << std::hex << temperature << endl; // use hex
    cout.setf(ios_base::uppercase);    // use uppercase in hex
    cout.setf(ios_base::showbase);    // use 0X prefix for hex
    cout << "or\n";
    cout << temperature << endl;
    cout << "How " << true << "! oops -- How ";
    cout.setf(ios_base::boolalpha);
    cout << true << "!\n";

    return 0;
}

```

---

Here is the output of the program in Listing 17.8:

```

Today's water temperature: +63
For our programming friends, that's
3f
or
0X3F
How 0X1! oops -- How true!

```

Note that the plus sign is used only with the base 10 version. C++ treats hexadecimal and octal values as unsigned; therefore no sign is needed for them. (However, some C++ implementations may still display a plus sign.)

The second `setf()` prototype takes two arguments and returns the prior setting:

```
fmtflags setf(fmtflags , fmtflags );
```

This overloaded form of the function is used for format choices controlled by more than 1 bit. The first argument, as before, is a `fmtflags` value that contains the desired setting. The second argument is a value that first clears the appropriate bits. For example, suppose setting bit 3 to 1 means base 10, setting bit 4 to 1 means base 8, and setting bit 5 to 1 means base 16. Suppose output is in base 10, and you want to set it to base 16. Not only do you have to set bit 5 to 1, you also have to set bit 3 to 0; this is called *clearing the bit*. The clever `hex` manipulator does both tasks automatically. Using the `setf()` function requires a bit more work because you use the second argument to indicate which bits to clear and then use the first argument to indicate which bit to set. This is not as complicated as it sounds because the `ios_base` class defines constants (shown in Table 17.2) for this purpose. In particular, you should use the constant `ios_base::basefield` as the second argument and `ios_base::hex` as the first argument if you're changing bases. That is, the following function call has the same effect as using the `hex` manipulator:

```
cout.setf(ios_base::hex, ios_base::basefield);
```

Table 17.2 Arguments for `setf(long, long)`

| Second Argument                    | First Argument                    | Meaning                                                |
|------------------------------------|-----------------------------------|--------------------------------------------------------|
| <code>ios_base::basefield</code>   | <code>ios_base::dec</code>        | Use base 10.                                           |
|                                    | <code>ios_base::oct</code>        | Use base 8.                                            |
|                                    | <code>ios_base::hex</code>        | Use base 16.                                           |
| <code>ios_base::floatfield</code>  | <code>ios_base::fixed</code>      | Use fixed-point notation.                              |
|                                    | <code>ios_base::scientific</code> | Use scientific notation.                               |
| <code>ios_base::adjustfield</code> | <code>ios_base::left</code>       | Use left-justification.                                |
|                                    | <code>ios_base::right</code>      | Use right-justification.                               |
|                                    | <code>ios_base::internal</code>   | Left-justify sign or base prefix, right-justify value. |

The `ios_base` class defines three sets of formatting flags that can be handled this way. Each set consists of one constant to be used as the second argument and two to three constants to be used as a first argument. The second argument clears a batch of related bits; then the first argument sets one of those bits to 1. Table 17.2 shows the names of the constants used for the second `setf()` argument, the associated choice of constants for the first argument, and their meanings. For example, to select left-justification, you use `ios_base::adjustfield` for the second argument and `ios_base::left` as the first argument. Left-justification means starting a value at the left end of the field, and right-justification means ending a value at the right end of the field. Internal justification means placing any signs or base prefixes at the left of the field and the rest of the number at the right of the field. (Unfortunately, C++ does not provide a self-justification mode.)

Fixed-point notation means using the 123.4 style for floating-point values, regardless of the size of the number, and scientific notation means using the 1.23e04 style, regardless of the size of the number. If you are familiar with C's `printf()` specifiers, it may help you to know that the default C++ mode corresponds to the `%g` specifier, `fixed` corresponds to the `%f` specifier, and `scientific` corresponds to the `%e` specifier.

Under the C++ Standard, both fixed and scientific notation have the following two properties:

- *Precision* means the number of digits to the right of the decimal rather than the total number of digits.
- Trailing zeros are displayed.

The `setf()` function is a member function of the `ios_base` class. Because that's a base class for the `ostream` class, you can invoke the function by using the `cout` object. For example, to request left-justification, you use this call:

```
ios_base::fmtflags old = cout.setf(ios::left, ios::adjustfield);
```

To restore the previous setting, you use this:

```
cout.setf(old, ios::adjustfield);
```

Listing 17.9 illustrates further examples of using `setf()` with two arguments.

### Note

The program in Listing 17.9 uses a math function, and some C++ systems don't automatically search the math library. For example, some Unix systems require that you use the following:

```
$ CC setf2.C -lm
```

The `-lm` option instructs the linker to search the math library. Similarly, some Linux systems using `g++` require the same flag.

### Listing 17.9 `setf2.cpp`

---

```
// setf2.cpp -- using setf() with 2 arguments to control formatting
#include <iostream>
#include <cmath>

int main()
{
    using namespace std;
    // use left justification, show the plus sign, show trailing
    // zeros, with a precision of 3
    cout.setf(ios_base::left, ios_base::adjustfield);
    cout.setf(ios_base::showpos);
    cout.setf(ios_base::showpoint);
    cout.precision(3);
    // use e-notation and save old format setting
    ios_base::fmtflags old = cout.setf(ios_base::scientific,
        ios_base::floatfield);
    cout << "Left Justification:\n";
    long n;
    for (n = 1; n <= 41; n+= 10)
    {
        cout.width(4);
        cout << n << "|";
        cout.width(12);
        cout << sqrt(double(n)) << "|\n";
    }

    // change to internal justification
    cout.setf(ios_base::internal, ios_base::adjustfield);
    // restore default floating-point display style
    cout.setf(old, ios_base::floatfield);

    cout << "Internal Justification:\n";
    for (n = 1; n <= 41; n+= 10)
    {
```

```

    cout.width(4);
    cout << n << "|";
    cout.width(12);
    cout << sqrt(double(n)) << "\\n";
}

// use right justification, fixed notation
cout.setf(ios_base::right, ios_base::adjustfield);
cout.setf(ios_base::fixed, ios_base::floatfield);
cout << "Right Justification:\\n";
for (n = 1; n <= 41; n+= 10)
{
    cout.width(4);
    cout << n << "|";
    cout.width(12);
    cout << sqrt(double(n)) << "\\n";
}

return 0;
}

```

---

Here is the output of the program in Listing 17.9:

Left Justification:

```

+1 | +1.000e+00 |
+11 | +3.317e+00 |
+21 | +4.583e+00 |
+31 | +5.568e+00 |
+41 | +6.403e+00 |

```

Internal Justification:

```

+ 1|+      1.00|
+ 11|+     3.32|
+ 21|+     4.58|
+ 31|+     5.57|
+ 41|+     6.40|

```

Right Justification:

```

+1|      +1.000|
+11|     +3.317|
+21|     +4.583|
+31|     +5.568|
+41|     +6.403|

```

Note how a precision of 3 causes the default floating-point display (used for internal justification in this program) to display a total of three digits, while the fixed and scientific modes display three digits to the right of the decimal. (The number of digits displayed in the exponent for e-notation depends on the implementation.)



The effects of calling `setf()` can be undone with `unsetf()`, which has the following prototype:

```
void unsetf(fmtflags mask);
```

Here `mask` is a bit pattern. All bits set to 1 in `mask` cause the corresponding bits to be unset. That is, `setf()` sets bits to 1, and `unsetf()` sets bits back to 0. Here's an example:

```
cout.setf(ios_base::showpoint); // show trailing decimal point
cout.unsetf(ios_base::boolshowpoint); // don't show trailing decimal point
cout.setf(ios_base::boolalpha); // display true, false
cout.unsetf(ios_base::boolalpha); // display 1, 0
```

You may have noticed that there is no special flag to indicate the default mode for displaying floating-point numbers. Here's how the system works. Fixed notation is used if the fixed bit, and only the fixed bit is set. Scientific notation is used if the scientific bit and only the scientific bit is set. Any other combination, such as no bits set or both bits set, results in the default mode being used. So one way to invoke the default mode is this:

```
cout.setf(0, ios_base::floatfield); // go to default mode
```

The second argument turns both bits off, and the first argument doesn't set any bits. A shorter way to accomplish the same end is to use `unsetf()` with `ios_base::floatfield`:

```
cout.unsetf(ios_base::floatfield); // go to default mode
```

If you knew for certain that `cout` were in the fixed state, you could use `ios_base::fixed` as an argument to `unsetf()`, but using `ios_base::floatfield` works, regardless of the current state of `cout`, so it's a better choice.

## Standard Manipulators

Using `setf()` is not the most user-friendly approach to formatting, so C++ offers several manipulators to invoke `setf()` for you, automatically supplying the right arguments. You've already seen `dec`, `hex`, and `oct`. These manipulators, most of which are not available to older C++ implementations, work like `hex`. For example, the following statement turns on left-justification and the fixed decimal point option:

```
cout << left << fixed;
```

Table 17.3 lists these along with several other manipulators.

Table 17.3 Some Standard Manipulators

| Manipulator              | Calls                                     |
|--------------------------|-------------------------------------------|
| <code>boolalpha</code>   | <code>setf(ios_base::boolalpha)</code>    |
| <code>noboolalpha</code> | <code>unset(ios_base::noboolalpha)</code> |
| <code>showbase</code>    | <code>setf(ios_base::showbase)</code>     |
| <code>noshowbase</code>  | <code>unsetf(ios_base::showbase)</code>   |

Table 17.3 Some Standard Manipulators

| Manipulator | Calls                                               |
|-------------|-----------------------------------------------------|
| showpoint   | setf(ios_base::showpoint)                           |
| noshowpoint | unsetf(ios_base::showpoint)                         |
| showpos     | setf(ios_base::showpos)                             |
| noshowpos   | unsetf(ios_base::showpos)                           |
| uppercase   | setf(ios_base::uppercase)                           |
| nouppercase | unsetf(ios_base::uppercase)                         |
| internal    | setf(ios_base::internal,<br>ios_base::adjustfield)  |
| left        | setf(ios_base::left,<br>ios_base::adjustfield)      |
| right       | setf(ios_base::right,<br>ios_base::adjustfield)     |
| dec         | setf(ios_base::dec, ios_base::base-<br>field)       |
| hex         | setf(ios_base::hex, ios_base::base-<br>field)       |
| oct         | setf(ios_base::oct, ios_base::base-<br>field)       |
| fixed       | setf(ios_base::fixed,<br>ios_base::floatfield)      |
| scientific  | setf(ios_base::scientific,<br>ios_base::floatfield) |

**Tip**

If your system supports these manipulators, take advantage of them; if it doesn't, you still have the option of using `setf()`.

**The `iomanip` Header File**

Setting some format values, such as the field width, can be awkward using the `iostream` tools. To make life easier, C++ supplies additional manipulators in the `iomanip` header file. They provide the same services already discussed, but in a notationally more convenient manner. The three most commonly used are `setprecision()` for setting the precision, `setfill()` for setting the fill character, and `setw()` for setting the field width.

Unlike the manipulators discussed previously, these take arguments. The `setprecision()` manipulator takes an integer argument that specifies the precision, the `setfill()` manipulator takes a `char` argument that indicates the fill character, and the `setw()` manipulator takes an integer argument that specifies the field width. Because they are manipulators,

they can be concatenated in a `cout` statement. This makes the `setw()` manipulator particularly convenient when you're displaying several columns of values. Listing 17.10 illustrates this by changing the field width and fill character several times for one output line. It also uses some of the newer standard manipulators.

### Note

Some C++ systems don't automatically search the math library. As mentioned before, some Unix systems require that you use the following to access the math library:

```
$ CC iomanip.C -lm
```

### Listing 17.10 `iomanip.cpp`

---

```
// iomanip.cpp -- using manipulators from iomanip
// some systems require explicitly linking the math library
#include <iostream>
#include <iomanip>
#include <cmath>

int main()
{
    using namespace std;
    // use new standard manipulators
    cout << fixed << right;

    // use iomanip manipulators
    cout << setw(6) << "N" << setw(14) << "square root"
         << setw(15) << "fourth root\n";

    double root;
    for (int n = 10; n <=100; n += 10)
    {
        root = sqrt(double(n));
        cout << setw(6) << setfill('.') << n << setfill(' ')
             << setw(12) << setprecision(3) << root
             << setw(14) << setprecision(4) << sqrt(root)
             << endl;
    }

    return 0;
}
```

---

Here is the output of the program in Listing 17.10:

```
      N   square root   fourth root
....10      3.162      1.7783
....20      4.472      2.1147
```

```

....30      5.477      2.3403
....40      6.325      2.5149
....50      7.071      2.6591
....60      7.746      2.7832
....70      8.367      2.8925
....80      8.944      2.9907
90          9.487      3.0801 ...
100         10.000     3.1623

```

Now you can produce neatly aligned columns. Using the `fixed` manipulator causes trailing zeros to be displayed.

## Input with `cin`

Now it's time to turn to input and getting data into a program. The `cin` object represents the standard input as a stream of bytes. Normally, you generate that stream of characters at the keyboard. If you type the character sequence `2011`, the `cin` object extracts those characters from the input stream. You may intend that input to be part of a string, to be an `int` value, to be a `float` value, or to be some other type. Thus, extraction also involves type conversion. The `cin` object, guided by the type of variable designated to receive the value, must use its methods to convert that character sequence into the intended type of value.

Typically, you use `cin` as follows:

```
cin >> value_holder;
```

Here `value_holder` identifies the memory location in which to store the input. It can be the name of a variable, a reference, a dereferenced pointer, or a member of a structure or of a class. How `cin` interprets the input depends on the data type for `value_holder`. The `istream` class, defined in the `istream` header file, overloads the `>>` extraction operator to recognize the following basic types:

- `signed char &`
- `unsigned char &`
- `char &`
- `short &`
- `unsigned short &`
- `int &`
- `unsigned int &`
- `long &`
- `unsigned long &`
- `long long & (C++11)`
- `unsigned long long & (C++11)`

- `float &`
- `double &`
- `long double &`

These are referred to as *formatted input functions* because they convert the input data to the format indicated by the target.

A typical operator function has a prototype like the following:

```
istream & operator>>(int &);
```

Both the argument and the return value are references. With a reference argument (see Chapter 8, “Adventures in Functions”), a statement such as the following causes the `operator>>()` function to work with the variable `staff_size` itself rather than with a copy, as would be the case with a regular argument:

```
cin >> staff_size;
```

Because the argument type is a reference, `cin` is able to directly modify the value of a variable used as an argument. The preceding statement, for example, directly modifies the value of the `staff_size` variable. We’ll get to the significance of a reference return value in a moment. First, let’s examine the type conversion aspect of the extraction operator. For arguments of each type in the preceding list of types, the extraction operator converts the character input to the indicated type of value. For example, suppose `staff_size` is type `int`. In this case, the compiler matches

```
cin >> staff_size;
```

to the following prototype:

```
istream & operator>>(int &);
```

The function corresponding to that prototype then reads the stream of characters being sent to the program—say, the characters 2, 3, 1, 8, and 4. For a system using a 2-byte `int`, the function then converts these characters to the 2-byte binary representation of the integer 23184. If, on the other hand, `staff_size` were type `double`, `cin` would use `operator>>(double &)` to convert the same input into the 8-byte floating-point representation of the value 23184.0.

Incidentally, you can use the `hex`, `oct`, and `dec` manipulators with `cin` to specify that integer input is to be interpreted as hexadecimal, octal, or decimal format. For example, the following statement causes an input of 12 or 0x12 to be read as hexadecimal 12, or decimal 18, and it causes ff or FF to be read as decimal 255:

```
cin >> hex;
```

The `istream` class also overloads the `>>` extraction operator for character pointer types:

- `signed char *`
- `char *`
- `unsigned char *`

For this type of argument, the extraction operator reads the next word from input and places it at the indicated address, adding a null character to make a string. For example, suppose you have this code:

```
cout << "Enter your first name:\n";
char name[20];
cin >> name;
```

If you respond to the request by typing `Liz`, the extraction operator places the characters `Liz\0` in the name array. (As usual, `\0` represents the terminating null character.) The name identifier, being the name of a `char` array, acts as the address of the array's first element, making name type `char *` (pointer-to-`char`).

The fact that each extraction operator returns a reference to the invoking object lets you concatenate input, just as you can concatenate output:

```
char name[20];
float fee;
int group;
cin >> name >> fee >> group;
```

Here, for example, the `cin` object returned by `cin >> name` becomes the object that handles `fee`.

## How `cin >>` Views Input

The various versions of the extraction operator share a common way of looking at the input stream. They skip over white space (blanks, newlines, and tabs) until they encounter a non-white-space character. This is true even for the single-character modes (those in which the argument is type `char`, `unsigned char`, or `signed char`), which is not true of C's character input functions (see Figure 17.5). In the single-character modes, the `>>` operator reads that character and assigns it to the indicated location. In the other modes, the operator reads in one unit of the indicated type. That is, it reads everything from the initial non-white-space character up to the first character that doesn't match the destination type.

For example, consider the following code:

```
int elevation;
cin >> elevation;
```

Suppose you type the following characters:

```
-123Z
```

The operator will read the `-`, `1`, `2`, and `3` characters because they are all valid parts of an integer. But the `Z` character isn't valid, so the last character accepted for input is the `3`. The `Z` remains in the input stream, and the next `cin` statement will start reading at that point. Meanwhile, the operator converts the character sequence `-123` to an integer value and assigns it to `elevation`.

```

char philosophy[20];
int distance;
char initial;

cin >> philosophy >> distance >> initial;

```

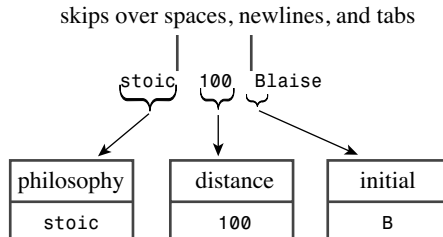

Figure 17.5 `cin >>` skips over white space.

It can happen that input fails to meet a program's expectation. For example, suppose you enter `zcar` instead of `-123z`. In that case, the extraction operator leaves the value of `elevation` unchanged and returns the value 0. (More technically, an `if` or `while` statement evaluates an `istream` object as `false` if it's had an error state set; we'll discuss this in more depth later in this chapter.) The `false` return value allows a program to check whether input meets the program requirements, as Listing 17.11 shows.

#### Listing 17.11 `check_it.cpp`

```

// check_it.cpp -- checking for valid input
#include <iostream>

int main()
{
    using namespace std;
    cout << "Enter numbers: ";

    int sum = 0;
    int input;
    while (cin >> input)
    {
        sum += input;
    }

    cout << "Last value entered = " << input << endl;
    cout << "Sum = " << sum << endl;
    return 0;
}

```

Here's the output of the program in Listing 17.11 when some inappropriate input (-123Z) sneaks into the input stream:

```
Enter numbers: 200
10 -50 -123Z 60
Last value entered = -123
Sum = 37
```

Because input is buffered, the second line of keyboard input values didn't get sent to the program until you pressed Enter at the end of the line. But the loop quit processing input at the z character because it didn't match any of the floating-point formats. The failure of input to match the expected format, in turn, caused the expression `cin>> input` to evaluate to `false`, thus terminating the `while` loop.

## Stream States

Let's take a closer look at what happens for inappropriate input. A `cin` or `cout` object contains a data member (inherited from the `ios_base` class) that describes the *stream state*. A stream state (defined as type `iosstate`, which, in turn, is a bitmask type, such as described earlier) consists of the three `ios_base` elements: `eofbit`, `badbit`, and `failbit`. Each element is a single bit that can be 1 (set) or 0 (cleared). When a `cin` operation reaches the end of a file, it sets `eofbit`. When a `cin` operation fails to read the expected characters, as in the earlier example, it sets `failbit`. I/O failures, such as trying to read a non-accessible file or trying to write to a write-protected disk, also can set `failbit` to 1. The `badbit` element is set when some undiagnosed failure may have corrupted the stream. (Implementations don't necessarily agree about which events set `failbit` and which set `badbit`.) When all three of these state bits are set to 0, everything is fine. Programs can check the stream state and use that information to decide what to do next. Table 17.4 lists these bits, along with some `ios_base` methods that report or alter the stream state.

Table 17.4 Stream States

| Member               | Description                                                                                                                              |
|----------------------|------------------------------------------------------------------------------------------------------------------------------------------|
| <code>eofbit</code>  | Is set to 1 if end-of-file reached.                                                                                                      |
| <code>badbit</code>  | Is set to 1 if the stream may be corrupted; for example, there could have been a file read error.                                        |
| <code>failbit</code> | Is set to 1 if an input operation failed to read the expected characters or an output operation failed to write the expected characters. |
| <code>goodbit</code> | Just another way of saying 0.                                                                                                            |
| <code>good()</code>  | Returns <code>true</code> if the stream can be used (all bits are cleared).                                                              |
| <code>eof()</code>   | Returns <code>true</code> if <code>eofbit</code> is set.                                                                                 |



Table 17.4 Stream States

| Member                              | Description                                                                                                                                                                                                                 |
|-------------------------------------|-----------------------------------------------------------------------------------------------------------------------------------------------------------------------------------------------------------------------------|
| <code>bad()</code>                  | Returns <code>true</code> if <code>badbit</code> is set.                                                                                                                                                                    |
| <code>fail()</code>                 | Returns <code>true</code> if <code>badbit</code> or <code>failbit</code> is set.                                                                                                                                            |
| <code>rdstate()</code>              | Returns the stream state.                                                                                                                                                                                                   |
| <code>exceptions()</code>           | Returns a bit mask that identifies which flags cause an exception to be thrown.                                                                                                                                             |
| <code>exceptions(iostate ex)</code> | Sets which states will cause <code>clear()</code> to throw an exception; for example, if <code>ex</code> is <code>eofbit</code> , then <code>clear()</code> will throw an exception if <code>eofbit</code> is set.          |
| <code>clear(iostate s)</code>       | Sets the stream state to <code>s</code> ; the default for <code>s</code> is <code>0</code> ( <code>goodbit</code> ); throws a <code>basic_ios::failure</code> exception if <code>rdstate() &amp; exceptions() != 0</code> . |
| <code>setstate(iostate s)</code>    | Calls <code>clear(rdstate()   s)</code> . This sets stream state bits corresponding to those bits set in <code>s</code> ; other stream state bits are left unchanged.                                                       |

## Setting States

Two of the methods in Table 17.4, `clear()` and `setstate()`, are similar. Both reset the state, but they do so in a different fashion. The `clear()` method sets the state to its argument. Thus, the following call uses the default argument of `0`, which clears all three state bits (`eofbit`, `badbit`, and `failbit`):

```
clear();
```

Similarly, the following call makes the state equal to `eofbit`; that is, `eofbit` is set, and the other two state bits are cleared:

```
clear(eofbit);
```

The `setstate()` method, however, affects only those bits that are set in its argument. Thus, the following call sets `eofbit` without affecting the other bits:

```
setstate(eofbit);
```

So if `failbit` was already set, it stays set.

Why would you reset the stream state? For a program writer, the most common reason is to use `clear()` with no argument to reopen input after encountering mismatched input or end-of-file; whether doing so makes sense depends on what the program is trying to accomplish. You'll see some examples shortly. The main purpose for `setstate()` is to provide a means for input and output functions to change the state. For example, if `num` is an `int`, the following call can result in `operator>>(int &)` using `setstate()` to set `failbit` or `eofbit`:

```
cin >> num; // read an int
```

## I/O and Exceptions

Suppose that an input function sets `eofbit`. Does this cause an exception to be thrown? By default, the answer is no. However, you can use the `exceptions()` method to control how exceptions are handled.

First, here's some background. The `exceptions()` method returns a bitfield with three bits corresponding to `eofbit`, `failbit`, and `badbit`. Changing the stream state involves either `clear()` or `setstate()`, which uses `clear()`. After changing the stream state, the `clear()` method compares the current stream state to the value returned by `exceptions()`. If a bit is set in the return value and the corresponding bit is set in the current state, `clear()` throws an `ios_base::failure` exception. This would happen, for example, if both values had `badbit` set. It follows that if `exceptions()` returns `goodbit`, no exceptions are thrown. The `ios_base::failure` exception class derives from the `std::exception` class and thus has a `what()` method.

The default setting for `exceptions()` is `goodbit`—that is, no exceptions thrown. However, the overloaded `exceptions(iostate)` function gives you control over the behavior:

```
cin.exceptions(badbit); // setting badbit causes exception to be thrown
```

The bitwise OR operator (`|`), as discussed in Appendix E, allows you to specify more than one bit. For example, the following statement results in an exception being thrown if either `badbit` or `eofbit` is subsequently set:

```
cin.exceptions(badbit | eofbit);
```

Listing 17.12 modifies Listing 17.11 so that the program throws and catches an exception if `failbit` is set.

### Listing 17.12 `cinexcp.cpp`

---

```
// cinexcp.cpp -- having cin throw an exception
#include <iostream>
#include <exception>

int main()
{
    using namespace std;
    // have failbit cause an exception to be thrown
    cin.exceptions(ios_base::failbit);
    cout << "Enter numbers: ";
    int sum = 0;
    int input;
    try {
        while (cin >> input)
        {
            sum += input;
        }
    } catch(ios_base::failure & bf)
```

```

    {
        cout << bf.what() << endl;
        cout << "O! the horror!\n";
    }

    cout << "Last value entered = " << input << endl;
    cout << "Sum = " << sum << endl;
    return 0;
}

```

---

Here is a sample run of the program in Listing 17.12; the `what()` message depends on the implementation:

```

Enter numbers: 20 30 40 pi 6
ios_base failure in clear
O! the horror!
Last value entered = 40.00
Sum = 90.00

```

So that's how you can use exceptions for input. But should you use them? It depends on the context. For this example, the answer is no. An exception should catch an unusual, unexpected occurrence, but this particular program uses a type mismatch as the intended way to exit the loop. It might make sense, however, for this program to throw an exception for `badbit` because that circumstance would be unexpected. Or if the program were designed to read numbers from a data file up to end-of-file, it might make sense to throw an exception for `failbit` because that would represent a problem with the data file.

### Stream State Effects

An `if` or `while` test such as the following tests as `true` only if the stream state is good (all bits cleared):

```
while (cin >> input)
```

If a test fails, you can use the member functions in Table 17.4 to discriminate among possible causes. For example, you could modify the central part of Listing 17.11 to look like this:

```

while (cin >> input)
{
    sum += input;
}
if (cin.eof())
    cout << "Loop terminated because EOF encountered\n";

```

Setting a stream state bit has a very important consequence: The stream is closed for further input or output until the bit is cleared. For example, the following code won't work:

```

while (cin >> input)
{

```

```

    sum += input;
}
cout << "Last value entered = " << input << endl;
cout << "Sum = " << sum << endl;
cout << "Now enter a new number: ";
cin >> input;    // won't work

```

If you want a program to read further input after a stream state bit has been set, you have to reset the stream state to good. This can be done by calling the `clear()` method:

```

while (cin >> input)
{
    sum += input;
}
cout << "Last value entered = " << input << endl;
cout << "Sum = " << sum << endl;
cout << "Now enter a new number: ";
cin.clear();        // reset stream state
while (!isspace(cin.get()))
    continue;      // get rid of bad input
cin >> input;      // will work now

```

Note that it is not enough to reset the stream state. The mismatched input that terminated the input loop is still in the input queue, and the program has to get past it. One way is to keep reading characters until reaching white space. The `isspace()` function (see Chapter 6, “Branching Statements and Logical Operators”) is a `cctype` function that returns `true` if its argument is a white-space character. Or you can discard the rest of the line instead of just the next word:

```

while (cin.get() != '\n')
    continue; // get rid rest of line

```

This example assumes that the loop terminated because of inappropriate input. Suppose, instead, that the loop terminated because of end-of-file or because of a hardware failure. Then the new code disposing of bad input makes no sense. You can fix matters by using the `fail()` method to test whether the assumption was correct. Because for historical reasons, `fail()` returns `true` if either `failbit` or `eofbit` is set, the code has to exclude the latter case. The following code shows an example of such exclusion:

```

while (cin >> input)
{
    sum += input;
}
cout << "Last value entered = " << input << endl;
cout << "Sum = " << sum << endl;
if (cin.fail() && !cin.eof() ) // failed because of mismatched input
{

```

```

        cin.clear();        // reset stream state
        while (!isspace(cin.get()))
            continue;      // get rid of bad input
    }
    else // else bail out
    {
        cout << "I cannot go on!\n";
        exit(1);
    }
    cout << "Now enter a new number: ";
    cin >> input; // will work now

```

## Other `istream` Class Methods

Chapters 3 through 5 discuss the `get()` and `getline()` methods. As you may recall, they provide the following additional input capabilities:

- The `get(char &)` and `get(void)` methods provide single-character input that doesn't skip over white space.
- The `get(char *, int, char)` and `getline(char *, int, char)` functions by default read entire lines rather than single words.

These are termed *unformatted input functions* because they simply read character input as it is, without skipping over white space and without performing data conversions.

Let's look at these two groups of `istream` class member functions.

### Single-Character Input

When used with a `char` argument or no argument at all, the `get()` methods fetch the next input character, even if it is a space, tab, or newline character. The `get(char & ch)` version assigns the input character to its argument, and the `get(void)` version uses the input character, converted to an integer type (typically `int`), as its return value.

#### The `get(char &)` Member Function

Let's try `get(char &)` first. Suppose you have the following loop in a program:

```

int ct = 0;
char ch;
cin.get(ch);
while (ch != '\n')
{
    cout << ch;
    ct++;
    cin.get(ch);
}
cout << ct << endl;

```

Next, suppose you type the following optimistic input:

```
I C++ clearly.<Enter>
```

Pressing the Enter key sends this input line to the program. The program fragment reads the `I` character, displays it with `cout`, and increments `ct` to 1. Next, it reads the space character following the `I`, displays it, and increments `ct` to 2. This continues until the program processes the Enter key as a newline character and terminates the loop. The main point here is that, by using `get(ch)`, the code reads, displays, and counts the spaces as well as the printing characters.

Suppose, instead, that the program tried to use `>>`:

```
int ct = 0;
char ch;
cin >> ch;
while (ch != '\n')    // FAILS
{
    cout << ch;
    ct++;
    cin >> ch;
}
cout << ct << endl;
```

First, the code would skip the spaces, thus not counting them and compressing the corresponding output to this:

```
IC++clearly.
```

Worse, the loop would never terminate! Because the extraction operator skips newlines, the code would never assign the newline character to `ch`, so the `while` loop test would never terminate the loop.

The `get(char &)` member function returns a reference to the `istream` object used to invoke it. This means you can concatenate other extractions following `get(char &)`:

```
char c1, c2, c3;
cin.get(c1).get(c2) >> c3;
```

First, `cin.get(c1)` assigns the first input character to `c1` and returns the invoking object, which is `cin`. This reduces the code to `cin.get(c2) >> c3`, which assigns the second input character to `c2`. The function call returns `cin`, reducing the code to `cin >> c3`. This, in turn, assigns the next non-white-space character to `c3`. Note that `c1` and `c2` could wind up being assigned white space, but `c3` couldn't.

If `cin.get(char &)` encounters the end of a file, either real or simulated from the keyboard (Ctrl+Z for DOS and Windows command prompt mode, Ctrl+D at the beginning of a line for Unix), it does not assign a value to its argument. This is quite right because if the program has reached the end of the file, there is no value to be assigned. Furthermore, the method calls `setstate(failbit)`, which causes `cin` to test as `false`:

```
char ch;
while (cin.get(ch))
{
    // process input
}
```

As long as there's valid input, the return value for `cin.get(ch)` is `cin`, which evaluates as `true`, so the loop continues. Upon reaching end-of-file, the return value evaluates as `false`, terminating the loop.

### The `getchar()` Member Function

The `get(void)` member function also reads white space, but it uses its return value to communicate input to a program. So you would use it this way:

```
int ct = 0;
char ch;
ch = cin.get(); // use return value
while (ch != '\n')
{
    cout << ch;
    ct++;
    ch = cin.get();
}
cout << ct << endl;
```

The `get(void)` member function returns type `int` (or some larger integer type, depending on the character set and locale). This makes the following invalid:

```
char c1, c2, c3;
cin.get().get() >> c3; // not valid
```

Here `cin.get()` returns a type `int` value. Because that return value is not a class object, you can't apply the membership operator to it. Thus, you get a syntax error. However, you can use `get()` at the end of an extraction sequence:

```
char c1;
cin.get(c1).get(); // valid
```

The fact that `get(void)` returns type `int` means you can't follow it with an extraction operator. But because `cin.get(c1)` returns `cin`, it makes it a suitable prefix to `get()`. This particular code would read the first input character, assign it to `c1`, and then read the second input character and discard it.

Upon reaching the end-of-file, real or simulated, `cin.get(void)` returns the value `EOF`, which is a symbolic constant provided by the `iostream` header file. This design feature allows the following construction for reading input:

```
int ch;
while ((ch = cin.get()) != EOF)
{
```

```

    // process input
}

```

You should use type `int` for `ch` instead of type `char` here because the value `EOF` may not be expressed as a `char` type.

Chapter 5, “Loops and Relational Expressions,” describes these functions in a bit more detail, and Table 17.5 summarizes the features of the single-character input functions.

Table 17.5 `cin.get(ch)` Versus `cin.get()`

| Property                                  | <code>cin.get(ch)</code>                         | <code>ch = cin.get()</code>                            |
|-------------------------------------------|--------------------------------------------------|--------------------------------------------------------|
| Method for conveying input character      | Assign to argument <code>ch</code>               | Use function return value to assign to <code>ch</code> |
| Function return value for character input | Reference to a class <code>istream</code> object | Code for character as type <code>int</code> value      |
| Function return value                     | Converts to <code>false</code>                   | <code>EOF</code> at end-of-file                        |

### Which Form of Single-Character Input to Use?

Given the choice of `>>`, `get(char &)`, and `get(void)`, which should you use? First, you need to decide whether you want input to skip over white space. If skipping white space is convenient, you should use the extraction operator, `>>`. For example, skipping white space is convenient for offering menu choices:

```

cout << "a. annoy client      b. bill client\n"
    << "c. calm client       d. deceive client\n"
    << "q.\n";
cout << "Enter a, b, c, d, or q: ";
char ch;
cin >> ch;
while (ch != 'q')
{
    switch(ch)
    {
        ...
    }
    cout << "Enter a, b, c, d, or q: ";
    cin >> ch;
}

```

To enter, say, a `b` response, you type `b` and press Enter, generating the two-character response `b\n`. If you used either form of `get()`, you would have to add code to process that `\n` character on each loop cycle, but the extraction operator conveniently skips it. (If you’ve programmed in C, you’ve probably encountered a situation in which the newline appears to the program as an invalid response. It’s an easy problem to fix, but it is a nuisance.)



If you want a program to examine every character, you should use one of the `get()` methods. For example, a word-counting program could use white space to determine when a word came to an end. Of the two `get()` methods, the `get(char &)` method has the classier interface. The main advantage of the `get(void)` method is that it closely resembles the standard C `getchar()` function, which means you can convert a C program to a C++ program by including `istream` instead of `stdio.h`, globally replacing `getchar()` with `cin.get()`, and globally replacing C's `putchar(ch)` with `cout.put(ch)`.

### String Input: `getline()`, `get()`, and `ignore()`

Next, let's review the string input member functions introduced in Chapter 4, "Compound Types". The `getline()` member function and the string-reading version of `get()` both read strings, and both have the same function signatures (here simplified from the more general template declaration):

```
istream & get(char *, int, char);
istream & get(char *, int);
istream & getline(char *, int, char);
istream & getline(char *, int);
```

The first argument, recall, is the address of the location to place the input string. The second argument is one greater than the maximum number of characters to be read. (The additional character leaves space for the terminating null character used in storing the input as a string.) The third argument specifies a character to act as a delimiter to input. The versions with just two arguments use the newline character as a delimiter. Each function reads up to the maximum characters or until it encounters the delimiter character, whichever comes first.

For example, the following code reads character input into the character array `line`:

```
char line[50];
cin.get(line, 50);
```

The `cin.get()` function quits reading input into the array after encountering 49 characters or, by default, after encountering a newline character, whichever comes first. The chief difference between `get()` and `getline()` is that `get()` leaves the newline character in the input stream, making it the first character seen by the next input operation, whereas `getline()` extracts and discards the newline character from the input stream.

Chapter 4 illustrated using the two-argument form for these two member functions. Now let's look at the three-argument versions. The third argument is the delimiter character. Encountering the delimiter character causes input to cease, even if the maximum number of characters hasn't been reached. So by default, both methods quit reading input if they reach the end of a line before reading the allotted number of characters. Just as in the default case, `get()` leaves the delimiter character in the input queue, and `getline()` does not.

Listing 17.13 demonstrates how `getline()` and `get()` work. It also introduces the `ignore()` member function. `ignore()` takes two arguments: a number specifying a maximum number of characters to read and a character that acts as a delimiter character for

input. For example, the following function call reads and discards the next 255 characters or up through the first newline character, whichever comes first:

```
cin.ignore(255, '\n');
```

The prototype provides defaults of 1 and EOF for the two arguments, and the function return type is `istream &`:

```
istream & ignore(int = 1, int = EOF);
```

(The EOF default value causes `ignore()` to read up to the specified number of characters or until end-of-file, whichever comes first.)

The function returns the invoking object. This lets you concatenate function calls, as in the following:

```
cin.ignore(255, '\n').ignore(255, '\n');
```

Here the first `ignore()` method reads and discards one line, and the second call reads and discards the second line. Together the two functions read through two lines.

Now check out Listing 17.13.

#### Listing 17.13 `get_fun.cpp`

---

```
// get_fun.cpp -- using get() and getline()
#include <iostream>
const int Limit = 255;

int main()
{
    using std::cout;
    using std::cin;
    using std::endl;

    char input[Limit];

    cout << "Enter a string for getline() processing:\n";
    cin.getline(input, Limit, '#');
    cout << "Here is your input:\n";
    cout << input << "\nDone with phase 1\n";

    char ch;
    cin.get(ch);
    cout << "The next input character is " << ch << endl;

    if (ch != '\n')
        cin.ignore(Limit, '\n');    // discard rest of line

    cout << "Enter a string for get() processing:\n";
    cin.get(input, Limit, '#');
    cout << "Here is your input:\n";
```

```

    cout << input << "\nDone with phase 2\n";

    cin.get(ch);
    cout << "The next input character is " << ch << endl;

    return 0;
}

```

---

Here is a sample run of the program in Listing 17.13:

Enter a string for getline() processing:

**Please pass**

**me a #3 melon!**

Here is your input:

Please pass

me a

Done with phase 1

The next input character is 3

Enter a string for get() processing:

**I still**

**want my #3 melon!**

Here is your input:

I still

want my

Done with phase 2

The next input character is #

Note that the `getline()` function discards the # termination character in the input, and the `get()` function does not.

### Unexpected String Input

Some forms of input for `get(char *, int)` and `getline()` affect the stream state. As with the other input functions, encountering end-of-file sets `eofbit`, and anything that corrupts the stream, such as device failure, sets `badbit`. Two other special cases are no input and input that meets or exceeds the maximum number of characters specified by the function call. Let's look at those cases now.

If either method fails to extract any characters, the method places a null character into the input string and uses `setstate()` to set `failbit`. When would a method fail to extract any characters? One possibility is if an input method immediately encounters end-of-file. For `get(char *, int)`, another possibility is if you enter an empty line:

```

char temp[80];
while (cin.get(temp,80) // terminates on empty line
    ...

```

Interestingly, an empty line does not cause `getline()` to set `failbit`. That's because `getline()` still extracts the newline character, even if it doesn't store it. If you want a `getline()` loop to terminate on an empty line, you can write it this way:

```
char temp[80];
while (cin.getline(temp,80) && temp[0] != '\0') // terminates on empty line
```

Now suppose the number of characters in the input queue meets or exceeds the maximum specified by the input method. First, consider `getline()` and the following code:

```
char temp[30];
while (cin.getline(temp,30))
```

The `getline()` method will read consecutive characters from the input queue, placing them in successive elements of the `temp` array, until (in order of testing) end-of-file is encountered, until the next character to be read is the newline character, or until 29 characters have been stored. If end-of-file is encountered, `eofbit` is set. If the next character to be read is a newline character, that character is read and discarded. And if 29 characters were read, `failbit` is set, unless the next character is a newline. Thus, an input line of 30 characters or more will terminate input.

Now consider the `get(char *, int)` method. It tests the number of characters first, end-of-file second, and for the next character being a newline third. It does not set the `failbit` flag if it reads the maximum number of characters. Nonetheless, you can tell if too many input characters caused the method to quit reading. You can use `peek()` (see the next section) to examine the next input character. If it's a newline, then `get()` must have read the entire line. If it's not a newline, then `get()` must have stopped before reaching the end. This technique doesn't necessarily work with `getline()` because `getline()` reads and discards the newline, so looking at the next character doesn't tell you anything. But if you use `get()`, you have the option of doing something if less than an entire line is read. The next section includes an example of this approach. Meanwhile, Table 17.6 summarizes these behaviors.

Table 17.6 Input Behavior

| Method                            | Behavior                                                                                                                                                                                                     |
|-----------------------------------|--------------------------------------------------------------------------------------------------------------------------------------------------------------------------------------------------------------|
| <code>getline(char *, int)</code> | Sets <code>failbit</code> if no characters are read (but newline counts as a character read).<br>Sets <code>failbit</code> if the maximum number of characters are read and more are still left in the line. |
| <code>get(char *, int)</code>     | Sets <code>failbit</code> if no characters are read.                                                                                                                                                         |

## Other istream Methods

Other `istream` methods besides the ones discussed so far include `read()`, `peek()`, `gcount()`, and `putback()`. The `read()` function reads a given number of bytes and stores them in the specified location. For example, the following statements read 144 characters from the standard input and place them in the `gross` array:

```
char gross[144];
cin.read(gross, 144);
```

Unlike `getline()` and `get()`, `read()` does not append a null character to input, so it doesn't convert input to string form. The `read()` method is not intended for keyboard input. Instead, it is most often used in conjunction with the ostream `write()` function for file input and output. The method's return type is `istream &`, so it can be concatenated as follows:

```
char gross[144];
char score[20];
cin.read(gross, 144).read(score, 20);
```

The `peek()` function returns the next character from input without extracting from the input stream. That is, it lets you peek at the next character. Suppose you want to read input up to the first newline or period, whichever comes first. You can use `peek()` to peek at the next character in the input stream in order to judge whether to continue:

```
char great_input[80];
char ch;
int i = 0;
while ((ch = cin.peek()) != '.' && ch != '\n')
    cin.get(great_input[i++]);
great_input[i] = '\0';
```

The call to `cin.peek()` peeks at the next input character and assigns its value to `ch`. Then the `while` loop test condition checks that `ch` is neither a period nor a newline. If this is the case, the loop reads the character into the array and updates the array index. When the loop terminates, the period or newline character remains in the input stream, positioned to be the first character read by the next input operation. Then the code appends a null character to the array, making it a string.

The `gcount()` method returns the number of characters read by the last unformatted extraction method. That means characters read by a `get()`, `getline()`, `ignore()`, or `read()` method but not by the extraction operator (`>>`), which formats input to fit particular data types. For example, suppose you've just used `cin.get(myarray, 80)` to read a line into the `myarray` array and you want to know how many characters were read. You could use the `strlen()` function to count the characters in the array, but it would be quicker to use `cin.gcount()` to report how many characters were just read from the input stream.

The `putback()` function inserts a character back in the input string. The inserted character then becomes the first character read by the next input statement. The `putback()` method takes one `char` argument, which is the character to be inserted, and it returns type `istream &`, which allows the call to be concatenated with other `istream` methods. Using `peek()` is like using `get()` to read a character and then using `putback()` to place the character back in the input stream. However, `putback()` gives you the option of putting back a character that is different from the one just read.

Listing 17.14 uses two approaches to read and echo input up to, but not including, a # character. The first approach reads through the # character and then uses `putback()` to insert the character back into the input. The second approach uses `peek()` to look ahead before reading input.

#### Listing 17.14 `peeker.cpp`

---

```
// peeker.cpp -- some istream methods
#include <iostream>

int main()
{
    using std::cout;
    using std::cin;
    using std::endl;

    // read and echo input up to a # character
    char ch;

    while(cin.get(ch)           // terminates on EOF
        {
            if (ch != '#')
                cout << ch;
            else
            {
                cin.putback(ch); // reinsert character
                break;
            }
        }

    if (!cin.eof())
    {
        cin.get(ch);
        cout << endl << ch << " is next input character.\n";
    }
    else
    {
        cout << "End of file reached.\n";
        std::exit(0);
    }

    while(cin.peek() != '#') // look ahead
    {
        cin.get(ch);
        cout << ch;
    }
    if (!cin.eof())
```

```

    {
        cin.get(ch);
        cout << endl << ch << " is next input character.\n";
    }
    else
        cout << "End of file reached.\n";

    return 0;
}

```

---

Here is a sample run of the program in Listing 17.14:

```

I used a #3 pencil when I should have used a #2.
I used a
# is next input character.
3 pencil when I should have used a
# is next input character.

```

### Program Notes

Let's look more closely at some of the code in Listing 17.14. The first approach uses a while loop to read input:

```

while(cin.get(ch)           // terminates on EOF
{
    if (ch != '#')
        cout << ch;
    else
    {
        cin.putback(ch); // reinsert character
        break;
    }
}

```

The expression `cin.get(ch)` returns `false` on reaching the end-of-file condition, so simulating end-of-file from the keyboard terminates the loop. If the `#` character shows up first, the program puts the character back in the input stream and uses a `break` statement to terminate the loop.

The second approach is simpler in appearance:

```

while(cin.peek() != '#') // look ahead
{
    cin.get(ch);
    cout << ch;
}

```

The program peeks at the next character. If it is not the # character, the program reads the next character, echoes it, and peeks at the next character. This continues until the terminating character shows up.

Now let's look, as promised, at an example—Listing 17.15—that uses `peek()` to determine whether an entire line has been read. If only part of a line fits in the input array, the program discards the rest of the line.

#### Listing 17.15 `truncate.cpp`

---

```
// truncate.cpp -- using get() to truncate input line, if necessary
#include <iostream>
const int SLEN = 10;
inline void eatline() { while (std::cin.get() != '\n') continue; }
int main()
{
    using std::cin;
    using std::cout;
    using std::endl;

    char name[SLEN];
    char title[SLEN];
    cout << "Enter your name: ";
    cin.get(name, SLEN);
    if (cin.peek() != '\n')
        cout << "Sorry, we only have enough room for "
            << name << endl;
    eatline();
    cout << "Dear " << name << ", enter your title: \n";
    cin.get(title, SLEN);
    if (cin.peek() != '\n')
        cout << "We were forced to truncate your title.\n";
    eatline();
    cout << " Name: " << name
        << "\nTitle: " << title << endl;

    return 0;
}
```

---

Here is a sample run of the program in Listing 17.15:

```
Enter your name: Ella Fishsniffer
Sorry, we only have enough room for Ella Fish
Dear Ella Fish, enter your title:
Executive Adjunct
We were forced to truncate your title.
```



```
Name: Ella Fish
Title: Executive
```

Note that the following code makes sense whether or not the first input statement reads the entire line:

```
while (cin.get() != '\n') continue;
```

If `get()` reads the whole line, it still leaves the newline in place, and this code reads and discards the newline character. If `get()` reads just part of the line, this code reads and discards the rest of the line. If you didn't dispose of the rest of the line, the next input statement would begin reading at the beginning of the remaining input on the first input line. With this example, that would result in the program reading the string `sniffer` into the `title` array.

## File Input and Output

Most computer programs work with files. Word processors create document files. Database programs create and search files of information. Compilers read source code files and generate executable files. A file itself is a bunch of bytes stored on some device, perhaps magnetic tape, perhaps an optical disk, a floppy disk, or a hard disk. Typically, the operating system manages files, keeping track of their locations, their sizes, when they were created, and so on. Unless you're programming on the operating system level, you normally don't have to worry about those things. What you do need is a way to connect a program to a file, a way to have a program read the contents of a file, and a way to have a program create and write to files. Redirection (as discussed earlier in this chapter) can provide some file support, but it is more limited than explicit file I/O from within a program. Also redirection comes from the operating system, not from C++, so it isn't available on all systems. This book has already touched on file I/O, and this chapter explores the topic more thoroughly.

The C++ I/O class package handles file input and output much as it handles standard input and output. To write to a file, you create an `ofstream` object and use the `ostream` methods, such as the `<<` insertion operator or `write()`. To read a file, you create an `ifstream` object and use the `istream` methods, such as the `>>` extraction operator or `get()`. Files require more management than the standard input and output, however. For example, you have to associate a newly opened file with a stream. You can open a file in read-only mode, write-only mode, or read-and-write mode. If you write to a file, you might want to create a new file, replace an old file, or add to an old file. Or you might want to move back and forth through a file. To help handle these tasks, C++ defines several new classes in the `fstream` (formerly `fstream.h`) header file, including the `ifstream` class for file input and the `ofstream` class for file output. C++ also defines the `fstream` class for simultaneous file I/O. These classes are derived from the classes in the `iostream` header file, so objects of these new classes are able to use the methods you've already learned.

## Simple File I/O

Suppose you want a program to write to a file. You must do the following:

1. Create an `ofstream` object to manage the output stream.
2. Associate that object with a particular file.
3. Use the object the same way you would use `cout`; the only difference is that output goes to the file instead of to the screen.

To accomplish this, you begin by including the `fstream` header file. Including this file automatically includes the `iostream` file for most, but not all, implementations, so you may not have to include `iostream` explicitly. Then you declare an `ofstream` object:

```
ofstream fout; // create an ofstream object named fout
```

The object's name can be any valid C++ name, such as `fout`, `outFile`, `cgate`, or `didi`.

Next, you must associate this object with a particular file. You can do so by using the `open()` method. Suppose, for example, that you want to open the `jar.txt` file for output. You would do the following:

```
fout.open("jar.txt"); // associate fout with jar.txt
```

You can combine these two steps (creating the object and associating a file) into a single statement by using a different constructor:

```
ofstream fout("jar.txt"); // create fout object, associate it with jar.txt
```

When you've gotten this far, you use `fout` (or whatever name you choose) in the same manner as `cout`. For example, if you want to put the words `Dull Data` into the file, you can do the following:

```
fout << "Dull Data";
```

Indeed, because `ostream` is a base class for the `ofstream` class, you can use all the `ostream` methods, including the various insertion operator definitions and the formatting methods and manipulators. The `ofstream` class uses buffered output, so the program allocates space for an output buffer when it creates an `ofstream` object such as `fout`. If you create two `ofstream` objects, the program creates two buffers, one for each object. An `ofstream` object such as `fout` collects output byte-by-byte from the program; then, when the buffer is filled, it transfers the buffer contents en masse to the destination file. Because disk drives are designed to transfer data in larger chunks, not byte-by-byte, the buffered approach greatly speeds up the transfer rate of data from a program to a file.

Opening a file for output this way creates a new file if there is no file of that name. If a file by that name exists prior to opening it for output, the act of opening it truncates it so that output starts with a clean file. Later in this chapter you'll see how to open an existing file and retain its contents.

**Caution**

Opening a file for output in the default mode automatically truncates the file to zero size, in effect disposing of the prior contents.

The requirements for reading a file are much like those for writing to a file:

1. Create an `ifstream` object to manage the input stream.
2. Associate that object with a particular file.
3. Use the object the same way you would use `cin`.

The steps for reading a file are similar to those for writing to a file. First, of course, you include the `fstream` header file. Then you declare an `ifstream` object and associate it with the filename. You can do so in two statements or one:

```
// two statements
ifstream fin;           // create ifstream object called fin
fin.open("jellyjar.txt"); // open jellyjar.txt for reading
// one statement
ifstream fis("jamjar.txt"); // create fis and associate with jamjar.txt
```

You can then use `fin` or `fis` much as you would use `cin`. For example, you can use the following:

```
char ch;
fin >> ch;           // read a character from the jellyjar.txt file
char buf[80];
fin >> buf;          // read a word from the file
fin.getline(buf, 80); // read a line from the file
string line;
getline(fin, line);  // read from a file to a string object
```

Input, like output, is buffered, so creating an `ifstream` object such as `fin` creates an input buffer, which the `fin` object manages. As with output, buffering moves data much faster than byte-by-byte transfer.

The connections with a file are closed automatically when the input and output stream objects expire—for example, when the program terminates. Also you can close a connection with a file explicitly by using the `close()` method:

```
fout.close(); // close output connection to file
fin.close();  // close input connection to file
```

Closing such a connection does not eliminate the stream; it just disconnects it from the file. However, the stream management apparatus remains in place. For example, the `fin` object still exists, along with the input buffer it manages. As you'll see later, you can reconnect the stream to the same file or to another file.

Let's look at a short example. The program in Listing 17.16 asks for a filename. It creates a file that has that name, writes some information to it, and closes the file. Closing the file flushes the buffer, guaranteeing that the file is updated. Then the program opens the

same file for reading and displays its contents. Note that the program uses `fin` and `fout` in the same manner as you'd use `cin` and `cout`. Also, the program reads the filename into a string object and then uses the `c_str()` method to provide C-style string arguments for the `ofstream` and `ifstream` constructors.

#### Listing 17.16 `fileio.cpp`

---

```
// fileio.cpp -- saving to a file
#include <iostream> // not needed for many systems
#include <fstream>
#include <string>

int main()
{
    using namespace std;
    string filename;

    cout << "Enter name for new file: ";
    cin >> filename;

    // create output stream object for new file and call it fout
    ofstream fout(filename.c_str());

    fout << "For your eyes only!\n"; // write to file
    cout << "Enter your secret number: "; // write to screen
    float secret;
    cin >> secret;
    fout << "Your secret number is " << secret << endl;
    fout.close(); // close file

    // create input stream object for new file and call it fin
    ifstream fin(filename.c_str());
    cout << "Here are the contents of " << filename << ":\n";
    char ch;
    while (fin.get(ch)) // read character from file and
        cout << ch; // write it to screen
    cout << "Done\n";
    fin.close();

    return 0;
}
```

---

Here is a sample run of the program in Listing 17.16:

```
Enter name for new file: pythag
Enter your secret number: 3.14159
```

```

Here are the contents of pythag:
For your eyes only!
Your secret number is 3.14159
Done

```

If you check the directory that contains the program, you should find a file named `pythag`, and any text editor should show the same contents that the program output displays. (So much for secrecy.)

## Stream Checking and `is_open()`

The C++ file stream classes inherit a stream-state member from the `ios_base` class. This member, as discussed earlier, stores information that reflects the stream status: All is well, end-of-file has been reached, I/O operation failed, and so on. If all is well, the stream state is zero (no news is good news). The various other states are recorded by setting particular bits to 1. The file stream classes also inherit the `ios_base` methods that report about the stream state and that are summarized in Table 17.4. You can check the stream state to find whether the most recent stream operation succeeded or failed. For file streams, this includes checking the success of an attempt to open a file. For example, attempting to open a non-existent file for input sets `failbit`. So you could check this way:

```

fin.open(argv[file]);
if (fin.fail() // open attempt failed
{
    ...
}

```

Or because an `ifstream` object, like an `istream` object, is converted to a `bool` type where a `bool` type is expected, you could use this:

```

fin.open(argv[file]);
if (!fin) // open attempt failed
{
    ...
}

```

However, newer C++ implementations have a better way to check whether a file has been opened—the `is_open()` method:

```

if (!fin.is_open()) // open attempt failed
{
    ...
}

```

The reason this is better is that it tests for some subtle problems that the other forms miss, as discussed in the following Caution.

**Caution**

In the past, the usual tests for successful opening of a file were the following:

```
if(fin.fail()) ... // failed to open
if(!fin.good()) ... // failed to open
if (!fin) ... // failed to open
```

The `fin` object, when used in a test condition, is converted to `false` if `fin.good()` is `false` and to `true` otherwise, so the two forms are equivalent. However, these tests fail to detect one circumstance, which is attempting to open a file by using an inappropriate file mode (see the “File Modes” section, later in this chapter). The `is_open()` method catches this form of error, along with those caught by the `good()` method. However, older C++ implementations do not have `is_open()`.

**Opening Multiple Files**

You might require that a program open more than one file. The strategy for opening multiple files depends on how they will be used. If you need two files open simultaneously, you must create a separate stream for each file. For example, a program that collates two sorted files into a third file would create two `ifstream` objects for the two input files and an `ofstream` object for the output file. The number of files you can open simultaneously depends on the operating system.

However, you may plan to process a group of files sequentially. For example, you might want to count how many times a name appears in a set of 10 files. In this case, you can open a single stream and associate it with each file in turn. This conserves computer resources more effectively than opening a separate stream for each file. To use this approach, you declare an `ifstream` object without initializing it and then use the `open()` method to associate the stream with a file. For example, this is how you could handle reading two files in succession:

```
ifstream fin; // create stream using default constructor
fin.open("fat.txt"); // associate stream with fat.txt file
... // do stuff
fin.close(); // terminate association with fat.txt
fin.clear(); // reset fin (may not be needed)
fin.open("rat.txt"); // associate stream with rat.txt file
...
fin.close();
```

We’ll look at an example shortly, but first, let’s examine a technique for feeding a list of files to a program in a manner that allows the program to use a loop to process them.

**Command-Line Processing**

File-processing programs often use command-line arguments to identify files. *Command-line arguments* are arguments that appear on the command line when you type a

command. For example, to count the number of words in some files on a Unix or Linux system, you would type this command at the command-line prompt:

```
wc report1 report2 report3
```

Here `wc` is the program name, and `report1`, `report2`, and `report3` are filenames passed to the program as command-line arguments.

C++ has a mechanism for letting a program running in a command-line environment access the command-line arguments. You can use the following alternative function heading for `main()`:

```
int main(int argc, char *argv[])
```

The `argc` argument represents the number of arguments on the command line. The count includes the command name itself. The `argv` variable is a pointer to a pointer to a `char`. This sounds a bit abstract, but you can treat `argv` as if it were an array of pointers to the command-line arguments, with `argv[0]` being a pointer to the first character of a string holding the command name, `argv[1]` being a pointer to the first character of a string holding the first command-line argument, and so on. That is, `argv[0]` is the first string from the command line, and so on. For example, suppose you have the following command line:

```
wc report1 report2 report3
```

In this case, `argc` would be 4, `argv[0]` would be `wc`, `argv[1]` would be `report1`, and so on. The following loop would print each command-line argument on a separate line:

```
for (int i = 1; i < argc; i++)
    cout << argv[i] << endl;
```

Starting with `i = 1` just prints the command-line arguments; starting with `i = 0` would print the command name as well.

Command-line arguments, of course, go hand-in-hand with command-line operating systems such as the Windows command prompt mode, Unix, and Linux. Other setups may still allow you to use command-line arguments:

- Many Windows IDEs (Integrated Development Environments) have an option for providing command-line arguments. Typically, you have to navigate through a series of menu choices that lead to a box into which you can type the command-line arguments. The exact set of steps varies from vendor to vendor and from upgrade to upgrade, so check your documentation.
- Many Windows IDEs can produce executable files that run under in the Windows command prompt mode.

Listing 17.17 combines the command-line technique with file stream techniques to count characters in files listed on the command line.

Listing 17.17 `count.cpp`

---

```

// count.cpp -- counting characters in a list of files
#include <iostream>
#include <fstream>
#include <cstdlib> // for exit()
int main(int argc, char * argv[])
{
    using namespace std;
    if (argc == 1) // quit if no arguments
    {
        cerr << "Usage: " << argv[0] << " filename[s]\n";
        exit(EXIT_FAILURE);
    }

    ifstream fin; // open stream
    long count;
    long total = 0;
    char ch;

    for (int file = 1; file < argc; file++)
    {
        fin.open(argv[file]); // connect stream to argv[file]
        if (!fin.is_open())
        {
            cerr << "Could not open " << argv[file] << endl;
            fin.clear();
            continue;
        }
        count = 0;
        while (fin.get(ch))
            count++;
        cout << count << " characters in " << argv[file] << endl;
        total += count;
        fin.clear(); // needed for some implementations
        fin.close(); // disconnect file
    }
    cout << total << " characters in all files\n";

    return 0;
}

```

---

**Note**

Some C++ implementations require using `fin.clear()` at the end of the program, and others do not. It depends on whether associating a new file with the `ifstream` object automatically resets the stream state. It does no harm to use `fin.clear()` even if it isn't needed.



On a Linux system, for example, you could compile Listing 17.17 to an executable file called `a.out`. Then sample runs could look like this:

```
$ a.out
Usage: a.out filename[s]
$ a.out paris rome
3580 characters in paris
4886 characters in rome
8466 characters in all files
$
```

Note that the program uses `cerr` for the error message. A minor point is that the message uses `argv[0]` instead of `a.out`:

```
cerr << "Usage: " << argv[0] << " filename[s]\n";
```

This way, if you change the name of the executable file, the program will automatically use the new name.

The program uses the `is_open()` method to verify that it was able to open the requested file. Let's examine that matter further.

## File Modes

The file mode describes how a file is to be used: read it, write to it, append it, and so on. When you associate a stream with a file, either by initializing a file stream object with a filename or by using the `open()` method, you can provide a second argument that specifies the file mode:

```
ifstream fin("banjo", mode1); // constructor with mode argument
ofstream fout();
fout.open("harp", mode2); // open() with mode arguments
```

The `ios_base` class defines an `openmode` type to represent the mode; like the `fmtflags` and `iostate` types, it is a `bitmask` type. (In the old days, it was type `int`.) You can choose from several constants defined in the `ios_base` class to specify the mode. Table 17.7 lists the constants and their meanings. C++ file I/O has undergone several changes to make it compatible with ANSI C file I/O.

Table 17.7 File Mode Constants

| Constant                      | Meaning                                |
|-------------------------------|----------------------------------------|
| <code>ios_base::in</code>     | Open file for reading.                 |
| <code>ios_base::out</code>    | Open file for writing.                 |
| <code>ios_base::ate</code>    | Seek to end-of-file upon opening file. |
| <code>ios_base::app</code>    | Append to end-of-file.                 |
| <code>ios_base::trunc</code>  | Truncate file if it exists.            |
| <code>ios_base::binary</code> | Binary file.                           |

If the `ifstream` and `ofstream` constructors and the `open()` methods each take two arguments, how have we gotten by using just one in the previous examples? As you have probably guessed, the prototypes for these class member functions provide default values for the second argument (the file mode argument). For example, the `ifstream open()` method and constructor use `ios_base::in` (open for reading) as the default value for the mode argument, and the `ofstream open()` method and constructor use `ios_base::out | ios_base::trunc` (open for writing and truncate the file) as the default. The bitwise OR operator (`|`) is used to combine two bit values into a single value that can be used to set both bits. The `fstream` class doesn't provide a mode default, so you have to provide a mode explicitly when creating an object of that class.

Note that the `ios_base::trunc` flag means an existing file is truncated when opened to receive program output; that is, its previous contents are discarded. Although this behavior commendably minimizes the danger of running out of disk space, you can probably imagine situations in which you don't want to wipe out a file when you open it. Of course, C++ provides other choices. If, for example, you want to preserve the file contents and add (append) new material to the end of the file, you can use the `ios_base::app` mode:

```
ofstream fout("bagels", ios_base::out | ios_base::app);
```

Again, the code uses the `|` operator to combine modes. So `ios_base::out | ios_base::app` means to invoke both the `out` mode and the `app` mode (see Figure 17.6).

You can expect to find some differences among older C++ implementations. For example, some allow you to omit the `ios_base::out` in the previous example, and some don't. If you aren't using the default mode, the safest approach is to provide all the mode elements explicitly. Some compilers don't support all the choices in Table 17.6, and some may offer choices beyond those in the table. One consequence of these differences is that you may have to make some alterations in the following examples to use them on your system. The good news is that the development of the C++ Standard is providing greater uniformity.

Standard C++ defines parts of file I/O in terms of ANSI C standard I/O equivalents. A C++ statement like

```
ifstream fin(filename, cplusplusmode);
```

is implemented as if it uses the C `fopen()` function:

```
fopen(filename, cmode);
```

Here `cplusplusmode` is a type `openmode` value, such as `ios_base::in`, and `cmode` is the corresponding C-mode string, such as `"r"`. Table 17.8 shows the correspondence between C++ modes and C modes. Note that `ios_base::out` by itself causes truncation but that it doesn't cause truncation when combined with `ios_base::in`. Unlisted combinations, such as `ios_base::in | ios_base::trunc`, prevent the file from being opened. The `is_open()` method detects this failure.

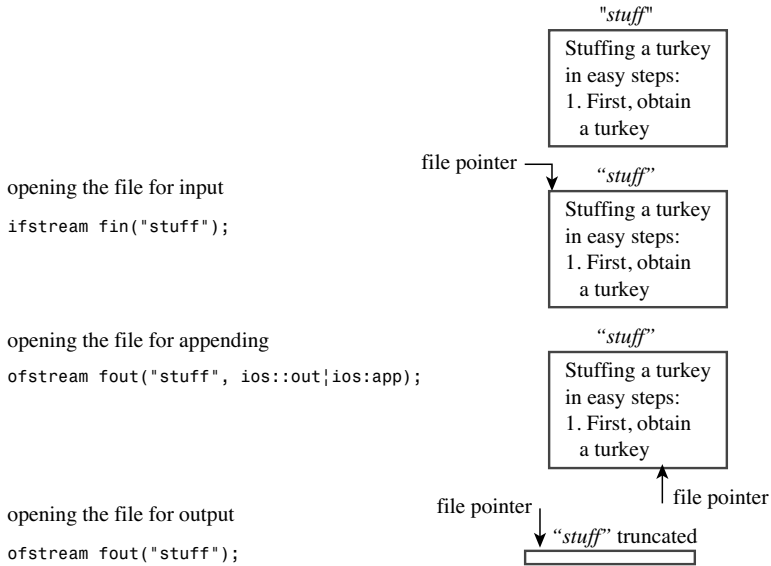

Figure 17.6 Some file-opening modes.

Table 17.8 C++ and C File-Opening Modes

| C++ mode                                                    | C mode   | Meaning                                                                                                                                                                                                                                                 |
|-------------------------------------------------------------|----------|---------------------------------------------------------------------------------------------------------------------------------------------------------------------------------------------------------------------------------------------------------|
| <code>ios_base::in</code>                                   | "r"      | Open for reading.                                                                                                                                                                                                                                       |
| <code>ios_base::out</code>                                  | "w"      | (Same as <code>ios_base::out   ios_base::trunc</code> .)                                                                                                                                                                                                |
| <code>ios_base::out   ios_base::trunc</code>                | "w"      | Open for writing, truncating file if it already exists.                                                                                                                                                                                                 |
| <code>ios_base::out   ios_base::app</code>                  | "a"      | Open for writing, append only.                                                                                                                                                                                                                          |
| <code>ios_base::in   ios_base::out</code>                   | "r+"     | Open for reading and writing, with writing permitted anywhere in the file.                                                                                                                                                                              |
| <code>ios_base::in   ios_base::out   ios_base::trunc</code> | "w+"     | Open for reading and writing, first truncating file if it already exists.                                                                                                                                                                               |
| <code>c++mode   ios_base::binary</code>                     | "cmodeb" | Open in <i>c++mode</i> or corresponding <i>cmode</i> and in binary mode; for example, <code>ios_base::in   ios_base::binary</code> becomes "rb".                                                                                                        |
| <code>c++mode   ios_base::ate</code>                        | "cmode"  | Open in indicated mode and go to end of file. C uses a separate function call instead of a mode code. For example, <code>ios_base::in   ios_base::ate</code> translates to the "r" mode and the C function call <code>fseek(file, 0, SEEK_END)</code> . |

Note that both `ios_base::ate` and `ios_base::app` place you (or, more precisely, a file pointer) at the end of the file just opened. The difference between the two is that the `ios_base::app` mode allows you to add data to the end of the file only, while the `ios_base::ate` mode merely positions the pointer at the end of the file.

Clearly, there are many possible combinations of modes. We'll look at a few representative ones.

## Appending to a File

Let's look at a program that appends data to the end of a file. The program maintains a file that contains a guest list. When the program begins, it displays the current contents of the file, if it exists. It can use the `is_open()` method after attempting to open the file to check whether the file exists. Next, the program opens the file for output, using the `ios_base::app` mode. Then it solicits input from the keyboard to add to the file. Finally, the program displays the revised file contents. Listing 17.18 illustrates how to accomplish these goals. Note how the program uses the `is_open()` method to test whether the file has been opened successfully.

### Note

File I/O was perhaps the least standardized aspect of C++ in its earlier days, and many older compilers don't quite conform to the current standard. Some, for example, used modes such as `nocreate` that are not part of the current standard. Also only some compilers require the `fin.clear()` call before opening the same file a second time for reading.

### Listing 17.18 `append.cpp`

---

```
// append.cpp -- appending information to a file
#include <iostream>
#include <fstream>
#include <string>
#include <cstdlib>      // (for exit())

const char * file = "guests.txt";
int main()
{
    using namespace std;
    char ch;
```

```
// show initial contents
ifstream fin;
fin.open(file);

if (fin.is_open())
{
    cout << "Here are the current contents of the "
        << file << " file:\n";
    while (fin.get(ch))
        cout << ch;
    fin.close();
}

// add new names
ofstream fout(file, ios::out | ios::app);
if (!fout.is_open())
{
    cerr << "Can't open " << file << " file for output.\n";
    exit(EXIT_FAILURE);
}

cout << "Enter guest names (enter a blank line to quit):\n";
string name;
while (getline(cin,name) && name.size() > 0)
{
    fout << name << endl;
}
fout.close();

// show revised file
fin.clear(); // not necessary for some compilers
fin.open(file);
if (fin.is_open())
{
    cout << "Here are the new contents of the "
        << file << " file:\n";
    while (fin.get(ch))
        cout << ch;
    fin.close();
}
cout << "Done.\n";
return 0;
}
```

---

Here's a sample first run of the program in Listing 17.18:

```
Enter guest names (enter a blank line to quit):
```

```
Genghis Kant
Hank Attila
Charles Bigg
```

```
Here are the new contents of the guests.txt file:
```

```
Genghis Kant
Hank Attila
Charles Bigg
Done.
```

At this point the `guests.txt` file hasn't been created, so the program doesn't preview the file.

Next time the program is run, however, the `guests.txt` file does exist, so the program does preview the file. Also note that the new data are appended to the old file contents rather than replacing them:

```
Here are the current contents of the guests.txt file:
```

```
Genghis Kant
Hank Attila
Charles Bigg
Enter guest names (enter a blank line to quit):
Greta Greppo
LaDonna Mobile
Fannie Mae
```

```
Here are the new contents of the guests.txt file:
```

```
Ghengis Kant
Hank Attila
Charles Bigg
Greta Greppo
LaDonna Mobile
Fannie Mae
Done.
```

You should be able to read the contents of `guest.txt` with any text editor, including the editor you use to write your source code.

## Binary Files

When you store data in a file, you can store the data in text form or in binary format. Text form means you store everything as text, even numbers. For example, storing the value `-2.324216e+07` in text form means storing the 13 characters used to write this number. That requires converting the computer's internal representation of a floating-point number to character form, and that's exactly what the `<<` insertion operator does. Binary format, on the other hand, means storing the computer's internal representation of a value.

That is, instead of storing characters, the computer stores the (typically) 64-bit double representation of the value. For a character, the binary representation is the same as the text representation—the binary representation of the character’s ASCII code (or equivalent). For numbers, however, the binary representation is much different from the text representation (see Figure 17.7).

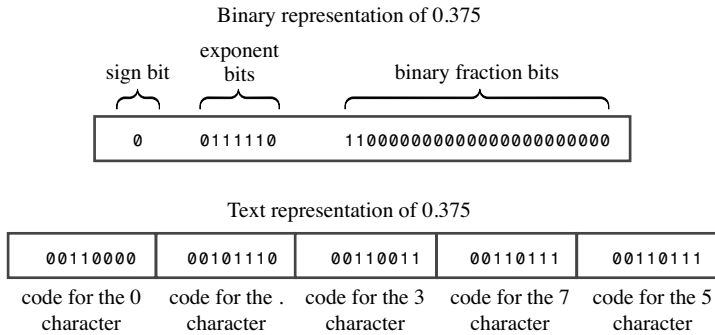

Figure 17.7 Binary and text representations of a floating-point number.

Each format has advantages. The text format is easy to read. With it, you can use an ordinary editor or word processor to read and edit a text file. You can easily transfer a text file from one computer system to another. The binary format is more accurate for numbers because it stores the exact internal representation of a value. There are no conversion errors or round-off errors. Saving data in binary format can be faster because there is no conversion and because you may be able to save data in larger chunks. And the binary format usually takes less space, depending on the nature of the data. Transferring to another system can be a problem, however, if the new system uses a different internal representation for values. Even different compilers on the same system may use different internal representations for structure layouts. In these cases, you (or someone) may have to write a program to translate one data format to another.

Let’s look at a more concrete example. Consider the following structure definition and declaration:

```
const int LIM = 20;
struct planet
{
    char name[LIM];        // name of planet
    double population;    // its population
    double g;             // its acceleration of gravity
};
planet pl;
```

To save the contents of the structure `pl` in text form, you can use this:

```
ofstream fout("planets.dat", ios_base::out | ios_base::app);
fout << pl.name << " " << pl.population << " " << pl.g << "\n";
```

Note that you have to provide each structure member explicitly by using the membership operator, and you have to separate adjacent data for legibility. If the structure contains, say, 30 members, this could get tedious.

To save the same information in binary format, you can use this:

```
ofstream fout("planets.dat",
             ios_base::out | ios_base::app | ios_base::binary);
fout.write( (char *) &pl, sizeof pl);
```

This code saves the entire structure as a single unit, using the computer's internal representation of data. You won't be able to read the file as text, but the information will be stored more compactly and precisely than as text. And it is certainly easier to type the code. This approach makes two changes:

- It uses a binary file mode.
- It uses the `write()` member function.

Let's examine these changes more closely.

Some systems, such as Windows, support two file formats: text and binary. If you want to save data in binary form, you should use the binary file format. In C++ you do so by using the `ios_base::binary` constant in the file mode. If you want to know why you should do this on a Windows system, check the discussion in the following sidebar, "Binary Files and Text Files."

### Binary Files and Text Files

Using a binary file mode causes a program to transfer data from memory to a file, or vice versa, without any hidden translation taking place. Such is not necessarily the case for the default text mode. For example, consider Windows text files. They represent a newline with a two-character combination: carriage return, linefeed. Macintosh text files represent a newline with a carriage return. Unix and Linux files represent a newline with a linefeed. C++, which grew up on Unix, also represents a newline with a linefeed. For portability, a Windows C++ program automatically translates the C++ newline to a carriage return and linefeed when writing to a text mode file; and a Macintosh C++ program translates the newline to a carriage return when writing to a file. When reading a text file, these programs convert the local newline back to the C++ form. The text format can cause problems with binary data because a byte in the middle of a `double` value could have the same bit pattern as the ASCII code for the newline character. Also there are differences in how end-of-file is detected. So you should use the binary file mode when saving data in binary format. (Unix systems have just one file mode, so on them the binary mode is the same as the text mode.)

To save data in binary form instead of text form, you can use the `write()` member function. This method, recall, copies a specified number of bytes from memory to a file. This chapter used it earlier to copy text, but it will copy any type of data byte-by-byte



with no conversion. For example, if you pass to it the address of a `long` variable and tell it to copy 4 bytes, it will copy the 4 bytes constituting the `long` value verbatim to a file and not convert it to text. The only awkwardness is that you have to type cast the address to type pointer-to-char. You can use the same approach to copy an entire `planet` structure. To get the number of bytes, you use the `sizeof` operator:

```
fout.write( (char *) &p1, sizeof p1);
```

This statement causes the program to go to the address of the `p1` structure and copy the 36 bytes (the value of the `sizeof p1` expression) beginning at this address to the file connected to `fout`.

To recover the information from a file, you use the corresponding `read()` method with an `ifstream` object:

```
ifstream fin("planets.dat", ios_base::in | ios_base::binary);
fin.read((char *) &p1, sizeof p1);
```

This copies `sizeof p1` bytes from the file to the `p1` structure. This same approach can be used with classes that don't use virtual functions. In that case, just the data members are saved, not the methods. If the class does have virtual methods, then a hidden pointer to a table of pointers to virtual functions is also copied. Because the next time you run the program it might locate the virtual function table at a different location, copying old pointer information into objects from a file can create havoc. (Also see the Note in Programming Exercise 6.)

### Tip

The `read()` and `write()` member functions complement each other. You use `read()` to recover data that has been written to a file with `write()`.

Listing 17.19 uses these methods to create and read a binary file. In form, the program is similar to Listing 17.18, but it uses `write()` and `read()` instead of the insertion operator and the `get()` method. It also uses manipulators to format the screen output.

### Note

Although the binary file concept is part of ANSI C, some C and C++ implementations do not provide support for the binary file mode. The reason for this oversight is that some systems have only one file type in the first place, so you can use binary operations such as `read()` and `write()` with the standard file format. Therefore, if your implementation rejects `ios_base::binary` as a valid constant, you can just omit it from your program. If your implementation doesn't support the `fixed` and `right` manipulators, you can use `cout.setf(ios_base::fixed, ios_base::floatfield)` and `cout.setf(ios_base::right, ios_base::adjustfield)`. Also you may have to substitute `ios` for `ios_base`. Other compilers, particularly older ones, may have other idiosyncrasies.

Listing 17.19 **binary.cpp**

---

```

// binary.cpp -- binary file I/O
#include <iostream> // not required by most systems
#include <fstream>
#include <iomanip>
#include <cstdlib> // for exit()

inline void eatline() { while (std::cin.get() != '\n') continue; }
struct planet
{
    char name[20]; // name of planet
    double population; // its population
    double g; // its acceleration of gravity
};

const char * file = "planets.dat";

int main()
{
    using namespace std;
    planet pl;
    cout << fixed << right;

    // show initial contents
    ifstream fin;
    fin.open(file, ios_base::in | ios_base::binary); // binary file
    //NOTE: some systems don't accept the ios_base::binary mode
    if (fin.is_open())
    {
        cout << "Here are the current contents of the "
             << file << " file:\n";
        while (fin.read((char *) &pl, sizeof pl))
        {
            cout << setw(20) << pl.name << ": "
                 << setprecision(0) << setw(12) << pl.population
                 << setprecision(2) << setw(6) << pl.g << endl;
        }
        fin.close();
    }

    // add new data
    ofstream fout(file,
                  ios_base::out | ios_base::app | ios_base::binary);
    //NOTE: some systems don't accept the ios::binary mode
    if (!fout.is_open())
    {

```

```

        cerr << "Can't open " << file << " file for output:\n";
        exit(EXIT_FAILURE);
    }

    cout << "Enter planet name (enter a blank line to quit):\n";
    cin.get(pl.name, 20);
    while (pl.name[0] != '\0')
    {
        eatline();
        cout << "Enter planetary population: ";
        cin >> pl.population;
        cout << "Enter planet's acceleration of gravity: ";
        cin >> pl.g;
        eatline();
        fout.write((char *) &pl, sizeof pl);
        cout << "Enter planet name (enter a blank line "
            "to quit):\n";
        cin.get(pl.name, 20);
    }
    fout.close();

// show revised file
    fin.clear(); // not required for some implementations, but won't hurt
    fin.open(file, ios_base::in | ios_base::binary);
    if (fin.is_open())
    {
        cout << "Here are the new contents of the "
            << file << " file:\n";
        while (fin.read((char *) &pl, sizeof pl))
        {
            cout << setw(20) << pl.name << ": "
                << setprecision(0) << setw(12) << pl.population
                << setprecision(2) << setw(6) << pl.g << endl;
        }
        fin.close();
    }
    cout << "Done.\n";
    return 0;
}

```

---

Here is a sample initial run of the program in Listing 17.19:

```

Enter planet name (enter a blank line to quit):
Earth
Enter planetary population: 6928198253
Enter planet's acceleration of gravity: 9.81

```

```
Enter planet name (enter a blank line to quit):
```

```
Here are the new contents of the planets.dat file:
```

```
Earth: 6928198253 9.81
```

```
Done.
```

And here is a sample follow-up run:

```
Here are the current contents of the planets.dat file:
```

```
Earth: 6928198253 9.81
```

```
Enter planet name (enter a blank line to quit):
```

```
Jenny's World
```

```
Enter planetary population: 32155648
```

```
Enter planet's acceleration of gravity: 8.93
```

```
Enter planet name (enter a blank line to quit):
```

```
Here are the new contents of the planets.dat file:
```

```
Earth: 6928198253 9.81
```

```
Jenny's World: 32155648 8.93
```

```
Done.
```

You've already seen the major features of the program, but let's re-examine an old point. The program uses this code (in the form of the inline `eatline()` function) after reading the planet's `g` value:

```
while (std::cin.get() != '\n') continue;
```

This reads and discards input up through the newline character. Consider the next input statement in the loop:

```
cin.get(pl.name, 20);
```

If the newline were left in place, this statement would read the newline as an empty line, terminating the loop.

You might wonder if this program could use a `string` object instead of a character array for the `name` member of the `planet` structure. The answer is no—at least not without major changes in design. The problem is that a `string` object doesn't actually contain the string within itself; instead, it contains a pointer to the memory location where the string is stored. So if you copy the structure to a file, you don't copy the string data, you just copy the address of where the string was stored. When you run the program again, that address is meaningless.

## Random Access

For our last file example, let's look at random access. *Random access* means moving directly to any location in the file instead of moving through it sequentially. The random access approach is often used with database files. A program will maintain a separate index file, giving the location of data in the main data file. Then it can jump directly to that location, read the data there, and perhaps modify it. This approach is done most simply if the file

consists of a collection of equal-sized records. Each record represents a related collection of data. For example, in the example in Listing 17.19, each file record would represent all the data about a particular planet. A file record corresponds rather naturally to a program structure or class.

This example is based on the binary file program in Listing 17.19, to take advantage of the fact that the `planet` structure provides a pattern for a file record. To add to the creative tension of programming, the example opens the file in a read-and-write mode so that it can both read and modify a record. You can do this by creating an `fstream` object. The `fstream` class derives from the `iostream` class, which, in turn, is based on both the `istream` and `ostream` classes, so it inherits the methods of both. It also inherits two buffers, one for input and one for output, and synchronizes the handling of the two buffers. That is, as the program reads the file or writes to it, it moves both an input pointer in the input buffer and an output pointer in the output buffer in tandem.

The example does the following:

1. Displays the current contents of the `planets.dat` file.
2. Asks which record you want to modify.
3. Modifies that record.
4. Shows the revised file.

A more ambitious program would use a menu and a loop to let you select from the list of actions indefinitely, but this version performs each action just once. This simplified approach allows you to examine several aspects of read/write files without getting bogged down in matters of program design.

### Caution

This program assumes that the `planets.dat` file already exists and was created by the `binary.cpp` program in Listing 17.19.

The first question to answer is what file mode to use. In order to read the file, you need the `ios_base::in` mode. For binary I/O, you need the `ios_base::binary` mode. (Again, on some nonstandard systems you can omit—indeed, you may have to omit—this mode.) In order to write to the file, you need the `ios_base::out` or the `ios_base::app` mode. However, the append mode allows a program to add data to the end of the file only. The rest of the file is read-only; that is, you can read the original data but not modify it—so, to be able to modify the data, you have to use `ios_base::out`. As Table 17.8 indicates, using the `in` and `out` modes simultaneously provides a read/write mode, so you just have to add the binary element. As mentioned earlier, you use the `|` operator to combine modes. Thus, you need the following statement to set up business:

```
finout.open(file,ios_base::in | ios_base::out | ios_base::binary);
```

Next, you need a way to move through a file. The `fstream` class inherits two methods for this: `seekg()` moves the input pointer to a given file location, and `seekp()` moves the output pointer to a given file location. (Actually, because the `fstream` class uses buffers

for intermediate storage of data, the pointers point to locations in the buffers, not in the actual file.) You can also use `seekg()` with an `ifstream` object and `seekp()` with an `ofstream` object. Here are the `seekg()` prototypes:

```
basic_istream<charT,traits>& seekg(off_type, ios_base::seekdir);
basic_istream<charT,traits>& seekg(pos_type);
```

As you can see, they are templates. This chapter uses a template specialization for the `char` type. For the `char` specialization, the two prototypes are equivalent to the following:

```
istream & seekg(streamoff, ios_base::seekdir);
istream & seekg(streampos);
```

The first prototype represents locating a file position measured, in bytes, as an offset from a file location specified by the second argument. The second prototype represents locating a file position measured, in bytes, from the beginning of a file.

### Type Escalation

When C++ was young, life was simpler for the `seekg()` methods. The `streamoff` and `streampos` types were typedefs for some standard integer type, such as `long`. However, the quest for creating a portable standard had to deal with the realization that an integer argument might not provide enough information for some file systems, so `streamoff` and `streampos` were allowed to be structure or class types, as long as they allowed some basic operations, such as using an integer value as an initialization value. Next, the old `istream` class was replaced with the `basic_istream` template, and `streampos` and `streamoff` were replaced with the template-based types `pos_type` and `off_type`. However, `streampos` and `streamoff` continue to exist as `char` specializations of `pos_type` and `off_type`. Similarly, you can use the `wstreampos` and `wstreamoff` types if you use `seekg()` with a `wistream` object.

Let's take a look at the arguments to the first prototype of `seekg()`. Values of the `streamoff` type are used to measure offsets, in bytes, from a particular location in a file. The `streamoff` argument represents the file position, in bytes, measured as an offset from one of three locations. (The type may be defined as an integer type or as a class.) The `seek_dir` argument is another integer type that is defined, along with three possible values, in the `ios_base` class. The constant `ios_base::beg` means measure the offset from the beginning of the file. The constant `ios_base::cur` means measure the offset from the current position. The constant `ios_base::end` means measure the offset from the end of the file. Here are some sample calls, assuming that `fin` is an `ifstream` object:

```
fin.seekg(30, ios_base::beg); // 30 bytes beyond the beginning
fin.seekg(-1, ios_base::cur); // back up one byte
fin.seekg(0, ios_base::end); // go to the end of the file
```

Now let's look at the second prototype. Values of the `streampos` type locate a position in a file. It can be a class, but, if so, the class includes a constructor with a `streamoff` argument and a constructor with an integer argument, providing a path to convert both types to `streampos` values. A `streampos` value represents an absolute location in a file, measured

from the beginning of the file. You can treat a `streampos` position as if it measures a file location in bytes from the beginning of a file, with the first byte being byte 0. So the following statement locates the file pointer at byte 112, which would be the 113th byte in the file:

```
fin.seekg(112);
```

If you want to check the current position of a file pointer, you can use the `tellg()` method for input streams and the `tellp()` methods for output streams. Each returns a `streampos` value representing the current position, in bytes, measured from the beginning of the file. When you create an `fstream` object, the input and output pointers move in tandem, so `tellg()` and `tellp()` return the same value. But if you use an `istream` object to manage the input stream and an `ostream` object to manage the output stream to the same file, the input and output pointers move independently of one another, and `tellg()` and `tellp()` can return different values.

You can then use `seekg()` to go to the file beginning. Here is a section of code that opens a file, goes to the beginning, and displays the file contents:

```
fstream finout;      // read and write streams
finout.open(file,ios::in | ios::out |ios::binary);
//NOTE: Some Unix systems require omitting | ios::binary
int ct = 0;
if (finout.is_open())
{
    finout.seekg(0);    // go to beginning
    cout << "Here are the current contents of the "
         << file << " file:\n";
    while (finout.read((char *) &pl, sizeof pl))
    {
        cout << ct++ << ": " << setw(LIM) << pl.name << ": "
             << setprecision(0) << setw(12) << pl.population
             << setprecision(2) << setw(6) << pl.g << endl;
    }
    if (finout.eof())
        finout.clear(); // clear eof flag
    else
    {
        cerr << "Error in reading " << file << ".\n";
        exit(EXIT_FAILURE);
    }
}
else
{
    cerr << file << " could not be opened -- bye.\n";
    exit(EXIT_FAILURE);
}
```

This is similar to the start of Listing 17.19, but there are some changes and additions. First, as just described, the program uses an `fstream` object with a read/write mode, and it uses `seekg()` to position the file pointer at the start of the file. (This isn't really needed for this example, but it shows how `seekg()` is used.) Next, the program makes the minor change of numbering the records as they are displayed. Then it makes the following important addition:

```
if (finout.eof())
    finout.clear(); // clear eof flag
else
{
    cerr << "Error in reading " << file << ".\n";
    exit(EXIT_FAILURE);
}
```

The problem this code addresses is that when the program finishes reading and displaying the entire file, it sets the `eofbit` element. This convinces the program that it's finished with the file and disables any further reading of or writing to the file. Using the `clear()` method resets the stream state, turning off `eofbit`. Now the program can once again access the file. The `else` part handles the possibility that the program quits reading the file for some reason other than reaching the end-of-file, such as a hardware failure.

The next step is to identify the record to be changed and then change it. To do this, the program asks the user to enter a record number. Multiplying the number by the number of bytes in a record yields the byte number for the beginning of the record. If `record` is the record number, the desired byte number is `record * sizeof pl`:

```
cout << "Enter the record number you wish to change: ";
long rec;
cin >> rec;
eatline(); // get rid of newline
if (rec < 0 || rec >= ct)
{
    cerr << "Invalid record number -- bye\n";
    exit(EXIT_FAILURE);
}
streampos place = rec * sizeof pl; // convert to streampos type
finout.seekg(place); // random access
```

The variable `ct` represents the number of records; the program exits if you try to go beyond the limits of the file.

Next, the program displays the current record:

```
finout.read((char *) &pl, sizeof pl);
cout << "Your selection:\n";
cout << rec << ": " << setw(LIM) << pl.name << ": "
<< setprecision(0) << setw(12) << pl.population
<< setprecision(2) << setw(6) << pl.g << endl;
if (finout.eof())
    finout.clear(); // clear eof flag
```



After displaying the record, the program lets you change the record:

```
cout << "Enter planet name: ";
cin.get(pl.name, LIM);
eatline();
cout << "Enter planetary population: ";
cin >> pl.population;
cout << "Enter planet's acceleration of gravity: ";
cin >> pl.g;
finout.seekp(place); // go back
finout.write((char *) &pl, sizeof pl) << flush;

if (finout.fail())
{
    cerr << "Error on attempted write\n";
    exit(EXIT_FAILURE);
}
```

The program flushes the output to guarantee that the file is updated before proceeding to the next stage.

Finally, to display the revised file, the program uses `seekg()` to reset the file pointer to the beginning. Listing 17.20 shows the complete program. Don't forget that it assumes that a `planets.dat` file created using the `binary.cpp` program is available.

### Note

The older the implementation, the more likely it is to run afoul of the C++ Standard. Some systems don't recognize the binary flag, the `fixed` and `right` manipulators, and `ios_base`.

#### Listing 17.20 `random.cpp`

---

```
// random.cpp -- random access to a binary file
#include <iostream> // not required by most systems
#include <fstream>
#include <iomanip>
#include <cstdlib> // for exit()
const int LIM = 20;
struct planet
{
    char name[LIM]; // name of planet
    double population; // its population
    double g; // its acceleration of gravity
};

const char * file = "planets.dat"; // ASSUMED TO EXIST (binary.cpp example)
inline void eatline() { while (std::cin.get() != '\n') continue; }

int main()
{
```

```

using namespace std;
planet pl;
cout << fixed;

// show initial contents
fstream finout;    // read and write streams
finout.open(file,
             ios_base::in | ios_base::out | ios_base::binary);
//NOTE: Some Unix systems require omitting | ios::binary
int ct = 0;
if (finout.is_open())
{
    finout.seekg(0);    // go to beginning
    cout << "Here are the current contents of the "
         << file << " file:\n";
    while (finout.read((char *) &pl, sizeof pl))
    {
        cout << ct++ << ": " << setw(LIM) << pl.name << ": "
             << setprecision(0) << setw(12) << pl.population
             << setprecision(2) << setw(6) << pl.g << endl;
    }
    if (finout.eof())
        finout.clear(); // clear eof flag
    else
    {
        cerr << "Error in reading " << file << ".\n";
        exit(EXIT_FAILURE);
    }
}
else
{
    cerr << file << " could not be opened -- bye.\n";
    exit(EXIT_FAILURE);
}

// change a record
cout << "Enter the record number you wish to change: ";
long rec;
cin >> rec;
eatline();    // get rid of newline
if (rec < 0 || rec >= ct)
{
    cerr << "Invalid record number -- bye\n";
    exit(EXIT_FAILURE);
}
streampos place = rec * sizeof pl; // convert to streampos type
finout.seekg(place);    // random access

```

```

    if (finout.fail())
    {
        cerr << "Error on attempted seek\n";
        exit(EXIT_FAILURE);
    }

    finout.read((char *) &pl, sizeof pl);
    cout << "Your selection:\n";
    cout << rec << ": " << setw(LIM) << pl.name << ": "
        << setprecision(0) << setw(12) << pl.population
        << setprecision(2) << setw(6) << pl.g << endl;
    if (finout.eof())
        finout.clear();    // clear eof flag

    cout << "Enter planet name: ";
    cin.get(pl.name, LIM);
    eatline();
    cout << "Enter planetary population: ";
    cin >> pl.population;
    cout << "Enter planet's acceleration of gravity: ";
    cin >> pl.g;
    finout.seekp(place);    // go back
    finout.write((char *) &pl, sizeof pl) << flush;
    if (finout.fail())
    {
        cerr << "Error on attempted write\n";
        exit(EXIT_FAILURE);
    }

// show revised file
    ct = 0;
    finout.seekg(0);    // go to beginning of file
    cout << "Here are the new contents of the " << file
        << " file:\n";
    while (finout.read((char *) &pl, sizeof pl))
    {
        cout << ct++ << ": " << setw(LIM) << pl.name << ": "
            << setprecision(0) << setw(12) << pl.population
            << setprecision(2) << setw(6) << pl.g << endl;
    }
    finout.close();
    cout << "Done.\n";
    return 0;
}

```

---

Here's a sample run of the program in Listing 17.20, based on a `planets.dat` file that has had a few more entries added since you last saw it:

Here are the current contents of the `planets.dat` file:

```
0:           Earth:  6928198253  9.81
1:       Jenny's World:  32155648  8.93
2:           Tramtor: 89000000000 15.03
3:           Trellan:  5214000  9.62
4:       Freestone:  3945851000  8.68
5:       Taanagoot:  361000004 10.23
6:           Marin:   252409  9.79
```

Enter the record number you wish to change: 2

Your selection:

```
2:           Tramtor: 89000000000 15.03
```

Enter planet name: **Trantor**

Enter planetary population: **89521844777**

Enter planet's acceleration of gravity: **10.53**

Here are the new contents of the `planets.dat` file:

```
0:           Earth:  6928198253  9.81
1:       Jenny's World:  32155648  8.93
2:           Trantor: 89521844777 10.53
3:           Trellan:  5214000  9.62
4:       Freestone:  3945851000  8.68
5:       Taanagoot:  361000004 10.23
6:           Marin:   252409  9.79
```

Done.

By using the techniques in this program, you can extend it so that it allows you to add new material and delete records. If you were to expand the program, it would be a good idea to reorganize it by using classes and functions. For example, you could convert the planet structure to a class definition; then you could overload the `<<` insertion operator so that `cout << p1` displays the class data members formatted as in the example. Also the example doesn't bother to verify input, so you could add code to check for numeric input where appropriate.

## Working with Temporary Files

Developing applications often requires the use of temporary files whose lifetimes are transient and must be controlled by the program. Have you ever thought about how to go about this in C++? It's really quite easy to create a temporary file, copy the contents of another file, and delete the file. First of all, you need to come up with a naming scheme for your temporary file(s). But wait...how can you ensure that each file is assigned a unique name? The `tmpnam()` standard function declared in `cstdio` has you covered:

```
char* tmpnam( char* pszName );
```

The `tmpnam()` function creates a temporary name and places it in the C-style string that is pointed to by `pszName`. The constants `L_tmpnam` and `TMP_MAX`, both defined in `cstdio`,

limit the number of characters in the filename and the maximum number of times `tmpnam()` can be called without generating a duplicate filename in the current directory. The following example generates 10 temporary names:

```
#include <cstdio>
#include <iostream>

int main()
{
    using namespace std;
    cout << "This system can generate up to " << TMP_MAX
        << " temporary names of up to " << L_tmpnam
        << " characters.\n";
    char pszName[ L_tmpnam ] = {'\0'};
    cout << "Here are ten names:\n";
    for( int i=0; 10 > i; i++ )
    {
        tmpnam( pszName );
        cout << pszName << endl;
    }
    return 0;
}
```

More generally, by using `tmpnam()`, you can now generate `TMP_NAM` unique filenames with up to `L_tmpnam` characters per name. The names themselves depend on the compiler. You can run this program to see what names your compiler comes up with.

## Incore Formatting

The `iostream` family supports I/O between a program and a terminal. The `fstream` family uses the same interface to provide I/O between a program and a file. The C++ library also provides an `sstream` family, which uses the same interface to provide I/O between a program and a `string` object. That is, you can use the same `ostream` methods you've used with `cout` to write formatted information into a `string` object, and you can use `istream` methods such as `getline()` to read information from a `string` object. The process of reading formatted information from a `string` object or of writing formatted information to a `string` object is termed *incore* formatting. Let's take a brief look at these facilities. (The `sstream` family of `string` support supersedes the `strstream.h` family of `char`-array support.)

The `sstream` header file defines an `ostringstream` class that is derived from the `ostream` class. (There is also a `wostream` class based on `wostream`, for wide character sets.) If you create an `ostringstream` object, you can write information to it, which it stores. You can use the same methods with an `ostringstream` object that you can with `cout`. That is, you can do something like the following:

```
ostringstream ostr;
double price = 380.0;
```

```
char * ps = " for a copy of the ISO/EIC C++ standard!";
ostr.precision(2);
ostr << fixed;
ostr << "Pay only CHF " << price << ps << endl;
```

The formatted text goes into a buffer, and the object uses dynamic memory allocation to expand the buffer size as needed. The `ostream` class has a member function, called `str()`, that returns a string object initialized to the buffer's contents:

```
string msg = ostr.str(); // returns string with formatted information
```

Using the `str()` method “freezes” the object, and you can no longer write to it. Listing 17.21 provides a short example of incore formatting.

#### Listing 17.21 `strout.cpp`

---

```
// strout.cpp -- incore formatting (output)
#include <iostream>
#include <sstream>
#include <string>
int main()
{
    using namespace std;
    stringstream ostr; // manages a string stream

    string hdisk;
    cout << "What's the name of your hard disk? ";
    getline(cin, hdisk);
    int cap;
    cout << "What's its capacity in GB? ";
    cin >> cap;
    // write formatted information to string stream
    ostr << "The hard disk " << hdisk << " has a capacity of "
        << cap << " gigabytes.\n";
    string result = ostr.str(); // save result
    cout << result; // show contents

    return 0;
}
```

---

Here's a sample run of the program in Listing 17.21:

```
What's the name of your hard disk? Datarapture
What's its capacity in GB? 2000
The hard disk Datarapture has a capacity of 2000 gigabytes.
```

The `istringstream` class lets you use the `istream` family of methods to read data from an `istringstream` object, which can be initialized from a string object.

Suppose `facts` is a `string` object. To create an `istringstream` object associated with this string, you can use the following:

```
istringstream instr(facts);    // use facts to initialize stream
```

Then you use `istream` methods to read data from `instr`. For example, if `instr` contained a bunch of integers in character format, you could read them as follows:

```
int n;
int sum = 0;
while (instr >> n)
    sum += n;
```

Listing 17.22 uses the overloaded `>>` operator to read the contents of a string one word at a time.

#### Listing 17.22 `strin.cpp`

---

```
// strin.cpp -- formatted reading from a char array
#include <iostream>
#include <sstream>
#include <string>
int main()
{
    using namespace std;
    string lit = "It was a dark and stormy day, and "
                " the full moon glowed brilliantly. ";
    istringstream instr(lit);    // use buf for input
    string word;
    while (instr >> word)        // read a word a time
        cout << word << endl;
    return 0;
}
```

---

Here is the output of the program in Listing 17.22:

```
It
was
a
dark
and
stormy
day,
and
the
full
moon
glowed
brilliantly.
```

In short, the `istream` and `ostream` classes give you the power of the `istream` and `ostream` class methods to manage character data stored in strings.

## Summary

A stream is a flow of bytes into or out of a program. A buffer is a temporary holding area in memory that acts as an intermediary between a program and a file or other I/O devices. Information can be transferred between a buffer and a file, using large chunks of data of the size most efficiently handled by devices such as disk drives. And information can be transferred between a buffer and a program in a byte-by-byte flow that often is more convenient for the processing done in a program. C++ handles input by connecting a buffered stream to a program and to its source of input. Similarly, C++ handles output by connecting a buffered stream to a program and to its output target. The `istream` and `fstream` files constitute an I/O class library that defines a rich set of classes for managing streams. C++ programs that include the `istream` file automatically open eight streams, managing them with eight objects. The `cin` object manages the standard input stream, which, by default, connects to the standard input device, typically a keyboard. The `cout` object manages the standard output stream, which, by default, connects to the standard output device, typically a monitor. The `cerr` and `clog` objects manage unbuffered and buffered streams connected to the standard error device, typically a monitor. These four objects have four wide character counterparts, named `wcin`, `wcout`, `wcerr`, and `wclog`.

The I/O class library provides a variety of useful methods. The `istream` class defines versions of the extraction operator (`>>`) that recognize all the basic C++ types and that convert character input to those types. The `get()` family of methods and the `getline()` method provide further support for single-character input and for string input. Similarly, the `ostream` class defines versions of the insertion operator (`<<`) that recognize all the basic C++ types and that convert them to suitable character output. The `put()` method provides further support for single-character output. The `wistream` and `wostream` classes provide similar support for wide characters.

You can control how a program formats output by using `ios_base` class methods and by using manipulators (functions that can be concatenated with insertion) defined in the `istream` and `omanip` files. These methods and manipulators let you control the number base, the field width, the number of decimal places displayed, the system used to display floating-point values, and other elements.

The `fstream` file provides class definitions that extend the `istream` methods to file I/O. The `ifstream` class derives from the `istream` class. By associating an `ifstream` object with a file, you can use all the `istream` methods for reading the file. Similarly, associating an `ofstream` object with a file lets you use the `ostream` methods to write to a file. And associating an `fstream` object with a file lets you employ both input and output methods with the file.

To associate a file with a stream, you can provide the filename when initializing a file stream object or you can first create a file stream object and then use the `open()` method to associate the stream with a file. The `close()` method terminates the connection



between a stream and a file. The class constructors and the `open()` method take an optional second argument that provides the file mode. The file mode determines such things as whether the file is to be read and/or written to, whether opening a file for writing truncates it, whether attempting to open a non-existent file is an error, and whether to use the binary or text mode.

A text file stores all information in character form. For example, numeric values are converted to character representations. The usual insertion and extraction operators, along with `get()` and `getline()`, support this mode. A binary file stores all information by using the same binary representation the computer uses internally. Binary files store data, particularly floating-point values, more accurately and compactly than text files, but they are less portable. The `read()` and `write()` methods support binary input and output.

The `seekg()` and `seekp()` functions provide C++ random access for files. These class methods let you position a file pointer relative to the beginning of a file, relative to the end, or relative to the current position. The `tellg()` and `tellp()` methods report the current file position.

The `sstream` header file defines `istringstream` and `ostringstream` classes that let you use `istream` and `ostream` methods to extract information from a string and to format information placed into a string.

## Chapter Review

1. What role does the `iostream` file play in C++ I/O?
2. Why does typing a number such as 121 as input require a program to make a conversion?
3. What's the difference between the standard output and the standard error?
4. Why is `cout` able to display various C++ types without being provided explicit instructions for each type?
5. What feature of the output method definitions allows you to concatenate output?
6. Write a program that requests an integer and then displays it in decimal, octal, and hexadecimal forms. Display each form on the same line, in fields that are 15 characters wide, and use the C++ number base prefixes.
7. Write a program that requests the following information and that formats it as shown:

```
Enter your name: Billy Gruff
Enter your hourly wages: 12
Enter number of hours worked: 7.5
First format:
                Billy Gruff: $      12.00:  7.5
Second format:
Billy Gruff           : $12.00      :7.5
```

8. Consider the following program:

```
//rq17-8.cpp
#include <iostream>

int main()
{
    using namespace std;
    char ch;
    int ct1 = 0;

    cin >> ch;
    while (ch != 'q')
    {
        ct1++;
        cin >> ch;
    }

    int ct2 = 0;
    cin.get(ch);
    while (ch != 'q')
    {
        ct2++;
        cin.get(ch);
    }
    cout << "ct1 = " << ct1 << "; ct2 = " << ct2 << "\n";

    return 0;
}
```

What does it print, given the following input:

```
I see a q<Enter>
I see a q<Enter>
```

Here <Enter> signifies pressing the Enter key.

9. Both of the following statements read and discard characters up to and including the end of a line. In what way does the behavior of one differ from that of the other?

```
while (cin.get() != '\n')
    continue;
cin.ignore(80, '\n');
```

## Programming Exercises

1. Write a program that counts the number of characters up to the first `$` in input and that leaves the `$` in the input stream.
2. Write a program that copies your keyboard input (up to the simulated end-of-file) to a file named on the command line.
3. Write a program that copies one file to another. Have the program take the file-names from the command line. Have the program report if it cannot open a file.
4. Write a program that opens two text files for input and one for output. The program should concatenate the corresponding lines of the input files, use a space as a separator, and write the results to the output file. If one file is shorter than the other, the remaining lines in the longer file should also be copied to the output file. For example, suppose the first input file has these contents:

```
eggs kites donuts
balloons hammers
stones
```

And suppose the second input file has these contents:

```
zero lassitude
finance drama
```

The resulting file would have these contents:

```
eggs kites donuts zero lassitude
balloons hammers finance drama
stones
```

5. Mat and Pat want to invite their friends to a party, much as they did in Programming Exercise 8 in Chapter 16, except now they want a program that uses files. They have asked you to write a program that does the following:
  - Reads a list of Mat's friends' names from a text file called `mat.dat`, which lists one friend per line. The names are stored in a container and then displayed in sorted order.
  - Reads a list of Pat's friends' names from a text file called `pat.dat`, which lists one friend per line. The names are stored in a container and then displayed in sorted order.
  - Merges the two lists, eliminating duplicates and stores the result in the file `matnpat.dat`, one friend per line.

6. Consider the class definitions of Programming Exercise 5 in Chapter 14, “Reusing Code in C++”. If you haven’t yet done that exercise, do so now. Then do the following:

Write a program that uses standard C++ I/O and file I/O in conjunction with data of types `employee`, `manager`, `fink`, and `highfink`, as defined in Programming Exercise 5 in Chapter 14. The program should be along the general lines of Listing 17.17 in that it should let you add new data to a file. The first time through, the program should solicit data from the user, show all the entries, and save the information in a file. On subsequent uses, the program should first read and display the file data, let the user add data, and show all the data. One difference is that data should be handled by an array of pointers to type `employee`. That way, a pointer can point to an `employee` object or to objects of any of the three derived types. Keep the array small to facilitate checking the program; for example, you might limit the array to 10 elements:

```
const int MAX = 10;    // no more than 10 objects
...
employee * pc[MAX];
```

For keyboard entry, the program should use a menu to offer the user the choice of which type of object to create. The menu should use a switch to use `new` to create an object of the desired type and to assign the object’s address to a pointer in the `pc` array. Then that object can use the virtual `setall()` function to elicit the appropriate data from the user:

```
pc[i]->setall(); // invokes function corresponding to type of object
```

To save the data to a file, devise a virtual `writeall()` function for that purpose:

```
for (i = 0; i < index; i++)
    pc[i]->writeall(fout); // fout ofstream connected to output file
```

### Note

Use text I/O, not binary I/O, for Programming Exercise 6. (Unfortunately, virtual objects include pointers to tables of pointers to virtual functions, and `write()` copies this information to a file. An object filled by using `read()` from the file gets weird values for the function pointers, which really messes up the behavior of virtual functions.) Use a newline character to separate each data field from the next; this makes it easier to identify fields on input. Or you could still use binary I/O, but not write objects as a whole. Instead, you could provide class methods that apply the `write()` and `read()` functions to each class member individually rather than to the object as a whole. That way, the program could save just the intended data to a file.

The tricky part is recovering the data from the file. The problem is, how can the program know whether the next item to be recovered is an `employee` object, a `manager` object, a `fink` type, or a `highfink` type? One approach is, when writing the data for an object to a file, precede the data with an integer that indicates the type of object to follow. Then, on file input, the program can read the integer and then use `switch` to create the appropriate object to receive the data:

```
enum classkind{Employee, Manager, Fink, Highfink}; // in class header
...
int classtype;
while((fin >> classtype).get(ch)){ // newline separates int from data
    switch(classtype) {
        case Employee : pc[i] = new employee;
                       : break;
```

Then you can use the pointer to invoke a virtual `getall()` function to read the information:

```
pc[i++]->getall();
```

7. Here is part of a program that reads keyboard input into a vector of `string` objects, stores the string contents (not the objects) in a file, and then copies the file contents back into a vector of `string` objects:

```
int main()
{
    using namespace std;
    vector<string> vostr;
    string temp;

    // acquire strings
    cout << "Enter strings (empty line to quit):\n";
    while (getline(cin,temp) && temp[0] != '\0')
        vostr.push_back(temp);
    cout << "Here is your input.\n";
    for_each(vostr.begin(), vostr.end(), ShowStr);

    // store in a file
    ofstream fout("strings.dat", ios_base::out | ios_base::binary);
    for_each(vostr.begin(), vostr.end(), Store(fout));
    fout.close();

    // recover file contents
    vector<string> vistr;
    ifstream fin("strings.dat", ios_base::in | ios_base::binary);
    if (!fin.is_open())
    {
        cerr << "Could not open file for input.\n";
```

```

        exit(EXIT_FAILURE);
    }
    GetStrs(fin, vistr);
    cout << "\nHere are the strings read from the file:\n";
    for_each(vistr.begin(), vistr.end(), ShowStr);

    return 0;
}

```

Note that the file is opened in binary format and that the intention is that I/O be accomplished with `read()` and `write()`. Quite a bit remains to be done:

- Write a `void ShowStr(const string &)` function that displays a string object followed by a newline character.
- Write a `Store` functor that writes string information to a file. The `Store` constructor should specify an `ifstream` object, and the overloaded `operator()(const string &)` should indicate the string to write. A workable plan is to first write the string's size to the file and then write the string contents. For example, if `len` holds the string size, you could use this:

```

os.write((char *)&len, sizeof(std::size_t)); // store length
os.write(s.data(), len);                    // store characters

```

The `data()` member returns a pointer to an array that holds the characters in the string. It's similar to the `c_str()` member except that the latter appends a null character.

- Write a `GetStrs()` function that recovers information from the file. It can use `read()` to obtain the size of a string and then use a loop to read that many characters from the file, appending them to an initially empty temporary string. Because a string's data is private, you have to use a class method to get data into the string rather than read directly into it.

*This page intentionally left blank*

# Visiting with the New C++ Standard

In this chapter you'll review C++11 features previously covered and then learn about the following:

- Move semantics and rvalue references
- Lambda expressions
- The `function` wrapper template
- Variadic templates

This chapter concentrates on the new C++11 changes to the C++ language. The book already has covered several C++11 features, and we'll begin by reviewing them. Then we'll look at some additional features in some detail. Next, we'll identify some of the C++11 additions that are beyond the scope of this book. (Given that the C++11 draft is over 80% longer than C++98, we won't cover everything.) Finally, we'll briefly examine the BOOST library.

## C++11 Features Revisited

By now you may have lost track of the many C++11 changes we already have encountered. This section reviews them briefly.

### New Types

C++11 adds the `long long` and `unsigned long long` types to support 64-bit integers (or wider) and the `char16_t` and `char32_t` types to support 16-bit and 32-bit character representations, respectively. It also adds the “raw” string. Chapter 3, “Dealing with Data,” discusses these additions.



## Uniform Initialization

C++11 extends the applicability of the brace-enclosed list (*list-initialization*) so that it can be used with all built-in types and with user-defined types (that is, class objects). The list can be used either with or without the = sign:

```
int x = {5};
double y {2.75};
short quar[5] {4,5,2,76,1};
```

Also the list-initialization syntax can be used in new expressions:

```
int * ar = new int [4] {2,4,6,7};           // C++11
```

With class objects, a braced list can be used instead of a parenthesized list to invoke a constructor:

```
class Stump
{
private:
    int roots;
    double weight;
public:
    Stump(int r, double w) : roots(r), weight(w) {}
};
Stump s1(3,15.6);           // old style
Stump s2{5, 43.4};         // C++11
Stump s3 = {4, 32.1};      // C++11
```

However, if a class has a constructor whose argument is a `std::initializer_list` template, then only that constructor can use the list-initialization form. Various aspects of list-initialization were discussed in Chapters 3, 4, 9, 10, and 16.

## Narrowing

The initialization-list syntax provides protection against narrowing—that is, against assigning a numeric value to a numeric type not capable of holding that value. Ordinary initialization allows you to do things that may or may not make sense:

```
char c1 = 1.57e27;         // double-to-char, undefined behavior
char c2 = 459585821;      // int-to-char, undefined behavior
```

If you use initialization-list syntax, however, the compiler disallows type conversions that attempt to store values in a type “narrower” than the value:

```
char c1 {1.57e27};        // double-to-char, compile-time error
char c2 = {459585821};   // int-to-char, out of range, compile-time error
```

However, conversions to wider types are allowed. Also a conversion to a narrower type is allowed if the value is within the range allowed by the type:

```
char c1 {66};    // int-to-char, in range, allowed
double c2 = {66}; // int-to-double, allowed
```

### **std::initializer\_list**

C++11 provides an `initializer_list` template class (discussed in Chapter 16, “The string Class and the Standard Template Library”) that can be used as a constructor argument. If a class has such a constructor, the brace syntax can be used only with that constructor. The items in the list should all be of the same type or else be convertible to the same type. The STL containers provide constructors with `initializer_list` arguments:

```
vector<int> a1(10);    // uninitialized vector with 10 elements
vector<int> a2{10};   // initializer-list, a2 has 1 element set to 10
vector<int> a3{4,6,1}; // 3 elements set to 4,6,1
```

The `initializer_list` header file provides support for this template class. The class has `begin()` and `end()` member functions specifying the range of the list. You can use an `initializer_list` argument for regular functions as well as for constructors:

```
#include <initializer_list>
double sum(std::initializer_list<double> il);
int main()
{
    double total = sum({2.5,3.1,4}); // 4 converted to 4.0
    ...
}
double sum(std::initializer_list<double> il)
{
    double tot = 0;
    for (auto p = il.begin(); p !=il.end(); p++)
        tot += *p;
    return tot;
}
```

## **Declarations**

C++11 implements several features that simplify declarations, particularly for situations arising when templates are used.

### **auto**

C++11 strips the keyword `auto` of its former meaning as a storage class specifier (Chapter 9, “Memory Models and Namespaces”) and puts it to use (Chapter 3) to implement automatic type deduction, provided that an explicit initializer is given. The compiler sets the type of the variable to the type of the initialization value:

```
auto maton = 112; // maton is type int
auto pt = &maton; // pt is type int *
double fm(double, int);
auto pf = fm;     // pf is type double (*)(double,int)
```

The `auto` keyword can simplify template declarations too. For example, if `il` is an object of type `std::initializer_list<double>`, you can replace

```
for (std::initializer_list<double>::iterator p = il.begin();
     p !=il.end(); p++)
```

with this:

```
for (auto p = il.begin(); p !=il.end(); p++)
```

## **decltype**

The `decltype` keyword creates a variable of the type indicated by an expression. The following statement means “make `y` the same type as `x`,” where `x` is an expression:

```
decltype(x) y;
```

Here are a couple of examples:

```
double x;
int n;
decltype(x*n) q; // q same type as x*n, i.e., double
decltype(&x) pd; // pd same as &x, i.e., double *
```

This is particularly useful in template definitions, when the type may not be determined until a specific instantiation is made:

```
template<typename T, typename U>
void ef(T t, U u)
{
    decltype(T*U) tu;
    ...
}
```

Here, `tu` is of whatever type results from the operation `T*U`, assuming that operation is defined. For example, if `T` is `char` and `U` is `short`, `tu` would be of type `int` because of the automatic integer promotions that take place in integer arithmetic.

The workings of `decltype` are more complicated than those of `auto`, and the resulting types can be references and can be `const`-qualified, depending on the expressions used.

Here are some more examples:

```
int j = 3;
int &k = j
const int &n = j;
decltype(n) i1; // i1 type const int &
decltype(j) i2; // i2 type int
decltype((j)) i3; // i3 type int &
decltype(k + 1) i4; // i4 type int
```

See Chapter 8, “Adventures in Functions,” for the rules that lead to these results.

## Trailing Return Type

C++11 introduces a new syntax for declaring functions, one in which the return type comes after the function name and parameter list instead of before them:

```
double f1(double, int);           // traditional syntax
auto f2(double, int) -> double; // new syntax, return type is double
```

The new syntax may look like a step backwards in readability for the usual function declarations, but it does make it possible to use `decltype` to specify template function return types:

```
template<typename T, typename U>
auto eff(T t, U u) -> decltype(T*U)
{
    ...
}
```

The problem that's addressed here is that `T` and `U` are not in scope before the compiler reads the `eff` parameter list, so any use of `decltype` has to come after the parameter list. The new syntax makes that possible.

## Template Aliases: `using =`

It's handy to be able to create aliases for long or complex type identifiers. C++ already had `typedef` for that purpose:

```
typedef std::vector<std::string>::iterator itType;
```

C++11 provides a second syntax (discussed in Chapter 14, "Reusing Code in C++") for creating aliases:

```
using itType = std::vector<std::string>::iterator;
```

The difference is that the new syntax also can be used for partial template specializations, whereas `typedef` can't:

```
template<typename T>
using arr12 = std::array<T,12>; // template for multiple aliases
```

This statement specializes the `array<T,int>` template by setting the `int` parameter to 12. For instance, consider these declarations:

```
std::array<double, 12> a1;
std::array<std::string, 12> a2;
```

They can be replaced with the following:

```
arr12<double> a1;
arr12<std::string> a2;
```

## **nullptr**

The null pointer is a pointer guaranteed not to point to valid data. Traditionally, C++ has represented this pointer in source code with `0`, although the internal representation could be different. This raises some problems because it makes `0` both a pointer constant and an integer constant. As discussed in Chapter 12, “Classes and Dynamic Memory Allocation,” C++11 introduces the keyword `nullptr` to represent the null pointer; it is a pointer type and not convertible to an integer type. For backward compatibility, C++ still allows the use of `0`, and the expression `nullptr == 0` evaluates as `true`, but using `nullptr` instead of `0` provides better type safety. For example, the value `0` could be passed to a function accepting an `int` argument, but the compiler will identify an attempt to pass `nullptr` to such a function as an error. So, for clarity and added safety, use `nullptr` if your compiler accepts it.

## **Smart Pointers**

A program that uses `new` to allocate memory from the heap (or free store) should use `delete` to free that memory when it no longer is needed. Earlier, C++ introduced the `auto_ptr` smart pointer to help automate the process. Subsequent programming experience, particularly with the STL, indicated that something more sophisticated was needed. Guided by the experience of programmers and by solutions provided by the BOOST library, C++11 deprecates `auto_ptr` and introduces three new smart pointer types: `unique_ptr`, `shared_ptr`, and `weak_ptr`. Chapter 16 discusses the first two.

All the new smart pointers have been designed to work with STL containers and with move semantics.

## **Exception Specification Changes**

C++ provides a syntax for specifying what exceptions, if any, a function may throw (refer to Chapter 15, “Friends, Exceptions, and More”):

```
void f501(int) throw(bad_dog);    // can throw type bad_dog exception
void f733(long long) throw();    // doesn't throw an exception
```

As with `auto_ptr`, the collective experience of the C++ programming community is that, in practice, exception specifications didn’t work as well as intended. Thus, the C++11 standard deprecates exception specifications. However, the standards committee felt that there is some value in documenting that a function does not throw an exception, and it added the keyword `noexcept` for this purpose:

```
void f875(short, short) noexcept; // doesn't throw an exception
```

## **Scoped Enumerations**

Traditional C++ enumerations provide a way to create named constants. However, they come with a rather low level of type checking. Also the scope for enumeration names is the scope that encloses the enumeration definition, which means that two enumerations

defined in the same scope must not have enumeration members with the same name. Finally, enumerations may not be completely portable because different implementations may choose to use different underlying types. C++11 introduces a variant of enumerations that addresses these problems. The new form is indicated by using `class` or `struct` in the definition:

```
enum Old1 {yes, no, maybe}; // traditional form
enum class New1 {never, sometimes, often, always}; // new form
enum struct New2 {never, lever, sever}; // new form
```

The new forms avoid name conflicts by requiring explicit scoping. Thus, you would use `New1::never` and `New2::never` to identify those particular enumerations. Chapter 10, “Objects and Classes,” provides more details.

## Class Changes

C++11 makes several changes to simplify and expand class design. These include ways to allow constructors to call one another and to be inherited, better ways to control method access, and move constructors and assignment operators, all of which will be covered in this chapter. Meanwhile, let’s review the changes that have been discussed previously.

### explicit Conversion Operators

One of the exciting aspects in the early days of C++ was the ease with which automatic conversions for classes could be established. One of the realizations that grew as programming experience accumulated was that automatic type conversions could lead to problems in the form of unexpected conversions. C++ then addressed one aspect of the problem by introducing the keyword `explicit` to suppress automatic conversions invoked by one-argument constructors:

```
class Plebe
{
    Plebe(int); // automatic int-to-plebe conversion
    explicit Plebe(double); // requires explicit use
    ...
};
...
Plebe a, b;
a = 5; // implicit conversion, call Plebe(5)
b = 0.5; // not allowed
b = Plebe(0.5); // explicit conversion
```

C++11 extends the use of `explicit` (discussed in Chapter 11, “Working with Classes”) so that conversion functions can be treated similarly:

```
class Plebe
{
    ...
    // conversion functions
```

```

    operator int() const;
    explicit operator double() const;
    ...
};
...
Plebe a, b;
int n = a;        // int-to-Plebe automatic conversion
double x = b;    // not allowed
x = double(b);   // explicit conversion, allowed

```

### Member In-Class Initialization

Many first-time users of C++ have wondered why they can't initialize members simply by providing values in the class definition. Now they (and you) can. The syntax looks like this:

```

class Session
{
    int mem1 = 10;           // in-class initialization
    double mem2 {1966.54}; // in-class initialization
    short mem3;
public:
    Session() {} // #1
    Session(short s) : mem3(s) {} // #2
    Session(int n, double d, short s) : mem1(n), mem2(d), mem3(s) {} // #3
    ...
};

```

You can use the equal sign or the brace forms of initialization, but not the parenthesized version. The result is the same as if you provided the first two constructors with member initialization list entries for `mem1` and `mem2`:

```

Session() : mem1(10), mem2(1966.54) {}
Session(short s) : mem1(10), mem2(1966.54), mem3(s) {}

```

Note how using in-class initialization avoids having to duplicate code in the constructors, thus reducing work and the number of opportunities for error and boredom for the programmer.

These default values are overridden by a constructor that supplies values in the member initialization list, so the third constructor overrides the in-class member initialization.

### Template and STL Changes

C++11 makes several changes extending the usability of templates in general and the Standard Template Library in particular. Some are in the library itself; others relate to ease of use. In this chapter we've already mentioned template aliases and the STL-friendly smart pointers.

## Range-based for Loop

The range-based for loop (discussed in Chapter 5, “Loops and Relational Expressions,” and Chapter 16) simplifies writing loops for built-in arrays and for classes, such as `std::string` and the STL containers, that have `begin()` and `end()` methods identifying a range. The loop applies the indicated action to each element in the array or container:

```
double prices[5] = {4.99, 10.99, 6.87, 7.99, 8.49};
for (double x : prices)
    std::cout << x << std::endl;
```

Here, `x` takes on the value of each element in `prices` in turn. The type of `x` should match the type of the array element. An easier and safer way of doing this is to use `auto` to declare `x`; the compiler will deduce the type from the information in the `prices` declaration:

```
double prices[5] = {4.99, 10.99, 6.87, 7.99, 8.49};
for (auto x : prices)
    std::cout << x << std::endl;
```

If your intent is to have the loop modify elements of the array or container, use a reference type:

```
std::vector<int> vi(6);
for (auto & x: vi) // use a reference if loop alters contents
    x = std::rand();
```

## New STL Containers

C++11 adds `forward_list`, `unordered_map`, `unordered_multimap`, `unordered_set`, and `unordered_multiset` to its collection of STL containers (see Chapter 16). The `forward_list` container is a singly linked list that can be traversed in just one direction; it’s simpler and more economical of space than the doubly linked `list` container. The other four containers support implementing hash tables.

C++11 also adds the `array` template (discussed in Chapter 4, “Compound Types,” and Chapter 16), for which one specifies an element type and a fixed number of elements:

```
std::array<int,360> ar; // array of 360 ints
```

This template class does not satisfy all the usual template requirements. For example, because the size is fixed, you can’t use any method, such as `put_back()`, that changes the size of a container. But `array` does have the `begin()` and `end()` methods, which allow you to use many of the range-based STL algorithms with array objects.

## New STL Methods

C++11 adds `cbegin()` and `cend()` to the list of STL methods. Like `begin()` and `end()`, the new methods return iterators to the first element and to one past the last element of a container, thus specifying a range encompassing all the elements. In addition, the new



methods treat the elements as if they were `const`. Similarly, `crbegin()` and `crend()` are `const` versions of `rbegin()` and `rend()`.

More significantly, STL containers now have move constructors and move assignment operators in addition to the traditional copy constructors and regular assignment operators. This chapter describes move semantics later.

### valarray Upgrade

The `valarray` template was developed independently of the STL, and its original design precluded using range-based STL algorithms with `valarray` objects. C++11 adds two functions, `begin()` and `end()`, that each take a `valarray` argument. They return iterators to the first and one past the last element of a `valarray` object, allowing one to use range-based STL algorithms (see Chapter 16).

### export Departs

C++98 introduced the `export` keyword in the hopes of creating a way to separate template definitions into interface files containing the prototypes and template declarations and implementation files containing the template function and methods definitions. This proved to be impractical, and C++11 ends that roll for `export`. However, the Standard retains `export` as a keyword for possible future use.

### Angle Brackets

To avoid confusion with the `>>` operator, C++ required a space between the brackets in nested template declarations:

```
std::vector<std::list<int> > v1; // >> not ok
```

C++11 removes that requirement:

```
std::vector<std::list<int>> v1; // >> ok in C++11
```

### The rvalue Reference

The traditional C++ reference, now called an *lvalue reference*, binds an identifier to an lvalue. An lvalue is an expression, such as a variable name or a dereferenced pointer, that represents data for which the program can obtain an address. Originally, an lvalue was one that could appear on the left side of an assignment statement, but the advent of the `const` modifier allowed for constructs that cannot be assigned to but which are still addressable:

```
int n;
int * pt = new int;
const int b = 101; // can't assign to b, but &b is valid
int & rn = n;      // n identifies datum at address &n
int & rt = *pt;    // *pt identifies datum at address pt
const int & rb = b; // b identifies const datum at address &b
```

C++11 adds the rvalue reference (discussed in Chapter 8), indicated by using `&&`, that can bind to rvalues—that is, values that can appear on the right-hand side of an

assignment expression but for which one cannot apply the address operator. Examples include literal constants (aside from C-style strings, which evaluate as addresses), expressions such as  $x+y$ , and function return values, providing the function does not return a reference:

```
int x = 10;
int y = 23;
int && r1 = 13;
int && r2 = x + y;
double && r3 = std::sqrt(2.0);
```

Note that what `r2` really binds to is the value to which `x + y` evaluates at that time. That is, `r2` binds to the value 23, and `r2` is unaffected by subsequent changes to `x` or `y`.

Interestingly, binding an rvalue to an rvalue reference results in the value being stored in a location whose address can be taken. That is, although you can't apply the `&` operator to 13, you can apply it to `r1`. This binding of the data to particular addresses is what makes it possible to access the data through the rvalue references.

Listing 18.1 provides a short example illustrating some of these points about rvalue references.

#### Listing 18.1 `rvref.cpp`

---

```
// rvref.cpp -- simple uses of rvalue references
#include <iostream>

inline double f(double tf) {return 5.0*(tf-32.0)/9.0;};
int main()
{
    using namespace std;
    double tc = 21.5;
    double && rd1 = 7.07;
    double && rd2 = 1.8 * tc + 32.0;
    double && rd3 = f(rd2);
    cout << " tc value and address: " << tc << ", " << &tc << endl;
    cout << "rd1 value and address: " << rd1 << ", " << &rd1 << endl;
    cout << "rd2 value and address: " << rd2 << ", " << &rd2 << endl;
    cout << "rd3 value and address: " << rd3 << ", " << &rd3 << endl;
    cin.get();
    return 0;
}
```

---

Here is a sample output:

```
tc value and address: 21.5, 002FF744
rd1 value and address: 7.07, 002FF728
rd2 value and address: 70.7, 002FF70C
rd3 value and address: 21.5, 002FF6F0
```

One of the main reasons for introducing the rvalue reference is to implement move semantics, the next topic in this chapter.

## Move Semantics and the Rvalue Reference

Now let's move on to topics we haven't yet discussed. C++11 enables a technique called *move semantics*. This raises some questions, such as what are move semantics, how does C++11 enable them, and why do we need them? We'll begin with the last question.

### The Need for Move Semantics

Let's look into the copying process as it worked prior to C++11. Suppose we start with something like this:

```
vector<string> vstr;
// build up a vector of 20,000 strings, each of 1000 characters
...
vector<string> vstr_copy1(vstr); // make vstr_copy1 a copy of vstr
```

Both the `vector` class and the `string` class use dynamic memory allocation, so they will have copy constructors defined that use some version of `new`. To initialize the `vstr_copy1` object, the `vector<string>` copy constructor will use `new` to allocate memory for 20,000 `string` objects, and each `string` object, in turn, will call the `string` copy constructor, which will use `new` to allocate memory for 1000 characters. Then all 20,000,000 characters will be copied from the memory controlled by `vstr` to the memory controlled by `vstr_copy1`. That's a lot of work, but if it's got to be done, then it's got to be done.

But does it “got to be done?” There are times when the answer is no. For instance, suppose we have a function that returns a `vector<string>` object:

```
vector<string> allcaps(const vector<string> & vs)
{
    vector<string> temp;
    // code that stores an all-uppercase version of vs in temp
    return temp;
}
```

Next, suppose we use it this way:

```
vector<string> vstr;
// build up a vector of 20,000 strings, each of 1000 characters
vector<string> vstr_copy1(vstr);           // #1
vector<string> vstr_copy2(allcaps(vstr)); // #2
```

Superficially, statements #1 and #2 are similar; each uses an existing object to initialize a new `vector<string>` object. If we take this code at face value, `allcaps()` creates a `temp` object managing 20,000,000 characters, the `vector` and `string` copy constructors go through the effort of creating a 20,000,000-character duplicate, then the program

deletes the temporary object returned by `allcaps()`. (A really uninspired compiler could even copy `temp` to a temporary return object, delete `temp`, and then delete the return object.) The main point is that a lot of effort is wasted here. Because the temporary object is deleted, wouldn't it be better if the compiler could just transfer ownership of the data to `vstr_copy2`? That is, instead of copying 20,000,000 characters to a new location and then deleting the old location, just leave the characters in place and attach the `vstr_copy2` label to them. This would be similar to what happens when you move a file from one directory to another: The actual file stays where it is on the hard drive, and just the bookkeeping is altered. Such an approach is called *move semantics*. Somewhat paradoxically, move semantics actually avoids moving the primary data; it just adjusts the bookkeeping.

To implement move semantics, we need a way to let the compiler know when it needs to do a real copy and when it doesn't. Here's where the rvalue reference comes into play. We can define two constructors. One, the regular copy constructor, can use the usual const lvalue reference as a parameter. This reference will bind to lvalue arguments, such as `vstr` in statement #1. The other, called a *move constructor*, can use an rvalue reference, and it can bind to rvalue arguments, such as the return value of `allcaps(vstr)` in statement #2. The copy constructor can do the usual deep copy, while the move constructor can just adjust the bookkeeping. A move constructor may alter its argument in the process of transferring ownership to a new object, and this implies that an rvalue reference parameter should not be `const`.

## A Move Example

Let's look at an example to see how move semantics and rvalue references work. Listing 18.2 defines and uses the `Useless` class, which incorporates dynamic memory allocation, a regular copy constructor, and a move constructor, which uses move semantics and an rvalue reference. In order to illustrate the processes involved, the constructors and destructor are unusually verbose, and the class uses a state variable to keep track of the number of objects. Also some important methods, such as the assignment operator, are omitted. (Despite these omissions, the `Useless` class should not be confused with the eco-friendly `Use_Less` class.)

### Listing 18.2 `useless.cpp`

---

```
// useless.cpp -- an otherwise useless class with move semantics
#include <iostream>
using namespace std;

// interface
class Useless
{
private:
    int n;           // number of elements
    char * pc;      // pointer to data
    static int ct;  // number of objects
```

```

        void ShowObject() const;
public:
    Useless();
    explicit Useless(int k);
    Useless(int k, char ch);
    Useless(const Useless & f); // regular copy constructor
    Useless(Useless && f);      // move constructor
    ~Useless();
    Useless operator+(const Useless & f) const;
// need operator=() in copy and move versions
    void ShowData() const;
};

// implementation
int Useless::ct = 0;

Useless::Useless()
{
    ++ct;
    n = 0;
    pc = nullptr;
    cout << "default constructor called; number of objects: " << ct << endl;
    ShowObject();
}

Useless::Useless(int k) : n(k)
{
    ++ct;
    cout << "int constructor called; number of objects: " << ct << endl;
    pc = new char[n];
    ShowObject();
}

Useless::Useless(int k, char ch) : n(k)
{
    ++ct;
    cout << "int, char constructor called; number of objects: " << ct
        << endl;
    pc = new char[n];
    for (int i = 0; i < n; i++)
        pc[i] = ch;
    ShowObject();
}

Useless::Useless(const Useless & f): n(f.n)
{

```

```

    ++ct;
    cout << "copy const called; number of objects: " << ct << endl;
    pc = new char[n];
    for (int i = 0; i < n; i++)
        pc[i] = f.pc[i];
    ShowObject();
}

Useless::Useless(Useless && f): n(f.n)
{
    ++ct;
    cout << "move constructor called; number of objects: " << ct << endl;
    pc = f.pc;          // steal address
    f.pc = nullptr;    // give old object nothing in return
    f.n = 0;
    ShowObject();
}

Useless::~~Useless()
{
    cout << "destructor called; objects left: " << --ct << endl;
    cout << "deleted object:\n";
    ShowObject();
    delete [] pc;
}

Useless Useless::operator+(const Useless & f) const
{
    cout << "Entering operator+()\n";
    Useless temp = Useless(n + f.n);
    for (int i = 0; i < n; i++)
        temp.pc[i] = pc[i];
    for (int i = n; i < temp.n; i++)
        temp.pc[i] = f.pc[i - n];
    cout << "temp object:\n";
    cout << "Leaving operator+()\n";
    return temp;
}

void Useless::ShowObject() const
{
    cout << "Number of elements: " << n;
    cout << " Data address: " << (void *) pc << endl;
}

```

```

void Useless::ShowData() const
{
    if (n == 0)
        cout << "(object empty)";
    else
        for (int i = 0; i < n; i++)
            cout << pc[i];
    cout << endl;
}

// application
int main()
{
    {
        Useless one(10, 'x');
        Useless two = one;           // calls copy constructor
        Useless three(20, 'o');
        Useless four (one + three); // calls operator+(), move constructor
        cout << "object one: ";
        one.ShowData();
        cout << "object two: ";
        two.ShowData();
        cout << "object three: ";
        three.ShowData();
        cout << "object four: ";
        four.ShowData();
    }
}

```

---

The crucial definitions are those of the two copy/move constructors. First, shorn of the output statements, here is the copy constructor:

```

Useless::Useless(const Useless & f): n(f.n)
{
    ++ct;
    pc = new char[n];
    for (int i = 0; i < n; i++)
        pc[i] = f.pc[i];
}

```

It does the usual deep copy, and it is the constructor that's used by the following statement:

```

Useless two = one;           // calls copy constructor

```

The reference `f` refers to the lvalue object `one`.





```

deleted object:
Number of elements: 30 Data address: 006F4C48
destructor called; objects left: 2
deleted object:
Number of elements: 20 Data address: 006F4BF8
destructor called; objects left: 1
deleted object:
Number of elements: 10 Data address: 006F4BB0
destructor called; objects left: 0
deleted object:
Number of elements: 10 Data address: 006F4B68

```

Note that object `two` is a separate copy of object `one`: Both display the same data output, but the data addresses (`006F4B68` and `006F4BB0`) are different. On the other hand, the data address (`006F4C48`) of the object created in the `Useless::operator+()` method is the same as the data address stored in the `four` object, which was constructed by the move copy constructor. Also note how the destructor was called for the temporary object after the `four` object was constructed. You can tell that is the temporary object that was deleted because the size and the data address both show as 0.

Compiling the same program (but replacing `nullptr` with `0`) with g++ 4.5.0 with the `-std=c++11` flag leads to an interestingly different output:

```

int, char constructor called; number of objects: 1
Number of elements: 10 Data address: 0xa50338
copy const called; number of objects: 2
Number of elements: 10 Data address: 0xa50348
int, char constructor called; number of objects: 3
Number of elements: 20 Data address: 0xa50358
Entering operator+()
int constructor called; number of objects: 4
Number of elements: 30 Data address: 0xa50370
temp object:
Leaving operator+()
object one: xxxxxxxxxxxx
object two: xxxxxxxxxxxx
object three: oooooooooooooooooooooo
object four: xxxxxxxxxxxxxxxxxxxxxxxxxxxxxxxxxxxx
destructor called; objects left: 3
deleted object:
Number of elements: 30 Data address: 0xa50370
destructor called; objects left: 2
deleted object:
Number of elements: 20 Data address: 0xa50358
destructor called; objects left: 1
deleted object:
Number of elements: 10 Data address: 0xa50348

```

```

destructor called; objects left: 0
deleted object:
Number of elements: 10 Data address: 0xa50338

```

Note that the move constructor is not called and that only four objects were created. The compiler did not call any of our constructors to construct the `four` object; instead, it deduced that the `four` object should be the beneficiary of the work done by `operator+()` and transferred the name `four` to the object created in `operator+()`. In general, compilers are empowered to make their own optimizations if the result is the same that would have been obtained by going through all the steps. Even if you omit the move constructor from the code and compile with `g++`, you get the same behavior.

## Move Constructor Observations

Although using an rvalue reference enables move semantics, it doesn't magically make it happen. There are two steps to enablement. The first step is that the rvalue reference allows the compiler to identify when move semantics can be used:

```

Useless two = one;           // matches Useless::Useless(const Useless &)
Useless four (one + three); // matches Useless::Useless(Useless &&)

```

The object `one` is an lvalue, so it matches the lvalue reference, and the expression `one + three` is an rvalue, so it matches the rvalue reference. Thus, the rvalue reference directs initialization for object `four` to the move constructor. The second step in enabling move semantics is coding the move constructor so that it provides the behavior we want.

In short, the presence of one constructor with an lvalue reference and a second constructor with an rvalue reference sorts possible initializations into two groups. Objects initialized with an lvalue object use the copy constructor, and objects initialized with an rvalue object use the move constructor. The code writer then can endow these constructors with different behaviors.

This raises the question of what happened before rvalue references were part of the language. If there is no move constructor and the compiler doesn't optimize away the need for the copy constructor, what should happen? Under C++98, the following statement would invoke the copy constructor:

```
Useless four (one + three);
```

But an lvalue reference doesn't bind to an rvalue. So what happens? As you may recall from Chapter 8, a `const` reference parameter will bind to a temporary variable or object if the actual argument is an rvalue:

```

int twice(const & rx) {return 2 * rx;}
...
int main()
{
    int m = 6;
    // below, rx refers to m
    int n = twice(m);
}

```

```

// below, rx refers to a temporary variable initialized to 21
int k = twice(21);
...

```

So in the `Useless` case, the formal parameter `f` will be initialized to a temporary object that's initialized to the return value of `operator+()`. Here is an excerpt from the result of using an older compiler with Listing 18.2 and omitting the move constructor:

```

...
Entering operator+()
int constructor called; number of objects: 4
Number of elements: 30 Data address: 01C337C4
temp object:
Leaving operator+()
copy const called; number of objects: 5
Number of elements: 30 Data address: 01C337E8
destructor called; objects left: 4
deleted object:
Number of elements: 30 Data address: 01C337C4
copy const called; number of objects: 5
Number of elements: 30 Data address: 01C337C4
destructor called; objects left: 4
deleted object:
Number of elements: 30 Data address: 01C337E8
...

```

First, within the `Useless::operator+()` method, a constructor creates `temp`, allocating storage for 30 elements at location `01C337C4`. Then the copy constructor creates a temporary copy to which `f` will refer, copying the information to location `01C337E8`. Next, `temp`, which uses location `01C337C4`, gets deleted. Then a new object, `four`, is constructed, reusing the recently freed memory at `01C337C4`. Then the temporary argument object, which used location `01C337E8`, gets deleted. So three complete objects were constructed, and two of them were destroyed. This is the sort of extra work that move semantics are meant to eliminate.

As the `g++` example shows, an optimizing compiler might eliminate extra copying on its own, but using an rvalue reference lets the programmer dictate move semantics when appropriate.

## Assignment

The same considerations that make move semantics appropriate for constructors make them appropriate for assignment. Here, for example, is how you could code the copy assignment and the move assignment operators for the `Useless` class:

```

Useless & Useless::operator=(const Useless & f) // copy assignment
{
    if (this == &f)

```

```

        return *this;
    delete [] pc;
    n = f.n;
    pc = new char[n];
    for (int i = 0; i < n; i++)
        pc[i] = f.pc[i];
    return *this;
}

Useless & Useless::operator=(Useless && f)    // move assignment
{
    if (this == &f)
        return *this;
    delete [] pc;
    n = f.n;
    pc = f.pc;
    f.n = 0;
    f.pc = nullptr;
    return *this;
}

```

The copy assignment operator follows the usual pattern given in Chapter 12. The move assignment operator deletes the original data in the target and pilfers the source object. It's important that only one pointer points to the data, so the method resets the pointer in the source object to the null pointer.

As with the move constructor, the move assignment operator parameter is not a `const` reference because the method alters the source object.

## Forcing a Move

Move constructors and move assignment operators work with rvalues. What if you want to use them with lvalues? For instance, a program could analyze an array of some sort of candidate objects, select one object for further use, and discard the array. It would be convenient if you could use a move constructor or a move assignment operator to preserve the selected object. However, suppose you tried the following:

```

Useless choices[10];
Useless best;
int pick;
... // select one object, set pick to index
best = choices[pick];

```

The `choices[pick]` object is an lvalue, so the assignment statement will use the copy assignment operator, not the move assignment operator. But if you could make `choices[pick]` look like an rvalue, then the move assignment operator would be used. This can be done by using the `static_cast<>` operator to cast the object to type `Useless &&`. C++11 provides a simpler way to do this—use the `std::move()` function,

which is declared in the `utility` header file. Listing 18.3 illustrates this technique. It adds verbose versions of the assignment operators to the `Useless` class while silencing the previously verbose constructors and destructor.

### Listing 18.3 `stdmove.cpp`

---

```
// stdmove.cpp -- using std::move()
#include <iostream>
#include <utility>

// interface
class Useless
{
private:
    int n;           // number of elements
    char * pc;      // pointer to data
    static int ct;  // number of objects
    void ShowObject() const;
public:
    Useless();
    explicit Useless(int k);
    Useless(int k, char ch);
    Useless(const Useless & f); // regular copy constructor
    Useless(Useless && f);      // move constructor
    ~Useless();
    Useless operator+(const Useless & f) const;
    Useless & operator=(const Useless & f); // copy assignment
    Useless & operator=(Useless && f);     // move assignment
    void ShowData() const;
};

// implementation
int Useless::ct = 0;

Useless::Useless()
{
    ++ct;
    n = 0;
    pc = nullptr;
}

Useless::Useless(int k) : n(k)
{
    ++ct;
    pc = new char[n];
}
```

```

Useless::Useless(int k, char ch) : n(k)
{
    ++ct;
    pc = new char[n];
    for (int i = 0; i < n; i++)
        pc[i] = ch;
}

Useless::Useless(const Useless & f): n(f.n)
{
    ++ct;
    pc = new char[n];
    for (int i = 0; i < n; i++)
        pc[i] = f.pc[i];
}

Useless::Useless(Useless && f): n(f.n)
{
    ++ct;
    pc = f.pc;          // steal address
    f.pc = nullptr;    // give old object nothing in return
    f.n = 0;
}

Useless::~~Useless()
{
    delete [] pc;
}

Useless & Useless::operator=(const Useless & f) // copy assignment
{
    std::cout << "copy assignment operator called:\n";
    if (this == &f)
        return *this;
    delete [] pc;
    n = f.n;
    pc = new char[n];
    for (int i = 0; i < n; i++)
        pc[i] = f.pc[i];
    return *this;
}

Useless & Useless::operator=(Useless && f) // move assignment
{
    std::cout << "move assignment operator called:\n";
    if (this == &f)

```

```

        return *this;
    delete [] pc;
    n = f.n;
    pc = f.pc;
    f.n = 0;
    f.pc = nullptr;
    return *this;
}

Useless Useless::operator+(const Useless & f) const
{
    Useless temp = Useless(n + f.n);
    for (int i = 0; i < n; i++)
        temp.pc[i] = pc[i];
    for (int i = n; i < temp.n; i++)
        temp.pc[i] = f.pc[i - n];
    return temp;
}

void Useless::ShowObject() const
{
    std::cout << "Number of elements: " << n;
    std::cout << " Data address: " << (void *) pc << std::endl;
}

void Useless::ShowData() const
{
    if (n == 0)
        std::cout << "(object empty)";
    else
        for (int i = 0; i < n; i++)
            std::cout << pc[i];
    std::cout << std::endl;
}

// application
int main()
{
    using std::cout;
    {
        Useless one(10, 'x');
        Useless two = one + one;    // calls move constructor
        cout << "object one: ";
        one.ShowData();
        cout << "object two: ";
        two.ShowData();
    }
}

```

```

Useless three, four;
cout << "three = one\n";
three = one;           // automatic copy assignment
cout << "now object three = ";
three.ShowData();
cout << "and object one = ";
one.ShowData();
cout << "four = one + two\n";
four = one + two;     // automatic move assignment
cout << "now object four = ";
four.ShowData();
cout << "four = move(one)\n";
four = std::move(one); // forced move assignment
cout << "now object four = ";
four.ShowData();
cout << "and object one = ";
one.ShowData();
}
}

```

---

Here is a sample run:

```

object one: xxxxxxxxxxxx
object two: xxxxxxxxxxxxxxxxxxxxxxxx
three = one
copy assignment operator called:
now object three = xxxxxxxxxxxx
and object one = xxxxxxxxxxxx
four = one + two
move assignment operator called:
now object four = xxxxxxxxxxxxxxxxxxxxxxxxxxxxxxxx
four = move(one)
move assignment operator called:
now object four = xxxxxxxxxxxx
and object one = (object empty)

```

As you can see, assigning one to three invokes copy assignment, but assigning `move(one)` to four invokes move assignment.

You should realize that the `std::move()` function doesn't necessarily produce a move operation. Suppose, for instance, that `Chunk` is a class with private data and that we have the following code:

```

Chunk one;
...
Chunk two;
two = std::move(one); // move semantics?

```



The expression `std::move(one)` is an rvalue, so the assignment statement will invoke the move assignment operator for `Chunk`, providing that one has been defined. But if the `Chunk` class doesn't define a move assignment operator, the compiler will use the copy assignment operator. And if that also isn't defined, then assignment isn't allowed at all.

The main benefit rvalue references bring to most programmers is not the opportunity to write code using them. Rather, it is the opportunity to use library code that utilizes rvalue references to implement move semantics. For example, the STL classes now have copy constructors, move constructors, copy assignment operators, and move assignment operators.

## New Class Features

C++11 adds several features to classes in addition to those already mentioned in this chapter—that is, explicit conversion operators and in-class member initialization.

### Special Member Functions

C++11 adds two more *special member functions* (the move constructor and the move assignment operator) to four previous ones (the default constructor, the copy constructor, the copy assignment operator, and the destructor). These are member functions that the compiler provides automatically, subject to a variety of conditions.

The default constructor, recall, is a constructor that can be called with no arguments. The compiler provides one if you fail to define any constructors for the class. This default version of a default constructor is termed the *defaulted* default constructor. The defaulted default constructor leaves members of the built-in types uninitialized, and it invokes the default constructors for members that are class objects.

Also the compiler provides a defaulted copy constructor if you don't provide one and if your code requires its use, and it now provides a defaulted move constructor if you don't provide one and if your code requires its use. If the class name is `Someclass`, these two defaulted constructors have the following prototypes:

```
Someclass::Someclass(const Someclass &); // defaulted copy constructor
Someclass::Someclass(Someclass &&); // defaulted move constructor
```

In similar circumstances, the compiler provides a defaulted copy assignment operator and a defaulted move assignment operator with the following prototypes:

```
Someclass & Someclass::operator=(const Someclass &); // defaulted copy assignment
Someclass & Someclass::operator=(Someclass &&); // defaulted move assignment
```

Finally, the compiler provides a destructor if you don't.

There are various exceptions to this description. If you do provide a destructor or a copy constructor or a copy assignment operator, the compiler does not automatically provide a move constructor or a move assignment operator. If you do provide a move constructor or a move assignment operator, the compiler does not automatically provide a copy constructor or a copy assignment operator.

Also the defaulted move constructor and defaulted move assignment operator work similarly to their copy counterparts, doing memberwise initialization and copying for built-in types. For members that are class objects, constructors and assignment operators for those classes are used as if the parameters were rvalues. This, in turn, invokes move constructors and assignment operators, if defined, and copy constructors and assignment operators otherwise, if defined.

## Defaulted and Deleted Methods

C++11 provides more control over which methods are used. Suppose that you wish to use a defaulted function that, due to circumstances, isn't created automatically. For example, if you provide a move constructor, then the default constructor, the copy constructor, and the copy assignment operator are not provided. In that case, you can use the keyword `default` to explicitly declare the defaulted versions of these methods:

```
class Someclass
{
public:
    Someclass(Someclass &&);
    Someclass() = default;           // use compiler-generated default constructor
    Someclass(const Someclass &) = default;
    Someclass & operator=(const Someclass &) = default;
    ...
};
```

The compiler provides the same constructor that it would have provided automatically had you not provided the move constructor.

The `delete` keyword, on the other hand, can be used to prevent the compiler from using a particular method. For example, to prevent an object from being copied, you can disable the copy constructor and copy assignment operator:

```
class Someclass
{
public:
    Someclass() = default;           // use compiler-generated default constructor
    // disable copy constructor and copy assignment operator:
    Someclass(const Someclass &) = delete;
    Someclass & operator=(const Someclass &) = delete;
    // use compiler-generated move constructor and move assignment operator:
    Someclass(Someclass &&) = default;
    Someclass & operator=(Someclass &&) = default;
    Someclass & operator+(const Someclass &) const;
    ...
};
```

You may recall (from Chapter 12) that you can disable copying by placing the copy constructor and assignment operator in the `private` section of a class. But using `delete` is a less devious and more easily understood way to accomplish that end.

What is the effect of disabling copy methods while enabling move methods? Recall that an rvalue reference, such as used by move operations, binds only to rvalue expressions. This implies the following:

```
Someclass one;
Someclass two;
Someclass three(one);    // not allowed, one an lvalue
Someclass four(one + two); // allowed, expression is an rvalue
```

Only the six special member functions can be defaulted, but you can use `delete` with any member function. One possible use is to disable certain conversions. Suppose, for example, that the `Someclass` class has a method with a type `double` parameter:

```
class Someclass
{
public:
...
    void redo(double);
...
};
```

Then suppose we have the following code:

```
Someclass sc;
sc.redo(5);
```

The `int` value `5` will be promoted to `5.0`, and the `redo()` method will execute.

Now suppose the `Someclass` definition is modified thusly:

```
class Someclass
{
public:
...
    void redo(double);
    void redo(int) = delete;
...
};
```

In this case, the method call `sc.redo(5)` matches the `redo(int)` prototype. The compiler will detect that fact and also detect that `redo(int)` is deleted, and it will then flag the call as a compile-time error. This illustrates an important fact about deleted functions. They do exist as far as function look-up is concerned, but to use them is an error.

## Delegating Constructors

If you provide a class with several constructors, you may find yourself writing the same code over and over. That is, some of the constructors may require you to duplicate code

already present in other constructors. To make coding simpler and more reliable, C++11 allows to you use a constructor as part of the definition of another constructor. This process is termed *delegation* because one constructor temporarily delegates responsibility to another constructor to work on the object it is constructing. Delegation uses a variant of the member initialization list syntax:

```
class Notes {
    int k;
    double x;
    std::string st;
public:
    Notes();
    Notes(int);
    Notes(int, double);
    Notes(int, double, std::string);
};
Notes::Notes(int kk, double xx, std::string stt) : k(kk),
        x(xx), st(stt) { /*do stuff*/}
Notes::Notes() : Notes(0, 0.01, "Oh") { /* do other stuff*/}
Notes::Notes(int kk) : Notes(kk, 0.01, "Ah") { /* do yet other stuff*/ }
Notes::Notes( int kk, double xx ) : Notes(kk, xx, "Uh") { /* ditto*/ }
```

The default constructor, for example, uses the first constructor in the list to initialize the data members and to also do whatever the body of that constructor requests. Then it finishes up doing whatever its own body requests.

## Inheriting Constructors

In another move to simplify coding, C++11 provides a mechanism for derived classes to inherit constructors from the base class. C++98 already had a syntax for making functions from a namespace available:

```
namespace Box
{
    int fn(int) { ... }
    int fn(double) { ... }
    int fn(const char *) { ... }
}
using Box::fn;
```

This makes all the overloaded `fn` functions available. The same technique works for making nonspecial member functions of a base class available to a derived class. For example, consider the following code:

```
class C1
{
    ...
public:
    ...
```

```

    int fn(int j) { ... }
    double fn(double w) { ... }
    void fn(const char * s) { ... }
};
class C2 : public C1
{
    ...
public:
    ...
    using C1::fn;
    double fn(double) { ... };
};
...
C2 c2;
int k = c2.fn(3);          // uses C1::fn(int)
double z = c2.fn(2.4);    // uses C2::fn(double)

```

The using declaration in C2 makes the three `fn()` methods in C1 available to a C2 object. However, the `fn(double)` method defined in C2 is chosen over the one from C1.

C++11 brings the same technique to constructors. All the constructors of the base class, other than the default, copy, and move constructors, are brought in as possible constructors for the derived class, but the ones that have function signatures matching derived class constructors aren't used:

```

class BS
{
    int q;
    double w;
public:
    BS() : q(0), w(0) {}
    BS(int k) : q(k), w(100) {}
    BS(double x) : q(-1), w(x) {}
    B0(int k, double x) : q(k), w(x) {}
    void Show() const {std::cout << q << ", " << w << '\n';}
};

class DR : public BS
{
    short j;
public:
    using BS::BS;
    DR() : j(-100) {}          // DR needs its own default constructor
    DR(double x) : BS(2*x), j(int(x)) {}
    DR(int i) : j(-2), BS(i, 0.5*i) {}
    void Show() const {std::cout << j << ", "; BS::Show();}
};
int main()

```

```

{
    DR o1;           // use DR()
    DR o2(18.81);   // use DR(double) instead of BS(double)
    DR o3(10, 1.8); // use BS(int, double)
    ...
}

```

Because there is no `DR(int, double)` constructor, the inherited `BS(int, double)` is used for `o3`. Note that an inherited base-class constructor only initializes base-class members. If you need to initialize derived class members too, you can use the member list initialization syntax instead of inheritance:

```
DR(int i, int k, double x) : j(i), BS(k,x) {}
```

## Managing Virtual Methods: `override` and `final`

Virtual methods are an important component of implementing polymorphic class hierarchies, in which a base class reference or pointer can invoke the particular method appropriate to the type of object referred to. Virtual methods do pose some programming pitfalls. For instance, suppose the base class declares a particular virtual method, and you decide to provide a different version for a derived class. This is called *overriding* the old version. But, as discussed in Chapter 13, “Class Inheritance,” if you mismatch the function signature, you hide rather than override the old version:

```

class Action
{
    int a;
public:
    Action(int i = 0) : a(i) {}
    int val() const {return a;};
    virtual void f(char ch) const { std::cout << val() << ch << "\n";}
};
class Bingo : public Action
{
public:
    Bingo(int i = 0) : Action(i) {}
    virtual void f(char * ch) const { std::cout << val() << ch << "! \n"; }
};

```

Because class `Bingo` uses `f(char * ch)` instead of `f(char ch)`, `f(char ch)` is hidden to a `Bingo` object. This prevents a program from using code like the following:

```

Bingo b(10);
b.f('@'); // works for Action object, fails for Bingo object

```

With C++11, you can use the virtual specifier `override` to indicate that you intend to override a virtual function. Place it after the parameter list. If your declaration does not match a base method, the compiler objects. Thus, the following version of `Bingo::f()` would generate a compile-time error message:

```
virtual void f(char * ch) const override { std::cout << val()
   << ch << "!\n"; }
```

For example, Microsoft Visual C++ 2010 has this to say:

```
method with override specifier 'override' did not override any
base class methods
```

The specifier `final` addresses a different issue. You may find that you want to prohibit derived classes from overriding a particular virtual method. To do so, place `final` after the parameter list. For example, the following code would prevent classes based on `Action` to redefine the `f()` function:

```
virtual void f(char ch) const final { std::cout << val() << ch << "\n"; }
```

The specifiers `override` and `final` do not quite have the status of keywords. Instead, they are labeled “identifiers with special meaning.” This means that the compiler uses the context in which they appear to decide if they have a special meaning. In other contexts, they can be used as ordinary identifiers (for example, as variable names or enumerations).

## Lambda Functions

When you see the term *lambda functions* (a.k.a. *lambda expressions* or, simply, *lambdas*), you may suspect that this is not one of the C++11 additions intended to help the novice programmer. You will have your suspicions seemingly confirmed when you see how lambda functions actually look—here’s an example:

```
[&count](int x){count += (x % 13 == 0);}
```

But they aren’t as arcane as they may look, and they do provide a useful service, particularly with STL algorithms using function predicates.

## The How of Function Pointers, Functors, and Lambdas

Let’s look at an example using three approaches for passing information to an STL algorithm: function pointers, functors, and lambdas. (For convenience, we’ll refer to these three forms as *function objects* so that we won’t have to keep repeating “function pointer or functor or lambda.”) Suppose you wish to generate a list of random integers and determine how many of them are divisible by 3 and how many are divisible by 13. If necessary, imagine that this is a quest you find absolutely fascinating.

Generating the list is pretty straightforward. One option is to use a `vector<int>` array to hold the numbers and use the STL `generate()` algorithm to stock the array with random numbers:

```
#include <vector>
#include <algorithm>
#include <cmath>
...
std::vector<int> numbers(1000);
std::generate(vector.begin(), vector.end(), std::rand);
```

The `generate()` function takes a range, specified by the first two arguments, and sets each element to the value returned by the third argument, which is a function object that takes no arguments. In this case, the function object is a pointer to the standard `rand()` function.

With the help of the `count_if()` algorithm, it's easy to count the number of elements divisible by 3. The first two arguments should specify the range, just as for `generate()`. The third argument should be a function object that returns `true` or `false`. The `count_if()` function then counts all the elements for which the function object returns `true`. To find elements divisible by 3, you can use this function definition:

```
bool f3(int x) {return x % 3 == 0;}
```

Similarly, you can use the following function definition for finding elements divisible by 13:

```
bool f13(int x) {return x % 13 == 0;}
```

With these definitions in place, you can count elements as follows:

```
int count3 = std::count_if(numbers.begin(), numbers.end(), f3);
cout << "Count of numbers divisible by 3: " << count3 << '\n';
int count13 = std::count_if(numbers.begin(), numbers.end(), f13);
cout << "Count of numbers divisible by 13: " << count13 << "\n\n";
```

Next, let's review how to accomplish the same task using a functor. A functor, as you'll recall from Chapter 16, is a class object than can be used as if it were a function name, thanks to the class defining `operator()()` as a class method. One advantage of the functor in our example is that you can use the same functor for both counting tasks. Here's one possible definition:

```
class f_mod
{
private:
    int dv;
public:
    f_mod(int d = 1) : dv(d) {}
    bool operator()(int x) {return x % dv == 0;}
};
```

Recall how this works. You can use the constructor to create an `f_mod` object storing a particular integer value:

```
f_mod obj(3); // f_mod.dv set to 3
```

This object can use the `operator()` method to return a `bool` value:

```
bool is_div_by_3 = obj(7); // same as obj.operator()(7)
```



The constructor itself can be used as an argument to functions such as `count_if()`:

```
count3 = std::count_if(numbers.begin(), numbers.end(), f_mod(3));
```

The argument `f_mod(3)` creates an object storing the value 3, and `count_if()` uses the created object to call the `operator()()` method, setting the parameter `x` equal to an element of `numbers`. To count how many numbers are divisible by 13 instead of 3, use `f_mod(13)` as the third argument.

Finally, let's examine the lambda approach. The name comes from *lambda calculus*, a mathematical system for defining and applying functions. The system enables one to use anonymous functions—that is, it allows one to dispense with function names. In the C++11 context, you can use an anonymous function definition (a lambda) as an argument to functions expecting a function pointer or functor. The lambda corresponding to the `f3()` function is this:

```
[] (int x) {return x % 3 == 0;}
```

It looks much like the definition of `f3()`:

```
bool f3(int x) {return x % 3 == 0;}
```

The two differences are that the function name is replaced with `[]` (how anonymous is that!) and that there is no declared return type. Instead, the return type is the type that `decltype` would deduce from the return value, which would be `bool` in this case. If the lambda doesn't have a return statement, the type is deduced to be `void`. In our example, you would use this lambda as follows:

```
count3 = std::count_if(numbers.begin(), numbers.end(),
    [] (int x) {return x % 3 == 0;});
```

That is, you use the entire lambda expression as you would use a pointer or a functor constructor.

The automatic type deduction for lambdas works only if the body consists of a single return statement. Otherwise, you need to use the new trailing-return-value syntax:

```
[] (double x) ->double {int y = x; return x - y;} // return type is double
```

Listing 18.4 illustrates the points just discussed.

#### Listing 18.4 `lambda0.cpp`

---

```
// lambda0.cpp -- using lambda expressions
#include <iostream>
#include <vector>
#include <algorithm>
#include <cmath>
#include <ctime>
const long Size1 = 39L;
const long Size2 = 100*Size1;
const long Size3 = 100*Size2;
```

```

bool f3(int x) {return x % 3 == 0;}
bool f13(int x) {return x % 13 == 0;}

int main()
{
    using std::cout;
    std::vector<int> numbers(Size1);

    std::srand(std::time(0));
    std::generate(numbers.begin(), numbers.end(), std::rand);

// using function pointers
    cout << "Sample size = " << Size1 << '\n';

    int count3 = std::count_if(numbers.begin(), numbers.end(), f3);
    cout << "Count of numbers divisible by 3: " << count3 << '\n';
    int count13 = std::count_if(numbers.begin(), numbers.end(), f13);
    cout << "Count of numbers divisible by 13: " << count13 << "\n\n";

// increase number of numbers
    numbers.resize(Size2);
    std::generate(numbers.begin(), numbers.end(), std::rand);
    cout << "Sample size = " << Size2 << '\n';

// using a functor
    class f_mod
    {
    private:
        int dv;
    public:
        f_mod(int d = 1) : dv(d) {}
        bool operator()(int x) {return x % dv == 0;}
    };

    count3 = std::count_if(numbers.begin(), numbers.end(), f_mod(3));
    cout << "Count of numbers divisible by 3: " << count3 << '\n';
    count13 = std::count_if(numbers.begin(), numbers.end(), f_mod(13));
    cout << "Count of numbers divisible by 13: " << count13 << "\n\n";

// increase number of numbers again
    numbers.resize(Size3);
    std::generate(numbers.begin(), numbers.end(), std::rand);
    cout << "Sample size = " << Size3 << '\n';

// using lambdas
    count3 = std::count_if(numbers.begin(), numbers.end(),
        [](int x){return x % 3 == 0;});
    cout << "Count of numbers divisible by 3: " << count3 << '\n';

```

```

count13 = std::count_if(numbers.begin(), numbers.end(),
    [](int x){return x % 13 == 0;});
cout << "Count of numbers divisible by 13: " << count13 << '\n';

return 0;
}

```

---

Here is a sample output:

```

Sample size = 39
Count of numbers divisible by 3: 15
Count of numbers divisible by 13: 6

Sample size = 3900
Count of numbers divisible by 3: 1305
Count of numbers divisible by 13: 302

Sample size = 390000
Count of numbers divisible by 3: 130241

Count of numbers divisible by 13: 29860

```

The output illustrates that one should not rely on statistics based on small samples.

## The Why of Lambdas

You may be wondering what need, other than the flowering of geekly expressionism, the lambda serves. Let's examine this question in terms of four qualities: proximity, brevity, efficiency, and capability.

Many programmers feel that it is useful to locate definitions close to where they are used. That way, you don't have to scan through pages of source code to find, say, what the third argument to a `count_if()` function call accomplishes. Also if you need to modify the code, all the components are close at hand. And if you cut and paste the code for use elsewhere, again all the components are at hand. From this standpoint, lambdas are ideal because the definition is at the point of usage. Functions are worst because functions cannot be defined inside other functions, so the definition will be located possibly quite far from the point of usage. Functors can be pretty good because a class, including a functor class, can be defined inside a function, so the definition can be located close to the point of use.

In terms of brevity, the functor code is more verbose than the equivalent function or lambda code. Functions and lambdas are approximately equally brief. One apparent exception would be if you had to use a lambda twice:

```

count1 = std::count_if(n1.begin(), n1.end(),
    [](int x){return x % 3 == 0;});
count2 = std::count_if(n2.begin(), n2.end(),
    [](int x){return x % 3 == 0;});

```

But you don't actually have to write out the lambda twice. Essentially, you can create a name for the anonymous lambda and then use the name twice:

```
auto mod3 = [] (int x){return x % 3 == 0;} // mod3 a name for the lambda
count1 = std::count_if(n1.begin(), n1.end(), mod3);
count2 = std::count_if(n2.begin(), n2.end(), mod3);
```

You even can use this no-longer-anonymous lambda as an ordinary function:

```
bool result = mod3(z); // result is true if z % 3 == 0
```

Unlike an ordinary function, however, a named lambda can be defined inside a function. The actual type for `mod3` will be some implementation-dependent type that the compiler uses to keep track of lambdas.

The relative efficiencies of the three approaches boils down to what the compiler chooses to inline. Here, the function pointer approach is handicapped by the fact that compilers traditionally don't inline a function that has its address taken because the concept of a function address implies a non-inline function. With functors and lambdas, there is no apparent contradiction with inlining.

Finally, lambdas have some additional capabilities. In particular, a lambda can access by name any automatic variable in scope. Variables to be used are *captured* by having their names listed within the brackets. If just the name is used, as in `[z]`, the variable is accessed by value. If the name is preceded by an `&`, as in `[&count]`, the variable is accessed by reference. Using `[&]` provides access to all the automatic variables by reference, and `[=]` provides access to all the automatic variables by value. You also can mix and match. For instance, `[ted, &ed]` would provide access to `ted` by value and `ed` by reference, `[&, ted]` would provide access to `ted` by value and to all other automatic variables by reference, and `[=, &ed]` would provide access by reference to `ed` and by value to the remaining automatic variables. In Listing 18.4, you can replace

```
int count13;
...
count13 = std::count_if(numbers.begin(), numbers.end(),
    [] (int x){return x % 13 == 0;});
```

with this:

```
int count13 = 0;
std::for_each(numbers.begin(), numbers.end(),
    [&count13](int x){count13 += x % 13 == 0;});
```

The `[&count13]` allows the lambda to use `count13` in its code. Because `count13` is captured by reference, any changes to `count13` in the lambda are changes to the original `count13`. The expression `x % 13 == 0` evaluates to `true` if `x` is divisible by 13, and `true` converts to 1 when added to `count13`. Similarly, `false` converts to 0. Thus, after `for_each()` applies the lambda expression to each element of `numbers`, `count13` counts the number of elements divisible by 13.

You can use this technique to count elements divisible by 3 and elements divisible by 13 using a single lambda expression:

```
int count3 = 0;
int count13 = 0;
std::for_each(numbers.begin(), numbers.end(),
    [&](int x){count3 += x % 3 == 0; count13 += x % 13 == 0;});
```

This time, [&] makes all the automatic variables, including `count3` and `count13`, available to the lambda expression.

Listing 18.5 puts these techniques to use.

---

#### Listing 18.5 `lambda1.cpp`

```
// lambda1.cpp -- use captured variables
#include <iostream>
#include <vector>
#include <algorithm>
#include <cmath>
#include <ctime>
const long Size = 390000L;

int main()
{
    using std::cout;
    std::vector<int> numbers(Size);

    std::srand(std::time(0));
    std::generate(numbers.begin(), numbers.end(), std::rand);
    cout << "Sample size = " << Size << '\n';
    // using lambdas
    int count3 = std::count_if(numbers.begin(), numbers.end(),
        [](int x){return x % 3 == 0;});
    cout << "Count of numbers divisible by 3: " << count3 << '\n';
    int count13 = 0;
    std::for_each(numbers.begin(), numbers.end(),
        [&count13](int x){count13 += x % 13 == 0;});
    cout << "Count of numbers divisible by 13: " << count13 << '\n';
    // using a single lambda
    count3 = count13 = 0;
    std::for_each(numbers.begin(), numbers.end(),
        [&](int x){count3 += x % 3 == 0; count13 += x % 13 == 0;});
    cout << "Count of numbers divisible by 3: " << count3 << '\n';
    cout << "Count of numbers divisible by 13: " << count13 << '\n';
    return 0;
}
```

---

Here is a sample output:

```
Sample size = 390000
Count of numbers divisible by 3: 130274
Count of numbers divisible by 13: 30009
Count of numbers divisible by 3: 130274
Count of numbers divisible by 13: 30009
```

It's reassuring that both approaches (two separate lambdas and a single lambda) in this program led to the same answers.

The main motivation for adding lambdas to C++ was to enable using a function-like expression as an argument to a function expecting a function pointer or functor as an argument. So the typical lambda would be a test expression or comparison expression that could be written as a single return statement. That keeps the lambda short and easy to understand and enables automatic deduction of the return value. However, it is likely that a subset of the ingenious C++ programming community will develop other uses.

## Wrappers

C++ provides several *wrappers* or *adapters*. These are objects used to provide a more uniform or more appropriate interface for other programming elements. For example, Chapter 16 described `bind1st` and `bind2nd`, which adapt functions with two parameters to match up with STL algorithms that expect functions with one parameter to be supplied as an argument. C++11 provides additional wrappers. They include the `bind` template, which provides a more flexible alternative to `bind1st` and `bind2nd`, the `mem_fn` template, which allows a member function to pass as a regular function, the `reference_wrapper` template allows you to create an object that acts like reference but which can be copied, and the `function` wrapper, which provides a way to handle several function-like forms uniformly.

Let's look more closely at one example of wrapper, the `function` wrapper, and at the problem it addresses.

### The `function` Wrapper and Template Inefficiencies

Consider the following line of code:

```
answer = ef(q);
```

What is `ef`? It could be the name of a function. It could be a pointer to a function. It could be a function object. It could be a name assigned to a lambda expression. These all are examples of *callable types*. The abundance of callable types can lead to template inefficiencies. To see this, let's examine a simple case.

First, let's define some templates in a header file, as shown in Listing 18.6.

Listing 18.6 **somedefs.h**

---

```

// somedefs.h
#include <iostream>

template <typename T, typename F>
T use_f(T v, F f)
{
    static int count = 0;
    count++;
    std::cout << " use_f count = " << count
              << ", &count = " << &count << std::endl;
    return f(v);
}

class Fp
{
private:
    double z_;
public:
    Fp(double z = 1.0) : z_(z) {}
    double operator()(double p) { return z_*p; }
};

class Fq
{
private:
    double z_;
public:
    Fq(double z = 1.0) : z_(z) {}
    double operator()(double q) { return z_+ q; }
};

```

---

The `use_f()` template uses the parameter `f` to represent a callable type:  
`return f(v);`

Next the program in Listing 18.7 calls the `use_f()` template function six times.

Listing 18.7 **callable.cpp**

---

```

// callable.cpp -- callable types and templates
#include "somedefs.h"
#include <iostream>

double dub(double x) {return 2.0*x;}
double square(double x) {return x*x;}

```

```

int main()
{
    using std::cout;
    using std::endl;

    double y = 1.21;
    cout << "Function pointer dub:\n";
    cout << " " << use_f(y, dub) << endl;
    cout << "Function pointer square:\n";
    cout << " " << use_f(y, square) << endl;
    cout << "Function object Fp:\n";
    cout << " " << use_f(y, Fp(5.0)) << endl;
    cout << "Function object Fq:\n";
    cout << " " << use_f(y, Fq(5.0)) << endl;
    cout << "Lambda expression 1:\n";
    cout << " " << use_f(y, [] (double u) {return u*u;}) << endl;
    cout << "Lambda expression 2:\n";
    cout << " " << use_f(y, [] (double u) {return u+u/2.0;}) << endl;
    return 0;
}

```

---

The template parameter `T` is set to type `double` for each call. What about template parameter `F`? Each time the actual argument is something that takes a type `double` argument and returns a type `double` value, so it might seem that `F` would be the same type for all six calls to `use_f()` and that the template would be instantiated just once. But as the following sample output shows, that belief is naïve:

```

Function pointer dub:
  use_f count = 1, &count = 0x402028
  2.42
Function pointer square:
  use_f count = 2, &count = 0x402028
  1.1
Function object Fp:
  use_f count = 1, &count = 0x402020
  6.05
Function object Fq:
  use_f count = 1, &count = 0x402024
  6.21
Lambda expression 1:
  use_f count = 1, &count = 0x405020
  1.4641
Lambda expression 2:
  use_f count = 1, &count = 0x40501c
  1.815

```



The template function `use_f()` has a static member `count`, and we can use its address to see how many instantiations are made. There are five distinct addresses, so there must have been five distinct instantiations of the `use_f()` template.

To see what is happening, consider how the compiler determines the type for the `F` template parameter. First, look at this call:

```
use_f(y, dub);
```

Here `dub` is the name of a function that takes a `double` argument and returns a `double` value. The name of a function is a pointer, hence the parameter `F` becomes type `double (*) (double)`, a pointer to a function with a `double` argument and a `double` return value.

The next call is this:

```
use_f(y, square);
```

Again, the second argument is type `double (*) (double)`, so this call uses the same instantiation of `use_f()` as the first call.

The next two calls to `use_f()` have objects as second arguments, so `F` becomes type `Fp` and `Fq` respectively, so we get two new instantiations for these values of `F`. Finally, the last two calls set `F` to whatever types the compiler uses for lambda expressions.

## Fixing the Problem

The function wrapper lets you rewrite the program so that it uses just one instantiation of `use_f()` instead of five. Note that the function pointers, function objects, and lambda expressions in Listing 18.7 share a common behavior—each takes one type `double` argument and each returns a type `double` value. We can say that each has the same *call signature*, which is described by the return type followed by a comma-separated list of parameter types enclosed in a pair of parentheses. Thus, these six examples all have `double(double)` as the call signature.

The function template, declared in the `functional` header file, specifies an object in terms of a call signature, and it can be used to wrap a function pointer, function object, or lambda expression having the same call signature. For example, the following declaration creates a function object `fdci` that takes a `char` and an `int` argument and returns type `double`:

```
std::function<double(char, int)> fdci;
```

You can then assign to `fdci` any function pointer, function object, or lambda expression that takes type `char` and `int` arguments and returns type `double`.

The various callable arguments in Listing 18.7 all have the same call signature — `double(double)`. So to fix Listing 18.7 and reduce the number of instantiations, we can use `function<double(double)>` to create six wrappers for the six functions, functors, and lambdas. Then all six calls to `use_f()` can be made with the same type (`function<double(double)>`) for `F`, resulting in just one instantiation. Listing 18.8 shows the result.

## Listing 18.8 wrapped.cpp

---

```

//wrapped.cpp -- using a function wrapper as an argument
#include "somedefs.h"
#include <iostream>
#include <functional>

double dub(double x) {return 2.0*x;}
double square(double x) {return x*x;}

int main()
{
    using std::cout;
    using std::endl;
    using std::function;

    double y = 1.21;
    function<double(double)> ef1 = dub;
    function<double(double)> ef2 = square;
    function<double(double)> ef3 = Fq(10.0);
    function<double(double)> ef4 = Fp(10.0);
    function<double(double)> ef5 = [] (double u) {return u*u;};
    function<double(double)> ef6 = [] (double u) {return u+u/2.0;};
    cout << "Function pointer dub:\n";
    cout << " " << use_f(y, ef1) << endl;
    cout << "Function pointer square:\n";
    cout << " " << use_f(y, ef2) << endl;
    cout << "Function object Fp:\n";
    cout << " " << use_f(y, ef3) << endl;
    cout << "Function object Fq:\n";
    cout << " " << use_f(y, ef4) << endl;
    cout << "Lambda expression 1:\n";
    cout << " " << use_f(y, ef5) << endl;
    cout << "Lambda expression 2:\n";
    cout << " " << use_f(y, ef6) << endl;
    return 0;
}

```

---

Here is a sample output:

```

Function pointer dub:
  use_f count = 1, &count = 0x404020
  2.42
Function pointer sqrt:
  use_f count = 2, &count = 0x404020
  1.1

```

```

Function object Fp:
    use_f count = 3, &count = 0x404020
    11.21
Function object Fq:
    use_f count = 4, &count = 0x404020
    12.1
Lambda expression 1:
    use_f count = 5, &count = 0x404020
    1.4641
Lambda expression 2:
    use_f count = 6, &count = 0x404020
    1.815

```

As you can see from the output, there is just one address for `count`, and the value of `count` shows `use_f()` has been called six times. So we now have just one instantiation invoked six times, reducing the size of the executable code.

## Further Options

Let's look at a couple more things you can do using `function`. First, we don't actually have to declare six `function<double(double)>` objects in Listing 18.8. Instead, we can use a temporary `function<double(double)>` object as an argument to the `use_f()` function:

```

typedef function<double(double)> fdd; // simplify the type declaration
cout << use_f(y, fdd(dub)) << endl; // create and initialize object to dub
cout << use_f(y, fdd(square)) << endl;
...

```

Second, Listing 18.8 adapts the second arguments in `use_f()` to match the formal parameter `f`. Another approach is to adapt the type of the formal parameter `f` to match the original arguments. This can be done by using a function wrapper object as the second parameter for the `use_f()` template definition. We can define `use_f()` this way:

```

#include <functional>
template <typename T>
T use_f(T v, std::function<T(T)> f) // f call signature is T(T)
{
    static int count = 0;
    count++;
    std::cout << " use_f count = " << count
              << ", &count = " << &count << std::endl;
    return f(v);
}

```

Then the function calls can look like this:

```

cout << " " << use_f<double>(y, dub) << endl;
...

```

```
cout << " " << use_f<double>(y, Fp(5.0)) << endl;
...
cout << " " << use_f<double>(y, [](double u) {return u*u;}) << endl;
```

The arguments `dub`, `Fp(5.0)`, etc., are not themselves type `function<double(double)>`, and so the calls `use<double>` after `use_f` to indicate the desired specialization. Thus `T` is set to `double`, and `std::function<T(T)>` becomes `std::function<double(double)>`.

## Variadic Templates

Variadic templates provide a means to create template functions and template classes that accept a variable number of arguments. We'll look at variadic template functions here. For example, suppose we want a function that will accept any number of parameters of any type, providing the type can be displayed with `cout`, and display the arguments as a comma-separated list. For instance, consider this code:

```
int n = 14;
double x = 2.71828;
std::string mr = "Mr. String objects!";
show_list(n, x);
show_list(x*x, '!', 7, mr);
```

The goal is to be able to define `show_list()` in such a way that this code would compile and lead to this output:

```
14, 2.71828
7.38905, !, 7, Mr. String objects!
```

There are a few key points to understand in order to create variadic templates:

- Template parameter packs
- Function parameter packs
- Unpacking a pack
- Recursion

## Template and Function Parameter Packs

As a starting point to see how parameter packs work, let's consider a simple template function, one that displays a list consisting of just one item:

```
template<typename T>
void show_list0(T value)
{
    std::cout << value << ", ";
}
```

This definition has two parameter lists. The template parameter list is just `T`. The function parameter list is just `value`. A function call such as the following sets `T` in the template parameter list to `double` and `value` in the function parameter list to `2.15`:

```
show_list0(2.15);
```

C++11 provides an ellipsis meta-operator that enables you to declare an identifier for a template parameter pack, essentially a list of types. Similarly, it lets you declare an identifier for a function parameter pack, essentially a list of values. The syntax looks like this:

```
template<typename... Args> // Args is a template parameter pack
void show_list1(Args... args) // args is a function parameter pack
{
...
}
```

`Args` is a template parameter pack, and `args` is a function parameter pack. (As with other parameter names, any name satisfying C++ identifier rules can be used for these packs.) The difference between `Args` and `T` is that `T` matches a single type, whereas `Args` matches any number of types, including none. Consider the following function call:

```
show_list1('S', 80, "sweet", 4.5);
```

In this case the parameter pack `Args` contains the types matching the parameters in the function call: `char`, `int`, `const char *`, and `double`.

Next, much as

```
void show_list0(T value)
```

states that `value` is of type `T`, the line

```
void show_list1(Args... args) // args is a function parameter pack
```

states that `args` is of type `Args`. More precisely, this means that the function pack `args` contains a list of values that matches the list of types in the template pack `Args`, both in type and in number. In this case, `args` contains the values `'S'`, `80`, `"sweet"`, and `4.5`.

In this manner, the `show_list1()` variadic template can match any of the following function calls:

```
show_list1();
show_list1(99);
show_list1(88.5, "cat");
show_list1(2,4,6,8, "who do we", std::string("appreciate));
```

In the last case, the `Args` template parameter pack would contain the types `int`, `int`, `int`, `const char *`, and `std::string`, and the `args` function parameter pack would contain the matching values `2`, `4`, `6`, `8`, `"who do we"`, and `std::string("appreciate")`.

## Unpacking the Packs

But how can the function access the contents of these packs? There is no indexing feature. That is, you can't use something like `Args[2]` to access the third type in a pack.

Instead, you can unpack the pack by placing the ellipsis to the right of the function parameter pack name. For example, consider the following flawed code:

```
template<typename... Args>    // Args is a template parameter pack
void show_list1(Args... args) // args is a function parameter pack
{
    show_list1(args...); // passes unpacked args to show_list1()
}
```

What does this mean, and why is it flawed? Suppose we have this function call:

```
show_list1(5, 'L', 0.5);
```

The call packs the values 5, 'L', and 0.5 into `args`. Within the function, the call

```
show_list1(args...);
```

expands to the following:

```
show_list1(5, 'L', 0.5);
```

That is, the single entity `args` is replaced by the three values stored within the pack. So the notation `args...` expands to a list of discrete function arguments. Unfortunately, the new call is the same as the original function call, so it will call itself again with the same arguments, initiating an infinite and futile recursion. (That would be the flaw.)

## Using Recursion in Variadic Template Functions

Although recursion dooms `show_list1()` aspirations to be a useful function, properly used recursion provides a solution to accessing pack items. The central idea is to unpack the function parameter pack, process the first item in the list, then pass the rest of the list on to a recursive call, and so on, until the list is empty. As usual with recursion, it's important to make sure that there is a call that terminates the recursion. Part of the trick involves changing the template heading to this:

```
template<typename T, typename... Args>
void show_list3( T value, Args... args)
```

With this definition, the first argument to `show_list3()` gets picked up as type `T` and is assigned to `value`. The remaining arguments are picked up by `Args` and `args`. This allows the function to do something with `value`, such as display it. Then the remaining arguments, in the form `args...`, can be passed to a recursive call of `show_list3()`. Each recursive call then prints a value and passes on a shortened list until the list is exhausted.

Listing 18.9 presents an implementation that, although not perfect, illustrates the technique.

### Listing 18.9 `variadic1.cpp`

---

```
//variadic1.cpp -- using recursion to unpack a parameter pack
#include <iostream>
#include <string>
```

```

// definition for 0 parameters -- terminating call
void show_list3() {}

// definition for 1 or more parameters
template<typename T, typename... Args>
void show_list3( T value, Args... args)
{
    std::cout << value << ", ";
    show_list3(args...);
}

int main()
{
    int n = 14;
    double x = 2.71828;
    std::string mr = "Mr. String objects!";
    show_list3(n, x);
    show_list3(x*x, '!', 7, mr);
    return 0;
}

```

---

### Program Notes

Consider this function call:

```
show_list3(x*x, '!', 7, mr);
```

The first argument matches `T` to `double` and `value` to `x*x`. The remaining three types (`char`, `int`, and `std::string`) are placed in the `Args` pack, and the remaining three values (`'!'`, `7`, and `mr`) are placed in the `args` pack.

Next, the `show_list3()` function uses `cout` to display `value` (approximately 7.38905) and the string `", "`. That takes care of displaying the first item in the list.

Next comes this call:

```
show_list3(args...);
```

This, given the expansion of `args...`, is the same as the following:

```
show_list3('!', 7, mr);
```

As promised, the list is shortened by one item. This time `T` and `value` become `char` and `'!'`, and the remaining two types and values are packed into `Args` and `args`, respectively. The next recursive call processes these reduced packs. Finally, when `args` is empty, the version of `show_list3()` with no arguments is called, and the process terminates.

Here is the output for the two function calls in Listing 18.5:

```
14, 2.71828, 7.38905, !, 7, Mr. String objects!,
```

## Improvements

We can improve `show_list3()` with a couple of changes. As it stands, the function displays a comma after every item in the list, but it would be better to omit the comma after the last item. This can be accomplished by adding a template for just one item and having it behave slightly differently from the general template:

```
// definition for 1 parameter
template<typename T>
void show_list3(T value)
{
    std::cout << value << '\n';
}
```

Thus, when the `args` pack is reduced to one item, this version is called, and it prints a newline instead of a comma. Because it lacks a recursive call to `show_list3()`, it also terminates the recursion.

The second area for improvement is that the current version passes everything by value. This is okay for the simple types we've used, but it's inefficient for classes of large size that might be printable by `cout`. It would be better to use `const` references. With variadic templates, you can impose a *pattern* on the unpacking. Instead of using

```
show_list3(Args... args);
```

you can use this:

```
show_list3(const Args&... args);
```

That will cause each function parameter to have the `const&` pattern applied. Thus, instead of `std::string mr`, the final paring of parameters becomes `const std::string& mr`.

Listing 18.10 incorporates these two changes.

### Listing 18.10 `variadic2.cpp`

---

```
// variadic2.cpp
#include <iostream>
#include <string>

// definition for 0 parameters
void show_list() {}

// definition for 1 parameter
template<typename T>
void show_list(const T& value)
{
    std::cout << value << '\n';
}
```



```
// definition for 2 or more parameters
template<typename T, typename... Args>
void show_list(const T& value, const Args&... args)
{
    std::cout << value << ", ";
    show_list(args...);
}

int main()
{
    int n = 14;
    double x = 2.71828;
    std::string mr = "Mr. String objects!";
    show_list(n, x);
    show_list(x*x, '!', 7, mr);
    return 0;
}
```

---

Here is the output:

```
14, 2.71828
7.38905, !, 7, Mr. String objects!
```

## More C++11 Features

C++11 adds many more features than this book can cover, even ignoring the fact that many of them are not widely implemented at the time this book was written. Still, it's worth taking a quick look at the nature of some of these features.

### Concurrent Programming

These days it's easier to improve computer performance by adding processors than it is to increase processor speed. So computers with dual-core or quad-core processors or even with multiple multicore processors are the norm. This enables computers to run multiple threads of execution simultaneously. One processor might handle a video download while another processor handles your spreadsheet.

Some activities can benefit from multiple threads, whereas others don't. Consider searching for something in a singly linked list. A program has to start at the beginning and follow the links, in order, to the end of the list; there's nothing much a second thread could do to help. Now consider an unsorted array. Using the random access feature of arrays, you could start one thread from the beginning of the array and one from the middle, thus halving the search time.

Multiple threads do raise many problems. What happens if one thread hangs up or if two threads try to access the same data simultaneously? C++11 addresses concurrency by

defining a memory model that supports threaded execution, by adding the keyword `thread_local`, and by providing library support. The keyword `thread_local` is used to declare variables having static storage duration relative to a particular thread; that is, they expire when the thread in which they are defined expires.

The library support consists of the atomic operations library, which specifies the `atomic` header file, and the thread support library, which specifies the `thread`, `mutex`, `condition_variable`, and `future` header files.

## Library Additions

C++11 adds several specialized libraries. An extensible random number library, supported by the `random` header file, provides much more extensive and sophisticated random number facilities than `rand()`. For example, it offers a choice of random-number generators and a choice of distributions, including uniform (like `rand()`), binomial, normal, and several others.

The `chrono` header file supports ways to deal with time duration.

The `tuple` header file supports the `tuple` template. A `tuple` object is a generalization of a `pair` object. Whereas a `pair` object can hold two values whose types need not be the same, a `tuple` can hold an arbitrary number of items of different types.

The compile-time rational arithmetic library, supported by the `ratio` header file, allows the exact representation of any rational number whose numerator and denominator can be represented by the widest integer type. It also provides arithmetic operations for these numbers.

One of the most interesting additions is a regular expression library, supported by the `regex` header file. A regular expression specifies a pattern that can be used to match contents in a text string. For example, a bracket expression matches any single character in the brackets. Thus, `[cCkK]` matches a single `c`, `C`, `k`, or `K`, and `[cCkK]at` matches the words `cat`, `Cat`, `kat`, and `Kat`. Other patterns include `\d` for a digit, `\w` for a word, `\t` for a tab, and many, many others. The fact that a backslash has a special meaning in C++ as the first character in an escape sequence requires a pattern like `\d\t\w\d` (that is, digit-tab-word-digit) to be written as the string literal `"\\d\\t\\w\\d"`, using `\\` to represent `\`. This is one reason the raw string was introduced (see Chapter 4); it enables you to write the same pattern as `R"d\t\w\d"`.

Unix utilities such as `ed`, `grep`, and `awk` used regular expressions, and the interpreted language Perl extended their capabilities. The C++ regular expressions library allows you to choose from several flavors of regular expressions.

## Low-Level Programming

The “low level” in low-level programming refers to the level of abstraction, not to the quality of the programming. Low level means closer to the bits and bytes of computer hardware and machine language. Low-level programming is important for embedded programming and for increasing the efficiency of some operations. C++11 offers some aids to those who do low-level programming.

One change is relaxing the constraints on what qualifies as “Plain Old Data,” or POD. In C++98, a POD is a scalar type (a one-value type, such as `int` or `double`) or an old-fashioned structure with no constructors, base classes, private data, virtual functions, and so on. The idea was that a POD is something for which it’s safe to make a byte-by-byte copy. That is still the idea, but C++11 recognizes one can remove some the C++98 restrictions and still have a viable POD. This helps low-level programming because some low-level operations, such as using the C functions for byte-wise copying or binary I/O, required PODs.

Another change is making unions more flexible by allowing them to have members that have constructors and destructors, but with some restrictions on other properties, for example, not allowing virtual functions. Unions are often utilized when minimizing the amount of memory used is important, and the new rules allow programmers to bring more flexibility and capability to these situations.

C++11 addresses memory alignment issues. Computer systems can restrict how data is stored in memory. For example, one system might require that a `double` value be stored at an even-numbered memory location, whereas another might require the storage to begin at a location that is a multiple of eight. The `alignof()` operator (see Appendix E, “Other Operators”) provides information on the alignment requirements for a type or object. The `alignas` specifier provides some control over the alignment used.

The `constexpr` mechanism expands the ability of the compiler to evaluate during compile time expressions that evaluate to a constant value. The low-level aspect of this is to allow `const` variables to be stored in read-only memory, which can be particularly useful in embedded programming. (Variables, `const` or otherwise, that are initialized during runtime, are stored in random-access memory.)

## Miscellaneous

C++11 follows the lead of C99 in allowing for implementation-dependent extended integer types. Such types, for example, could be used on a system with 128-bit integers. Extended types are supported in the C header file `stdint.h` and in the C++ version, `cstdint`.

C++11 provides a mechanism, the *literal operator*, for creating user-defined literals. Using this mechanism, for instance, one can define binary literals, such as `1001001b`, which the corresponding literal operator will convert to an integer value.

C++ has a debugging tool called `assert`. It is a macro that checks during runtime if an assertion is true and which displays a message and calls `abort()` if the assertion is false. The assertion would typically be about something the programmer thinks should be true at that point in the program. C++11 adds the keyword `static_assert`, which can be used to test assertions during compile time. The primary motivation is to make it easier to debug templates for which instantiation takes place during compile time, not runtime.

C++11 provides more support for metaprogramming, which is creating programs that create or modify other programs or even themselves. In C++ this can be done during compile time using templates.

## Language Change

How does a computer language grow and evolve? after usage of C++ became sufficiently widespread, the need for an international standard became clear, and control of the language essentially passed to a standards committee—first the ANSI committee, then the joint ISO/ANSI committees, and currently to ISO/IEC JTC1/SC22/WG21 (the C++ Standards Committee). ISO is the International Organization for Standardization, IEC is the International Electrotechnical Commission, JTC1 is the Joint Technical Committee 1 of the preceding two organizations, SC22 is the JTC1 subcommittee for programming languages, and WG21 is the SC22 working group for C++.

The committee considers defect reports and proposals for changes in and extensions to the language, and it attempts to reach a consensus. This is neither a speedy nor a simple process. *The Design and Evolution of C++* (Stroustrup, Addison-Wesley, 1994) provides some insight on this subject. Anyway, the possibly contentious and ponderous dynamics of a consensus-seeking committee are not the best way to encourage the blossoming of a multitude of innovations. Nor is that the proper role of a standards committee.

But with C++ there is a second avenue for change: direct action by the creative C++ programming community. Programmers can't independently change the language, but they can create useful libraries. Well-designed libraries can extend the usefulness and versatility of the language, increase reliability, and make programming easier and more enjoyable. Libraries build on the existing features of a language, so they don't require any additional compiler support. And if they are implemented through templates, they can be distributed as text files in the form of header files.

One example of this sort of change is the STL, primarily created by Alexander Stepanov, and made freely available by Hewlett-Packard. Its success with the programming community made it a candidate for the first ANSI/ISO standard. Indeed, its design influenced other aspects of the emerging standard.

### The Boost Project

More recently, the Boost library has become an important part of C++ programming and has had a significant influence on C++11. The Boost project began in 1998 when Beman Dawes, the then-chairman of the C++ library working group, brought together a few other members of the group and developed a plan to generate new libraries outside the confines of the standards committee. The basic idea was to provide a website that acts as an open forum for people to post free C++ libraries. The project provides guidelines for licensing and programming practices, and it requires peer review of proposed libraries. The result is a group of highly praised and highly used libraries. The project provides an environment in which the programming community can test and evaluate programming ideas and provide feedback.

Boost has over 100 libraries at the time of this writing, and they can be downloaded as a set from [www.boost.org](http://www.boost.org), as can documentation. Most of the libraries can be used by including the appropriate header files.

## The TR1

The Technical Report 1, or TR1, was a project of a subset of the C++ Standards committee. TR1 was a compilation of library extensions that were compatible with the C++98 standard, but which were not required by the standard. They were candidates for the next iteration of the standard. The TR1 library enabled the C++ community to test the worthiness of the library components. Thus, when the standards committee incorporated most of TR1 into C++11, it was dealing with known and proven libraries.

The Boost libraries contributed much to TR1. Examples include the `tuple` template class, the `array` template class, the `bind` and `function` templates, smart pointers (with some name and implementation changes), `static_assert`, the `regex` library, and the `random` library. Furthermore, the experiences of the Boost community and of users of the TR1 led to actual language changes, such as the deprecation of exception specifications, and the addition of variadic templates, which allows for a better implementation of the `tuple` template class and of the `function` template.

## Using Boost

Although you now can access many Boost-developed libraries as part of the C++11 standard, there are many additional Boost libraries to explore. For example, `lexical_cast` from the Conversion library provides simple conversions between numeric and string types. The syntax is modeled after `dynamic_cast`, in which you provide the target type as a template parameter. Listing 18.11 shows a simple example.

Listing 18.11 `lexcast.cpp`

---

```
// lexcast.cpp -- simple cast from float to string
#include <iostream>
#include <string>
#include "boost/lexical_cast.hpp"
int main()
{
    using namespace std;
    cout << "Enter your weight: ";
    float weight;
    cin >> weight;
    string gain = "A 10% increase raises ";
    string wt = boost::lexical_cast<string>(weight);
    gain = gain + wt + " to "; // string operator+()
    weight = 1.1 * weight;
    gain = gain + boost::lexical_cast<string>(weight) + ".";
    cout << gain << endl;
    return 0;
}
```

---

Here are a couple of sample runs:

```
Enter your weight: 150
A 10% increase raises 150 to 165.
```

```
Enter your weight: 156
A 10% increase raises 156 to 171.600006.
```

The second sample run shows one of the limitations of `lexical_cast`; it doesn't provide fine control over floating-point formatting. To get that, you need to use the more elaborate incore formatting facilities discussed in Chapter 17, "Input, Output, and Files."

You also can use `lexical_cast` to convert strings to numeric values.

Obviously, there is much, much more to Boost. For example, the `Any` library allows you to store (and recover) a heterogeneous collection of values and objects of different types in an STL container, using the `Any` template as a wrapper for the various values. The Boost Math library extends the list of math functions beyond that of the standard math library. The Boost Filesystem library facilitates writing code that is portable across platforms using different file systems. You can refer to the Boost website ([www.boost.org](http://www.boost.org)) to get more information about the contents of the library and how to add it to various platforms. Also some C++ distributions, such as the one from Cygwin, come with the Boost library included.

## What Now?

If you have worked your way through this book, you should have a good grasp of the rules of C++. However, that's just the beginning in learning this language. The second stage is learning to use the language effectively, and that is the longer journey. The best situation is to be in a work or learning environment that brings you into contact with good C++ code and programmers. Also now that you know C++, you can read books that concentrate on more advanced topics and on object-oriented programming. Appendix H, "Selected Readings and Internet Resources," lists some of these resources.

One promise of OOP is to facilitate the development and enhance the reliability of large projects. One of the essential activities of the OOP approach is to invent the classes that represent the situation (called the *problem domain*) that you are modeling. Because real problems are often complex, finding a suitable set of classes can be challenging. Creating a complex system from scratch usually doesn't work; instead, it's best to take an iterative, evolutionary approach. Toward this end, practitioners in the field have developed several techniques and strategies. In particular, it's important to do as much of the iteration and evolution in the analysis and design stages as possible instead of writing and rewriting actual code.

Two common techniques are *use-case analysis* and *CRC cards*. In use-case analysis, the development team lists the common ways, or scenarios, in which it expects the final system to be used, identifying elements, actions, and responsibilities that suggest possible

classes and class features. Using CRC (short for Class/Responsibilities/Collaborators) cards is a simple way to analyze such scenarios. The development team creates an index card for each class. On the card are the class name; class responsibilities, such as data represented and actions performed; and class collaborators, such as other classes with which the class must interact. Then the team can walk through a scenario, using the interface provided by the CRC cards. This can lead to suggestions for new classes, shifts of responsibility, and so on.

On a larger scale are the systematic methods for working on entire projects. The most recent of these is the Unified Modeling Language (UML). UML is not a programming language; rather, it is a language for representing the analysis and design of a programming project. It was developed by Grady Booch, Jim Rumbaugh, and Ivar Jacobson, who had been the primary developers of three earlier modeling languages: the Booch Method, OMT (Object Modeling Technique), and OOSE (Object-Oriented Software Engineering), respectively. UML is the evolutionary successor of these three, and ISO/IEC published a standard for it in 2005.

In addition to increasing your understanding of C++ in general, you might want to learn about specific class libraries. Microsoft and Embarcadero, for example, offer extensive class libraries to facilitate programming for the Windows environment, and Apple Xcode offers similar facilities for Apple products, including the iPhone.

## Summary

The new C++ standard adds many features to the language. Some are intended to make the language easier to learn and easier to use. Examples include uniform braced list initialization, automatic type deduction with `auto`, in-class member initialization, and the range-based `for` loop. Other changes expand and clarify class design. These changes include defaulted and deleted methods, delegated constructors, inherited constructors, and the `override` and `final` specifiers for clarifying virtual function design.

Several additions aim to make programs and the act programming more efficient. Lambda expressions provide advantages over function pointers and functors. The `function` template can be used to reduce the number of template instantiations. The `rvalue` reference enables move semantics and allows for move constructors and move assignment operators.

Other changes deliver better ways of doing things. Scoped enumerations provide better control over the scope and underlying types for enumerations. The `unique_ptr` and `shared_ptr` templates provide better ways of handling memory allocated with `new`.

Template design has been enhanced with the addition of `decltype`, trailing return types, template aliases, and variadic templates.

Modified rules for unions, PODs, the `alignof()` operator, the `alignas` specifier, and the `constexpr` mechanism support low-level programming.

Several library additions, including the new STL classes, the `tuple` template, and the `regex` library, provide solutions to many common programming needs.

The new standard addresses concurrent programming with the `thread_local` keyword and the `atomic` library.

All in all, the new standard improves the usability and reliability of C++, both for novices and for experts.

## Chapter Review

1. Rewrite the following code using braced initialization list syntax; the rewrite should dispense with using the array `ar`:

```
class Z200
{
private:
    int j;
    char ch;
    double z;
public:
    Z200(int jv, char chv, zv) : j(jv), ch(chv), z(zv) {}
    ...
};

double x = 8.8;
std::string s = "What a bracing effect!";
int k(99);
Z200 zip(200, 'Z', 0.675);
std::vector<int> ai(5);
int ar[5] = {3, 9, 4, 7, 1};
for (auto pt = ai.begin(), int i = 0; pt != ai.end(); ++pt, ++i)
    *pt = ai[i];
```

2. For the following short program, which function calls are errors and why? For the valid calls, what does the reference argument refer to?

```
#include <iostream>
using namespace std;

double up(double x) { return 2.0* x;}
void r1(const double &rx) {cout << rx << endl;}
void r2(double &rx) {cout << rx << endl;}
void r3(double &&rx) {cout << rx << endl;}

int main()
{
    double w = 10.0;
    r1(w);
    r1(w+1);
    r1(up(w));
```



```

    r2(w);
    r2(w+1);
    r2(up(w));
    r3(w);
    r3(w+1);
    r3(up(w));
    return 0;
}

```

3. a. What does the following short program display and why?

```

#include <iostream>
using namespace std;

double up(double x) { return 2.0* x;}
void r1(const double &rx) {cout << "const double & rx\n";}
void r1(double &rx) {cout << "double & rx\n";}

int main()
{
    double w = 10.0;
    r1(w);
    r1(w+1);
    r1(up(w));
    return 0;
}

```

- b. What does the following short program display and why?

```

#include <iostream>
using namespace std;

double up(double x) { return 2.0* x;}
void r1(double &rx) {cout << "double & rx\n";}
void r1(double &&rx) {cout << "double && rx\n";}

int main()
{
    double w = 10.0;
    r1(w);
    r1(w+1);
    r1(up(w));
    return 0;
}

```

- c. What does the following short program display and why?

```

#include <iostream>
using namespace std;

```

```

double up(double x) {return 2.0* x;}
void r1(const double &rx) {cout << "const double & rx\n";}
void r1(double &&rx) {cout << "double && rx\n";}

int main()
{
    double w = 10.0;
    r1(w);
    r1(w+1);
    r1(up(w));
    return 0;
}

```

4. Which member functions are special member functions, and what makes them special?
5. Suppose the `Fizzle` class has only the data members shown:

```

class Fizzle
{
private:
    double bubbles[4000];
    ...
};

```

Why would this class not be a good candidate for a user-defined move constructor? What change in approach to storing the 4000 double values would make the class a good candidate for a move function?

6. Revise the following short program so that it uses a lambda expression instead of `f1()`. Don't change `show2()`.

```

#include <iostream>
template<typename T>
void show2(double x, T& fp) {std::cout << x << " -> " << fp(x) << '\n';}
double f1(double x) { return 1.8*x + 32;}
int main()
{
    show2(18.0, f1);
    return 0;
}

```

7. Revise the following short and ugly program so that it uses a lambda expression instead of the `Adder` functor. Don't change `sum()`.

```

#include <iostream>
#include <array>
const int Size = 5;
template<typename T>

```

```

    void sum(std::array<double,Size> a, T& fp);
class Adder
{
    double tot;
public:
    Adder(double q = 0) : tot(q) {}
    void operator()(double w) { tot +=w;}
    double tot_v () const {return tot;};
};
int main()
{
    double total = 0.0;
    Adder ad(total);
    std::array<double, Size> temp_c = {32.1, 34.3, 37.8, 35.2, 34.7};
    sum(temp_c,ad);
    total = ad.tot_v();
    std::cout << "total: " << ad.tot_v() << '\n';
    return 0;
}
template<typename T>
void sum(std::array<double,Size> a, T& fp)
{
    for(auto pt = a.begin(); pt != a.end(); ++pt)
    {
        fp(*pt);
    }
}

```

## Programming Exercises

1. Here is part of a short program:

```

int main()
{
    using namespace std;
    // list of double deduced from list contents
    auto q = average_list({15.4, 10.7, 9.0});
    cout << q << endl;
    // list of int deduced from list contents
    cout << average_list({20, 30, 19, 17, 45, 38} ) << endl;
    // forced list of double
    auto ad = average_list<double>({'A', 70, 65.33});
    cout << ad << endl;
    return 0;
}

```

Complete the program by supplying the `average_list()` function. It should be a template function, with the type parameter being used to specify the kind of `initialized_list` template to be used as the function parameter and also to give the function return type.

2. Here is declaration for the `Cpmv` class:

```
class Cpmv
{
public:
    struct Info
    {
        std::string qcode;
        std::string zcode;
    };
private:
    Info *pi;
public:
    Cpmv();
    Cpmv(std::string q, std::string z);
    Cpmv(const Cpmv & cp);
    Cpmv(Cpmv && mv);
    ~Cpmv();
    Cpmv & operator=(const Cpmv & cp);
    Cpmv & operator=(Cpmv && mv);
    Cpmv operator+(const Cpmv & obj) const;
    void Display() const;
};
```

The `operator+()` function should create an object whose `qcode` and `zcode` members concatenate the corresponding members of the operands. Provide code that implements move semantics for the move constructor and the move assignment operator. Write a program that uses all the methods. For testing purposes, make the various methods verbose so that you can see when they are used.

3. Write and test a variadic template function `sum_values()` that accepts an arbitrarily long list of arguments with numeric values (they can be a mixture of types) and returns the sum as a `long double` value.
4. Redo Listing 16.5 using lambdas. In particular, replace the `outint()` function with a named lambda and replace the two uses of a functor with two anonymous lambda expressions.

*This page intentionally left blank*

# A

## Number Bases

Civilizations have used many systems to represent numbers. Some systems, such as Roman numerals, are ill suited for doing arithmetic. On the other hand, the Hindi number system, modified and transmitted to Europe as the Arabic number system, facilitated calculations for mathematicians, scientists, and merchants. Modern computer number systems are based on the placeholder concept and use of zero that first appeared with the Hindi number system. However, they generalize the principles to other number bases. So although our everyday notation is based on the number 10, as described in the next section, the computing world often uses numbers based on 8 (octal), 16 (hexadecimal), and 2 (binary).

### Decimal Numbers (Base 10)

The method we use for writing numbers is based on powers of 10. For example, consider the number 2,468. The 2 represents 2 thousands, the 4 represents 4 hundreds, the 6 represents 6 tens, and the 8 represents 8 ones:

$$2,468 = 2 \times 1,000 + 4 \times 100 + 6 \times 10 + 8 \times 1$$

One thousand is  $10 \times 10 \times 10$ , which can be written as  $10^3$ , or 10 to the 3rd power. Using this notation, you can write the preceding relationship this way:

$$2,468 = 2 \times 10^3 + 4 \times 10^2 + 6 \times 10^1 + 8 \times 10^0$$

Because this number notation is based on powers of 10, we refer to it as base 10, or decimal, notation. You can also use another number as a base. For example, C++ lets you use base 8 (octal) and base 16 (hexadecimal or hex) notation for writing integer numbers. (Note that  $10^0$  is 1, as is any nonzero number to the zero power.)

### Octal Integers (Base 8)

Octal numbers are based on powers of 8, so base 8 notation uses the digits 0–7 in writing numbers. C++ uses a 0 prefix to indicate octal notation. Thus, 0177 is an octal value. You can use powers of 8 to find the equivalent base 10 value:

| Octal | Decimal                                                                                                |
|-------|--------------------------------------------------------------------------------------------------------|
| 0177  | $= 1 \times 8^2 + 7 \times 8^1 + 7 \times 8^0$<br>$= 1 \times 64 + 7 \times 8 + 7 \times 1$<br>$= 127$ |

Because the Unix operating system often uses octal representation of values, C++ and C provide octal notation.

## Hexadecimal Numbers (Base 16)

Hexadecimal numbers are based on powers of 16. This means that 10 in hexadecimal represents the value  $16 + 0$ , or 16. To represent the values between 9 and hexadecimal 16, you need a few more digits. Standard hexadecimal notation uses the letters a–f for that purpose. C++ accepts either lowercase or uppercase versions of these characters, as shown in Table A.1.

Table A.1 Hexadecimal Digits

| Hexadecimal Digit | Decimal Value |
|-------------------|---------------|
| a or A            | 10            |
| b or B            | 11            |
| c or C            | 12            |
| d or D            | 13            |
| e or E            | 14            |
| f or F            | 15            |

C++ uses 0x or 0X notation to indicate hexadecimal notation. Thus, 0x2B3 is a hexadecimal value. To find the decimal equivalent of 0x2B3, you can evaluate the powers of 16:

| Hexadecimal | Decimal                                                                                                       |
|-------------|---------------------------------------------------------------------------------------------------------------|
| 0x2B3       | $= 2 \times 16^2 + 11 \times 16^1 + 3 \times 16^0$<br>$= 2 \times 256 + 11 \times 16 + 3 \times 1$<br>$= 691$ |

Hardware documentation often uses hexadecimal notation to represent values such as memory locations and port numbers.

## Binary Numbers (Base 2)

Whether you use decimal, octal, or hexadecimal notation for writing an integer, the computer stores it as a binary, or base 2, value. Binary notation uses just two digits, 0 and 1. For example, 100110111 is a binary number. Note, however, that C++ doesn't provide for writing a number in binary notation. Binary numbers are based on powers of 2:

| Binary    | Decimal                                                                                                                                                                           |
|-----------|-----------------------------------------------------------------------------------------------------------------------------------------------------------------------------------|
| 100110111 | $= 1 \times 2^7 + 0 \times 2^6 + 0 \times 2^5 + 1 \times 2^4$<br>$+ 1 \times 2^3 + 0 \times 2^2 + 1 \times 2^1 + 1 \times 2^0$<br>$= 128 + 0 + 0 + 16 + 8 + 0 + 2 + 1$<br>$= 155$ |

Binary notation makes a nice match to computer memory, in which each individual unit, called a *bit*, can be set to off or on. You just identify the off setting with 0 and the on setting with 1. Memory is commonly organized in units called *bytes* or *octets*, with each byte being 8 bits. (As noted in Chapter 2 “Setting Out to C++,” a C++ byte isn't necessarily 8 bits, but this appendix will follow the common practice of using byte to mean octet.) The bits in a byte are numbered corresponding to the associated power of 2. Thus, the rightmost bit is bit number 0, the next bit is bit 1, and so on. For example, Figure A.1 represents a 2-byte integer.

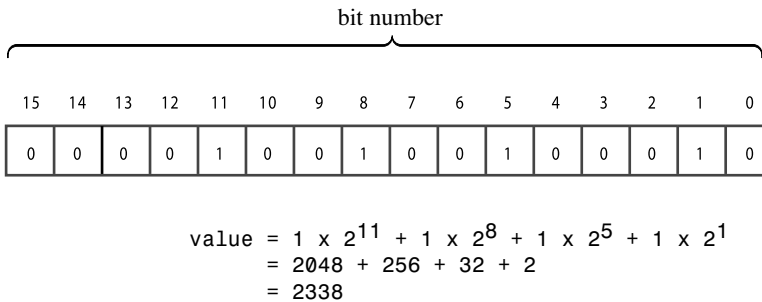

Figure A.1 A 2-byte integer value.

## Binary and Hex

Hex notation is often used to provide a more convenient view of binary data, such as memory addresses or integers holding bit-flag settings. The reason for this is that each hexadecimal digit corresponds to a 4-bit unit. Table A.2 shows this correspondence.



Table A.2 Hexadecimal Digits and Binary Equivalents

| Hexadecimal Digit | Binary Equivalent |
|-------------------|-------------------|
| 0                 | 0000              |
| 1                 | 0001              |
| 2                 | 0010              |
| 3                 | 0011              |
| 4                 | 0100              |
| 5                 | 0101              |
| 6                 | 0110              |
| 7                 | 0111              |
| 8                 | 1000              |
| 9                 | 1001              |
| A                 | 1010              |
| B                 | 1011              |
| C                 | 1100              |
| D                 | 1101              |
| E                 | 1110              |
| F                 | 1111              |

To convert a hex value to binary, you just replace each hex digit with the corresponding binary equivalent. For example, the hex number 0xA4 corresponds to binary 1010 0100. Similarly, you can easily convert binary values to hex notation by converting each 4-bit unit into the equivalent hex digit. For example, the binary value 1001 0101 becomes 0x95.

### Big Endian and Little Endian

Oddly, two computing platforms that both use binary representation of integers might not represent the same number identically. Intel machines, for example, store bytes using the Little Endian architecture, whereas Motorola processors, IBM mainframe computers, SPARC processors, and ARM processors employ the Big Endian scheme. (However, the last two systems can be configured to use either scheme.)

The terms *Big Endian* and *Little Endian* can be thought of as meaning “Big End In” and “Little End In”—a reference to the order of bytes in a word (typically a 2-byte unit) of memory. On an Intel computer (Little Endian), the low-order byte is stored first. This means a hex value such as 0xABCD would be stored in memory as 0xCD 0xAB. A Motorola (Big Endian) machine would store the same value in reverse, so 0xABCD would be stored in memory as 0xAB 0xCD.

Jonathan Swift’s book *Gulliver’s Travels* is the ultimate source for these terms. Swift satirized the irrationality of many political disputes by inventing two contentious political factions in

Lilliput: the Big Endians, who maintained that the proper end to break an egg is the large end, and the Little Endians, who championed breaking the small end of the egg.

You, as a software engineer, should understand the word order of the platform you are targeting. Among other things, it affects the interpretation of data transmitted over a network and how data is stored in binary files. In the preceding example, the 2-byte memory pattern `0xABCD` would represent the decimal value 52,651 on a Little Endian machine and the decimal value 43,981 on a Big Endian machine.

*This page intentionally left blank*

# B

## C++ Reserved Words

**C**++ reserves some words for its own use and for use in C++ libraries. You shouldn't use a reserved word as an identifier in a declaration. Reserved words come in three categories: keywords, alternative tokens, and C++ library reserved names.

### C++ Keywords

*Keywords* are identifiers that form the vocabulary of a programming language. They may not be used for other purposes, such as serving as variable names. Table B.1 shows C++'s keywords. Keywords shown in boldface are also keywords in ANSI C99. Keywords in italics are C++11 additions.

Table B.1 C++ Keywords

|                 |                  |                      |                     |                  |
|-----------------|------------------|----------------------|---------------------|------------------|
| <i>alignas</i>  | <i>alignof</i>   | asm                  | <b>auto</b>         | bool             |
| <b>break</b>    | <b>case</b>      | catch                | <b>char</b>         | <i>char16_t</i>  |
| <i>char32_t</i> | class            | <b>const</b>         | const_cast          | <i>constexpr</i> |
| <b>continue</b> | <i>decltype</i>  | <b>default</b>       | delete              | <b>do</b>        |
| <b>double</b>   | dynamic_cast     | <b>else</b>          | <b>enum</b>         | explicit         |
| export          | <b>extern</b>    | false                | <b>float</b>        | <b>for</b>       |
| friend          | <b>goto</b>      | <b>if</b>            | <b>inline</b>       | <b>int</b>       |
| <b>long</b>     | mutable          | namespace            | new                 | <i>noexcept</i>  |
| <i>nullptr</i>  | operator         | private              | protected           | public           |
| <b>register</b> | reinterpret_cast | <b>return</b>        | <b>short</b>        | <b>signed</b>    |
| <b>sizeof</b>   | <b>static</b>    | <i>static_assert</i> | static_cast         | <b>struct</b>    |
| <b>switch</b>   | template         | this                 | <i>thread_local</i> | throw            |
| true            | try              | <b>typedef</b>       | typeid              | typename         |
| <b>union</b>    | <b>unsigned</b>  | using                | virtual             | <b>void</b>      |
| <b>volatile</b> | wchar_t          | <b>while</b>         |                     |                  |

## Alternative Tokens

In addition to keywords, C++ has some alphabetic alternative representations of operators, termed *alternative tokens*. These, too, are reserved. Table B.2 lists the alphabetic alternative tokens and the operators they represent.

Table B.2 C++ Reserved Alternative Tokens and Their Meanings

| Token  | Meaning |
|--------|---------|
| and    | &&      |
| and_eq | &=      |
| bitand | &       |
| bitor  |         |
| compl  | ~       |
| not    | !       |
| not_eq | !=      |
| or     |         |
| or_eq  | =       |
| xor    | ^       |
| xor_eq | ^=      |

## C++ Library Reserved Names

The compiler won't let you use keywords and alternative tokens as names. There's another class of forbidden names for which the protection is not as absolute—*reserved names*, which are names reserved for use by the C++ library. If you use one of these as an identifier, the effect is undefined. That is, it might generate a compiler error, it might generate a warning, it might cause a program to run incorrectly, or it might cause no problems at all.

The C++ language reserves macro names used in a library header file. If a program includes a particular header file, then you shouldn't use the names of macros defined in that header (or in headers included by that header file, and so on) for other purposes. For example, if you include the header file `<climits>` directly or indirectly, you shouldn't use `CHAR_BIT` as an identifier because that name is already used as a macro in that header file.

The C++ language reserves names beginning with two underscores or a single underscore followed by an uppercase letter for any use, and it reserves names beginning with a single underscore for use as a global variable. So don't create names such as `__gink` or `__Lynx` in any case and names such as `_lynx` in the global namespace.

The C++ language reserves names declared with external linkage in library header files. For functions, this includes the function signature (name and parameter list). For example, suppose you have this code:

```
#include <cmath>
using namespace std;
```

In this case, the function signature `tan(double)` is reserved. That means your program should not declare a function that has this prototype:

```
int tan(double); // don't do it
```

This doesn't match the library `tan()` prototype, which returns type `double`, but it does match the signature portion. However, it would be okay to have the following prototype:

```
char * tan(char *); // ok
```

That's because even though it matches the `tan()` identifier, it doesn't match the signature.

## Identifiers With Special Meaning

The C++ community is loath to add new keywords because they could conflict with existing code. That is why the standards committee has, for example, repurposed the `auto` keyword and provided more than one use for others, such as `virtual` and `delete`. C++11 has implemented another way to avoid adding keywords, and that is to use identifiers with special meanings. These identifiers, `override` and `final`, are not keywords, but they are used to implement language features. The compiler uses the context to determine whether they are used as ordinary identifiers or as language features:

```
class F
{
    int final; // #1
public:
    ...
    virtual void unfold() {...} = final; // #2
};
```

Here the `final` on line #1 is used as an ordinary identifier, and the `final` on line #2 is used to invoke a language feature. The two uses do not conflict with one another.

Also C++ has many identifiers that commonly appear in programs but that are not reserved. These include header file names, library function names, and `main`, the name of the required function with which execution begins. As long as you avoid namespace conflicts, you can use these identifiers for other purposes, although there is no reason to do so. That is, nothing except a lack of common sense prevents code like the following:

```
// allowable but silly
#include <iostream>
int iostream(int a);
```

```
int main ()
{
    std::
cout << ostream(5) << '\n';

    return 0;
}

int ostream(int a)
{
    int main = a + 1;
    int cout = a -1;
    return main*cout;
}
```

## C

# The ASCII Character Set

Computers store characters by using numeric codes. The ASCII (American Standard Code for Information Interchange) code is the most commonly used code in the United States. It's also a subset (a very small subset) of Unicode. C++ lets you represent most single characters directly by including the character in single quotation marks, as in 'A' for the A character. You can also represent a single character by using the octal or hex code preceded by a backslash; for example, '\012' and '\0xa' both represent the linefeed (LF) character. Such escape sequences can also be part of a string, as in "Hello, \012my dear".

Table C.1 shows the ASCII character set in various representations. When used as a prefix in the table, the ^ character denotes using the Ctrl key.

Table C.1 **ASCII Character Set Representations**

| Decimal | Octal | Hex | Binary   | Character | ASCII Name |
|---------|-------|-----|----------|-----------|------------|
| 0       | 0     | 0   | 00000000 | ^@        | NUL        |
| 1       | 01    | 0x1 | 00000001 | ^A        | SOH        |
| 2       | 02    | 0x2 | 00000010 | ^B        | STX        |
| 3       | 03    | 0x3 | 00000011 | ^C        | ETX        |
| 4       | 04    | 0x4 | 00000100 | ^D        | EOT        |
| 5       | 05    | 0x5 | 00000101 | ^E        | ENQ        |
| 6       | 06    | 0x6 | 00000110 | ^F        | ACK        |
| 7       | 07    | 0x7 | 00000111 | ^G        | BEL        |
| 8       | 010   | 0x8 | 00001000 | ^H        | BS         |
| 9       | 011   | 0x9 | 00001001 | ^I, Tab   | HT         |
| 10      | 012   | 0xa | 00001010 | ^J        | LF         |
| 11      | 013   | 0xb | 00001011 | ^K        | VT         |
| 12      | 014   | 0xc | 00001100 | ^L        | FF         |
| 13      | 015   | 0xd | 00001101 | ^M        | CR         |



Table C.1 ASCII Character Set Representations

| Decimal | Octal | Hex  | Binary   | Character | ASCII Name |
|---------|-------|------|----------|-----------|------------|
| 14      | 016   | 0xe  | 00001110 | ^N        | SO         |
| 15      | 017   | 0xf  | 00001111 | ^O        | SI         |
| 16      | 020   | 0x10 | 00010000 | ^P        | DLE        |
| 17      | 021   | 0x11 | 00010001 | ^Q        | DC1        |
| 18      | 022   | 0x12 | 00010010 | ^R        | DC2        |
| 19      | 023   | 0x13 | 00010011 | ^S        | DC3        |
| 20      | 024   | 0x14 | 00010100 | ^T        | DC4        |
| 21      | 025   | 0x15 | 00010101 | ^U        | NAK        |
| 22      | 026   | 0x16 | 00010110 | ^V        | SYN        |
| 23      | 027   | 0x17 | 00010111 | ^W        | ETB        |
| 24      | 030   | 0x18 | 00011000 | ^X        | CAN        |
| 25      | 031   | 0x19 | 00011001 | ^Y        | EM         |
| 26      | 032   | 0x1a | 00011010 | ^Z        | SUB        |
| 27      | 033   | 0x1b | 00011011 | ^[, Esc   | ESC        |
| 28      | 034   | 0x1c | 00011100 | ^\<br>^_  | FS         |
| 29      | 035   | 0x1d | 00011101 | ^]        | GS         |
| 30      | 036   | 0x1e | 00011110 | ^^        | RS         |
| 31      | 037   | 0x1f | 00011111 | ^_        | US         |
| 32      | 040   | 0x20 | 00100000 | Spacebar  | SP         |
| 33      | 041   | 0x21 | 00100001 | !         |            |
| 34      | 042   | 0x22 | 00100010 | "         |            |
| 35      | 043   | 0x23 | 00100011 | #         |            |
| 36      | 044   | 0x24 | 00100100 | \$        |            |
| 37      | 045   | 0x25 | 00100101 | %         |            |
| 38      | 046   | 0x26 | 00100110 | &         |            |
| 39      | 047   | 0x27 | 00100111 | '         |            |
| 40      | 050   | 0x28 | 00101000 | (         |            |
| 41      | 051   | 0x29 | 00101001 | )         |            |
| 42      | 052   | 0x2a | 00101010 | *         |            |
| 43      | 053   | 0x2b | 00101011 | +         |            |
| 44      | 054   | 0x2c | 00101100 | ,         |            |
| 45      | 055   | 0x2d | 00101101 | -         |            |
| 46      | 056   | 0x2e | 00101110 | .         |            |

Table C.1 ASCII Character Set Representations

| Decimal | Octal | Hex  | Binary   | Character | ASCII Name |
|---------|-------|------|----------|-----------|------------|
| 47      | 057   | 0x2f | 00101111 | /         |            |
| 48      | 060   | 0x30 | 00110000 | 0         |            |
| 49      | 061   | 0x31 | 00110001 | 1         |            |
| 50      | 062   | 0x32 | 00110010 | 2         |            |
| 51      | 063   | 0x33 | 00110011 | 3         |            |
| 52      | 064   | 0x34 | 00110100 | 4         |            |
| 53      | 065   | 0x35 | 00110101 | 5         |            |
| 54      | 066   | 0x36 | 00110110 | 6         |            |
| 55      | 067   | 0x37 | 00110111 | 7         |            |
| 56      | 070   | 0x38 | 00111000 | 8         |            |
| 57      | 071   | 0x39 | 00111001 | 9         |            |
| 58      | 072   | 0x3a | 00111010 | :         |            |
| 59      | 073   | 0x3b | 00111011 | ;         |            |
| 60      | 074   | 0x3c | 00111100 | <         |            |
| 61      | 075   | 0x3d | 00111101 | =         |            |
| 62      | 076   | 0x3e | 00111110 | >         |            |
| 63      | 077   | 0x3f | 00111111 | ?         |            |
| 64      | 0100  | 0x40 | 01000000 | @         |            |
| 65      | 0101  | 0x41 | 01000001 | A         |            |
| 66      | 0102  | 0x42 | 01000010 | B         |            |
| 67      | 0103  | 0x43 | 01000011 | C         |            |
| 68      | 0104  | 0x44 | 01000100 | D         |            |
| 69      | 0105  | 0x45 | 01000101 | E         |            |
| 70      | 0106  | 0x46 | 01000110 | F         |            |
| 71      | 0107  | 0x47 | 01000111 | G         |            |
| 72      | 0110  | 0x48 | 01001000 | H         |            |
| 73      | 0111  | 0x49 | 01001001 | I         |            |
| 74      | 0112  | 0x4a | 01001010 | J         |            |
| 75      | 0113  | 0x4b | 01001011 | K         |            |
| 76      | 0114  | 0x4c | 01001100 | L         |            |
| 77      | 0115  | 0x4d | 01001101 | M         |            |
| 78      | 0116  | 0x4e | 01001110 | N         |            |
| 79      | 0117  | 0x4f | 01001111 | O         |            |

Table C.1 ASCII Character Set Representations

| Decimal | Octal | Hex  | Binary   | Character | ASCII Name |
|---------|-------|------|----------|-----------|------------|
| 80      | 0120  | 0x50 | 01010000 | P         |            |
| 81      | 0121  | 0x51 | 01010001 | Q         |            |
| 82      | 0122  | 0x52 | 01010010 | R         |            |
| 83      | 0123  | 0x53 | 01010011 | S         |            |
| 84      | 0124  | 0x54 | 01010100 | T         |            |
| 85      | 0125  | 0x55 | 01010101 | U         |            |
| 86      | 0126  | 0x56 | 01010110 | V         |            |
| 87      | 0127  | 0x57 | 01010111 | W         |            |
| 88      | 0130  | 0x58 | 01011000 | X         |            |
| 89      | 0131  | 0x59 | 01011001 | Y         |            |
| 90      | 0132  | 0x5a | 01011010 | Z         |            |
| 91      | 0133  | 0x5b | 01011011 | [         |            |
| 92      | 0134  | 0x5c | 01011100 | \         |            |
| 93      | 0135  | 0x5d | 01011101 | ]         |            |
| 94      | 0136  | 0x5e | 01011110 | ^         |            |
| 95      | 0137  | 0x5f | 01011111 | _         |            |
| 96      | 0140  | 0x60 | 01100000 | '         |            |
| 97      | 0141  | 0x61 | 01100001 | a         |            |
| 98      | 0142  | 0x62 | 01100010 | b         |            |
| 99      | 0143  | 0x63 | 01100011 | c         |            |
| 100     | 0144  | 0x64 | 01100100 | d         |            |
| 101     | 0145  | 0x65 | 01100101 | e         |            |
| 102     | 0146  | 0x66 | 01100110 | f         |            |
| 103     | 0147  | 0x67 | 01100111 | g         |            |
| 104     | 0150  | 0x68 | 01101000 | h         |            |
| 105     | 0151  | 0x69 | 01101001 | i         |            |
| 106     | 0152  | 0x6a | 01101010 | j         |            |
| 107     | 0153  | 0x6b | 01101011 | k         |            |
| 108     | 0154  | 0x6c | 01101100 | l         |            |
| 109     | 0155  | 0x6d | 01101101 | m         |            |
| 110     | 0156  | 0x6e | 01101110 | n         |            |
| 111     | 0157  | 0x6f | 01101111 | o         |            |
| 112     | 0160  | 0x70 | 01110000 | p         |            |

Table C.1 ASCII Character Set Representations

| Decimal | Octal | Hex  | Binary   | Character | ASCII Name |
|---------|-------|------|----------|-----------|------------|
| 113     | 0161  | 0x71 | 01110001 | q         |            |
| 114     | 0162  | 0x72 | 01110010 | r         |            |
| 115     | 0163  | 0x73 | 01110011 | s         |            |
| 116     | 0164  | 0x74 | 01110100 | t         |            |
| 117     | 0165  | 0x75 | 01110101 | u         |            |
| 118     | 0166  | 0x76 | 01110110 | v         |            |
| 119     | 0167  | 0x77 | 01110111 | w         |            |
| 120     | 0170  | 0x78 | 01111000 | x         |            |
| 121     | 0171  | 0x79 | 01111001 | y         |            |
| 122     | 0172  | 0x7a | 01111010 | z         |            |
| 123     | 0173  | 0x7b | 01111011 | {         |            |
| 124     | 0174  | 0x7c | 01111100 |           |            |
| 125     | 0175  | 0x7d | 01111101 | }         |            |
| 126     | 0176  | 0x7e | 01111110 | ~         |            |
| 127     | 0177  | 0x7f | 01111111 | Del       |            |

*This page intentionally left blank*

# Operator Precedence

Operator precedence determines the order in which operators are applied to a value. C++ operators come in 18 precedence groups, which are presented in Table D.1. Those in Group 1 have the highest precedence, those in Group 2 have the next-highest precedence, and so on. If two operators apply to the same operand (something on which an operator operates), the operator with the higher precedence applies first. If the two operators have the same precedence, C++ uses associativity rules to determine which operator binds more tightly. All operators in the same group have the same precedence and the same associativity, which is either left-to-right (L–R in the table) or right-to-left (R–L in the table). Left-to-right associativity means to apply the leftmost operator first, and right-to-left associativity means to apply the rightmost operator first.

Table D.1 C++ Operator Precedence and Associativity

| Operator                  | Assoc. | Meaning                                              |
|---------------------------|--------|------------------------------------------------------|
| <i>Precedence Group 1</i> |        |                                                      |
| ::                        |        | Scope resolution operator                            |
| <i>Precedence Group 2</i> |        |                                                      |
| (expression)              |        | Grouping                                             |
| ()                        | L–R    | Function call                                        |
| ()                        |        | Value construction—that is, <code>type (expr)</code> |
| []                        |        | Array subscript                                      |
| .                         |        | Direct membership operator                           |
| ->                        |        | Indirect membership operator                         |
| ++                        |        | Increment operator, postfix                          |
| --                        |        | Decrement operator, postfix                          |
| const_cast                |        | Specialized type cast                                |
| dynamic_cast              |        | Specialized type cast                                |
| reinterpret_cast          |        | Specialized type cast                                |
| static_cast               |        | Specialized type cast                                |
| typeid                    |        | Type identification                                  |

Table D.1 C++ Operator Precedence and Associativity

| Operator                               | Assoc. | Meaning                                   |
|----------------------------------------|--------|-------------------------------------------|
| <i>Precedence Group 3 (All Unary)</i>  |        |                                           |
| !                                      | R-L    | Logical negation                          |
| ~                                      |        | Bitwise negation                          |
| +                                      |        | Unary plus (positive sign)                |
| -                                      |        | Unary minus (negative sign)               |
| ++                                     |        | Increment operator, prefix                |
| --                                     |        | Decrement operator, prefix                |
| &                                      |        | Address                                   |
| *                                      |        | Dereference (indirect value)              |
| ()                                     |        | Type cast—that is, (type) expr            |
| sizeof                                 |        | Size in bytes                             |
| alignof                                |        | Alignment requirement                     |
| new                                    |        | Dynamically allocate storage              |
| new []                                 |        | Dynamically allocate array                |
| delete                                 |        | Dynamically free storage                  |
| delete []                              |        | Dynamically free array                    |
| noexcept                               |        | False if operand might throw an exception |
| <i>Precedence Group 4</i>              |        |                                           |
| .*                                     | L-R    | Member dereference                        |
| ->*                                    |        | Indirect member dereference               |
| <i>Precedence Group 5 (All Binary)</i> |        |                                           |
| *                                      | L-R    | Multiply                                  |
| /                                      |        | Divide                                    |
| %                                      |        | Modulus (remainder)                       |
| <i>Precedence Group 6 (All Binary)</i> |        |                                           |
| +                                      | L-R    | Addition                                  |
| -                                      |        | Subtraction                               |
| <i>Precedence Group 7</i>              |        |                                           |
| <<                                     | L-R    | Left shift                                |
| >>                                     |        | Right shift                               |
| <i>Precedence Group 8</i>              |        |                                           |
| <                                      | L-R    | Less than                                 |
| <=                                     |        | Less than or equal to                     |
| >=                                     |        | Greater than or equal to                  |
| >                                      |        | Greater than                              |

Table D.1 C++ Operator Precedence and Associativity

| Operator                            | Assoc. | Meaning                          |
|-------------------------------------|--------|----------------------------------|
| <i>Precedence Group 9</i>           |        |                                  |
| ==                                  | L-R    | Equal to                         |
| !=                                  |        | Not equal to                     |
| <i>Precedence Group 10 (Binary)</i> |        |                                  |
| &                                   | L-R    | Bitwise AND                      |
| <i>Precedence Group 11</i>          |        |                                  |
| ^                                   | L-R    | Bitwise XOR (exclusive OR)       |
| <i>Precedence Group 12</i>          |        |                                  |
|                                     | L-R    | Bitwise OR                       |
| <i>Precedence Group 13</i>          |        |                                  |
| &&                                  | L-R    | Logical AND                      |
| <i>Precedence Group 14</i>          |        |                                  |
|                                     | L-R    | Logical OR                       |
| <i>Precedence Group 15</i>          |        |                                  |
| : ?                                 | R-L    | Conditional                      |
| <i>Precedence Group 16</i>          |        |                                  |
| =                                   | R-L    | Simple assignment                |
| *=                                  |        | Multiply and assign              |
| /=                                  |        | Divide and assign                |
| %=                                  |        | Take remainder and assign        |
| +=                                  |        | Add and assign                   |
| -=                                  |        | Subtract and assign              |
| &=                                  |        | Bitwise AND and assign           |
| ^=                                  |        | Bitwise XOR and assign           |
| =                                   |        | Bitwise OR and assign            |
| <<=                                 |        | Left shift and assign            |
| >>=                                 |        | Right shift and assign           |
| <i>Precedence Group 17</i>          |        |                                  |
| throw                               | L-R    | Throw exception                  |
| <i>Precedence Group 18</i>          |        |                                  |
| ,                                   | L-R    | Combine two expressions into one |



Some symbols, such as `*` and `&`, are used for more than one operator. In such cases, one form is *unary* (one operand), and the other form is *binary* (two operands), and the compiler uses the context to determine which is meant. Table D.1 labels operator groups unary or binary for those cases in which the same symbol is used two ways.

The following are some examples of precedence and associativity.

Here's an example in which the compiler has to decide whether to add 5 to 3 or multiply 5 by 6:

```
3 + 5 * 6
```

The `*` operator has higher precedence than the `+` operator, so it is applied to the 5 first, making the expression `3 + 30`, or 33.

Here's an example in which the compiler has to decide whether to divide 6 into 120 or multiply 6 by 5:

```
120 / 6 * 5
```

Both `/` and `*` have the same precedence, but these operators associate from left to right. That means the operator to the left of the shared operand (6) is applied first, so the expression becomes `20 * 5`, or 100.

Here's an example in which the compiler has to decide whether to begin by incrementing `str` or by dereferencing `str`:

```
char * str = "Whoa";
char ch = *str++;
```

The postfix `++` operator has higher precedence than the unary `*` operator. This means the increment operator operates on `str` and not `*str`. That is, the operation increments the pointer, making it point to the next character, rather than altering the character pointed to. However, because `++` is the postfix form, the pointer is incremented after the original value of `*str` is assigned to `ch`. Therefore, this expression assigns the character `w` to `ch` and then moves `str` to point to the `h` character.

Here's a similar example:

```
char * str = "Whoa";
char ch = *++str;
```

The prefix `++` operator and the unary `*` operator have the same precedence, but they associate right-to-left. So, again, `str` and not `*str` is incremented. Because the `++` operator is in prefix form, first `str` is incremented, and then the resulting pointer is dereferenced. Thus, `str` moves to point to the `h` character, and the `h` character is assigned to `ch`.

Note that Table D.1 uses *binary* or *unary* in the "Precedence" column to distinguish between two operators that use the same symbol, such as the unary address operator and the binary bitwise AND operator.

Appendix B, "C++ Reserved words," lists alternative representations for some of the operators.

# Other Operators

To avoid terminal obesity, the main text of this book doesn't cover three groups of operators. The first group consists of the bitwise operators, which let you manipulate individual bits in a value; these operators were inherited from C. The second group consists of two-member dereferencing operators; they are C++ additions. The third group includes operators added by C++11: `alignof` and `noexcept`. This appendix briefly summarizes these operators.

## Bitwise Operators

The bitwise operators operate on the bits of integer values. For example, the left-shift operator moves bits to the left, and the bitwise negation operator turns each 1 to a 0 and each 0 to a 1. Altogether, C++ has six such operators: `<<`, `>>`, `~`, `&`, `|`, and `^`.

### The Shift Operators

The left-shift operator has the following syntax:

```
value << shift
```

Here *value* is the integer value to be shifted, and *shift* is the number of bits to shift. For example, the following shifts all the bits in the value 13 three places to the left:

```
13 << 3
```

The vacated places are filled with zeros, and bits shifted past the end are discarded (see Figure E.1).

Because each bit position represents a value twice that of the bit to the right (see Appendix A, "Number Bases"), shifting one bit position is equivalent to multiplying the value by 2. Similarly, shifting two bit positions is equivalent to multiplying by  $2^2$ , and shifting *n* positions is equivalent to multiplying by  $2^n$ . Thus, the value of `13 << 3` is  $13 \times 2^3$ , or 104.

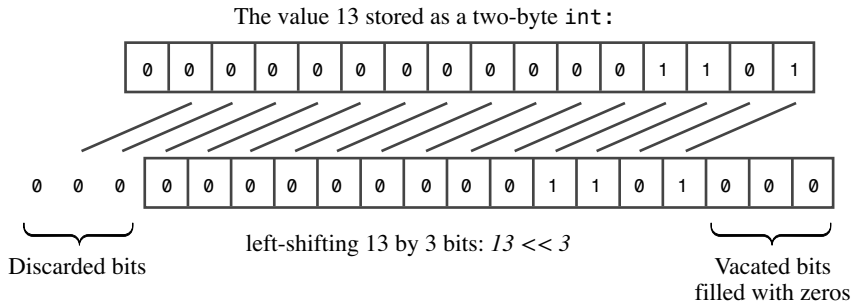

Figure E.1 The left-shift operator.

The left-shift operator provides a capability often found in assembly languages. However, an assembly language left-shift operator directly alters the contents of a register, whereas the C++ left-shift operator produces a new value without altering existing values. For example, consider the following:

```
int x = 20;
int y = x << 3;
```

This code doesn't change the value of `x`. The expression `x << 3` uses the value of `x` to produce a new value, much as `x + 3` produces a new value without altering `x`.

If you want to use the left-shift operator to change the value of a variable, you must also use assignment. You can use regular assignment or the `<<=` operator, which combines shifting with assignment:

```
x = x << 4;           // regular assignment
y <<= 2;             // shift and assign
```

The right-shift operator (`>>`), as you might expect, shifts bits to the right. It has the following syntax:

```
value >> shift
```

Here *value* is the integer value to be shifted, and *shift* is the number of bits to shift. For example, the following shifts all the bits in the value 17 two places to the right:

```
17 >> 2
```

For unsigned integers, the vacated places are filled with zeros, and bits shifted past the end are discarded. For signed integers, vacated places may be filled with zeros or else with the value of the original leftmost bit. The choice depends on the C++ implementation. (Figure E.2 shows an example that illustrates filling with zeros.)

The right-shift operator. Shifting one place to the right is equivalent to integer division by 2. In general, shifting *n* places to the right is equivalent to integer division by  $2^n$ .

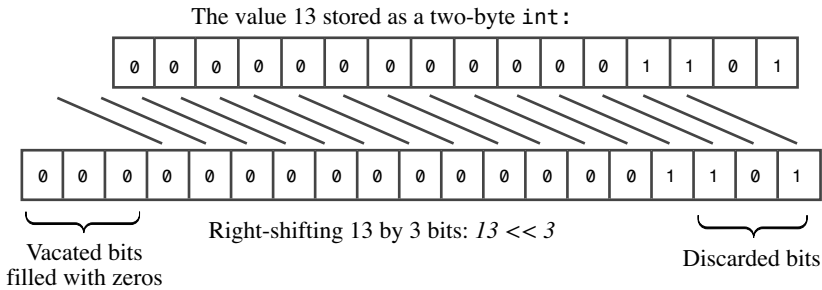

Figure E.2 The right-shift operator.

C++ also defines a right-shift-and-assign operator that you can use to replace the value of a variable by the shifted value:

```
int q = 43;
q >>= 2;           // replace 43 by 43 >> 2, or 10
```

On some systems, using left- and right-shift operators may produce faster integer multiplication and division by 2 than using the division operator, but as compilers get better at optimizing code, such differences are fading.

## The Logical Bitwise Operators

The logical bitwise operators are analogous to the regular logical operators, except they apply to a value on a bit-by-bit basis rather than to the whole. For example, consider the regular negation operator (!) and the bitwise negation (or complement) operator (~). The ! operator converts a *true* (or nonzero) value to *false* and a *false* value to *true*. The ~ operator converts each individual bit to its opposite (1 to 0 and 0 to 1). For example, consider the `unsigned char` value of 3:

```
unsigned char x = 3;
```

The expression `!x` has the value 0. To see the value of `~x`, you write it in binary form: 00000011. Then you convert each 0 to 1 and each 1 to 0. This produces the value 11111100, which in base 10 is the value 252. (Figure E.3 shows a 16-bit example.) The new value is termed the *complement* of the original value.

The bitwise OR operator (|) combines two integer values to produce a new integer value. Each bit in the new value is set to 1 if one or the other, or both, of the corresponding bits in the original values is set to 1. If both corresponding bits are 0, then the final bit is set to 0 (see Figure E.4).

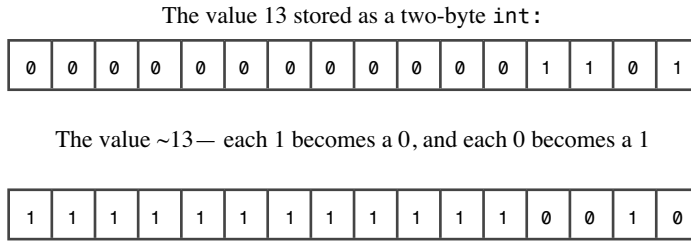

Figure E.3 The bitwise negation operator.

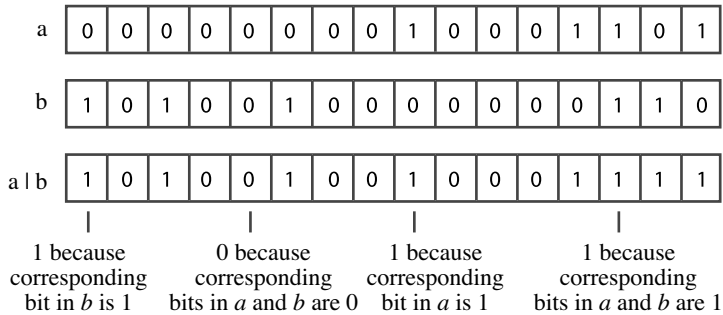

Figure E.4 The bitwise OR operator.

Table E.1 summarizes how the | operator combines bits.

Table E.1 The Value of *b1* | *b2*

| Bit Values | b1 = 0 | b1 = 1 |
|------------|--------|--------|
| b2 = 0     | 0      | 1      |
| b2 = 1     | 1      | 1      |

The |= operator combines the bitwise OR operator with assignment:

```
a |= b; // set a to a | b
```

The bitwise XOR operator (^) combines two integer values to produce a new integer value. Each bit in the new value is set to 1 if one or the other, but not both, of the corresponding bits in the original values is set to 1. If both corresponding bits are 0 or both are 1, the final bit is set to 0 (see Figure E.5).

Table E.2 summarizes how the ^ operator combines bits.

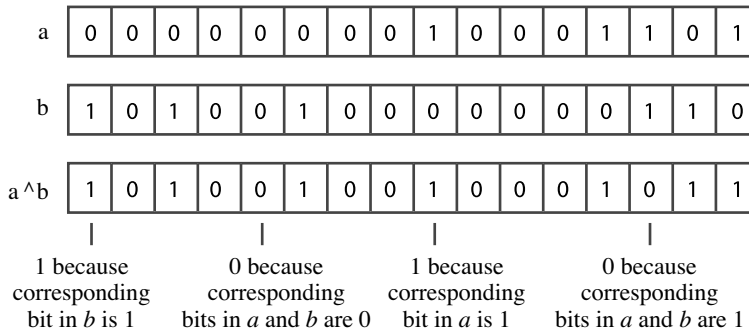

Figure E.5 The bitwise XOR operator.

Table E.2 The Value of  $b1 \wedge b2$

| Bit Values | b1 = 0 | b1 = 1 |
|------------|--------|--------|
| b2 = 0     | 0      | 1      |
| b2 = 1     | 1      | 0      |

The  $\wedge$ = operator combines the bitwise XOR operator with assignment:

```
a ^= b; // set a to a ^ b
```

The bitwise AND operator ( $\&$ ) combines two integer values to produce a new integer value. Each bit in the new value is set to 1 only if both of the corresponding bits in the original values are set to 1. If either or both corresponding bits are 0, the final bit is set to 0 (see Figure E.6).

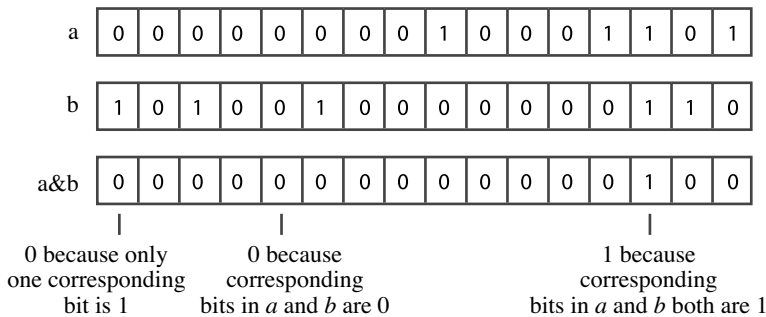

Figure E.6 The bitwise AND operator.

Table E.3 summarizes how the `&` operator combines bits.

Table E.3 The Value of `b1 & b2`

| Bit Values | b1 = 0 | b1 = 1 |
|------------|--------|--------|
| b2 = 0     | 0      | 0      |
| b2 = 1     | 0      | 1      |

The `&=` operator combines the bitwise AND operator with assignment:

```
a &= b; // set a to a & b
```

## Alternative Representations of Bitwise Operators

C++ provides alternative representations of several bitwise operators, as shown in Table E.4. They are provided for locales that do not have the traditional bitwise operators as part of their character sets.

Table E.4 Bitwise Operator Representations

| Standard Representation | Alternative Representation |
|-------------------------|----------------------------|
| <code>&amp;</code>      | <code>bitand</code>        |
| <code>&amp;=</code>     | <code>and_eq</code>        |
| <code> </code>          | <code>bitor</code>         |
| <code> =</code>         | <code>or_eq</code>         |
| <code>~</code>          | <code>compl</code>         |
| <code>^</code>          | <code>xor</code>           |
| <code>^=</code>         | <code>xor_eq</code>        |

These alternative forms let you write statements like the following:

```
b = compl a bitand b; // same as b = ~a & b;
c = a xor b;          // same as c = a ^ b;
```

## A Few Common Bitwise Operator Techniques

Often controlling hardware involves turning particular bits on or off or checking their status. The bitwise operators provide the means to perform such actions. We'll go through the methods quickly.

In the following examples, `lottabits` represents a general value, and `bit` represents the value corresponding to a particular bit. Bits are numbered from right to left, beginning with bit 0, so the value corresponding to bit position  $n$  is  $2^n$ . For example, an integer

with only bit number 3 set to 1 has the value  $2^3$  or 8. In general, each individual bit corresponds to a power of 2, as described for binary numbers in Appendix A. So we'll use the term *bit* to represent a power of 2; this corresponds to a particular bit being set to 1 and all other bits being set to 0.

### Turning a Bit On

The following two operations each turn on the bit in `lottabits` that corresponds to the bit represented by `bit`:

```
lottabits = lottabits | bit;
lottabits |= bit;
```

Each sets the corresponding bit to 1, regardless of the former value of the bit. That's because ORing 1 with either 0 or 1 produces 1. All other bits in `lottabits` remain unaltered. That's because ORing 0 with 0 produces 0, and ORing 0 with 1 produces 1.

### Toggling a Bit

The following two operations each toggle the bit in `lottabits` that corresponds to the bit represented by `bit`. That is, they turn the bit on if it is off, and they turn it off if it is on:

```
lottabits = lottabits ^ bit;
lottabits ^= bit;
```

XORing 1 with 0 produces 1, turning an off bit on, and XORing 1 with 1 produces 0, turning an on bit off. All other bits in `lottabits` remain unaltered. That's because XORing 0 with 0 produces 0, and XORing 0 with 1 produces 1.

### Turning a Bit Off

The following operation turns off the bit in `lottabits` that corresponds to the bit represented by `bit`:

```
lottabits = lottabits & ~bit;
```

These statements turn the bit off, regardless of its prior state. First, the operator `~bit` produces an integer with all its bits set to 1 *except* the bit that originally was set to 1; that bit becomes 0. ANDing a 0 with any bit results in 0, thus turning that bit off. All other bits in `lottabits` are unchanged. That's because ANDing a 1 with any bit produces the value that bit had before.

Here's a briefer way of doing the same thing:

```
lottabits &= ~bit;
```

### Testing a Bit Value

Suppose you want to determine whether the bit corresponding to `bit` is set to 1 in `lottabits`. The following test does not necessarily work:

```
if (lottabits == bit)           // no good
```



That's because even if the corresponding bit in `lottabits` is set to 1, other bits might also be set to 1. The equality above is true *only* when the corresponding bit is 1. The fix is to first AND `lottabits` with `bit`. This produces a value that is 0 in all the other bit positions because 0 AND any value is 0. Only the bit corresponding to the bit value is left unchanged because 1 AND any value is that value. Thus the proper test is this:

```
if (lottabits & bit == bit)        // testing a bit
```

Real-world programmers often simplify this test to the following:

```
if (lottabits & bit)              // testing a bit
```

Because `bit` consists of one bit set to 1 and the rest set to 0, the value of `lottabits & bit` is either 0 (which tests as `false`) or `bit`, which, being nonzero, tests as `true`.

## Member Dereferencing Operators

C++ lets you define pointers to members of a class. These pointers involve special notations to declare them and to dereference them. To see what's involved, let's start with a sample class:

```
class Example
{
private:
    int feet;
    int inches;
public:
    Example();
    Example(int ft);
    ~Example();
    void show_in() const;
    void show_ft() const;
    void use_ptr() const;
};
```

Consider the `inches` member. Without a specific object, `inches` is a label. That is, the class defines `inches` as a member identifier, but you need an object before you actually have memory allocated:

```
Example ob; // now ob.inches exists
```

Thus, you specify an actual memory location by using the identifier `inches` in conjunction with a specific object. (In a member function, you can omit the name of the object, but then the object is understood to be the one pointed to by the pointer.)

C++ lets you define a member pointer to the identifier `inches` like this:

```
int Example::*pt = &Example::inches;
```

This pointer is a bit different from a regular pointer. A regular pointer points to a specific memory location. But the `pt` pointer doesn't point to a specific memory location

because the declaration doesn't identify a specific object. Instead, the pointer `pt` identifies the location of `inches` member within any `Example` object. Like the identifier `inches`, `pt` is designed to be used in conjunction with an object identifier. In essence, the expression `*pt` assumes the role of the identifier `inches`. Therefore, you can use an object identifier to specify which object to access and the `pt` pointer to specify the `inches` member of that object. For example, a class method could use this code:

```
int Example::*pt = &Example::inches;
Example ob1;
Example ob2;
Example *pq = new Example;
cout << ob1.*pt << endl; // display inches member of ob1
cout << ob2.*pt << endl; // display inches member of ob2
cout << po->*pt << endl; // display inches member of *po
```

Here `.*` and `->*` are *member dereferencing operators*. When you have a particular object, such as `ob1`, then `ob1.*pt` identifies the `inches` member of the `ob1` object. Similarly, `pq->*pt` identifies the `inches` member of an object pointed to by `pq`.

Changing the object in the preceding example changes which `inches` member is used. But you can also change the `pt` pointer itself. Because `feet` is of the same type as `inches`, you can reset `pt` to point to the `feet` member instead of the `inches` member; then `ob1.*pt` will refer to the `feet` member of `ob1`:

```
pt = &Example::feet; // reset pt
cout << ob1.*pt << endl; // display feet member of ob1
```

In essence, the combination `*pt` takes the place of a member name and can be used to identify different member names (of the same type).

You can also use member pointers to identify member functions. The syntax for this is relatively involved. Recall that declaring a pointer to an ordinary type `void` function with no arguments looks like this:

```
void (*pf)(); // pf points to a function
```

Declaring a pointer to a member function has to indicate that the function belongs to a particular class. Here, for instance, is how to declare a pointer to an `Example` class method:

```
void (Example::*pf)() const; // pf points to an Example member function
```

This indicates that `pf` can be used the same places that `Example` method can be used. Note that the term `Example::*pf` has to be in parentheses. You can assign the address of a particular member function to this pointer:

```
pf = &Example::show_inches;
```

Note that unlike in the case of ordinary function pointer assignment, here you can and must use the address operator. Having made this assignment, you can then use an object to invoke the member function:

```
Example ob3(20);
(ob3.*pf)(); // invoke show_inches() using the ob3 object
```

You need to enclose the entire `ob3.*pf` construction in parentheses in order to clearly identify the expression as representing a function name.

Because `show_feet()` has the same prototype form as `show_inches()`, you can use `pf` to access the `show_feet()` method, too:

```
pf = &Example::show_feet;
(ob3.*pf)();    // apply show_feet() to the ob3 object
```

The class definition presented in Listing E.1 has a `use_ptr()` method that uses member pointers to access both data members and function members of the `Example` class.

#### Listing E.1 `memb_pt.cpp`

---

```
// memb_pt.cpp -- dereferencing pointers to class members
#include <iostream>
using namespace std;

class Example
{
private:
    int feet;
    int inches;
public:
    Example();
    Example(int ft);
    ~Example();
    void show_in() const;
    void show_ft() const;
    void use_ptr() const;
};

Example::Example()
{
    feet = 0;
    inches = 0;
}

Example::Example(int ft)
{
    feet = ft;
    inches = 12 * feet;
}

Example::~~Example()
{
}
```

```

void Example::show_in() const
{
    cout << inches << " inches\n";
}

void Example::show_ft() const
{
    cout << feet << " feet\n";
}

void Example::use_ptr() const
{
    Example yard(3);
    int Example::*pt;
    pt = &Example::inches;
    cout << "Set pt to &Example::inches:\n";
    cout << "this->pt: " << this->*pt << endl;
    cout << "yard.*pt: " << yard.*pt << endl;
    pt = &Example::feet;
    cout << "Set pt to &Example::feet:\n";
    cout << "this->pt: " << this->*pt << endl;
    cout << "yard.*pt: " << yard.*pt << endl;
    void (Example::*pf)() const;
    pf = &Example::show_in;
    cout << "Set pf to &Example::show_in:\n";
    cout << "Using (this->*pf)(): ";
    (this->*pf)();
    cout << "Using (yard.*pf)(): ";
    (yard.*pf)();
}

int main()
{
    Example car(15);
    Example van(20);
    Example garage;

    cout << "car.use_ptr() output:\n";
    car.use_ptr();
    cout << "\nvan.use_ptr() output:\n";
    van.use_ptr();

    return 0;
}

```

---

Here is a sample run of the program in Listing E.1:

```
car.use_ptr() output:
Set pt to &Example::inches:
this->pt: 180
yard.*pt: 36
Set pt to &Example::feet:
this->pt: 15
yard.*pt: 3
Set pf to &Example::show_in:
Using (this->*pf)(): 180 inches
Using (yard.*pf)(): 36 inches
```

```
van.use_ptr() output:
Set pt to &Example::inches:
this->pt: 240
yard.*pt: 36
Set pt to &Example::feet:
this->pt: 20
yard.*pt: 3
Set pf to &Example::show_in:
Using (this->*pf)(): 240 inches
Using (yard.*pf)(): 36 inches
```

This example assigned pointer values at compile time. In a more sophisticated class, you can use member pointers to data members and methods for which the exact member associated with the pointer is determined at runtime.

## alignof (C++11)

Computer systems can have restrictions on how data is stored in memory. For example, one system might require that a `double` value be stored at an even-numbered memory location, whereas another might require the storage to begin at a location that is a multiple of eight. The `alignof` operator takes a type as an argument and returns an integer indicating the required alignment type. Alignment requirements can, for example, determine how information is arranged within a structure, as Listing E.2 shows.

### Listing E.2 `align.cpp`

---

```
// align.cpp -- checking alignment
#include <iostream>
using namespace std;
struct things1
{
    char ch;
    int a;
    double x;
```

```

};
struct things2
{
    int a;
    double x;
    char ch;
};

int main()
{
    things1 th1;
    things2 th2;
    cout << "char alignment: " << alignof(char) << endl;
    cout << "int alignment: " << alignof(int) << endl;
    cout << "double alignment: " << alignof(double) << endl;
    cout << "things1 alignment: " << alignof(things1) << endl;
    cout << "things2 alignment: " << alignof(things2) << endl;
    cout << "things1 size: " << sizeof(things1) << endl;
    cout << "things2 size: " << sizeof(things2) << endl;
    return 0;
}

```

---

Here is the output on one system:

```

char alignment: 1
int alignment: 4
double alignment: 8
things1 alignment: 8
things2 alignment: 8
things1 size: 16
things2 size: 24

```

Both structures have an alignment requirement of eight. One implication is that the structure size should be a multiple of eight so that one can create arrays of structures with each element adjacent to the next and also starting on an alignment boundary that's a multiple of eight. The individual members of each structure in Listing E.2 use only a total of 13 bits, but the requirement of using a multiple of eight bits means each structure needs some padding in it. Next, within each structure, the `double` member needs to align on a multiple of eight. The different arrangement of members within `things1` and `things2` results in `things2` needing more internal padding to make the boundaries come out right.

## **noexcept (C++11)**

The `noexcept` keyword is used to indicate that a function doesn't throw an exception. It also can be used as an operator that determines whether its operand (an expression) potentially could throw an exception. It returns `false` if the operand could throw an exception and `true` otherwise. For example, consider the following declarations:

```
int hilt(int);  
int halt(int) noexcept;
```

The expression `noexcept(hilt)` would evaluate as `false`, as the declaration of `hilt()` doesn't guarantee that an exception won't be thrown. But `noexcept(halt)` will evaluate as `true`.

# The `string` Template Class

Much of this appendix is a bit technical. However, if you just want to know the capabilities of the `string` template class, you can concentrate on the descriptions of the various `string` methods.

The `string` class is based on a template definition:

```
template<class charT, class traits = char_traits<charT>,
        class Allocator = allocator<charT> >
class basic_string {...};
```

Here `charT` represents the type stored in the string. The `traits` parameter represents a class that defines necessary properties that a type must possess to be represented as a string. For example, it should have a `length()` method that returns the length of a string, represented as an array of type `charT`. The end of such an array is indicated by the value `charT(0)`, the generalization of the null character. (The expression `charT(0)` is a type cast of `0` to type `charT`. It could be just `0`, as it is for type `char`, or more generally, it could be an object created by a `charT` constructor.) The class also includes methods for comparing values, and so on. The `Allocator` parameter represents a class to handle memory allocation for the string. The default `allocator<charT>` template uses `new` and `delete` in the standard ways.

There are four predefined specializations:

```
typedef basic_string<char> string;
typedef basic_string<char16_t> u16string;
typedef basic_string<char32_t> u32string;
typedef basic_string<wchar_t> wstring;
```

These specializations, in turn, use the following specializations:

```
char_traits<char>
allocator<char>
char_traits<char16_t>
allocator<char_16>
char_traits<char_32>
allocator<char_32>
char_traits<wchar_t>
allocator<wchar_t>
```



You can create a `string` class for some type other than `char` or `wchar_t` by defining a `traits` class and using the `basic_string` template.

## Thirteen Types and a Constant

The `basic_string` template defines several types that are used later in defining the methods:

```
typedef traits                               traits_type;
typedef typename traits::char_type          value_type;
typedef Allocator                            allocator_type;
typedef typename Allocator::size_type      size_type;
typedef typename Allocator::difference_type difference_type;
typedef typename Allocator::reference       reference;
typedef typename Allocator::const_reference const_reference;
typedef typename Allocator::pointer        pointer;
typedef typename Allocator::const_pointer  const_pointer;
```

Note that `traits` is a template parameter that corresponds to some specific type, such as `char_traits<char>`; `traits_type` becomes a `typedef` for that specific type. The following notation means that `char_type` is a type name defined in the class represented by `traits`:

```
typedef typename traits::char_type          value_type;
```

The keyword `typename` is used to tell the compiler that the expression `traits::char_type` is a type. For the `string` specialization, for example, `value_type` is `char`.

`size_type` is used like `size_of`, except that it returns the size of a string in terms of the stored type. For the `string` specialization, that would be in terms of `char`, in which case `size_type` is the same as `size_of`. It is an unsigned type.

`difference_type` is used to measure the distance between two elements of a string, again in units corresponding to the size of a single element. Typically, it would be a signed version of the type underlying `size_type`.

For the `char` specialization, `pointer` is type `char *`, and `reference` is type `char &`. However, if you create a specialization for a type of your own design, these types (`pointer` and `reference`) could refer to classes that have the same properties as the more basic pointers and references.

To allow Standard Template Library (STL) algorithms to be used with strings, the template defines some iterator types:

```
typedef (models random access iterator)      iterator;
typedef (models random access iterator)      const_iterator;
typedef std::reverse_iterator<iterator>     reverse_iterator;
typedef std::reverse_iterator<const_iterator> const_reverse_iterator;
```

The template defines a static constant:

```
static const size_type npos = -1;
```

Because `size_type` is unsigned, assigning the value `-1` actually amounts to assigning the largest possible unsigned value to `npos`. This value corresponds to one greater than the largest possible array index.

## Data Information, Constructors, and Odds and Ends

Constructors can be described in terms of the effects they have. Because the private portions of a class can be implementation dependent, these effects should be described in terms of information available as part of the public interface. Table F.1 lists several methods whose return values can be used to describe the effects of constructors and of other methods. Note that much of the terminology is from the STL.

Table F.1 Some `string` Data Methods

| Method                  | Returns                                                                                                                                                                                                                                                                                                                          |
|-------------------------|----------------------------------------------------------------------------------------------------------------------------------------------------------------------------------------------------------------------------------------------------------------------------------------------------------------------------------|
| <code>begin()</code>    | An iterator to the first character in a string.                                                                                                                                                                                                                                                                                  |
| <code>cbegin()</code>   | A <code>const_iterator</code> to the first character in a string (C++11).                                                                                                                                                                                                                                                        |
| <code>end()</code>      | An iterator that is the past-the-end value.                                                                                                                                                                                                                                                                                      |
| <code>end()</code>      | A <code>const_iterator</code> that is the past-the-end value (C++11).                                                                                                                                                                                                                                                            |
| <code>rbegin()</code>   | A reverse iterator that is the past-the-end.                                                                                                                                                                                                                                                                                     |
| <code>crbegin()</code>  | A reverse <code>const_iterator</code> that is the past-the-end (C++11).                                                                                                                                                                                                                                                          |
| <code>rend()</code>     | A reverse iterator that refers to the first character.                                                                                                                                                                                                                                                                           |
| <code>crend()</code>    | A reverse <code>const_iterator</code> that refers to the first character (C++11).                                                                                                                                                                                                                                                |
| <code>size()</code>     | The number of elements in a string, equal to the distance from <code>begin()</code> to <code>end()</code> .                                                                                                                                                                                                                      |
| <code>length()</code>   | The same as <code>size()</code> .                                                                                                                                                                                                                                                                                                |
| <code>capacity()</code> | The allocated number of elements in a string. This can be greater than the actual number of characters. The value of <code>capacity() - size()</code> represents the number of characters that can be appended to a string before more memory needs to be allocated.                                                             |
| <code>max_size()</code> | The maximum allowable size of a string.                                                                                                                                                                                                                                                                                          |
| <code>data()</code>     | A pointer of type <code>const charT*</code> that points to the first element of an array whose first <code>size()</code> elements equal the corresponding elements in the string controlled by <code>*this</code> . The pointer should not be assumed to be valid after the <code>string</code> object itself has been modified. |

Table F.1 Some `string` Data Methods

| Method                       | Returns                                                                                                                                                                                                                                                                                                                                                                                                                                 |
|------------------------------|-----------------------------------------------------------------------------------------------------------------------------------------------------------------------------------------------------------------------------------------------------------------------------------------------------------------------------------------------------------------------------------------------------------------------------------------|
| <code>c_str()</code>         | A pointer of type <code>const charT*</code> that points to the first element of an array whose first <code>size()</code> elements equal the corresponding elements in the string controlled by <code>*this</code> and whose next element is the <code>charT(0)</code> character (end-of-string marker) for the <code>charT</code> type. The pointer should not be assumed to be valid after the string object itself has been modified. |
| <code>get_allocator()</code> | A copy of the allocator object that is used to allocate memory for the <code>string</code> object.                                                                                                                                                                                                                                                                                                                                      |

Be careful of the differences among `begin()`, `rend()`, `data()`, and `c_str()`. All relate to the first character in a string, but in different ways. The `begin()` and `rend()` methods return iterators, which are generalizations of pointers, as described in Chapter 16, “The `string` Class and the Standard Template Library.” In particular, `begin()` returns a model of a forward iterator, and `rend()` returns a copy of a reverse iterator. Both refer to the actual string managed by the `string` object. (Because the `string` class uses dynamic memory allocation, the actual string contents need not be inside the object, so we use the term *manage* to describe the relationship between object and string.) You can use the methods that return iterators with the iterator-based algorithms of the STL. For example, you can use the STL `reverse()` function to reverse the contents of a string:

```
string word;
cin >> word;
reverse(word.begin(), word.end());
```

The `data()` and `c_str()` methods, on the other hand, do return ordinary pointers. Furthermore, the returned pointers point to the first element of an *array* that holds the string characters. This array can but need not be a copy of the original string managed by the `string` object. (The internal representation used by the `string` object can be an array, but it doesn't have to be.) Because it is possible that the returned pointers point to the original data, they are `const`, so they can't be used to alter the data. Also the pointers are not guaranteed to be valid after the string is modified; this reflects that they may point to the original data. The difference between `data()` and `c_str()` is that the array `c_str()` points to is terminated with a null character (or equivalent), whereas `data()` just guarantees that the actual string characters are present. Thus, the `c_str()` method can be used, for example, as an argument to a function that expects to receive a C-style string:

```
string file("tofu.man");
ofstream outFile(file.c_str());
```

Similarly, `data()` and `size()` could be used with a function that expects to receive a pointer to an array element and a value that represents the number of elements to process:

```
string vampire("Do not stake me, oh my darling!");
int vlad = byte_check(vampire.data(), vampire.size());
```

A C++ implementation could choose to represent a `string` object's string as a dynamically allocated C-style string and to implement the forward iterator as a `char *` pointer. In that case, the implementation could choose to have `begin()`, `data()`, and `c_str()` all return the same pointer. But it could just as legitimately (if not as easily) return references to three different data objects.

C++11 has 11 constructors for the `basic_string` template class, up from the six of C++98, and one destructor:

```
explicit basic_string(const Allocator& a = Allocator());
basic_string(const charT* s, const Allocator& a = Allocator());
basic_string(const charT* s, size_type n, const Allocator& a = Allocator());
basic_string(const basic_string& str);
basic_string(const basic_string& str, const Allocator&);
basic_string(const basic_string& str, size_type pos,
             size_type n = npos, const Allocator& a = Allocator());
basic_string(basic_string&& str) noexcept;
basic_string(const basic_string&& str, const Allocator&);
basic_string(size_type n, charT c, const Allocator& a = Allocator());
template<class InputIterator>
basic_string(InputIterator begin, InputIterator end,
             const Allocator& a = Allocator());
basic_string(initializer_list<charT>, const Allocator& = Allocator());
~basic_string();
```

Some of the increase in constructors comes from handling arguments differently. For example, C++98 had this copy constructor:

```
basic_string(const basic_string& str, size_type pos = 0,
            size_type n = npos, const Allocator& a = Allocator());
```

C++11 replaces it with three constructors—the second, third, and fourth items in the preceding list. This allows the most common uses of the C++98 version to be coded more efficiently. The really new additions are the move constructors (those with rvalue references, as discussed in Chapter 18, “Visiting with the New C++ Standard”) and the constructor with the `initializer_list` parameter.

Note that most of the constructors have an argument of the following form:

```
const Allocator& a = Allocator()
```

Recall that the term `Allocator` is the template parameter name for an allocator class to manage memory. The term `Allocator()` is the default constructor for that class. Thus, the constructors, by default, use the default version of the `allocator` object, but they give you the option of using some other version of the `allocator` object. The following sections examine the constructors individually.

## Default Constructor

This is the prototype for the default constructor:

```
explicit basic_string(const Allocator& a = Allocator());
```

Typically, you would accept the default argument for the `allocator` class and would use the constructor to create empty strings:

```
string bean;
wstring theory;
```

The following relationships hold after the default constructor is called:

- The `data()` method returns a non-null pointer to which `0` can be added.
- The `size()` method returns `0`.
- The return value for `capacity()` is not specified.

Suppose you assign the value returned by `data()` to the pointer `str`. In this case, the first condition means `str + 0` is valid.

## Constructors That Use C-Style Strings

Constructors that use C-style strings let you initialize a `string` object from a C-style string; more generally, they let you initialize a `charT` specialization from an array of `charT` values:

```
basic_string(const charT* s, const Allocator& a = Allocator());
```

To determine how many characters to copy, the constructor applies the `traits::length()` method to the array pointed to by `s`. (The pointer `s` should not be a null pointer.) For example, the following statement initializes the `toast` object, using the indicated character string:

```
string toast("Here's looking at you, kid.");
```

The `traits::length()` method for type `char` uses the null character to determine how many characters to copy.

The following relationships hold after the constructor is called:

- The `data()` method returns a pointer to the first element of a copy of the array `s`.
- The `size()` method returns a value equal to `traits::length()`.
- The `capacity()` method returns a value at least as large as `size()`.

## Constructors That Use Part of a C-Style String

Constructors that use part of a C-style string let you initialize a `string` object from part of a C-style string; more generally, they let you initialize a `charT` specialization from part of an array of `charT` values:

```
basic_string(const charT* s, size_type n, const Allocator& a = Allocator());
```

This constructor copies to the constructed object a total of  $n$  characters from the array pointed to by  $s$ . Note that it doesn't stop copying if  $s$  has fewer characters than  $n$ . If  $n$  exceeds the length of  $s$ , the constructor interprets the contents of memory following the string as if they held data of type `charT`.

This constructor requires that  $s$  is not a null pointer and that  $n < npos$ . (Recall that `npos` is a static class constant equal to the maximum possible number of elements in a string.) If  $n$  equals `npos`, the constructor throws an `out_of_range` exception. (Because  $n$  is of type `size_type` and `npos` is the maximum `size_type` value,  $n$  cannot be greater than `npos`.) Otherwise, the following relationships hold after the constructor is called:

- The `data()` method returns a pointer to the first element of a copy of the array  $s$ .
- The `size()` method returns  $n$ .
- The `capacity()` method returns a value at least as large as `size()`.

## Constructors That Use an Lvalue Reference

The copy constructor looks like this:

```
basic_string(const basic_string& str);
```

It initializes a new `string` object using a `string` argument:

```
string mel("I'm ok!");
string ida(mel);
```

Here, `ida` would get a copy of the string managed by `mel`.

The next constructor additionally requires that you specify an allocator:

```
basic_string(const basic_string& str, const Allocator&);
```

The following relationships hold after either of these two constructors is called:

- The `data()` method returns a pointer to an allocated copy of the array whose first element is pointed to by `str.data()`.
- The `size()` method returns the value of `str.size()`.
- The `capacity()` method returns a value at least as large as `size()`.

Moving along, the next constructor lets you set several items:

```
basic_string(const basic_string& str, size_type pos, size_type n = npos,
             const Allocator& a = Allocator());
```

The second argument `pos` specifies a location in the source string from which to begin the copying:

```
string att("Telephone home.");
string et(att, 4);
```

Position numbers begin with 0, so position 4 is the `p` character. Thus, `et` is initialized to "phone home."

The optional third argument `n` specifies the maximum number of characters to copy. Thus, this initializes `pt` to the string "phone":

```
string att("Telephone home.");
string pt(att, 4, 5);
```

However, this constructor does not go past the end of the source string; for example, the following stops after copying the period:

```
string pt(att, 4, 200)
```

Thus, the constructor actually copies a number of characters equal to the lesser of `n` and `str.size() - pos`.

This constructor requires that `pos <= str.size()`—that is, that the initial position copied to is inside the source string; if this is not the case, the constructor throws an `out_of_range` exception. Otherwise, if `copy_len` represents the lesser of `n` and `str.size() - pos`, the following relationships hold after the constructor is called:

- The `data()` method returns a pointer to a copy of `copy_len` elements copied from the string `str`, starting with position `pos` in `str`.
- The `size()` method returns `copy_len`.
- The `capacity()` method returns a value at least as large as `size()`.

## Constructors That Use an Rvalue Reference (C++11)

C++11 adds move semantics to the `string` class. As described in Chapter 18, this involves adding a move constructor, which uses an rvalue reference instead of an lvalue reference:

```
basic_string(basic_string&& str) noexcept;
```

This constructor is invoked when the actual argument is a temporary object:

```
string one("din"); // C-style string constructor
string two(one); // copy constructor - one is an lvalue
string three(one+two); // move constructor, sum is an rvalue
```

As discussed in Chapter 18, the intent is that `string three` takes ownership of the object constructed by `operator+` rather than copying the object and then letting the original be destroyed.

The second rvalue constructor additionally allows you to specify an allocator:

```
basic_string(const basic_string&& str, const Allocator&);
```

The following relationships hold after either of these two constructors is called:

- The `data()` method returns a pointer to an allocated copy of the array whose first element is pointed to by `str.data()`.
- The `size()` method returns the value of `str.size()`.
- The `capacity()` method returns a value at least as large as `size()`.

## Constructor That Uses $n$ Copies of a Character

A constructor that uses  $n$  copies of a character creates a `string` object that consists of  $n$  consecutive characters, all having the value `c`:

```
basic_string(size_type n, charT c, const Allocator& a = Allocator());
```

This constructor requires that  $n < npos$ . If  $n$  equals  $npos$ , the constructor throws an `out_of_range` exception. Otherwise, the following relationships hold after the constructor is called:

- The `data()` method returns a pointer to the first element of a string of  $n$  elements, each set to `c`.
- The `size()` method returns  $n$ .
- The `capacity()` method returns a value at least as large as `size()`.

## Constructor That Uses a Range

A constructor that uses a range uses an iterator-defined range in the style of the STL:

```
template<class InputIterator>
basic_string(InputIterator begin, InputIterator end,
             const Allocator& a = Allocator());
```

The `begin` iterator points to the element in the source at which copying begins, and `end` points to one past the last location to be copied.

You can use this form with arrays, strings, or STL containers:

```
char cole[40] = "Old King Cole was a merry old soul.";
string title(cole + 4, cole + 8);
vector<char> input;
char ch;
while (cin.get(ch) && ch != '\n')
    input.push_back(ch);
string str_input(input.begin(), input.end());
```

In the first use, `InputIterator` is evaluated to type `const char *`. In the second use, `InputIterator` is evaluated to type `vector<char>::iterator`.

The following relationships hold after the constructor is called:

- The `data()` method returns a pointer to the first element of a string formed by copying elements from the range `[begin, end)`.
- The `size()` method returns the distance between `begin` and `end`. (The distance is measured in units equal to the size of data type obtained when the iterator is dereferenced.)
- The `capacity()` method returns a value at least as large as `size()`.



## Constructor That Uses an Initialization List (C++11)

This constructor takes an `initializer_list<charT>` parameter:

```
basic_string(initializer_list<charT> il, const Allocator& a = Allocator());
```

You can use it with a braced list of characters:

```
string slow({'s', 'n', 'a', 'i', 'l'});
```

This isn't the most convenient way to initialize a string, but it keeps the string interface similar to that of the STL container classes.

The `initializer_list` class has `begin()` and `end()` members, and the effect of using this constructor is the same using the range constructor:

```
basic_string(il.begin(), il.end(), a);
```

## Memory Miscellany

Several methods deal with memory—for example, clearing memory contents, resizing a string, or adjusting the capacity of a string. Table F.2 lists some memory-related methods.

Table F.2 Some Memory-Related Methods

| Method                                           | Effect                                                                                                                                                                                                                                                                                              |
|--------------------------------------------------|-----------------------------------------------------------------------------------------------------------------------------------------------------------------------------------------------------------------------------------------------------------------------------------------------------|
| <code>void resize(size_type n)</code>            | Throws an <code>out_of_range</code> exception if <code>n &gt; npos</code> . Otherwise, changes the size of a string to <code>n</code> , truncating the end of the string if <code>n &lt; size()</code> and padding the string with <code>charT(0)</code> characters if <code>n &gt; size()</code> . |
| <code>void resize(size_type n, charT c)</code>   | Throws an <code>out_of_range</code> exception if <code>n &gt; npos</code> . Otherwise, changes the size of a string to <code>n</code> , truncating the end of the string if <code>n &lt; size()</code> and padding the string with the character <code>c</code> if <code>n &gt; size()</code> .     |
| <code>void reserve(size_type res_arg = 0)</code> | Sets <code>capacity()</code> to greater than or equal to <code>res_arg</code> . Because this reallocates the string, it voids previous references, iterators, and pointers into the string.                                                                                                         |
| <code>void shrink_to_fit()</code>                | Non-binding request to reduce <code>capacity()</code> to <code>size()</code> (C++11).                                                                                                                                                                                                               |
| <code>void clear() noexcept</code>               | Removes all characters from a string.                                                                                                                                                                                                                                                               |
| <code>bool empty() const noexcept</code>         | Returns <code>true</code> if <code>size() == 0</code> .                                                                                                                                                                                                                                             |

## String Access

There are four methods for accessing individual characters, two of which use the `[]` operator and two of which use the `at()` method:

```
reference operator[](size_type pos);
const_reference operator[](size_type pos) const;
reference at(size_type n);
const_reference at(size_type n) const;
```

The first operator `[]()` method allows you to access an individual element of a string by using array notation; it can be used to retrieve or alter the value. The second operator `[]()` method can be used with `const` objects, and it can be used only to retrieve the value:

```
string word("tack");
cout << word[0];    // display the t
word[3] = 't';     // overwrite the k with a t
const ward("garlic");
cout << ward[2];   // display the r
```

The `at()` methods provide similar access, except that the index is provided in function argument notation:

```
string word("tack");
cout << word.at(0); // display the t
```

The difference (besides the syntax difference) is that the `at()` methods provide bounds checking and throw an `out_of_range` exception if `pos >= size()`. Note that `pos` is type `size_type`, which is unsigned; therefore, a negative value is impossible for `pos`. The operator `[]()` methods don't do bounds checking, so the behavior is undefined if `pos >= size()`, except that the `const` version returns the null character equivalent if `pos == size()`.

Thus, you get a choice between safety (using `at()` and testing for exceptions) and execution speed (using array notation).

There is also a function that returns a new string that is a substring of the original:

```
basic_string substr(size_type pos = 0, size_type n = npos) const;
```

It returns a string that's a copy of the string starting at position `pos` and going for `n` characters or to the end of the string, whichever comes first. For example, the following initializes `pet` to "donkey":

```
string message("Maybe the donkey will learn to sing.");
string pet(message.substr(10, 6));
```

C++11 adds these four access methods:

```
const charT& front() const;
charT& front();
const charT& back() const;
charT& back();
```

The `front()` methods access the first element of a `string`, acting like `operator[] (0)`. The `back()` methods access the last element of a `string`, acting like `operator[] (size() - 1)`.

## Basic Assignment

C++11 has five overloaded assignment methods, up two from C++98:

```
basic_string& operator=(const basic_string& str);
basic_string& operator=(const charT* s);
basic_string& operator=(charT c);
basic_string& operator=(basic_string&& str) noexcept; // C++11
basic_string& operator=(initializer_list<charT>); // C++11
```

The first assigns one `string` object to another, the second assigns a C-style string to a `string` object, the third assigns a single character to a `string` object, the fourth uses move semantics to assign an rvalue `string` object to a `string` object, and the fifth allows assignment of an initializer list. Thus, all the following operations are possible:

```
string name("George Wash");
string pres, veep, source, join, awkward;
pres = name;
veep = "Road Runner";
source = 'X';
join = name + source; // now with move semantics!
awkward = {'C', 'l', 'o', 'u', 's', 'e', 'a', 'u'};
```

## String Searching

The `string` class provides six search functions, each with four prototypes. The following sections describe them briefly.

### The `find()` Family

Here are the `find()` prototypes as provided by C++11:

```
size_type find (const basic_string& str, size_type pos = 0) const noexcept;
size_type find (const charT* s, size_type pos = 0) const;
size_type find (const charT* s, size_type pos, size_type n) const;
size_type find (charT c, size_type pos = 0) const noexcept;
```

The first member returns the beginning position of the `str` substring's first occurrence in the invoking object, with the search beginning at position `pos`. If the substring is not found, the method returns `npos`.

Here's code for finding the location of the substring "hat" in a longer string:

```
string longer("That is a funny hat.");
string shorter("hat");
```

```
size_type loc1 = longer.find(shorter);           // sets loc1 to 1
size_type loc2 = longer.find(shorter, loc1 + 1); // sets loc2 to 16
```

Because the second search begins at position 2 (the a in That), the first occurrence of hat it finds is near the end of the string. To test for failure, you use the `string::npos` value:

```
if (loc1 == string::npos)
    cout << "Not found\n";
```

The second method does the same thing, except that it uses an array of characters instead of a `string` object as the substring:

```
size_type loc3 = longer.find("is");           //sets loc3 to 5
```

The third method does the same as the second, except that it uses only the first `n` characters of the string `s`. The effect is the same as using the `basic_string(const charT* s, size_type n)` constructor and using the resulting object as the `string` argument to the first form of `find()`. For example, the following searches for the substring "fun":

```
size_type loc4 = longer.find("funds", 3);     //sets loc4 to 10
```

The fourth method does the same thing as the first, except that it uses a single character instead of a `string` object as the substring:

```
size_type loc5 = longer.find('a');           //sets loc5 to 2
```

## The `rfind()` Family

The `rfind()` methods have these prototypes:

```
size_type rfind(const basic_string& str,
               size_type pos = npos) const noexcept;
size_type rfind(const charT* s, size_type pos = npos) const;
size_type rfind(const charT* s, size_type pos, size_type n) const;
size_type rfind(charT c, size_type pos = npos) const noexcept;
```

These methods work like the analogous `find()` methods, except that they find the last occurrence of a string or character that starts at or before position `pos`. If the substring is not found, the method returns `npos`.

Here's code for finding the location of the substring "hat" in a longer string, starting at the end of the longer string:

```
string longer("That is a funny hat.");
string shorter("hat");
size_type loc1 = longer.rfind(shorter);       // sets loc1 to 16
size_type loc2 = longer.rfind(shorter, loc1 - 1); // sets loc2 to 1
```



```

size_type find_first_not_of(const charT* s, size_type pos,
                           size_type n) const;
size_type find_first_not_of(const charT* s, size_type pos = 0) const;
size_type find_first_not_of(charT c, size_type pos = 0) const noexcept;

```

These methods work like the corresponding `find_first_of()` methods, except that they search for the first occurrence of any character not in the substring.

Here's code for finding the location of the first two occurrences of any of the letters not in "This" in a longer string:

```

string longer("That is a funny hat.");
string shorter("This");
size_type loc1 = longer.find_first_not_of(shorter); // sets loc1 to 2
size_type loc2 = longer.find_first_not_of("Thatch"); // sets loc2 to 4

```

The `a` in `That` is the first character in `longer` that does not appear in `This`. The first space in the longer string is the first character not present in `Thatch`.

## The `find_last_not_of()` Family

The `find_last_not_of()` methods have these prototypes:

```

size_type find_last_not_of (const basic_string& str,
                           size_type pos = npos) const noexcept;
size_type find_last_not_of (const charT* s, size_type pos,
                           size_type n) const;
size_type find_last_not_of (const charT* s,
                           size_type pos = npos) const;
size_type find_last_not_of (charT c, size_type pos = npos) const noexcept;

```

These methods work like the corresponding `find_last_of()` methods, except that they search for the last occurrence of any character not in the substring.

Here's code for finding the location of the last two occurrences of any of the letters not in "This" in a longer string:

```

string longer("That is a funny hat.");
string shorter("That.");
size_type loc1 = longer.find_last_not_of(shorter); // sets loc1 to 15
size_type loc2 = longer.find_last_not_of(shorter, 10); // sets loc2 to 10

```

The last space in `longer` is the last character in `longer` that does not appear in `shorter`. The `f` in the longer string is the last character not present in `shorter` found up through position 10.

## Comparison Methods and Functions

The `string` class offers methods and functions for comparing two strings. First, here are the method prototypes:

```

int compare(const basic_string& str) const noexcept;

int compare(size_type pos1, size_type n1,
            const basic_string& str) const;
int compare(size_type pos1, size_type n1,
            const basic_string& str,
            size_type pos2, size_type n2) const;
int compare(const charT* s) const;
int compare(size_type pos1, size_type n1, const charT* s) const;
int compare(size_type pos1, size_type n1,
            const charT* s, size_type n2 ) const;

```

These methods use a `traits::compare()` method that is defined for the particular character type used for the string. The first method returns a value less than 0 if the first string precedes the second string according to the ordering supplied by `traits::compare()`. It returns 0 if the two strings are the same, and it returns a value greater than 0 if the first string follows the second. If two strings are identical to the end of the shorter of the two strings, the shorter string precedes the longer string.

The following examples compare strings `s1` with `s3` and `s1` with `s2`:

```

string s1("bellflower");
string s2("bell");
string s3("cat");
int a13 = s1.compare(s3); // a13 is < 0
int a12 = s1.compare(s2); // a12 is > 0

```

The second method is like the first, except that it just uses `n1` characters, starting from position `pos1` in the first string for the comparison.

The following example compares the first four characters in `s1` with `s2`:

```

string s1("bellflower");
string s2("bell");
int a2 = s1.compare(0, 4, s2); // a2 is 0

```

The third method is like the first, except that it just uses `n1` characters, starting from position `pos1` in the first string, and `n2` characters, starting from position `pos2` in the second string, for the comparison. For example, the following compares the out in `stout` to the out in `about`:

```

string st1("stout boar");
string st2("mad about ewe");
int a3 = st1.compare(2, 3, st2, 6, 3); // a3 is 0

```

The fourth method is like the first, except that it uses a character array instead of a string object for the second string.

The fifth and sixth methods essentially are like the third, except that they use a character array instead of a string object for the second string.

The non-member comparison functions are overloaded relational operators:

```
operator==()
operator<()
operator<=()
operator>()
operator>=()
operator!=()
```

Each operator is overloaded so that it can compare a `string` object to a `string` object, a `string` object to a C-style string, and a C-style string to a `string` object. These operators are defined in terms of the `compare()` method, so they provide a notationally more convenient way of making comparisons.

## String Modifiers

The `string` class provides several methods for modifying strings. Most come with an abundance of overloaded versions so that they can be used with `string` objects, string arrays, individual characters, and iterator ranges.

### Methods for Appending and Adding

You can append one string to another by using the overloaded `+=` operator or by using an `append()` method. All throw a `length_error` exception if the result would be longer than the maximum string size. The `+=` operators let you append a `string` object, a string array, or an individual character to another string:

```
basic_string& operator+=(const basic_string& str);
basic_string& operator+=(const charT* s);
basic_string& operator+=(charT c);
```

The `append()` methods also let you append a `string` object, a string array, or an individual character to another string. In addition, they let you append part of a `string` object by specifying an initial position and a number of characters to append or else by specifying a range. You can append part of a string by specifying how many characters of the string to use. The version for appending a character lets you specify how many instances of that character to copy. Here are the prototypes for the various `append()` methods:

```
basic_string& append(const basic_string& str);
basic_string& append(const basic_string& str, size_type pos,
                    size_type n);
template<class InputIterator>
    basic_string& append(InputIterator first, InputIterator last);
basic_string& append(const charT* s);
basic_string& append(const charT* s, size_type n);
basic_string& append(size_type n, charT c); // append n copies of c
void push_back(charT c); // appends 1 copy of c
```



Here are a couple examples:

```
string test("The");
test.append("ory"); // test is "Theory"
test.append(3, '!'); // test is "Theory!!!"
```

The `operator+()` function is overloaded to enable string concatenation. The overloaded functions don't modify a string; instead, they create a new string that consists of one string appended to a second. The addition functions are not member functions, and they allow you to add a string object to a string object, a string array to a string object, a string object to a string array, a character to a string object, and a string object to a character. Here are some examples:

```
string st1("red");
string st2("rain");
string st3 = st1 + "uce"; // st3 is "reduce"
string st4 = 't' + st2; // st4 is "train"
string st5 = st1 + st2; // st5 is "redrain"
```

## More Assignment Methods

In addition to the basic assignment operator, the `string` class provides `assign()` methods, which allow you to assign a whole string or a part of a string or a sequence of identical characters to a string object. Here are the prototypes for the various `assign()` methods:

```
basic_string& assign(const basic_string& str);
basic_string& assign(basic_string&& str) noexcept; // C++11
basic_string& assign(const basic_string& str, size_type pos,
                    size_type n);
basic_string& assign(const charT* s, size_type n);
basic_string& assign(const charT* s);
basic_string& assign(size_type n, charT c); // assign n copies of c
template<class InputIterator>
    basic_string& assign(InputIterator first, InputIterator last);
basic_string& assign(initializer_list<charT>); // C++11
```

Here are a couple examples:

```
string test;
string stuff("set tubs clones ducks");
test.assign(stuff, 1, 5); // test is "et tu"
test.assign(6, '#'); // test is "#####"
```

The `assign()` method with an rvalue reference (added by C++11) allows for move semantics, and the second new `assign()` method allows one to assign an `initializer_list` to a string object.

## Insertion Methods

The `insert()` methods let you insert a string object, a string array, a character, or several characters into a string object. The methods are similar to the `append()` methods, except that they take an additional argument, indicating where to insert the new material. This argument may be a position or an iterator. The material is inserted before the insertion point. Several of the methods return a reference to the resulting string. If `pos1` is beyond the end of the target string or if `pos2` is beyond the end of the string to be inserted, a method throws an `out_of_range` exception. If the resulting string will be larger than the maximum size, a method throws a `length_error` exception. Here are the prototypes for the various `insert()` methods:

```
basic_string& insert(size_type pos1, const basic_string& str);
basic_string& insert(size_type pos1, const basic_string& str,
                    size_type pos2, size_type n);
basic_string& insert(size_type pos, const charT* s, size_type n);
basic_string& insert(size_type pos, const charT* s);
basic_string& insert(size_type pos, size_type n, charT c);
iterator insert(const_iterator p, charT c);
iterator insert(const_iterator p, size_type n, charT c);
template<class InputIterator>
    void insert(iterator p, InputIterator first, InputIterator last);
iterator insert(const_iterator p, initializer_list<charT>); // C++11
```

For example, the following code inserts the string "former " before the b in "The banker.":

```
string st3("The banker.");
st3.insert(4, "former ");
```

Then the following code inserts the string " waltzed" (not including the !, which would be the ninth character) just before the period at the end of "The former banker.":

```
st3.insert(st3.size() - 1, " waltzed!", 8);
```

## Erase Methods

The `erase()` methods remove characters from a string. Here are their prototypes:

```
basic_string& erase(size_type pos = 0, size_type n = npos);
iterator erase(const_iterator position);
iterator erase(const_iterator first, iterator last);
void pop_back();
```

The first form removes the character from position `pos` to `n` characters later or the end of the string, whichever comes first. The second removes the single character referenced by the iterator position and returns an iterator to the next element or if there are no more elements, returns `end()`. The third removes the characters in the range `[first, last)`; that is, including `first` and up to but not including `last`. The method returns an iterator to the element following the last element erased. Finally, the `pop_back()` method removes the last character in the string.

## Replacement Methods

The various `replace()` methods identify part of a string to be replaced and identify the replacement. The part to be replaced can be identified by an initial position and a character count or by an iterator range. The replacement can be a `string` object, a string array, or a particular character duplicated several times. Replacement `string` objects and arrays can further be modified by indicating a particular portion, using a position and a count, just a count, or an iterator range. Here are the prototypes for the various `replace()` methods:

```
basic_string& replace(size_type pos1, size_type n1, const basic_string& str);
basic_string& replace(size_type pos1, size_type n1, const basic_string& str,
                    size_type pos2, size_type n2);
basic_string& replace(size_type pos, size_type n1, const charT* s,
                    size_type n2);
basic_string& replace(size_type pos, size_type n1, const charT* s);
basic_string& replace(size_type pos, size_type n1, size_type n2, charT c);
basic_string& replace(const_iterator i1, const_iterator i2,
                    const basic_string& str);
basic_string& replace(const_iterator i1, const_iterator i2,
                    const charT* s, size_type n);
basic_string& replace(const_iterator i1, const_iterator i2,
                    const charT* s);
basic_string& replace(const_iterator i1, const_iterator i2,
                    size_type n, charT c);
template<class InputIterator>
    basic_string& replace(const_iterator i1, const_iterator i2,
                        InputIterator j1, InputIterator j2);
basic_string& replace(const_iterator i1, const_iterator i2,
                    initializer_list<charT> il);
```

Here is an example:

```
string test("Take a right turn at Main Street.");
test.replace(7,5,"left"); // replace right with left
```

Note that you can use `find()` to find the positions used in `replace`:

```
string s1 = "old";
string s2 = "mature";
string s3 = "The old man and the sea";
string::size_type pos = s3.find(s1);
if (pos != string::npos)
    s3.replace(pos, s1.size(), s2);
```

This example would replace `old` with `mature`.

## Other Modifying Methods: `copy()` and `swap()`

The `copy()` method copies a `string` object, or part thereof, to a designated character array:

```
size_type copy(charT* s, size_type n, size_type pos = 0) const;
```

In this case, `s` points to the destination array, `n` indicates the number of characters to copy, and `pos` indicates the position in the `string` object from which copying begins. Copying proceeds for `n` characters or until the last character in the `string` object, whichever comes first. The function returns the number of characters copied. The method does not append a null character, and it is up to the programmer to see that the array is large enough to hold the copy.

### Caution

The `copy()` method does not append a null character, nor does it check whether the destination array is large enough.

The `swap()` method swaps the contents of two `string` objects by using a constant time algorithm:

```
void swap(basic_string& str);
```

## Output and Input

The `string` class overloads the `<<` operator to display `string` objects. It returns a reference to the `ostream` object so that output can be concatenated:

```
string claim("The string class has many features.");
cout << claim << endl;
```

The `string` class overloads the `>>` operator so that you can read input into a `string`:

```
string who;
cin >> who;
```

Input terminates on the end-of-file, on reading the maximum number of characters allowed in a `string`, or on reaching a white-space character. (The definition of white space depends on the character set and on the type that `charT` represents.)

There are two `getline()` functions. The first has this prototype:

```
template<class charT, class traits, class Allocator>
    basic_istream<charT,traits>& getline(basic_istream<charT,traits>& is,
        basic_string<charT,traits,Allocator>& str, charT delim);
```

It reads characters from the input stream `is` into the string `str` until it encounters the `delim` delimiter character, reaches the maximum size of the string, or encounters the end-of-file. The `delim` character is read (that is, removed from the input stream) but not stored. The second version lacks the third argument and uses the newline character (or its generalization) instead of `delim`:

```
string str1, str2;
getline(cin, str1);          // read to end-of-line
getline(cin, str2, '.');    // read to period
```

# The Standard Template Library

## Methods and Functions

The Standard Template Library (STL) aims to provide efficient implementations of common algorithms. It expresses these algorithms in general functions that can be used with any container that satisfies the requirements for the particular algorithm and in methods that can be used with instantiations of particular container classes. This appendix assumes that you have some familiarity with the STL, such as might be gained from reading Chapter 16, “The `string` Class and the Standard Template Library.” For example, this chapter assumes that you know about iterators and constructors.

### The STL and C++11

Just as the changes brought by C++11 to the C++ language are too extensive to cover completely in this book, so are the changes to the STL too extensive to cover completely in this appendix. However, we can summarize many of the additions.

C++11 brings several new elements to the STL. First, it adds several new containers. Second, it adds a few new features to the old containers. Third, it adds a few new template functions to its family of algorithms. All these changes are incorporated into this appendix, but you may find an overview of the first two categories helpful.

#### New Containers

C++11 adds the following containers: `array`, `forward_list`, `unordered_set`, and the unordered associative containers `unordered_multiset`, `unordered_map`, and `unordered_multimap`.

An `array` container, once declared, is fixed in size and uses static or stack memory rather than dynamically allocated memory. It's intended as a substitute for the built-in array type; it's more limited than `vector`, but more efficient.

The `list` container is a bidirectional linked list, with each item, other than the two ends, linked to the item before it and the one after. The `forward_list` is a singly linked

list, with each item, other than the last, linked to the next item. It provides a more compact, but more limited, alternative for `list`.

Like `set` and the other associative containers, the unordered associative containers allow fast data retrieval through the use of keys. The difference is that the associative containers use trees as the underlying data structure, whereas the unordered associative containers use hash tables.

## Changes to C++98 Containers

C++11 brings three main changes to the container class methods.

First, the addition of rvalue references makes it possible to provide move semantics (Chapter 18, “Visiting with the New C++ Standard”) for containers. Accordingly, the STL now provides move constructors and move assignment operators for containers. These methods take an rvalue reference argument.

Second, the addition of the `initializer_list` template class (Chapter 18) has led to constructors and assignment operators that accept an `initializer_list` argument. This makes code like the following possible:

```
vector<int> vi{100, 99, 97, 98};
vi = {96, 99, 94, 95, 102};
```

Third, the addition of variadic templates and function parameter packs (Chapter 18) makes emplacement methods possible. What does this mean? Like move semantics, emplacement is a means to increase efficiency. Consider the following code snippets:

```
class Items
{
    double x;
    double y;
    int m;
public:
    Items(); // #1
    Items (double xx, double yy, int mm); // #2
    ...
};
...
vector<Items> vt(10);
...
vt.push_back(Items(8.2, 2.8, 3)); //
```

The call to `insert()` causes the memory allocation function to create a default `Items` object at the end of `vt`. Next, the `Items()` constructor creates a temporary `Items` object; this object is copied to a location at the front of the vector `vt` and then the temporary object is deleted. With C++11, you can do this instead:

```
vi.emplace_back(8.2, 2.8, 3);
```

The `emplace_back()` method is a variadic template with a function parameter pack as its argument:

```
template <class... Args> void emplace_back(Args&&... args);
```

The three arguments 8.2, 2.8, and 3 are packed into the `args` parameter. These parameters are passed along to the allocation function, which then can unpack the parameters and use the `Items` constructor with three arguments (#2) instead of the default constructor (#1). That is, it can use `Items(args...)`, which, in this example, expands to `Items(8.2, 2.8, 3)`. Thus, the desired object is constructed in place in the vector rather than at a temporary location and then copied to the vector.

The STL uses this technique with several emplacement methods.

## Members Common to All or Most Containers

All containers define the types in Table G.1. In this table, `X` is a container type, such as `vector<int>`, and `T` is the type stored in the container, such as `int`. The examples following the table clarify the meanings.

Table G.1 Types Defined for All Containers

| Type                            | Value                                                                                                                                |
|---------------------------------|--------------------------------------------------------------------------------------------------------------------------------------|
| <code>X::value_type</code>      | <code>T</code> , the element type.                                                                                                   |
| <code>X::reference</code>       | <code>T &amp;</code> .                                                                                                               |
| <code>X::const_reference</code> | <code>const T &amp;</code> .                                                                                                         |
| <code>X::iterator</code>        | Iterator type pointing to <code>T</code> , behaves like type <code>T *</code> .                                                      |
| <code>X::const_iterator</code>  | Iterator type pointing to <code>const T</code> ; behaves like type <code>const T *</code> .                                          |
| <code>X::difference_type</code> | Signed integral type used to represent the distance from one iterator to another (for example, the difference between two pointers). |
| <code>X::size_type</code>       | Unsigned integral type <code>size_type</code> can represent size of data objects, number of elements, and subscripts.                |

The class definition uses a `typedef` to define these members. You can use these types to declare suitable variables. For example, the following code uses a roundabout way to replace the first occurrence of "bonus" in a vector of `string` objects with "bogus" in order to show how you can use member types to declare variables:

```
using namespace std;
vector<string> input;
string temp;
while (cin >> temp && temp != "quit")
    input.push_back(temp);
vector<string>::iterator want=
```



```

    find(input.begin(), input.end(), string("bonus"));
if (want != input.end())
{
    vector<string>::reference r = *want;
    r = "bogus";
}

```

This code makes `r` a reference to the element in `input` to which `want` points. Similarly, continuing with the preceding example, you can write code like the following:

```

vector<string>::value_type s1 = input[0]; // s1 is type string
vector<string>::reference s2 = input[1]; // s2 is type string &

```

This results in `s1` being a new `string` object that's a copy of `input[0]` and in `s2` being a reference to `input[1]`. In this example, given that you already know that the template is based on the `string` type, it would be simpler to write the following code, which is equivalent in its effect:

```

string s1 = input[0]; // s1 is type string
string & s2 = input[1]; // s2 is type string &

```

However, the more elaborate types from Table G.1 can also be used in more general code in which the type of container and element are generic. For example, suppose you want a `min()` function that takes as its argument a reference to a container and returns the smallest item in the container. This assumes that the `<` operator is defined for the value type used to instantiate the template and that you don't want to use the STL `min_element()` algorithm, which uses an iterator interface. Because the argument could be `vector<int>` or `list<string>` or `deque<double>`, you use a template with a template parameter, such as `Bag`, to represent the container. (That is, `Bag` is a template type that might be instantiated as `vector<int>`, `list<string>`, or some other container type.) So the argument type for the function is `const Bag & b`. What about the return type? It should be the value type for the container—that is, `Bag::value_type`. However, at this point, `Bag` is just a template parameter, and the compiler has no way of knowing that the `value_type` member is actually a type. But you can use the `typename` keyword to clarify that a class member is a `typedef`:

```

vector<string>::value_type st; // vector<string> a defined class
typename Bag::value_type m; // Bag an as yet undefined type

```

For the first definition here, the compiler has access to the `vector` template definition, which states that `value_type` is a `typedef`. For the second definition, the `typename` keyword promises that, whatever `Bag` may turn out to be, the combination `Bag::value_type` is the name of a type. These considerations lead to the following definition:

```

template<typename Bag>
typename Bag::value_type min(const Bag & b)
{
    typename Bag::const_iterator it;
    typename Bag::value_type m = *b.begin();
}

```

```

    for (it = b.begin(); it != b.end(); ++it)
        if (*it < m)
            m = *it;
    return m;
}

```

You then could use this template function as follows:

```

vector<int> temperatures;
// input temperature values into the vector
int coldest = min(temperatures);

```

The `temperatures` parameter would cause `Bag` to be evaluated as `vector<int>` and `typename Bag::value_type` to be evaluated as `vector<int>::value_type`, which, in turn, is `int`.

All containers also contain the member functions or operations listed in Table G.2. Again, `X` is a container type, such as `vector<int>`, and `T` is the type stored in the container, such as `int`. Also `a` and `b` are values of type `X`, `u` is an identifier, `r` is a non-const value of type `X`, and `rv` is a non-const rvalue of type `X`. The move operations were added by C++11.

Table G.2 Operations Defined for All Containers

| Operation                       | Description                                                                                      |
|---------------------------------|--------------------------------------------------------------------------------------------------|
| <code>X u;</code>               | Constructs an empty object <code>u</code> .                                                      |
| <code>X ()</code>               | Constructs an empty object.                                                                      |
| <code>X (a)</code>              | Constructs a copy of object <code>a</code> .                                                     |
| <code>X u (a)</code>            | <code>u</code> is a copy of <code>a</code> (copy constructor).                                   |
| <code>X u = a;</code>           | <code>u</code> is a copy of <code>a</code> (copy constructor).                                   |
| <code>r = a</code>              | <code>r</code> equals the value of <code>a</code> (copy assignment).                             |
| <code>X u (rv)</code>           | <code>u</code> equals the value that <code>rv</code> had before construction (move constructor). |
| <code>X u = rv;</code>          | <code>u</code> equals the value that <code>rv</code> had before construction (move constructor). |
| <code>a = rv</code>             | <code>a</code> equals the value that <code>rv</code> had before construction (move assignment).  |
| <code>(&amp;a) -&gt;~X()</code> | Destructor applied to every element of <code>a</code> .                                          |
| <code>begin()</code>            | Returns an iterator to the first element.                                                        |
| <code>end()</code>              | Returns an iterator to past the end.                                                             |
| <code>cbegin()</code>           | Returns a <code>const</code> iterator to the first element.                                      |
| <code>chend()</code>            | Returns a <code>const</code> iterator to past the end.                                           |
| <code>size()</code>             | Returns the number of elements.                                                                  |
| <code>maxsize()</code>          | Returns the size of the largest possible container.                                              |
| <code>empty()</code>            | Returns <code>true</code> if the container is empty.                                             |

Table G.2 Operations Defined for All Containers

| Operation           | Description                                                                                                 |
|---------------------|-------------------------------------------------------------------------------------------------------------|
| <code>swap()</code> | Swaps the contents of two containers.                                                                       |
| <code>==</code>     | Returns <code>true</code> if two containers are the same size and have the same elements in the same order. |
| <code>!=</code>     | <code>a != b</code> returns <code>!(a == b)</code> .                                                        |

Containers that use a bi-directional or random iterator (`vector`, `list`, `deque`, `queue`, `array`, `set`, and `map`) are reversible and provide the methods in Table G.3.

Table G.3 Types and Operations Defined for Reversible Containers

| Operation                              | Description                                                                        |
|----------------------------------------|------------------------------------------------------------------------------------|
| <code>X::reverse_iterator</code>       | Reverse iterator that points to type <code>T</code> .                              |
| <code>X::const_reverse_iterator</code> | <code>const</code> reverse iterator that points to type <code>T</code> .           |
| <code>a.rbegin()</code>                | Returns a reverse iterator to past the end of <code>a</code> .                     |
| <code>a.rend()</code>                  | Returns a reverse iterator to the beginning of <code>a</code> .                    |
| <code>a.crbegin()</code>               | Returns a <code>const</code> reverse iterator to past the end of <code>a</code> .  |
| <code>a.crend()</code>                 | Returns a <code>const</code> reverse iterator to the beginning of <code>a</code> . |

The unordered set and unordered map containers are not required to support the optional container operations in Table G.4, but the remaining containers do support them.

Table G.4 Optional Container Operations

| Operation          | Description                                                                                                   |
|--------------------|---------------------------------------------------------------------------------------------------------------|
| <code>&lt;</code>  | <code>a &lt; b</code> returns <code>true</code> if <code>a</code> lexicographically precedes <code>b</code> . |
| <code>&gt;</code>  | <code>a &gt; b</code> returns <code>b &lt; a</code> .                                                         |
| <code>&lt;=</code> | <code>a &lt;= b</code> returns <code>!(a &gt; b)</code> .                                                     |
| <code>&gt;=</code> | <code>a &gt;= b</code> returns <code>!(a &lt; b)</code> .                                                     |

The `>` operator for a container assumes that the `>` operator is defined for the value type. A lexicographic comparison is a generalization of alphabetical sorting. It compares two containers, element-by-element, until it encounters an element in one container that doesn't equal the corresponding element in the other container. In that case, the containers are considered to be in the same order as the noncorresponding pair of elements. For example, if two containers are identical through the first 10 elements, but the 11th element in the first container is less than the 11th element in the second container, the first

container precedes the second. If two containers compare equally until one runs out of elements, the shorter container precedes the longer.

## Additional Members for Sequence Containers

The `vector`, `forward_list`, `list`, `deque`, and `array` template classes are all sequence containers, and they all have the methods listed previously, with the exception that `forward_list` isn't reversible and doesn't support the methods of Table G.3. A sequence container, not surprisingly, holds a homogeneous set of items in linear order. If the sequence has a fixed number of elements, `array` is the usual choice. Otherwise, `vector`, which combines the random access of `array` with the ability to add and delete items should be your first recourse. However, if there are frequent additions in the middle of the sequence, consider using `list` or `forward_list`. And if additions and deletions primarily occur at the two ends of the sequence, consider `deque`.

The fixed size of an `array` object prevents `array` from using many of the sequence methods. Table G.5 lists additional methods available for sequence containers other than `array`. (`forward_list` has somewhat different definitions for `resize()`.) Again, `x` is a container type, such as `vector<int>`, and `T` is the type stored in the container, such as `int`. `a` is a value of type `X`. `t` is an lvalue or `const` rvalue of type `X::value_type`. `rv` is a non-`const` rvalue of that same type. `i` and `j` are input iterators. `[i, j)` is a valid range. `il` is an object of type `initializer_list<value_type>`. `p` is a valid `const` iterator to `a`. `q` is a valid dereferenceable `const` iterator to `a`. `[q1, q2)` is a valid range of `const` iterators. `n` is an integer of `X::size_type`. `Args` is a template parameter pack, and `args` is a function parameter pack with the pattern `Args&&`.

Table G.5 Additional Operations Defined for Sequence Containers

| Operation                        | Description                                                                                                                                                                                                                                                                         |
|----------------------------------|-------------------------------------------------------------------------------------------------------------------------------------------------------------------------------------------------------------------------------------------------------------------------------------|
| <code>X(n, t)</code>             | Constructs a sequence container with <code>n</code> copies of <code>t</code> .                                                                                                                                                                                                      |
| <code>X a(n, t)</code>           | Constructs a sequence container <code>a</code> with <code>n</code> copies of <code>t</code> .                                                                                                                                                                                       |
| <code>X(i, j)</code>             | Constructs a sequence container equal to the range <code>[i, j)</code> .                                                                                                                                                                                                            |
| <code>X a(i, j)</code>           | Constructs a sequence container <code>a</code> equal to the range <code>[i, j)</code> .                                                                                                                                                                                             |
| <code>X(il);</code>              | Constructs a sequence container initialized to the contents of <code>il</code> .                                                                                                                                                                                                    |
| <code>a = il;</code>             | Copies the values in <code>il</code> to <code>a</code> .                                                                                                                                                                                                                            |
| <code>a.emplace(p, args);</code> | Inserts an object of type <code>T</code> before <code>p</code> using the <code>T</code> constructor with the arguments packed into <code>args</code> .                                                                                                                              |
| <code>a.insert(p, t)</code>      | Inserts a copy of <code>t</code> before <code>p</code> ; returns an iterator pointing to the inserted copy of <code>t</code> . The default value for <code>t</code> is <code>T()</code> —that is, the value used for type <code>T</code> in the absence of explicit initialization. |
| <code>a.insert(p, rv)</code>     | Inserts a copy of <code>rv</code> before <code>p</code> ; returns an iterator pointing to the inserted copy of <code>t</code> ; move semantics may be used.                                                                                                                         |

Table G.5 Additional Operations Defined for Sequence Containers

| Operation                     | Description                                                                                                                                                                                                                                                                                                                        |
|-------------------------------|------------------------------------------------------------------------------------------------------------------------------------------------------------------------------------------------------------------------------------------------------------------------------------------------------------------------------------|
| <code>a.insert(p,n,t)</code>  | Inserts <code>n</code> copies of <code>t</code> before <code>p</code> .                                                                                                                                                                                                                                                            |
| <code>a.insert(p,i,j)</code>  | Inserts copies of the elements in the range <code>[i, j)</code> before <code>p</code> .                                                                                                                                                                                                                                            |
| <code>a.insert(p, il);</code> | Same as <code>a.insert(p, il.begin(), il.end())</code> .                                                                                                                                                                                                                                                                           |
| <code>a.resize(n)</code>      | If <code>n &gt; a.size()</code> , inserts <code>n - a.size()</code> elements before <code>a.end()</code> ; the value used for new elements is the value used for type <code>T</code> in the absence of explicit initialization. If <code>n &lt; a.size()</code> , the elements following the <code>n</code> th element are erased. |
| <code>a.resize(n,t)</code>    | If <code>n &gt; a.size()</code> , inserts <code>n - a.size()</code> copies of <code>t</code> before <code>a.end()</code> . If <code>n &lt; a.size()</code> , the elements following the <code>n</code> th element are erased.                                                                                                      |
| <code>a.assign(i,j)</code>    | Replaces the current contents of <code>a</code> with copies of the elements in the range <code>[i, j)</code> .                                                                                                                                                                                                                     |
| <code>a.assign(n,t)</code>    | Replaces the current contents of <code>a</code> with <code>n</code> copies of <code>t</code> . The default value for <code>t</code> is <code>T()</code> , the value used for type <code>T</code> in the absence of explicit initialization.                                                                                        |
| <code>a.assign(il);</code>    | Same as <code>a.assign(il.begin(), il.end())</code> .                                                                                                                                                                                                                                                                              |
| <code>a.erase(q)</code>       | Erases the element pointed to by <code>q</code> ; returns an iterator to the element that had followed <code>q</code> .                                                                                                                                                                                                            |
| <code>a.erase(q1,q2)</code>   | Erases the elements in the range <code>[q1, q2)</code> ; returns an iterator pointing to the element that <code>q2</code> originally pointed to.                                                                                                                                                                                   |
| <code>a.clear()</code>        | Does the same thing as <code>erase(a.begin(), a.end())</code> .                                                                                                                                                                                                                                                                    |
| <code>a.front()</code>        | Returns <code>*a.begin()</code> (the first element).                                                                                                                                                                                                                                                                               |

Table G.6 lists methods common to some of the sequence classes (`vector`, `forward_list`, `list`, and `deque`).

Table G.6 Operations Defined for Some Sequences

| Operation                    | Description                                                                  | Container                                                    |
|------------------------------|------------------------------------------------------------------------------|--------------------------------------------------------------|
| <code>a.back()</code>        | Returns <code>*--a.end()</code> (the last element).                          | <code>vector</code> , <code>list</code> , <code>deque</code> |
| <code>a.push_back(t)</code>  | Inserts <code>t</code> before <code>a.end()</code> .                         | <code>vector</code> , <code>list</code> , <code>deque</code> |
| <code>a.push_back(rv)</code> | Inserts <code>t</code> before <code>a.end()</code> . May use move semantics. | <code>vector</code> , <code>list</code> , <code>deque</code> |
| <code>a.pop_back()</code>    | Erases the last element.                                                     | <code>vector</code> , <code>list</code> , <code>deque</code> |

Table G.6 Operations Defined for Some Sequences

| Operation                         | Description                                                                                                                                   | Container                                                          |
|-----------------------------------|-----------------------------------------------------------------------------------------------------------------------------------------------|--------------------------------------------------------------------|
| <code>a.emplace_back(args)</code> | Appends an object of type <code>T</code> using the <code>T</code> constructor with the arguments packed into <code>args</code> .              | <code>vector</code> , <code>list</code> , <code>deque</code>       |
| <code>a.push_front(t)</code>      | Inserts a copy of <code>t</code> before the first element.                                                                                    | <code>forward_list</code> , <code>list</code> , <code>deque</code> |
| <code>a.push_front(rv)</code>     | Inserts a copy of <code>rv</code> before the first element. Move semantics may be used.                                                       | <code>forward_list</code> , <code>list</code> , <code>deque</code> |
| <code>a.emplace_front()</code>    | Inserts in the front an object of type <code>T</code> using the <code>T</code> constructor with the arguments packed into <code>args</code> . | <code>forward_list</code> , <code>list</code> , <code>deque</code> |
| <code>a.pop_front()</code>        | Erases the first element.                                                                                                                     | <code>forward_list</code> , <code>list</code> ,                    |
| <code>a[n]</code>                 | Returns <code>*(a.begin() + n)</code> .                                                                                                       | <code>vector</code> , <code>deque</code> , <code>array</code>      |
| <code>a.at(n)</code>              | Returns <code>*(a.begin() + n)</code> ; throws <code>out_of_range</code> exception if <code>n &gt; a.size()</code> .                          | <code>vector</code> , <code>deque</code> , <code>array</code>      |

The `vector` template additionally has the methods in Table G.7. Here, `a` is a vector container and `n` is an integer of `X::size_type`.

Table G.7 Additional Operations for Vectors

| Operation                 | Description                                                                                                                                                                                                                                                                                                                                                               |
|---------------------------|---------------------------------------------------------------------------------------------------------------------------------------------------------------------------------------------------------------------------------------------------------------------------------------------------------------------------------------------------------------------------|
| <code>a.capacity()</code> | Returns the total number of elements the vector can hold without requiring reallocation.                                                                                                                                                                                                                                                                                  |
| <code>a.reserve(n)</code> | Alerts object <code>a</code> that memory for at least <code>n</code> elements is needed. After the method call, the capacity will be at least <code>n</code> elements. Reallocation occurs if <code>n</code> is greater than the current capacity. If <code>n</code> is greater than <code>a.max_size()</code> , the method throws a <code>length_error</code> exception. |

The `list` template additionally has the methods in Table G.8. Here, `a` and `b` are `list` containers, and `T` is the type stored in the list, such as `int`, `t` is a value of type `T`, `i` and `j` are input iterators, `q2` and `p` are iterators, `q` and `q1` are dereferenceable iterators, and `n` is an integer of `X::size_type`. The table uses the standard STL notation `[i, j)`, meaning the range from `i` up to, but not including, `j`.

Table G.8 Additional Operations for Lists

| Operation                                       | Description                                                                                                                                                                                                                                                                                                           |
|-------------------------------------------------|-----------------------------------------------------------------------------------------------------------------------------------------------------------------------------------------------------------------------------------------------------------------------------------------------------------------------|
| <code>a.splice(p,b)</code>                      | Moves the contents of list <code>b</code> to list <code>a</code> , inserting them before <code>p</code> .                                                                                                                                                                                                             |
| <code>a.splice(p,b,i)</code>                    | Moves the element in list <code>b</code> pointed to by <code>i</code> to before position <code>p</code> in list <code>a</code> .                                                                                                                                                                                      |
| <code>a.splice(p,b,i,j)</code>                  | Moves the elements in the range <code>[i, j)</code> of list <code>b</code> to before position <code>p</code> in list <code>a</code> .                                                                                                                                                                                 |
| <code>a.remove(const T&amp; t)</code>           | Erases all elements in list <code>a</code> that have the value <code>t</code> .                                                                                                                                                                                                                                       |
| <code>a.remove_if(Predicate pred)</code>        | Given that <code>i</code> is an iterator into list <code>a</code> , erases all values for which <code>pred(*i)</code> is true. (Predicate is a Boolean function or function object, as discussed in Chapter 15, “Friends, Exceptions, and More.”)                                                                     |
| <code>a.unique()</code>                         | Erases all but the first element from each group of consecutive equal elements.                                                                                                                                                                                                                                       |
| <code>a.unique(BinaryPredicate bin_pred)</code> | Erases all but the first element from each group of consecutive elements for which <code>bin_pred(*i, *(i - 1))</code> is true. (BinaryPredicate is a Boolean function or function object, as discussed in Chapter 15.)                                                                                               |
| <code>a.merge(b)</code>                         | Merges the contents of list <code>b</code> with list <code>a</code> , using the <code>&lt;</code> operator defined for the value type. If an element in <code>a</code> is equivalent to an element in <code>b</code> , the element from <code>a</code> is placed first. List <code>b</code> is empty after the merge. |
| <code>a.merge(b, Compare comp)</code>           | Merges the contents of list <code>b</code> with list <code>a</code> , using the <code>comp</code> function or function object. If an element in <code>a</code> is equivalent to an element in <code>b</code> , the element from <code>a</code> is placed first. List <code>b</code> is empty after the merge.         |
| <code>a.sort()</code>                           | Sorts list <code>a</code> , using the <code>&lt;</code> operator.                                                                                                                                                                                                                                                     |
| <code>a.sort(Compare comp)</code>               | Sorts list <code>a</code> , using the <code>comp</code> function or function object.                                                                                                                                                                                                                                  |
| <code>a.reverse()</code>                        | Reverses the order of the elements in list <code>a</code> .                                                                                                                                                                                                                                                           |

The forward-list operations are similar. However, because a `forward_list` template class iterator can't go backwards, some methods have to be adjusted. Thus, the `insert()`, `erase()`, and `splice()` methods are replaced with the `insert_after()`, `erase_after()`, and `splice_after()` methods, all of which operate on the position following an iterator position rather than preceding it.

## Additional Operations for Sets and Maps

Associative containers, of which sets and maps are models, have a `key` template parameter and a `compare` template parameter, which indicate, respectively, the type of the `key` used to order the contents and the function object, termed a *comparison object*, used to compare key values. For the `set` and `multiset` containers, the stored keys are the stored values, so the key type is the same as the value type. For the `map` and `multimap` containers, the stored values of one type (template parameter `T`) are associated with a key type (template parameter `Key`), and the value type is `pair<const Key, T>`. Associative containers have additional members to describe these features, as listed in Table G.9.

Table G.9 Types Defined for Associative Containers

| Type                          | Value                                                                                                                                                                                                                                                        |
|-------------------------------|--------------------------------------------------------------------------------------------------------------------------------------------------------------------------------------------------------------------------------------------------------------|
| <code>X::key_type</code>      | <code>Key</code> , the key type                                                                                                                                                                                                                              |
| <code>X::key_compare</code>   | <code>Compare</code> , which has a default value of <code>less&lt;key_type&gt;</code>                                                                                                                                                                        |
| <code>X::value_compare</code> | A binary predicate type that is the same as <code>key_compare</code> for <code>set</code> and <code>multiset</code> and that supplies ordering for the <code>pair&lt;const Key, T&gt;</code> values in a <code>map</code> or <code>multimap</code> container |
| <code>X::mapped_type</code>   | <code>T</code> , the type of the associated data ( <code>map</code> and <code>multimap</code> only)                                                                                                                                                          |

Associative containers provide the methods listed in Table G.10. In general, the comparison object need not require that values with the same key be identical; the term *equivalent keys* means that two values, which may or may not be equal, have the same key. In the table, `x` is a container class, and `a` is an object of type `x`. If `x` uses unique keys (that is, is `set` or `map`), `a_uniq` is an object of type `x`. If `x` uses multiple keys (that is, is `multiset` or `multimap`), `a_eq` is an object of type `x`. As before, `i` and `j` are input iterators referring to elements of `value_type`, `[i, j)` is a valid range, `p` and `q2` are iterators to `a`, `q` and `q1` are dereferenceable iterators to `a`, `[q1, q2)` is a valid range, `t` is a value of `X::value_type` (which may be a pair), and `k` is a value of `X::key_type`. Also `il` is an `initializer_list<value_type>` object.



Table G.10 Operations Defined for Sets, Multisets, Maps, and Multimaps

| Operation                         | Description                                                                                                                                                                                                                                                                                                                                                                                                                                         |
|-----------------------------------|-----------------------------------------------------------------------------------------------------------------------------------------------------------------------------------------------------------------------------------------------------------------------------------------------------------------------------------------------------------------------------------------------------------------------------------------------------|
| <code>X(i, j, c)</code>           | Constructs an empty container, inserts the elements from the range <code>[i, j)</code> , and uses <code>c</code> as the comparison object.                                                                                                                                                                                                                                                                                                          |
| <code>X a(i, j, c)</code>         | Constructs an empty container ( <code>a</code> ), inserts the elements from the range <code>[i, j)</code> , and uses <code>c</code> as the comparison object.                                                                                                                                                                                                                                                                                       |
| <code>X(i, j)</code>              | Constructs an empty container, inserts the elements from the range <code>[i, j)</code> , and uses <code>Compare()</code> as the comparison object.                                                                                                                                                                                                                                                                                                  |
| <code>X a(i, j)</code>            | Constructs an empty container ( <code>a</code> ), inserts the elements from the range <code>[i, j)</code> , and uses <code>Compare()</code> as the comparison object.                                                                                                                                                                                                                                                                               |
| <code>X(il);</code>               | Same as <code>X(il.begin(), il.end())</code> .                                                                                                                                                                                                                                                                                                                                                                                                      |
| <code>a = il</code>               | Assigns the range <code>il.begin(), il.end()</code> to <code>a</code> .                                                                                                                                                                                                                                                                                                                                                                             |
| <code>a.key_comp()</code>         | Returns the comparison object used in constructing <code>a</code> .                                                                                                                                                                                                                                                                                                                                                                                 |
| <code>a.value_comp()</code>       | Returns an object of the <code>value_compare</code> type.                                                                                                                                                                                                                                                                                                                                                                                           |
| <code>a_uniq.insert(t)</code>     | Inserts the value <code>t</code> into the container <code>a</code> if and only if <code>a</code> does not yet contain a value with an equivalent key. The method returns a value of type <code>pair&lt;iterator, bool&gt;</code> . The <code>bool</code> component is <code>true</code> if insertion occurred and <code>false</code> otherwise. The iterator component points to the element whose key is equivalent to the key of <code>t</code> . |
| <code>a_eq.insert(t)</code>       | Inserts <code>t</code> and returns an iterator that points to its location.                                                                                                                                                                                                                                                                                                                                                                         |
| <code>a.insert(p, t)</code>       | Inserts <code>t</code> , using <code>p</code> as a hint to where <code>insert()</code> should begin its search. If <code>a</code> is a container with unique keys, insertion takes place if and only if <code>a</code> doesn't contain an element with an equivalent key; otherwise, insertion takes place. Whether or not insertion takes place, the method returns an iterator that points to the location with an equivalent key.                |
| <code>a.insert(i, j)</code>       | Inserts elements from the range <code>[i, j)</code> into <code>a</code> .                                                                                                                                                                                                                                                                                                                                                                           |
| <code>a.insert(il)</code>         | Inserts elements from the <code>initializer_list</code> <code>il</code> into <code>a</code> .                                                                                                                                                                                                                                                                                                                                                       |
| <code>a_uniq.emplace(args)</code> | Like <code>a_uniq.insert(t)</code> , but uses the <code>T</code> constructor whose parameter list matches the contents of the <code>args</code> parameter pack.                                                                                                                                                                                                                                                                                     |
| <code>a_eq.emplace(args)</code>   | Like <code>a_eq.insert(t)</code> , but uses the <code>T</code> constructor whose parameter list matches the contents of the <code>args</code> parameter pack.                                                                                                                                                                                                                                                                                       |
| <code>a.emplace_hint(args)</code> | Like <code>a.insert(p, t)</code> , but uses the <code>T</code> constructor whose parameter list matches the contents of the <code>args</code> parameter pack.                                                                                                                                                                                                                                                                                       |
| <code>a.erase(k)</code>           | Erases all elements in <code>a</code> whose keys are equivalent to <code>k</code> and returns the number of elements erased.                                                                                                                                                                                                                                                                                                                        |

Table G.10 Operations Defined for Sets, Multisets, Maps, and Multimaps

| Operation                     | Description                                                                                                                                         |
|-------------------------------|-----------------------------------------------------------------------------------------------------------------------------------------------------|
| <code>a.erase(q)</code>       | Erases the element pointed to by <code>q</code> .                                                                                                   |
| <code>a.erase(q1, q2)</code>  | Erases the elements in the range <code>[q1, q2)</code> .                                                                                            |
| <code>a.clear()</code>        | Does the same thing as <code>erase(a.begin(), a.end())</code> .                                                                                     |
| <code>a.find(k)</code>        | Returns an iterator that points to an element whose key is equivalent to <code>k</code> ; returns <code>a.end()</code> if no such element is found. |
| <code>a.count(k)</code>       | Returns the number of elements that have keys equivalent to <code>k</code> .                                                                        |
| <code>a.lower_bound(k)</code> | Returns an iterator to the first element that have a key not less than <code>k</code> .                                                             |
| <code>a.upper_bound(k)</code> | Returns an iterator to the first element that have a key greater than <code>k</code> .                                                              |
| <code>a.equal_range(k)</code> | Returns a pair whose first member is <code>a.lower_bound(k)</code> and whose second member is <code>a.upper_bound(k)</code> .                       |
| <code>a.operator[] (k)</code> | Returns a reference to the value associated with the key <code>k</code> (map containers only).                                                      |

## Unordered Associative Containers (C++11)

As mentioned earlier, the unordered associative containers (`unordered_set`, `unordered_multiset`, `unordered_map`, and `unordered_multimap`) use keys and hash tables to provide rapid access to data. Let's take a simple look at these concepts. A *hash function* converts a key to an index value. For example, if the key were a `string`, the hash function could sum the numeric codes for the characters in the `string` and take that sum modulus 13, thus giving an index in the range 0–12. The unordered container would use 13 *buckets* to store `strings`. Any `string` with, say, an index of 4 would be placed in bucket 4. If you wished to search the container for a key, you would apply the hash function to the key and just search the bucket with the corresponding index. Ideally, you would have enough buckets that each one would contain only a few `strings`.

The C++11 library provides a `hash<Key>` template that the unordered associative containers use by default. Specializations are defined for the various integer and floating-point types, for pointers, and for some template classes, such as `string`.

Table G.11 lists types used for these containers.

The interface for the unordered associative containers is similar to that of the associative containers. In particular, Table G.10 also applies to the unordered associative containers with the following exceptions: The `lower_bound()` and `upper_bound()` methods are not required, nor is the `x(i, j, c)` constructor. The fact that the regular associative containers are ordered allows them to use a comparison predicate that expresses the “less

than” concept. Such a comparison doesn’t apply to unordered associative containers, so, instead, they use a comparison predicate that is based on the “is equivalent to” concept.

Table G.11 Types Defined for Unordered Associative Containers

| Type                                 | Value                                                                                                                          |
|--------------------------------------|--------------------------------------------------------------------------------------------------------------------------------|
| <code>X::key_type</code>             | Key, the key type                                                                                                              |
| <code>X::key_equal</code>            | Pred, which is a binary predicate that tests if two arguments of type Key are equivalent                                       |
| <code>X::hasher</code>               | Hash, a unary function object type such that if hf is type Hash and k is type Key, then hf(k) is type <code>std::size_t</code> |
| <code>X::local_iterator</code>       | An iterator of the same type as <code>X::iterator</code> but which can be used only within a single bucket                     |
| <code>X::const_local_iterator</code> | An iterator of the same type as <code>X::const_iterator</code> but which can be used only within a single bucket               |
| <code>X::mapped_type</code>          | T, the type of the associated data (map and multimap only)                                                                     |

In addition to the Table G.10 methods, the unordered associative containers require several more methods, as listed in Table G.12. In this table, `X` is an unordered associative container class, `a` is an object of type `X`, `b` is a possibly constant object of type `X`, `a_unique` is an object of type `unordered_set` or `unordered_map`, `a_eq` is an object of type `unordered_multiset` or `unordered_multimap`, `hf` is a value of type `hasher`, `eq` is a value of type `key_equal`, `n` is a value of type `size_type`, and `z` is a value of type `float`. As before, `i` and `j` are input iterators referring to elements of `value_type`, `[i, j)` is a valid range, `p` and `q2` are iterators to `a`, `q` and `q1` are dereferenceable iterators to `a`, `[q1, q2)` is a valid range, `t` is a value of `X::value_type` (which may be a pair), and `k` is a value of `X::key_type`. Also `il` is an `initializer_list<value_type>` object.

Table G.12 Additional Operations Defined for Unordered Sets, Multisets, Maps, and Multimaps

| Operation                   | Description                                                                                                                                                                                                                                                                                                                                                                |
|-----------------------------|----------------------------------------------------------------------------------------------------------------------------------------------------------------------------------------------------------------------------------------------------------------------------------------------------------------------------------------------------------------------------|
| <code>X(n, hf, eq)</code>   | Constructs an empty container with at least <code>n</code> buckets, using <code>hf</code> as the hash function and <code>eq</code> as the key equality predicate. If <code>eq</code> is omitted, <code>key_equal()</code> is used as the key equality predicate. If <code>hf</code> also is omitted, <code>hasher()</code> is used as the hash function.                   |
| <code>X a(n, hf, eq)</code> | Constructs an empty container, <code>a</code> , with at least <code>n</code> buckets, using <code>hf</code> as the hash function and <code>eq</code> as the key equality predicate. If <code>eq</code> is omitted, <code>key_equal()</code> is used as the key equality predicate. If <code>hf</code> also is omitted, <code>hasher()</code> is used as the hash function. |

Table G.12 **Additional Operations Defined for Unordered Sets, Multisets, Maps, and Multimaps**

| Operation                         | Description                                                                                                                                                                                                                                                                                                                                                                                                                                                                                             |
|-----------------------------------|---------------------------------------------------------------------------------------------------------------------------------------------------------------------------------------------------------------------------------------------------------------------------------------------------------------------------------------------------------------------------------------------------------------------------------------------------------------------------------------------------------|
| <code>X(i, j, n, hf, eq)</code>   | Constructs an empty container with at least <code>n</code> buckets, using <code>hf</code> as the hash function and <code>eq</code> as the key equality predicate, and inserts the elements from <code>[i, j)</code> . If <code>eq</code> is omitted, <code>key_equal()</code> is used as the key equality predicate. If <code>hf</code> also is omitted, <code>hasher()</code> is used as the hash function. If <code>n</code> also is omitted, an unspecified number of buckets is used.               |
| <code>X a(i, j, n, hf, eq)</code> | Constructs an empty container <code>a</code> with at least <code>n</code> buckets, using <code>hf</code> as the hash function and <code>eq</code> as the key equality predicate and inserts the elements from <code>[i, j)</code> . If <code>eq</code> is omitted, <code>key_equal()</code> is used as the key equality predicate. If <code>hf</code> also is omitted, <code>hasher()</code> is used as the hash function. If <code>n</code> also is omitted, an unspecified number of buckets is used. |
| <code>b.hash_function()</code>    | Returns the hash function used by <code>b</code> .                                                                                                                                                                                                                                                                                                                                                                                                                                                      |
| <code>b.key_eq()</code>           | Returns the key equality predicate used in constructing <code>b</code> .                                                                                                                                                                                                                                                                                                                                                                                                                                |
| <code>b.bucket_count()</code>     | Returns the number of buckets in <code>b</code> .                                                                                                                                                                                                                                                                                                                                                                                                                                                       |
| <code>b.max_bucket_count()</code> | Returns an upper bound for the number of buckets <code>b</code> might contain.                                                                                                                                                                                                                                                                                                                                                                                                                          |
| <code>b.bucket(k)</code>          | Returns the index of the bucket that would contain an item with a key equivalent to <code>k</code> .                                                                                                                                                                                                                                                                                                                                                                                                    |
| <code>b.bucket_size(n)</code>     | Returns the number of elements in the bucket having index <code>n</code> .                                                                                                                                                                                                                                                                                                                                                                                                                              |
| <code>b.begin(n)</code>           | Returns an iterator to the first element of the bucket having index <code>n</code> .                                                                                                                                                                                                                                                                                                                                                                                                                    |
| <code>b.end(n)</code>             | Returns an iterator to the past-the-end element of the bucket having index <code>n</code> .                                                                                                                                                                                                                                                                                                                                                                                                             |
| <code>b.cbegin(n)</code>          | Returns a constant iterator to the first element of the bucket having index <code>n</code> .                                                                                                                                                                                                                                                                                                                                                                                                            |
| <code>b.cbegin(n)</code>          | Returns a constant iterator to the past-the-end element of the bucket having index <code>n</code> .                                                                                                                                                                                                                                                                                                                                                                                                     |
| <code>b.load_factor()</code>      | Returns the average number of elements per bucket.                                                                                                                                                                                                                                                                                                                                                                                                                                                      |
| <code>b.max_load_factor()</code>  | Returns the value used as an upper limit for the load factor; the container increases the number of buckets if the load factor exceeds this value.                                                                                                                                                                                                                                                                                                                                                      |
| <code>b.max_load_factor(z)</code> | May change the maximum load factor, using <code>z</code> as a hint.                                                                                                                                                                                                                                                                                                                                                                                                                                     |

Table G.12 Additional Operations Defined for Unordered Sets, Multisets, Maps, and Multimaps

| Operation                 | Description                                                                                                                |
|---------------------------|----------------------------------------------------------------------------------------------------------------------------|
| <code>a.rehash(n)</code>  | Resets the bucket count to $\geq n$ with the requirement <code>a.bucket_count() &gt; a.size()/a.max_load_factor()</code> . |
| <code>a.reserve(n)</code> | Same as <code>a.rehash(ceil(n/a.max_load_factor()))</code> , where <code>ceil(x)</code> is the smallest integer $\geq x$ . |

## STL Functions

The STL algorithm library, supported by the `algorithm` and `numeric` header files, provides a large number of nonmember, iterator-based template functions. As discussed in Chapter 16, the template parameter names are chosen to indicate what concept particular parameters should model. For example, `ForwardIterator` is used to indicate that a parameter should, at the minimum, model the requirements of a forward iterator, and `Predicate` is used to indicate a parameter that should be a function object with one argument and a `bool` return value. The C++ Standard divides the algorithms into four groups: nonmodifying sequence operations, mutating sequence operations, sorting and related operators, and numeric operations. (C++11 moves numeric operations from the STL to the numeric library, but that doesn't affect how they are used.) The term *sequence operation* indicates that the function takes a pair of iterators as arguments to define a range, or sequence, to be operated on. The term *mutating* means the function is allowed to alter the container.

### Nonmodifying Sequence Operations

Table G.13 summarizes the nonmodifying sequence operations. Arguments are not shown, and overloaded functions are listed just once. A fuller description, including the prototypes, follows the table. Thus, you can scan the table to get an idea of what a function does and then look up the details if you find the function appealing.

Now let's take a more detailed look at these nonmodifying sequence operations. For each function, the discussion shows the prototype(s), followed by a brief explanation. Pairs of iterators indicate ranges, with the chosen template parameter name indicating the type of iterator. As usual a range in the form `[first, last)` goes from `first` up to, but not including, `last`. Some functions take two ranges, which need not be in the same kind of container. For example, you can use `equal()` to compare a list to a vector. Functions passed as arguments are function objects, which can be pointers (of which function names are an example) or objects for which the `()` operation is defined. As in Chapter 16, a predicate is a Boolean function with one argument, and a binary predicate is a Boolean function with two arguments. (The functions need not be type `bool`, as long as they return 0 for `false` and a nonzero value for `true`.)

Table G.13 Nonmodifying Sequence Operations

| Function                     | Description                                                                                                                                                                         |
|------------------------------|-------------------------------------------------------------------------------------------------------------------------------------------------------------------------------------|
| <code>all_of()</code>        | Returns <code>true</code> if a predicate test is true for all elements. (C++11)                                                                                                     |
| <code>any_of()</code>        | Returns <code>true</code> if a predicate test is true for any element. (C++11)                                                                                                      |
| <code>none_of()</code>       | Returns <code>true</code> if a predicate test is false for all elements. (C++11)                                                                                                    |
| <code>for_each()</code>      | Applies a nonmodifying function object to each element in a range.                                                                                                                  |
| <code>find()</code>          | Finds the first occurrence of a value in a range.                                                                                                                                   |
| <code>find_if()</code>       | Finds the first value that satisfies a predicate test criterion in a range.                                                                                                         |
| <code>find_if_not()</code>   | Finds the first value that doesn't satisfy a predicate test criterion in a range. (C++11)                                                                                           |
| <code>find_end()</code>      | Finds the last occurrence of a subsequence whose values match the values of a second sequence. Matching may be by equality or by applying a binary predicate.                       |
| <code>find_first_of()</code> | Finds the first occurrence of any element of a second sequence that matches a value in the first sequence. Matching may be by equality or may be evaluated with a binary predicate. |
| <code>adjacent_find()</code> | Finds the first element that matches the element immediately following it. Matching may be by equality or may be evaluated with a binary predicate.                                 |
| <code>count()</code>         | Returns the number of times a given value occurs in a range.                                                                                                                        |
| <code>count_if()</code>      | Returns the number of times a given value matches values in a range, with a match determined by using a binary predicate.                                                           |

Table G.13 Nonmodifying Sequence Operations

| Function                      | Description                                                                                                                                                                                                      |
|-------------------------------|------------------------------------------------------------------------------------------------------------------------------------------------------------------------------------------------------------------|
| <code>mismatch()</code>       | Finds the first element in one range that does not match the corresponding element in a second range and returns iterators to both. Matching may be by equality or may be evaluated with a binary predicate.     |
| <code>equal()</code>          | Returns <code>true</code> if each element in one range matches the corresponding element in a second range. Matching may be by equality or may be evaluated with a binary predicate.                             |
| <code>is_permutation()</code> | Returns <code>true</code> if each element in one range matches the corresponding element in some permutation of a second range. Matching may be by equality or may be evaluated with a binary predicate. (C++11) |
| <code>search()</code>         | Finds the first occurrence of a subsequence whose values match the values of a second sequence. Matching may be by equality or by applying a binary predicate.                                                   |
| <code>search_n()</code>       | Finds the first subsequence of <code>n</code> elements that each match a given value. Matching may be by equality or by applying a binary predicate.                                                             |

**`all_of()` (C++11)**

```
template<class InputIterator, class Predicate>
bool all_of(InputIterator first, InputIterator last,
           Predicate pred);
```

The `all_of()` function returns `true` if `pred(*i)` is `true` for every iterator in the range `[first, last)` or if the range is empty. Otherwise the function returns `false`.

**`any_of()` (C++11)**

```
template<class InputIterator, class Predicate>
bool any_of(InputIterator first, InputIterator last,
           Predicate pred);
```

The `any_of()` function returns `false` if `pred(*i)` is `false` for every iterator in the range `[first, last)` or if the range is empty. Otherwise the function returns `true`.

**`none_of()` (C++11)**

```
template<class InputIterator, class Predicate>
bool none_of(InputIterator first, InputIterator last,
            Predicate pred);
```

The `none_of()` function returns `true` if `pred(*i)` is `false` for every iterator in the range `[first, last)` or if the range is empty. Otherwise the function returns `false`.

**for\_each()**

```
template<class InputIterator, class Function>
Function for_each(InputIterator first, InputIterator last,
                 Function f);
```

The `for_each()` function applies function object `f` to each element in the range `[first, last)`. It also returns `f`.

**find()**

```
template<class InputIterator, class T>
InputIterator find(InputIterator first, InputIterator last,
                 const T& value);
```

The `find()` function returns an iterator to the first element in the range `[first, last)` that has the value `value`; it returns `last` if the item is not found.

**find\_if()**

```
template<class InputIterator, class Predicate>
InputIterator find_if(InputIterator first, InputIterator last,
                    Predicate pred);
```

The `find_if()` function returns an iterator `it` to the first element in the range `[first, last)` for which the function object call `pred(*i)` is true; it returns `last` if the item is not found.

**find\_if\_not()**

```
template<class InputIterator, class Predicate>
InputIterator find_if_not(InputIterator first, InputIterator last,
                        Predicate pred);
```

The `find_if_not()` function returns an iterator, `it`, to the first element in the range `[first, last)` for which the function object call `pred(*i)` is false; it returns `last` if the item is not found.

**find\_end()**

```
template<class ForwardIterator1, class ForwardIterator2>
ForwardIterator1 find_end(
    ForwardIterator1 first1, ForwardIterator1 last1,
    ForwardIterator2 first2, ForwardIterator2 last2);
```

```
template<class ForwardIterator1, class ForwardIterator2,
        class BinaryPredicate>
ForwardIterator1 find_end(
    ForwardIterator1 first1, ForwardIterator1 last1,
    ForwardIterator2 first2, ForwardIterator2 last2,
    BinaryPredicate pred);
```



The `find_end()` function returns an iterator `it` to the last element in the range `[first1, last1)` that marks the beginning of a subsequence that matches the contents of the range `[first2, last2)`. The first version uses the `==` operator for the value type to compare elements. The second version uses the binary predicate function object `pred` to compare elements. That is, elements pointed to by `it1` and `it2` match if `pred(*it1, *it2)` is true. Both return `last1` if the item is not found.

### **find\_first\_of()**

```
template<class ForwardIterator1, class ForwardIterator2>
ForwardIterator1 find_first_of(
    ForwardIterator1 first1, ForwardIterator1 last1,
    ForwardIterator2 first2, ForwardIterator2 last2);
```

```
template<class ForwardIterator1, class ForwardIterator2,
        class BinaryPredicate>
ForwardIterator1 find_first_of(
    ForwardIterator1 first1, ForwardIterator1 last1,
    ForwardIterator2 first2, ForwardIterator2 last2,
    BinaryPredicate pred);
```

The `find_first_of()` function returns an iterator `it` to the first element in the range `[first1, last1)` that matches any element of the range `[first2, last2)`. The first version uses the `==` operator for the value type to compare elements. The second version uses the binary predicate function object `pred` to compare elements. That is, elements pointed to by `it1` and `it2` match if `pred(*it1, *it2)` is true. Both return `last1` if the item is not found.

### **adjacent\_find()**

```
template<class ForwardIterator>
ForwardIterator adjacent_find(ForwardIterator first,
    ForwardIterator last);
```

```
template<class ForwardIterator, class BinaryPredicate>
ForwardIterator adjacent_find(ForwardIterator first,
    ForwardIterator last, BinaryPredicate pred);
```

The `adjacent_find()` function returns an iterator `it` to the first element in the range `[first1, last1)` such that the element matches the following element. The function returns `last` if no such pair is found. The first version uses the `==` operator for the value type to compare elements. The second version uses the binary predicate function object `pred` to compare elements. That is, elements pointed to by `it1` and `it2` match if `pred(*it1, *it2)` is true.

**count()**

```
template<class InputIterator, class T>
    typename iterator_traits<InputIterator>::difference_type
    count(InputIterator first, InputIterator last, const T& value);
```

The `count()` function returns the number of elements in the range `[first, last)` that match the value `value`. The `==` operator for the value type is used to compare values. The return type is an integer type that is large enough to contain the maximum number of items the container can hold.

**count\_if()**

```
template<class InputIterator, class Predicate>
    typename iterator_traits<InputIterator>::difference_type
    count_if(InputIterator first, InputIterator last, Predicate pred);
```

The `count_if()` function returns the number of elements in the range `[first, last)` for which the function object `pred` returns a true value when passed the element as an argument.

**mismatch()**

```
template<class InputIterator1, class InputIterator2>
    pair<InputIterator1, InputIterator2>
    mismatch(InputIterator1 first1,
             InputIterator1 last1, InputIterator2 first2);
```

```
template<class InputIterator1, class InputIterator2,
         class BinaryPredicate>
    pair<InputIterator1, InputIterator2>
    mismatch(InputIterator1 first1,
             InputIterator1 last1, InputIterator2 first2,
             BinaryPredicate pred);
```

Each of the `mismatch()` functions finds the first element in the range `[first1, last1)` that doesn't match the corresponding element in the range beginning at `first2` and returns a pair holding iterators to the two mismatching elements. If no mismatch is found, the return value is `pair<last1, first2 + (last1 - first1)>`. The first version uses the `==` operator to test matching. The second version uses the binary predicate function object `pred` to compare elements. That is, elements pointed to by `it1` and `it2` don't match if `pred(*it1, *it2)` is false.

**equal()**

```
template<class InputIterator1, class InputIterator2>
    bool equal(InputIterator1 first1, InputIterator1 last1,
              InputIterator2 first2);
```

```
template<class InputIterator1, class InputIterator2,
        class BinaryPredicate>
bool equal(InputIterator1 first1, InputIterator1 last1,
          InputIterator2 first2, BinaryPredicate pred);
```

The `equal()` function returns `true` if each element in the range `[first1, last1)` matches the corresponding element in the sequence beginning at `first2` and `false` otherwise. The first version uses the `==` operator for the value type to compare elements. The second version uses the binary predicate function object `pred` to compare elements. That is, elements pointed to by `it1` and `it2` match if `pred(*it1, *it2)` is `true`.

### **`is_permutation()` (C++11)**

```
template<class InputIterator1, class InputIterator2>
bool equal(InputIterator1 first1, InputIterator1 last1,
          InputIterator2 first2);

template<class InputIterator1, class InputIterator2,
        class BinaryPredicate>
bool equal(InputIterator1 first1, InputIterator1 last1,
          InputIterator2 first2, BinaryPredicate pred);
```

The `is_permutation()` function returns `true` if each element in the range `[first1, last1)` matches the corresponding element in some permutation of the equal-length sequence beginning at `first2`; it returns `false` otherwise. The first version uses the `==` operator for the value type to compare elements. The second version uses the binary predicate function object `pred` to compare elements. That is, elements pointed to by `it1` and `it2` match if `pred(*it1, *it2)` is `true`.

### **`search()`**

```
template<class ForwardIterator1, class ForwardIterator2>
ForwardIterator1 search(
    ForwardIterator1 first1, ForwardIterator1 last1,
    ForwardIterator2 first2, ForwardIterator2 last2);

template<class ForwardIterator1, class ForwardIterator2,
        class BinaryPredicate>
ForwardIterator1 search(
    ForwardIterator1 first1, ForwardIterator1 last1,
    ForwardIterator2 first2, ForwardIterator2 last2,
    BinaryPredicate pred);
```

The `search()` function finds the first occurrence in the range `[first1, last1)` that matches the corresponding sequence found in the range `[first2, last2)`. It returns `last1` if no such sequence is found. The first version uses the `==` operator for the value type to compare elements. The second version uses the binary predicate function object

`pred` to compare elements. That is, elements pointed to by `it1` and `it2` match if `pred(*it1, *it2)` is true.

### **search\_n()**

```
template<class ForwardIterator, class Size, class T>
ForwardIterator search_n(ForwardIterator first, ForwardIterator last,
                        Size count, const T& value);

template<class ForwardIterator, class Size, class T, class BinaryPredicate>
ForwardIterator search_n(ForwardIterator first, ForwardIterator last,
                        Size count, const T& value, BinaryPredicate pred);
```

The `search_n()` function finds the first occurrence in the range `[first1, last1)` that matches the sequence consisting of `count` consecutive occurrences of `value`. It returns `last1` if no such sequence is found. The first version uses the `==` operator for the value type to compare elements. The second version uses the binary predicate function object `pred` to compare elements. That is, elements pointed to by `it1` and `it2` match if `pred(*it1, *it2)` is true.

## **Mutating Sequence Operations**

Table G.14 summarizes the mutating sequence operations. Arguments are not shown, and overloaded functions are listed just once. A fuller description, including the prototypes, follows the table. Thus, you can scan the table to get an idea of what a function does and then look up the details if you find the function appealing.

Now let's take a more detailed look at these mutating sequence operations. For each function, the discussion shows the prototype(s), followed by a brief explanation. As you saw earlier, pairs of iterators indicate ranges, with the chosen template parameter name indicating the type of iterator. As usual, a range in the form `[first, last)` goes from `first` up to, but not including, `last`. Functions passed as arguments are function objects, which can be function pointers or objects for which the `()` operation is defined. As in Chapter 16, a predicate is a Boolean function with one argument, and a binary predicate is a Boolean function with two arguments. (The functions need not be type `bool`, as long as they return `0` for `false` and a nonzero value for `true`.) Also as in Chapter 16, a unary function object is one that takes a single argument, and a binary function object is one that takes two arguments.

### **copy()**

```
template<class InputIterator, class OutputIterator>
OutputIterator copy(InputIterator first, InputIterator last,
                  OutputIterator result);
```

The `copy()` function copies the elements in the range `[first, last)` into the range `[result, result + (last - first))`. It returns `result + (last - first)`—that is, an

iterator pointing one past the last copied-to location. The function requires that `result` not be in the range `[first, last)`— that is, the target can't overlap the source.

Table G.14 Mutating Sequence Operations

| Function                       | Description                                                                                                                                                                        |
|--------------------------------|------------------------------------------------------------------------------------------------------------------------------------------------------------------------------------|
| <code>copy()</code>            | Copies elements from a range to a location identified by an iterator.                                                                                                              |
| <code>copy_n()</code>          | Copies <code>n</code> elements from one location identified by an iterator to a second location identified by an iterator. (C++11)                                                 |
| <code>copy_if()</code>         | Copies elements satisfying a predicate test from a range to a location identified by an iterator. (C++11)                                                                          |
| <code>copy_backward()</code>   | Copies elements from a range to a location identified by an iterator. Copying begins at the end of the range and proceeds backward.                                                |
| <code>move()</code>            | Moves elements from a range to a location identified by an iterator. (C++11)                                                                                                       |
| <code>move_backward()</code>   | Moves elements from a range to a location identified by an iterator. Moving begins at the end of the range and proceeds backward. (C++11)                                          |
| <code>swap()</code>            | Exchanges two values stored at locations specified by references.                                                                                                                  |
| <code>swap_ranges()</code>     | Exchanges corresponding values in two ranges.                                                                                                                                      |
| <code>iter_swap()</code>       | Exchanges two values stored at locations specified by iterators.                                                                                                                   |
| <code>transform()</code>       | Applies a function object to each element in a range (or to each pair of elements in a pair of ranges) and copies the return value to the corresponding location of another range. |
| <code>replace()</code>         | Replaces each occurrence of a value in a range with another value.                                                                                                                 |
| <code>replace_if()</code>      | Replaces each occurrence of a value in a range with another value if a predicate function object applied to the original value returns <code>true</code> .                         |
| <code>replace_copy()</code>    | Copies one range to another and replaces each occurrence of a specified value with another value.                                                                                  |
| <code>replace_copy_if()</code> | Copies one range to another and replaces each value for which a predicate function object is <code>true</code> with an indicated value.                                            |
| <code>fill()</code>            | Sets each value in a range to an indicated value.                                                                                                                                  |
| <code>fill_n()</code>          | Sets <code>n</code> consecutive elements to a value.                                                                                                                               |
| <code>generate()</code>        | Sets each value in a range to the return value of a generator, which is a function object that takes no arguments.                                                                 |
| <code>generate_n()</code>      | Sets the first <code>n</code> values in a range to the return value of a generator, which is a function object that takes no arguments.                                            |

Table G.14 Mutating Sequence Operations

| Function                        | Description                                                                                                                                                        |
|---------------------------------|--------------------------------------------------------------------------------------------------------------------------------------------------------------------|
| <code>remove()</code>           | Removes all occurrences of an indicated value from a range and returns a past-the-end iterator for the resulting range.                                            |
| <code>remove_if()</code>        | Removes all occurrences of values for which a predicate object returns <code>true</code> from a range and returns a past-the-end iterator for the resulting range. |
| <code>remove_copy()</code>      | Copies elements from one range to another, omitting elements that equal a specified value.                                                                         |
| <code>remove_copy_if()</code>   | Copies elements from one range to another, omitting elements for which a predicate function object returns <code>true</code> .                                     |
| <code>unique()</code>           | Reduces each sequence of two or more equivalent elements in a range to a single element.                                                                           |
| <code>unique_copy()</code>      | Copies elements from one range to another, reducing each sequence of two or more equivalent elements to one.                                                       |
| <code>reverse()</code>          | Reverses the elements in a range.                                                                                                                                  |
| <code>reverse_copy()</code>     | Copies a range in reverse order to a second range.                                                                                                                 |
| <code>rotate()</code>           | Treats a range as a circular ordering and rotates the elements left.                                                                                               |
| <code>rotate_copy()</code>      | Copies one range to another in a rotated order.                                                                                                                    |
| <code>random_shuffle()</code>   | Randomly rearranges the elements in a range.                                                                                                                       |
| <code>shuffle()</code>          | Randomly rearranges the elements in a range using a function object type satisfying C++11 requirements for a uniform random generator. (C++11)                     |
| <code>is_partitioned()</code>   | Returns <code>true</code> if a range is partitioned by a given predicate.                                                                                          |
| <code>partition()</code>        | Places all the elements that satisfy a predicate function object before all elements that don't.                                                                   |
| <code>stable_partition()</code> | Places all the elements that satisfy a predicate function object before all elements that don't. The relative order of elements in each group is preserved.        |
| <code>partition_copy()</code>   | Copies all the elements that satisfy a predicate function object to one output range and the remaining elements to a second output range. (C++11)                  |
| <code>partition_point()</code>  | For a range partitioned by a given predicate, returns an iterator to the first element not satisfying the predicate.                                               |

**copy\_n() (C++11)**

```
template<class InputIterator, class Size class OutputIterator>
OutputIterator copy(InputIterator first, Size n,
                   OutputIterator result);
```

The `copy_n()` function copies `n` elements, starting from the location `first`, into the range `[result, result + n)`. It returns `result + n`—that is, an iterator pointing one past the last copied-to location. The function does not require that the target can't overlap the source.

**copy\_if() (C++11)**

```
template<class InputIterator, class OutputIterator,
         class Predicate>
OutputIterator copy_if(InputIterator first, InputIterator last,
                     OutputIterator result, Predicate pred);
```

The `copy_if()` function copies those elements referred to by the iterator `i` in the range `[first, last)`, for which `pred(*i)` is true, into the range `[result, result + (last - first))`. It returns `result + (last - first)`—that is, an iterator pointing one past the last copied-to location. The function requires that `result` not be in the range `[first, last)`—that is, the target can't overlap the source.

**copy\_backward()**

```
template<class BidirectionalIterator1,
         class BidirectionalIterator2>
BidirectionalIterator2 copy_backward(BidirectionalIterator1 first,
BidirectionalIterator1 last, BidirectionalIterator2 result);
```

The `copy_backward()` function copies the elements in the range `[first, last)` into the range `[result - (last - first), result)`. Copying begins with the element at `last - 1` being copied to location `result - 1` and proceeds backward from there to `first`. It returns `result - (last - first)`—that is, an iterator pointing one past the last copied-to location. The function requires that `result` not be in the range `[first, last)`. However, because copying is done backward, it is possible for the target and source to overlap.

**move() (C++11)**

```
template<class InputIterator, class OutputIterator>
OutputIterator copy(InputIterator first, InputIterator last,
                   OutputIterator result);
```

The `move()` function uses `std::move()` to move the elements in the range `[first, last)` into the range `[result, result + (last - first))`. It returns `result + (last - first)`—that is, an iterator pointing one past the last copied-to location. The function

requires that `result` not be in the range `[first, last)`—that is, the target can't overlap the source.

### **move\_backward() (C++11)**

```
template<class BidirectionalIterator1,
         class BidirectionalIterator2>
BidirectionalIterator2 copy_backward(BidirectionalIterator1 first,
BidirectionalIterator1 last, BidirectionalIterator2 result);
```

The `move_backward()` function uses `std::move()` to move the elements in the range `[first, last)` into the range `[result - (last - first), result)`. Copying begins with the element at `last - 1` being copied to location `result - 1` and proceeds backward from there to `first`. It returns `result - (last - first)`—that is, an iterator pointing one past the last copied-to location. The function requires that `result` not be in the range `[first, last)`. However, because copying is done backward, it is possible for the target and source to overlap.

### **swap()**

```
template<class T> void swap(T& a, T& b);
```

The `swap()` function exchanges values stored at two locations specified by references. (C++ moves this function to the utility header file.)

### **swap\_ranges()**

```
template<class ForwardIterator1, class ForwardIterator2>
ForwardIterator2 swap_ranges(
    ForwardIterator1 first1, ForwardIterator1 last1,
    ForwardIterator2 first2);
```

The `swap_ranges()` function exchanges values in the range `[first1, last1)` with the corresponding values in the range beginning at `first2`. The two ranges should not overlap.

### **iter\_swap()**

```
template<class ForwardIterator1, class ForwardIterator2>
void iter_swap(ForwardIterator1 a, ForwardIterator2 b);
```

The `iter_swap()` function exchanges values stored at two locations specified by iterators.

### **transform()**

```
template<class InputIterator, class OutputIterator, class UnaryOperation>
OutputIterator transform(InputIterator first, InputIterator last,
OutputIterator result, UnaryOperation op);
```



```

template<class InputIterator1, class InputIterator2, class OutputIterator,
        class BinaryOperation>
OutputIterator transform(InputIterator1 first1, InputIterator1 last1,
                        InputIterator2 first2, OutputIterator result,
                        BinaryOperation binary_op);

```

The first version of `transform()` applies the unary function object `op` to each element in the range `[first, last)` and assigns the return value to the corresponding element in the range beginning at `result`. So `*result` is set to `op(*first)`, and so on. It returns `result + (last - first)`—that is, the past-the-end value for the target range.

The second version of `transform()` applies the binary function object `op` to each element in the range `[first1, last1)` and to each element in the range `[first2, last2)` and assigns the return value to the corresponding element in the range beginning at `result`. So `*result` is set to `op(*first1, *first2)`, and so on. It returns `result + (last - first)`, the past-the-end value for the target range.

### **replace()**

```

template<class ForwardIterator, class T>
void replace(ForwardIterator first, ForwardIterator last,
            const T& old_value, const T& new_value);

```

The `replace()` function replaces each occurrence of the value `old_value` in the range `[first, last)` with the value `new_value`.

### **replace\_if()**

```

template<class ForwardIterator, class Predicate, class T>
void replace_if(ForwardIterator first, ForwardIterator last,
               Predicate pred, const T& new_value);

```

The `replace_if()` function replaces each value `old` in the range `[first, last)` for which `pred(old)` is true with the value `new_value`.

### **replace\_copy()**

```

template<class InputIterator, class OutputIterator, class T>
OutputIterator replace_copy(InputIterator first, InputIterator last,
                           OutputIterator result, const T& old_value, const T& new_value);

```

The `replace_copy()` function copies the elements in the range `[first, last)` to a range beginning at `result` but substituting `new_value` for each occurrence of `old_value`. It returns `result + (last - first)`, the past-the-end value for the target range.

### **replace\_copy\_if()**

```

template<class Iterator, class OutputIterator, class Predicate, class T>
OutputIterator replace_copy_if(Iterator first, Iterator last,
                               OutputIterator result, Predicate pred, const T& new_value);

```

The `replace_copy_if()` function copies the elements in the range `[first, last)` to a range beginning at `result` but substituting `new_value` for each value `old` for which `pred(old)` is true. It returns `result + (last - first)`, the past-the-end value for the target range.

### **fill()**

```
template<class ForwardIterator, class T>
void fill(ForwardIterator first, ForwardIterator last, const T& value);
```

The `fill()` function sets each element in the range `[first, last)` to `value`.

### **fill\_n()**

```
template<class OutputIterator, class Size, class T>
void fill_n(OutputIterator first, Size n, const T& value);
```

The `fill_n()` function sets each of the first `n` elements beginning at location `first` to `value`.

### **generate()**

```
template<class ForwardIterator, class Generator>
void generate(ForwardIterator first, ForwardIterator last, Generator gen);
```

The `generate()` function sets each element in the range `[first, last)` to `gen()`, where `gen` is a generator function object—that is, one that takes no arguments. For example, `gen` can be a pointer to `rand()`.

### **generate\_n()**

```
template<class OutputIterator, class Size, class Generator>
void generate_n(OutputIterator first, Size n, Generator gen);
```

The `generate_n()` function sets each of the first `n` elements in the range beginning at `first` to `gen()`, where `gen` is a generator function object—that is, one that takes no arguments. For example, `gen` can be a pointer to `rand()`.

### **remove()**

```
template<class ForwardIterator, class T>
ForwardIterator remove(ForwardIterator first, ForwardIterator last,
                      const T& value);
```

The `remove()` function removes all occurrences of `value` from the range `[first, last)` and returns a past-the-end iterator for the resulting range. The function is stable, meaning that the order of the unremoved elements is unaltered.

**Note**

Because the various `remove()` and `unique()` functions are not member functions, and also because they aren't restricted to STL containers, they can't reset the size of a container. Instead, they return an iterator that indicates the new past-the-end location. Typically, the removed items are simply shifted to the end of the container. However, for STL containers, you can use the returned iterator and one of the `erase()` methods to reset `end()`.

**remove\_if()**

```
template<class ForwardIterator, class Predicate>
ForwardIterator remove_if(ForwardIterator first, ForwardIterator last,
                          Predicate pred);
```

The `remove_if()` function removes all occurrences of values `val` for which `pred(val)` is true from the range `[first, last)` and returns a past-the-end iterator for the resulting range. The function is stable, meaning that the order of the unremoved elements is unaltered.

**remove\_copy()**

```
template<class InputIterator, class OutputIterator, class T>
OutputIterator remove_copy(InputIterator first, InputIterator last,
                           OutputIterator result, const T& value);
```

The `remove_copy()` function copies values from the range `[first, last)` to the range beginning at `result`, skipping instances of `value` as it copies. It returns a past-the-end iterator for the resulting range. The function is stable, meaning that the order of the unremoved elements is unaltered.

**remove\_copy\_if()**

```
template<class InputIterator, class OutputIterator, class Predicate>
OutputIterator remove_copy_if(InputIterator first, InputIterator last,
                              OutputIterator result, Predicate pred);
```

The `remove_copy_if()` function copies values from the range `[first, last)` to the range beginning at `result`, skipping instances of `val` for which `pred(val)` is true as it copies. It returns a past-the-end iterator for the resulting range. The function is stable, meaning that the order of the unremoved elements is unaltered.

**unique()**

```
template<class ForwardIterator>
ForwardIterator unique(ForwardIterator first, ForwardIterator last);

template<class ForwardIterator, class BinaryPredicate>
ForwardIterator unique(ForwardIterator first, ForwardIterator last,
                      BinaryPredicate pred);
```

The `unique()` function reduces each sequence of two or more equivalent elements in the range `[first, last)` to a single element and returns a past-the-end iterator for the new range. The first version uses the `==` operator for the value type to compare elements. The second version uses the binary predicate function object `pred` to compare elements. That is, elements pointed to by `it1` and `it2` match if `pred(*it1, *it2)` is true.

### **unique\_copy()**

```
template<class InputIterator, class OutputIterator>
OutputIterator unique_copy(InputIterator first, InputIterator last,
                          OutputIterator result);
```

```
template<class InputIterator, class OutputIterator, class BinaryPredicate>
OutputIterator unique_copy(InputIterator first, InputIterator last,
                          OutputIterator result, BinaryPredicate pred);
```

The `unique_copy()` function copies elements from the range `[first, last)` to the range beginning at `result`, reducing each sequence of two or more identical elements to a single element. It returns a past-the-end iterator for the new range. The first version uses the `==` operator for the value type to compare elements. The second version uses the binary predicate function object `pred` to compare elements. That is, elements pointed to by `it1` and `it2` match if `pred(*it1, *it2)` is true.

### **reverse()**

```
template<class BidirectionalIterator>
void reverse(BidirectionalIterator first, BidirectionalIterator last);
```

The `reverse()` function reverses the elements in the range `[first, last)` by invoking `swap(first, last - 1)`, and so on.

### **reverse\_copy()**

```
template<class BidirectionalIterator, class OutputIterator>
OutputIterator reverse_copy(BidirectionalIterator first,
                           BidirectionalIterator last,
                           OutputIterator result);
```

The `reverse_copy()` function copies the elements in the range `[first, last)` to the range beginning at `result` in reverse order. The two ranges should not overlap.

### **rotate()**

```
template<class ForwardIterator>
void rotate(ForwardIterator first, ForwardIterator middle,
           ForwardIterator last);
```

The `rotate()` function performs a left rotation on the elements in the range `[first, last)`. The element at `middle` is moved to `first`, the element at `middle + 1` is moved to



The `is_partitioned()` function returns `true` if the range is empty or if it is partitioned by `pred`—that is, arranged so that all elements satisfying `pred` precede all those that do not. Otherwise, the function returns `false`.

### **partition()**

```
template<class BidirectionalIterator, class Predicate>
BidirectionalIterator partition(BidirectionalIterator first,
                               BidirectionalIterator last,
                               Predicate pred);
```

The `partition()` function places each element whose value `val` is such that `pred(val)` is `true` before all elements that don't meet that test. It returns an iterator to the position following the last position holding a value for which the predicate object function was `true`.

### **stable\_partition()**

```
template<class BidirectionalIterator, class Predicate>
BidirectionalIterator stable_partition(BidirectionalIterator first,
                                      BidirectionalIterator last,
                                      Predicate pred);
```

The `stable_partition()` function places each element whose value `val` is such that `pred(val)` is `true` before all elements that don't meet that test. This function preserves the relative ordering within each of the two groups. It returns an iterator to the position following the last position holding a value for which the predicate object function was `true`.

### **partition\_copy() (C++11)**

```
template<class InputIterator, class OutputIterator1,
        class OutputIterator2, class Predicate>
pair<OutputIterator1, OutputIterator2> partition_copy(
    InputIterator first, InputIterator last,
    OutputIterator1 out_true, OutputIterator2 out_false,
    Predicate pred);
```

The `partition_copy()` function copies each element whose value `val` is such that `pred(val)` is `true` to the range beginning with `out_true` and the remaining elements to the range beginning with `out_false`. It returns a `pair` object containing an iterator to the end of the range that begins with `out_true` and an iterator to the end of the range that begins with `out_false`.

### **partition\_point() (C++11)**

```
template<class ForwardIterator, class Predicate>
ForwardIterator partition_point(ForwardIterator first,
                               ForwardIterator last,
                               Predicate pred);
```

The `partition_point()` function requires that the range be partitioned by `pred`. It returns an iterator to the position following the last position holding a value for which the predicate object function was `true`.

## Sorting and Related Operations

Table G.15 summarizes the sorting and related operations. Arguments are not shown, and overloaded functions are listed just once. Each function has a version that uses `<` for ordering elements and a version that uses a comparison function object for ordering elements. A fuller description, including the prototypes, follows the table. Thus, you can scan the table to get an idea of what a function does and then look up the details if you find the function appealing.

Table G.15 **Sorting and Related Operations**

| Function                         | Description                                                                                                                                                        |
|----------------------------------|--------------------------------------------------------------------------------------------------------------------------------------------------------------------|
| <code>sort()</code>              | Sorts a range.                                                                                                                                                     |
| <code>stable_sort()</code>       | Sorts a range, preserving the relative order of equivalent elements.                                                                                               |
| <code>partial_sort()</code>      | Partially sorts a range, providing the first <code>n</code> elements of a full sort.                                                                               |
| <code>partial_sort_copy()</code> | Copies a partially sorted range to another range.                                                                                                                  |
| <code>is_sorted()</code>         | Returns <code>true</code> if the range is sorted. (C++11)                                                                                                          |
| <code>is_sorted_until()</code>   | Returns the last iterator for which a range is sorted. (C++11)                                                                                                     |
| <code>nth_element()</code>       | Given an iterator into a range, finds the element that would be there if the range were sorted and places that element there.                                      |
| <code>lower_bound()</code>       | Given a value, finds the first position in a sorted range before which the value can be inserted while maintaining the ordering.                                   |
| <code>upper_bound()</code>       | Given a value, finds the last position in a sorted range before which the value can be inserted while maintaining the ordering.                                    |
| <code>equal_range()</code>       | Given a value, finds the largest subrange of a sorted range such that the value can be inserted before any element in the subrange without violating the ordering. |
| <code>binary_search()</code>     | Returns <code>true</code> if a sorted range contains a value that is equivalent to a given value; returns <code>false</code> otherwise.                            |

Table G.15 **Sorting and Related Operations**

| Function                                | Description                                                                                                                                                                                        |
|-----------------------------------------|----------------------------------------------------------------------------------------------------------------------------------------------------------------------------------------------------|
| <code>merge()</code>                    | Merges two sorted ranges into a third range.                                                                                                                                                       |
| <code>inplace_merge()</code>            | Merges two consecutive sorted ranges in place.                                                                                                                                                     |
| <code>includes()</code>                 | Returns <code>true</code> if every element in one set is also found in another set.                                                                                                                |
| <code>set_union()</code>                | Constructs the union of two sets—that is, a set that contains all elements present in each set.                                                                                                    |
| <code>set_intersection()</code>         | Constructs the intersection of two sets—that is, a set that contains only those elements found in both sets.                                                                                       |
| <code>set_difference()</code>           | Constructs the difference of two sets—that is, a set that contains only those elements found in the first set but not the second.                                                                  |
| <code>set_symmetric_difference()</code> | Constructs a set that contains elements found in one set or the other, but not both.                                                                                                               |
| <code>make_heap</code>                  | Converts a range to a heap.                                                                                                                                                                        |
| <code>push_heap()</code>                | Adds an element to a heap.                                                                                                                                                                         |
| <code>pop_heap()</code>                 | Removes the largest element from a heap.                                                                                                                                                           |
| <code>sort_heap()</code>                | Sorts a heap.                                                                                                                                                                                      |
| <code>is_heap()</code>                  | Returns <code>true</code> if a range is a heap. (C++11)                                                                                                                                            |
| <code>is_heap_until()</code>            | Returns the last iterator for which a range is a heap. (C++11)                                                                                                                                     |
| <code>min()</code>                      | Returns the lesser of two values or the smallest item in an <code>initializer_list</code> object. (C++11)                                                                                          |
| <code>max()</code>                      | Returns the larger of two values or the largest item in an <code>initializer_list</code> argument. (C++11)                                                                                         |
| <code>minmax()</code>                   | Returns a <code>pair</code> object containing the values of two arguments in order of increasing size or the smallest and largest items in an <code>initializer_list</code> argument. (C++11)      |
| <code>min_element()</code>              | Finds the first occurrence of the smallest value in a range.                                                                                                                                       |
| <code>max_element()</code>              | Finds the first occurrence of the largest value in a range.                                                                                                                                        |
| <code>minmax_element()</code>           | Returns a <code>pair</code> object containing an iterator to the first occurrence of the smallest value in a range and an iterator to the last occurrence of the largest value in a range. (C++11) |



Table G.15 **Sorting and Related Operations**

| Function                             | Description                                                                                                                                                             |
|--------------------------------------|-------------------------------------------------------------------------------------------------------------------------------------------------------------------------|
| <code>lexicographic_compare()</code> | Compares two sequences lexicographically, returning <code>true</code> if the first sequence is lexicographically less than the second and <code>false</code> otherwise. |
| <code>next_permutation()</code>      | Generates the next permutation in a sequence.                                                                                                                           |
| <code>previous_permutation()</code>  | Generates the preceding permutation in a sequence.                                                                                                                      |

The functions in this section determine the order of two elements by using the `<` operator defined for the elements or by using a comparison object designated by the template type `Compare`. If `comp` is an object of type `Compare`, then `comp(a, b)` is a generalization of `a < b` and returns `true` if `a` precedes `b` in the ordering scheme. If `a < b` is `false` and `b < a` is also `false`, `a` and `b` are equivalent. A comparison object must provide at least *strict weak ordering*. This means the following:

- The expression `comp(a, a)` must be `false`, a generalization of the fact that a value can't be less than itself. (This is the strict part.)
- If `comp(a, b)` is `true` and `comp(b, c)` is `true`, then `comp(a, c)` is `true` (that is, comparison is a transitive relationship).
- If `a` is equivalent to `b` and `b` is equivalent to `c`, then `a` is equivalent to `c` (that is, equivalency is a transitive relationship).

If you think of applying `<` to integers, then equivalency implies equality, but this doesn't have to hold for more general cases. For example, you could define a structure with several members describing a mailing address and define a `comp` comparison object that orders the structures according to zip code. Then any two addresses with the same zip code would be equivalent but not equal.

Now let's take a more detailed look at these sorting and related operations. For each function, the discussion shows the prototype(s), followed by a brief explanation. This section is divided into several subsections. As you saw earlier, pairs of iterators indicate ranges, with the chosen template parameter name indicating the type of iterator. As usual, a range in the form `[first, last)` goes from `first` up to, but not including, `last`. Functions passed as arguments are function objects, which can be pointers or objects for which the `()` operation is defined. As you learned in Chapter 16, a predicate is a Boolean function with one argument, and a binary predicate is a Boolean function with two arguments. (The functions need not be type `bool`, as long as they return 0 for `false` and a nonzero value for `true`.) Also as in Chapter 16, a unary function object is one that takes a single argument, and a binary function object is one that takes two arguments.



```

        RandomAccessIterator result_first,
        RandomAccessIterator result_last);

template<class InputIterator, class RandomAccessIterator, class Compare>
RandomAccessIterator
partial_sort_copy(InputIterator first, InputIterator last,
                 RandomAccessIterator result_first,
                 RandomAccessIterator result_last,
                 Compare comp);

```

The `partial_sort_copy()` function copies the first  $n$  elements of the sorted range `[first, last)` to the range `[result_first, result_first + n)`. The value of  $n$  is the lesser of `last - first` and `result_last - result_first`. The function returns `result_first + n`. The first version uses `<`, and the second version uses the comparison object `comp` to determine the order.

### **is\_sorted() (C++11)**

```

template<class ForwardIterator>
bool is_sorted(ForwardIterator first, ForwardIterator last);

template<class ForwardIterator, class Compare>
bool is_sorted(ForwardIterator first, ForwardIterator last
              Compare comp);

```

The `is_sorted()` function returns `true` if the range `[first, last)` is sorted and `false` otherwise. The first version uses `<`, and the second version uses the comparison object `comp` to determine the order.

### **is\_sorted\_until() (C++11)**

```

template<class ForwardIterator>
ForwardIterator is_sorted_until(ForwardIterator first, ForwardIterator last);

template<class ForwardIterator, class Compare>
ForwardIterator is_sorted_until(ForwardIterator first, ForwardIterator last
                              Compare comp);

```

The `is_sorted_until()` function returns `last` if the range `[first, last)` has fewer than two elements. Otherwise, it returns the last iterator, `it`, for which the range `[first, it)` is sorted. The first version uses `<`, and the second version uses the comparison object `comp` to determine the order.

### **nth\_element()**

```

template<class RandomAccessIterator>
void nth_element(RandomAccessIterator first, RandomAccessIterator nth,
                RandomAccessIterator last);

```

```
template<class RandomAccessIterator, class Compare>
void nth_element(RandomAccessIterator first, RandomAccessIterator nth,
RandomAccessIterator last, Compare comp);
```

The `nth_element()` function finds the element in the range `[first, last)` that would be at position `nth` were the range sorted, and it places that element at position `nth`. The first version uses `<`, and the second version uses the comparison object `comp` to determine the order.

## Binary Searching

The algorithms in the binary searching group assume that the range is sorted. They only require a forward iterator but are most efficient for random-access iterators.

### `lower_bound()`

```
template<class ForwardIterator, class T>
ForwardIterator lower_bound(ForwardIterator first, ForwardIterator last,
                           const T& value);
```

```
template<class ForwardIterator, class T, class Compare>
ForwardIterator lower_bound(ForwardIterator first, ForwardIterator last,
                           const T& value, Compare comp);
```

The `lower_bound()` function finds the first position in a sorted range `[first, last)` in front of which `value` can be inserted without violating the order. It returns an iterator that points to this position. The first version uses `<`, and the second version uses the comparison object `comp` to determine the order.

### `upper_bound()`

```
template<class ForwardIterator, class T>
ForwardIterator upper_bound(ForwardIterator first, ForwardIterator last,
                           const T& value);
```

```
template<class ForwardIterator, class T, class Compare>
ForwardIterator upper_bound(ForwardIterator first, ForwardIterator last,
                           const T& value, Compare comp);
```

The `upper_bound()` function finds the last position in the sorted range `[first, last)` in front of which `value` can be inserted without violating the order. It returns an iterator that points to this position. The first version uses `<`, and the second version uses the comparison object `comp` to determine the order.

### `equal_range()`

```
template<class ForwardIterator, class T>
pair<ForwardIterator, ForwardIterator> equal_range(
    ForwardIterator first, ForwardIterator last, const T& value);
```

```
template<class ForwardIterator, class T, class Compare>
pair<ForwardIterator, ForwardIterator> equal_range(
    ForwardIterator first, ForwardIterator last, const T& value,
    Compare comp);
```

The `equal_range()` function finds the largest subrange `[it1, it2)` in the sorted range `[first, last)` such that `value` can be inserted in front of any iterator in this range without violating the order. The function returns a `pair` formed of `it1` and `it2`. The first version uses `<`, and the second version uses the comparison object `comp` to determine the order.

### **binary\_search()**

```
template<class ForwardIterator, class T>
bool binary_search(ForwardIterator first, ForwardIterator last,
    const T& value);
```

```
template<class ForwardIterator, class T, class Compare>
bool binary_search(ForwardIterator first, ForwardIterator last,
    const T& value, Compare comp);
```

The `binary_search()` function returns `true` if the equivalent of `value` is found in the sorted range `[first, last)`; it returns `false` otherwise. The first version uses `<`, and the second version uses the comparison object `comp` to determine the order.

### **Note**

Recall that if `<` is used for ordering, the values `a` and `b` are equivalent if both `a < b` and `b < a` are `false`. For ordinary numbers, equivalency implies equality, but this is not the case for structures sorted on the basis of just one member. Thus, there may be more than one location where a new value can be inserted and still keep the data ordered. Similarly, if the comparison object `comp` is used for ordering, equivalency means both `comp(a, b)` and `comp(b, a)` are `false`. (This is a generalization of the statement that `a` and `b` are equivalent if `a` is not less than `b` and `b` is not less than `a`.)

### **Merging**

The merging functions assume that ranges are sorted.

### **merge()**

```
template<class InputIterator1, class InputIterator2,
    class OutputIterator>
OutputIterator merge(InputIterator1 first1, InputIterator1 last1,
    InputIterator2 first2, InputIterator2 last2,
    OutputIterator result);
```

```
template<class InputIterator1, class InputIterator2,
    class OutputIterator,
```

```

class Compare>
OutputIterator merge(InputIterator1 first1, InputIterator1 last1,
                    InputIterator2 first2, InputIterator2 last2,
                    OutputIterator result, Compare comp);

```

The `merge()` function merges elements from the sorted range `[first1, last1)` and from the sorted range `[first2, last2)`, placing the result in a range starting at `result`. The target range should not overlap either of the merged ranges. When equivalent elements are found in both ranges, elements from the first range precede elements of the second. The return value is the past-the-end iterator for the resulting merge. The first version uses `<`, and the second version uses the comparison object `comp` to determine the order.

### **`inplace_merge()`**

```

template<class BidirectionalIterator>
void inplace_merge(BidirectionalIterator first,
                  BidirectionalIterator middle, BidirectionalIterator last);

template<class BidirectionalIterator, class Compare>
void inplace_merge(BidirectionalIterator first,
                  BidirectionalIterator middle, BidirectionalIterator last,
                  Compare comp);

```

The `inplace_merge()` function merges two consecutive sorted ranges—`[first, middle)` and `[middle, last)`—into a single sorted sequence stored in the range `[first, last)`. Elements from the first range precede equivalent elements from the second range. The first version uses `<`, and the second version uses the comparison object `comp` to determine the order.

### **Working with Sets**

Set operations work with all sorted sequences, including `set` and `multiset`. For containers that hold more than one instance of a value, such as `multiset`, definitions are generalized. A union of two multisets contains the larger number of occurrences of each element, and an intersection contains the lesser number of occurrences of each element. For example, suppose Multiset A contains the string "apple" seven times and Multiset B contains the same string four times. Then the union of A and B will contain seven instances of "apple", and the intersection will contain four instances.

### **`includes()`**

```

template<class InputIterator1, class InputIterator2>
bool includes(InputIterator1 first1, InputIterator1 last1,
             InputIterator2 first2, InputIterator2 last2);

template<class InputIterator1, class InputIterator2, class Compare>
bool includes(InputIterator1 first1, InputIterator1 last1,
             InputIterator2 first2, InputIterator2 last2, Compare comp);

```

The `includes()` function returns `true` if every element in the range `[first2, last2)` is also found in the range `[first1, last1)`; it returns `false` otherwise. The first version uses `<`, and the second version uses the comparison object `comp` to determine the order.

### **set\_union()**

```
template<class InputIterator1, class InputIterator2,
        class OutputIterator>
OutputIterator set_union(InputIterator1 first1, InputIterator1 last1,
                        InputIterator2 first2, InputIterator2 last2,
                        OutputIterator result);
```

```
template<class InputIterator1, class InputIterator2,
        class OutputIterator, class Compare>
OutputIterator set_union(InputIterator1 first1, InputIterator1 last1,
                        InputIterator2 first2, InputIterator2 last2,
                        OutputIterator result, Compare comp);
```

The `set_union()` function constructs the set that is the union of the ranges `[first1, last1)` and `[first2, last2)` and copies the result to the location pointed to by `result`. The resulting range should not overlap either of the original ranges. The function returns a past-the-end iterator for the constructed range. The union is the set that contains all elements found in either or both sets. The first version uses `<`, and the second version uses the comparison object `comp` to determine the order.

### **set\_intersection()**

```
template<class InputIterator1, class InputIterator2,
        class OutputIterator>
OutputIterator set_intersection(InputIterator1 first1,
                               InputIterator1 last1, InputIterator2 first2,
                               InputIterator2 last2, OutputIterator result);
```

```
template<class InputIterator1, class InputIterator2,
        class OutputIterator, class Compare>
OutputIterator set_intersection(InputIterator1 first1,
                               InputIterator1 last1, InputIterator2 first2,
                               InputIterator2 last2, OutputIterator result,
                               Compare comp);
```

The `set_intersection()` function constructs the set that is the intersection of the ranges `[first1, last1)` and `[first2, last2)` and copies the result to the location pointed to by `result`. The resulting range should not overlap either of the original ranges. The function returns a past-the-end iterator for the constructed range. The intersection is the set that contains the elements that are common to both sets. The first version uses `<`, and the second version uses the comparison object `comp` to determine the order.

**set\_difference()**

```
template<class InputIterator1, class InputIterator2,
        class OutputIterator>
OutputIterator set_difference(InputIterator1 first1,
                            InputIterator1 last1, InputIterator2 first2,
                            InputIterator2 last2, OutputIterator result);
```

```
template<class InputIterator1, class InputIterator2,
        class OutputIterator, class Compare>
OutputIterator set_difference(InputIterator1 first1,
                            InputIterator1 last1, InputIterator2 first2,
                            InputIterator2 last2, OutputIterator result,
                            Compare comp);
```

The `set_difference()` function constructs the set that is the difference between the ranges `[first1, last1)` and `[first2, last2)` and copies the result to the location pointed to by `result`. The resulting range should not overlap either of the original ranges. The function returns a past-the-end iterator for the constructed range. The difference is the set that contains the elements found in the first set but not in the second. The first version uses `<`, and the second version uses the comparison object `comp` to determine the order.

```
template<class InputIterator1, class InputIterator2,
        class OutputIterator>
OutputIterator set_symmetric_difference(
    InputIterator1 first1, InputIterator1 last1,
    InputIterator2 first2, InputIterator2 last2,
    OutputIterator result);
```

```
template<class InputIterator1, class InputIterator2,
        class OutputIterator, class Compare>
OutputIterator set_symmetric_difference(
    InputIterator1 first1, InputIterator1 last1,
    InputIterator2 first2, InputIterator2 last2,
    OutputIterator result, Compare comp);
```

The `set_symmetric_difference()` function constructs the set that is the symmetric difference between the ranges `[first1, last1)` and `[first2, last2)` and copies the result to the location pointed to by `result`. The resulting range should not overlap either of the original ranges. The function returns a past-the-end iterator for the constructed range. The symmetric difference is the set that contains the elements found in the first set but not in the second and the elements found in the second set but not the first. It's the same as the difference between the union and the intersection. The first version uses `<`, and the second version uses the comparison object `comp` to determine the order.



**Working with Heaps**

A *heap* is a common data form with the property that the first element in a heap is the largest. Whenever the first element is removed or any element is added, the heap may have to be rearranged to maintain that property. A heap is designed so that these two operations are done efficiently.

**make\_heap()**

```
template<class RandomAccessIterator>
void make_heap(RandomAccessIterator first, RandomAccessIterator last);
```

```
template<class RandomAccessIterator, class Compare>
void make_heap(RandomAccessIterator first, RandomAccessIterator last,
               Compare comp);
```

The `make_heap()` function makes a heap of the range `[first, last)`. The first version uses `<` to determine the ordering, and the second version uses the `comp` comparison object.

**push\_heap()**

```
template<class RandomAccessIterator>
void push_heap(RandomAccessIterator first, RandomAccessIterator last);
```

```
template<class RandomAccessIterator, class Compare>
void push_heap(RandomAccessIterator first, RandomAccessIterator last,
               Compare comp);
```

The `push_heap()` function assumes that the range `[first, last - 1)` is a valid heap, and it adds the value at location `last - 1` (that is, one past the end of the heap that is assumed to be valid) into the heap, making `[first, last)` a valid heap. The first version uses `<` to determine the ordering, and the second version uses the `comp` comparison object.

**pop\_heap()**

```
template<class RandomAccessIterator>
void pop_heap(RandomAccessIterator first, RandomAccessIterator last);
```

```
template<class RandomAccessIterator, class Compare>
void pop_heap(RandomAccessIterator first, RandomAccessIterator last,
               Compare comp);
```

The `pop_heap()` function assumes that the range `[first, last)` is a valid heap. It swaps the value at location `last - 1` with the value at `first` and makes the range `[first, last - 1)` a valid heap. The first version uses `<` to determine the ordering, and the second version uses the `comp` comparison object.

**sort\_heap()**

```
template<class RandomAccessIterator>
void sort_heap(RandomAccessIterator first, RandomAccessIterator last);

template<class RandomAccessIterator, class Compare>
void sort_heap(RandomAccessIterator first, RandomAccessIterator last,
               Compare comp);
```

The `sort_heap()` function assumes that the range `[first, last)` is a heap and sorts it. The first version uses `<` to determine the ordering, and the second version uses the `comp` comparison object.

**is\_heap() (C++11)**

```
template<class RandomAccessIterator>
bool is_heap(RandomAccessIterator first, RandomAccessIterator last);

template<class RandomAccessIterator, class Compare>
bool is_heap(RandomAccessIterator first, RandomAccessIterator last,
             Compare comp);
```

The `is_heap()` function returns `true` if the range `[first, last)` is a heap and `false` otherwise. The first version uses `<`, and the second version uses the comparison object `comp` to determine the order.

**is\_heap\_until() (C++11)**

```
template<class RandomAccessIterator>
RandomAccessIterator is_heap_until(RandomAccessIterator first,
                                  RandomAccessIterator last);

template<class RandomAccessIterator, class Compare>
RandomAccessIterator is_heap_until(
    RandomAccessIterator first, RandomAccessIterator last,
    Compare comp);
```

The `is_heap_until()` function returns `last` if the range `[first, last)` has fewer than two elements. Otherwise, it returns the last iterator, `it`, for which the range `[first, it)` is a heap. The first version uses `<`, and the second version uses the comparison object `comp` to determine the order.

**Finding Minimum and Maximum Values**

The `minimum` and `maximum` functions return the minimum and maximum values of pairs of values and of sequences of values.

**min()**

```
template<class T> const T& min(const T& a, const T& b);
```

```
template<class T, class Compare>
const T& min(const T& a, const T& b, Compare comp);
```

These versions of the `min()` function return the lesser of two values. If the two values are equivalent, they return the first value. The first version uses `<` to determine the ordering, and the second version uses the `comp` comparison object.

```
template<class T> T min(initializer_list<T> t);
```

```
template<class T, class Compare>
T min(initializer_list<T> t, Compare comp);
```

These versions of `min()` function (C++11) return the smallest value in the initializer list `t`. If the two or more values are equivalent, they return a copy of the first-occurring item having that value. The first version uses `<` to determine the ordering, and the second version uses the `comp` comparison object.

**max()**

```
template<class T> const T& max(const T& a, const T& b);
```

```
template<class T, class Compare>
const T& max(const T& a, const T& b, Compare comp);
```

These versions of the `max()` function return the greater of two values. If the two values are equivalent, they return the first value. The first version uses `<` to determine the ordering, and the second version uses the `comp` comparison object.

```
template<class T> T max(initializer_list<T> t);
```

```
template<class T, class Compare>
T max(initializer_list<T> t, Compare comp);
```

These versions of `max()` function (C++11) return the largest value in the initializer list `t`. If the two or more values are equivalent, they return a copy of the first-occurring item having that value. The first version uses `<` to determine the ordering, and the second version uses the `comp` comparison object.

**minmax() (C++11)**

```
template<class T>
pair<const T&,const T&> minmax(const T& a, const T& b);
```

```
template<class T, class Compare>
pair<const T&,const T&> minmax(const T& a, const T& b,
                             Compare comp);
```

These versions of the `minmax()` function return the pair (b,a) if b is less than a, and the pair (a,b) otherwise. The first version uses `<` to determine the ordering, and the second version uses the `comp` comparison object.

```
template<class T> pair<T,T> minmax(initializer_list<T> t);
```

```
template<class T, class Compare>
pair<T,T> minmax(initializer_list<T> t, Compare comp);
```

These versions of `minmax()` function return copies of the smallest element and largest element in the initializer list `t`. If several elements are equivalent to the smallest, the first-occurring is returned. If several elements are equivalent to the largest, the last-occurring is returned. The first version uses `<` to determine the ordering, and the second version uses the `comp` comparison object.

### **min\_element()**

```
template<class ForwardIterator>
ForwardIterator min_element(ForwardIterator first, ForwardIterator last);
```

```
template<class ForwardIterator, class Compare>
ForwardIterator min_element(ForwardIterator first, ForwardIterator last,
Compare comp);
```

The `min_element()` function returns the first iterator `it` in the range `[first, last)` such that no element in the range is less than `*it`. The first version uses `<` to determine the ordering, and the second version uses the `comp` comparison object.

### **max\_element()**

```
template<class ForwardIterator>
ForwardIterator max_element(ForwardIterator first, ForwardIterator last);
```

```
template<class ForwardIterator, class Compare>
ForwardIterator max_element(ForwardIterator first, ForwardIterator last,
Compare comp);
```

The `max_element()` function returns the first iterator `it` in the range `[first, last)` such that there is no element that `*it` is less than. The first version uses `<` to determine the ordering, and the second version uses the `comp` comparison object.

### **minmax\_element() (C++11)**

```
template<class ForwardIterator>
pair<ForwardIterator,ForwardIterator>
minmax_element(ForwardIterator first, ForwardIterator last);
```

```
template<class ForwardIterator, class Compare>
pair<ForwardIterator,ForwardIterator>
minmax_element(ForwardIterator first, ForwardIterator last,
Compare comp);
```

The `max_element()` function returns a pair object containing the first iterator, `it1`, in the range `[first, last)`, such that there is no element that `*it1` is less than, and the last iterator, `it2`, in the range `[first, last)`, such that there is no element that `*it2` is less than. The first version uses `<` to determine the ordering, and the second version uses the `comp` comparison object.

### **lexicographical\_compare()**

```
template<class InputIterator1, class InputIterator2>
bool lexicographical_compare(
    InputIterator1 first1, InputIterator1 last1,
    InputIterator2 first2, InputIterator2 last2);

template<class InputIterator1, class InputIterator2, class Compare>
bool lexicographical_compare(
    InputIterator1 first1, InputIterator1 last1,
    InputIterator2 first2, InputIterator2 last2,
    Compare comp);
```

The `lexicographical_compare()` function returns `true` if the sequence of elements in the range `[first1, last1)` is lexicographically less than the sequence of elements in the range `[first2, last2)`; it returns `false` otherwise. A lexicographic comparison compares the first element of one sequence to the first of the second—that is, it compares `*first1` to `*first2`. If `*first1` is less than `*first2`, the function returns `true`. If `*first2` is less than `*first1`, the function returns `false`. If the two are equivalent, comparison proceeds to the next element in each sequence. This process continues until two corresponding elements are not equivalent or until the end of a sequence is reached. If two sequences are equivalent until the end of one is reached, the shorter sequence is less. If the two sequences are equivalent and of the same length, neither is less, so the function returns `false`. The first version of the function uses `<` to compare elements, and the second version uses the `comp` comparison object. The lexicographic comparison is a generalization of an alphabetic comparison.

### **Working with Permutations**

A *permutation* of a sequence is a reordering of the elements. For example, a sequence of three elements has six possible orderings because you have a choice of three elements for the first element. Choosing a particular element for the first position leaves a choice of two for the second, and one for the third. For example, the six permutations of the digits 1, 2, 3 are as follows:

```
123 132 213 232 312 321
```

In general, a sequence of  $n$  elements has  $n \times (n-1) \times \dots \times 1$ , or  $n!$  possible permutations.

The permutation functions assume that the set of all possible permutations can be arranged in lexicographic order, as in the previous example of six permutations. That

means, in general, that there is a specific permutation that precedes and follows each permutation. For example, 213 immediately precedes 232, and 312 immediately follows it. However, the first permutation (123 in the example) has no predecessor, and the last permutation (321 in the example) has no follower.

### **next\_permutation()**

```
template<class BidirectionalIterator>
bool next_permutation(BidirectionalIterator first,
                    BidirectionalIterator last);

template<class BidirectionalIterator, class Compare>
bool next_permutation(BidirectionalIterator first,
                    BidirectionalIterator last, Compare comp);
```

The `next_permutation()` function transforms the sequence in the range `[first, last)` to the next permutation in lexicographic order. If the next permutation exists, the function returns `true`. If it doesn't exist (that is, the range contains the last permutation in lexicographic order), the function returns `false` and transforms the range to the first permutation in lexicographic order. The first version uses `<` to determine the ordering, and the second version uses the `comp` comparison object.

### **prev\_permutation()**

```
template<class BidirectionalIterator>
bool prev_permutation(BidirectionalIterator first,
                    BidirectionalIterator last);

template<class BidirectionalIterator, class Compare>
bool prev_permutation(BidirectionalIterator first,
                    BidirectionalIterator last, Compare comp);
```

The `previous_permutation()` function transforms the sequence in the range `[first, last)` to the previous permutation in lexicographic order. If the previous permutation exists, the function returns `true`. If it doesn't exist (that is, the range contains the first permutation in lexicographic order), the function returns `false` and transforms the range to the last permutation in lexicographic order. The first version uses `<` to determine the ordering, and the second version uses the `comp` comparison object.

## **Numeric Operations**

Table G.16 summarizes the numeric operations, which are described by the `numeric` header file. Arguments are not shown, and overloaded functions are listed just once. Each function has a version that uses `<` for ordering elements and a version that uses a comparison function object for ordering elements. A fuller description, including the prototypes, follows the table. Thus, you can scan the table to get an idea of what a function does and then look up the details if you find the function appealing.

Table G.16 **Sorting and Related Operations**

| Function                           | Description                                                                                              |
|------------------------------------|----------------------------------------------------------------------------------------------------------|
| <code>accumulate()</code>          | Calculates a cumulative total for values in a range.                                                     |
| <code>inner_product()</code>       | Calculates the inner product of two ranges.                                                              |
| <code>partial_sum()</code>         | Copies partial sums calculated from one range into a second range.                                       |
| <code>adjacent_difference()</code> | Copies adjacent differences calculated from elements in one range to a second range.                     |
| <code>iota()</code>                | Assigns consecutive values, as produced by the <code>++</code> operator, to elements in a range. (C++11) |

Now let's take a more detailed look at these numeric operations. For each function, the discussion shows the prototype(s), followed by a brief explanation.

### **accumulate()**

```
template <class InputIterator, class T>
T accumulate(InputIterator first, InputIterator last, T init);

template <class InputIterator, class T, class BinaryOperation>
T accumulate(InputIterator first, InputIterator last, T init,
             BinaryOperation binary_op);
```

The `accumulate()` function initializes a value `acc` to `init`; then it performs the operation `acc = acc + *i` (first version) or `acc = binary_op(acc, *i)` (second version) for each iterator `i` in the range `[first, last)`, in order. It then returns the resulting value of `acc`.

### **inner\_product()**

```
template <class InputIterator1, class InputIterator2, class T>
T inner_product(InputIterator1 first1, InputIterator1 last1,
               InputIterator2 first2, T init);

template <class InputIterator1, class InputIterator2, class T,
          class BinaryOperation1, class BinaryOperation2>
T inner_product(InputIterator1 first1, InputIterator1 last1,
               InputIterator2 first2, T init,
               BinaryOperation1 binary_op1, BinaryOperation2 binary_op2);
```

The `inner_product()` function initializes a value `acc` to `init`; then it performs the operation `acc = *i * *j` (first version) or `acc = binary_op(*i, *j)` (second version) for each iterator `i` in the range `[first1, last1)`, in order, and each corresponding iterator `j`

in the range  $[first2, first2 + (last1 - first1))$ . That is, it calculates a value from the first elements from each sequence, then from the second elements of each sequence, and so on, until it reaches the end of the first sequence. (Hence the second sequence should be at least as long as the first.) The function then returns the resulting value of `acc`.

### **partial\_sum()**

```
template <class InputIterator, class OutputIterator>
OutputIterator partial_sum(InputIterator first, InputIterator last,
                          OutputIterator result);

template <class InputIterator, class OutputIterator, class BinaryOperation>
OutputIterator partial_sum(InputIterator first, InputIterator last,
                          OutputIterator result,
                          BinaryOperation binary_op);
```

The `partial_sum()` function assigns `*first` to `*result` or `*first + *(first + 1)` to `*(result + 1)` (first version) or it assigns `binary_op(*first, *(first + 1))` to `*(result + 1)` (second version), and so on. That is, the  $n$ th element of the sequence beginning at `result` contains the sum (or `binary_op` equivalent) of the first  $n$  elements of the sequence beginning at `first`. The function returns the past-the-end iterator for the result. The algorithm allows `result` to be `first`—that is, it allows the result to be copied over the original sequence, if desired.

### **adjacent\_difference()**

```
template <class InputIterator, class OutputIterator>
OutputIterator adjacent_difference(InputIterator first, InputIterator last,
                                  OutputIterator result);

template <class InputIterator, class OutputIterator, class BinaryOperation>
OutputIterator adjacent_difference(InputIterator first, InputIterator last,
                                  OutputIterator result,
                                  BinaryOperation binary_op);
```

The `adjacent_difference()` function assigns `*first` to the location `result` (`*result = *first`). Subsequent locations in the target range are assigned the differences (or `binary_op` equivalent) of adjacent locations in the source range. That is, the next location in the target range (`result + 1`) is assigned `*(first + 1) - *first` (first version) or `binary_op(*(first + 1), *first)` (second version), and so on. The function returns the past-the-end iterator for the result. The algorithm allows `result` to be `first`—that is, it allows the result to be copied over the original sequence, if desired.



**`iota()` (C++11)**

```
template <class ForwardIterator, class T>  
void iota(ForwardIterator first, ForwardIterator last, T value);
```

The `iota()` function assigns `value` to `*first`, increases `value` as if by `++value`, assigns the new `value` to the next element in the range, and so on until the last element.

# Selected Readings and Internet Resources

There are many good books and Internet resources about C++ and programming. The following list is intended to be representative rather than comprehensive. Thus, there are many fine books and sites not listed here. However, the list does cover a broad range of presentations.

## Selected Readings

- Becker, Pete. *The C++ Standard Library Extensions*. Upper Saddle River, NJ: Addison-Wesley, 2007.

This book discusses the first C++ Library Technical Report, or TR1 library. This is an optional library for C++98, but most of its elements were incorporated into C++11. Topics include the unordered set templates, smart pointers, the regular expression library, the random number library, and tuples.

- Booch, Grady, Robert A. Maksimchuk, Michael W. Engel, and Bobbi J. Young. *Object-Oriented Analysis and Design, Third Edition*. Upper Saddle River, NJ: Addison-Wesley, 2007.

This book presents the concepts behind object-oriented programming (OOP), discusses OOP methods, and presents sample applications. The examples are in C++.

- Cline, Marshall, Greg Lomow, and Mike Girou. *C++ FAQs, Second Edition*. Reading, MA: Addison-Wesley, 1998.

This book addresses a great number of frequently asked questions about the C++ language.

- Josuttis, Nicolai M. *The C++ Standard Library: A Tutorial and Reference*. Reading, MA: Addison-Wesley, 1999.

This book describes the Standard Template Library (STL) as well as other C++ library features, such as complex number support, locales, and input/output streams.

- Karlsson, Björn. *Beyond the C++ Standard Library: An Introduction to Boost*. Upper Saddle River, NJ: Addison-Wesley, 2006.

This book, as the title suggests, explores several of the Boost libraries.
- Meyers, Scott. *Effective C++: 55 Specific Ways to Improve Your Programs and Designs, Third Edition*. Upper Saddle River, NJ: Addison-Wesley, 2005.

This book is aimed at programmers who already know C++ and provides 55 rules and guidelines. Some are technical, such as explaining when you should define copy constructors and assignment operators. Others are more general, such as discussing *is-a* and *has-a* relationships.
- Meyers, Scott. *Effective STL: 50 Specific Ways to Improve Your Use of the Standard Template Library*. Reading, MA: Addison-Wesley, 2001.

This book provides guidance in choosing containers and algorithms and in other facets of using the STL.
- Meyers, Scott. *More Effective C++: 35 New Ways to Improve Your Programs and Designs*. Reading, MA: Addison-Wesley, 1996.

This book continues in the tradition of *Effective C++*, clarifying some of the more obscure aspects of the language and showing how to accomplish various goals, such as designing smart pointers. It reflects the additional experience C++ programmers have gained in the past few years.
- Musser, David R, Gillmer J. Derge, and Atul Saini. *STL Tutorial and Reference Guide: C++ Programming with the Standard Template Library, Second Edition*. Reading, MA: Addison-Wesley, 2001.

The STL merits a complete book to describe and illustrate its features, and here is such a book.
- Stroustrup, Bjarne. *The C++ Programming Language, Third Edition*. Reading, MA: Addison-Wesley, 1997.

Stroustrup created C++, so this is the definitive text. However, it is most easily digested if you already have some knowledge of C++. It not only describes the language, but it also provides many examples of how to use it, as well as discussions of OOP methodology. Successive editions of this book have grown with the language, and this edition includes a discussion of standard library elements such as the STL and strings.
- Stroustrup, Bjarne. *The Design and Evolution of C++*. Reading, MA: Addison-Wesley, 1994.

If you're interested in learning how C++ evolved and why it is the way it is, read this book.
- Vandevoorde, David and Nocolai M. Jpsittos. *C++ Templates: The Complete Guide*. Reading, MA: Addison-Wesley, 2003.

A lot can be said about templates, as this detailed reference demonstrates.

## Internet Resources

- The 2011 ISO/ANSI C++ Standard (ISO/IEC 14882:2011) is available from both the American National Standards Institute (ANSI) and the International Organization for Standardization (ISO).

ANSI has a downloadable PDF version available for \$381. It can be ordered from the following website:

<http://webstore.ansi.org>

The ISO offers the document as a downloadable PDF file for CHF 352 or on a CD-ROM, also for CHF 352 (Swiss Francs), at the following site:

[www.iso.org](http://www.iso.org)

Prices are subject to change.

- The C++ FAQ Lite site for frequently asked questions (in English, Chinese, French, Russian, and Portuguese) is a slimmed-down version of the book by Cline, et al. Currently it has the following URL:
- You can find a moderated discussion of C++ questions in the following newsgroup: `comp.lang.C++.moderated`.
- You can find information about specific C++ topics by using Google, Bing, and other search engines.

*This page intentionally left blank*

# Converting to ISO Standard C++

You might have programs (or programming habits) that you developed in C or in older versions of C++ and you want to convert to standard C++. This appendix provides some guidelines. Some pertain to moving from C to C++, and others pertain to moving from older C++ to standard C++.

## Use Alternatives for Some Preprocessor Directives

The C/C++ preprocessor provides an array of directives. In general, C++ practice is to use those directives that are designed to manage the compilation process and to avoid using directives as a substitute for code. For example, the `#include` directive is an essential component for managing program files. Other directives, such as `#ifndef` and `#endif`, let you control whether particular blocks of code get compiled. The `#pragma` directive lets you control compiler-specific compilation options. These are all useful, sometimes necessary, tools. You should exercise caution, however, when it comes to the `#define` directive.

## Use `const` Instead of `#define` to Define Constants

Symbolic constants make code more readable and maintainable. The constant's name indicates its meaning, and if you need to change the value, you just have to change the value once, in the definition, and then recompile. C uses the preprocessor to create symbolic names for a constant:

```
#define MAX_LENGTH 100
```

The preprocessor then does a text substitution in your source code, replacing occurrences of `MAX_LENGTH` with `100` prior to compilation.

The C++ approach is to apply the `const` modifier to a variable declaration:

```
const int MAX_LENGTH = 100;
```

This treats `MAX_LENGTH` as a read-only `int`.

There are several advantages to using the `const` approach. First, the declaration explicitly names the type. With `#define`, you must use various suffixes to a number to indicate types other than `char`, `int`, or `double`; for example, you use `100L` to indicate a `long` type and `3.14F` to indicate a `float` type. More importantly, the `const` approach can just as easily be used with compound types, as in this example:

```
const int base_vals[5] = {1000, 2000, 3500, 6000, 10000};
const string ans[3] = {"yes", "no", "maybe"};
```

Finally, `const` identifiers obey the same scope rules as variables. Thus, you can create constants with global scope, named namespace scope, and block scope. If, say, you define a constant in a particular function, you don't have to worry about the definition conflicting with a global constant used elsewhere in a program. For example, consider the following:

```
#define n 5
const int dz = 12;
...
void fizzle()
{
    int n;
    int dz;
    ...
}
```

The preprocessor will replace

```
int n;
```

with

```
int 5;
```

and induce a compilation error. The `dz` defined in `fizzle()`, however, will be a local variable. Also if necessary, `fizzle()` can use the scope-resolution operator (`::`) and access the constant as `::dz`.

C++ has borrowed the `const` keyword from C, but the C++ version is more useful. For example, the C++ version has internal linkage for external `const` values rather than the default external linkage used by variables and by the C `const`. This means that each file in a program using a `const` needs that `const` defined in that particular file. This might sound like extra work, but, in fact, it makes life easier. With internal linkage, you can place `const` definitions in a header file used by various files in a project. That is a compiler error for external linkage but not for internal linkage. Also because a `const` must be defined in the file that uses it (being in a header file used by that file satisfies the requirement), you can use `const` values as array size arguments:

```
const int MAX_LENGTH = 100;
...
double loads[MAX_LENGTH];
```

```
for (int i = 0; i < MAX_LENGTH; i++)
    loads[i] = 50;
```

This won't work in C because the defining declaration for `MAX_LENGTH` could be in a separate file and not be available when this particular file is compiled. In fairness, it should be added that, in C, you could use the `static` modifier to create constants with internal linkage. It's just that C++, by making `static` the default, requires one fewer thing for you to remember.

Incidentally, the revised C Standard (C99) allows you to use a `const` as an array size specification, but the array is treated as a new form of array, called a *variable array*, that is not part of the C++ Standard.

One role for the `#define` directive is still quite useful—the standard idiom for controlling when a header file is compiled:

```
// blooper.h
#ifndef _BLOOPER_H_
#define _BLOOPER_H_
// code goes here
#endif
```

For typical symbolic constants, however, you should get into the habit of using `const` instead of `#define`. Another good alternative, particularly when you have a set of related integer constants, is to use `enum`:

```
enum {LEVEL1 = 1, LEVEL2 = 2, LEVEL3 = 4, LEVEL4 = 8};
```

## Use inline Instead of #define to Define Short Functions

The traditional C way to create the near-equivalent of an inline function is to use a `#define` macro definition:

```
#define Cube(X) X*X*X
```

This leads the preprocessor to do text substitution, with `x` being replaced by the corresponding argument to `Cube()`:

```
y = Cube(x);          // replaced with y = x*x*x;
y = Cube(x + z++);   // replaced with x + z++*x + z++*x + z++;
```

Because the preprocessor uses text substitution instead of true passing of arguments, using such macros can lead to unexpected and incorrect results. Such errors can be reduced by using lots of parentheses in the macro to ensure the correct order of operations:

```
#define Cube(X) ((X)*(X)*(X))
```

Even this, however, doesn't deal with cases such as using values like `z++`.



The C++ approach of using the keyword `inline` to identify inline functions is much more dependable because it uses true argument passing. Furthermore, C++ inline functions can be regular functions or class methods:

```
class dormant
{
private:
    int period;
    ...
public:
    int Period() const { return period; } // automatically inline
    ...
};
```

One positive feature of the `#define` macro is that it is typeless, so it can be used with any type for which the operation makes sense. In C++ you can create inline templates to achieve type-independent functions while retaining argument passing.

In short, you should use C++ inlining instead of C `#define` macros.

## Use Function Prototypes

Actually, you don't have a choice: Although prototyping is optional in C, it is mandatory in C++. Note that a function that is defined before its first use, such as an inline function, serves as its own prototype.

You should use `const` in function prototypes and headers when appropriate. In particular, you should use `const` with pointer parameters and reference parameters representing data that is not to be altered. Not only does this allow the compiler to catch errors that change data, it also makes a function more general. That is, a function with a `const` pointer or reference can process both `const` and `non-const` data, whereas a function that fails to use `const` with a pointer or reference can process only `non-const`.

## Use Type Casts

One of Stroustrup's pet peeves about C is its undisciplined type cast operator. True, type casts are often necessary, but the standard type cast is too unrestrictive. For example, consider the following code:

```
struct Doof
{
    double feeb;
    double steeb;
    char sgif[10];
};
Doof leam;
short * ps = (short *) & leam; // old syntax
int * pi = int * (&leam);      // new syntax
```

Nothing in the C language prevents you from casting a pointer of one type to a pointer to a totally unrelated type.

In a way, the situation is similar to that of the `goto` statement. The problem with the `goto` statement was that it was too flexible, leading to twisted code. The solution was to provide more limited, structured versions of `goto` to handle the most common tasks for which `goto` was needed. This was the genesis of language elements such as `for` and `while` loops and `if else` statements. Standard C++ provides a similar solution for the problem of the undisciplined type cast—namely, restricted type casts to handle the most common situations requiring type casts. The following are the type cast operators discussed in Chapter 15, “Friends, Exceptions, and More”:

```
dynamic_cast
static_cast
const_cast
reinterpret_cast
```

So if you are doing a type cast involving pointers, you should use one of these operators if possible. Doing so both documents the intent of the type cast and provides checking that the type cast is being used as intended.

## Become Familiar with C++ Features

If you’ve been using `malloc()` and `free()`, you should switch to using `new` and `delete` instead. If you’ve been using `setjmp()` and `longjmp()` for error handling, you should use `try`, `throw`, and `catch` instead. You should try using the `bool` type for values representing `true` and `false`.

## Use the New Header Organization

The C++ Standard specifies new names for the header files, as described in Chapter 2, “Setting Out to C++.” If you’ve been using the old-style header files, you should change over to using the new-style names. This is not just a cosmetic change because the new versions sometimes add new features. For example, the `ostream` header file provides support for wide-character input and output. It also provides new manipulators such as `boolalpha` and `fixed` (as described in Chapter 17, “Input, Output, and Files”). These offer a simpler interface than using `setf()` or the `omanip` functions for setting many formatting options. If you do use `setf()`, you should use `ios_base` instead of `ios` when specifying constants; that is, you should use `ios_base::fixed` instead of `ios::fixed`. Also the new header files incorporate namespaces.

## Use Namespaces

Namespaces help organize identifiers used in a program in order to avoid name conflicts. Because the standard library, as implemented with the new header file organization,

places names in the `std` namespace, using these header files requires that you deal with namespaces.

The examples in this book, for simplicity, most often utilize a `using` directive to make all the names from the `std` namespace available:

```
#include <iostream>
#include <string>
#include <vector>
using namespace std;           // a using-directive
```

However, the wholesale exporting of all the names in a namespace, whether needed or not, runs counter to the goals of namespaces.

Somewhat better is placing a `using` directive inside a function; this makes the names available just inside that function.

Even better, and the recommended approach, is to use either `using` declarations or the scope-resolution operator (`::`) to make available just those names a program needs. For example, the following makes `cin`, `cout`, and `endl` available for the rest of the file:

```
#include <iostream>
using std::cin;                // a using-declaration
using std::cout;
using std::endl;
```

Using the scope-resolution operator, however, makes a name available just in the expression that uses the operator:

```
cout << std::fixed << x << endl; //using the scope resolution operator
```

This could get wearisome, but you could collect your common `using` declarations in a header file:

```
// mynames - a header file
using std::cin;                // a using-declaration
using std::cout;
using std::endl;
```

Going a step further, you could collect `using` declarations in namespaces:

```
// mynames - a header file
#include <iostream>

namespace io
{
    using std::cin;
    using std::cout;
    using std::endl;
}

namespace formats
{
```

```

using std::fixed;
using std::scientific;
using std::boolalpha;
}

```

Then a program could include this file and use the namespaces it needs:

```

#include "mynames"
using namespace io;

```

## Use Smart Pointers

Each use of `new` should be paired with a use of `delete`. This can lead to problems if a function in which `new` is used terminates early via an exception being thrown. As discussed in Chapter 15, using an `auto_ptr` object to keep track of an object created by `new` automates the activation of `delete`. The C++11 additions `unique_ptr` and `shared_ptr` provide yet better alternatives.

## Use the `string` Class

The traditional C-style string suffers from not being a real type. You can store a string in a character array, and you can initialize a character array to a string. But you can't use the assignment operator to assign a string to a character array; instead, you must remember to use `strcpy()` or `strncpy()`. You can't use the relational operators to compare C-style strings; instead, you must remember to use `strcmp()`. (And if you forget and use, say, the `>` operator, you don't get a syntax error; instead, the program compares string addresses instead of string contents.)

The `string` class (see Chapter 16, "The `string` Class and the Standard Template Library," and Appendix F, "The `string` Template Class"), on the other hand, lets you use objects to represent strings. Assignment operators, relational operators, and the addition operator (for concatenation) are all defined. Furthermore, the `string` class provides automatic memory management so that you normally don't have to worry about someone entering a string that either overruns an array or gets truncated before being stored.

The `string` class provides many convenience methods. For example, you can append one `string` object to another, but you can also append a C-style string or even a `char` value to a `string` object. For functions that require a C-style string argument, you can use the `c_str()` method to return a suitable pointer-to-`char`.

Not only does the `string` class provide a well-designed set of methods for handling string-related tasks, such as finding substrings, but it also features a design that is compatible with the Standard Template Library (STL) so that you can use STL algorithms with `string` objects.

## Use the STL

The STL (see Chapter 16 and Appendix G, “The STL methods and Functions”) provides ready-made solutions to many programming needs, so you should use it. For example, instead of declaring an array of `double` or of `string` objects, you can create a `vector<double>` object or a `vector<string>` object. The advantages are similar to those of using `string` objects instead of C-style strings. Assignment is defined, so you can use the assignment operator to assign one `vector` object to another. You can pass a `vector` object by reference, and a function receiving such an object can use the `size()` method to determine the number of elements in the `vector` object. Built-in memory management allows for automatic resizing when you use the `pushback()` method to add elements to a `vector` object. And of course, several useful class methods and general algorithms are at your service. Or with C++11, if a fixed-size array is a better fit, use `array<double>` or `array<string>`.

If you need a list, a double-ended queue (or deque), a stack, a regular queue, a set, or a map, you should use the STL, which provides useful container templates. The algorithm library is designed so that you can easily copy the contents of a vector to a list or compare the contents of a set to a vector. This design makes the STL a toolkit that provides basic units that you can assemble as needed.

The extensive algorithm library was designed with efficiency as one of the main design goals, so you can get top-flight results with relatively little programming effort on your part. And the iterator concept used to implement the algorithms means that the algorithms aren't limited to being used with STL containers. In particular, they can be applied to traditional arrays, too.

# Answers to Chapter Reviews

## Answers to Chapter Review for Chapter 2

1. They are called functions.
2. It causes the contents of the `iostream` file to be substituted for this directive before final compilation.
3. It makes definitions made in the `std` namespace available to a program.
4. 

```
cout << "Hello, world\n";
```

or

```
cout << "Hello, world" << endl;
```
5. 

```
int cheeses;
```
6. 

```
cheeses = 32;
```
7. 

```
cin >> cheeses;
```
8. 

```
cout << "We have " << cheeses << " varieties of cheese\n";
```
9. The function `froop()` expects to be called with one argument, which will be type `double`, and that the function will return a type `int` value. For instance, it could be used as follows:

```
int gval = froop(3.14159);
```

The function `rattle()` has no return value and expects an `int` argument. For instance, it could be used as follows:

```
rattle(37);
```

The function `prune()` returns an `int` and expects to be used without an argument. For instance, it could be used as follows:

```
int residue = prune();
```

10. You don't have to use `return` in a function when the function has the return type `void`. However, you can use it if you don't give a return value:

```
return;
```

## Answers to Chapter Review for Chapter 3

1. Having more than one integer type lets you choose the type that is best suited to a particular need. For example, you could use `short` to conserve space or `long` to guarantee storage capacity or to find that a particular type speeds up a particular calculation.

2. 

```
short rbis = 80;           // or short int rbis = 80;
unsigned int q = 42110;   // or unsigned q = 42110;
unsigned long ants = 3000000000;
// or long long ants = 3000000000;
```

Note: Don't count on `int` being large enough to hold 3,000,000,000. Also if your system supports universal list-initialization, you could use it:

```
short rbis = {80};           // = is optional
unsigned int q {42110};     // could use = {42110}
long long ants {3000000000};
```

3. C++ provides no automatic safeguards to keep you from exceeding integer limits; you can use the `climits` header file to determine what the limits are.
4. The constant `33L` is type `long`, whereas the constant `33` is type `int`.
5. The two statements are not really equivalent, although they have the same effect on some systems. Most importantly, the first statement assigns the letter `A` to `grade` only on a system using the ASCII code, while the second statement also works for other codes. Second, `65` is a type `int` constant, whereas `'A'` is a type `char` constant.
6. Here are four ways:

```
char c = 88;
cout << c << endl;           // char type prints as character

cout.put(char(88));         // put() prints char as character

cout << char(88) << endl;     // new-style type cast value to char

cout << (char)88 << endl;     // old-style type cast value to char
```

7. The answer depends on how large the two types are. If `long` is 4 bytes, there is no loss. That's because the largest `long` value would be about 2 billion, which is 10 digits. Because `double` provides at least 13 significant figures, no rounding would be needed. The `long long` type, on the other hand, can reach 19 digits, which exceeds the 13 significant figures guaranteed for `double`.
8. a.  $8 * 9 + 2$  is  $72 + 2$  is 74  
 b.  $6 * 3 / 4$  is  $18 / 4$  is 4  
 c.  $3 / 4 * 6$  is  $0 * 6$  is 0  
 d.  $6.0 * 3 / 4$  is  $18.0 / 4$  is 4.5  
 e.  $15 \% 4$  is 3

9. Either of the following would work for the first task:

```
int pos = (int) x1 + (int) x2;
int pos = int(x1) + int(x2);
```

To add them as type `double` and then convert, you could do either of the following:

```
int pos = (int) (x1 + x2);
int pos = int(x1 + x2);
```

10. a. `int`  
 b. `float`  
 c. `char`  
 d. `char32_t`  
 e. `double`

## Answers to Chapter Review for Chapter 4

1. a. `char actors[30];`  
 b. `short betsie[100];`  
 c. `float chuck[13];`  
 d. `long double dipsea[64];`
2. a. `array<char,30> actors;`  
 b. `array<short, 100> betsie;`  
 c. `array<float, 13> chuck;`  
 d. `array<long double, 64> dipsea;`



3. `int oddly[5] = {1, 3, 5, 7, 9};`
4. `int even = oddly[0] + oddly[4];`
5. `cout << ideas[1] << "\n"; // or << endl;`
6. `char lunch[13] = "cheeseburger"; // number of characters + 1`  
or  
`char lunch[] = "cheeseburger"; // let the compiler count elements`
7. `string lunch = "Waldorf Salad";`  
or, if you don't have a using directive,  
`std::string lunch = "Waldorf Salad";`
8. `struct fish {`  
`char kind[20];`  
`int weight;`  
`float length;`  
`};`
9. `fish petes =`  
`{`  
`"trout",`  
`12,`  
`26.25`  
`};`
10. `enum Response {No, Yes, Maybe};`
11. `double * pd = &ted;`  
`cout << *pd << "\n";`
12. `float * pf = treacle; // or = &treacle[0]`  
`cout << pf[0] << " " << pf[9] << "\n";`  
`// or use *pf and *(pf + 9)`
13. This assumes that the `iostream` and `vector` header files have been included and that there is a using directive:  
`unsigned int size;`  
`cout << "Enter a positive integer: ";`  
`cin >> size;`  
`int * dyn = new int [size];`  
`vector<int> dv(size);`

14. Yes, it is valid. The expression "Home of the jolly bytes" is a string constant; hence it evaluates as the address of the beginning of the string. The `cout` object interprets the address of a `char` as an invitation to print a string, but the type cast `(int *)` converts the address to type pointer-to-int, which is then printed as an address. In short, the statement prints the address of the string, assuming the `int` type is wide enough to hold an address.
15. 

```
struct fish
{
    char kind[20];
    int weight;
    float length;
};

fish * pole = new fish;
cout << "Enter kind of fish: ";
cin >> pole->kind;
```
16. Using `cin >> address` causes a program to skip over whitespace until it finds non-whitespace. It then reads characters until it encounters whitespace again. Thus, it will skip over the newline following the numeric input, avoiding that problem. On the other hand, it will read just a single word, not an entire line.
17. 

```
#include <string>
#include <vector>
#include <array>
const int Str_num {10}; // or = 10
...
std::vector<std::string> vstr(Str_num);
std::array<std::string, Str_num> astr;
```

## Answers to Chapter Review for Chapter 5

1. An entry-condition loop evaluates a test expression before entering the body of the loop. If the condition is initially `false`, the loop never executes its body. An exit-condition loop evaluates a test expression after processing the body of the loop. Thus, the loop body is executed once, even if the test expression is initially `false`. The `for` and `while` loops are entry-condition loops, and the `do while` loop is an exit-condition loop.
2. It would print the following:

```
01234
```

Note that `cout << endl;` is not part of the loop body (because there are no braces).

3. It would print the following:

```
0369
12
```

4. It would print the following:

```
6
8
```

5. It would print the following:

```
k = 8
```

6. It's simplest to use the \*= operator:

```
for (int num = 1; num <= 64; num *= 2)
    cout << num << " ";
```

7. You enclose the statements within paired braces to form a single compound statement, or block.
8. Yes, the first statement is valid. The expression `1,024` consists of two expressions—`1` and `024`—joined by a comma operator. The value is the value of the right-hand expression. This is `024`, which is octal for `20`, so the declaration assigns the value `20` to `x`. The second statement is also valid. However, operator precedence causes it to be evaluated as follows:

```
(y = 1), 024;
```

That is, the left expression sets `y` to `1`, and the value of the entire expression, which isn't used, is `024`, or `20`.

9. The `cin >> ch` form skips over spaces, newlines, and tabs when it encounters them. The other two forms read those characters.

## Answers to Chapter Review for Chapter 6

- Both versions give the same answers, but the `if else` version is more efficient. Consider what happens, for example, when `ch` is a space. Version 1, after incrementing spaces, tests whether the character is a newline. This wastes time because the program has already established that `ch` is a space and hence could not be a newline. Version 2, in the same situation, skips the newline test.
- Both `++ch` and `ch + 1` have the same numerical value. But `++ch` is type `char` and prints as a character, while `ch + 1`, because it adds a `char` to an `int`, is type `int` and prints as a number.

3. Because the program uses `ch = '$'` instead of `ch == '$'`, the combined input and output looks like this:

```
Hi!
H$i!$
$Send $10 or $20 now!
S$e$n$d$ $ct1 = 9, ct2 = 9
```

Each character is converted to the \$ character before being printed the second time. Also the value of the expression `ch = $` is the code for the \$ character, hence nonzero, hence `true`; so `ct2` is incremented each time.

4. a. `weight >= 115 && weight < 125`  
 b. `ch == 'q' || ch == 'Q'`  
 c. `x % 2 == 0 && x != 26`  
 d. `x % 2 == 0 && !(x % 26 == 0)`  
 e. `donation >= 1000 && donation <= 2000 || guest == 1`  
 f. `(ch >= 'a' && ch <= 'z') || (ch >= 'A' && ch <= 'Z')`
5. Not necessarily. For example, if `x` is 10, then `!x` is 0 and `!!x` is 1. However, if `x` is a `bool` variable, then `!!x` is `x`.

6. `(x < 0)? -x : x`  
 or  
`(x >= 0)? x : -x;`

7. 

```
switch (ch)
{
    case 'A': a_grade++;
              break;
    case 'B': b_grade++;
              break;
    case 'C': c_grade++;
              break;
    case 'D': d_grade++;
              break;
    default: f_grade++;
              break;
}
```

8. If you use integer labels and the user types a noninteger such as `q`, the program hangs because integer input can't process a character. But if you use character labels and the user types an integer such as `5`, character input will process 5 as a character. Then the default part of the switch can suggest entering another character.

9. Here is one version:

```
int line = 0;
char ch;
while (cin.get(ch) && ch != 'Q')
{
    if (ch == '\n')
        line++;
}
```

## Answers to Chapter Review for Chapter 7

1. The three steps are defining the function, providing a prototype, and calling the function.

2. a. `void igor(void); // or void igor()`  
 b. `float tofu(int n); // or float tofu(int);`  
 c. `double mpg(double miles, double gallons);`  
 d. `long summation(long harray[], int size);`  
 e. `double doctor(const char * str);`  
 f. `void ofcourse(boss dude);`  
 g. `char * plot(map *pmap);`

3. `void set_array(int arr[], int size, int value)`  
`{`  
     `for (int i = 0; i < size; i++)`  
         `arr[i] = value;`  
`}`

4. `void set_array(int * begin, int * end, int value)`  
`{`  
     `for (int * pt = begin; pt != end; pt++)`  
         `pt* = value;`  
`}`

5. `double biggest (const double foot[], int size)`  
`{`  
     `double max;`  
     `if (size < 1)`  
     `{`  
         `cout << "Invalid array size of " << size << endl;`  
         `cout << "Returning a value of 0\n";`  
         `return 0;`  
     `}`  
`}`

```

    }
    else // not necessary because return terminates program
    {
        max = foot[0];
        for (int i = 1; i < size; i++)
            if (foot[i] > max)
                max = foot[i];
        return max;
    }
}

```

6. You use the `const` qualifier with pointers to protect the original pointed-to data from being altered. When a program passes a fundamental type such as an `int` or a `double`, it passes it by value so that the function works with a copy. Thus, the original data is already protected.
7. A string can be stored in a `char` array, it can be represented by a string constant in double quotation marks, and it can be represented by a pointer pointing to the first character of a string.

```

8. int replace(char * str, char c1, char c2)
{
    int count = 0;
    while (*str) // while not at end of string
    {
        if (*str == c1)
        {
            *str = c2;
            count++;
        }
        str++; // advance to next character
    }
    return count;
}

```

9. Because C++ interprets `"pizza"` as the address of its first element, applying the `*` operator yields the value of that first element, which is the character `p`. Because C++ interprets `"taco"` as the address of its first element, it interprets `"taco" [2]` as the value of the element two positions down the line—that is, as the character `c`. In other words, the string constant acts the same as an array name.
10. To pass it by value, you just pass the structure name `glitz`. To pass its address, you use the address operator `&glitz`. Passing by the value automatically protects the original data, but it takes time and memory. Passing by address saves time and memory but doesn't protect the original data unless you use the `const` modifier for the function parameter. Also passing by value means you can use ordinary structure

member notation, but passing a pointer means you have to remember to use the indirect membership operator.

11. 

```
int judge (int (*pf)(const char *));
```
12.
  - a. Note that if `ap` is an applicant structure, then `ap.credit_ratings` is an array name and `ap.credit_ratings[i]` is an array element.
 

```
void display(applicant ap)
{
    cout << ap.name << endl;
    for (int i = 0; i < 3; i++)
        cout << ap.credit_ratings[i] << endl;
}
```
  - b. Note that if `pa` is a pointer to an applicant structure, then `pa->credit_ratings` is an array name and `pa->credit_ratings[i]` is an array element.
 

```
void show(const applicant * pa)
{
    cout << pa->name << endl;
    for (int i = 0; i < 3; i++)
        cout << pa->credit_ratings[i] << endl;
}
```
13. 

```
typedef void (*p_f1)(applicant *);
p_f1 p1 = f1;
typedef const char * (*p_f2)(const applicant *, const applicant *);
p_f2 p2 = f2;
p_f1 ap[5];
p_f2 (*pa)[10];
```

## Answers to Chapter Review for Chapter 8

1. Short, nonrecursive functions that can fit in one line of code are good candidates for inline status.
2.
  - a. 

```
void song(const char * name, int times = 1);
```
  - b. None. Only prototypes contain the default value information.
  - c. Yes, provided that you retain the default value for `times`:
 

```
void song(char * name = "O, My Papa", int times = 1);
```
3. You can use either the string `"\"` or the character `"\"` to print a quotation mark. The following functions show both methods:
 

```
#include <iostream.h>
void iquote(int n)
```

```

{
    cout << "\"" << n << "\"";
}

void iquote(double x)
{
    cout << "'" << x << "'";
}

void iquote(const char * str)
{
    cout << "\"" << str << "\"";
}

```

4. a. This function shouldn't alter the structure members, so use the `const` qualifier:

```

void show_box(const box & container)
{
    cout << "Made by " << container.maker << endl;
    cout << "Height = " << container.height << endl;
    cout << "Width = " << container.width << endl;
    cout << "Length = " << container.length << endl;
    cout << "Volume = " << container.volume << endl;
}

```

- b. `void set_volume(box & crate)`

```

{
    crate.volume = crate.height * crate.width * crate.length;
}

```

5. First, change the prototypes to the following:

```

// function to modify array object
void fill(std::array<double, Seasons> & pa);
// function that uses array object without modifying it
void show(const std::array<double, Seasons> & da);

```

Note that `show()` should use `const` to protect the object from being modified.

Next, within `main()`, change the `fill()` call to this:

```
fill(expenses);
```

There's no change to the `show()` call.



Next, the new `fill()` should look like this:

```
void fill(std::array<double, Seasons> & pa) // changed
{
    using namespace std;
    for (int i = 0; i < Seasons; i++)
    {
        cout << "Enter " << Snames[i] << " expenses: ";
        cin >> pa[i]; // changed
    }
}
```

Note that `(*pa)[i]` gets changed to the simpler `pa[i]`.

Finally, the only change to `show()` is to the function header:

```
void show(std::array<double, Seasons> & da)
```

6. a. This can be done by using a default value for the second argument:

```
double mass(double d, double v = 1.0);
```

It can also be done by using function overloading:

```
double mass(double d, double v);
double mass(double d);
```

- b. You can't use a default for the repeat value because you have to provide default values from right to left. You can use overloading:

```
void repeat(int times, const char * str);
void repeat(const char * str);
```

- c. You can use function overloading:

```
int average(int a, int b);
double average(double x, double y);
```

- d. You can't do this because both versions would have the same signature.

7. `template<class T>`

```
T max(T t1, T t2) // or T max(const T & t1, const T & t2)
{
    return t1 > t2? t1 : t2;
}
```

8. `template<> box max(box b1, box b2)`

```
{
    return b1.volume > b2.volume? b1 : b2;
}
```

9. `v1` is type `float`, `v2` is type `float &`, `v3` is type `float &`, `v4` is type `int`, and `v5` is type `double`. The literal `2.0` is type `double`, so the product `2.0 * m` is `double`.

## Answers to Chapter Review for Chapter 9

1.
  - a. `homer` is automatically an automatic variable.
  - b. `secret` should be defined as an external variable in one file and declared using `extern` in the second file.
  - c. `topsecret` could be defined as a static variable with internal linkage by prefacing the external definition with the keyword `static`. Or it could be defined in an unnamed namespace.
  - d. `beencalled` should be defined as a local static variable by prefacing a declaration in the function with the keyword `static`.
2. A `using` declaration makes available a single name from a namespace, and it has the scope corresponding to the declarative region in which the `using` declaration occurs. A `using` directive makes available all the names in a namespace. When you use a `using` directive, it is as if you have declared the names in the smallest declarative region containing both the `using` declaration and the namespace itself.

3. 

```
#include <iostream>
int main()
{
    double x;
    std::cout << "Enter value: ";
    while (! (std::cin >> x) )
    {
        std::cout << "Bad input. Please enter a number: ";
        std::cin.clear();
        while (std::cin.get() != '\n')
            continue;
    }
    std::cout << "Value = " << x << std::endl;
    return 0;
}
```

4. Here is the revised code:

```
#include <iostream>
int main()
{
    using std::cin;
    using std::cout;
    using std::endl;
```

```

double x;
cout << "Enter value: ";
while (! (cin >> x) )
{
    cout << "Bad input. Please enter a number: ";
    cin.clear();
    while (cin.get() != '\n')
        continue;
}
cout << "Value = " << x << endl;
return 0;
}

```

5. You could have separate static function definitions in each file. Or each file could define the appropriate `average()` function in an unnamed namespace.
6. 10  
4  
0  
Other: 10, 1  
another(): 10, -4
7. 1  
4, 1, 2  
2  
2  
4, 1, 2  
2

## Answers to Chapter Review for Chapter 10

1. A class is a definition of a user-defined type. A class declaration specifies how data is to be stored, and it specifies the methods (class member functions) that can be used to access and manipulate that data.
2. A class represents the operations you can perform on a class object with a public interface of class methods; this is abstraction. The class can use private visibility (the default) for data members, meaning that the data can be accessed only through the member functions; this is data hiding. Details of the implementation, such as data representation and method code, are hidden; this is encapsulation.
3. A class defines a type, including how it can be used. An object is a variable or another data object, such as that produced by `new`, which is created and used according to the class definition. The relationship between a class and an object is the same as that between a standard type and a variable of that type.

4. If you create several objects of a given class, each object comes with storage for its own set of data. But all the objects use the one set of member functions. (Typically, methods are public and data members are private, but that's a matter of policy, not of class requirements.)
5. This example use char arrays to hold the character data, but you could use string class objects instead.

```
// #include <cstring>

// class definition
class BankAccount
{
private:
    char name[40];    // or std::string name;
    char acctnum[25]; // or std::string acctnum;
    double balance;
public:
    BankAccount(const char * client, const char * num, double bal = 0.0);
//or BankAccount(const std::string & client,
//               const std::string & num, double bal = 0.0);

    void show(void) const;
    void deposit(double cash);
    void withdraw(double cash);
};
```

6. A class constructor is called when you create an object of that class or when you explicitly call the constructor. A class destructor is called when the object expires.
7. These are two possible solutions (note that you must include `cstring` or `string.h` in order to use `strncpy()` or else you must include `string` to use the `string` class):

```
BankAccount::BankAccount(const char * client, const char * num, double bal)
{
    strncpy(name, client, 39);
    name[39] = '\0';
    strncpy(acctnum, num, 24);
    acctnum[24] = '\0';
    balance = bal;
}
```

or

```
BankAccount::BankAccount(const std::string & client,
                        const std::string & num, double bal)
{
    name = client;
```

```

    acctnum = num;
    balance = bal;
}

```

Keep in mind that default arguments go in the prototype, not in the function definition.

8. A default constructor either has no arguments or has defaults for all the arguments. Having a default constructor enables you to declare objects without initializing them, even if you've already defined an initializing constructor. It also allows you to declare arrays.

9. // stock30.h
- ```

#ifndef STOCK30_H_
#define STOCK30_H_

class Stock
{
private:
    std::string company;
    long shares;
    double share_val;
    double total_val;
    void set_tot() { total_val = shares * share_val; }
public:
    Stock(); // default constructor
    Stock(const std::string & co, long n, double pr);
    ~Stock() {} // do-nothing destructor
    void buy(long num, double price);
    void sell(long num, double price);
    void update(double price);
    void show() const;
    const Stock & topval(const Stock & s) const;
    int numshares() const { return shares; }
    double shareval() const { return share_val; }
    double totalval() const { return total_val; }
    const string & co_name() const { return company; }
};

```

10. The `this` pointer is available to class methods. It points to the object used to invoke the method. Thus, `this` is the address of the object, and `*this` represents the object itself.

## Answers to Chapter Review for Chapter 11

1. Here's a prototype for the class definition file and a function definition for the methods file:

```
// prototype
Stonewt operator*(double mult);

// definition - let constructor do the work
Stonewt Stonewt::operator*(double mult)
{
    return Stonewt(mult * pounds);
}
```

2. A member function is part of a class definition and is invoked by a particular object. The member function can access members of the invoking object implicitly, without using the membership operator. A friend function is not part of a class, so it's called as a straight function call. It can't access class members implicitly, so it must use the membership operator applied to an object passed as an argument. Compare, for instance, the answer to Review Question 1 with the answer to Review Question 4.
3. It must be a friend to access private members, but it doesn't have to be a friend to access public members.

4. Here's a prototype for the class definition file and a function definition for the methods file:

```
// prototype
friend Stonewt operator*(double mult, const Stonewt & s);

// definition - let constructor do the work
Stonewt operator*(double mult, const Stonewt & s)
{
    return Stonewt(mult * s.pounds);
}
```

5. The following five operators cannot be overloaded:

```
sizeof
.
.*
::
?:
```

6. These operators must be defined by using a member function.

7. Here are a possible prototype and definition:

```
// prototype and inline definition
operator double () {return mag;}

```

Note, however, that it makes better sense to use the `magval()` method than to define this conversion function.

## Answers to Chapter Review for Chapter 12

1.
  - a. The syntax is fine, but this constructor leaves the `str` pointer uninitialized. The constructor should either set the pointer to `NULL` or use `new []` to initialize the pointer.
  - b. This constructor does not create a new string; it merely copies the address of the old string. It should use `new []` and `strcpy()`.
  - c. It copies the string without allocating the space to store it. It should use `new char[len + 1]` to allocate the proper amount of memory.
2. First, when an object of that type expires, the data pointed to by the object's member pointer remains in memory, using space and remaining inaccessible because the pointer has been lost. That can be fixed by having the class destructor delete memory allocated by `new` in the constructor functions. Second, after the destructor deletes such memory, it might end up trying to delete it twice if a program initializes one such object to another. That's because the default initialization of one object to another copies pointer values but does not copy the pointed-to data, and this produces two pointers to the same data. The solution is to define a class copy constructor that causes initialization to copy the pointed-to data. Third, assigning one object to another can produce the same situation of two pointers pointing to the same data. The solution is to overload the assignment operator so that it copies the data, not the pointers.
3. C++ automatically provides the following member functions:
  - A default constructor if you define no constructors
  - A copy constructor if you don't define one
  - An assignment operator if you don't define one
  - A default destructor if you don't define one
  - An address operator if you don't define one

The default constructor does nothing, but it allows you to declare arrays and uninitialized objects. The default copy constructor and the default assignment operator use memberwise assignment. The default destructor does nothing. The implicit address operator returns the address of the invoking object (that is, the value of the `this` pointer).

4. The personality member should be declared either as a character array or as a pointer-to-char. Or you could make it a `string` object or a `string` object. The declaration fails to make the methods public. Then there are several small errors. Here is a possible solution, with changes (other than deletions) in boldface:

```
#include <iostream>
#include <cstring>
using namespace std;
class nifty
{
private: // optional
    char personality[40]; // provide array size
    int talents;
public: // needed
// methods
    nifty();
    nifty(const char * s);
    friend ostream & operator<<(ostream & os, const nifty & n);
}; // note closing semicolon

nifty::nifty()
{
    personality[0] = '\0';
    talents = 0;
}

nifty::nifty(const char * s)
{
    strcpy(personality, s);
    talents = 0;
}

ostream & operator<<(ostream & os, const nifty & n)
{
    os << n.personality << '\n';
    os << n.talent << '\n';
    return os;
}
```

Here is another possible solution:

```
#include <iostream>
#include <cstring>
using namespace std;
class nifty
{
private: // optional
    char * personality; // create a pointer
```



```

        int talents;
public: // needed
// methods
    nifty();
    nifty(const char * s);
    nifty(const nifty & n);
    ~nifty() { delete [] personality; }
    nifty & operator=(const nifty & n) const;
    friend ostream & operator<<(ostream & os, const nifty & n);
}; // note closing semicolon

nifty::nifty()
{
    personality = NULL;
    talents = 0;
}

nifty::nifty(const char * s)
{
    personality = new char [strlen(s) + 1];
    strcpy(personality, s);
    talents = 0;
}

ostream & operator<<(ostream & os, const nifty & n)
{
    os << n.personality << '\n';
    os << n.talent << '\n';
    return os;
}

```

5.
  - a. Golfer nancy; // default constructor
 

```

Golfer lulu("Little Lulu"); // Golfer(const char * name, int g)
Golfer roy("Roy Hobbs", 12); // Golfer(const char * name, int g)
Golfer * par = new Golfer; // default constructor
Golfer next = lulu; // Golfer(const Golfer &g)
Golfer hazard = "Weed Thwacker"; // Golfer(const char * name, int g)
*par = nancy; // default assignment operator
nancy = "Nancy Putter"; // Golfer(const char * name, int g), then
// the default assignment operator
          
```

Note that some compilers additionally call the default assignment operator for Statements 5 and 6.

- b. The class should define an assignment operator that copies data rather than addresses.

## Answers to Chapter Review for Chapter 13

1. The public members of the base class become public members of the derived class. The protected members of the base class become protected members of the derived class. The private members of the base class are inherited but cannot be accessed directly. The answer to Review Question 2 provides the exceptions to these general rules.
2. The constructor methods are not inherited, the destructor is not inherited, the assignment operator is not inherited, and friends are not inherited.
3. If the return type were `void`, you would still be able to use single assignment but not chain assignment:

```
baseDMA magazine("Pandering to Glitz", 1);
baseDMA gift1, gift2, gift3;
gift1 = magazine;           // ok
gift 2 = gift3 = gift1;    // no longer valid
```

If the method returned an object instead of a reference, the method execution would be slowed a bit because the return statement would involve copying the object.

4. Constructors are called in the order of derivation, with the most ancestral constructor called first. Destructors are called in the opposite order.
5. Yes, every class requires its own constructors. If the derived class adds no new members, the constructor can have an empty body, but it must exist.
6. Only the derived-class method is called. It supersedes the base-class definition. A base-class method is called only if the derived class does not redefine the method or if you use the scope-resolution operator. However, you really should declare as virtual any functions that will be redefined.
7. The derived class should define an assignment operator if the derived-class constructors use the `new` or `new []` operator to initialize pointers that are members of that class. More generally, the derived class should define an assignment operator if the default assignment is incorrect for derived-class members.
8. Yes, you can assign the address of an object of a derived class to a pointer to the base class. You can assign the address of a base-class object to a pointer to a derived class (downcasting) only by making an explicit type cast, and it is not necessarily safe to use such a pointer.
9. Yes, you can assign an object of a derived class to an object of the base class. Any data members that are new to the derived type are not passed to the base type, however. The program uses the base-class assignment operator. Assignment in the

opposite direction (base to derived) is possible only if the derived class defines a conversion operator, which is a constructor that has a reference to the base type as its sole argument, or else defines an assignment operator with a base-class parameter.

10. It can do so because C++ allows a reference to a base type to refer to any type derived from that base.
11. Passing an object by value invokes the copy constructor. Because the formal argument is a base-class object, the base-class copy constructor is invoked. The copy constructor has as its argument a reference to the base class, and this reference can refer to the derived object passed as an argument. The net result is that a new base-class object whose members correspond to the base class portion of the derived object is produced.
12. Passing an object by reference instead of by value enables the function to avail itself of virtual functions. Also passing an object by reference instead of by value may use less memory and time, particularly for large objects. The main advantage of passing by value is that it protects the original data, but you can accomplish the same end by passing the reference as a `const` type.
13. If `head()` is a regular method, then `ph->head()` invokes `Corporation::head()`. If `head()` is a virtual function, then `ph->head()` invokes `PublicCorporation::head()`.
14. First, the situation does not fit the *is-a* model, so public inheritance is not appropriate. Second, the definition of `area()` in `House` hides the `Kitchen` version of `area()` because the two methods have different signatures.

## Answers to Chapter Review for Chapter 14

- |   |                                   |   |
|---|-----------------------------------|---|
| 1. <code>class Bear</code>                                  | <code>class PolarBear</code>      | Public; a polar bear is a kind of bear  |
| <code>class Kitchen</code>                                  | <code>class Home</code>           | Private; a home has a kitchen   |
| <code>class Person</code>                                   | <code>class Programmer</code>     | Public; a programmer is a kind of person  |
| <code>class Person</code>                                   | <code>class HorseAndJockey</code> | Private; a horse and jockey team contains a person  |
| <code>class Person,</code><br><code>class Automobile</code> | <code>class Driver</code>         | Person public because a driver is a person; Automobile private because a driver has an automobile |

```

2. Gloam::Gloam(int g, const char * s) : glip(g), fb(s) { }
   Gloam::Gloam(int g, const Frabjous & fr) : glip(g), fb(fr) { }
   // note: the above uses the default Frabjous copy constructor
   void Gloam::tell()
   {
       fb.tell();
       cout << glip << endl;
   }

```

```

3. Gloam::Gloam(int g, const char * s)
      : glip(g), Frabjous(s) { }
   Gloam::Gloam(int g, const Frabjous & fr)
      : glip(g), Frabjous(fr) { }
   // note: the above uses the default Frabjous copy constructor
   void Gloam::tell()
   {
       Frabjous::tell();
       cout << glip << endl;
   }

```

```

4. class Stack<Worker *>
   {
   private:
       enum {MAX = 10};           // constant specific to class
       Worker * items[MAX];      // holds stack items
       int top;                   // index for top stack item
   public:
       Stack();
       Boolean isempty();
       Boolean isfull();
       Boolean push(const Worker * & item); // add item to stack
       Boolean pop(Worker * & item);       // pop top into item
   };

```

```

5. ArrayTP<string> sa;
   StackTP< ArrayTP<double> > stck_arr_db;
   ArrayTP< StackTP<Worker *> > arr_stk_wpr;

```

Listing 14.18 generates four templates: `ArrayTP<int, 10>`, `ArrayTP<double, 10>`, `ArrayTP<int, 5>`, and `Array< ArrayTP<int, 5>, 10>`.

6. If two lines of inheritance for a class share a common ancestor, the class winds up having two copies of the ancestor's members. Making the ancestor class a virtual base class to its immediate descendants solves that problem.

## Answers to Chapter Review for Chapter 15

1.
  - a. The friend declaration should be as follows:
 

```
friend class clasp;
```
  - b. This needs a forward declaration so that the compiler can interpret `void snip(muff &)`:
 

```
class muff;    // forward declaration
class cuff {
public:
    void snip(muff &) { ... }
    ...
};
class muff {
    friend void cuff::snip(muff &);
    ...
};
```
  - c. First, the `cuff` class declaration should precede the `muff` class so that the compiler can understand the term `cuff::snip()`. Second, the compiler needs a forward declaration of `muff` so that it can understand `snip(muff &)`:
 

```
class muff;    // forward declaration
class cuff {
public:
    void snip(muff &) { ... }
    ...
};
class muff {
    friend void cuff::snip(muff &);
    ...
};
```
2. No. For Class A to have a friend that's a member function of Class B, the B declaration must precede the A declaration. A forward declaration is not enough because it would tell A that B is a class, but it wouldn't reveal the names of the class members. Similarly, if B has a friend that's a member function of A, the complete A declaration must precede the B declaration. These two requirements are mutually exclusive.
3. The only access to a class is through its public interface, which means the only thing you can do with a `Sauce` object is call the constructor to create one. The other members (`soy` and `sugar`) are private by default.
4. Suppose the function `f1()` calls the function `f2()`. A return statement in `f2()` causes program execution to resume at the next statement following the `f2()` function call in function `f1()`. A `throw` statement causes the program to back up

through the current sequence of function calls until it finds a `try` block that directly or indirectly contains the call to `f2()`. This might be in `f1()` or in a function that called `f1()`, and so on. Once there, execution goes to the next matching `catch` block, not to the first statement after the function call.

5. You should arrange the `catch` blocks in order, from most derived class to least derived.
6. For Sample #1, the `if` condition is `true` if `pg` points to a `Superb` object or to an object of any class descended from `Superb`. In particular, it is also `true` if `pg` points to a `Magnificent` object. In Sample #2, the `if` condition is `true` only for a `Superb` object, not for objects derived from `Superb`.
7. The `dynamic_cast` operator only allows upcasting in a class hierarchy, whereas a `static_cast` operator allows both upcasting and downcasting. The `static_cast` operator also allows conversions from enumeration types to integer types, and vice versa, and between various numeric types.

## Answers to Chapter Review for Chapter 16

```
1. #include <string>
   using namespace std;
   class RQ1
   {
   private:
       string st;          // a string object
   public:
       RQ1() : st("") {}
       RQ1(const char * s) : st(s) {}
       ~RQ1() {}
   // more stuff
   };
```

The explicit copy constructor, destructor, and assignment operator are no longer needed because the `string` object provides its own memory management.

2. You can assign one `string` object to another. A `string` object provides its own memory management so that you normally don't have to worry about a string exceeding the capacity of its holder.
3. #include <string>
 #include <cctype>
 using namespace std;
 void ToUpper(string & str)

```

{
    for (int i = 0; i < str.size(); i++)
        str[i] = toupper(str[i]);
}

```

4.

```

auto_ptr<int> pia= new int[20]; // wrong, use with new, not new[]
auto_ptr<string>(new string); // wrong, no name for pointer
int rigue = 7;
auto_ptr<int>(&rigue); // wrong, memory not allocated by new
auto_ptr dbl (new double); // wrong, omits <double>

```
5. The LIFO aspect of a stack means you might have to remove a lot of clubs before reaching the one you need.
6. The set will store just one copy of each value, so, say, five scores of 5 would be stored as a single 5.
7. Using iterators allows you to use objects with a pointer-like interface to move through data that is organized in some fashion other than an array (for example, data in a doubly linked list).
8. The STL approach allows STL functions to be used with ordinary pointers to ordinary arrays as well as with iterators to STL container classes, thus increasing generality.
9. You can assign one `vector` object to another. A `vector` manages its own memory, so you can insert items into a vector and have it resize itself automatically. By using the `at()` method, you can get automatic bounds checking.
10. The two `sort()` functions and the `random_shuffle()` function require a random access iterator, whereas a `list` object just has a bidirectional iterator. You can use the list template class `sort()` member functions (see Appendix G, “The STL Methods and Functions”) instead of the general-purpose functions to do the sorting, but there is no member function equivalent to `random_shuffle()`. However, you could copy the list to a vector, shuffle the vector, and copy the results back to the list.

## Answers to Chapter Review for Chapter 17

1. The `iostream` file defines the classes, constants, and manipulators used to manage input and output. These objects manage the streams and buffers used to handle I/O. The file also creates standard objects (`cin`, `cout`, `cerr`, and `clog` and their wide-character equivalents) used to handle the standard input and output streams connected to every program.

- Keyboard entry generates a series of characters. Typing **121** generates three characters, each represented by a 1-byte binary code. If the value is to be stored as type `int`, these three characters have to be converted to a single binary representation of the value 121.
- By default, both the standard output and the standard error send output to the standard output device, typically a monitor. If you have the operating system redirect output to a file, however, the standard output connects to the file instead of to the screen, but the standard error continues to be connected to the screen.
- The `ostream` class defines a version of the `operator<<()` function for each basic C++ type. The compiler interprets an expression like  
`cout << spot`

as the following:

```
cout.operator<<(spot)
```

It can then match this method call to the function prototype that has the same argument type.

- You can concatenate output methods that return type `ostream &`. This causes the invoking of a method with an object to return that object. The returned object can then invoke the next method in a sequence.
- ```
//rq17-6.cpp
#include <iostream>
#include <iomanip>
```

```
int main()
{
    using namespace std;
    cout << "Enter an integer: ";
    int n;
    cin >> n;
    cout << setw(15) << "base ten" << setw(15)
        << "base sixteen" << setw(15) << "base eight" << "\n";
    cout.setf(ios::showbase); // or cout << showbase;
    cout << setw(15) << n << hex << setw(15) << n
        << oct << setw(15) << n << "\n";

    return 0;
}
```



```

7. //rq17-7.cpp
#include <iostream>
#include <iomanip>

int main()
{
    using namespace std;
    char name[20];
    float hourly;
    float hours;

    cout << "Enter your name: ";
    cin.get(name, 20).get();
    cout << "Enter your hourly wages: ";
    cin >> hourly;
    cout << "Enter number of hours worked: ";
    cin >> hours;

    cout.setf(ios::showpoint);
    cout.setf(ios::fixed, ios::floatfield);
    cout.setf(ios::right, ios::adjustfield);
    // or cout << showpoint << fixed << right;
    cout << "First format:\n";
    cout << setw(30) << name << ": $" << setprecision(2)
        << setw(10) << hourly << ":" << setprecision(1)
        << setw(5) << hours << "\n";
    cout << "Second format:\n";
    cout.setf(ios::left, ios::adjustfield);
    cout << setw(30) << name << ": $" << setprecision(2)
        << setw(10) << hourly << ":" << setprecision(1)
        << setw(5) << hours << "\n";

    return 0;
}

```

8. Here is the output:

```
ct1 = 5; ct2 = 9
```

The first part of the program ignores spaces and newline characters; the second part doesn't. Note that the second part of the program begins reading at the newline character following the first `q`, and it counts that newline character as part of its total.

9. The `ignore()` form filters if the input line exceeds 80 characters. In that case, it skips only the first 80 characters.

## Answers to Chapter Review for Chapter 18

```

1. class Z200
   {
   private:
       int j;
       char ch;
       double z;
   public:
       Z200(int jv, char chv, zv) : j(jv), ch(chv), z(zv) {}
       ...
   };

   double x {8.8}; // or = {8.8}
   std::string s {"What a bracing effect!"};
   int k{99};
   Z200 zip{200, 'Z', 0.67};
   std::vector<int> ai {3, 9, 4, 7, 1};

```

2. `r1(w)` is valid, and the argument `rx` refers to `w`.

`r1(w+1)` is valid, and the argument `rx` refers to a temporary initialized to the value of `w+1`.

`r1(up(w))` is valid, and the argument `rx` refers to a temporary initialized to the return value of `up(w)`.

In general, if an lvalue is passed to a `const` lvalue reference parameter, the parameter is initialized to the lvalue. If an rvalue is passed to the function, a `const` lvalue reference parameter refers to a temporary copy of the value.

`r2(w)` is valid, and the argument `rx` refers to `w`.

`r2(w+1)` is an error because `w+1` is an rvalue.

`r2(up(w))` is an error because the return value of `up(w)` is an rvalue.

In general, if an lvalue is passed to a `non-const` lvalue reference parameter, the parameter is initialized to the lvalue. But a `non-const` lvalue reference parameter can't accept an rvalue function argument.

`r3(w)` is an error because an rvalue reference cannot refer to an lvalue, such as `w`.

`r3(w+1)` is valid, and `rx` refers to the temporary value of the expression `w+1`.

`r3(up(w))` is valid, and `rx` refers to the temporary return value of `up(w)`

```

3. a. double & rx
      const double & rx
      const double & rx

```

The non-const lvalue reference matches the lvalue argument `w`. The other two arguments are rvalues, and the const lvalue reference can refer to copies of them.

- b. `double & rx`  
`double && rx`  
`double && rx`

The lvalue reference matches the lvalue argument `w`, and the rvalue references matches the two rvalue arguments.

- c. `const double & rx`  
`double && rx`  
`double && rx`

The const lvalue reference matches the lvalue argument `w`, and the rvalue reference matches the two rvalues.

In short, a non-const lvalue parameter matches an lvalue argument, a non-const rvalue parameter matches an rvalue argument, and a const lvalue parameter can match either an lvalue or an rvalue argument, but the compiler will prefer the first two choices, if available.

4. They are the default constructor, the copy constructor, the move constructor, the destructor, the copy assignment operator, and the move assignment operator. They are special because the compiler can automatically provide defaulted versions of these functions, depending on the context.
5. A move constructor can be used when it makes sense to transfer ownership of data instead of copying it, but there is no mechanism for transferring ownership of a standard array. If the `Fizzle` class used a pointer and dynamic memory allocation, then one can transfer ownership by reassigning the address of the data to a new pointer.

6. 

```
#include <iostream>
#include <algorithm>
template<typename T>
void show2(double x, T fp) {std::cout << x << " -> " << fp(x) << '\n';}
int main()
{
    show2(18.0, [](double x){return 1.8*x + 32;});
    return 0;
}
```

```
7. #include <iostream>
#include <array>
#include <algorithm>
const int Size = 5;
template<typename T>
void sum(std::array<double,Size> a, T& fp);
int main()
{
    double total = 0.0;
    std::array<double, Size> temp_c = {32.1, 34.3, 37.8, 35.2, 34.7};
    sum(temp_c, [&total](double w){total += w;});
    std::cout << "total: " << total << '\n';
    std::cin.get();
    return 0;
}
template<typename T>
void sum(std::array<double,Size> a, T& fp)
{
    for(auto pt = a.begin(); pt != a.end(); ++pt)
    {
        fp(*pt);
    }
}
```

*This page intentionally left blank*

# Index

## Symbols

---

**<=**, 217

**+** (addition operator), overloading, 569-572

**-=** (assignment operator), 212

**\*=** (assignment operator), 212

**+=** (assignment operator), 211

**%=** (assignment operator), 212

**/=** (assignment operator), 212

**=** (assignment operator), 43-44, 644, 767-768, 772-775

compared to equality operator, 218-220

custom definitions, 645-646

enumerator values, setting, 152

overloading, 652-658

sayings1.cpp, 656

string1.cpp, 653-656

string1.h, 652-653

potential problems, 645

strings, 133-134

structures, 145-146

when to use, 644

**&** (bitwise AND operator), 1239-1240

**~** (bitwise negation operator), 1237

**|** (bitwise OR operator), 1237-1238

**^** (bitwise XOR operator), 1238

**{}** (braces), 258

**[]** (brackets), 649-651

**,** (comma operator), 214-217

example, 214-216

precedence, 217

**/\*...\*/** comment notation, 33

**//** comment notation, 27, 32

**+** (concatenation operator), strings, 133-134

**?:** (conditional operator), 273-274

**--** (decrement operator), 207-208

pointers, 210-211

postfixing, 209-210

prefixing, 209-210

**\*** (dereferencing operator), 155-159

pointers, 171-172

**/** (division operator), 100-101

**==** (equality operator), 217

compared to assignment operator, 218-220

**++** (increment operator), 197, 207-208

pointers, 210-211

postfixing, 209-210

prefixing, 209-210

**!=** (inequality operator), 217

**&&** (logical AND operator), 262

alternative representations, 270

example, 263-265

precedence, 269-270

ranges, 265-267

**!** (logical NOT operator), 267-269

alternative representations, 270

precedence, 269

**||** (logical OR operator), 260-262

alternative representations, 270

example, 261-262

**-]\*** (member dereferencing operator), 1243-1246

**.\*** (member dereferencing operator), 1243-1246

**%** (modulus operator), 101-102

**\*** (multiplication operator), overloading, 574-578

**\n** newline character, 38-39

**<** operator, 217

**.** (period), 255

**#** (pound sign), 234

**"** (quotation marks), 36

**&** (reference operator), 383-386

**]]=** (right shift and assign operator), 1237

**]])(right shift operator), 1236**

**::** (scope resolution operator), 467, 514, 1332,

**;** (semicolon), 29-30

- (subtraction operator), overloading, 574-578
- ~ (tilde), 529
- \_ (underscore), 1222

## A

---

- ABCs (abstract base classes), 746-749**
  - ABC philosophy, 756
  - AcctABC example, 749-751, 754-755
  - enforcing interface rules with, 757
- abort() function, 897-898, 928-930**
- abstract data types (ADTs), 552**
- abstraction, 507. See also classes**
- access control, 892**
- access control (classes), 511-513**
- accessing**
  - content of template and parameter packs, 1198-1199
  - strings, 1259
- AcctABC class, 749-751, 754-755**
- acctabc.cpp, 751**
- acctabc.h, 750**
- accumulate() function, 1320**
- acquire() function, 516**
- actual arguments, 314**
- adaptable binary functions, 1035**
- adaptable binary predicate, 1035**
- adaptable functors, 1032**
- adaptable generators, 1035**
- adaptable predicate, 1035**
- adaptable unary functions, 1035**
- adapters, 1002**
- adding vectors, 590**
- addition operator (+), overloading, 569-572**
- addpntrs.cpp, 167**
- address.cpp, 154**
- addresses**
  - addresses of functions, obtaining, 362
  - of arrays, 170
  - structure addresses, passing, 351-353
- adjacent\_difference() function, 1321-1322**
- adjacent\_find() function, 1287, 1290**
- ADTs (abstract data types), 552-557**
- algorithms, 1035**
  - copying, 1036
  - groups, 1035-1036
  - in-place, 1036
  - properties, 1036-1037

- aliases**
  - creating, 230
  - declarations, 1157
  - namespaces, 491
- align.cpp, 1246**
- alignof() operator, 1204**
- allocating memory, 968**
  - bad\_alloc exceptions, 921
  - dynamic memory allocation, 757
    - derived class does use new, 758-760
    - derived class doesn't use new, 757-758
    - example, 761-766
    - new operator, 160-162
- allocators, 979**
- alternative tokens, table of, 1222**
- American National Standards Institute (ANSI), C++ standard, 16**
- American Standard Code for Information Interchange. See ASCII character set**
- ampersand (&), 1239-1240**
  - logical AND operator (&&), 262
    - alternative representations, 270
    - example, 263-265
    - precedence, 269-270
    - ranges, 265-267
  - reference operator (&), 383-386
- AND operators**
  - bitwise AND (&), 1239-1240
  - logical AND (&&), 262
    - alternative representations, 270
    - example, 263-265
    - precedence, 269-270
    - ranges, 265-267
- and.cpp, 263-264**
- angle brackets, 1162**
- anonymous unions, 150**
- ANSI (American National Standards Institute), C++ standard, 16**
- ANSI C Standard Input/Output, 1062**
- append() method, 1265**
- append.cpp, 1125**
- appending**
  - data to files, 1125-1127
  - strings, 133-134, 1265-1266
- applications. See also compilers**
  - creating, 18-19

- portability, 15, 17-18
  - ANSI/ISO standard, 16
  - limitations, 16
- source code, 19
  - file extensions, 20
- apply() method, 1046**
- Area() method, 748**
- args, 1198**
- argument lists, 30**
- arguments, 31**
  - arrays, 322-325
  - C-style strings, 339-341
  - command-line, 1119-1120
  - default arguments, 409-412
  - formal/actual, 314
  - multiple, 314-320
    - n\_chars() example, 314-317
    - probability() example, 318-320
  - parameters, 314
  - passing by reference, 386, 389-390
  - passing by value, 313-314
  - reference arguments, 392-394, 408-409
  - two-dimensional arrays, 337-339
  - type conversions, 106
- arguments (functions), 49, 53**
- arith.cpp, 98**
- arithmetic, pointers, 167-172**
- arithmetic operators, 97-99**
  - associativity, 99-100
  - division (/), 100-101
  - functor equivalents, 1031-1032
  - modulus (%), 101-102
  - order of precedence, 99-100
  - overloading
    - addition operator (+), 569-572
    - multiplication operator (\*), 574-578, 600
    - subtraction operator (-), 574-578
    - vector class, 599-600
- array notation, 173**
- array objects, 355**
  - fill function, 357
  - versus arrays, 188-189
  - versus vector objects, 188-189
- array template class, 187**
- ArrayDb class, 791**
- arraynew.cpp, 166**
- arrayone.cpp, 117**

- arrays**
  - addresses, 170
  - array notation, 173
  - arrays of objects, 546-549
    - declaring, 546
    - example, 547-549
    - initializing, 546
  - as function arguments, 322-325
  - const keyword, 327-328
  - declaring, 116-119
  - defined, 77, 116
  - design decisions, 325-326
  - displaying contents of, 327-328
  - dynamic arrays, 172-173
    - creating, 164-165
    - sample program, 165-167
  - examples, 328-331
  - filling, 326-327
  - function idioms, 331
  - functions and, 320-321
  - indexes, 117
  - initializing, 117-120
    - in C++11, 120
  - modifying, 328
  - naming, 172
  - one-dimensional arrays, 244
  - pointer arithmetic, 167-172
  - pointers, 321-322
  - ranges, 332-334
  - static binding, 172
  - strings, 123-124
    - initializing, 121
  - structures, 147-148
  - subscripts, 117
  - templates, non-type arguments, 843-845
  - two-dimensional arrays, 244-249, 337-339
    - declaring, 244-246
    - initializing, 246-249
  - variable arrays, 1329
  - versus vector objects, 188-189
- arraytp.h, 843-844**
- arrfun1.cpp, 321**
- arrfun2.cpp, 323**
- arrfun3.cpp, 328**
- arrfun4.cpp, 332**
- arrstruc.cpp, 147-148**



**ASCII character set, table of, 1225-1229****assert, 1204****assign\_st.cpp, 145****assign() method, 1266, 1278****assignable objects, 1008****assigning**

strings, 1266

values to pointers, 171

values to variables, 43

variable values, 43

**assignment**

string class, 133-134

type conversions, 103-104

**assignment methods, 1260****assignment operator (=), 43-44, 644, 767-768, 772-775**compared to equality operator,  
218-220

custom definitions, 645-646

enumerator values, setting, 152

enumerators, value ranges, 153

overloading, 652-658

sayings1.cpp, 656

string1.cpp, 653-656

string1.h, 652-653

potential problems, 645

strings, 133-134

structures, 145-146

when to use, 644

**assignment operators, combination****assignment operators, 211-212****assignment statements, 43-44****assignments, 1172-1173****associative containers, 1018, 1026**

methods, 1281-1284

multimap, 1023-1025

set, 1019-1022

**associativity, arithmetic operators, 99-100****associativity of operators, 1231**

examples, 1234

table of, 1232-1234

asterisk (\*), dereferencing operator  
(\*)155, 159

pointers171-172

**at() method, 1259****atan() function, 348****atan2() function, 348****ATM queue simulation**

bank.cpp simulation, 695

Customer class, 694

Queue class

class declaration, 691

public interface, 679

**ATM queue simulation, 678**

bank.cpp simulation, 694-698

Customer class, 690-691

Queue class

class declaration, 694

design, 679

implementation, 680-682

methods, 682-690

public interface, 680

**auto, 370**

declarations, 1155

**auto declarations, 109****auto keyword, 472****auto ptr, 1158****auto.cpp, 456-457****automatic memory storage, 182****automatic sizing (strings), 966-967****automatic teller machine simulation. See****ATM queue simulation****automatic type conversion. See type  
conversion****automatic variables, 182, 314, 453-457**

example, 455-457

initializing, 458

stacks, 458-459

**autoptr template, 1333****auto\_ptr class, 969, 973-975**

versus unique\_ptr, 975-977

**average() function, 800**

---

**B**

---

**back insert iterators, 1005-1007****bad() method, 296****bad() stream state method, 1098-1102****badbit stream state, 1097-1102****bad\_alloc exceptions, 921****Balance() function, 731****bank.cpp, 695-697****bank.cpp simulation, 694-698****Base 10 notation, 1215**

**Base 16 notation, 1216**

- binary equivalents, 1217-1218

**Base 2 notation, 1217**

- hexadecimal equivalents, 1217-1218

**Base 8 notation, 1215-1216****base classes**

- ABCs (abstract base classes), 746-749

- ABC philosophy, 756

- AcctABC example, 749-751, 754-755

- enforcing interface rules with, 757

- components, initializing, 798-799

- friends, accessing, 801-804

- methods, accessing, 800-801

- objects, accessing, 801

- relationships with derived classes, 718-720

- TableTennisPlayer example, 708-710

- using declarations, 807-808

- virtual, methods, 826

- virtual base classes, 815-817

- combining with nonvirtual base classes, 828

- constructors, 817-818

- dominance, 828-829

- methods, 818-828

**base-class functions, 777****begin() method, 981-984, 1251-1252, 1275****best matches, 432-434****bidirectional iterators, 998****Big Endian, 1218****bigstep.cpp, 205****binary files, 1127-1133****binary functions, 1027-1030****binary numbers, 1217**

- hexadecimal equivalents, 1217-1218

**binary operators, 601, 1234****binary predicates, 1027, 1030****binary search operations**

- binary\_search() function, 1304, 1310

- equal\_range() function, 1304, 1309

- lower\_bound() function, 1304, 1309

- upper\_bound() function, 1304, 1309

**binary searching**

- binary\_search() function, 1304, 1310

- equal\_range() function, 1304, 1309

- lower\_bound() function, 1304, 1309

- upper\_bound() function, 1304, 1309

**binary.cpp, 1131****binary\_search() function, 1304, 1310****binding**

- dynamic binding, 173, 737, 739-740

- static binding, 172, 737, 740

**bit fields, 148****bit values, represented by constants, 1085****bitmask data type, 1085****bits, 68-69**

- clearing, 1086

- testing, 1241-1242

- toggling, 1241

- turning off, 1241

- turning on, 1241

**bitwise AND operator (&), 1239-1240****bitwise negation operator (~), 1237****bitwise operators, 1235**

- alternative representations, 1240

- logical bitwise operators, 1237-1240

- shift operators, 1235-1237

- overloading, 581-587

- testing bit values, 1241-1242

- toggling, 1241

- turning bits off, 1241

- turning bits on, 1241

**bitwise OR operator (|), 1237-1238****bitwise XOR operator (^), 1238****block scope, 454****block.cpp, 212****blocks, 212-214****body (function), 29**

- for loops, 196-197

**bondini.cpp, 86****books, 1323-1324****bool data type, 90****boolalpha manipulator, 1090****Boost project, 1205-1207****bottom-up programming, 13, 331****bound template friend functions, 861-864****braces {}, 258****bracket notation, 649-651****brackets, angle brackets, 1162****branching statements**

- if, 254

- bug prevention, 260

- example, 255

- syntax, 254

- if else
  - example, 256–257
  - formatting, 257–258
  - if else if else construction, 258–260
  - syntax, 255
- switch, 274
  - enumerators as labels, 278–280
  - example, 275–278
  - syntax, 275
- Brass class**
  - class declaration, 723–727, 730–733
  - virtual destructors, 737
  - virtual method behavior, 734–736
- brass.cpp, 727**
- brass.h, 724**
- BrassPlus class**
  - class declaration, 723–726
  - class implementation, 727, 730–731
  - class objects, 732–733
  - virtual destructors, 737
  - virtual method behavior, 734–736
- break statement, 280–282**
- bucks() function, 53**
- buffers, 1063–1064, 1067**
  - flushing, 1063
- Build All option (compiler), 24**
- buildstr() function, 341**
- buy() function, 516**
- bytes, 69**

---

## C

- C language**
  - ANSI C, 17
  - classic C, 17
  - development history, 11
  - programming philosophy, 11–13
- C++, Macintosh, 25**
- C++ FAQ Lite, 1325**
- C++ FAQs, Second Edition, 1323**
- The C++ Programming Language, Third Edition, 1324***
- The C++ Standard Library: A Tutorial and Reference, 1323–1324***
- C++ Templates: The Complete Guide, 1324***
- C++11**
  - arrays, initializing, 120
  - auto declarations, 109
  - basic assignments, 1260
  - constructors
    - initialization list, 1258
    - Rvalue reference, 1256
  - container requirements, 1010
  - containers, unordered associative containers, 1283
  - exception specifications, 908
  - initializer\_list template, 1051–1053
  - libraries, 1203
  - list initialization, 537
  - noexcept, 1248
  - range-based loops, 233–234
  - scoped enumerations, 551–552
  - STL, 1271
    - containers, 1271–1273
    - structure initialization, 144
    - template aliases, 866
- C-style strings, 120–122**
  - in arrays, 123–124
  - combining with numeric input, 130–131
  - concatenating, 122
  - empty lines, 130
  - failbits, 130
  - null characters, 121
  - passing as arguments, 339–341
  - pointers, 173–178
  - returning from functions, 341–343
  - string input, entering, 124–126
  - string input, reading with get(), 127–130
  - string input, reading with getline(), 126–127
- C-style strings, comparing, 220–223**
- call signatures, 1194**
- calling**
  - class member functions, 523
  - constructors, 526–527
  - functions, 309–311
    - pointers, 363–364
- calling functions, 30, 49**
- calling.cpp, 306**
- callme1() function, 636**
- callme2() function, 636**
- capacity() method, 966, 1251, 1279**
- caret (^), 1238**
- carrots.cpp, 41**

- case sensitivity, 27, 32**
- casting, 1330-1331**
  - downcasting, 738
  - upcasting, 738
    - implicit upcasting, 807
- casting data types, 606-610, 612**
- casting types, 107-109**
- catch keyword, 900**
- catching exceptions, 900, 916-917**
- CC compiler (UNIX), 21-22**
- cctype library, 270-272**
- cctypes.cpp, 271-272**
- cerr object, 1067**
- cfront translator, 21**
- char data type, 80-87, 1064**
  - escape sequences, 84-87
  - signed char, 88-89
  - universal character names, 87-88
  - unsigned char, 88-89
  - wchar\_t, 89
- character strings, 36**
- characters**
  - ASCII character set, table of, 1225-1229
  - fill, 1081-1082
- chartype.cpp, 81**
- CHAR\_BIT constant, 72**
- CHAR\_MAX constant, 72**
- char\_type type, 1250**
- check\_it.cpp, 1096**
- cheers() function, 307-309**
- choices.cpp, 188**
- choosing integer types, 76-77**
- cin, cin.get() function, 235-237, 241-244**
- cin object, 1067, 1093-1095**
  - get() function, 128-130
  - getline() function, 126-127
  - loops, 234-235
  - operator overloading, 1095-1097
  - stream states, 1097-1098
    - effects, 1100-1102
    - exceptions, 1099-1100
    - setting, 1098
- cin statement, 46**
- cin.get() function, 235-237, 241-244, 317**
- cin.get() member function, 1103-1105**
- cin.get(ch) function, 317**
- cinexcp.cpp, 1099**
- cinfish.cpp, 283-284**
- cingolf.cpp, 285-286**
- class declaration, 511-513**
- class inheritance, private inheritance, 797**
  - base-class components, initializing, 798-799
  - base-class friends, accessing, 801-804
  - base-class methods, accessing, 800-801
  - base-class objects, accessing, 801
  - compared to containment, 806
  - Student class example, 798, 804-805
- class keyword, 831**
- class member functions, operator overloading, 587-588**
- class scope, 454, 514, 549-551**
- class templates, 830-837**
  - arrays, non-type arguments, 843-845
  - complex, 1045
  - explicit instantiations, 850
  - explicit specializations, 850-851
  - friend classes, 858
    - bound template friend functions, 861-864
    - non-template friend functions, 858-861
    - unbound template friend functions, 864-865
  - implicit instantiations, 850
  - member templates, 854-855
  - parameters, 855-858
  - partial specializations, 851-852
  - pointers, stacks of pointers, 837-843
  - versatility, 845-846
    - default type parameters, 849
    - multiple type parameters, 847
    - recursive use, 846-847
- classes, 47-48, 508, 520, 1159**
  - ABCs (abstract base classes), 746-749
    - ABC philosophy, 756
    - AcctABC example, 749-751, 754-755
    - enforcing interface rules with, 757
  - abstraction, 507
  - access control, 511-513
  - AcctABC, 749-751, 754-755
  - ADTs (abstract data types), 552-557
  - array template class, 187
  - ArrayDb, 791
  - auto\_ptr, 969, 973-975

- bad\_alloc, 921
- base classes
  - components, initializing, 798-799
  - friends, accessing, 801-804
  - methods, accessing, 800-801
  - objects, accessing, 801
  - using declarations, 807-808
  - virtual base classes, 815-829
- Brass
  - class declaration, 723-726
  - class implementation, 727, 730-731
  - class objects, 732-733
  - virtual destructors, 737
  - virtual method behavior, 734-736
- BrassPlus
  - class declaration, 723-726
  - class implementation, 727, 730-731
  - class objects, 732-733
  - virtual destructors, 737
  - virtual method behavior, 734-736
- class scope, 549-551
- client files, 533-536
- compared to structures, 514
- constructors, 524, 538-539, 768
  - calling, 526-527
  - conversion, 769-770
  - copy constructors, 639-644, 767
  - declaring, 525-526
  - default constructors, 527-528, 638-639, 766-767
  - defining, 525-526
  - delegating, 1180-1181
  - inheriting, 1181-1183
  - new operator, 659-661, 677-678
- converting class type, 677
- Customer, 690-691, 694
- data hiding, 511-513, 523
- data types, 507-508
- declarations, 509-511, 522
- defaulted and deleted methods, 1179-1180
- defined, 36, 47, 508
- defining, 47
- definition of, 13
- derived classes, 405
- destructors, 524, 528-529, 538-539, 768
- encapsulation, 512, 523
- exception, 917
- explicit conversion operators, 1159-1160
- friend classes, 578-580, 877, 880-883, 886-888
  - compared to class member functions, 886
  - templates, 858-865
  - Tv class example, 878-883
- header files, 530
- ifstream, 1116-1119
- implementation files, 530
- inheritance
  - assignment operators, 772-775
  - base classes, 708-710, 718-720
  - constructors, 713-715
  - derived classes, 711-712, 716-720
  - exceptions, 922-927
  - has-a relationships, 721
  - is-a relationships, 720-722, 772
  - multiple, 814, 826
  - what's not inherited, 772
- ios, 1065
- iostream, 1065
- ios\_base, 1065
  - constants representing bit values, 1085
- istream, 47, 1065
  - data types recognized, 1093-1095
  - input methods, 1109-1114
  - single-character input, 1102-1106
  - string input, 1106-1108
- member functions
  - const member functions, 537
  - const objects, 662-665
  - constructors, 524-528, 538-539, 638-639, 659-661, 677-678
  - copy constructors, 639-644
  - definitions, 509, 514-516, 523
  - destructors, 528-529, 538-539
  - friend member functions, 883-886, 888-889
  - implicit member functions, 637-638
  - inline functions, 517-518
  - invoking, 523
  - non-const objects, 663
  - object membership, 518
  - objects, returning, 662-665

- private, 513
- properties, 777-778
- public, 513
- qualified names, 514
- this pointer, 539-546
- unqualified names, 514
- member in-class initialization, 1160
- nested classes, 682, 889-891
  - access control, 892
  - scope, 891-892
  - templates, 892-896
- objects, 786-788
  - contained objects, 791-795
  - subobjects, 797
- ofstream, 1115-1119
- ostream, 47, 1065
- ostreamstream, 1142, 1144-1145
- pointers, member dereferencing operators, 1242-1246
- private inheritance
  - base-class components, initializing, 798-799
  - base-class friends, accessing, 801-802, 804
  - base-class methods, accessing, 800-801
  - base-class objects, accessing, 801
  - Student class example, 798
- protected classes, 745-746, 775
- Queue
  - class declaration, 691-694
  - design, 679
  - implementation, 680-682
  - methods, 682-690
  - public interface, 679-680
- Sales
  - sales.cpp, 924
  - sales.h, 922
  - use\_sales.cpp, 925-927
- sample program, 518-520
- special member functions, 1178-1179
- Stack, 831-836
  - pointers, 837-843
- static class members, 628-637
- stdexcept exception classes, 918-920
- Stock, 511
- streambuf, 1065
- string, 131-133, 353-354, 647, 952, 960, 965-966, 1333
  - appending, 133-134
  - assignment, 133-134
  - assignment operator, overloading, 652-658
  - automatic sizing, 966-967
  - bracket notation, 649-651
  - comparing, 960
  - comparison members, 648-649
  - complex operations, 135-136
  - concatenation, 133-134
  - constructors, 952-956
  - default constructor, 647-648
  - finding size of, 960
  - Hangman sample program, 962-965
  - input, 957-960
  - reading line by line, 136-140
  - searching, 960-961
  - static class member functions, 651-652
  - STL interface, 1038-1039
  - string comparisons, 223-224
  - structures, 144-145
- StringBad, 628
  - constructors, 632-633
  - destructor, 633
  - strngbad.cpp, 630-631
  - strngbad.h, 628-629
  - vegnews.cpp sample program, 633-637
- Student
  - contained objects interfaces, 792-795
  - contained objects, initializing, 791
  - design, 787-788
  - methods, 793-795
  - private inheritance, 798-805
  - sample program, 795-797
  - studentc.h, 789-790
- TableTennisPlayer, 708
  - tabtenn0.cpp, 709
  - tabtenn0.h, 708
  - uset0.cpp, 710
- this pointer, 539-546
- Tv, 878-879, 883
  - tv.cpp, 880-882
  - tv.h, 879-880
  - tvfm.h, 885-886
  - use\_tv.cpp, 882

- type casts, 606-612
- type conversions, 606-612
  - applying automatically, 616-618
  - conversion functions, 612-616
  - friends, 618-621
  - implicit conversion, 609
- type info, 939-944
- valarray, 786-787, 1045-1046, 1049-1051
- vector, 120, 588-590, 600, 979-991, 1045-1046, 1049-1051
  - adding elements to, 982-983
  - adding vectors, 590
  - declaring, 591-592
  - displacement vectors, 589
  - implementation comments, 602
  - member functions, 592, 597
  - multiple representations, 599
  - overloaded arithmetic operators, 599-600
  - overloading overloaded operators, 601
  - past-the-end iterators, 981-982
  - Random Walk sample program, 602, 605-606
  - removing ranges of, 982
  - shuffling elements in, 987
  - sorting, 987
  - state members, 597-599
  - vect1.cpp example, 980-981
  - vect2.cpp sample program, 984-986
  - vect3.cpp sample program, 988-991
- vector template class, 186-187
- virtual methods
  - final, 1183-1184
  - override, 1183-1184
- Worker, 810-814
- classic C, 17**
- classifying data types, 97**
- clear() method, 1258, 1278, 1283**
- clear() stream state method, 1098-1102**
- clearing bits, 1086**
- client files, creating, 533-536**
- client/server model, 520**
- climits header file, 71-73**
- clock() function, 229**
- clog object, 1067**
- close() method, 292**
- code formatting, 39**
  - source code style, 40
  - tokens, 39
  - white space, 39
- code listings**
  - acctabc.cpp, 751
  - acctabc.h, 750
  - addpntrs.cpp, 167
  - address.cpp, 154
  - align.cpp, 1246
  - and.cpp, 263-264
  - append.cpp, 1125
  - arith.cpp, 98
  - arraynew.cpp, 166
  - arrayone.cpp, 117
  - arraytp.h, 843-844
  - arrfun1.cpp, 321
  - arrfun2.cpp, 323
  - arrfun3.cpp, 328, 332
  - arrstruc.cpp, 147-148
  - assgn st.cpp, 145
  - auto.cpp, 456-457
  - bank.cpp, 695-697
  - bigstep.cpp, 205
  - binary.cpp, 1131
  - block.cpp, 212
  - bondini.cpp, 86
  - brass.cpp, 727
  - brass.h, 724
  - callable.cpp, 1192
  - calling.cpp, 306
  - carrots.cpp, 41
  - cctypes.cpp, 271-272
  - chartype.cpp, 81
  - check\_it.cpp, 1096
  - choices.cpp, 188
  - cinexcp.cpp, 1099
  - cinfish.cpp, 283-284
  - cingolf.cpp, 285-286
  - compstr1.cpp, 221
  - compstr2.cpp, 223
  - condit.cpp, 273
  - constcast.cpp, 944
  - conversion functions, stone1.cpp, 616
  - convert.cpp, 57
  - coordin.h, 449-450
  - copyit.cpp, 1004
  - count.cpp, 1121

cubes.cpp, 390  
 defaults.cpp, 1077  
 delete.cpp, 181, 185  
 divide.cpp, 100  
 dma.cpp, 762-764  
 dma.h, 761-762  
 dowhile.cpp, 232  
 enum.cpp, 279  
 equal.cpp, 219  
 error1.cpp, 897-898  
 error2.cpp, 899  
 error3.cpp, 901  
 error4.cpp, 906-907  
 error5.cpp, 910, 913  
 exceed.cpp, 75  
 exceptions, newexcp.cpp, 920  
 exc\_mean.cpp, 905-906  
 express.cpp, 200  
 external.cpp, 465  
 file1.cpp, 451  
 file2.cpp, 452  
 filefunc.cpp, 406-407  
 fileio.cpp, 1117  
 fill.cpp, 1082  
 firstref.cpp, 383  
 floatnum.cpp, 95  
 ftadd.cpp, 96  
 forloop.cpp, 196  
 formore.cpp, 203-204  
 forstr1.cpp, 206  
 forstr2.cpp, 215  
 fowl.cpp, 973  
 frnd2tmp.cpp, 860-861  
 fun\_ptr.cpp, 364, 368  
 funadap.cpp, 1034-1035  
 function overloading, leftover.cpp, 418  
 functions, tempover.cpp, 434-437  
 functions, arguments, twoarg.cpp, 316  
 functions, recursion, recur.cpp, 359  
 functor.cpp, 1028  
 funtemp.cpp, 420  
 getinfo.cpp, 45  
 get\_fun.cpp, 1107  
 hangman.cpp, 962-965  
 hexoct2.cpp, 79  
 if/cpp, 255  
 ifelse.cpp, 257  
 ifelseif.cpp, 259  
 ilist.cpp, 1053  
 init\_ptr.cpp, 158  
 inline functions.cpp, 381  
 inserts.cpp, 1006  
 instr1.cpp, 125  
 instr2.cpp, 127  
 instr3.cpp, 129  
 iomanip.cpp, 1092  
 jump.cpp, 280-281  
 lambda0.cpp, 1186  
 lambda1.cpp, 1190  
 left.cpp, 410-411  
 leftover.cpp, 416-417  
 lexcast.cpp, 1206  
 limits.cpp, 70  
 list.cpp, 1015  
 listrmv.cpp, 1039-1040  
 lotto.cpp, 319  
 manip.cpp, 1079  
 manyfrnd.cpp, 865  
 memb\_pt.cpp, 1244-1245  
 modulus.cpp, 102  
 morechar.cpp, 82  
 more\_and.cpp, 266  
 multmap.cpp, 1024-1025  
 myfirst.cpp, 28  
 mytime0.h, 566  
 mytime1.cpp, 569-570  
 mytime1.h, 569  
 mytime2.cpp, 575  
 mytime2.h, 575  
 namesp.cpp, 493-494  
 namesp.h, 493  
 namespaces, static.cpp, 479  
 nested.cpp, 247, 895-896  
 newstrct.cpp, 179-180  
 not.cpp, 267-268  
 numstr.cpp, 130  
 num\_test.cpp, 198  
 operator overloading  
     mytime0.cpp, 566  
     mytime3.cpp, 585  
     mytime3.h, 584  
     usetime0.cpp, 568  
     usetime3.cpp, 587  
 or.cpp, 261  
 ourfunc.cpp, 54  
 outfile.cpp, 290-291  
 pairs.cpp, 848  
 peeker.cpp, 1111



placenew1.cpp, 671-673  
 placenew2.cpp, 674-675  
 plus\_one.cpp, 207  
 pointer.cpp, 155  
 precise.cpp, 1082  
 protos.cpp, 310  
 ptrstr.cpp, 174-175  
 queue.cpp, 692-694  
 queue.h, 691-692  
 queuetp.h, 893-895  
 random.cpp, 1138-1139  
 randwalk.cpp, 603  
 recur.cpp, 355, 358  
 reference variables as function  
   parameters, swaps.cpp, 389  
 rtti1.cpp, 936-938  
 rtti2.cpp, 939-941  
 ruler.cpp, 360  
 rvref.cpp, 1163  
 sales.cpp, 924  
 sales.h, 922  
 sayings1.cpp, 656  
 sayings2.cpp, 665  
 secref.cpp, 385  
 setf.cpp, 1085  
 setf2.cpp, 1088  
 setops.cpp, 1021-1022  
 showpt.cpp, 1084  
 somedefs.h, 1192  
 sqrt.cpp, 51  
 stack.cpp, 554-555  
 stack.h, 553-554  
 stacker.cpp, 555-557  
 stacktem.cpp, 835-836  
 stacktp.h, 833-834  
 static.cpp, 470-471  
 stcktp1.cpp, 841-842  
 stcktp1.h, 839-840  
 stdmove.cpp, 1174  
 stock00.h, 510  
 stock1.cpp, 531  
 stock1.h, 530  
 stock2.cpp, 543  
 stock2.h, 543  
 stocks.cpp, class member functions, 515  
 stone1.cpp, 615  
 stone.cpp, 610  
 stonewt.cpp, 608  
 stonewt.h, 607  
 stonewt1.cpp, 614-615  
 stonewt1.h, 613  
 str1.cpp, 953  
 str2.cpp, 966-967, 971  
 strctfun.cpp, 348  
 strctptr.cpp, 352-353  
 strfile.cpp, 958-959  
 strgfun.cpp, 340  
 strgstl.cpp, 1038-1039  
 strin.cpp, 1144  
 string1.cpp, 653-656  
 string1.h, 653  
 strings, numeric input,  
   numstr.cpp, 135  
 strings, returning, strgback.cpp, 341  
 strings.cpp, 123  
 strngbad.cpp, 630-631  
 strngbad.h, 629  
 strout.cpp, 1143  
 strquote.cpp, 402-403  
 strtref.cpp, 395  
 strtype1.cpp, 132  
 strtype2.cpp, 134  
 strtype4.cpp, 137  
 structur.cpp, 142  
 studentc.cpp, 793  
 studentc.h, 789-790  
 studenti.cpp, 802-803  
 studenti.h, 799  
 sumafile.cpp, 294-295  
 swaps.cpp, 387-388  
 switch.cpp, 276-277  
 tabtenn0.cpp, 709  
 tabtenn0.h, 708  
 tabtenn1.cpp, 717  
 tabtenn1.h, 716  
 tempmemb.cpp, 852  
 tempparm.cpp, 856-857  
 textin1.cpp, 234  
 textin2.cpp, 236  
 textin3.cpp, 239  
 textin4.cpp, 242  
 tmp2tmp.cpp, 862-864  
 topfive.cpp, 353  
 travel.cpp, 344-345  
 truncate.cpp, 1113  
 tv.cpp, 880-882

- tv.h, 879-880
- tvfm.h, 885-886
- twoarg.cpp, 316
- twod.cpp, 846-847
- twofile1.cpp, 469
- twofile2.cpp, 469
- twoswap.cpp, 427-428
- twotemps.cpp, 422
- typecast.cpp, 108
- use new.cpp, 161
- usealgo.cpp, 1043-1044
- usebrass1.cpp, 732-733
- usebrass2.cpp, 734
- usedma.cpp, 765
- useless.cpp, 1165
- usenmsp.cpp, 494-495
- usesstok2.cpp, 547
- usestok1.cpp, 533
- usetime1.cpp, 571-572
- usetime2.cpp, 577
- usett0.cpp, 710
- usett1.cpp, 717-718
- use\_sales.cpp, 925-927
- use\_stuc.cpp, 795-797
- use\_stui.cpp, 804-805
- use\_tv.cpp, 882
- usestok0.cpp, 519
- valvect.cpp, 1048
- variadic1.cpp, 1199
- vect.cpp, 593
- vect.h, 591
- vect1.cpp, 980
- vect2.cpp, 984-985
- vect3.cpp, 988
- vegnews.cpp, 634
- vslice.cpp, 1049-1050
- waiting.cpp, 229
- while.cpp, 225
- width.cpp, 1080
- Worker0.cpp, 811-812
- Worker0.h, 810-811
- workermi.cpp, 823-825
- workermi.h, 821-822
- workmi.cpp, 826-827
- worktest.cpp, 813
- write.cpp, 1073-1074
- code style, 40**
- colon (`()`), scope-resolution operator (`::`), 514**
- combination assignment operators, 211-212**
- comma operator, 214-217**
  - example, 214-216
  - precedence, 217
- command-line processing, 1119-1120**
- comments, 27, 33**
  - `/*...*/` notation, 33
  - `//` notation, 32
- compare() method, 1264-1265**
- comparing**
  - arrays, vector objects, and array objects, 188-189
  - strings, 960, 1263-1265
    - C-style strings, comparing, 220-223
    - string class strings, comparing, 223-224
- comparison members (String class), 648-649**
- compile time, 155**
- compile time complexity, 1009-1010**
- compilers, 21**
  - CC (UNIX), 21-22
  - definition of, 11
  - g++ (Linux), 22
  - gpp, 22
  - troubleshooting, 24
  - Windows, 23-24
- compiling files separately, 447-449, 453**
- complex class template, 1045**
- composition, 785**
- compound statements (blocks), 212-214**
- compound types, 115-116**
  - enumerations, 150-152
    - enumerators, 150-151
    - value ranges, 153
    - values, setting, 152
  - pointers, 153
    - assigning values to, 171
    - C++ philosophy, 155
    - cautions, 159
    - compared to pointed-to values, 172
    - declaring, 155-159, 171
    - deferencing, 171-172
    - delete operator, 163-164
    - example, 154
    - initializing, 157-159
    - integers, 160
    - new operator, 160-162
    - pointer arithmetic, 167-172
    - pointer notation, 173

- pointers to objects, 665-670
- strings, 173-178
- structures, 140-142
  - arrays, 147-148
  - assignment, 145-146
  - bit fields, 148
  - dynamic structures, 178-180
  - example, 142-144
  - members, 141
  - string class members, 144-145
- unions, 149
  - anonymous unions, 150
  - declaring, 149
- compstr1.cpp, 221**
- compstr2.cpp, 223**
- concatenating strings, 122, 128, 1266**
- concatenating output, 46-47**
- concatenation**
  - output, 1071-1072
  - string class, 133-134
- concatenation operator (+), strings, 133-134**
- concepts**
  - containers, 1007
    - container methods compared to functions, 1039-1041
    - properties, 1008-1010
    - sequence requirements, 1011-1012
  - functors, 1027-1030
  - iterators, models, 1000-1001
- concurrent programming, 1202-1203**
- condit.cpp, 273**
- conditional operator (?:), 273-274**
- const, reference returns, 400**
- const keyword, 90-92, 473-474, 771-772**
  - arrays, 327-328
  - pointers, 334-336
  - reference variables, 401
  - temporary variables, 392-394
- const member functions, 537**
- const modifier as alternative to #define, 1327-1329**
- const objects, returning references to, 662-665**
- constant time, 1009**
- constant time complexity, 1009-1010**
- constants, 78-80. See also strings**
  - char constants. *See* char data type
  - const keyword, 90-92
  - file modes, 1122-1123
  - floating-point constants, 96
  - representing bit values, 1085
  - size\_type, 1251
  - symbolic constants, 72
  - symbolic names, 90-92
- constcast.cpp, 944**
- constructors, 524, 742, 768**
  - calling, 526-527
  - class, 524
  - conversion, 769-770
  - copy constructors, 639, 767
    - deep copying, 642-644
    - limitations, 640-642
    - shallow copying, 640
    - when to use, 639-640
  - declaring, 525-526
  - default constructors, 527-528, 638-639, 766-767
  - defining, 525-526
  - delegating, 1180-1181
  - inheritance, 713-715
  - initialization list, C++11, 1258
  - new operator, 659-661, 677-678
  - Rvalue reference, C++11, 1256
  - string class, 1253
    - constructors that use arrays, 1254
    - constructors that use n copies of character, 1257
    - constructors that use parts of arrays, 1254-1255
    - constructors that use ranges, 1257
    - copy constructors, 1255-1256
    - default constructors, 1254
    - String(), 647-648, 952-956
    - virtual base classes, 817-818
- const\_cast operator, 944**
- const\_iterator type, 1273**
- const\_reference type, 1273**
- contained objects**
  - compared to private inheritance, 806
  - initializing, 791
  - interfaces, 792-795
- container classes, 830**
- container concepts, 1007**
  - container methods compared to functions, 1039-1041
  - properties, 1008-1010
  - sequence requirements, 1011-1012

**container methods, compared to functions, 1039-1041**

**container requirements, C++11, 1010**

**container types**

- deque, 1013
- list, 1014-1017
  - member functions, 1014-1016
- priority\_queue, 1017-1018
- queue, 1017
- stack, 1018
- vector, 1012-1013

**containers, 553**

- associative, 1018, 1026
  - multimap, 1023-1025
  - set, 1019-1022
- C++11, unordered associative
  - containers, 1283
- deques, methods, 1278-1280
- lists, methods, 1278-1280
- maps, methods, 1281-1284
- methods, 1275-1277
- sets, methods, 1281-1284
- stacks, 557
- STL (Standard Template Library), 1161
  - C++11, 1271-1273
- vectors, methods, 1278-1280

**containment, 785**

**continue statement, 280-282**

**conversion constructors, 769-770**

**conversion operators, explicit, 1159-1160**

**convert.cpp, 57**

**converting**

- class type, 677
- rectangular coordinates to polar
  - coordinates, 348-351
- to standard C++, 1327
  - auto\_ptr template, 1333
  - C++ features, 1331
  - const instead of #define, 1327-1329
  - function prototypes, 1330
  - header files, 1331
  - inline instead of #define, 1329-1330
  - namespaces, 1331-1333
  - STL (Standard Template Library), 1334
  - string class, 1333
  - type casts, 1330-1331

**converting data types, 102, 606-612**

- applying automatically, 616-618
- conversion functions, 612-616
- conversion in arguments, 106
- conversion in expressions, 105-106
- conversion on assignment, 103-104
- friends, 618-621
- implicit conversion, 609
- type casts, 107-109, 606-612

**coordin.h, 449-450**

**coordinates**

- converting, 348-351
- polar coordinates, 347
- rectangular coordinates, 346

**copy constructable objects, 1008**

**copy constructors, 639, 767**

- deep copying, 642-644
- limitations, 640-642
- shallow copying, 640
- when to use, 639-640

**copy() function, 1293-1296**

- iterators, 1001-1002

**copy() method, 1269**

**copying**

- deep copying, 642-644
- shallow copying, 640
- strings, 135, 1269

**copying algorithms, 1036**

**copyit.cpp, 1004**

**copy\_backward() function, 1294-1297**

**count() function, 862, 1042, 1287, 1291**

**count() method, 1283**

**count.cpp, 1121**

**count\_if() function, 1287, 1291**

**counts() function, 862**

**cout object, 1067-1069**

- buffers, flushing, 1075-1076
- concatenation, 1071-1072
- field width display, 1080-1081
- fill characters, 1081-1082
- floating-point display precision, 1082-1083
- formatting data types, 1076-1078
- methods, 1071-1075
- number base display, 1078-1079
- printing trailing zeros/decimal points, 1083-1090

**cout statement, 36**

- concatenated output, 46-47

- cout.put() function, 83
- endl manipulator, 37-38
- integer values, displaying, 44-45
- \n newline character, 38-39
- cout.put() function, 83-84**
- covariance of return type, 744**
- cpp filename extension, 28**
- CRC cards, 1207**
- cstring header file, 123-124**
- ctime header file, 229**
- cube() function, 309, 312-313, 391**
- cubes.cpp, 390**
- cumulative totals, calculating, 1320**
- Customer class, 690-691, 694**
- cv-qualifiers, 472-473**
  - const, 473-474
  - volatile, 473
- c\_in\_str() function, 340-341**
- c\_str() method, 1252**

## D

---

- data hiding, 511-513, 523**
- data methods, 1251-1253**
- data objects, pointers, 161**
- data types, 507-508**
  - ADTs (abstract data types), 552-557
  - aliases, creating, 230
  - bool, 90
  - classifying, 97
  - compound types, 116
  - double, 50
  - floating-point numbers, 92
    - advantages/disadvantages, 96-97
    - constants, 96
    - decimal-point notation, 92
    - double, 94-96
    - E notation, 92-93
    - float, 94-96
    - long double, 94-96
  - integers, 68
    - char, 80-89
    - choosing integer types, 76-77
    - climits header file, 71-73
    - constants, 78-80, 90-92
    - initializing, 73
    - int, 68-70
    - long, 68-70
    - short, 68-70
    - sizeof operator, 71-73
    - unsigned, 74-76
    - width of, 68
  - recognized by, 1093-1095
  - type casts, 606-612
  - type conversion, 606-612
    - applying automatically, 616-618
    - conversion functions, 612-616
    - friends, 618-621
    - implicit conversion, 609
  - type conversions, 102
    - conversion in arguments, 106
    - conversion in expressions, 105-106
    - conversion on assignment, 103-104
    - type casts, 107-109
- data types, 140. See also compound types**
- Data() function, 820**
- data() method, 1251-1252**
- Dawes, Beman, 1205**
- dec manipulator, 1090-1091**
- dec manipulators, 1078-1079**
- decimal numbers, 1215**
- decimal points, trailing, 1083-1087, 1090**
- decision making, 253**
- declaration statements, 41-43**
- declaration-statement expressions, 202**
- declarations, 463**
  - aliases, 1157
  - auto, 109, 1155
  - decltype, 1156
  - external, 143
  - return types, 1157
- declarative region, 483**
- declaring**
  - arrays, 116-119
  - arrays of objects, 546
  - classes, 509-513, 522
  - constructors, 525-526
  - function pointers, 362-363
    - example, 364
    - invoking functions with, 363-364
  - pointers, 155-159, 171
  - two-dimensional arrays, 244-246
  - unions, 149
  - variables, 41-43
    - static, 183
  - vector class, 591-592

- decltype, 439**
  - declarations, 1156
- decorating names, 418**
- decrement operator (--), 207-208**
  - pointers, 210-211
  - postfixing, 209-210
  - prefixing, 209-210
- deep copying, 642-644**
- default arguments, 409-412**
- default class constructors, 527-528**
- default constructors, 638-639, 766-767**
- default type template parameters, 849**
- defaulted methods, classes, 1179-1180**
- defaults.cpp, 1077**
- dereferencing operator (\*), pointers, 171-172**
- #define directive, converting to standard C++**
  - const instead of #define, 1327-1329
  - inline instead of #define, 1329-1330
- defining**
  - class member functions, 514-516
  - classes, 47
  - constructors, 525-526
  - functions, 306-309
- defining declarations, 463**
- definitions, 463**
- delegating constructors, 1180-1181**
- delete operator, 163-164, 180-183, 400, 454, 476-477, 668**
- delete.cpp, 181**
- deleted methods, classes, 1179-1180**
- deque class templates, 1013**
- deque containers, 1013**
- deques, methods, 1278-1280**
- dequeue() method, 689**
- dereferencing (\*) operator, 155-159**
- dereferencing operators, 1242-1246**
- derived classes, 405**
  - constructors, 713-715
  - creating, 711-712
  - header files, 716
  - method definitions, 716
  - objects, creating, 717-718
  - relationships with base classes, 718-720
- derived types, 116**
- design**
  - bottom-up, 13
  - top-down, 12
- The Design and Evolution of C++*, 775, 1324**
- destructors, 524, 528-529, 538-539, 768**
  - class, 524
  - virtual destructors, 737, 742-743, 776
- difference\_type type, 1250, 1273**
- directives**
  - #define, converting to standard C++, 1327-1330
  - #ifndef, 451
  - #include, 33
  - using, 35-36, 59-60, 487-490
- displacement vectors, 589**
- divide-and-conquer strategy, 360-361**
- divide.cpp, 100**
- division operator (/), 100-101**
- dma.cpp, 762-764**
- dma.h, 761-762**
- do while loops, 231-233**
- dominance, virtual base classes, 828-829**
- double data type, 50, 94-96**
- double-ended queue, 1013**
- dowhile.cpp, 232**
- downcasting, 738**
- Draw() function, 818**
- dribble() function, 414**
- dynamic storage duration, 454**
- dynamic arrays, 172-173**
  - creating, 164-165
  - new operator, 164
  - sample program, 165-167
- dynamic binding, 164, 172-173, 737-740**
- dynamic cast operator, 934, 941-943**
- dynamic cast operators, 934-939**
- dynamic memory, 476-479, 482**
- dynamic memory allocation, 757**
  - auto\_ptr class, 969, 973-975
  - derived class does use new, 758-760
  - derived class doesn't use new, 757-758
  - example, 761-766
    - dma.cpp, 762-764
    - dma.h, 761-762
    - usedma.cpp, 765
- dynamic structures, creating, 178-180**
- dynamic\_cast operator, 943**
- dynamic variables, 454**

## E

early binding, 737

*Effective C++: 50 Specific Ways to Improve Your Programs and Designs, Second Edition*, 1324

*Effective STL: 50 Specific Ways to Improve Your Use of the Standard Template Library*, 1324

empty lines in strings, 130

empty() method, 1258, 1275

encapsulation, 512, 523

end() method, 981-984, 1251, 1275

end-of-file conditions, 237-241

endl manipulator, 37-38

enqueue() function, 890

entry-condition loops, 198

enum statement, 278-280

enum variables, 150-152

enumerators, 150-151

value ranges, 153

values, setting, 152

enum.cpp, 279

enumerations, 150-152

enumerators, 150-151

scoped, 1158

C++11, 551-552

value ranges, 153

values, setting, 152

enumerators, 150-151

as labels, 278-280

EOF (end-of-file) conditions, 237-241

eof() function, 238

eof() method, 296

eof() stream state methods, 1097-1102

eofbit stream state, 1097-1102

equal sign (=)

assignment operator (=), 644, 767-768, 772-775

custom definitions, 645-646

enumerator values, setting, 152

overloading, 652-658

potential problems, 645

strings, 133-134

structures, 145-146

when to use, 644

equality operator (==), compared to assignment operator, 218-220

equal() function, 1288-1292

equal.cpp, 219

equality operator (==), 217

compared to assignment operator, 218-220

equal\_range() function, 1024, 1304, 1309

equal\_range() method, 1283, 1285-1286

erase() method, 982-984, 1267, 1278, 1282

erasing strings, 1267-1268

error codes, returning, 898-900

error handling. *See* handling exceptions

error1.cpp, 897-898

error2.cpp, 899

error3.cpp, 901

error4.cpp, 906-907

error5.cpp, 910, 913

escape sequences, 84-85

estimate() function, 362-364

eternal loops, 232

exact matches, 432-434

exceed.cpp, 75

exception class, 917

exception handlers, 900, 933

exception handling, 896-897, 900, 933

abort() function, 897-898

bad\_alloc exceptions, 921

catching exceptions, 900, 916-917

cautions, 931-932

error codes, returning, 898-900

exception class, 917

exception handlers, 900

inheritance, 922-927

sales.cpp, 924

sales.h, 922

use\_sales.cpp, 925-927

invalid\_argument exceptions, 919

length\_error exceptions, 919

logic\_error exceptions, 918

objects as exceptions, 903-908

out\_of\_bounds exceptions, 919

range\_error exceptions, 919

real-world note, 933

runtime\_error exceptions, 919

stdexcept exception classes, 918-920

throwing exceptions, 900, 915-916

try blocks, 901-903

uncaught exceptions, 928-931

unexpected exceptions, 928-931

unwinding the stack, 909-910, 913-914

**exception specifications, C++11, 908**  
**exceptions, 1158**  
**exceptions() stream state method, 1098-1102**  
**exclamation point (!), logical NOT operator, 267-269**

- alternative representations, 270
- precedence, 269

**exc\_mean.cpp, 905-906**  
**executable code, 18**  
**exit() function, 930**  
**explicit, 1159-1160**  
**explicit instantiations, 428-430, 850**  
**explicit keyword, 610**  
**explicit specializations, 425, 850-851**

- example, 426-428
- third-generation specialization, 425-426

**exporting, templates, 1162**  
**express.cpp, 200**  
**expression arguments, 844**  
**expressions, 97, 200-202**

- combining with comma operator, 214
- compared to statements, 201
- conditional operator (?:), 273-274
- declaration-statement expressions, 202
- logical AND (&&), 262
  - alternative representations, 270
  - example, 263-265
  - precedence, 269-270
  - ranges, 265-267
- logical NOT (!), 267-269
  - alternative representations, 270
  - precedence, 269
- logical OR (||), 260-262
  - alternative representations, 270
  - example, 261-262
  - precedence, 269
- relational operators, 217-218, 220
  - C-style strings, comparing, 220-223
  - equality operator (==), 218-220
  - string class strings, comparing, 223-224
  - table of, 217
- sequence points, 208-209
- side effects, 201, 208-209
- type conversions, 105-106

**extern keyword, 467-472**

- functions, 474

**external declarations, 143**  
**external linkage, 454**  
**external variables, 463, 466-467**  
**external.cpp, 465**  
**ext\_permutation() algorithm, 1038**

---

## F

**factorials, calculating, 203-205**  
**fail() method, 296, 1101**  
**fail() stream state method, 1098-1102**  
**failbit stream state, 1097-1102**  
**failbits, 130**  
**fields**

- bit fields, 148
- width, 1080-1081

**file extensions, 20**  
**file I/O, 1114**

- checking stream states, 1118-1119
- command-line processing, 1119-1120
- file modes, 1122
  - appending data to files, 1125-1127
  - binary, 1127-1133
  - constants, 1122-1123
  - opening files, 1124-1125
  - text, 1129
- files, random access, 1133-1142
- opening multiple files, 1119
- reading, 1116-1118
- writing, 1115-1118

**file scope, 454**  
**file1.cpp, 451**  
**file2.cpp, 452**  
**filefunc.cpp, 406-407**  
**fileio.cpp, 1117**  
**files, 1129**

- associating objects with, 289
- client files, creating, 533-536
- climits, 71-73
- compiling separately, 447-449, 453
- cpp filename extension, 28
- ctime, 229
- EOF (end-of-file) conditions, 237-240
- header filenames, 34
- header files, 448-449
  - converting to standard C++, 1331
  - creating, 530
  - cstring, 123-124
  - managing, 451



- implementation files, creating, 530
- include files, 96
- iostream, 33-34, 289, 1064, 1067
- text files, 287-288
  - reading, 292-298
  - writing to, 288-292
- file\_it() function, 408**
- fill characters, 1081-1082**
- fill() function, 1081, 1294, 1299**
  - array objects, 357
- fill.cpp, 1082**
- filling arrays, 326-327**
- fill\_array() function, 325-327, 331**
- fill\_n() function, 1294, 1299**
- fin.clear() function, 1121**
- final, 1183-1184**
- find() function, 1287-1289**
- find() method, 960-961, 965, 1260-1261, 1283**
- finding, 1260**
- find\_arr() function, 994**
- find\_end() function, 1287-1290**
- find\_first\_not\_of() method, 961, 1262-1263**
- find\_first\_of() function, 1287, 1290**
- find\_first\_of() method, 961, 1262**
- find\_if() function, 1287-1289**
- find\_last\_not\_of() method, 1263**
- find\_last\_of() method, 961, 1262**
- firstref.cpp, 383**
- fixed manipulator, 1091**
- flags, 1084**
- flags, setting, 1083**
- float data type, 94-96**
- floating points, display precision, 1082-1087, 1090**
- floating-point data types, default behavior, 1076**
- floating-point numbers, 92**
  - advantages/disadvantages, 96-97
  - constants, 96
  - decimal-point notation, 92
  - double data type, 94-96
  - E notation, 92-93
  - float data type, 94-96
  - long double data type, 94-96
- floatnum.cpp, 95**
- fltadd.cpp, 96**
- flush() function, 1076**
- flushing buffers, 1063**
- for loops**
  - blocks, 212-214
  - body, 196-197
  - combination assignment operators, 211-212
  - comma operator, 214-217
    - example, 214-216
    - precedence, 217
  - compared to while loops, 227-228
  - decrement operator (--), 207-208
    - pointers, 210-211
    - postfixing, 209-210
    - prefixing, 209-210
  - example, 196-197
  - expressions, 200-202
    - compared to statements, 201
    - declaration-statement expressions, 202
  - factorials, calculating, 203-205
  - increment operator (++), 207-208
    - pointers, 210-211
    - postfixing, 209-210
    - prefixing, 209-210
  - initialization, 196-197
  - loop test, 196-197
  - loop updates, 196-198, 205-206
  - nested loops, 244-249
  - nonexpressions, 202
  - range-based, 1161
  - sequence points, 208-209
  - side effects, 201, 208-209
  - step size, 205-206
  - strings, 206-207
  - syntax, 197-199
- for statements, declaration-statement expressions, 203**
- for-init-statement, 203**
- forcing moves, 1173-1174, 1177-1178**
- forever loops, 232**
- forloop.cpp, 196**
- formal arguments, 314**
- formatted input functions, 1094**
- formatting**
  - if else statement, 257-258
  - incore, 1142-1145

- source code, 39
  - source code style, 40
  - tokens, 39
  - white space, 39
- with `cout`, 1076-1077
  - field width display, 1080-1081
  - fill characters, 1081-1082
  - floating-point display precision, 1082-1083
  - manipulators, 1090-1091
  - number base display, 1078-1079
  - trailing zeros/decimal points, 1083-1090
- with `iomanip` header file
  - manipulators, 1091
- formore.cpp, 203-204**
- forstr1.cpp, 206**
- forstr2.cpp, 215**
- forward declaration, 884**
- forward iterators, 998**
- for\_each() function, 987-988, 1287-1289**
- for\_each() STL function, 991**
- fowl.cpp, 973**
- free memory storage, 182**
- free store, 454**
- free store (memory), 182-183**
- freeing memory, delete operator, 163-164**
- friend classes, 578-580, 877-888**
  - base-class friends, accessing, 801-804
  - compared to class member functions, 886
  - templates, 858
    - bound template friend functions, 861-864
    - non-template friend functions, 858-861
    - unbound template friend functions, 864-865
  - Tv class example, 878-879, 883
    - tv.cpp, 880-882
    - tv.h, 879-880
    - tvfm.h, 885-886
    - use\_tv.cpp, 882
- friend functions, 578-580**
  - creating, 579-580
  - type conversion, 618-621
- friend keyword, 579-580**
- friend member functions, 578-580, 883**
  - compared to friend classes, 886
  - example, 885-886
  - forward declaration, 884
  - shared friends, 888-889
- frnd2tmp.cpp, 860-861**
- front insert iterators, 1005-1007**
- front() method, 1278**
- funadap.cpp, 1034-1035**
- function idioms, arrays, 331**
- function objects, 1026**
- function parameter packs, 1197-1198**
  - unpacking, 1198-1199
- function parameters, reference variables, 386-390**
- function pointers, 1184-1188**
  - variations on, 365-370
- function polymorphism, 412**
- function prototype scope, 454**
- function prototypes, 309-311, 1330**
  - benefits, 312-313
  - C++ compared to ANSI C, 312
  - syntax, 311-312
- function wrapper**
  - fixing problems, 1194-1196
  - options for, 1196-1197
  - template inefficiencies, 1191-1194
- functional polymorphism, 564**
- functions, 18, 29, 48-49. See also names of specific functions**
  - adaptable binary, 1035
  - adaptable unary, 1035
  - algorithms, 1035
    - groups, 1035-1036
    - properties, 1036-1037
  - arguments, 31, 49, 53
    - arrays, 322-325
      - multiple, 314-320
    - passing by value, 313-314
    - two-dimensional arrays, 337-339
  - arrays, 320-321
    - as arguments, 322-325
    - const keyword, 327-328
    - design decisions, 325-326
    - displaying contents of, 327-328
    - examples, 328-331
    - filling, 326-327
    - modifying, 328

- pointers, 321–322
- ranges, 332–334
- two-dimensional arrays, 337–339
- binary, 1027, 1030
- body, 29
- C-style strings
  - passing as arguments, 339–341
  - returning, 341–343
- calling, 30, 49, 309, 311
- case sensitivity, 27, 32
- cin.get(), 317
- cin.get(ch), 317
- class member functions
  - const member functions, 537
  - constructors, 524–528, 538–539, 638–639, 659–661, 677–678
  - copy constructors, 639–644
  - definitions, 509, 514–516, 523
  - destructors, 528–529, 538–539
  - friend member functions, 883–889
  - implicit member functions, 637–638
  - inline functions, 517–518
  - invoking, 523
  - object membership, 518
  - private, 513
  - properties, 777–778
  - public, 513
  - qualified names, 514
  - this pointer, 539–546
  - unqualified names, 514
- compared to container methods, 1039–1041
- conversion functions, 677
- defining, 306–309
- definitions, 29
- formatted input, 1094
- friend functions, 578–580
  - creating, 579–580
  - type conversion, 618–621
- function prototypes, 1330
- headers, 29–31
- inline functions, 379–382
  - compared to macros, 382
  - square(), 381–382
- input, unformatted, 1102
- lambda functions, 1184
- language linking, 475–476
- library functions, 52
- linkage properties, 474–475
- non-member, 986–988, 991
- objects, returning, 662–664
  - const objects, 662–665
  - non-const objects, 663
- operator overloading, 587–588
- overloading, 237, 412–414, 564
  - example, 415–418
  - function signatures, 413
  - name decoration, 418
  - overload resolution, 431–438
  - when to use, 418
- pf()364
- pointers, 361–362
  - addresses of functions, obtaining, 362
  - const keyword, 334–336
  - declaring, 362–363
  - example, 364
  - invoking functions with, 363–364
  - pointers to pointers, 335
- prototypes, 50–52
- qualified names, 514
- recursion, 357
  - multiple recursive calls, 359–361
  - single recursive call, 358–359
- return addresses, 909
- return types, 30
- return values, 49
- set\_union(), 1020
- signatures, 413
- string class objects, 353–354
- structures, 343–346
  - passing/returning, 344–351
  - polar coordinates, 347
  - rectangular coordinates, 346
  - structure addresses, passing, 351–353
- templates, 419, 422
  - explicit instantiation, 428–430
  - explicit specializations, 425–428
  - implicit instantiation, 428–430
  - overload resolution, 431–438
  - overloading, 422–424
- transform(), 1031
- unary, 1027, 1030
- unqualified names, 514

- user-defined functions
  - example, 53-54
  - function form, 54-55
  - function headers, 55-56
  - return values, 57-59
  - using directive, 59-60
- virtual functions, pure virtual functions, 748
- void, 307
- functor.cpp, 1028**
- functors, 1026-1027, 1184-1188**
  - adaptable, 1032
  - concepts, 1027-1030
  - predefined, 1030-1032
    - equivalents for operators, 1032
- funtemp.cpp, 420**
- fun\_ptr.cpp, 364, 368**

---

## G

- g++ compiler, 22**
- gcount() member function, 1109-1114**
- generate() function, 1294, 1299**
- generate\_n() function, 1294, 1299**
- generators, 1027**
- generic programming, 14, 419, 951, 978, 992**
  - associative containers, 1018-1026
    - multimap, 1023-1025
    - set, 1019-1022
  - container concepts, 1007
    - container methods compared to functions, 1039-1041
    - properties, 1008-1010
    - sequence requirements, 1011-1012
  - container types
    - deque, 1013
    - list, 1014-1017
    - priority\_queue, 1017-1018
    - queue, 1017
    - stack, 1018
    - vector, 1012-1013
  - iterators, 992-997
    - back insert, 1005-1007
    - bidirectional, 998
    - concepts, 1000-1001
    - copy() function, 1001-1002
    - forward, 998
    - front insert, 1005-1007

- hierarchy, 999-1000
- importance of, 992-996
- input, 997-998
- insert, 1005-1007
- istream iterator template, 1003
- ostream iterator template, 1002-1003
- output, 998
- pointers, 1001
- random access, 999
- reverse, 1003-1005
- types, 997
- get() function, 127-130**
- get() function (cin), 235-237, 241-244**
- get() member function, 1102-1108**
- Get() method, 821**
- getinfo.cpp, 45**
- getline() function, 126-127, 957-960**
- getline() member function, 1106-1108**
- getline() method, 509, 1270**
- getname() function, 180-182**
- get\_allocator() method, 1252**
- get\_fun.cpp, 1107**
- global namespaces, 484**
- global scope, 454**
- global variables, compared to local variables, 467**
- good() method, 294**
- good() stream state method, 1097-1102**
- goodbit stream state, 1097-1102**
- gpp compiler, 22**
- greater than () operator, 217**
- greater than or equal to () operator, 217**

---

## H

- handling exceptions, 896**
- hangman.cpp, 962-965**
- hardware, program portability, 16**
- harmonic mean, 896**
- harpo() function, 410**
- has-a relationships, 721, 788**
- header files, 448-449**
  - limits, 71-73
  - converting to standard C++, 1331
  - creating, 530
  - cstring, 123-124
  - ctime, 229
  - iomanip, manipulators, 1091
  - iostream, 289
  - managing, 451

**headers, filenames, 34****headers (function), 29-31, 55-56****heap operations**

- make\_heap() function, 1305, 1314
- pop\_heap() function, 1305, 1314
- push\_heap() function, 1305, 1314
- sort\_heap() function, 1305, 1315

**heaping**

- popping values off, 1314
- pushing values onto, 1314

**heaps**

- creating, 1314
- defined, 1314
- heap operations
  - make\_heap() function, 1305, 1314
  - pop\_heap() function, 1305, 1314
  - push\_heap() function, 1305, 1314
  - sort\_heap() function, 1305, 1315
- sorting, 1315

**heaps (memory), 182****hex manipulator, 1090-1091****hex manipulators, 1078-1079****hexadecimal numbers, 1216**

- binary equivalents, 1217-1218

**hexoct2.cpp, 79****hierarchy, iterators, 999-1000****high-level languages, 11****history of C++, 10-15**

- C language
  - development history, 11
  - programming philosophy, 11-13
- generic programming, 14
- OOP, 13-14

**hmean() function, 898-905**

|

**I/O (input/output), 1062, 1270**

- buffers, 1063-1067
- redirecting, 1067-1068
- streams, 1063-1067
- text files, 287-288
  - reading, 292-298
  - writing to, 288-292

**identifiers, special meanings, 1223****IDEs (integrated development environments), 19****if else statement, 255**

- example, 256-257
- formatting, 257-258
- if else if else construction, 258-260
- syntax, 255

**if statement, 254**

- bug prevention, 260
- example, 255
- syntax, 254

**if.cpp, 255****ifelse.cpp, 257****ifelseif.cpp, 259****#ifndef directive, 451****ifstream objects, 1116-1119****ignore() member function, 1106-1108****ilist.cpp, 1053****imbuing, I/O with styles, 1077****implementation, changing, 521-522****implementation files, creating, 530****implicit conversion, 609****implicit instantiation, 428-430****implicit instantiations, 850****implicit keyword, 610****implicit member functions, 637-638****implicit upcasting, 807****in-class initialization, 1160****in-place algorithms, 1036****include (#include) directive, 33****include files, 96****includes() function, 1305, 1311****incore formatting, 1142-1145****increment operator (++), 197, 207-208**

- pointers, 210-211
- postfixing, 209-210
- prefixing, 209-210

**indeterminate values, 73****indexes, 117****indirect values, 155****inequality operator (!=), 217****inheritance**

- dynamic memory allocation, 757
  - derived class does use new, 758-760
  - derived class doesn't use new, 757-758
- example, 761-766
- exceptions, 922-927
- sales.cpp, 924

- sales.h, 922
- use\_sales.cpp, 925-927
- references, 405-408
- inheritance (class), 708**
  - ABCs (abstract base classes), 746-749
    - ABC philosophy, 756
    - AcctABC example, 749-755
    - enforcing interface rules with, 757
  - assignment operators, 772-775
  - base classes
    - relationships with derived classes, 718-720
    - TableTennisPlayer example, 708-710
  - Constructors, 713-715
  - derived classes
    - creating, 711-712
    - header files, 716
    - method definitions, 716
    - objects, creating, 717-718
    - relationships with base classes, 718-720
  - has-a relationships, 721
  - is-a relationships, 720-722, 772
  - multiple inheritance, 798, 808-830
    - virtual base classes, 815-829
    - Worker class example, 810-814
  - polymorphic public inheritance, 722-723
    - base-class functions, 777
    - Brass class declaration, 723-726
    - Brass class implementation, 727-731
    - Brass class objects, 732-733
    - BrassPlus class declaration, 723-726
    - BrassPlus class implementation, 727-731
    - BrassPlus class objects, 732-733
    - constructors, 742
    - dynamic binding, 737-740
    - pointer compatibility, 737-739
    - reference type compatibility, 737-739
    - static binding, 737-740
    - virtual destructors, 737, 742-743, 776
    - virtual functions, 734-736, 739-745, 775-776
  - private inheritance, 797
    - base-class components, initializing, 798-799
    - base-class friends, accessing, 801-804
    - base-class methods, accessing, 800-801
    - base-class objects, accessing, 801
    - compared to containment, 806
    - Student class example, 798-805
  - protected classes, 745-746, 775
  - protected inheritance, 806-807
  - public, 806
    - multiple, 826
  - what's not inherited, 772
- inheriting**
  - constructors, 1181-1183
  - delegating, 1181-1183
- initialization, 70**
  - arrays, 117-120
  - arrays of objects, 546
  - automatic variables, 458
  - base-class components, 798-799
  - contained objects, 791
  - for loops, 196-197
  - pointers, 157-159
  - reference variables, 385
  - strings, 121
  - two-dimensional arrays, 246-249
- initialization lists, 119**
  - constructors, C++11, 1258
- initializer\_list, 1053-1054**
  - uniform initialization, 1155
- initializer\_list template, C++11, 1051-1053**
- initializing**
  - arrays, C++11, 120
  - variables, 52, 73
- init\_ptr.cpp, 158**
- inline functions, 379, 517-518**
  - compared to macros, 382
  - square(), 381-382
- inline modifier as alternative to #define, 1329-1330**
- inline qualifier, 517**
- inline.cpp, 381**
- inner\_product() function, 1320-1321**
- inplace\_merge() function, 1305, 1311**

**input, 46**

- cin object, 1093-1095
  - operator overloading, 1095-1097
  - stream states, 1097-1102
- cin statement, 46
- classes, string, 957-960
- istream class, methods, 1109-1114
- single-character, 1102-1106
- strings, 1106-1108

**input functions**

- formatted, 1094
- unformatted, 1102

**input iterators, 997-998****input/output, strings, 287, 1269-1270****insert iterators, 1005-1007****insert() method, 983-984, 1015-1016, 1267, 1277, 1282****inserting strings, 1267****inserts.cpp, 1006****instances, 511****instantiation, 832-836****instantiation**

- explicit, 428-430, 850
- implicit, 428-430, 850

**instr1.cpp, 125****instr2.cpp, 127****instr3.cpp, 129****int data type, 68-70****int main() function header, 30-31****integer values, displaying with cout, 44-45****integers, 68**

- bool, 90
- char, 80-87
  - escape sequences, 84-87
  - signed char, 88-89
  - universal character names, 87-88
  - unsigned char, 88-89
  - wchar\_t, 89
- choosing integer types, 76-77
- climits header file, 71-73
- constants, 78-80
  - const keyword, 90-92
  - symbolic names, 90-92
- initializing, 73
- int, 68-70
- long, 68-70
- pointers, 160
- short, 68-70

sizeof operator, 71-73

unsigned, 74-76

width of, 68

**integrated development environments, 19**  
**interfaces**

contained objects, 792-795

defined, 509-510

public interfaces, 509

**internal linkage, 454****internal manipulator, 1091****internal variables, 467-470****International Standards Organization (ISO),**

C++ standard, 16

**Internet resources, 1325****INT\_MAX constant, 72****INT\_MIN constant, 72****invalid\_argument exception, 919****invoking, 526****iomanip.cpp, 1092****ios class, 1065****iostream class, 1065****iostream file, 33-34, 1064, 1067****iostream header file, 289****ios\_base class, 1065**

constants representing bit values, 1085

**is-a relationships, 720-722, 772, 808****isalnum() function, 272****isalpha() function, 272****isblank() function, 272****iscntrl() function, 272****isdigit() function, 272****isempty() function, 685****isfull() function, 685****isgraph() function, 272****islower() function, 272****ISO (International Standards Organization),**

C++ standard, 16

**ISO 10646, 88****isprint() function, 272****ispunct() function, 272****isspace() function, 272, 1101****istream class, 47, 1065**

data types recognized, 1093-1095

input

methods, 1109-1114

single-character, 1102-1106

strings, 1106-1108

**istream iterator template, 1003****isupper() function, 272**

**isxdigit() function, 273**  
**is\_open() method, 294, 1118-1119, 1125-1127**  
**iterator type, 1273**  
**iterators, 981-982, 992, 997**  
   back insert, 1005-1007  
   bidirectional, 998  
   concepts, models, 1000-1001  
   copy() function, 1001-1002  
   forward, 998  
   front insert, 1005-1007  
   hierarchy, 999-1000  
   importance of, 992-996  
   input, 997-998  
   insert, 1005-1007  
   istream iterator template, 1003  
   ostream iterator template, 1002-1003  
   output, 998  
   pointers, 1001  
   random access, 999  
   reverse, 1003-1005  
   types, 997  
**iter\_swap() function, 1294**

---

## J–K

---

**jump.cpp, 280-281**

**K&R (Kernighan and Ritchie) C standard, 17**

**keywords, 56. See also statements**  
   auto, 472  
   catch, 900  
   class, 831  
   const, 90-92, 473-474, 771-772, 1327-1329  
     arrays, 327-328  
     pointers, 334-336  
     reference variables, 401  
     temporary variables, 392-394  
   decltype, 439  
   explicit, 610  
   extern, 467-472  
     functions, 474  
   friend, 579-580  
   implicit, 610  
   inline, 517, 1329-1330  
   mutable, 472-473  
   namespace, 483-486

  private, 511-513, 798  
   protected, 745-746, 775, 806  
   public, 511-513  
   register, 472  
   static, 183, 472  
     functions, 475  
   struct, 140  
   table of, 1221  
   template, 831  
   throw, 900  
   try, 901  
   typedef, 230  
   typename, 831  
   using, 486-490, 807-808, 1332  
   virtual, 742  
   volatile, 473  
**key\_comp() method, 1282-1285**  
**key\_compare type, 1281-1284**  
**key\_type type, 1281-1284**

---

## L

---

**labels, enumerators as, 278-280**  
**lambda functions, 1184-1188**  
   reasons for, 1188-1191  
**language divergence, 16**  
**language linking, 475-476**  
**languages, evolution of, 1205**  
   Boost, 1205-1207  
   Technical Report, 1206  
**last in-first out (LIFO) stacks, 459**  
**late binding, 737**  
**layering, 785**  
**leaks (memory), 183**  
**Lee, Meng, 978**  
**left manipulator, 1091**  
**left shift operator (<), 1235**  
   overloading, 581-587, 676  
**left() function, 409-410, 415-418**  
**left.cpp, 410-411**  
**leftover.cpp, 416-417**  
**length() functions, 960**  
**length() method, 1249-1251**  
**length\_error exception, 919**  
**lessthanlessthan (left shift operator),**  
   **overloading, 581-587, 676**  
**lessthansignlessthansign (left shift**  
**operator), 1236**



`lessthansignlessthansignequalsign` (left shift and assign) operator, **1236**

`lexicalographical_compare()` function, **1306, 1318**

**libraries, 18, 378**

- C++11, 1203
- cctype, 270-273
- multiple library linking, 453
- STL (Standard Template Library), 1334

**library functions, 52**

**LIFO (last in-first out) stacks, 459**

`limits.cpp, 70`

**linear time, 1009**

**linear time complexity, 1009-1010**

**linkage**

- external, 454
- functions, 474-475
- internal, 454
- language linking, 475-476
- static variables
  - external linkage, 463-467
  - internal linkage, 467-470
  - no linkage, 470-472

**linked lists, 680**

**linking multiple libraries, 453**

**Linux, g++ compiler, 22**

**list class templates, 1014-1017**

- member functions, 1014-1016

**list containers, 1014-1017**

- member functions, 1014-1016

**list initialization, C++11, 537**

`list.cpp, 1015-1016`

`listmv.cpp, 1039-1040`

**lists**

- linked lists, 680
- methods, 1278-1280

**literal operators, 1204**

**Little Endian, 1218**

**local scope, 454**

- variables, 455-457

**local variables, 314-315**

- compared to global variables, 467

**logical AND operator (&&), 262**

- alternative representations, 270
- example, 263-265
- precedence, 269-270
- ranges, 265-267

**logical bitwise operators, 1237-1240**

**logical NOT operator (!), 267-269**

- alternative representations, 270
- precedence, 269

**logical operators, 260**

- alternative representations, 270
- AND (&&), 262
  - example, 263-265
  - precedence, 269-270
  - ranges, 265-267
- function equivalents, 1031-1032
- NOT (!), 267-269
- OR (||), 260-262
  - Example, 261-262

**logical OR operator (||), 260-262**

- alternative representations, 270
- example, 261-262
- precedence, 269

**logic\_error exception, 918**

**long data type, 68-70**

**long double data type, 94-96**

**long long type, 1153**

**LONG\_MAX constant, 72**

**LONG\_MIN constant, 72**

**loops, 195**

- break statement, 280-282
- continue statement, 280-282
- do while, 231-233
- entry-condition loops, 198
- for loops
  - blocks, 212-214
  - body, 196-197
  - combination assignment operators, 211-212
  - comma operator, 214-217
  - compared to while loops, 227-228
  - decrement operator (`---`), 207-211
  - example, 196-197
  - expressions, 200-202
  - factorials, calculating, 203-205
  - increment operator (`++`), 207-211
  - initialization, 196-197
  - loop test, 196-197
  - loop updates, 196-198, 205-206
  - nonexpressions, 202
  - sequence points, 208-209
  - side effects, 201, 208-209
  - step size, 205-206

- strings, 206–207
- syntax, 197–199
- forever loops, 232
- nested loops, 244–249
- number-reading loops, 283–286
- range-based, C++11, 233–234
- text input
  - cin object, 234–235
  - cin.get() function, 235–237, 241–244
  - end-of-file conditions, 237–241
  - sentinel characters, 234
- while loops, 224–227
  - compared to for loops, 227–228
  - example, 225–226
  - syntax, 224
  - time-delay loops, 229–230
- lotto probabilities, calculating, 317–320**
- lotto.cpp, 319**
- low-level languages, 11**
- low-level programming, 1203–1204**
- lower\_bound() function, 1024, 1304, 1309**
- lower\_bound() method, 1021, 1283**
- lvalue reference, 1162**

---

## M

- machine language, definition of, 18**
- Macintosh, C++, 25**
- macros, compared to inline functions, 382**
- magval() method, 602**
- main() function, 29–30**
  - calling, 30
  - importance of, 32
  - int main() header, 30–31
- make\_heap() function, 1305, 1314**
- malloc() function, 160**
- mangling names, 418**
- manip.cpp, 1079**
- manipulators, 38, 1090–1091**
  - endl, 37–38
  - iomanip header file, 1091
  - number base display, 1078–1079
- mantissas, 93**
- manyfrnd.cpp, 865**
- mapped\_type type, 1281, 1284**
- maps, methods, 1281–1284**
- math operators, 97. See also arithmetic operators**
- max() function, 1305, 1316**
- max() method, 787, 1046**
- maxsize() method, 1275**
- max\_element() function, 1305, 1317**
- max\_size() method, 1251**
- mean, harmonic, 896**
- means() function, 909–914**
- member dereferencing operators, 1242–1246**
- member functions. See also constructors**
  - const member functions, 537
  - constructors, 524, 538–539
    - calling, 526–527
    - declaring, 525–526
    - default constructors, 527–528, 638–639
    - defining, 525–526
    - new operator, 659–661, 677–678
  - copy constructors, 639
  - deep copying, 642–644
  - limitations, 640–642
  - shallow copying, 640
  - when to use, 639–640
- definitions, 509, 514, 516, 523
- destructors, 528–529, 538–539
- friend member functions, 578–580, 883
  - compared to friend classes, 886
  - example, 885–886
  - forward declaration, 884
  - shared friends, 888–889
- implicit member functions, 637–638
- inline functions, 517–518
- invoking, 523
- object membership, 518
- objects, returning, 662–664
  - const objects, 662–665
  - non-const objects, 663
- private, 513
- properties, 777–778
- public, 513
- qualified names, 514
- template classes, list, 1014–1016
- this pointer, 539–546
- unqualified names, 514

- member in-class initialization, 1160**
- member initializer lists, 683, 715**
- member templates, 854–855**
- members, structures, 141**
- memberwise assignment, 145**

**memberwise copying, 640**

**memb\_pt.cpp, 1244-1245**

**memory. See also buffers**

allocating

bad\_alloc exceptions, 921

new operator, 160-162

automatic storage, 182

cv-qualifiers, 472-474

dynamic, 476-482

dynamic memory allocation, 757

derived class does use new, 758-760

derived class doesn't use new,

757-758

example, 761-766

free store, 182-183

freezing delete operator, 163-164

function linkage, 474-475

language linking, 475-476

leaks, 183

memory-related methods, 1258

multifile programs, compiling separately,

447-453

named, 160

stack, 458-459

unwinding, 909-914

static storage, 183

storage class specifiers, 472-473

storage duration, 453-454

automatic variables, 455-459

scope and linkage, 454

static variables, 459-463, 466-472

storage methods, 182

**memory allocation, dynamic (auto\_ptr class), 969, 973-975**

**memory leaks, 163**

**merge() function, 1305, 1310-1311**

**merge() method, 1016-1017, 1280**

**merging**

inplace\_merge() function, 1305, 1311

merge() function, 1305, 1310-1311

**methods. See also specific methods**

base-class methods, accessing, 800-801

defaulted and deleted methods, classes,

1179-1180

end(), 984

inheritance, multiple, 826

insert(), 1015-1016

STL, 1161

virtual base classes, 818-828

**MI (multiple inheritance), 798**

**min() function, 1305, 1316**

**min() method, 787, 1046**

**minimum values**

finding 1316-1317

**minus sign (-), decrement operator (--), 207-208**

pointers, 210-211

postfixing, 209-210

prefixing, 209-210

**min\_element() function, 1305, 1317**

**mismatch() function, 1288, 1291**

**mixtypes.cpp, 185**

**models, concepts of iterators, 1000-1001**

**modifiers**

const, as alternative to #define,

1327-1329

inline, as alternative to #define,

1329-1330

**modulus operator (%), 101-102**

**modulus.cpp, 102**

**morechar.cpp, 82**

**more\_and.cpp, 266**

**move assignment operator, 1173**

**move constructors, 1165**

**move semantics, 1164-1171**

observations, 1171-1172

**Move() method, 748**

**moves, forcing, 1173-1178**

**MS-DOS, gpp compiler, 22**

**multifile programs, compiling separately, 447-453**

**multimap associative containers, 1023-1025**

**multiple arguments, 314-320**

n\_chars() example, 314-317

probability() example, 318-320

**multiple class representations, 599**

**multiple inheritance, 798, 808-809, 829-830**

virtual base classes, 815-817

combining with nonvirtual base

classes, 828

constructors, 817-818

dominance, 828-829

methods, 818-828

Worker class example, 810-814

**multiple library linking, 453**

**multiple public inheritance, methods, 826**

**multiple type parameters, 847**

**multiplication operator (\*), overloading, 574-578****multisets, set operations**

- includes() function, 1311
- set\_difference() function, 1313
- set\_intersection() function, 1312
- set\_union() function, 1312

**multimap.cpp, 1024-1025****mutable keyword, 472-473****mutating sequence operations**

- copy() function, 1293-1296
- copy\_backward() function, 1294-1297
- fill() function, 1294, 1299
- fill\_n() function, 1294, 1299
- generate() function, 1294, 1299
- generate\_n() function, 1294, 1299
- iter\_swap() function, 1294
- partition() function, 1295, 1302-1303
- random\_shuffle() function, 1295, 1302
- remove() function, 1295, 1299
- remove\_copy() function, 1295, 1300
- remove\_copy\_if() function, 1295, 1300
- remove\_if() function, 1295, 1300
- replace() function, 1294, 1298, 1302
- replace\_copy() function, 1294, 1298
- replace\_copy\_if() function, 1294, 1298
- replace\_if() function, 1294, 1298
- reverse() function, 1295
- reverse\_copy() function, 1295, 1301
- rotate() function, 1295, 1301
- rotate\_copy() function, 1295, 1302
- stable\_partition() function, 1295, 1303
- swap() function, 1294, 1297
- swap\_ranges() function, 1294, 1297
- transform() function, 1294, 1297
- unique() function, 1295, 1300
- unique\_copy() function, 1295, 1301

**myfirst.cpp program, 27-29**

- comments, 32-33
- header filenames, 34
- iostream file, 33-34
- main() function, 29-30
  - calling, 30
  - importance of, 32
  - int main() header, 30-31
- namespaces, 35-36

- output, displaying with cout, 36
  - endl manipulator, 37-38
  - \n newline character, 38-39
- source code formatting, 39
  - source code style, 40
  - tokens, 39
  - white space, 39

**mytime0.h, 566****mytime1.cpp, 569-570****mytime1.h, 569****mytime2.cpp, 575****mytime2.h, 575**

---

**N**

---

**name decoration, 418****name mangling, 418****named memory, 160****names**

- aliases, creating, 230
- array names, 172
- function qualified names, 514
- function unqualified names, 514
- name decoration, 418
- namespace aliases, 491
- reserved names, 1222-1223

**namesp.cpp, 493-494****namesp.h, 493****namespace keyword, 483-486****namespace scope, 454****namespaces, 35-36, 482-483, 1331-1333**

- aliases, 491
- creating, 483-486
- declarative region, 483
- example, 492-496
  - namesp.cpp, 493-494
  - namesp.h, 493
  - usenmsp.cpp, 494-495
- global, 484
- guidelines, 496-497
- nesting, 490-491
- open, 485
- potential scope, 483
- std, 59
- unnamed, 491-492
- using declaration, 486-490
- using directive, 487-490
- using-declaration, 491
- using-directive, 491

**naming conventions, 60**

- header files, 34
- source files, 20
- symbolic names, 90-92
- universal character names, 87-88
- variables, 66-68

**narrowing uniform initialization, 1154****navigating files, 133-1141**

- temporary files, 1141-1142

**nested classes, 682, 889-891**

- access control, 892
- scope, 891-892
- templates, 892-896

**nested loops, 244-249****nested structures, 682****nested.cpp, 247, 895-896****nesting namespaces, 490-491****new, 921****new operator, 180-182, 454, 476-479, 482, 668**

- bad\_alloc exceptions, 921
- constructors, 659-661, 677-678
- dynamic arrays, 164-167
- dynamic structures, 178-180
- free store, 183
- memory allocation, 160-162
- placement new, 671-676
- reference variables, 400

**newline character (\n), 38-39****newstrct.cpp, 179-180****next\_permutation() algorithm, 1039****next\_permutation() function, 1306, 1319****noboolalpha manipulator, 1090****noexcept, C++11, 1248****non-const objects, returning**

- references to, 663

**non-member functions, 986-991****non-type arguments (arrays), 843-845****nonexpressions, for loops, 202****nonmodifying sequence operations, 1286**

- adjacent\_find() function, 1287, 1290
- count() function, 1287, 1291
- count\_if() function, 1287, 1291
- equal() function, 1288, 1291-1292
- find() function, 1287-1289
- find\_end() function, 1287-1290
- find\_first\_of() function, 1287, 1290
- find\_if() function, 1287-1289

- for\_each() function, 1287-1289
- mismatch() function, 1288, 1291
- search() function, 1288, 1292-1293
- search\_n() function, 1288, 1293

**noshowbase manipulator, 1090****noshowpoint manipulator, 1091****noshowpos manipulator, 1091****NOT operators, logical NOT (!), 267-269**

- alternative representations, 270
- precedence, 269

**not.cpp, 267-268****nouppercase manipulator, 1091****nth\_element() function, 1304, 1308, 1315****null characters, 121****null pointers, 163****nullptr, 1158****number base display, 1078-1079****number-reading loops, 283-286****numbers, 1215**

- ASCII character set, table of, 1225-1229
- Big Endian/Little Endian, 1218
- binary numbers, 1217
  - hexadecimal equivalents, 1217-1218
- decimal numbers, 1215
- factorials, calculating, 203-205
- floating-point numbers, 92
  - advantages/disadvantages, 96-97
  - constants, 96
  - decimal-point notation, 92
  - double data type, 94-96
  - E notation, 92-93
  - float data type, 94-96
  - long double data type, 94-96
- harmonic mean, 896
- hexadecimal numbers, 1216
  - binary equivalents, 1217-1218
- integers, 68
  - bool, 90
  - char, 80-89
  - choosing integer types, 76-77
  - climits header file, 71-73
  - constants, 78-80, 90-92
  - initializing, 73
  - int, 68-70
  - long, 68-70
  - short, 68-70
  - sizeof operator, 71-73
  - unsigned, 74-76
  - width of, 68

number-reading loops, 283-286  
 octal numbers, 1215-1216  
 pointers, 160  
 pseudorandom numbers, 605  
**numeric operations, 1319-1320**  
 accumulate() function, 1320  
 adjacent\_difference() function,  
 1321-1322  
 inner\_product() function, 1320-1321  
 partial\_sum() function, 1321  
**numstr.cpp, 130**  
**num\_test.cpp, 198**  
**n\_chars() function, 314-317**

---

## O

---

**object code, definition of, 18**  
**object types, 47**  
*Object-Oriented Analysis and Design, Second Edition, 1323*  
**object-oriented programming. See OOP (object-oriented programming)**  
**objects, 511, 786**  
 arrays, 355, 546-549  
   declaring, 546  
   example, 547-549  
   fill function, 357  
   initializing, 546  
 as exceptions, 903-908  
 assignable, 1008  
 associating with files, 289  
 base-class objects, accessing, 801  
 cerr, 1067  
 cin, 1067, 1093-1095  
   cin.get() function, 235-237, 241-244  
   get() function, 128-130  
   getline() function, 126-127  
   loops, 234-235  
   operator overloading, 1095-1097  
   stream states, 1097-1102  
 class, 788  
 clog, 1067  
 contained objects  
   compared to private inheritance, 806  
   initializing, 791  
   interfaces, 792-795  
 copy constructable, 1008  
 cout, 1067-1069  
   concatenation, 1071-1072  
   field width display, 1080-1081  
   fill characters, 1081-1082  
   floating-point display precision,  
   1082-1083  
   flushing buffers, 1075-1076  
   formatting data types, 1076-1078  
   methods, 1071-1075  
   number base display, 1078-1079  
   printing trailing zeros/decimal  
   points, 1083-1090  
 creating, 523  
 defined, 13, 36  
 functions. *See* function objects  
 ifstream, 1116-1119  
 ofstream, 1115-1119  
 ostream, 1142-1145  
 passing by reference, 770  
 passing by value, 770  
 pointers, 665-670  
 reference variables, 401-405  
 returning, 662-664, 770-771  
   const objects, 662-665  
   non-const objects, 663  
 stream, 1067  
 string, 965  
 subobjects, 797  
 this pointer, 539-546  
 valarray, 1045-1051  
 vector, 979-991, 1045-1051  
   adding elements to, 982-983  
   past-the-end iterators, 981-982  
   removing ranges of, 982  
   shuffling elements in, 987  
   sorting, 987  
   vect1.cpp example, 980-981  
   vect2.cpp sample program, 984-986  
   vect3.cpp sample program,  
   988-991  
**oct manipulators, 1078-1079, 1090-1091**  
**octal numbers, 1215-1216**  
**ofstream objects, 290, 1115-1119**  
**one definition rule, 475**  
**one-dimensional arrays, 244**

**OOP (object-oriented programming), 13, 506-507, 512, 1207**

- classes, 47-48
- client/server model, 520
- overview, 13-14

**open namespaces, 485****open() method, 291-293, 967, 1119, 1122-1125****opening files, 1124-1125**

- multiple, 1119

**operands, 97****operator functions, 565****operator overloading, 37, 564-566**

- addition operator (+), 569-572
- cin object input, 1095-1097
- example, 565-569
  - mytime0.cpp, 566
  - mytime0.h, 566
  - usetime0.cpp, 568-569
- left shift operator (<), 581-587

- member versus nonmember functions, 587-588

## multiplication operator (\*), 574-578

## operator functions, 565

- operator\*(), 574-578
- operator+(), 569-572
- operator-(), 574-578
- operator<<(), 581-585, 587

## restrictions, 573-574

## subtraction operator (-), 574-578

## vector class, 588-590, 600

- adding vectors, 590
- declaring, 591-592
- displacement vectors, 589
- implementation comments, 602
- member functions, 592, 597
- multiple representations, 599
- overloaded arithmetic operators, 599-600
- overloading overloaded operators, 601
- Random Walk sample program, 602, 605-606
- state members, 597-599
- with classes, string, 965

**operator\*() function, 574-578****operator+() function, 569-572****operator+() method, 1266****operator-() function, 574-578****operators, 1235**

- addition operator (+), overloading, 569-572

## alternative tokens, 1222

## arithmetic operators, 97-99

- associativity, 99-100
- division (/), 100-101
- modulus (%), 101-102
- order of precedence, 99-100

## assignment (=), 43-44, 644, 767-768, 772-775

- custom definitions, 645-646
- enumerator value ranges, 153
- enumerator values, setting, 152
- overloading, 652-658
- potential problems, 645
- strings, 133-134
- structures, 145-146
- when to use, 644

## associativity, 1231

- examples, 1234
- table of, 1232-1234

## binary operators, 601, 1234

## bitwise operators, 1235

- alternative representations, 1240
- logical bitwise operators, 1237-1240
- shift operators, 1235-1237
- testing bit values, 1241-1242
- toggleing, 1241
- turning bits off, 1241
- turning bits on, 1241

## combination assignment operators, 211-212

## comma, 214-217

- example, 214-216
- precedence, 217

## concatenation (+), strings, 133-134

## conditional (?:), 273-274

## const\_cast, 944

## decrement (—), 207-208

- pointers, 210-211
- postfixing, 209-210
- prefixing, 209-210

## dereferencing (\*), pointers, 171-172

## defined, 70

## delete, 163-164, 180-183, 400, 454, 476-477, 668

## dereferencing (\*), 155-159

## dynamic cast, 934-943

- functor equivalents for arithmetic, logical, and relational operators, 1031-1032
- increment (++), 197, 207-208
  - pointers, 210-211
  - postfixing, 209-210
  - prefixing, 209-210
- left shift operator (<<)
  - overloading, 581-587, 676
- literal operators, 1204
- member dereferencing operators, 1242-1246
- multiplication operator (\*), overloading, 574-578
- new, 180-182, 454, 476-482, 668
  - bad\_alloc exceptions, 921
  - constructors, 659-661, 677-678
  - dynamic arrays, 164-167
  - dynamic structures, 178-180
  - free store, 183
  - memory allocation, 160-162
  - placement new, 671-676
  - reference variables, 400
- operator functions, 565
  - operator\*(), 574-578
  - operator+(), 569-572
  - operator-(), 574-578
  - operator<<(), 581-587
- overloading, 101, 564-565
  - addition operator (+), 569-572
  - assignment operator, 652-658
  - example, 565-569
  - left shift operator (<<), 581-587, 676
  - member versus nonmember functions, 587-588
  - multiplication operator (\*), 574-578
  - operator functions, 565
  - overloading overloaded operators, 601
  - restrictions, 573-574
  - subtraction operator (-), 574-578
- precedence, 1231
  - examples, 1234
  - table of, 1232-1234
- reference operator (&), 383-386
- reinterpret\_cast, 946
- relational operators, 217-220
  - C-style strings, comparing, 220-223
  - equality operator (==), 218-220
  - string class strings, comparing, 223-224
  - table of, 217
- scope resolution (::), 467
- scope-resolution (::), 514
- scope-resolution operator, 1332
- sizeof, 71-73
- static\_cast, 945-946
- subtraction operator (-), overloading, 574-578
- type cast, 943-944
- type info structure, 934
- typeid, 934, 939-944
- unary minus, 601
- unary operators, 601, 1234
- operator[]() method, 787, 1259, 1283-1286**
- OR operators**
  - bitwise OR (|), 1237-1238
  - logical OR (||), 260-262
    - alternative representations, 270
    - example, 261-262
    - precedence, 269
- or.cpp, 261**
- ordering**
  - strict weak, 988
  - total, 988
- ostream class, 47, 1065**
- ostream iterator template, 1002-1003**
- ostream methods, 1071-1075**
- ostreamstring class, 1142-1145**
- ourfunc.cpp, 54**
- outfile.cpp, 290-291**
- output**
  - buffers, flushing, 1075-1076
  - classes, ostream, 1070-1075
  - concatenating, 46-47, 1071-1072
  - cout
    - field width display, 1080-1081
    - fill characters, 1081-1082
    - floating-point display precision, 1082-1083
    - formatting data types, 1076-1078
    - number base display, 1078-1079
    - printing trailing zeros/decimal points, 1083-1090



- cout object, 1069
- displaying with cout, 36
  - concatenated output, 46-47
  - endl manipulator, 37-38
  - integer values, 44-45
  - \n newline character, 38-39
- output iterators, 998**
- out\_of\_bounds exception, 919**
- overload resolution, 431-432**
  - best matches, 432-434
  - exact matches, 432-434
  - multiple arguments, 438
  - partial ordering rules, 434-436
- overloading**
  - functions, 237, 412-414, 564
    - example, 415-418
    - function signatures, 413
    - name decoration, 418
    - overload resolution, 431-438
    - when to use, 418
  - operators, 101, 564-565
    - addition operator (+), 569-572
    - assignment operator, 652-658
    - example, 565-569
    - left shift operator (<<), 581-587, 676
    - member versus nonmember functions, 587-588
    - multiplication operator (\*), 574-578
    - operator functions, 565
    - restrictions, 573-574
    - subtraction operator (-), 574-578
    - vector class, 588-590
  - reference parameters, 415
  - templates, 422-424
    - overload resolution, 431-438
- override, 1183-1184**
- ownership, 973**

---

## P

- pairs.cpp, 848**
- palindromes, 1057**
- pam() function, 362-363**
- parameter lists, 30**
- parameterized types, 419**
- parameters, 314**
  - templates, 855-858
  - type, 834
- partial ordering rules, 434-436**
- partial specializations, 851-852**
- partial\_sort() function, 1304, 1307**
- partial\_sort\_copy() function, 1304, 1307-1308**
- partial\_sum() function, 1321**
- partition() function, 1295, 1302-1303**
- passing**
  - structure addresses, 351-353
  - structures, 344-351
- passing by reference, 386, 389-390**
- passing objects**
  - by reference, 770
  - by value, 770
- past-the-end iterators, 981-982**
- peek() member function, 1109-1114**
- peeker.cpp, 1111**
- period (.), 255**
- permutations, 1038**
  - defined, 1318
  - functions
    - next\_permutation(), 1306, 1319
    - prev\_permutation(), 1319
- pf() function, 364**
- pipe character (|), 1237-1238**
  - logical OR operator (||), 260-262
    - alternative representations, 270
    - example, 261-262
    - precedence, 269
- placement new operator, 478-482, 671-676**
- placeneu1.cpp, 671-673**
- placeneu2.cpp, 674-675**
- plus sign (+)**
  - addition operator (+), overloading, 569-572
  - concatenation operator (+), strings, 133-134
  - increment operator (++), 207-208
    - pointers, 210-211
    - postfixing, 209-210
    - prefixing, 209-210
- plus\_one.cpp, 207**
- pointed-to values, 172**
- pointer arithmetic, 167-172**

**pointer.cpp, 155****pointers, 153, 321-322, 837**

- assigning values to, 171
- auto\_ptr, 969, 973-975
- C++ philosophy, 155
- cautions, 159
- compared to pointed-to values, 172
- const keyword, 334-336
- declaring, 155-159, 171
- deferencing, 171-172
- delete operator, 163-164
- example, 154
- function pointers, 361-362
  - addresses of functions, obtaining, 362
  - declaring, 362-363
- increment/decrement operators, 210-211
- inheritance, 737-739
- initializing, 157-159
- integers, 160
- iterators, 1001
- member dereferencing operators, 1242-1246
- new operator, 160-162
- passing variables, 386-390
- pointer arithmetic, 167-172
- pointer notation, 173
- pointers to objects, 665-670
- pointers to pointers, 335
- stacks of pointers, 837-843
- strings, 173-178
- this, 539-546

**polar coordinates, 347**

- converting rectangular coordinates to, 348-351

**polymorphic public inheritance, 722-723**

- base-class functions, 777
- Brass class declaration, 723-726
- Brass class implementation, 727-731
- Brass class objects, 732-733
- BrassPlus class declaration, 723-726
- BrassPlus class implementation, 727-731
- BrassPlus class objects, 732-733
- constructors, 742
- dynamic binding, 737-740
- pointer compatibility, 737-739

- reference type compatibility, 737-739

- static binding, 737, 740

- virtual destructors, 737, 742-743, 776

- virtual functions, 739-742, 775-776

- behavior, 734-736

- friends, 743, 776

- memory and execution speed, 742

- redefinition, 743-745

- virtual function tables, 740

**pop() method, 837****popping values off heap, 1314****pop\_heap() function, 1305****portability of C++, 15-18**

- ANSI/ISO standard, 16

- limitations, 16

**postfixing, 209-210****potential scope, 483****pound sign (#), 234****pow() function, 53****precedence**

- comma operator, 217

- logical operators, 269-270

**precedence of operators, 1231**

- examples, 1234

- table of, 1232-1234

**precise.cpp, 1082****precision() function, 1082-1083****precision() method, 408****predefined functors, 1030-1032**

- equivalents for operators, 1032

**predicates**

- adaptable, 1035

- binary, 1027-1030

- adaptable, 1035

- unary, 1027, 1030

**prefixing, 209-210****preprocessors, 33-34****prev\_permutation() function, 1319****print() functions, 413****printf() function, 29, 44****priority\_queue class templates, 1017-1018****priority\_queue containers, 1017-1018****private inheritance, 797**

- base-class components, initializing, 798-799

- base-class friends, accessing, 801-804

- base-class methods, accessing, 800-801

- base-class objects, accessing, 801
- compared to containment, 806
- Student class example, 798, 804–805
- private keyword, 511–513, 798**
- private member functions, 513**
- probability() function, 318–320**
- problem domains, 1207**
- procedural languages, 11–12**
- procedural programming, 506–507**
- procedures. See functions**
- programming**
  - concurrent programming, 1202–1203
  - low-level programming, 1203–1204
  - programming, generic, 992**
    - associative containers, 1018–1026
      - multimap, 1023–1025
      - set, 1019–1022
    - container concepts, 1007–1012
      - container methods compared to functions, 1039–1041
      - properties, 1008–1009
      - sequence requirements, 1011–1012
    - container types, 1013, 1017–1018
      - deque, 1013
      - list, 1014–1017
      - priority\_queue, 1017–1018
      - queue, 1017
      - stack, 1018
      - vector, 1012–1013
  - iterators, 992, 997–1005
    - back insert iterators, 1005–1007
    - bidirectional iterators, 998
    - concepts, 1000
    - copy() function, 1001–1002
    - forward iterators, 998
    - front insert iterators, 1005–1007
    - hierarchy, 999–1000
    - importance of, 992–996
    - input iterators, 997–998
    - insert iterators, 1005–1007
    - istream iterator template, 1003
    - models, 1001
    - ostream iterator template, 1002
    - output iterators, 998
    - pointers, 1001
    - random access iterators, 999
    - reverse iterators, 1003–1005
    - types, 997
- programming exercises**
  - chapter 2, 62–63
  - chapter 3, 111–113
  - chapter 4, 192–193
  - chapter 5, 251–252
  - chapter 6, 301–303
  - chapter 7, 374–377
  - chapter 8, 444–446
  - chapter 9, 501–503
  - chapter 10, 559–562
  - chapter 11, 623–624
  - chapter 12, 702–705
  - chapter 13, 780–783
  - chapter 14, 871–876
  - chapter 15, 949
  - chapter 16, 1057–1058
  - chapter 17, 1148–1151
  - chapter 18, 1212–1213
- programs**
  - comments, 33
    - /\*...\*/ notation, 33
    - // notation, 32
  - creating main() function, 31
  - header filenames, 34
  - istream file, 33–34
  - main() function, 29–30
    - calling, 30
    - importance of, 32
    - int main() header, 30–31
  - myfirst.cpp example, 27–29
    - comments, 32–33
    - header filenames, 34
    - istream file, 33–34
    - main() function, 29–32
    - namespaces, 35–36
    - output, displaying with cout, 36–39
      - source code formatting, 39–40
    - namespaces, 35–36
    - output, displaying with cout, 36
      - concatenated output, 46–47
      - endl notation, 37–38
      - integer values, 44–45
      - \n newline character, 38–39
    - source code formatting, 39
      - tokens, 39–40
      - white space, 39
  - properties**
    - algorithms, 1036–1037
    - class member functions, 777–778

containers, 1008-1010  
 reference variables, 390-391

**protected classes, 745-746, 775**  
**protected inheritance, 806-807**  
**protected keyword, 745-746, 775, 806**  
**protos.cpp, 310**  
**prototypes (functions), 50-52, 309-311**  
 benefits, 312-313  
 C++ compared to ANSI C, 312  
 function prototypes, 1330  
 syntax, 311-312

**pseudorandom numbers, 605**  
**ptrstr.cpp, 174-175**  
**public derivation, 711**  
**public inheritance, 806, 808, 829. See also**  
**MI (multiple inheritance)**  
 multiple inheritance, methods, 826

**public inheritance (polymorphic), 722-723**  
 base-class functions, 777  
 Brass class declaration, 723-726  
 Brass class implementation, 727,  
 730-731  
 Brass class objects, 732-733  
 BrassPlus class declaration, 723-726  
 BrassPlus class implementation, 727,  
 730-731  
 BrassPlus class objects, 732-733  
 constructors, 742  
 dynamic binding, 737-740  
 pointer compatibility, 737-739  
 reference type compatibility, 737-739  
 static binding, 737, 740  
 virtual destructors, 737, 742-743, 776  
 virtual functions, 739-742, 775-776  
 behavior, 734-736  
 friends, 743, 776  
 memory and execution speed, 742  
 redefinition, 743-745  
 virtual function tables, 740

**public interfaces, 509**  
**public keyword, 511-513**  
**public member functions, 513**  
**pure virtual functions, 748**  
**push\_back() function, 1041**  
**push\_back() method, 982-984**  
**push\_heap() function, 1305**  
**pushing values onto heap, 1314**  
**put() method, 1071-1075**  
**putback() member function, 1109-1114**

---

## Q

**qualified, inline, 517**  
**qualified names, 486**  
**qualified names (functions), 514**  
**qualifiers**  
 cv-qualifiers, 472-473  
 const, 473-474  
 volatile, 473  
 keywords, 473

**Queue class**  
 class declaration, 691, 694  
 design, 679  
 implementation, 680-682  
 methods, 682-690  
 public interface, 679-680

**queue class templates, 1017**  
**queue containers, 1017**  
**Queue() function, 683**  
**queue simulation, 678**  
 bank.cpp simulation, 694-698  
 Customer class, 690-691, 694  
 Queue class  
 class declaration, 691, 694  
 design, 679  
 implementation, 680-682  
 methods, 682-690  
 public interface, 679-680

**queue.cpp, 692-694**  
**queue.h, 691-692**  
**queuecount() function, 685**  
**queuetp.h, 893-895**  
**quotation marks (), 36**

---

## R

**rand() function, 53, 605**  
**random access, files, 1133-1141**  
 temporary files, 1141-1142  
**random access iterators, 999**  
**Random Walk sample program, 603**  
**random.cpp, 1138-1139**  
**random\_shuffle() function, 987-988,**  
**1295, 1302**  
**random\_shuffle() STL function, 991**  
**randwalk.cpp, 603**  
**range-based for loop**  
 C++11, 233-234  
 templates, 1161

- range\_error** exception, 919
- ranges**, logical AND operator (&&), 265-267
- ranges (arrays)**, 332-334
- RatedPlayer** class, 711-712
  - header files, 716
  - method definitions, 716
  - RatedPlayer object, 717-718
- Rating()** method, 719
- rbegin()** method, 1251, 1275
- rdstate()** stream state method, 1098-1102
- read()** member function, 1109-1114, 1130-1133
- reading**
  - C-style strings
    - get(), 127-130
    - getline(), 126-127
  - from files, 1116-1118
  - string class strings, 136-140
  - text files, 292-298
  - text with loops, 234
    - cin.get() function, 235-237, 241-244
    - cin object, 234-235
    - end-of-file conditions, 237-241
    - sentinel characters, 234
- real numbers**, 50
- recommended reading**, 1323-1324
- rect\_to\_polar()** function, 348-349
- rectangular coordinates**, 346
  - converting to polar coordinates, 348-351
- recur.cpp**, 355, 358
- recurs()** function, 357-359
- recursion**, 357
  - multiple recursive calls, 359-361
  - single recursive call, 358-359
  - variadic template functions, 1199-1202
- recursive use of templates**, 846-847
- redefining virtual functions**, 743-745
- redirecting I/O**, 1067-1068
- redirection**, 238
- refcube()** function, 391-393
- reference**, passing by, 343, 386, 389-390, 770
- reference arguments**, 392-394, 408-409
- reference counting**, 973
- reference operator (&)**, 383-386
- reference parameters**, overloading, 415
- reference returns**, const, 400
- reference type**, 1273
- reference variables**, 383
  - arguments, 408-409
  - class objects, 401-405
  - creating, 383-386
  - function parameters, 386, 389-390
  - inheritance, 405-408
  - initialization, 385
  - properties, 390-391
  - structures, 394, 397-399
    - const keyword, 401
    - return references, 399-400
- references**
  - inheritance, 737-739
  - returning, 399, 770-771
- referencing declarations**, 463
- refinement**, 1001
- register keyword**, 472
- reinterpret\_cast** operators, 946
- relational operators**, 217-220
  - C-style strings, comparing, 220-223
  - equality operator (==), 218-220
  - functor equivalents, 1031-1032
  - string class strings, comparing, 223-224
  - table of, 217
- relationships**
  - has-a, 721, 788
  - is-a, 720-722, 772, 808
- remodel()** function, 971
- remote\_access()** function, 468
- remove\_copy()** function, 1295, 1300
- remove\_copy\_if()** function, 1295, 1300
- remove()** function, 1295, 1299
- remove\_if()** function, 1295, 1300
- remove\_if()** method, 1280
- remove()** method, 1280
- rend()** method, 1251-1252, 1275
- replace\_copy()** function, 1294, 1298
- replace\_copy\_if()** function, 1294, 1298
- replace()** function, 1294, 1298, 1302
- replace\_if()** function, 1294, 1298
- replacing()** method, 1268-1269
- replacing strings**, 1268-1269
- report()** function, 859
- reserve()** method, 966, 1258, 1279
- reserved names**, 1222-1223

**reserved words, 1221**  
 alternative tokens, table of, 1222  
 keywords, table of, 1221  
 reserved names, 1222-1223

**ResetRanking() method, 718**

**resize() method, 1047, 1258, 1278**

**return addresses, 909**

**return statements, 30**

**return types, declarations, 1157**

**return types (functions), 30**

**return values, 31**

**return values (functions), 49, 57-59**

**returning**  
 C-style strings, 341-343  
 references, 399  
 structures, 344-345, 348-351

**returning objects, 662-664**  
 const objects, 662-665  
 non-const objects, 663

**reverse\_copy() function, 1295, 1301**

**reverse() function, 1295**

**reverse iterators, 1003-1005**

**reverse() method, 1252, 1280**

**reversible containers**  
 associative, multimap, 1023-1025  
 list, 1014, 1017  
 member functions, 1014-1016  
 vector, 1012-1013

**review questions**  
 chapter 2, 62  
 chapter 3, 110-111  
 chapter 4, 191-192  
 chapter 5, 250  
 chapter 6, 298-300  
 chapter 7, 372-373  
 chapter 8, 443-444  
 chapter 9, 498-501  
 chapter 10, 558-559  
 chapter 11, 623  
 chapter 12, 700-702  
 chapter 13, 779-780  
 chapter 14, 869-870  
 chapter 15, 947-949  
 chapter 16, 1056-1057  
 chapter 17, 1146-1147  
 chapter 18, 1209-1212

**rewrite rule, 517**

**rfind() method, 961, 1261**

**right manipulator, 1091**

**right shift and assign operator ([]=), 1237**

**right shift operator ([]), 1236**

**Ritchie, Dennis, 11**

**rotate\_copy() function, 1295, 1302**

**rotate() function, 1295, 1301**

**RTTI (runtime type information), 933-934**  
 incorrect usage, 941-943  
 operators  
 dynamic cast, 934-939  
 typeid, 934, 939, 941, 944  
 type info class, 939-941, 944  
 type info structure, 934

**rtti1.cpp, 936-938**

**rtti2.cpp, 939-941**

**ruler.cpp, 360**

**runtime, 155**

**runtime\_error exception, 919**

**runtime type information, 933**

**rvalue reference, 1162-1164**  
 constructors, C++11, 1256

**rvalues, 400**

---

## S

**Sales class**  
 sales.cpp, 924  
 sales.h, 922  
 use\_sales.cpp, 925-927

**sales.cpp, 924**

**sales.h, 922**

**sayings1.cpp, 656**

**sayings2.cpp, 665**

**SCHAR\_MAX constant, 72**

**SCHAR\_MIN constant, 72**

**scientific manipulator, 1091**

**scope, 454, 483**  
 class, 454, 514  
 class scope, 549-551  
 function prototype, 454  
 global, 454  
 local, 454-457  
 namespace, 454  
 nested classes, 891-892  
 potential, 483

**scope-resolution operator (::), 467, 514, 1332**

**scoped enumerations, 1158**  
 C++11, 551-552

**search() function, 1288, 1292-1293**

- search\_n() function, 1288, 1293**
- searching strings, 960-961, 1260**
  - find\_first\_not\_of() method, 1262-1263
  - find\_first\_of() method, 1262
  - find\_last\_not\_of() method, 1263
  - find\_last\_of() method, 1262
  - find() method, 1260-1261
  - rfind() method, 1261
- secretf.cpp, 385**
- seekg() method, 1134-1136**
- seekp() method, 1134-1136**
- selecting smart pointers, 977-978**
- sell() function, 516**
- semantics, move semantics, 1164-1165, 1168-1171**
  - observations, 1171-1172
- semicolon (), 29-30**
- sending messages, OOP, 518**
- sentinel characters, 234**
- separate compilation, 447-449, 453**
- sequence points, 208-209**
- sequence requirements, container concepts, 1011-1012**
- sequences**
  - mutating sequence operations
    - copy\_backward() function, 1294-1297
    - copy() function, 1293-1296
    - fill() function, 1294, 1299
    - fill\_n() function, 1294, 1299
    - generate() function, 1294, 1299
    - generate\_n() function, 1294, 1299
    - iter\_swap() function, 1294
    - partition() function, 1295, 1302-1303
    - random\_shuffle() function, 1295, 1302
    - remove\_copy() function, 1295, 1300
    - remove\_copy\_if() function, 1295, 1300
    - remove\_if() function, 1295, 1300
    - remove() function, 1295, 1299
    - replace\_copy() function, 1294, 1298
    - replace\_copy\_if() function, 1294, 1298
    - replace() function, 1294, 1298, 1302
    - replace\_if() function, 1294, 1298
    - reverse\_copy() function, 1295, 1301
    - reverse() function, 1295
    - rotate\_copy() function, 1295, 1302
    - rotate() function, 1295, 1301
    - stable\_partition() function, 1295, 1303
    - swap() function, 1294, 1297
    - swap\_ranges() function, 1294, 1297
    - transform() function, 1294, 1297
    - unique\_copy() function, 1295, 1301
    - unique() function, 1295, 1300
  - nonmodifying sequence operations
    - adjacent\_find() function, 1287, 1290
    - count() function, 1287, 1291
    - count\_if() function, 1287, 1291
    - equal() function, 1288, 1291-1292
    - find\_end() function, 1287-1290
    - find\_first\_of() function, 1287, 1290
    - find() function, 1287-1289
    - find\_if() function, 1287-1289
    - for\_each() function, 1287-1289
    - mismatch() function, 1288, 1291
    - search() function, 1288, 1292-1293
    - search\_n() function, 1288, 1293
- set associative containers, 1019-1022**
- set flag. See setf() function**
- set\_difference() function, 1021, 1305, 1313**
- set\_intersection() function, 1021, 1305, 1312**
- set() method, 596, 820**
- set operations**
  - includes() function, 1305, 1311
  - set\_difference() function, 1305, 1313
  - set\_intersection() function, 1305, 1312
  - set\_symmetric\_difference() function, 1305, 1313
  - set\_union() function, 1305, 1312
- set\_symmetric\_difference() function, 1305, 1313**
- set\_terminate() function, 928**
- set\_tot() function, 517-518**
- set\_unexpected() function, 929**
- set\_union() function, 1020-1021, 1305, 1312**
- setf.cpp, 1085**
- setf2.cpp, 1088**

- setf() function, 1083-1087, 1090**
  - arguments, 1087-1089
  - manipulators, 1090-1091
- setf() method, 408**
- setfill() function, 1091**
- setops.cpp, 1021-1022**
- setprecision() function, 1091**
- sets**
  - methods, 1281-1284
  - set operations
    - includes() function, 1305, 1311
    - set\_difference() function, 1305, 1313
    - set\_intersection() function, 1305, 1312
    - set\_symmetric\_difference() function, 1305, 1313
    - set\_union() function, 1305, 1312
- setstate() stream state method, 1098-1102**
- setw() function, 1091**
- shallow copying, 640**
- shared friends, 888-889**
- shift operators, 1235-1237**
  - overloading, 581-587
- short data type, 68-70**
- show(), array objects, 357**
- show\_array() function, 327-328**
- Show() function, 818-820**
- show() method, 514, 537**
- show\_polar() function, 347, 351**
- show\_time() function, 344-345**
- showbase manipulator, 1090**
- showperks() function, 744**
- showpoint manipulator, 1091**
- showpos manipulator, 1091**
- showpt.cpp, 1084**
- SHRT\_MAX constant, 72**
- SHRT\_MIN constant, 72**
- side effects of expressions, 201, 208-209**
- signatures (functions), 413**
- signed char data type, 88-89**
- singly linked lists, 680**
- size, string size**
  - finding, 960
  - automatic sizing feature, 966-967
- size() function, 136, 960**
- size() method, 509, 787, 981, 984, 1251-1252, 1275**
- size\_type constant, 1251**
- size\_type type, 1250, 1273**
- sizeof operator, 71-73**
- smart pointers, 1158**
  - selecting, 977-978
- sort() function, 987-988, 1041, 1304, 1307**
- sort\_heap() function, 1305**
- sort() method, 1016-1017, 1280**
- sort() STL function, 991**
- sorting**
  - heaps, 1315
  - nth\_element() function, 1304, 1308, 1315
  - partial\_sort\_copy() function, 1304, 1307-1308
  - partial\_sort() function, 1304, 1307
  - sort() function, 1304, 1307
  - stable\_sort() function, 1304, 1307
  - vectors, 987
- source code, 19**
  - definition of, 18
  - file extensions, 20
- special meanings, identifiers, 1223**
- special member functions, 1178-1179**
- specializations**
  - explicit, 425, 850-851
    - example, 426-428
    - third-generation specialization, 425-426
  - explicit instantiations, 850
  - implicit instantiations, 850
  - partial specializations, 851-852
- specifiers**
  - storage class, 472-473
- splice() method, 1016, 1280**
- sqrt.cpp, 51**
- sqrt() function, 50-52**
- square() function, 381-382**
- stable\_partition() function, 1295, 1303**
- stable\_sort() function, 1304, 1307**
- stack, unwinding, 909-910, 913-914**
- stack class, 831-836**
  - pointers, 837-843
  - templates, 1018
- stack containers, 1018**
- stack.cpp, 554-555**
- stack.h, 553-554**
- stacker.cpp, 556-557**
- stacks, 553-557**
  - automatic variables, 458-459
- stacktem.cpp, 835-836**



**stacktp.h, 834****standard C++, converting to, 1327**

- auto\_ptr template, 1333
- C++ features, 1331
- const instead of #define, 1327-1329
- function prototypes, 1330
- header files, 1331
- inline instead of #define, 1329-1330
- namespaces, 1331-1333
- STL (Standard Template Library), 1334
- string class, 1333
- type casts, 1330-1331

**Standard Input/Output, ANSI C, 1062****Standard Template Library. See STL****state members, 597-599****statements, 41**

- assignment statements, 43-44
- blocks, 212-214
- break, 280-282
- cin, 46
  - loops, 234-235
- compared to expressions, 201
- continue, 280-282
- cout, 36
  - concatenated output, 46-47
  - cout.put() function, 83-84
  - endl manipulator, 37-38
  - integer values, displaying, 44-45
  - \n newline character, 38-39
- declaration statements, 41-43
- defined, 29-30
- enum, 278-280
- examples, 41, 45
- for, declaration-statement expressions, 203
- if, 254
  - bug prevention, 260
  - example, 255
  - syntax, 254
- if else, 255
  - example, 256-257
  - formatting, 257-258
  - if else if else construction, 258-260
  - syntax, 255
- return statements, 30
- switch, 274-278
  - enumerators as labels, 278-280
  - example, 275-278
  - syntax, 275

- terminators, 30

- void, 53

**static assert, 1204****static binding, 164, 172-173, 737, 740****static\_cast operator, 945-946****static class members, 628-637****static keyword, 183, 472**

- functions, 475

**static memory storage, 182-183****static storage duration, 453****static type checking, 313****static variables, 453, 459-462, 466**

- external, 466
  - external linkage, 463, 466-467
  - internal linkage, 467-470
  - no linkage, 470-472

**static.cpp, 470-471****stcktp1.h, 839-840****std namespace, 59****stdexcept exception classes, 918-920****Stepanov, Alexander, 978, 1205****stkoptr1.cpp, 841-842****STL (Standard Template Library), 978, 1041, 1044, 1271, 1334**

- algorithms, 1035
  - groups, 1035-1036
  - properties, 1036-1037
- associative containers, 1018, 1026
  - multimap, 1023-1025
  - set, 1019-1022
- binary search operations
  - binary\_search() function, 1304, 1310
  - equal\_range() function, 1304, 1309
  - lower\_bound() function, 1304, 1309
  - upper\_bound() function, 1304, 1309
- C++11, 1271
  - containers, 1271-1273
- container concepts, 1007
  - container methods compared to functions, 1039-1041
  - properties, 1008-1010
  - sequence requirements, 1011-1012
- container methods, 1275-1277
- container types
  - deque, 1013
  - list, 1014-1017
  - priority\_queue, 1017-1018
  - queue, 1017

- stack, 1018
  - vector, 1012-1013
- containers, 1161
- deque methods, 1278-1280
- functions, 1286
  - adjacent\_find(), 1287, 1290
  - copy(), 1293-1296
  - copy\_backward(), 1294-1297
  - count(), 1287, 1291
  - count\_if(), 1287, 1291
  - equal(), 1288, 1291-1292
  - fill(), 1294, 1299
  - fill\_n(), 1294, 1299
  - find(), 1287-1289
  - find\_end(), 1287-1290
  - find\_first\_of(), 1287, 1290
  - find\_if(), 1287-1289
  - for\_each(), 1287-1289
  - generate(), 1294, 1299
  - generate\_n(), 1294, 1299
  - iter\_swap(), 1294
  - mismatch(), 1288, 1291
  - partition(), 1295, 1302-1303
  - random\_shuffle(), 1295, 1302
  - remove(), 1295, 1299
  - remove\_copy(), 1295, 1300
  - remove\_copy\_if(), 1295, 1300
  - remove\_if(), 1295, 1300
  - replace(), 1294, 1298, 1302
  - replace\_copy(), 1294, 1298
  - replace\_copy\_if(), 1294, 1298
  - replace\_if(), 1294, 1298
  - reverse(), 1295
  - reverse\_copy(), 1295, 1301
  - rotate(), 1295, 1301
  - rotate\_copy(), 1295, 1302
  - search(), 1288, 1292-1293
  - search\_n(), 1288, 1293
  - stable\_partition(), 1295, 1303
  - swap(), 1294, 1297
  - swap\_ranges(), 1294, 1297
  - transform(), 1294, 1297
  - unique(), 1295, 1300
  - unique\_copy(), 1295, 1301
- functors, 1026-1027
  - adaptable, 1032
  - concepts, 1027-1028, 1030
  - predefined, 1030-1032
- generic programming, 992
- heap operations
  - make\_heap() function, 1305, 1314
  - pop\_heap() function, 1305, 1314
  - push\_heap() function, 1305, 1314
  - sort\_heap() function, 1305, 1315
- iterators, 997
  - concepts, 1001
  - pointers, 1001
- list methods, 1278-1280
- map methods, 1281-1284
- merge operations
  - inplace\_merge() function, 1305, 1311
  - merge() function, 1305, 1310-1311
- methods, 1161
- minimum/maximum value operations
  - lexicographical\_compare() function, 1306, 1318
  - max\_element() function, 1305, 1317
  - max() function, 1305, 1316
  - min\_element() function, 1305, 1317
  - min() function, 1305, 1316
- numeric operations, 1319-1320
  - accumulate() function, 1320
  - adjacent\_difference() function, 1321-1322
  - inner\_product() function, 1320-1321
  - partial\_sum() function, 1321
- permutation operations
  - next\_permutation() function, 1306, 1319
  - prev\_permutation() function, 1319
- set methods, 1281-1284
- set operations
  - includes() function, 1305, 1311
  - set\_difference() function, 1305, 1313
  - set\_intersection() function, 1305, 1312
  - set\_symmetric\_difference() function, 1305, 1313
  - set\_union() function, 1305, 1312
- sorting operations
  - nth\_element() function, 1304, 1308, 1315
  - partial\_sort() function, 1304, 1307
  - partial\_sort\_copy() function, 1304, 1307-1308
  - sort() function, 1304, 1307
  - stable\_sort() function, 1304, 1307

- string class, 1038-1039
- types, 1273-1274
- usealgo.cpp sample program, 1042-1044
- using, 1041
- vector methods, 1278-1280
- Stock class, 511**
- stock00.h, 510**
- stock1.cpp, 531**
- stock1.h, 530**
- stocks.cpp, class member function, 515**
- stone.cpp, 610**
- stone1.cpp, 615**
- stonetolb() function, 58**
- stonewt.cpp, 608**
- stonewt.h, 607**
- stonewt1.cpp, 614-615**
- stonewt1.h, 613**
- storage class qualifiers, 473**
- storage class specifiers, 472-473**
- storage duration, 453-454**
  - automatic variables, 455-457
    - example, 455-457
    - initializing, 458
    - stacks, 458-459
  - scope and linkage, 454
  - static variables, 459-462
    - external linkage, 463, 466-467
    - internal linkage, 467-470
    - no linkage, 470-472
- str1.cpp, 953**
- str2.cpp, 966-967, 971**
- strcat() function, 136**
- strcmp() function, 221-222, 648**
- strcpy() function, 177-178, 633**
- strctfun.cpp, 348**
- strctptr.cpp, 352-353**
- stream objects, 1067**
- stream states, 1097-1098**
  - effects, 1100-1102
  - exceptions, 1099-1100
  - file I/O, 1118-1119
  - get() and getline() input effects, 1108
  - setting, 1098
- streambuf class, 1065**
- streams, 1063-1064, 1067**
  - istream class, 47
  - ostream class, 47
- strfile.cpp, 958-959**
- strgfun.cpp, 340**
- strgstl.cpp, 1038-1039**
- strict weak ordering, 988**
- strin.cpp, 1144**
- string class, 131-133, 353-354, 647, 952, 960, 965-966, 1249-1250, 1333**
  - append methods, 1265-1266
  - assignment, 133-134
  - assignment methods, 1260, 1266
  - assignment operator, overloading, 652-658
    - sayings1.cpp, 656
    - string1.cpp, 653-656
    - string1.h, 652-653
  - automatic sizing, 966-967
  - bracket notation, 649-651
  - comparing, 960
  - comparison members, 648-649
  - comparison methods, 1263-1265
  - complex operations, 135-136
  - concatenation, 133-134
  - concatenation methods, 1266
  - constants, 1251
  - constructors, 952-956, 1253
    - copy constructors, 1255-1256
    - default constructors, 1254
    - that use arrays, 1254
    - that use n copies of characters, 1257
    - that use parts of arrays, 1254-1255
    - that use ranges, 1257
  - copy methods, 1269
  - data methods, 1251-1253
  - default constructor, 647-648
  - erase methods, 1267-1268
  - finding size of, 960
  - Hangman sample program, 962-965
  - input, 957-960
  - input/output, 1269-1270
  - insertion methods, 1267
  - memory-related methods, 1258
  - reading line by line, 136-140
  - replacement methods, 1268-1269
  - search methods, 1260
    - find(), 1260-1261
    - find\_first\_not\_of(), 1262-1263
    - find\_first\_of(), 1262
    - find\_last\_not\_of(), 1263
    - find\_last\_of(), 1262
    - rfind(), 1261

- searching, 960-961
- static class member functions, 651-652
- STL interface, 1038-1039
- string access methods, 1259
- string comparisons, 223-224
- structures, 144-145
- template definition, 1249
- types, 1250-1251
- string() constructors, 952-956, 1253**
  - copy constructors, 1255-1256
  - default constructors, 1254
  - that use arrays, 1254
  - that use n copies of character, 1257
  - that use parts of arrays, 1254-1255
  - that use ranges, 1257
- string1.cpp, 653-656**
- string1.h, 653**
- StringBad class, 628**
  - constructors, 632-633
  - destructor, 633
  - strngbad.cpp, 630-631
  - strngbad.h, 628-629
  - vegnews.cpp sample program, 633-637
- strings**
  - accessing, 1259
  - accessing with for loops, 206-207
  - appending, 1265-1266
  - assigning, 1266
  - C-style, 120-122
    - combining with numeric input, 130-131
    - concatenating, 122
    - empty lines, 130
    - failbits, 130
    - in arrays, 123-124
    - null characters, 121
    - passing as arguments, 339-341
    - pointers, 173-178
    - returning from functions, 341-343
    - string input, entering, 124-126
    - string input, reading with get(), 127-130
    - string input, reading with getline(), 126-127
  - comparing, 1263-1265
    - C-style strings, 220-223
    - string class strings, 223-224
  - concatenating, 128, 1266
  - copying, 1269
  - erasing, 1267-1268
  - initializing, 121
  - input, 1106-1108
  - input/output, 1269-1270
  - inserting, 1267
  - palindromes, 1057
  - replacing, 1268-1269
  - searching, 1260
    - find\_first\_not\_of() method, 1262-1263
    - find\_first\_of() method, 1262
    - find\_last\_not\_of() method, 1263
    - find\_last\_of() method, 1262
    - find() method, 1260-1261
    - rfind() method, 1261
  - string access methods, 1259
  - string class, 131-133, 647, 960, 966, 1249-1250, 1333
    - append methods, 1265-1266
    - appending, 133-134
    - assignment, 133-134
    - assignment methods, 1260, 1266
    - assignment operator, overloading, 652-658
    - automatic sizing, 966-967
    - bracket notation, 649-651
    - comparing, 960
    - comparison members, 648-649
    - comparison methods, 1263-1265
    - complex operations, 135-136
    - concatenation, 133-134
    - concatenation methods, 1266
    - constants, 1251
    - constructors, 952-956, 1253-1257
    - copy methods, 1269
    - data methods, 1251-1253
    - default constructor, 647-648
    - erase methods, 1267-1268
    - finding size of, 960
    - Hangman sample program, 962-965
    - input, 957-960
    - input/output, 1269-1270
    - insertion methods, 1267
    - memory-related methods, 1258
    - reading line by line, 136-140
    - replacement methods, 1268-1269
    - search methods, 1260-1263

- searching, 960-961
- static class member functions, 651-652
- STL interface, 1038-1039
- string access methods, 1259
- structures, 144-145
- template definition, 1249
- types, 1250-1251
- string class objects, 353-354
- StringBad class, 628
  - constructors, 632-633
  - destructor, 633
  - strngbad.cpp, 630-631
  - strngbad.h, 628-629
  - vegnews.cpp sample program, 633-637
  - swapping, 1269
- strings.cpp, 123**
- strlen() function, 123-124, 136, 177, 306, 632**
- strngbad.cpp, 630-631**
- strngbad.h, 629**
- Stroustrup, Bjarne, 14-15**
- strout.cpp, 1143**
- strquote.cpp, 402-403**
- strtref.cpp, 395**
- strtype1.cpp, 132**
- strtype2.cpp, 134**
- strtype4.cpp, 137**
- struct keyword, 140**
- structur.cpp, 142**
- structure initialization, C++11, 144**
- structure members, 141**
- structured programming, 12**
- structures, 140-142, 343, 346**
  - addresses, passing, 351-353
  - arrays, 147-148
  - assignment, 145-146
  - bit fields, 148
  - compared to classes, 514
  - dynamic structures, new operator, 178-180
  - example, 142-144
  - nested structures, 682
  - passing/returning structures, 344-345, 348-351
  - polar coordinates, 347
  - rectangular coordinates, 346
  - reference variables, 394, 397-399
    - const keyword, 401
    - return references, 399-400
  - string class members, 144-145
- Student class**
  - contained object interfaces, 792-795
  - contained objects, initializing, 791
  - design, 787-788
  - methods, 793-795
  - private inheritance, 798, 804-805
    - base-class components, initializing, 798-799
    - base-class friends, accessing, 801-804
    - base-class methods, accessing, 800-801
    - base-class objects, accessing, 801
  - sample program, 795-797
  - studentc.h, 789-790
- studentc.cpp, 793**
- studentc.h, 789-790**
- studenti.cpp, 802-803**
- studenti.h, 799**
- subdivide() function, 360-361**
- sube() function, 311**
- subobjects, 797**
- subroutines. See functions**
- subscripts, 117**
- substrings, finding, 1260**
  - find\_first\_not\_of() method, 1262-1263
  - find\_first\_of() method, 1262
  - find\_last\_not\_of() method, 1263
  - find\_last\_of() method, 1262
  - find() method, 1260-1261
  - rfind() method, 1261
- subtraction operator (-), overloading, 574-578**
- sum\_arr() function, 320-322, 325**
- sum() function, 344-345, 565-567**
- sum() method, 787, 807, 1046**
- sumafire.cpp, 294-295**
- Swap() function, 420-421, 1294, 1297**
- swap() method, 981, 1269, 1276**
- swap\_ranges() function, 1294, 1297**
- swapp() function, 389**
- swapping strings, 1269**
- swapr() function, 389**
- swaps.cpp, 387-388**
- swapv() function, 389**

**switch.cpp, 276-277**  
**switch statement, 274-278**  
 compared to if else statement, 279-280  
 enumerators as labels, 278-279  
 example, 275-278  
 syntax, 275  
**symbolic constants, 72**  
**symbolic names, 90-92**

**T**

---

**TableTennisPlayer class, 708-710**  
 tabtenn0.cpp, 709  
 tabtenn0.h, 708  
 usett0.cpp, 710  
**tabtenn0.cpp, 709**  
**tabtenn0.h, 708**  
**tabtenn1.cpp, 717**  
**tabtenn1.h, 716**  
**tags, 140**  
**Technical Report 1 (TR1), 1206**  
**template aliases, C++11, 866**  
**template classes, 830-837**  
 arrays, non-type arguments, 843-845  
 auto\_ptr, 969, 973-975  
 complex, 1045  
 deque, 1013  
 explicit instantiations, 850  
 explicit specializations, 850-851  
 implicit instantiations, 850  
 list, 1014-1017  
     member functions, 1014-1016  
 members, 854-855  
 partial specializations, 851-852  
 pointers, stacks of pointers, 837-843  
 priority\_queue, 1017-1018  
 queue, 1017  
 stack, 1018  
 valarray, 1045-1046, 1049-1051  
 vector, 979-991, 1012-1013, 1045-1046, 1049-1051  
     adding elements to, 982-983  
     past-the-end iterators, 981-982  
     removing ranges of, 982  
     shuffling elements in, 987  
     sorting, 987  
     vect1.cpp example, 980-981  
     vect2.cpp sample program, 984-986  
     vect3.cpp sample program, 988-991

    versatility, 845-846  
     default type parameters, 849  
     multiple type parameters, 847  
     recursive use, 846-847  
**template functions, 438**  
 alternative function syntax, 441  
 decltype, 439  
 type, 439  
**template keyword, 831**  
**template parameter packs, 1197-1198**  
 unpacking, 1198-1199  
**templates. See also STL (Standard Template Library)**  
 angle brackets, 1162  
 auto\_ptr, 1333  
 export, 1162  
 friend classes, 858  
     bound template friend functions, 861-864  
     non-template friend functions, 858-861  
     unbound template friend functions, 864-865  
 function templates, 419, 422  
     explicit instantiation, 428-430  
     explicit specializations, 425-428  
     implicit instantiation, 428-430  
     overload resolution, 431-438  
     overloading, 422-424  
 inefficiencies, function wrapper, 1191-1194  
 initializer\_list, C++11, 1051-1053  
 istream iterator, 1003  
 nested classes, 892-896  
 ostream iterator, 1002-1003  
 parameters, 855-858  
 range-based for loop, 1161  
 STL (Standard Template Library), 1334  
 string template class, 1249-1250  
     append methods, 1265-1266  
     assignment methods, 1260, 1266  
     comparison methods, 1263-1265  
     concatenation methods, 1266  
     constants, 1251  
     constructors, 1253-1257  
     copy methods, 1269  
     data methods, 1251-1253  
     erase methods, 1267-1268  
     input/output, 1269-1270

- insertion methods, 1267
- memory-related methods, 1258
- replacement methods, 1268-1269
- search methods, 1260-1263
- string access methods, 1259
- template definition, 1249
- types, 1250-1251
- valarray, 1162
- variadic templates, 866, 1197
  - recursion, 1199-1202
  - template and function parameter packs, 1197-1198
  - unpacking the packs, 1198-1199
- tempmemb.cpp, 852**
- temporary files, random access, 1141-1142**
- temporary variables, 392-394**
- tempover.cpp, 434-437**
- tempparm.cpp, 856-857**
- terminate() function, 928-930**
- terminators, 30**
- testing bit values, 1241-1242**
- tests, loop tests, 196-197**
- text, reading with loops, 234**
  - cin.get() function, 235-237, 241-244
  - cin object, 234-235
  - end-of-file conditions, 237-241
  - sentinel characters, 234
- text files, 287-288, 1129**
  - reading, 292-298
  - writing to, 288-292
- textin1.cpp, 234**
- textin2.cpp, 236**
- textin3.cpp, 239**
- textin4.cpp, 242**
- third-generation specialization, 425-426**
- this pointer, 539**
- throw keyword, 900**
- throwing exceptions, 900, 915-916**
- tilde, 529, 1237**
- time, 1009**
- time-delay loops, 229-230**
- tmp2tmp.cpp, 862-864**
- tooggling bits, 1241**
- tokens, 39**
  - alternative tokens, table of, 1222
- tolower() function, 273, 1041**
- top-down design, 12**
- top-down programming, 331**
- topfive.cpp, 353**
- topval() method, 543**
- total ordering, 988**
- totals, calculating cumulative totals, 1320**
- toupper() function, 273**
- trailing zeros/decimal points, printing, 1083-1087, 1090**
- traits type, 1250**
- transform() function, 1030-1031, 1041, 1294, 1297**
- translation units, compiling separately, 447-449, 453**
- translator (cfront), 21**
- travel.cpp, 344-345**
- trivial conversations for exact matches, 432**
- troubleshooting compilers, 24**
- truncate.cpp, 1113**
- try blocks, 901-903**
- try keyword, 901**
- turning off bits, 1241**
- turning on bits, 1241**
- Tv class, 878-879, 883**
  - tv.cpp, 880-882
  - tv.h, 879-880
  - tvfm.h, 885-886
  - use\_tv.cpp, 882
- tv.cpp, 880-882**
- tv.h, 879-880**
- tvfm.h, 885-886**
- two-dimensional arrays, 244-249**
  - declaring, 244-246
  - initializing, 246-249
- twoarg.cpp, 316**
- twod.cpp, 846-847**
- twofile2.cpp, 469**
- twoswap.cpp, 427-428**
- twotemps.cpp, 422**
- type cast operators, 943-944**
- type casts, 606-612, 1330-1331**
- type conversion, 606-612**
  - applying automatically, 616-618
  - conversion functions, 612-616
  - friends, 618-621
  - implicit conversion, 609
- type info class, 939-941, 944**
- type info structure, 934**
- type parameters, 834**
- type of template functions, 439**
- typecast.cpp, 108**

**typedef, 371**  
**typedef keyword, 230**  
**typeid operators, 934, 939-944**  
**typename keyword, 831**  
**types**  
   char\_type, 1250  
   const\_iterator, 1273  
   const\_reference, 1273  
   difference\_type, 1250, 1273  
   iterators, 997, 1273  
   key\_compare, 1281, 1284  
   key\_type, 1281, 1284  
   mapped\_type, 1281, 1284  
   reference, 1273  
   size\_type, 1250, 1273  
   traits, 1250  
   type casts, 1330-1331  
   value\_compare, 1281, 1284  
   value\_type, 1273

## U

---

**UCHAR\_MAX constant, 72**  
**UINT\_MAX constant, 72**  
**ULONG\_MAX constant, 72**  
**UML (Unified Modeling Language), 08**  
**unary functions, 1027, 1030**  
**unary minus operator, 601**  
**unary operators, 601, 1234**  
**unbound template friend functions, 864-865**  
**uncaught exceptions, 928-931**  
**underscore (\_), 1222**  
**unexpected exceptions, 928-931**  
**unexpected() function, 929**  
**unformatted input functions, 1102**  
**Unicode, 88**  
**Unified Modeling Language (UML), 1208**  
*Unified Modeling Language User Guide, 1323*  
**uniform initialization, 1154**  
   initializer\_list, 1155  
   narrowing, 1154  
**unions, 149**  
   anonymous unions, 150  
   declaring, 149  
**unique\_copy() function, 1295, 1301**  
**unique() function, 1041, 1295, 1300**  
**unique() method, 1016-1017, 1280**  
**unique\_ptr versus auto\_ptr, 975-977**  
**universal character names, 87-88**  
**UNIX, CC compiler, 21-22**  
**unnamed namespaces, 491-492**  
**unordered associative containers,**  
   **C++11, 1283**  
**unqualified names (functions), 486, 514**  
**unsetf() function, 1090**  
**unsigned char data type, 88-89**  
**unsigned integers, 74-76**  
**unsigned long long type, 1153**  
**unwinding the stack, 909-910, 913-914**  
**upcasting, 738, 944**  
   implicit upcasting, 807  
**update() function, 466, 514**  
**updates, loop updates, 196-198, 205-206**  
**uppercase manipulator, 1091**  
**upper\_bound() functions, 1024, 1304, 1309**  
**upper\_bound() method, 1021, 1283**  
**use-case analysis, 1207**  
**use() function, 394, 397-399**  
**usealgo.cpp, 1043-1044**  
**usebrass1.cpp, 732-733**  
**usebrass2.cpp, 734**  
**usedma.cpp, 765**  
**usenmsp.cpp, 494-495**  
**user-defined functions**  
   example, 53-54  
   function form, 54-55  
   function headers, 55-56  
   return values, 57-59  
   using directive, 59-60  
**usestok0.cpp, 519**  
**usestok1.cpp, 533**  
**usestok2.cpp, 547**  
**usetime1.cpp, 571-572**  
**usetime2.cpp, 577**  
**usett0.cpp, 710**  
**usett1.cpp, 717-718**  
**use\_new.cpp, 161**  
**use\_ptr() method, 1244**  
**use\_sales.cpp, 925-927**  
**use\_stuc.cpp, 795-797**  
**use\_stui.cpp, 804-805**  
**use\_tv.cpp, 882**  
**USHRT\_MAX constant, 72**  
**using-declaration, 491**  
**using directive, 35-36, 59-60**  
**using keyword, 486-490, 807-808, 1332**



## V

**valarray class, 786-787, 1045-1046, 1049-1051**

templates, 1162

**value, passing by, 313-314, 770**

**value\_comp() method, 1282**

**value\_compare type, 1281, 1284**

**value\_type type, 1273**

**values**

assigning to pointers, 171

indirect, 155

**valvect.cpp, 1048**

**variable arrays, 1329**

**variables, 66**

assigning values to, 43

automatic, 182, 453-457

example, 455-457

initializing, 458

stacks, 458-459

automatic variables, 314

declaring, 41-43

dynamic, 454

dynamic memory, 476-479, 482

enum, 150-152

enumerators, 150-151

value ranges, 153

values, setting, 152

floating-point numbers, 92

advantages/disadvantages, 96-97

constants, 96

decimal-point notation, 92

double data type, 94-96

E notation, 92-93

float data type, 94-96

long double data type, 94-96

global, compared to local

variables, 467

indeterminate values, 73

initializing, 52, 73

integers, 68

bool, 90

char, 80-89

choosing integer types, 76-77

climits header file, 71-73

constants, 78-80, 90-92

initializing, 73

int, 68-70

long, 68-70

short, 68-70

size of operator, 71-73

unsigned, 74-76

width of, 68

keywords, static, 183

local variables, 314-315

compared to global variables, 467

naming conventions, 66-68

pointers, 153

assigning values to, 171

C++ philosophy, 155

cautions, 159

compared to pointed-to values, 172

declaring, 155-159, 171

deferencing, 171-172

delete operator, 163-164

example, 154

initializing, 157-159

integers, 160

new operator, 160-162

pointer arithmetic, 167-172

pointer notation, 173

strings, 173-178

reference variables, 383

arguments, 408-409

class objects, 401-405

creating, 383-386

function parameters, 386, 389-390

inheritance, 405-408

properties, 390-391

structures, 394, 397-401

scope, 454

global, 454

local, 454-457

namespace, 454

static, 453, 459-462

external, 466

external linkage, 463, 466-467

internal linkage, 467-470

no linkage, 470-472

temporary variables, 392-394

type conversions, 102

in arguments, 106

in expressions, 105-106

on assignment, 103-104

type casts, 107-109

**variadic templates, 866, 1197**  
 recursion, 1199-1202  
 template and function parameter packs, 1197-1198  
 unpacking the packs, 1198-1199  
**variadic2.cpp, 1201**  
**variations on function pointers, 365-370**  
**vect.cpp, 593**  
**vect.h, 591**  
**vect1.cpp, 980**  
**vect2.cpp, 984-985**  
**vect3.cpp, 988**  
**vector class, 588-590, 600, 979-988, 991, 1045-1046, 1049-1051**  
 adding elements to, 982-983  
 adding vectors, 590  
 declaring, 591-592  
 displacement vectors, 589  
 implementation comments, 602  
 member functions, 592, 597  
 multiple representations, 599  
 overloaded arithmetic operators, 599-600  
 overloading overloaded operators, 601  
 past-the-end iterators, 981-982  
 Random Walk sample program, 602, 605-606  
 removing ranges of, 982  
 shuffling elements in, 987  
 sorting, 987  
 state members, 597-599  
 vect1.cpp example, 980-981  
 vect2.cpp sample program, 984-986  
 vect3.cpp sample program, 988-991  
**vector class templates, 1012-1013**  
**vector containers, 1012-1013**  
**vector objects versus arrays, 188-189**  
**vector template class, 120, 186-187**  
**vectors, methods, 1278-1280**  
**vegnews.cpp, 634**  
**versatility of templates, 845-846**  
**version1() function, 403**  
**version2() function, 404**  
**version3() function, 405**  
**ViewAcct() function, 725-726, 730**  
**virtual base classes, 815-817**  
 combining with nonvirtual base classes, 828  
 constructors, 817-818

dominance, 828-829  
 methods, 818-828  
**virtual destructors, 737, 742-743, 776**  
**virtual function tables (vtbl), 740**  
**virtual functions, 739-742, 775-776**  
 behavior, 734-736  
 friends, 743, 776  
 memory and execution speed, 742  
 pure virtual functions, 748  
 redefinition, 743-745  
 virtual function tables, 740  
**virtual keyword, 742**  
**virtual methods, 1183-1184**  
**void functions, 307**  
**void statement, 53**  
**volatile keyword, 473**  
**vslice.cpp, 1049-1050**  
**vtbl (virtual function table), 740**

---

## W

**waiting.cpp, 229**  
**wchar\_t data type, 89, 1064**  
**width of integers, 68**  
**Web resources, 1325**  
**what() function, 917**  
**while loops, 224-227**  
 compared to for loops, 227-228  
 example, 225-226  
 syntax, 224  
 time-delay loops, 229-230  
**while.cpp, 225**  
**white space, 39**  
**width() method, 1080-1081**  
**width.cpp, 1080**  
**Windows, compilers, 23-24**  
**Withdraw() method, 731, 745**  
**Worker class, 810-814**  
**Worker0.cpp, 811-812**  
**Worker0.h, 810-811**  
**workermi.cpp, 823-825**  
**workermi.h, 821-822**  
**workmi.cpp, 826-827**  
**worktest.cpp, 813**  
**WorseThan() function, 988**  
**wow() function, 409**  
**wrapped.cpp, 1195**

**wrappers, 1191**

function wrapper

fixing problems, 1194-1196

options for, 1196-1197

template inefficiencies, 1191-1194

**write.cpp, 1073-1074**

**write() member function, 1130-1133**

**write() method, 1071-1075**

**writing**

to files, 1115-1118

to text files, 288-292

---

**X-Z**

---

**XOR operator, bitwise XOR (^), 1238**

**zeros, trailing, 1083-1087, 1090**

# Take the Next Step to Mastering C++



978-0-321-54372-1

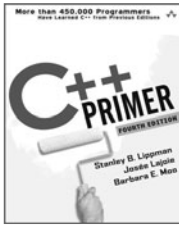

978-0-201-72148-5

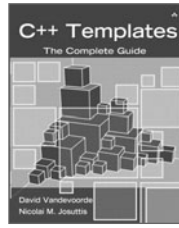

978-0-201-73484-3

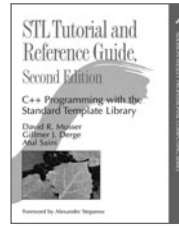

978-0-321-70212-8

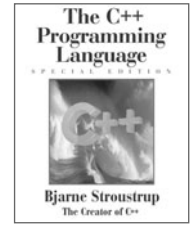

978-0-201-70073-2



978-0-13-704483-2



978-0-13-700130-9



978-0-201-37926-6



978-0-321-41299-7



978-0-321-13354-0



978-0-321-33487-9

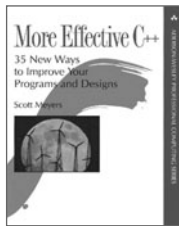

978-0-201-63371-9



978-0-201-74962-5

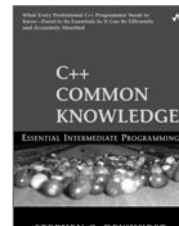

978-0-321-32192-3

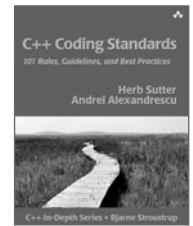

978-0-321-11358-0



978-0-201-76042-2

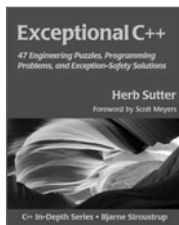

978-0-201-61562-3



978-0-201-70434-1

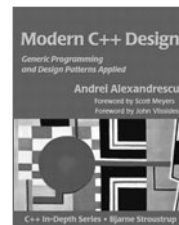

978-0-201-70431-0

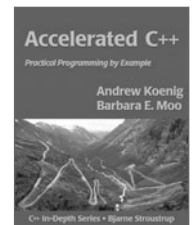

978-0-201-70353-5



For more information on these titles  
visit [informit.com](http://informit.com)

# Developer's Library Series

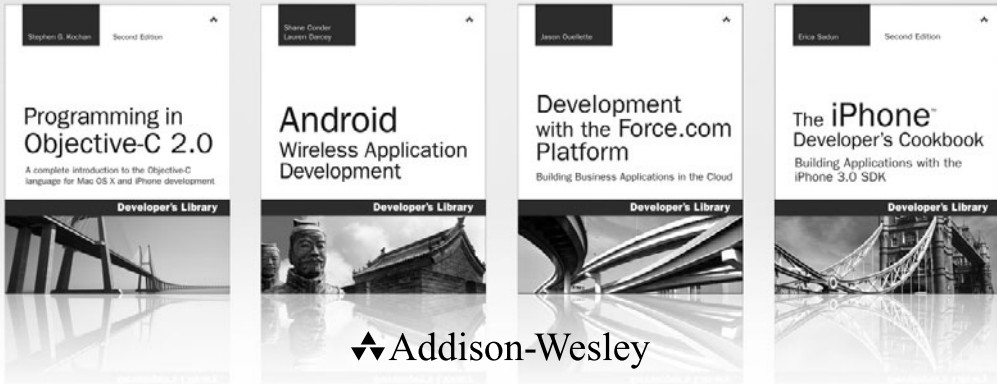

Visit **developers-library.com** for a complete list of available products

**T**he **Developer's Library Series** from Addison-Wesley provides practicing programmers with unique, high-quality references and tutorials on the latest programming languages and technologies they use in their daily work. All books in the Developer's Library are written by expert technology practitioners who are exceptionally skilled at organizing and presenting information in a way that's useful for other programmers.

Developer's Library books cover a wide range of topics, from open-source programming languages and databases, Linux programming, Microsoft, and Java, to Web development, social networking platforms, Mac/iPhone programming, and Android programming.



