

Radio Shack

ONE DOLLAR AND
FIFTY CENTS

62-2057

BOOK MARKET
\$1.50

Math for the ELECTRONICS STUDENT

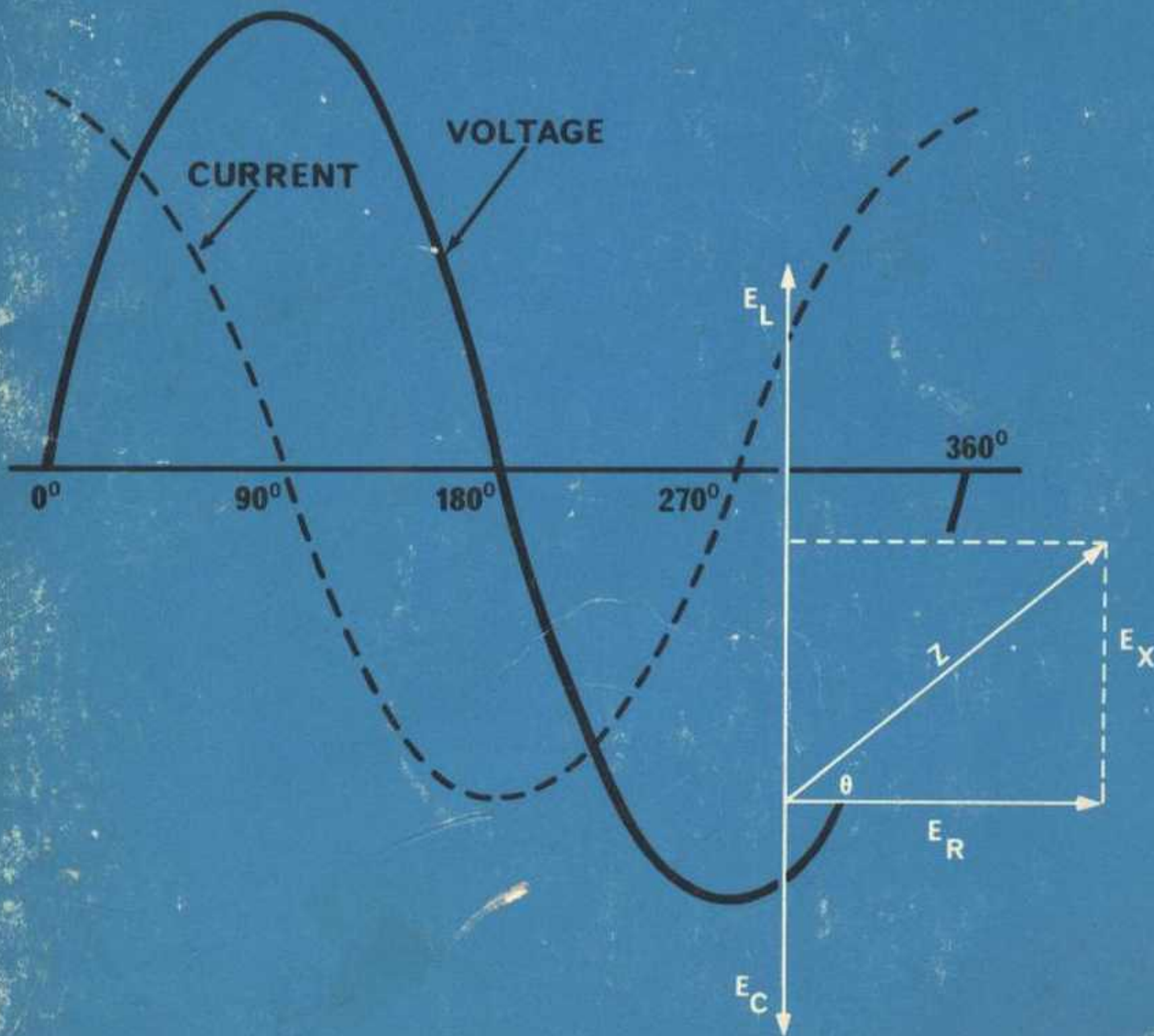

FIRST EDITION
SECOND PRINTING—1975

Copyright © 1974 by Radio Shack, a Tandy Corporation
Company, Fort Worth, Texas 76107. Printed in the United
States of America.

All rights reserved. Reproduction or use, without express
permission, of editorial or pictorial content, in any manner,
is prohibited. No patent liability is assumed with respect
to the use of the information contained herein.

Library of Congress Catalog Card Number: 74-78010

PREFACE

In acquiring a knowledge of electronics, or in the application of such knowledge, once it is acquired, a certain amount of mathematics is indispensable. The topics covered here have been selected as some of the most essential and will provide a good basic foundation in electronic math.

Scientific notation (powers of ten) greatly reduces the number of digits required in dealing with very large or very small quantities. The text shows how to use powers of ten to add, subtract, multiply, divide, square, and extract square roots.

The working principles of basic algebra are useful whenever it is necessary to find some unknown quantity in terms of known quantities. Only the simplest operations are covered, including negative numbers, terminology, combining terms, factoring, and simple equations.

Ohm's law is probably the most important and most used law in electronics. The three basic forms and their application to series circuits, parallel circuits, and combinations of these two circuit types are given.

The circuit elements, resistance, capacitance, and inductance, each receive a separate chapter for their study. This includes definitions, series and parallel combinations, reactance formulas, charge and energy, and time constants.

In electronics, many phenomena are associated with the use of alternating current with certain components. Reactance, both inductive and capacitive, varies as the frequency of applied AC varies. This is shown by the reactance formulas. In addition, there are such properties as phase relationships, rms and peak values of voltage and current, real and apparent power, power factor, and series and parallel resonance. These are all given the detailed attention their importance warrants, and worked examples show how formulas are used to solve for their numerical values.

The reader who understands and masters the math presented here will be able to handle a majority of the math problems associated with general electronics applications. If further specialized study is needed, he will have a good foundation on which to build.

ALAN ANDREWS

CONTENTS

CHAPTER 1

SCIENTIFIC NOTATION	7
Addition and Subtraction—Multiplication—Division—Reciprocals—Squares and Square Roots—Units of Measurement	

CHAPTER 2

BASIC ALGEBRA	18
Negative Numbers—Terminology—Combining Terms—Factoring—Equations	

CHAPTER 3

OHM'S LAW	34
Series Circuits—Parallel Circuits—Series-Parallel Circuits—Power	

CHAPTER 4

RESISTANCE	43
Series Resistors—Parallel Resistors—Conductance	

CHAPTER 5

AC AND AC CIRCUITS	50
Average Values—Effective Values—AC Circuits—Series Circuits—AC Power	

CHAPTER 6

FREQUENCY	66
Wavelength—Time	

CHAPTER 7

INDUCTANCE	70
Inductive Reactance—Inductor Combinations—Energy and Q—Time Constant—Transformers	

CHAPTER 8

CAPACITANCE	82
Factors Affecting Capacitance—Capacitive Reactance—Series Capacitors—Parallel Capacitors—Charge and Energy—Time Constant	

CHAPTER 9

RESONANCE	94
Series Resonance—Parallel Resonance—Decibels	

CHAPTER 10

BOOK REVIEW QUIZ	105
----------------------------	-----

APPENDIX

DECIMAL EQUIVALENT CHART	109
INDEX	110

SCHEMATIC SYMBOLS

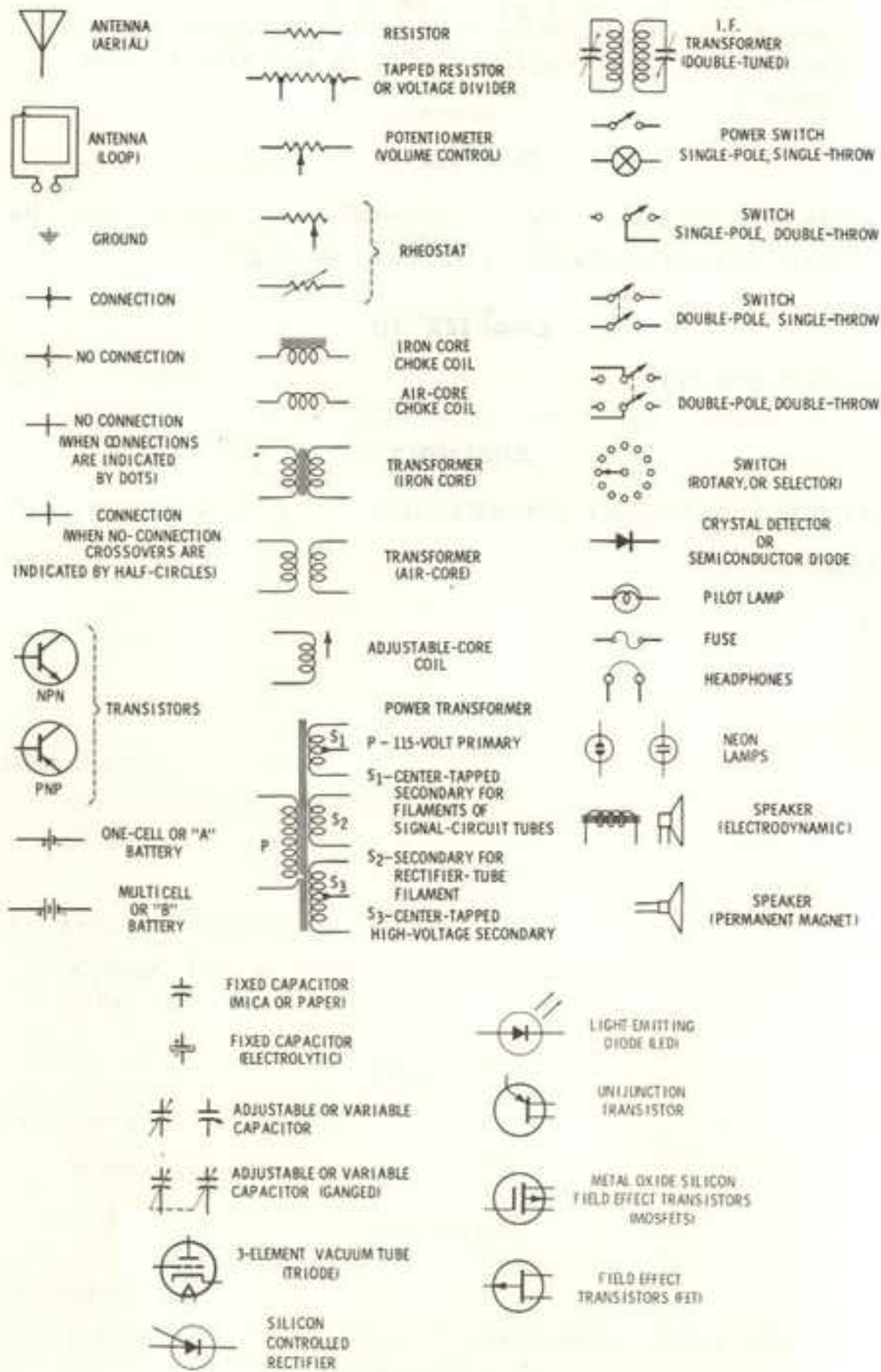

CHAPTER 1

SCIENTIFIC NOTATION

In electronics, numbers in the millions are often used, as well as numbers of less than one—on down to a millionth or less. The complete numbers, expressed in basic units, can be carried straight through an entire problem. But we waste time by doing so, and greatly increase the chance of error. As an example, suppose we had to take 10 megohms times 50 picofarads, to find the time constant of a circuit. The problem would read:

$$10,000,000 \times 0.00000000005 = 0.00050000000$$

Look at all the zeros we have to write, thus increasing the possibility of making mistakes.

In this chapter we will show you a method of abbreviation called "engineer's shorthand," "scientific notation," or more simply, "powers of ten." The last title most aptly describes the process, because all numbers are expressed as powers of ten. This means any number can be expressed as a number between 1 and 10, multiplied by 10 raised to some power. For example:

$$628 = 6.28 \times 10^2$$

$$2,000 = 2 \times 10^3$$

$$3,000,000 = 3 \times 10^6$$

$$0.005 = 5 \times 10^{-3}$$

The power of 10 is the exponent; it tells how many times 10 is used as a factor in multiplying. For example 10^2 indicates 10×10 , or 10 used twice; 10^3 is $10 \times 10 \times 10$, or 10 used three times, etc. Following is a partial list of the powers of ten which occur most often.

$10^0 = 1$	$10^{-1} = 0.1$
$10^1 = 10$	$10^{-2} = 0.01$
$10^2 = 100$	$10^{-3} = 0.001$
$10^3 = 1,000$	$10^{-4} = 0.0001$
$10^4 = 10,000$	$10^{-5} = 0.00001$
$10^5 = 100,000$	$10^{-6} = 0.000001$
$10^6 = 1,000,000$	

The negative powers of 10— 10^{-1} , 10^{-2} , etc.—may require some explanation. Actually, it is difficult to imagine 10 being used minus 2 times as a factor. In fact, anything less than zero has little practical meaning. But we can show that 10 to a negative power has a real-number meaning. There is a rule that states that the numerator and denominator of a fraction can be multiplied or divided by the same number without changing the value of the fraction. Let's use 10^{-1} and multiply by 10^1 .

$$\frac{10^{-1}}{1} \times \frac{10^1}{10^1} = \frac{10^0}{10^1} = \frac{1}{10} = 0.1$$

For the present we will assume that any number to the zero power has a value of 1. In the next chapter we will show why this is true. Using the same method as above we can show the value of 10^{-2} .

$$\frac{10^{-2}}{1} \times \frac{10^2}{10^2} = \frac{10^0}{10^2} = \frac{1}{10^2} = \frac{1}{100} = 0.01$$

There are two rules we can apply in converting numbers to powers of 10.

Rule 1. For a number larger than 1, move the decimal point to the *left* until a number between 1 and 10 results. Then count the number of places the decimal was moved, and use that number as a *positive* power of 10.

Thus:

$$732,000 = 7.32 \times 10^5$$

In this example the decimal point was moved five places to the left to make the number 7.32. To compensate for the change, 7.32 was multiplied by 10^5 to make the two quantities equal.

Rule 2. For a number smaller than 1, move the decimal point to the *right* until a number between 1 and 10 results. Then count the number of places the decimal was moved and use that number as a *negative* power of 10.

Thus:

$$0.00732 = 7.32 \times 10^{-3}$$

In this example the decimal point was moved three places to the right, again resulting in 7.32. To compensate for the change, 7.32 was multiplied by 10^{-3} to make the two quantities equal.

We reverse the process by performing opposite actions. For example:

$$2.4 \times 10^3 = 2,400.$$

The decimal point was moved to the right the number of places indicated by the power of 10. An example of a number less than 1:

$$3.24 \times 10^{-2} = 0.0324.$$

Here the decimal was moved to the left two places, as indicated by the power of 10. We could summarize these actions by saying: A number *larger* than 1 has a *positive* power of 10. A number *smaller* than 1 has a *negative* power of 10. The number 1 itself has a zero power of 10 because $10^0 = 1$. 10^1 is usually written as 10, the power of 1 being understood. It is necessary, however, to include the minus sign in 10^{-1} .

In the examples thus far, we have converted each number to a value between 1 and 10 and then used the proper power of 10. For some problems it may suit our purpose to express a number in a slightly modified form; the next examples show several ways of expressing 254.

$$\begin{array}{lll} 2.54 \times 10^2 & 254 \times 10^0 & 0.0254 \times 10^4 \\ 25.4 \times 10 & 0.254 \times 10^3 & 2,540 \times 10^{-1} \end{array}$$

ADDITION AND SUBTRACTION

To add or subtract numbers expressed as powers of 10, we must first convert all numbers to the same power of 10. Then the numbers can be added (or subtracted) and the same power

retained in the answer. This is illustrated by the next two problems:

$$1. 4.32 \times 10^4 + 6.68 \times 10^3 + 142 \times 10 = ?$$

$$4.32 \times 10^4 = 4.320 \times 10^4$$

$$6.68 \times 10^3 = 0.668 \times 10^4$$

$$142 \times 10 = 0.142 \times 10^4$$

$$\underline{5.130 \times 10^4}$$

$$2. 2.88 \times 10^4 - 0.65 \times 10^3 = ?$$

$$2.88 \times 10^4 = 2.880 \times 10^4$$

$$0.65 \times 10^3 = \underline{-0.065 \times 10^4}$$

$$2.815 \times 10^4$$

Or we could have solved the second problem like this:

$$28.80 \times 10^3$$

$$\underline{-0.65 \times 10^3}$$

$$28.15 \times 10^3$$

which is the same answer obtained in the first solution.

MULTIPLICATION

To obtain the product of numbers expressed as powers of 10, multiply the numbers together and then *add* the exponents of the 10's. For example:

$$4200 \times 300$$

$$= 4.2 \times 10^3 \times 3 \times 10^2$$

$$= 4.2 \times 3 \times 10^3 \times 10^2$$

$$= 12.6 \times 10^5$$

In this example both powers of 10 were positive and so were added. The same rule also holds true when all exponents are negative, as in the next problem:

$$0.036 \times 0.002$$

$$= 3.6 \times 10^{-2} \times 2 \times 10^{-3}$$

$$= 3.6 \times 2 \times 10^{-2} \times 10^{-3}$$

$$= 7.2 \times 10^{-5}$$

If the exponents have different signs, the smaller exponent is subtracted from the larger and the sign of the larger is retained. This is illustrated in the next two problems:

$$360 \times 0.5$$

$$= 3.6 \times 10^2 \times 5 \times 10^{-1}$$

$$= 3.6 \times 5 \times 10^2 \times 10^{-1}$$

$$= 18 \times 10 = 180$$

$$7500 \times 0.0004$$

$$= 7.5 \times 10^3 \times 4 \times 10^{-4}$$

$$= 7.5 \times 4 \times 10^3 \times 10^{-4}$$

$$= 30 \times 10^{-1} = 3.0$$

Multiplication of more than two numbers would be handled in the same way, as illustrated by the next example:

$$650 \times 2300 \times 0.0002$$

$$= 6.5 \times 10^2 \times 2.3 \times 10^3 \times 2 \times 10^{-4}$$

$$= 6.5 \times 2.3 \times 2 \times 10^2 \times 10^3 \times 10^{-4}$$

$$= 29.9 \times 10 = 299$$

DIVISION

To divide numbers involving powers of 10, divide the numbers and then *subtract* the exponent of the divisor from the exponent of the number being divided. Thus:

$$(64 \times 10^5) \div (4 \times 10^3)$$

$$= \frac{64 \times 10^5}{4 \times 10^3}$$

$$= \frac{64 \times 10^5 \times 10^{-3}}{4}$$

$$= \frac{64 \times 10^2}{4}$$

$$= 16 \times 10^2 = 1600$$

Notice that when the 10's are divided, the 10 in the divisor can be moved to the numerator by changing the sign of the exponent.

$$\frac{420,000}{210} = \frac{4.2 \times 10^5}{2.1 \times 10^2}$$

$$= \frac{4.2 \times 10^5 \times 10^{-2}}{2.1}$$

$$= \frac{4.2 \times 10^3}{2.1}$$

$$= 2.0 \times 10^3 = 2000.$$

Both multiplication and division may be found in the same electronics problems. They can be combined and solved as follows:

$$\frac{520 \times 0.0036}{2600} = \frac{5.2 \times 10^2 \times 3.6 \times 10^{-3}}{2.6 \times 10^3}$$

$$= \frac{5.2 \times 3.6 \times 10^2 \times 10^{-3} \times 10^{-3}}{2.6}$$

$$= 7.2 \times 10^{-4} = 0.00072$$

RECIPROCAL

To take the *reciprocal* of a number means to divide that number into 1. For example the reciprocal of 250 is 1/250. An easy way of taking reciprocals with powers of 10 is to state the number with the decimal point just preceding the first significant digit. Then, after the number is divided into 1, the decimal will appear after the first digit. The power of 10 in the answer is the same as in the original problem but has the opposite sign. Two examples are given, using these rules in the solutions:

$$\frac{1}{250} = \frac{1}{.25 \times 10^3} = 4 \times 10^{-3} = .004$$

$$\frac{1}{0.002} = \frac{1}{.2 \times 10^{-2}} = 5 \times 10^2 = 500$$

SQUARES AND SQUARE ROOTS

When squaring a number stated as a power of 10, multiply the number by itself and then *double* the exponent of the 10.

$$(6 \times 10^2)^2 = 36 \times 10^4$$

$$(2.5 \times 10^3)^2 = 6.25 \times 10^6$$

$$(4 \times 10^{-1})^2 = 16 \times 10^{-2}$$

The opposite is done when taking the square root of a number. But first the number should be arranged so that the power of 10 is an even number, either positive or negative. The square root of the number is taken, and the power of 10 is then divided by 2.

$$\sqrt{52.9 \times 10^3} = \sqrt{5.29 \times 10^4} = 2.3 \times 10^2$$

$$\sqrt{6.4 \times 10^{-5}} = \sqrt{64 \times 10^{-6}} = 8 \times 10^{-3}$$

$$\sqrt{144 \times 10^6} = 12 \times 10^3$$

UNITS OF MEASUREMENT

For effective exchange of information in any technical field, we must have units by which we can measure and express various quantities. This is especially true in electronics because so many separate components and circuit characteristics enter into the over-all operation or description of any particular piece of equipment. Especially in the mathematical study of electronics, these units and their uses should be well understood.

Ohm's Law

The units used in Ohm's law probably occur more frequently than any others. So let's define these first.

Volt—The volt is the basic unit of electromotive force, or electrical pressure. One volt is the force necessary to cause a current of one ampere to flow through a resistance of one ohm.

Ampere—The ampere is the practical unit for measuring current. One ampere is the amount of electron flow that results when one volt is applied across a resistance of one ohm. (Actually, the ampere is a rate of flow rather than a quantity, and the number of amperes can be defined as the number of coulombs passing a given point each second.)

Coulomb—The coulomb is the unit for measuring the quantity of electricity, or charge. Numerically, one coulomb is a charge of 6.24×10^{18} electrons, and is the amount delivered by a current of one ampere in one second. Coulombs are used to measure the quantity of flow, and amperes the rate of flow, of electrons through a circuit. Coulombs are also used to express the quantity of charge on a capacitor.

Ohm—The ohm (Ω) is the basic unit of resistance or opposition to electron flow. One ohm is the amount of resistance which will allow a current flow of one ampere when one volt is applied across it.

Mho—The *mho* (ohm spelled backwards) is the unit of conductance, or the ease with which electrons can flow in a circuit. The numbers of mhos is the reciprocal of the circuit resistance. The symbol for conductance is G or g.

Power and Energy

The capacity or ability to do work is called energy. The rate at which the work is done is called power. For energy, the practical unit of measurement is the watt-hour. For power, the practical unit is the watt.

Watt—The practical unit of power. One watt is the dissipation which occurs when one ampere of current is passing through a resistance of one ohm. One watt is also the same as one joule per second.

Joule—The joule is a unit of energy. One joule is the amount of energy (or work) required in maintaining a current of one ampere for one second through a resistance of one ohm. It is also equivalent to one watt-second—3,600 joules (watt-seconds) equal one watt-hour.

Watt-Hour—The watt-hour is the practical unit of electrical energy. The number of watt-hours is calculated by multiplying the number of watts times the hours during which that amount of power is being dissipated. One watt-hour is equal to 3,600 joules.

Horsepower—The horsepower is a practical unit of power. One horsepower (hp) is equal to 746 watts.

Reactive Units

Cycle—An alternating current goes through one complete cycle when it increases from zero to maximum, decreases to zero, increases to maximum in the reverse direction, then decreases to zero again. The number of cycles of AC which occur in one second of time is called the *frequency*, and the basic unit of frequency is the hertz (cycle per second).

Henry—The basic unit of inductance is the henry. One henry is the amount of inductance that will result in an electromotive force of one volt being generated by a change in current rate of one ampere per second. (As voltage is applied to a coil, it opposes the increase of current by generating a counter voltage which is opposite in polarity to the applied voltage.)

Farad—The basic unit of capacitance is the farad, although it is too large to be a practical unit. One farad is the amount of capacitance that will exhibit a potential of one volt across it when it is charged for one second by one ampere of current

flow. A farad can also be defined as the amount of capacitance which will produce a current of one ampere when a change of one volt per second occurs across it.

Units of Length

Various units of length are used in electronics to express wavelength, antenna length, and other physical characteristics of components and devices. Two different systems are used,—the English and the metric—and the electronics technician should be familiar with the primary units of both. Following is a list of length relationships which occur most frequently in basic electronics calculations:

1 mil	= 0.001 inch	1 centimeter	= .3937 inch
12 inches	= 1 foot	1 meter	= 3.28 feet
3 feet	= 1 yard	1 meter	= 39.37 inches
1,760 yards	= 1 mile (statute)	1 kilometer	= 3,280 feet
5,280 feet	= 1 mile (statute)		

For measuring extremely short wavelengths, other units are used. One of these, the *micron*, is equal to 10^{-4} centimeter. The *millimicron* is 0.001 of a micron, or 10^{-7} centimeter. Another similar unit is the *Angstrom unit*, which is equal to 10^{-8} centimeter.

Prefixes

Expression of electronics quantities often involves extremely large or small numbers. We have already seen the number of electrons in a coulomb (6.24×10^{18}). Capacitance in a circuit may be as small as 5×10^{-12} farad. Other quantities of comparable numbers are often used. To express these numbers as powers of ten simplifies the writing, as well as the calculations involving them. But prefixes are also used (prefixes are portions of words used before the names of the units), each separate prefix indicating a certain power of 10. For instance *centi* indicates $0.01(10^{-2})$; therefore, a *centimeter* is 0.01 of a meter. *Kilo* means 1,000 (10^3); so a *kilometer* is 1,000 meters.

Following is a list of prefixes used most frequently in expressing electronics measurements. Each represents a certain

power of 10 (either positive or negative) as indicated. Each prefix also has a symbol which is often used to represent it:

deka (da) = 10^1	deci (d) = 10^{-1}
hekto (h) = 10^2	centi (c) = 10^{-2}
kilo (k) = 10^3	milli (m) = 10^{-3}
mega (M) = 10^6	micro (μ) = 10^{-6}
giga (G) = 10^9	nano (n) = 10^{-9}
tera (T) = 10^{12}	pico (p) = 10^{-12}
	or
	micromicro ($\mu\mu$)

Examples of the use of prefixes in electronic notation, and their numerical equivalents, are illustrated next:

- 1 microfarad = 1×10^{-6} farad = 0.000,001 farad
- 3 kilohertz = 3×10^3 hertz = 3,000 hertz
- 5 picofarads = 5×10^{-12} farad = .000,000,000,005 farad
- 2 nanoseconds = 2×10^{-9} second = .000,000,002 second

Sometimes confusion may arise in using *M* for *mega* and *m* for *milli*. Unless completely understood, it may be advisable to write out the prefix and unit—for example, megahertz or milliamper. Another source of confusion is the use of *m* for micro. In this case, when denoting capacity, common usage has determined it to mean *micro*. By the same token, when used with amperes it is understood to mean *milli*.

In some calculations it is necessary to convert from one prefix to another. This involves moving the decimal point a certain number of places. Figure 1-1 is useful for this purpose. Notice that the calibration is reversed from our usual method of counting. The numbers are progressively smaller as we move toward the right. For instance, to convert 0.05 μ F to pF, we start at micro (10^{-6}) and move to pico (10^{-12}), a move of six places to the right—to a smaller unit. The decimal point, therefore, would be moved six places to the right, so that



Figure 1-1. Relative values of multiple and submultiple prefixes.

0.05 μ F would become 50,000 pF. When a *quantity* is expressed in smaller units, the *number* of these units becomes greater.

Using the chart, convert 3,000 kHz to MHz as follows: Moving from kilo to mega, move 3 units to the left. Hence, 3,000 kHz becomes 3 MHz (after the decimal point has been moved to the left). Without the chart, the conversions are made by using powers of 10. For example, 3,000 kHz is $3,000 \times 10^3$ Hz. Since a megacycle is 10^6 we can change the 10^3 to 10^6 , but the decimal point must be moved three places to the left (to compensate for the changed power of 10). To change 0.05 μ F to pF, we change the power of 10 from 10^{-6} to the smaller 10^{-12} . To compensate, the 0.05 is changed to 50,000, a larger number.

In a few cases a combination of prefixes may be used. Kilo-megahertz (10^9) is used in connection with super high frequencies.

BASIC ALGEBRA

In a sense, algebra can be considered as arithmetic expressed on a general rather than specific basis. For example, 2 amps multiplied by 3 ohms equals 6 volts. This is Ohm's law expressed in terms of those specific values. If we say that $E = I \times R$, we are using an algebraic expression to give the relationship of voltage, current, and resistance for all values. Electronics formulas are algebraic expressions showing how some value varies with respect to others. Thus, our prime concern in studying algebra is to be able to manipulate these formulas in such a way that we can solve for any circuit characteristic.

Algebra is different from arithmetic in two ways. First, algebra can include negative numbers, a concept usually not considered in arithmetic. Second, algebra makes use of *literal numbers* (letters) in place of actual numerical values, although numbers can also be used. The use of literal numbers limits what can be done in a given problem; hence most algebraic expressions are more involved than their arithmetical counterparts. We can say that 2 plus 3 equals 5, combining the separate numbers. But we cannot combine a and b unless we know the specific value of each.

NEGATIVE NUMBERS

In arithmetic we normally use zero to indicate a complete lack of whatever we are numbering. If we have zero dollars, we have no dollars. And, in a practical sense, it is difficult to imagine having less than zero of anything. But if we consider zero as merely a reference point on a number scale, we can go in either direction from that reference. Voltage measurements illustrate our point. If we call chassis ground zero volts, we can have either a positive or a negative potential with respect to that reference. A reading of -10 volts does

not indicate "less than nothing"; it only indicates that the potential is 10 volts negative with respect to whatever we are calling zero.

Temperature measurements also illustrate this point; a reading of zero or below does not mean there is no temperature. The measurements are taken with respect to what has been arbitrarily set up as zero on the temperature scale, and negative readings are opposite in direction from positive readings. Thus, the use of positive and negative numbers gives us a mathematical means of expressing direction as well as quantity in our electronics calculations. We have already used positive and negative voltages as one example. Phasing in AC circuits, and measurement of sound levels, also make use of these ideas.

Direction is illustrated by Figure 2-1, which is a numbered scale extending from zero in both directions. On the scale, $+2$ and -2 are both separated from zero by the same amount, but in different directions. However, $+2$ and -2 are 4 units apart on the number scale. The *absolute value* of a number is its

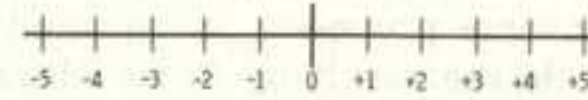

Figure 2-1. Scale showing both the positive and the negative direction from a zero point.

value, neglecting the sign; both $+2$ and -2 have absolute values of 2.

In algebra, a negative number is noted by placing a negative sign in front of the number; for example -2 , $-3a$, $-4x^3$, etc. In combining numbers, the signs must be considered part of the operation, as evidenced by the four examples listed below:

$$4 + 3 = 7$$

$$4 - 3 = 1$$

$$3 - 4 = -1$$

$$-3 - 4 = -7$$

The positive sign indicates that the quantity is added; the negative sign, that it must be subtracted. When numbers are added the result is called the *sum*. When subtraction is performed the result is the *difference*.

We also use other signs of operation. If we wish to indicate that a and b are multiplied together, it can be shown as $a \times b$, $a \cdot b$, or simply ab —all three methods signifying multiplication. When negative numbers are involved, parentheses are used to show multiplication, $(-3)(-2)$ for example. Otherwise this might be read as $-3-2$, or -5 . In expressing arithmetic numbers, all of these methods are valid except one. The symbols 2×3 , $2 \cdot 3$, $(2)(3)$ would all express multiplication of 2 times 3, but 23 would be read as twenty-three. With literal numbers, though, the latter method is all right, as with ab . Similarly $2\frac{1}{2}$ is usually considered to be $2 + \frac{1}{2}$ rather than 2 times $\frac{1}{2}$. The result obtained when numbers are multiplied is called the *product*.

Dividing a by b can be shown by $a \div b$ or a/b , the latter being used almost exclusively in algebraic operations. Thus in these examples,

$$\frac{a}{b}, \frac{2}{3}, \frac{2x^3}{5}, \frac{3}{a}$$

the numerator is divided by the denominator. Multiplication and division are inverse processes. If we multiply a number by 3 and then divide the result by 3, we obtain the original number. Multiplying a number by $\frac{1}{3}$ is the same as dividing by 3, so that $a/3$ is the same as $a \times \frac{1}{3}$. The result of dividing one expression by another is called the *quotient*.

Zero can be added, subtracted, or multiplied. But we cannot divide by zero because the answer would have no meaning. We can divide into zero; as an example, $0/3$ is still zero. Any number multiplied by zero produces a product of zero.

TERMINOLOGY

Arithmetic uses only *constants*—that is, numbers which have specific, unchanging values. For example, 5 always has a value of 5. Algebra uses constants, but it also uses *variables*. Consider the formula for inductive reactance, $X_L = 2\pi fL$. 2π has the same value (6.28) in every problem, so it is a constant. But f and L may be assigned any values, which makes the value of X_L dependent upon them. These are variables because their values vary from problem to problem. In any given instance, however, each variable will have a specific value.

An *algebraic expression* is a mathematical statement including both literal and arithmetic numbers grouped according to algebraic standards. Some examples are:

$$x + y, 2a - b, xy, -3a/b \text{ and } x^2 + y^2.$$

A *term* is a number, or the product or quotient of several numbers. Examples are $3a$, b , xy , a/b , etc. In the expression $2a + b$, there are two terms, $2a$ and b ; and in any expression of two or more terms, each term is separated from its adjacent terms by either a plus or minus sign.

Terms which contain the same letters are called *like terms* or *similar terms* (for example, $2a$ and $-3a$, x^2 and $2x^2$, $2ab$ and $3ab$, etc.). *Unlike terms* have different literal numbers; $2a$ and $3b$ are unlike terms. An expression containing only one term is called a *monomial*. A two-term expression is a *binomial*, and one including three terms is a *trinomial*. The word *polynomial* is often used to describe an expression which contains two or more terms.

An algebraic term consists of several parts—namely the *base*, the *coefficient*, and the *exponent*. In the term $3x^2$, x is the base, 3 is the coefficient, and 2 is the exponent. The x^2 indicates that x is used as a factor twice, or x times x . The coefficient tells us how many of these x^2 terms we have. Actually, 3 is the coefficient of x^2 , and x^2 is the coefficient of 3. But popular usage describes the number as the coefficient—3 in this case.

Whenever the number in front of the letter is omitted, the coefficient is assumed to be 1. The term x actually means $1x$, and ab means $1ab$. Similarly, omission of the exponent also indicates 1. The term a actually means $1a^1$, the ones being implied.

Coefficients, bases, and exponents can be either literal or arithmetic numbers. In ab^c all three components are literal. In $3x^2$ only the base is literal. The term *base* sometimes indicates the combination of base and exponent, but this should cause no difficulty.

When numbers are multiplied together to give a product, each of the numbers is called a *factor*. In $2 \times 3 \times 4 = 24$, the 2, 3, and 4 are factors and the product is 24. Similarly a , b , and c are factors of abc , and each factor can be considered the coefficient of all the other factors.

COMBINING TERMS

Addition and Subtraction

Algebraic terms can be added or subtracted as long as their bases (including the exponents) are the same. For instance, $2a + 3a = 5a$. Here the numerical coefficients are combined. The base remains the same, the reason for which can be seen from a simple analogy. If we add 2 tubes and 3 tubes, the sum is 5 tubes. Similarly, adding a 's in the first example produces the result of $5a$.

In combining terms the signs must be considered, as indicated by the following examples:

1. $5x - 2x = 3x$
2. $-2A - 3A = -5A$
3. $3y^2 - 7y^2 = -4y^2$
4. $3b^3 + 2b^3 = 5b^3$
5. $-ab + 2ab = ab$

When the signs are alike, add the numerical quantities and affix the same sign. When the signs are different, subtract the smaller number from the larger and use the sign of the larger, as in examples 1, 3, and 5 above.

Terms with unlike bases (or exponents) cannot be combined algebraically. For example:

$$\begin{aligned}3a + 2b &= 3a + 2b \\4x^2 - 3x &= 4x^2 - 3x \\2a^2b + 3ab^2 &= 2a^2b + 3ab^2\end{aligned}$$

An analogy of this would be the attempt to add 3 resistors and 2 capacitors. The combined result is still 3 resistors and 2 capacitors.

Using the same rules, expressions involving more than two like terms can be combined. Add all the positive terms together, and then all the negatives. Finally, combine by the rules given previously. As an example:

$$4a - 2a + a - 3a - a = +5a - 6a = -a$$

If two or more bases are involved, the terms with like bases are combined as previously shown. The combined result con-

tains as many terms as there are different bases, unless a coefficient turns out to be zero. An example of this type is:

$$a - 2b - 2a + 3b - 4c = -a + b - 4c$$

Multiplication and Division

When multiplying algebraic terms, the sign, coefficient, and exponent of the various terms must all be considered. The product of two terms having like signs, either positive or negative, is always positive.

$$3 \times 4 = +12; (-2)(-3) = +6$$

Parentheses are used in the latter example in order not to confuse the problem with $-2 - 3$, an addition problem. When the multiplied terms have unlike signs the product is always negative.

$$(2)(-3) = -6, \text{ and } (-4)(3) = -12$$

The exponent of a product is the *sum* of all exponents of the factors having like bases:

$$\begin{aligned}x \cdot x^2 \cdot x^3 &= x^6 \\a^2 \cdot b^3 \cdot a \cdot b &= a^3b^4\end{aligned}$$

The coefficient of the product is the value of all separate coefficients multiplied together, as in the following examples:

$$\begin{aligned}(a)(3a) &= 3a^2 \\(2a)(3b) &= 6ab \\(\frac{1}{2}x)(3y) &= \frac{3}{2}xy\end{aligned}$$

Notice that all coefficients are multiplied, even when the separate factors have unlike bases.

In raising a number to a power, the coefficient is raised to that power and the exponents are *multiplied* by the order of the power:

$$\begin{aligned}(2x)^2 &= 4x^2 & (3a^2x)^3 &= 27a^6x^3 \\(-3ab^2)^2 &= 9a^2b^4 & (-2a)^3 &= -8a^3\end{aligned}$$

Taking the root of an expression involves the opposite operation from raising a number to a power. Take the indicated

root of the coefficient; then *divide* the exponent by the order of the root. This is illustrated in the next four examples:

$$\sqrt{2x^2} = 1.414x$$

$$\sqrt{16a^2b^4} = 4ab^2$$

$$\sqrt[3]{8x^6} = 2x^2$$

$$\sqrt[3]{-27a^3} = -3a$$

When multiplied by an expression having two or more terms, a monomial is multiplied by each of the other terms separately as in:

$$2a(3a-4b) = 6a^2-8ab$$

and:

$$-3a(a^2 + 2b - 4c) = -3a^3 - 6ab + 12ac$$

If the monomial factor is positive, the signs of the terms in the product will be the same as those within the parentheses. If the monomial is negative, as in the second example, then all signs change. Placing parentheses around the binomial indicates that the entire quantity within the parentheses is multiplied by the monomial. For example, $2a(3a-4b) = 6a^2-8ab$. But $2a \cdot 3a - 4b = 6a^2-4b$. Using the parentheses changes the problem in such cases.

A binomial can be multiplied by another binomial in any of several ways. Two are illustrated, both multiplying $(2a+b)$ and $(3a-2b)$. The first method has the entire problem set up on the same line, and the separate multiplications are all made as indicated below. Then the like terms are combined, in this case $-4ab$ and $+3ab$:

$$\begin{array}{l} (2a+b)(3a-2b) \\ 6a^2-4ab+3ab-2b^2 = 6a^2-ab-2b^2 \end{array}$$

Or we can solve the problem in much the same way as in arithmetical multiplication:

$$\begin{array}{r} 2a + b \\ 3a - 2b \\ \hline 6a^2 + 3ab \\ - 4ab - 2b^2 \\ \hline 6a^2 - ab - 2b^2 \end{array}$$

The latter method is probably easier for expressions involving more than two terms. For instance, multiplying

$3a^2-2ab+b^2$ by $a-b$, the problem would be set down in this manner:

$$\begin{array}{r} 3a^2-2ab+b^2 \\ a-b \\ \hline 3a^3-2a^2b+ab^2 \\ -3a^2b+2ab^2-b^3 \\ \hline 3a^3-5a^2b+3ab^2-b^3 \end{array}$$

Notice that all terms in the trinomial are first multiplied by a , giving $3a^3-2a^2b+ab^2$. Then each of the three terms is multiplied by $-b$, the terms with like bases being placed under those in the first step. Finally the two are added.

In some electronics equations a binomial quantity must be squared by one of the methods just illustrated. However, a special formula that can be applied to squaring a binomial is expressed as follows:

$$(a+b)^2 = a^2+2ab+b^2$$

There are three terms in the product. The first is equal to the *square* of the first term of the binomial. The second term is *twice the product* of the two original terms, and the third term is the *square* of the second term of the binomial. The numerical coefficients follow the same rules. For example:

$$\begin{array}{l} (2x+y)^2 = 4x^2+4xy+y^2 \\ (3a+4b)^2 = 9a^2+24ab+16b^2 \end{array}$$

Dividing algebraic expressions also involves the signs, exponents, and coefficients, and they must all be considered in order to arrive at the correct quotient. As to signs, the same rules apply as for multiplication. When the numbers to be divided have like signs, the quotient is positive. When the signs are opposite, the quotient is negative:

$$\frac{6}{3} = +2 \quad \frac{-6}{3} = -2 \quad \frac{6}{-3} = -2 \quad \frac{-6}{-3} = +2$$

The exponent of the quotient is obtained by *subtracting* the exponent of the divisor from the exponent of the number being divided, assuming like bases. This is shown in the following:

$$\frac{x^3}{x^2} = x \quad \frac{x^2}{x^4} = x^{-2} \quad \frac{a^3}{a^3} = a^0$$

Notice that a negative or zero exponent can appear in a quotient. A term having a *negative* exponent is equal to the reciprocal of that term with a *positive* exponent of the same numerical value:

$$x^{-2} = \frac{1}{x^2} \quad \frac{1}{x^{-3}} = x^3$$

This can be verified by multiplying numerator and denominator by the same term with a positive exponent, as follows:

$$\frac{x^{-2}}{1} \cdot \frac{x^2}{x^2} = \frac{x^0}{x^2} = \frac{1}{x^2}$$

and:

$$\frac{1}{x^{-3}} \cdot \frac{x^3}{x^3} = \frac{x^3}{x^0} = x^3$$

Any number, arithmetical or literal, raised to the zero power has a numerical value of 1. This can be shown by assuming that any quantity divided by the same quantity has a value of 1:

$$\frac{x^2}{x^2} = x^{2-2} = x^0 = 1$$

$$\frac{10^3}{10^3} = 10^{3-3} = 10^0 = 1$$

Thus we can assume that any expression raised to the zero power is equal to 1.

The numerical coefficient of a quotient is found by dividing the numerical coefficient in the numerator by the one in the denominator.

$$\frac{6a^2}{2a} = 3a \quad \frac{-8x^3}{2x} = -4x^2 \quad \frac{-12a}{-3b} = +\frac{4a}{b}$$

Division involving polynomials can be performed by long division just as in arithmetic. Each part of the problem must

be arranged so that its terms are in ascending or descending powers of some literal number. An example follows:

$$\begin{array}{r} 2a^2-3ab+3b^2 \\ a+2b \overline{) 2a^3+a^2b-3ab^2+b^3} \\ \underline{2a^3+4a^2b} \\ -3a^2b-3ab^2 \\ \underline{-3a^2b-6ab^2} \\ 3ab^2+b^3 \\ \underline{3ab^2+6b^3} \\ -5b^3 \text{ is the remainder.} \end{array}$$

a (of the expression $a+2b$) will divide into $2a^3$ (of the expression $2a^3+a^2b-3ab^2+b^3$) $2a^2$ times ($\frac{2a^3}{a} = 2a^2$). As in regular long division, this answer is placed over the term $2a^3$ and the divisor $a+2b$ is multiplied by it. This equals $2a^3+4ab^2$, which is placed under the first two terms and subtracted from them. a^2b-4a^2b equals $-3a^2b$. Bringing down the third term in the expression gives $-3a^2b-3ab^2$. a can be divided into $(-3a^2b)$, $-3ab$ times. The result is placed at the top as part of the answer and is multiplied by $a+2b$. This gives $-3a^2b-6ab^2$, which is placed under like terms and subtracted. $-3ab^2-(-6ab^2)$ equals $+3ab^2$. Bringing down the last term we now have $3ab^2+b^3$. a divided into the first term of this expression equals $3b^2$. This is placed with the answer as the final term and multiplied by $a+2b$ to give $3ab^2+6b^3$. Placing under like terms and subtracting, we have a remainder of $-5b^3$.

If the two expressions are exactly divisible, there will be no remainder, as shown in the next problem:

$$\begin{array}{r} a+b \\ a-b \overline{) a^2 -b^2} \\ \underline{a^2-ab} \\ +ab-b^2 \\ \underline{+ab-b^2} \\ 0 \end{array}$$

Notice that there is no term containing ab in the dividend, so a zero is substituted. Therefore, when subtracting, change the sign of the subtrahend and add. Changing $-ab$ to $+ab$ and adding it to 0 is equal to $+ab$.

FACTORING

In some instances it is desirable to break down a mathematical expression into its various fundamental elements—that is, to obtain the basic elements which, when multiplied together, give the original expression. This is called *factoring*. As an example, the number 75 can be factored into $5 \times 5 \times 3$, the lowest whole numbers (omitting 1) which will give a product of 75 when multiplied. Other examples are:

$$\begin{aligned}48 &= 2 \times 2 \times 2 \times 2 \times 3 \\210 &= 2 \times 3 \times 5 \times 7 \\102 &= 2 \times 3 \times 17\end{aligned}$$

Numerous factoring forms are used for algebraic quantities, but we will consider only the one used to any extent in basic electronics formulas. This method is referred to as removing a monomial factor. An example is given here:

$$ac + ab = a(c + b)$$

A factor can be removed from the expression only if it appears as a factor in each term. $ab + ac + bd$ is not factorable, since no one factor appears in all three terms. Numbers can also be factored if they are factors of each term, such as the following:

$$\begin{aligned}2xy + 2xz &= 2x(y + z) \\3a^2b - 6a^2c &= 3a^2(b - 2c) \\-15ab - 5a^2b &= -5ab(3 + a)\end{aligned}$$

This form of factoring will be used to a limited extent in some of the calculations in later chapters. Each factoring problem can be checked by multiplication. In the first example, multiplying out $2x(y+z)$, gives a product of $2xy+2xz$, the original quantity.

EQUATIONS

An equation is a mathematical statement that two expressions are equal to each other. $3+2=5$ is an equation, but not of the type we have in mind. Electronics equations (often called formulas) are stated in terms of literal and arithmetical

numbers giving the relationships between them. $E = IR$ is an equation; so is $X_L = 2\pi fL$. Most of the time we are interested in solving the equation—that is, finding the values of the literal numbers which make the equation hold true.

In the formula, $X_L = 2\pi fL$, if we are given the values of frequency and inductance, we can multiply them together, and then multiply by 2π to obtain the value of X_L (inductive reactance). Suppose, however, that frequency and inductive reactance are given and we must solve for inductance. Then the equation must be solved for L .

A large portion of practical mathematics consists of working with equations in order to solve for one of the component parts of the equation. The ideas illustrated here will be necessary tools in most of the remaining chapters. In this chapter we are using simple literal numbers such as a , x , etc., but in actual electronics equations, literal factors often use subscripts (as R_1 , R_2 , etc.) to distinguish between various components. Subscripts are numbers or letters written under and slightly to the right of the symbol. They play no mathematical part in the solution of the equation, as do exponents, but are used solely for identification. Even though the literal parts may be identical (R_1 and R_2 for example), they are not like terms.

There is one basic rule in working with equations—you must do nothing to destroy the equality existing between the two sides. Simply stated, **whatever is done to one side of an equation must also be done to the other side**. Consider the equation $3x-3 = x+1$. There is only one value of x which will make this statement true. Solving the equation consists of determining this value mathematically. In order to do this we must isolate x on one side of the equation and the numerical value on the other. Our manipulations are of several types, but we must always do the same to both sides of the equation. We can perform virtually any mathematical operation except dividing by zero—which is never possible anyway.

Let's solve the equation previously given:

$$3x-3 = x+1$$

If we subtract x from both sides we obtain:

$$3x-3-x = x+1-x$$

Collecting terms:

$$2x - 3 = 1$$

Then we add 3 to both sides and again collect terms:

$$\begin{aligned} 2x - 3 + 3 &= 1 + 3 \\ 2x &= 4 \end{aligned}$$

Dividing both sides by 2, we obtain:

$$x = 2$$

This should be the solution for our equation, but let's check it by substituting 2 for x in the original:

$$\begin{aligned} 3x - 3 &= x + 1 \\ 3(2) - 3 &= 2 + 1 \\ 6 - 3 &= 3 \\ 3 &= 3 \end{aligned}$$

Since the two sides are equal, our solution must be correct.

This is the general idea for solving almost any type of equation, except that additional steps sometimes must be included in the process. Keep in mind that nothing should be done which will disturb the equality of the equation. We can add a quantity to or subtract it from both sides. We can multiply or divide both sides by some quantity. We can raise both sides to some power, or take a root of both sides. Always remember, the same operation must be performed on both sides.

Literal Equations

Most electronics formulas contain more than one unknown. These are often called *literal equations*, and they may or may not contain constant terms. The X_L formula and Ohm's law previously given are examples of literal equations. In solving this type the rules already given are followed. Instead of a definite numerical answer, however, the solution also contains literal terms or factors. Let's solve one to see what we mean. Solve for x in this problem:

$$ax - b = c$$

Add b to both sides:

$$\begin{aligned} ax - b + b &= c + b \\ ax &= c + b \end{aligned}$$

Divide both sides by a :

$$\begin{aligned} \frac{ax}{a} &= \frac{c + b}{a} \\ x &= \frac{c + b}{a} \end{aligned}$$

Literal equations, in which the wanted factor appears in more than one term, pose an additional problem not encountered previously in this chapter. Let's try one to illustrate the point, solving for a :

$$ac - bc = ad$$

Collect all the terms containing a on one side by subtracting ad and adding bc to both sides:

$$\begin{aligned} ac - bc - ad + bc &= ad - ad + bc \\ ac - ad &= bc \end{aligned}$$

Then we factor a out of the left side:

$$a(c - d) = bc$$

Next we divide both sides of the equation by $(c - d)$, the coefficient of a :

$$\begin{aligned} \frac{a(c - d)}{c - d} &= \frac{bc}{c - d} \\ a &= \frac{bc}{c - d} \end{aligned}$$

Fractional Equations

In general, whenever an equation contains one or more fractions, the solution is simplified if we rid the equation of the fractions. The following equation illustrates the procedure:

$$\frac{x}{3} - 1 = 2x + 4$$

To eliminate the denominator, multiply both sides of the equation by 3, making sure to multiply every term:

$$\begin{aligned} \frac{3x}{3} - 3 &= 6x + 12 \\ x - 3 &= 6x + 12 \end{aligned}$$

Collecting terms:

$$-5x = 15$$

Multiplying both sides by -1 , we obtain:

$$5x = -15$$

Then dividing by 5 we get the solution:

$$x = -3$$

This answer can be proven as shown:

Substituting -3 for x in $\frac{x}{3} - 1 = 2x + 4$

$$\begin{aligned}\frac{-3}{3} - 1 &= 2(-3) + 4 \\ -1 - 1 &= -6 + 4 \\ -2 &= -2\end{aligned}$$

If several denominators occur in the same equation, it is usually advisable to find the least common denominator (*LCD*) and use it for the entire equation. From that point the solution follows the same pattern as in the previous equation. Let's try one of this type:

$$\frac{x}{2} + 3 = \frac{x}{3} - 2$$

The *LCD* of 2 and 3 is 6. So the entire equation is set over a denominator of 6:

$$\frac{3x + 18}{6} = \frac{2x - 12}{6}$$

If both sides are then multiplied by 6, the problem is no longer fractional, but can be expressed in straight-line form:

$$3x + 18 = 2x - 12$$

Collecting terms:

$$x = -30$$

Which is proven as follows:

$$\begin{aligned}\frac{x}{2} + 3 &= \frac{x}{3} - 2 \\ \frac{-30}{2} + 3 &= \frac{-30}{3} - 2 \\ -15 + 3 &= -10 - 2 \\ -12 &= -12\end{aligned}$$

Equations With Radicals

Many calculations in electronics include either the square or square root of one or more quantities. For example, power equals the square of the current multiplied by the resistance ($P = I^2R$). In this equation we must express the wanted factor with an exponent of 1. For example:

$$2x^2 = 50$$

If we divide both sides by 2 the result is:

$$x^2 = 25$$

Taking the square root of both sides we find:

$$x = 5$$

Actually, $\sqrt{25}$ is either plus or minus 5, because either one squared gives a product of 25. In practical problems, however, the negative may have no practical meaning. Hence we use the positive value, which is known as the *principal root*.

The following equation has a square root in the original problem:

$$\sqrt{3R} = 6$$

If we are to solve for R , then we must eliminate the radical. This is done by squaring both sides:

$$3R = 36$$

Or:

$$R = 12$$

OHM'S LAW

In all probability, the formula used most often in electronics calculations is Ohm's law, which expresses the relationship of voltage, current, and resistance in electrical circuits. It can be expressed in any of the three forms shown below:

$$E = IR$$

$$I = \frac{E}{R}$$

$$R = \frac{E}{I}$$

All three of these circuit characteristics are expressed in basic units—volts, amperes, and ohms.

SERIES CIRCUITS

Ohm's law holds true for the entire circuit or for individual portions of a circuit. Let's refer to Figure 3-1, to illustrate this.

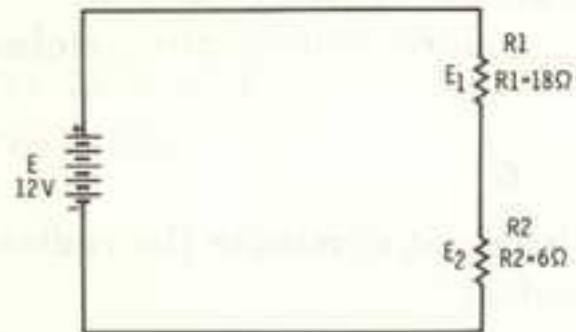

Figure 3-1. Series-connected resistances illustrating Ohm's-law calculations.

The total resistance in the circuit is $18 + 6$, or 24 ohms. Circuit current is:

$$I = \frac{E}{R}$$

$$= \frac{12}{24}$$

$$= 0.5 \text{ ampere}$$

Multiplying current by resistance gives voltage, as shown in the next calculation:

$$\begin{aligned} E &= IR \\ &= 0.5 \times 24 \\ &= 12 \text{ volts} \end{aligned}$$

If we calculate the voltage drop across each resistor, their sum should equal the applied voltage. In the diagram, E_1 is the voltage drop across R_1 , and E_2 is the drop across R_2 . Therefore:

$$\begin{aligned} E_1 &= I \times R_1 \\ &= 0.5 \times 18 \\ &= 9 \text{ volts} \end{aligned}$$

$$\begin{aligned} E_2 &= I \times R_2 \\ &= 0.5 \times 6 \\ &= 3 \text{ volts} \end{aligned}$$

and:

$$\begin{aligned} E &= 9 + 3 \\ &= 12 \text{ volts} \end{aligned}$$

PARALLEL CIRCUITS

Ohm's law also holds for parallel circuits like that of Figure 3-2. The total resistance in the circuit is:

$$\begin{aligned} R_t &= \frac{R_1 \times R_2}{R_1 + R_2} \\ &= \frac{36 \times 12}{36 + 12} \\ &= \frac{432}{48} \\ &= 9 \text{ ohms} \end{aligned}$$

Figure 3-2. Parallel resistances illustrating Ohm's-law calculations.

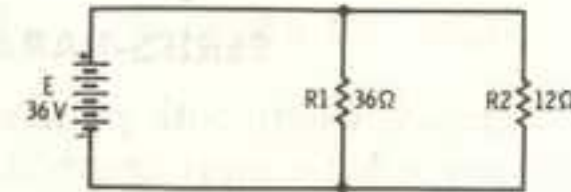

I_1 is the current through R_1 , and I_2 is the current through R_2 :

$$\begin{aligned} I_1 &= \frac{E}{R_1} \\ &= \frac{36}{36} \\ &= 1 \text{ ampere} \end{aligned}$$

$$\begin{aligned} I_2 &= \frac{E}{R_2} \\ &= \frac{36}{12} \\ &= 3 \text{ amperes} \end{aligned}$$

$$\begin{aligned} I_t &= 1 + 3 \\ &= 4 \text{ amperes} \end{aligned}$$

We can check this by multiplying the total current and total resistance, the latter being 9 ohms:

$$\begin{aligned} E &= I_t \times R_t \\ &= 4 \times 9 \\ &= 36 \text{ volts} \end{aligned}$$

Several basic facts can help us in Ohm's-law calculations:

1. In a series circuit, the current is the same through all parts of the circuit. The individual voltage drops add up to the applied voltage.
2. In a parallel circuit, the voltage is the same across all components. The current through the individual components may be different, but the sum of these currents equals the total.
3. Current in a circuit is directly proportional to the applied voltage, and inversely proportional to the resistance. As circuit resistance is increased, the current is decreased and vice versa.
4. The voltage drop across an individual circuit component is directly proportional to both current and resistance. As either or both are increased, the voltage drop also increases and vice versa.

SERIES-PARALLEL CIRCUITS

Circuits where both parallel and series resistances are present are a little more complicated, but the same basic method

is used for solution. Let's put these ideas to use in solving several problems.

1. Solve for the applied voltage (E) of the combination circuit shown in Figure 3-3.

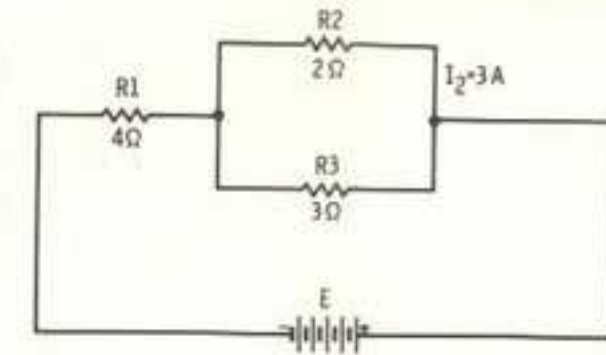

Figure 3-3. Series-parallel resistance combination illustrating Ohm's-law calculations.

By remembering that the voltage drops across parallel resistors are the same, we can solve for total circuit current. The voltage across R_2 is:

$$\begin{aligned} E_{R_2} &= I_2 \times R_2 \\ &= 3 \times 2 \\ &= 6 \text{ volts} \end{aligned}$$

The current through R_3 is found by dividing resistance into the voltage drop:

$$\begin{aligned} I_3 &= \frac{E_{R_3}}{R_3} \\ &= \frac{6}{3} \\ &= 2 \text{ amperes} \end{aligned}$$

The current through R_1 is 5 amps, being the total of I_2 and I_3 . Voltage across R_1 is:

$$\begin{aligned} E_{R_1} &= I_1 \times R_1 \\ &= 5 \times 4 \\ &= 20 \text{ volts} \end{aligned}$$

The applied voltage, then, is the sum of the two separate voltages:

$$\begin{aligned} E_t &= 6 + 20 \\ &= 26 \text{ volts} \end{aligned}$$

2. With 200 volts applied, the current through a resistor is 2 amperes. What is the current if the resistance is doubled?

As long as current and resistance are inversely proportional, we could set up a formula where I_1 is the original current and I_2 the final current. The original resistance (R_1), by Ohm's law, is 100 ohms:

$$\begin{aligned} \frac{I_1}{I_2} &= \frac{R_2}{R_1} \\ I_2 R_2 &= I_1 R_1 \\ I_2 &= \frac{I_1 R_1}{R_2} \\ &= \frac{2 \times 100}{200} \\ &= 1 \text{ ampere} \end{aligned}$$

We could also reason out the answer by assuming that when the resistance is doubled, the current is halved. Therefore the current drops from 2 amps to 1 amp.

3. How is the current of a circuit affected if the voltage is doubled and the resistance halved? By reasoning the problem in two separate steps, we find that the current is quadrupled. If the voltage is doubled, the current is also doubled. Then halving the resistance doubles the current again.

As we shall see in later chapters, Ohm's law can also be used for calculations in circuits containing AC as well as DC. For AC, however, inductance and capacitance may enter into our problem, Ohm's law will still apply, however, since it states the basic relationships between voltage, current, and circuit opposition to electron flow.

In the last chapter, conductance was determined by $G = \frac{1}{R}$.

One form of Ohm's law states:

$$R = \frac{E}{I}$$

so,

$$\frac{1}{R} = \frac{I}{E}$$

therefore

$$G = \frac{I}{E}$$

POWER

The power in a circuit is measured in watts and can be calculated from three different formulas, all based on Ohm's law. The first of these is:

$$P = E \times I$$

where,

P is the power in watts,
 E is the voltage in volts,
 I is the current in amperes.

By making Ohm's-law substitutions, we can obtain the other two forms:

Substituting IR for E :

$$\begin{aligned} P &= IR \times I \\ &= I^2 R \end{aligned}$$

Or substituting $\frac{E}{R}$ for I :

$$\begin{aligned} P &= E \times \frac{E}{R} \\ &= \frac{E^2}{R} \end{aligned}$$

The formula for solving a given problem depends on what was given originally in the problem. For example, if current and resistance were given, then $P = I^2 R$ is the logical formula to use. These formulas can be used for calculating the power in an entire circuit or in individual components. Several problems will illustrate how.

1. In the circuit of Figure 3-1 the total power dissipated can be calculated from any one of the three formulas. Voltage is 12 volts, resistance 24 ohms, and current 0.5 ampere.

$$\begin{aligned} P_t &= E \times I \\ &= 12 \times 0.5 \\ &= 6 \text{ watts} \end{aligned}$$

Or:

$$\begin{aligned}
 P_1 &= I^2 \times R \\
 &= 0.5^2 \times 24 \\
 &= 0.25 \times 24 \\
 &= 6 \text{ watts}
 \end{aligned}$$

Or:

$$\begin{aligned}
 P_1 &= \frac{E^2}{R} \\
 &= \frac{12^2}{24} \\
 &= \frac{144}{24} \\
 &= 6 \text{ watts}
 \end{aligned}$$

Power dissipated by R_2 is:

$$\begin{aligned}
 P_2 &= I^2 \times R_2 \\
 &= 0.5^2 \times 18 \\
 &= 4.5 \text{ watts}
 \end{aligned}$$

And in R^2 :

$$\begin{aligned}
 P_2 &= I^2 \times R_2 \\
 &= 0.5^2 \times 6 \\
 &= 1.5 \text{ watts}
 \end{aligned}$$

The total power is the sum of the two individual powers, $4.5 + 1.5 = 6$ watts.

2. What is the total power dissipation in a circuit (Figure 3-4A) composed of a 50-ohm, 10-watt resistor connected in series with a 100-ohm, 10-watt resistor, if the latter is dissipating 10 watts?

The 10-watt ratings mean that each resistor can safely dissipate 10 watts and presumably no more. But don't jump to conclusions—the answer is not 20 watts. As long as the resistors are in series, the current through them is the same. The power dissipation is directly proportional to the resistance; so if the 100-ohm resistor is dissipating 10 watts, the 50-ohm resistor will be dissipating 5 watts, for a total of 15 watts. This is the maximum, above which the 100-ohm resistor will burn out. If both resistors had the same resistance

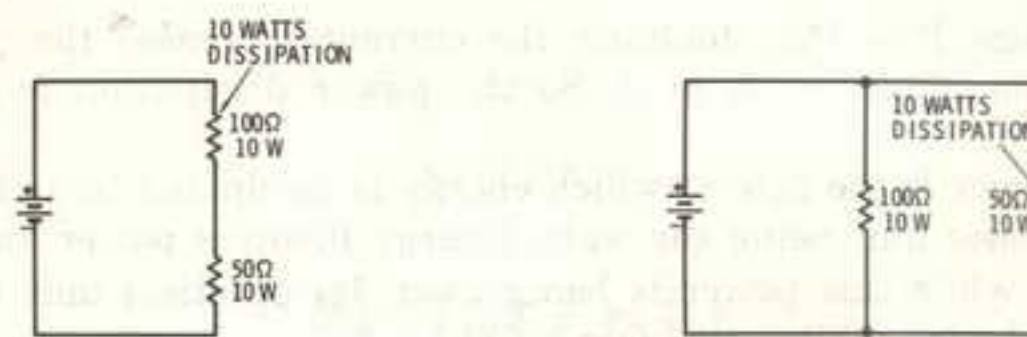

(A) Resistance in series.

(B) Resistance in parallel.

Figure 3-4. Circuits illustrating total power dissipation.

and the same wattage ratings, then the power would be added directly, resulting in 20 watts in this problem.

Connecting the two resistors in parallel (Figure 3-4B) produces the same total power dissipation, 15 watts, as when they are in series. In parallel, however, the 50-ohm unit will dissipate twice the power of the 100-ohm resistor. The reason is that twice as much current will flow through the 50-ohm unit as flows through the 100-ohm unit.

3. A 100-ohm resistor is carrying 50 mA of current. What minimum power rating should it have?

$$\begin{aligned}
 P &= I^2 R \\
 &= (0.05)^2 \times 100 \\
 &= 0.0025 \times 100 \\
 &= 0.25 \text{ watt}
 \end{aligned}$$

4. A 200-ohm resistor is dissipating 12 watts. What is the voltage across the resistor?

$$\begin{aligned}
 P &= \frac{E^2}{R} \\
 E^2 &= PR \\
 E &= \sqrt{PR} \\
 &= \sqrt{12 \times 200} \\
 &= \sqrt{2,400} \\
 &= 49 \text{ volts.}
 \end{aligned}$$

5. What is the effect on power dissipation if the current in a circuit is doubled?

Since $P = I^2R$, doubling the current increases the power by the square of 2, or 4. So the power dissipation is quadrupled.

Power is the rate at which energy is dissipated in a circuit, the basic unit being the watt. Energy involves power and the time while this power is being used. Its practical unit is the watt-hour or kilowatt-hour (kWh).

$$\text{Energy} = \text{Watts} \times \text{Hours}$$

As an example, a receiver is rated at 120 volts and 1 ampere. How much energy is used if the receiver is played 12 hours?

$$\begin{aligned} P &= E \times I \\ &= 120 \times 1 \\ &= 120 \text{ watts} \end{aligned}$$

therefore,

$$\text{Energy} = 120 \text{ watts} \times 12 \text{ hours}$$

or

$$= 1,440 \text{ watt-hours, or } 1.44 \text{ kWh}$$

RESISTANCE

Resistance is the opposition to the flow of current in an electrical circuit. The basic unit of measurement is the ohm. One ohm is the amount of resistance which allows a current of one ampere to flow when one volt is applied. In a conductor, the resistance is directly proportional to the length and inversely proportional to the square of the diameter.

Resistance of a length of wire can be determined by the formula:

$$R = \frac{KL}{d^2}$$

where,

K is a constant which is the resistance of a mil-foot of wire.

A mil-foot is a section of wire having a diameter of 1 mil (.001 inch) and a length of 1 foot,

L is the length of wire in feet,

d^2 is the diameter (in mils) squared.

For copper, the resistance of a mil-foot is 10.4 ohms. Other materials have values which vary inversely with the conductivity of the material. (See Table 4-1.) Thickness of a wire

Table 4-1. Resistivity Constant of Different Metals at a Temperature of Approximately 68° F.

Material	Ohms per Mil-Foot
Aluminum	19.3
Copper	10.4
Iron	72 to 84
Lead	125
Nichrome	660
Platinum	66
Silver	9.9
Tungsten	33
Zinc	36.7

is often expressed in terms of its circular-mil area, which is determined by squaring the diameter (expressed in mils).

Suppose a copper conductor is 12 feet in length and has a diameter of 5 mils. What is its resistance and circular-mil area?

$$R = \frac{KL}{d^2} = \frac{10.4 \times 12}{5^2} = \frac{124.8}{25} = 4.99 \text{ ohms}$$

$$\text{Circular-mil area} = 5^2 = 25 \text{ circular mils}$$

Another length of wire has a resistance of 100 ohms. If the length and diameter are both doubled, what is the new resistance?

For problems of this type the formula below can be used:

$$\frac{R_1}{R_2} = \frac{L_1 \times d_2^2}{L_2 \times d_1^2}$$

Not knowing the length and diameter we can assume any values and the result will be the same. Let's assume them to be 1. Therefore:

$$\frac{100}{R_2} = \frac{1 \times 2^2}{2 \times 1^2}$$

$$\frac{100}{R_2} = \frac{4}{2}$$

$$4R_2 = 200$$

$$R_2 = 50 \text{ ohms}$$

If both diameters are the same, the formula reduces to:

$$\frac{R_1}{R_2} = \frac{L_1}{L_2}$$

If both lengths are the same, the formula can be written as:

$$\frac{R_1}{R_2} = \frac{d_2^2}{d_1^2}$$

SERIES RESISTORS

Resistors connected in series are added directly. This can be expressed as:

$$R_t = R_1 + R_2 + R_3 + \dots$$

where,

R_t is the total resistance in ohms,

R_1 , R_2 , and R_3 are the individual resistances in ohms.

Figure 4-1. Finding the total resistance of resistors in series.

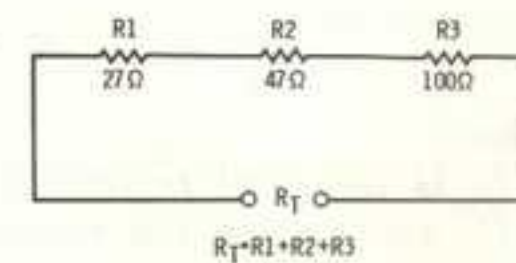

As an example, suppose that resistances of 27, 47, and 100 ohms are connected in series, as shown in Figure 4-1. The total resistance will be:

$$R_t = 27 + 47 + 100 = 174 \text{ ohms}$$

PARALLEL RESISTORS

When two or more resistors are connected in parallel, the total resistance is less than the smallest resistor of the group. If all the parallel resistors have the same value, the total can be found by:

$$R_t = \frac{R}{N}$$

where,

R_t is the total resistance in ohms,

R is the resistance of one resistor in ohms,

N is the number of equal-value resistors connected in parallel.

Figure 4-2. Finding the total resistance of two or more equal resistors in parallel.

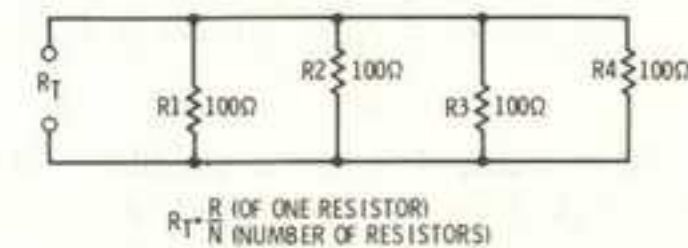

As shown in Figure 4-2, four resistors, each 100 ohms, are connected in parallel. The total resistance is:

$$R_t = \frac{R}{N} = \frac{100}{4} = 25 \text{ ohms}$$

When two resistors (whatever their value) are connected in parallel, the total resistance can be calculated by the "product-over-the-sum" method, as shown next:

$$R_t = \frac{R_1 R_2}{R_1 + R_2}$$

where,

R_t is the total resistance in ohms,

R_1 and R_2 are the resistances connected in parallel.

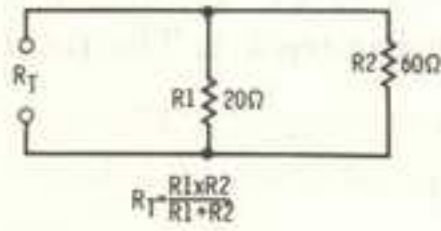

Figure 4-3. Finding the total resistance of two unequal resistors in parallel.

Figure 4-3 illustrates an example where a 20-ohm and a 60-ohm resistor are connected in parallel. The total resistance is:

$$\begin{aligned} R_t &= \frac{R_1 R_2}{R_1 + R_2} \\ R_t &= \frac{20 \times 60}{20 + 60} \\ &= \frac{1,200}{80} \\ &= 15 \text{ ohms} \end{aligned}$$

Another arrangement of this formula works this way: Divide the smaller resistance into the larger, add 1 to the answer, and divide the larger resistance by the result. Expressed as a formula it becomes:

$$R_t = \frac{R_1}{\frac{R_1}{R_2} + 1} \text{ (where } R_1 \text{ is larger than } R_2\text{)}$$

Reworking the same problem, 20 (R_2) can be divided into 60 (R_1) 3 times. Adding 1 gives 4. Dividing 4 into 60 gives a resultant resistance of 15 ohms, the same as obtained before.

The reciprocal formula works for two or more resistors in parallel, and is stated as follows:

$$\frac{1}{R_t} = \frac{1}{R_1} + \frac{1}{R_2} + \frac{1}{R_3} + \dots$$

where,

R_t is the total resistance in ohms,

R_1 , R_2 , and R_3 are the parallel resistances in ohms.

Figure 4-4. Finding the total resistance of parallel resistors by the reciprocal formula.

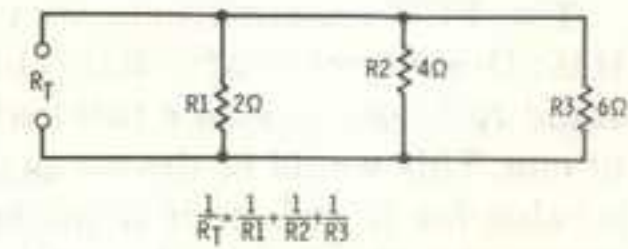

Hence, 2, 4, and 6-ohm resistances connected in parallel (Figure 4-4) would be calculated like this:

$$\begin{aligned} \frac{1}{R_t} &= \frac{1}{2} + \frac{1}{4} + \frac{1}{6} \\ \frac{1}{R_t} &= \frac{6 + 3 + 2}{12} \\ \frac{1}{R_t} &= \frac{11}{12} \\ R_t &= \frac{12}{11} \text{ or } 1.09 \text{ ohms} \end{aligned}$$

In some problems the total resistance and one of the individual resistance values may be given, and we must solve for the other. As illustrated in Figure 4-5, the total resistance of

Figure 4-5. Finding the value of an unknown resistance when the total and the other resistance values are known.

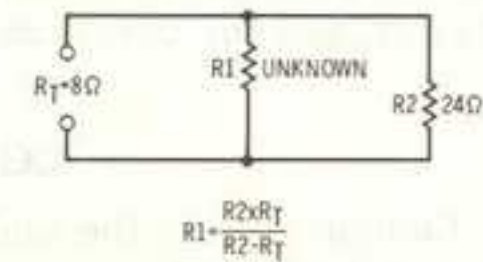

two units connected in parallel is 8 ohms. One of the resistances is 24 ohms. What is the other? First we must transpose our basic formula, assuming R_t to be the unknown:

$$\begin{aligned} R_t &= \frac{R_1 R_2}{R_1 + R_2} \\ R_t (R_1 + R_2) R_t &= R_1 R_2 \\ R_t R_1 - R_1 R_2 &= -R_2 R_t \\ R_t (R_1 - R_2) &= -R_2 R_t \\ R_t &= \frac{-R_2 R_t}{R_1 - R_2} = \frac{R_2 R_t}{R_2 - R_t} \\ R_t &= \frac{24 \times 8}{24 - 8} = \frac{192}{16} = 12 \text{ ohms} \end{aligned}$$

The FCC examinations very often contain a problem like this: Draw a schematic diagram showing how to connect three equal resistors to give a total which is $1\frac{1}{2}$ times the resistance of one. This would be drawn as shown in Figure 4-6. Substitute a value for R and see if it works out. Once you understand the principles of series and parallel resistances, many such prob-

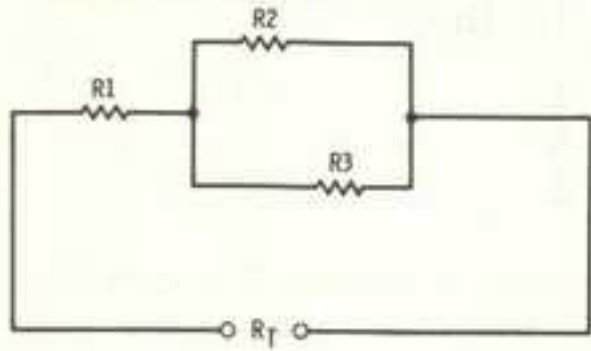

Figure 4-6. A circuit in which all resistors are of equal value and the total resistance is $1\frac{1}{2}$ times the value of a single resistor.

lems can be solved by simple reasoning. In this case, you know that placing all three resistors in series would result in a total resistance three times the value of one. Placing them in parallel would result in a total resistance less than the value of any one. Obviously, then, at least one of the three equal resistors must be series-connected; the additional one-half value then means the two remaining resistors are in parallel.

CONDUCTANCE

Conductance is the ability of a material to carry current. It can be thought of as being inversely proportional to resistance. As resistance decreases, more current can be carried. We say the conductance is increased. If resistance were increased, the conductance would decrease. The basic unit of conductance is the *mho*, which is the conductance that exists with a resistance of 1 ohm. (Mho is *ohm* spelled backward!) Conductance may be calculated by:

$$G = \frac{1}{R}$$

where,

G is the conductance in mhos,
 R is the resistance in ohms,

A circuit having a resistance of 20 ohms has a conductance of 0.05 mho:

$$G = \frac{1}{R} = \frac{1}{20} = .05 \text{ mho}$$

With the conductance given, the resistance can be found by:

$$R = \frac{1}{G}$$

A circuit having a conductance of 2 mhos has a resistance of 0.5 ohm:

$$R = \frac{1}{G} = \frac{1}{2} = 0.5 \text{ ohm}$$

Notice that whenever the resistance is larger than 1 ohm, the conductance will be smaller than 1 mho. Conversely, if the resistance is smaller than 1 ohm, the conductance will be larger than 1 mho.

AC AND AC CIRCUITS

Most commercial electricity is AC (alternating current). So are the signals which occur most often in electronics. Alternating current is so named because it alternately flows in first one direction, and then reverses and flows in the other direction. This is caused by the voltage alternating between a positive and a negative polarity at a definite rate. The basic AC waveform is the sine wave shown in Figure 5-1. All other AC waveforms are composed of sine waves of various frequencies and amplitudes added together. The term *sine wave* was adopted because in the generation of a complete cycle, the

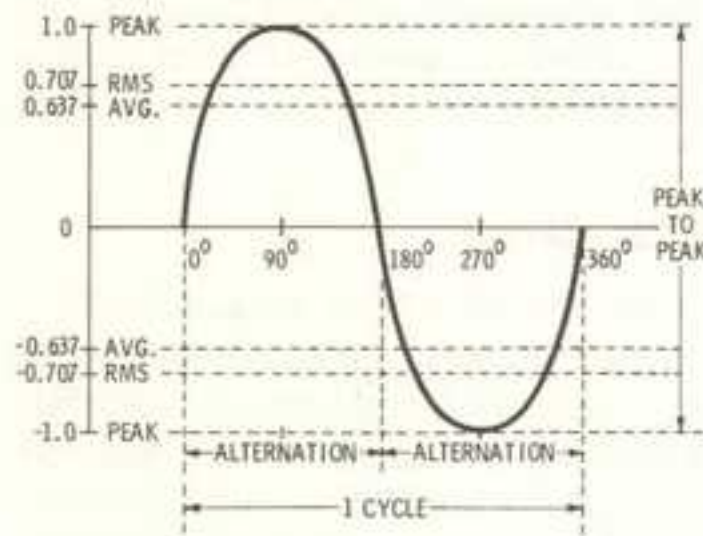

Figure 5-1. One cycle of a sine wave, showing the relationship between the various values of a current or voltage.

instantaneous amplitude at any time is equal to the maximum amplitude multiplied by the sine of the angle through which the generating conductor has moved during that period. By plotting a graph of the sine values at a number of different angles, a sine wave is formed. The complete sine wave is a cycle, each half being called an alternation.

The amplitude of a sine wave varies continuously, the magnitude at any instant of time being known as the instantaneous value. The peak value is the maximum reached at any point during a complete cycle. With a sine wave, this maxi-

imum is reached at 90° and again at 270° , each having opposite polarity from the other. The mathematical relationship between the peak and the instantaneous values of voltage can be found by:

$$e = E_m \times \sin \theta$$

where,

e is the instantaneous amplitude in volts,

E_m is the maximum amplitude in volts,

θ is the angle at which instantaneous voltage is being calculated.

Several examples are given, and these can be verified by reference to Figure 5-1. Using a maximum value of 100 volts:

$$\text{At } 0^\circ, e = 100 \times \sin 0^\circ = 100 \times 0 = 0 \text{ volts}$$

$$\text{At } 30^\circ, e = 100 \times \sin 30^\circ = 100 \times 0.5 = 50 \text{ volts}$$

$$\text{At } 45^\circ, e = 100 \times \sin 45^\circ = 100 \times 0.707 = 70.7 \text{ volts}$$

$$\text{At } 60^\circ, e = 100 \times \sin 60^\circ = 100 \times 0.866 = 86.6 \text{ volts}$$

$$\text{At } 90^\circ, e = 100 \times \sin 90^\circ = 100 \times 1 = 100 \text{ volts}$$

These values are repeated during the remainder of the first alternation, but in reverse order. Then the same values occur during the second alternation, but with opposite polarity. The same relationship exists for current, as given by the next formula:

$$i = I_m \times \sin \theta$$

where,

i is the instantaneous current in amperes,

I_m is the maximum current in amperes,

θ is the angle at which instantaneous current is being calculated.

Because of the nature of inductance and capacitance, there may often be a phase difference between the voltage and the current in AC circuits. That is, the voltage and current maximums may not occur at the same instant, as they do in completely resistive circuits. A large number of the calculations found in later chapters are concerned with the problems of phase and changing values of AC waveforms.

AVERAGE VALUES

In some calculations we are interested in the average value of an AC waveform. Actually, the average amplitude of a

complete cycle is zero, because the amplitudes in the positive direction equal those in the negative direction. For a single alternation, however, the average amplitude is equal to 0.637 of the peak (maximum). This could be shown by adding a large number of instantaneous values, equally spaced across the half-cycle, and then dividing by the number of values used. As a formula:

$$E_{av} = 0.637 \times E_m$$

where,

E_{av} is the average amplitude of one alternation in volts,
 E_m is the maximum amplitude in volts.

Average current of one alternation can be obtained in the same way—by multiplying the maximum by 0.637. It should be stressed that this relationship holds true only for sine waves. Any other waveform will have a different average value. One example is a square wave; here the average and peak values are the same.

EFFECTIVE VALUES

With DC, the amplitudes of the voltage and current remain constant, and a certain current (say, 1 ampere) gives a certain heating effect. An AC wave with a peak current of 1 ampere, will not produce as much heating as DC, because in AC the amplitude is less than the peak most of the time. The effective value of AC is the equivalent DC value which produces the same heating effect. The effective value can be calculated by taking the square root of the average of all instantaneous values squared. Average is also referred to as *mean*, so the effective value is also called the root-mean-square (rms) value. The rms value for a sine wave can be found by:

$$E_{rms} = 0.707 \times E_m$$

where,

E_{rms} is the rms or effective voltage,
 E_m is the maximum amplitude in volts.

Effective current is found in the same way—by multiplying the maximum current by 0.707. Again it should be stressed that this relationship holds true for a sine wave only, not for any other waveshape.

So for sine-wave calculations we have three different voltage or current values which may be of interest to us—peak, average, and rms. In some instances the peak-to-peak voltage also may be indicated. Numerically, this is the over-all change of voltage or current from maximum to maximum,—it is equal to twice the peak value.

Table 5-1 gives the relationships between the various values, which can be used in converting from one to another.

Table 5-1. Sine Wave Value Conversions

GIVEN	TO OBTAIN			
	Avg =	Rms =	Pk =	P to P =
Peak	$0.637 \times Pk$	$0.707 \times Pk$		$2 \times Pk$
Peak to Peak	$0.3185 \times P \text{ to } P$	$0.3535 \times P \text{ to } P$	$0.5 \times Pk \text{ to } Pk$	
Rms	$0.9 \times Rms$		$1.41 \times Rms$	$2.82 \times Rms$
Average		$1.11 \times Avg$	$1.57 \times Avg$	$3.14 \times Avg$

AC CIRCUITS

With purely resistive circuits the use of alternating current poses problems no different from those when DC is used. All the Ohm's-law relationships hold, just as for DC, as well as the various formulas for determining power. However, in many cases, the R in the various formulas must be replaced by X_L , X_C , or impedance (Z), the latter representing the combined resistance and reactance in a circuit. In order to make the various values comparable to DC, the rms values of the AC is expressed unless otherwise indicated. Thus if we say the line voltage is 115, we are implying the rms value. Similarly, AC power of 100 watts is understood to have been calculated from the rms values of voltage and current.

Whenever inductance or capacitance, or both, are used in an AC circuit the relationships assumed for DC are not quite true. The reason is the phase difference between current and voltage. For purely resistive AC circuits, even this causes no problem since the current and voltage are in phase (See Figure 5-2A). In an inductance the current *lags* the voltage by 90° (Figure 5-2B); for capacitance the current *leads* the voltage

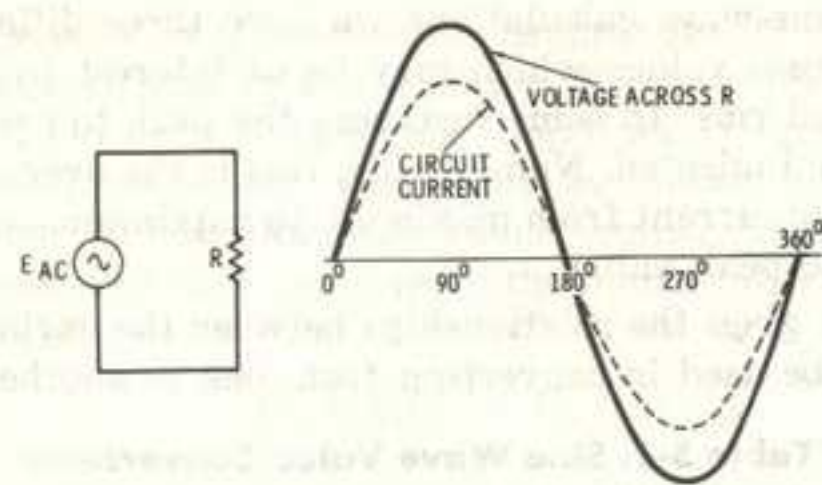

(A) Purely resistive circuit.

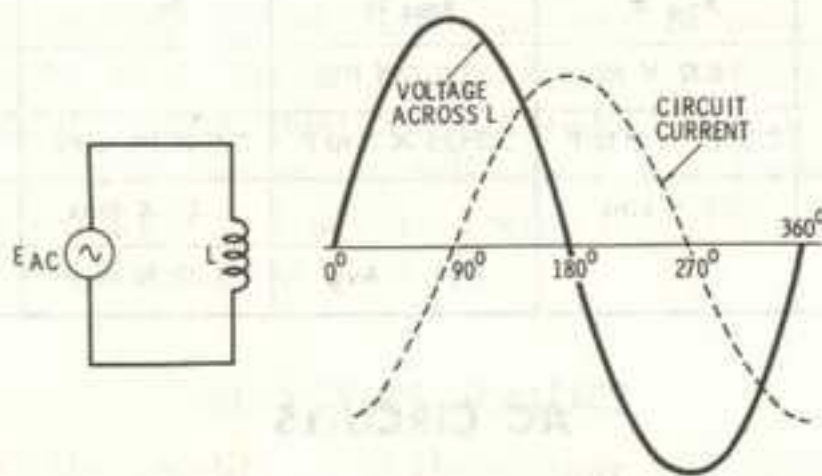

(B) Purely inductive circuit.

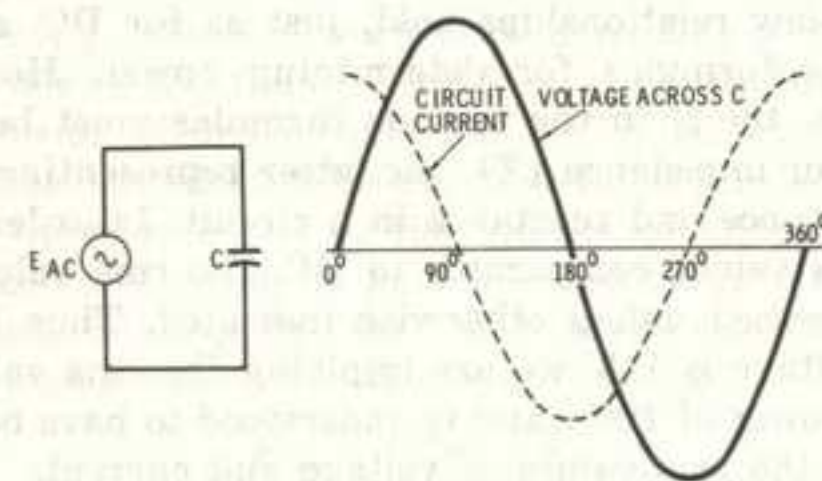

(C) Purely capacitive circuit.

Figure 5-2. Phase relationship between current and voltage.

by 90° (Figure 5-2C). This can be remembered by thinking of the basic properties of L and C . Since an inductor opposes a change of current, the current does not reach maximum until after the voltage—hence the lagging action of the current.

Since a capacitor opposes a change of voltage, the current maximum precedes the voltage—hence the leading current in a capacitive circuit.

When resistance and reactance are both contained in a circuit, the phase angle is between 0° and 90° . The exact angle depends on the relative values of resistance and reactance. Because of this phase difference, resistance and reactance cannot be added directly in a series or parallel circuit. Rather we must add these quantities vectorially (at different angles) and use the results in our Ohm's-law calculations.

SERIES CIRCUITS

In any series circuit the current is the same in any part of the circuit—whether AC or DC, resistive or reactive. This fact gives us our starting point for calculations involving the



Figure 5-3. Reactive circuits.

RL and RC circuits of Figure 5-3. For absolute values of circuit characteristics, both circuits are treated alike. The only difference is that in Figure 5-3A the current *lags* the applied voltage by the phase angle θ . For Figure 5-3B the current *leads* the voltage. So the formulas to be given apply equally to either circuit, except that we will express the formulas in terms of the inductive circuit of Figure 5-3A. To apply them for the capacitive circuit of Figure 5-3B, simply insert X_c into the formulas in place of X_L , each time it appears:

$$Z = \sqrt{R^2 + X_L^2} = \frac{E_a}{I}$$

$$E_a = \sqrt{E_r^2 + E_L^2} = I \times Z$$

$$E_r = I \times R$$

$$E_L = I \times X_L$$

$$\theta = \arctan \frac{X_L}{R} = \arctan \frac{E_L}{E_r}$$

where,

- Z is the impedance in ohms,
- R is the resistance in ohms,
- X_L is the inductive reactance in ohms,
- E_a is the applied voltage in volts,
- I is the circuit current in amperes,
- E_r is the voltage across the resistance in volts,
- E_L is the voltage across the inductance in volts,
- θ is the phase angle in degrees.



(A) Impedance triangle. (B) Voltage triangle.

Figure 5-4. Triangles used for solving certain AC problems.

These formulas can be referred to the impedance and voltage triangles given in Figures 5-4A and B, which apply only to series circuits. Notice that X_L and R are drawn 90° out of phase, with θ representing the angle between the applied voltage E_a and the current I . Impedance Z is the hypotenuse of the triangle. The current is not labeled, but can be assumed to be on the same line with R and E_r . Also the voltages across R and X_L are drawn 90° out of phase, with E_a being the hypotenuse of the triangle. Impedance is always larger than either R or X_L , and applied voltage is always larger than either E_r or E_L . Let's try some problems, to see how these calculations would be used.

In an RL series circuit, R is 4 ohms, X_L is 3 ohms, and the applied voltage is 10 volts. Find the impedance, current, phase angle, E_r , and E_L .

$$Z = \sqrt{R^2 + X_L^2} = \sqrt{4^2 + 3^2} = \sqrt{25} = 5 \text{ ohms}$$

by Ohm's law,

$$I = \frac{E}{Z} = \frac{10}{5} = 2 \text{ amperes}$$

$$\theta = \arctan \frac{X_L}{R} = \arctan \frac{3}{4} = 36.9^\circ$$

$$E_r = I \times R = 2 \times 4 = 8 \text{ volts}$$

$$E_L = I \times X_L = 2 \times 3 = 6 \text{ volts}$$

As a check, let's solve for E_a , using E_r and E_L :

$$E_a = \sqrt{E_r^2 + E_L^2} = \sqrt{8^2 + 6^2} = \sqrt{100} = 10 \text{ volts}$$

Bear in mind that what we have worked out for the RL circuit also holds for an RC circuit with the same values (except that X_c is 3 ohms, instead of X_L). Even the phase angle is the same, except the current is lagging by 36.9° in the RL circuit, but leading by the same angle for the RC network.

All these formulas can be transposed to solve specific problems, a few of which are given next:

1. In a series RC circuit, R is 5 ohms and the impedance is 9 ohms. Solve for X_c :

$$Z = \sqrt{R^2 + X_c^2}$$

$$Z^2 = R^2 + X_c^2$$

$$X_c^2 = Z^2 - R^2$$

$$X_c = \sqrt{Z^2 - R^2} = \sqrt{9^2 - 5^2} = \sqrt{56} = 7.48 \text{ ohms}$$

2. Applied voltage is 36 and E_r is 20 volts. Solve for E_L in this series RL circuit:

$$E_a = \sqrt{E_r^2 + E_L^2}$$

$$E_a^2 = E_r^2 + E_L^2$$

$$E_L^2 = E_a^2 - E_r^2$$

$$E_L = \sqrt{E_a^2 - E_r^2} = \sqrt{36^2 - 20^2} = \sqrt{896} = 29.93 \text{ volts}$$

3. In a series RC circuit, the phase angle is 30° and X_c is 10 ohms. What is the resistance?

$$\theta = \arctan \frac{X_c}{R}$$

taking the tangent of both sides:

$$\tan \theta = \frac{X_c}{R}$$

$$\tan 30^\circ = \frac{10}{R}$$

$$.5774 = \frac{10}{R}$$

$$R = \frac{10}{.5774} = 17.32 \text{ ohms}$$

So far we have considered RL and RC series circuits, but not those containing R , L , and C , as shown in Figure 5-5. Actually the addition of the extra component does not make

too much difference in our calculations, except that the effective reactance in the circuit is the *difference* between X_L and X_C . Using this, the impedance of the circuit is:

$$Z = \sqrt{R^2 + (X_L - X_C)^2}$$

Or, if X_C is larger than X_L , then:

$$Z = \sqrt{R^2 + (X_C - X_L)^2}$$

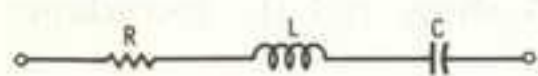

Figure 5-5. Circuit containing series-connected resistance, inductance, and capacitance.

Similarly, the other formulas are based on the *difference* between the two reactances:

$$E_a = \sqrt{E_r^2 + (E_L - E_C)^2}$$

And:

$$\theta = \arctan \frac{X_L - X_C}{R}$$

When X_C is larger than X_L , the reactive parts of the formulas are interchanged:

Suppose that in a series RCL circuit, $R = 5\Omega$, $X_L = 8\Omega$, and $X_C = 6\Omega$. What is the impedance?

$$\begin{aligned} Z &= \sqrt{R^2 + (X_L - X_C)^2} \\ &= \sqrt{5^2 + (8 - 6)^2} \\ &= \sqrt{25 + 4} = 5.39 \text{ ohms} \end{aligned}$$

To find the phase angle,

$$\begin{aligned} \theta &= \arctan \frac{X_L - X_C}{R} \\ &= \arctan \frac{2}{5} = 21.8^\circ \end{aligned}$$

The inductive reactance is larger than the capacitive reactance. Hence the total circuit acts inductively and the current lags the applied voltage.

If 20 volts is applied to the above circuit the current will be:

$$\begin{aligned} I &= \frac{E}{Z} \\ &= \frac{20}{5.39} = 3.71 \text{ amperes} \end{aligned}$$

$$\begin{aligned} E_r &= I \times R \\ &= 3.71 \times 5 = 18.55 \text{ volts} \end{aligned}$$

$$\begin{aligned} E_L &= I \times X_L \\ &= 3.71 \times 8 = 29.68 \text{ volts} \end{aligned}$$

$$\begin{aligned} E_C &= I \times X_C \\ &= 3.71 \times 6 = 22.26 \text{ volts} \end{aligned}$$

Notice that E_L and E_C are both larger than the applied voltage. But since they are 180° out of phase, the total reactive voltage is 29.68 minus 22.26, or 7.42 volts. By adding E_r of 18.55 volts and E_x of 7.42 volts vectorially, we should obtain the applied voltage:

$$\begin{aligned} E_a &= \sqrt{E_r^2 + E_x^2} \\ &= \sqrt{18.55^2 + 7.42^2} \\ &= \sqrt{344.1 + 55.06} \\ &= \sqrt{399.16} = 19.98 \text{ volts} \end{aligned}$$

There is a difference of 0.02 volt because various calculations in the total problem have been rounded off.

If you must solve a series RCL circuit for X_L or X_C , there may be two possible answers. As an example, suppose the impedance of a series circuit is 10 ohms, resistance is 8 ohms, and capacitive reactance is 10 ohms. Solve for inductive reactance. In the solution we will use the symbol X to indicate the difference between the reactances:

$$\begin{aligned} X &= \sqrt{Z^2 - R^2} = \sqrt{10^2 - 8^2} \\ &= \sqrt{100 - 64} = \sqrt{36} = 6 \end{aligned}$$

The total reactance is 6 ohms, and as X_C is 10 ohms, then X_L could be either 4 ohms or 16 ohms, producing a capacitive circuit in the first example and an inductive circuit in the second. In some problems, one value of reactance may turn out to be negative. This is an impossible situation, since only the positive value of reactance can produce a valid result. To illustrate, suppose that in the previous problem $X_C = 4$ ohms. Then for a reactance difference of 6 ohms, X_L must be either -2 ohms or 10 ohms, the first answer of which is impossible to attain. So only the 10-ohm answer would be valid.

PARALLEL CIRCUITS

When R , L , and C are connected in parallel as in Figure 5-6, the voltages across all three components are the same, just as in any other parallel arrangement. The currents in the different branches are not necessarily the same, however, nor at the

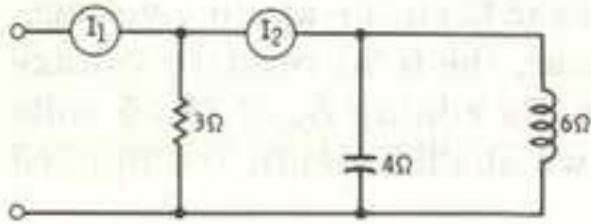

Figure 5-6. Circuit containing parallel-connected resistance, inductance, and capacitance.

same phase angle. Current in each branch can be determined by Ohm's law—dividing the resistance, or reactance, into the applied voltage. Then the currents can be added vectorially to calculate the total current I_t , in Figure 5-6. The impedance of a parallel RLC circuit cannot be calculated by the formula $Z = \sqrt{R^2 + (X_L - X_C)^2}$, as was done for series circuits, but must be calculated by other means.

Several formulas can be used to calculate impedance of this circuit directly, but they are lengthy and often difficult to remember. As an example:

$$Z = \frac{RX_L X_C}{\sqrt{X_L^2 X_C^2 + (RX_L - RX_C)^2}}$$

Phase angle can be calculated by:

$$\theta = \arctan \frac{RX_C - RX_L}{X_L X_C}$$

Here is a method of calculating impedance which can be remembered much more easily: Find the total circuit current; then divide it into the voltage. Using the R and X values given in Figure 5-6, let's calculate the impedance by the current method. Applied voltage is not given in the problem; so we can assume one in order to find the currents. The impedance will come out the same no matter what voltage is assumed. For this problem, 12 volts is a good choice because R , X_L , and X_C all divide into it a whole number of times. Then the currents are as follows:

$$I_r = \frac{E}{R} = \frac{12}{3} = 4 \text{ amps}$$

$$I_c = \frac{E}{X_c} = \frac{12}{4} = 3 \text{ amps}$$

$$I_L = \frac{E}{X_L} = \frac{12}{6} = 2 \text{ amps}$$

Since I_c and I_L are 180° out of phase with each other, the total reactive current is 3 minus 2, or 1 ampere. This is the current I_s in Figure 5-6. Since this reactive current is 90° out of phase with the resistive current (4 amps), they must be added as shown:

$$I_t = \sqrt{I_r^2 + I_s^2} = \sqrt{4^2 + 1^2} \\ = \sqrt{17} = 4.12 \text{ amps}$$

Impedance is then determined by Ohm's law:

$$Z = \frac{E}{I_t} \\ = \frac{12}{4.12} = 2.91 \text{ ohms}$$

Suppose we use 24 volts as the applied voltage? We obtain the same result:

$$Z = \frac{E}{I_t} \\ = \frac{24}{8.24} = 2.91 \text{ ohms}$$

This is classed as a capacitive circuit because capacitive current is larger than the current through the inductance.

Figure 5-7. Resistance and inductance in parallel.

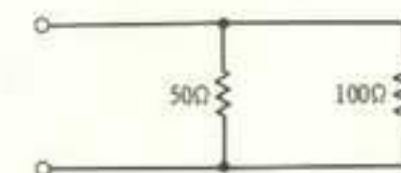

If the parallel circuit contains only one reactance, the problem is worked the same way but is simplified. An example is the circuit in Figure 5-7, where R is 50 ohms and X_L is 100 ohms. If we assume an applied voltage of 100, then:

$$I_r = \frac{E}{R}$$

$$= \frac{100}{50} = 2 \text{ amps}$$

And:

$$I_L = \frac{E}{X_L}$$

$$= \frac{100}{100} = 1 \text{ amp}$$

Then:

$$I_t = \sqrt{2^2 + 1^2}$$

$$= \sqrt{5} = 2.24 \text{ amps}$$

And:

$$Z = \frac{E}{I_t}$$

$$= \frac{100}{2.24} = 44.6 \text{ ohms}$$

Note that these parallel circuits cannot be calculated like resistors in parallel because of the phase differences involved. Neither can we add the oppositions vectorially as we did for series circuits, although we can add the currents by that method. For series circuits, the phase angle was determined by the relative values of reactance and resistance. For parallel circuits we use the reactive and resistive currents. For example, in Figure 5-6:

$$\theta = \arctan \frac{I_x}{I_r}$$

$$= \arctan \frac{1}{4} = 14^\circ$$

For Figure 5-7:

$$\theta = \arctan \frac{I_x}{I_r}$$

$$= \arctan \frac{1}{2} = 26.6^\circ$$

AC POWER

As indicated at the beginning of this chapter, AC values are normally stated in rms values unless otherwise indicated.

Power, which is calculated from rms values, is usually referred to as average power. When AC is applied across a resistance only, the voltage and current are in phase. So $E \times I$, I^2R , or E^2/R can all be used to calculate power in the circuit. In this respect AC circuits are very similar to DC as long as rms values are used. This calculated power gives the amount dissipated by the purely resistive circuit.

However, when an AC circuit also contains reactance—either inductive or capacitive, or both—the power calculations will be altered. Circuit resistance dissipates power because in a resistance the voltage and current are in phase. Circuit reactance returns power to the line because of the 90° phase difference between voltage and current. This results in certain relations which may be confusing. In a series circuit composed of resistance and reactance, multiplying the applied voltage by the circuit current gives a certain result called apparent power (P_a). This value is greater than the power dissipated by the resistor, called true power (P_t). To distinguish it from true power, the apparent power is usually expressed in volt-amperes, which are numerically the same as watts. The ratio of true power to apparent power is called the power factor (PF):

$$PF = \frac{P_t}{P_a}$$

where,

PF is the power factor (always between 0 and 1),
 P_t is the true power in watts,
 P_a is the apparent power in volt-amperes.

Power factor of a series circuit can also be expressed in terms of circuit opposition and phase angle, as shown next:

$$PF = \frac{R}{Z} = \cos \theta$$

where,

PF is the power factor,
 R is the circuit resistance in ohms,
 Z is the circuit impedance in ohms,
 θ is the phase angle in degrees.

These relationships are the same because in the standard impedance triangle (see Figure 5-4A) the cosine of the phase

angle is equal to R divided by Z . Let's solve for the power relationships in the series circuit of Figure 5-8:

$$Z = \sqrt{R^2 + (X_L - X_C)^2} = \sqrt{3^2 + (6-2)^2}$$

$$= \sqrt{25} = 5 \text{ ohms}$$

$$I = \frac{E}{Z}$$

$$= \frac{20}{5} = 4 \text{ amps}$$

$$P_a = E \times I$$

$$= 20 \times 4 = 80 \text{ volt amperes}$$

$$P_t = I^2 \times R$$

$$= 4^2 \times 3 = 48 \text{ watts}$$

$$PF = \frac{P_t}{P_a}$$

$$= \frac{48}{80} = \frac{3}{5} = 0.6$$

We can check this result with the other formulas:

$$PF = \frac{R}{Z}$$

$$= \frac{3}{5} = 0.6$$

$$\theta = \arctan \frac{X}{R}$$

$$= \arctan 1.33 = 53.1^\circ$$

$$PF = \cos \theta$$

$$= \cos 53.1^\circ = 0.6004$$

This latter result is extremely close, considering that we determined θ only to the nearest tenth of a degree. For series RL or RC circuits, the calculations are the same except that we need to consider only one reactance—the total to be used.

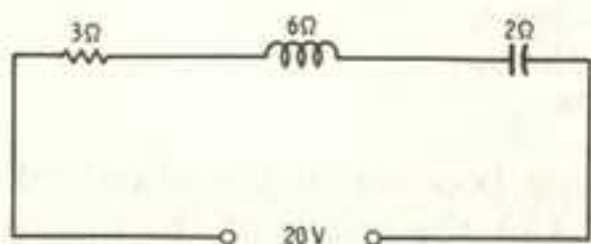

Figure 5-8. Resistance, inductance, and capacitance in series.

Figure 5-8 is an inductive circuit because X_L is larger than X_C . Current lags the applied voltage, so the power factor can also be termed "a lagging power factor." In a few instances, power factor may be expressed as a percentage, in which case 0.6 would be the same as 60%. Power factor of a purely resistive circuit is 1; for a purely reactive circuit, it is 0.

For parallel circuits the idea is the same except that the methods of calculation vary slightly. The P_t/P_a relationship still holds, as well as cosine θ . But for parallel circuits the angle is figured from the current, which is inversely proportional to impedance. Therefore, instead of R/Z , power factor in parallel circuits is calculated by Z divided by R . Let's use Figure 5-6 and illustrates power factor for parallel circuits, assuming an applied voltage of 12 volts. From our previous calculations, $I_t = 4.12$ amps and $Z = 2.91$ ohms.

$$P_a = E \times I_t$$

$$= 12 \times 4.12 = 49.44 \text{ volt amperes}$$

And:

$$P_t = E \times I_r$$

$$= 12 \times 4 = 48 \text{ watts}$$

Therefore:

$$PF = \frac{P_t}{P_a}$$

$$= \frac{48}{49.44} = 0.971$$

Checking:

$$PF = \frac{Z}{R}$$

$$= \frac{2.91}{3} = 0.97$$

Previously it was found that the phase angle for this circuit is 14° . So:

$$PF = \cos \theta$$

$$= \cos 14^\circ = 0.9703$$

FREQUENCY

As defined in the preceding chapter, a *cycle* of alternating current consists of two successive alternations, one positive and one negative. We can express the duration as the number of cycles which occur in one second. This is called the *frequency* of the AC wave and it is always expressed as a certain value in hertz (cycles per second). Commercial AC power is usually supplied at 60 hertz, which means that sixty cycles occur during each second, each cycle lasting $\frac{1}{60}$ th of a second.

Normally, DC is considered as having a frequency of zero hertz. On the other hand, various types of radiation extend into the millions-of-hertz region or beyond. Names are given to some frequency ranges—for example the *audio* range, which extends up to about 20,000 hertz; or the *ultrasonic* range, starting at about that point and extending to several hundred kilohertz. Broadcast and communications stations are assigned frequencies beginning at 10 kilohertz and extending up to 30,000 megahertz. The Federal Communications Commission (FCC) has established the following frequency-range designations:

Very low frequencies (VLF)	—Below 30 kHz.
Low frequencies (LF)	—30-300 kHz.
Medium frequencies (MF)	—300-3,000 kHz.
High frequencies (HF)	—3,000-30,000 kHz.
Very high frequencies (VHF)	—30,000 kHz-300 MHz.
Ultra high frequencies (UHF)	—300-3,000 MHz.
Super high frequencies (SHF)	—3,000-30,000 MHz.
Extremely high frequencies (EHF)	—30,000-300,000 MHz.

WAVELENGTH

Radio waves are assumed to travel through space at approximately 186,000 miles (300 million meters, or 984 million

feet) per second. Therefore, each cycle of radio energy occupies a certain distance in space, called *wavelength*. It is usually expressed in meters or feet, or for the shorter wavelengths, in centimeters or inches. Since the velocity is the same for all frequencies, this means the wavelength of a given signal depends only on the frequency. The general formula which follows can be used to solve for wavelength, the symbol of which is the Greek letter *lambda* (λ):

$$\lambda = \frac{v}{f}$$

where,

λ is the wavelength,
 v is the velocity of propagation,
 f is the signal frequency.

In using this formula, we express frequency in basic units of hertz. Thus, both wavelength and velocity will be in the same units of distance. In the next formula, wavelength is listed in meters and velocity in meters *per second*:

$$\lambda = \frac{300,000,000}{\text{Hz}}$$

As an example, a wavelength at 1,500 kHz is:

$$\lambda = \frac{300,000,000}{1,500,000} = 200 \text{ meters}$$

To shorten the formulas, the next two forms may be used, especially for the higher frequencies:

$$\lambda = \frac{300,000}{\text{kHz}} = \frac{300}{\text{MHz}} = \text{meters}$$

Solving the previous problem with these formulas produces the same answer, 200 meters. If we wanted the answer expressed in feet, we could multiply the number of meters by 3.28 (the number of feet in a meter). For the previous problem the wavelength would be 200 times 3.28, or 656 feet. We could solve for feet directly by using:

$$\lambda = \frac{984,000,000}{\text{Hz}} = \frac{984,000,000}{1,500,000} = 656 \text{ feet}$$

Two other versions of this formula may be used to facilitate calculations:

$$\lambda = \frac{984,000}{\text{kHz}} = \frac{984}{\text{MHz}} = \text{feet}$$

If wavelength (λ) is given in a problem, then the original formula can be transposed, giving the results shown next:

$$\lambda = \frac{v}{f} \qquad f = \frac{v}{\lambda} \qquad v = \lambda f$$

Since velocity is a constant, it is of no concern in ordinary problems. Let's solve a problem, finding the frequency, if the wavelength of a signal is 40 meters:

$$f = \frac{v}{\lambda} = \frac{300,000,000}{40} = 7,500,000 \text{ Hz or } 7.5 \text{ MHz}$$

These formulas show that frequency and wavelength are inversely proportional to each other. In other words, if the frequency is doubled, the wavelength is halved. This inverse relationship can be shown from this formula:

$$\frac{\lambda_1}{\lambda_2} = \frac{f_2}{f_1}$$

The wavelength at a certain frequency is 60 meters. What will the wavelength be if the frequency is tripled?

$$\frac{60}{\lambda_2} = \frac{3}{1}$$

$$3\lambda_2 = 60$$

$$\lambda_2 = 20 \text{ meters}$$

This formula shows that the inverse proportion holds true—since the frequency was tripled, the wavelength was reduced to one third its former value.

In some electronics applications we are interested in fractions of wavelengths, such as in finding the length of a half-wave antenna. The formulas already given can be used to find a full wavelength, and then multiplied by the proper fraction to give us the result.

TIME

As previously explained, each cycle occurs in a certain interval, called the *period*. It can be found from the following:

$$t = \frac{1}{f}$$

where,

t is the duration of one cycle in seconds,
 f is the frequency in hertz.

What is the period of a 400-Hz signal?

$$t = \frac{1}{f} = \frac{1}{400} = 0.0025 \text{ second}$$

For higher frequencies we can use the same formula, stating frequency in megahertz and time in microseconds. For example, what is the period of an 8,000-kHz wave?

$$t = \frac{1}{f} = \frac{1}{8} = 0.125 \text{ microsecond}$$

If the period of a signal is 0.5 microsecond, what is the wavelength in meters?

This can be solved by two separate problems. First the frequency could be found, and then the wavelength. Or it could be solved directly by:

$$\lambda = v \times t = 300 \times 0.5 = 150 \text{ meters}$$

In some AC formulas, (such as those for reactance) the expression $2\pi f$ often appears. This quantity is called *angular velocity* and is sometimes indicated by the symbol ω (*omega*). There are 2π radians in each 360° , or a complete cycle. Multiplying by the number of hertz gives us the number of radians covered during each second of time.

What is the angular velocity of a 2,000-Hz signal?

Angular velocity = $2\pi f = 6.28 \times 2,000 = 12,566$ radians per second.

INDUCTANCE

Inductance opposes any change of current through it. This opposition is present because the coil develops a counterelectromotive force with a polarity opposite that of the applied voltage. The basic unit of inductance is the *henry*, which was defined in Chapter 5.

Inductance of an individual coil depends on a number of coil characteristics—primarily the number of turns, the physical dimensions, and the permeability of the core. *Permeability* (μ) is a measure of the ease with which a material can carry magnetic lines of force. Air has a permeability of 1. Inductance varies directly with the permeability and directly as the square of the number of turns. These properties are shown mathematically by the next two formulas, in which the subscript 1 indicates the initial condition and subscript 2 the same condition after a change in one of the coil characteristics:

$$\frac{L_1}{L_2} = \frac{\mu_1}{\mu_2}$$

$$\frac{L_1}{L_2} = \frac{N_1^2}{N_2^2}$$

where,

L is the inductance of L_1 and L_2 (both in the same measurement units),

μ is the permeability of the core,

N is the number of turns in the coil.

A coil having an inductance of 2 henrys has its core replaced by one having a permeability three times as great. What is the new inductance?

$$\frac{2}{L_2} = \frac{1}{3}$$

$$L_2 = 6 \text{ henrys}$$

indicating that inductance is directly proportional to the permeability of the core.

A 400-turn coil has an inductance of 3 henrys. If the number of turns is increased to 600, what is the new inductance?

$$\frac{3}{L_2} = \frac{400^2}{600^2}$$

$$\frac{3}{L_2} = \left(\frac{2}{3}\right)^2$$

$$\frac{3}{L_2} = \frac{4}{9}$$

$$4L_2 = 27$$

$$L_2 = \frac{27}{4}$$

$$= 6.75 \text{ henrys}$$

INDUCTIVE REACTANCE

Inductive reactance (X_L) is the opposition offered by the coil to the flow of AC. It can be determined by this formula:

$$X_L = 2\pi fL$$

where,

X_L is the inductive reactance in ohms,

f is the frequency in hertz,

L is the inductance in henrys,

2π is equal to 6.28 (a constant).

Inductive reactance varies directly with frequency and inductance. If either or both are increased, the reactance will increase and vice versa.

What is the inductive reactance of a 3-henry coil operating at 600 kHz?

$$X_L = 2\pi fL$$

$$X_L = 6.28 \times 6 \times 10^5 \times 3$$

$$= 113 \times 10^5 \text{ ohms}$$

We can use the basic equation and solve for either inductance or frequency, as shown next:

$$X_L = 2\pi fL$$

$$f = \frac{X_L}{2\pi L}$$

or:

$$L = \frac{X_L}{2\pi f}$$

At 50 kHz a coil has 500 ohms of inductive reactance. What is the inductance?

$$L = \frac{X_L}{2\pi f} = \frac{500}{6.28 \times 50,000} = \frac{1}{628} = 0.0016 \text{ henry}$$

We could solve for frequency in the same manner, by using the formula already given. As long as X_L is directly proportional we can use the next two relationships whenever one of the variables remains constant. With inductance constant:

$$\frac{X_{L1}}{X_{L2}} = \frac{f_1}{f_2}$$

With frequency constant:

$$\frac{X_{L1}}{X_{L2}} = \frac{L_1}{L_2}$$

These formulas can be used to solve the following types of problems:

1. An inductor has a reactance of 400 ohms at 100 kHz. What is its reactance at 125 kHz?

$$\frac{X_{L1}}{X_{L2}} = \frac{f_1}{f_2}$$

$$\frac{400}{X_{L2}} = \frac{100}{125}$$

$$100 X_{L2} = 50,000$$

$$X_{L2} = 500 \text{ ohms}$$

2. At a given frequency a coil has a reactance of 7,500 ohms. What will the reactance be if the frequency is quadrupled?

$$\frac{X_{L1}}{X_{L2}} = \frac{f_1}{f_2}$$

$$\frac{7,500}{X_{L2}} = \frac{1}{4}$$

$$X_{L2} = 4 \times 7,500$$

$$X_{L2} = 30,000 \text{ ohms}$$

INDUCTOR COMBINATIONS

When series- or parallel-connected coils are physically close together, the lines of force from each pass through the other, changing the total amount of inductance. This interaction is called *mutual inductance* and is measured in henrys—just like the self-inductance of a single coil. So, in considering total inductance of a group of coils, we must take into account whether or not there is mutual coupling between them. With no coupling, a group of series-connected coils produces a total inductance equal to the sum of the individual coils.

$$L_t = L_1 + L_2 + L_3 + \dots$$

For example, if three inductances, 2, 3, and 4 henrys, are series-connected (Figure 7-1A), the total inductance will be:

$$L_t = 2 + 3 + 4 = 9 \text{ henrys}$$

With mutual coupling, the total inductance of two series-connected coils is:

$$L_t = L_1 + L_2 \pm 2M$$

where,

L_t is the total inductance,
 L_1 and L_2 are the series inductances,
 M is the mutual inductance.

If the coils are connected series-aiding (Figure 7-1B), the $2M$ term is positive and adds to the total inductance. If the coils are wound series-opposing (Figure 7-1C), there is at least a partial cancellation of effective inductance and the $2M$ term is negative, decreasing the total. When the coefficient of coupling is known, the mutual inductance can be determined from the following:

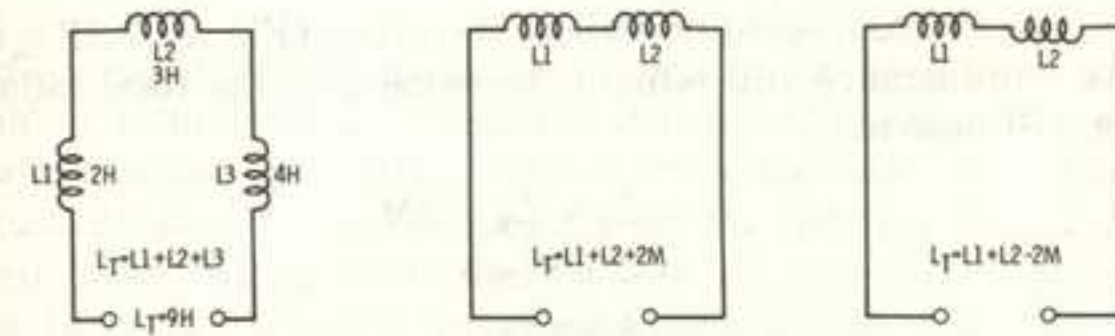

(A) No coupling.

(B) Series-aiding.

(C) Series-opposing.

Figure 7-1. Circuits of series-connected inductances.

$$M = K\sqrt{L_1 L_2}$$

where,

M is the mutual inductance,
 K is the coefficient of coupling,
 L_1 and L_2 are the series-connected inductors.

The coefficient of coupling (K) is a decimal indicating the percentage of the lines of force passing through the other coil. It is always equal to 1 or less, thus a K of 80% would be the same as 0.8. The decimal form will be used in our calculations.



(A) Series-aiding.

(B) Series-opposing.

Figure 7-2. Two inductances connected in series to illustrate the effect of mutual inductance on the total circuit inductance.

Suppose a 2-henry and an 8-henry coil are connected series-aiding with a coefficient of coupling of 75%. (See Figure 7-2A). We can find the mutual inductance by:

$$\begin{aligned} M &= K\sqrt{L_1 L_2} \\ &= 0.75 \sqrt{2 \times 8} \\ &= 0.75 \times 4 \\ &= 3 \text{ henrys} \\ L_t &= L_1 + L_2 + 2M \\ &= 2 + 8 + 6 \\ &= 16 \text{ henrys} \end{aligned}$$

If they are connected in series-opposition (Figure 7-2B), the mutual inductance will remain the same. But the total inductance will now be:

$$\begin{aligned} L_t &= L_1 + L_2 - 2M \\ &= 2 + 8 - 6 \\ &= 4 \text{ henrys} \end{aligned}$$

Where the coupling coefficient is unknown, mutual inductance can be calculated by:

$$M = \frac{L_a - L_b}{4}$$

where,

M is the mutual inductance,
 L_a is the total inductance with fields aiding,
 L_b is the total inductance with fields opposing.

For this, L_a and L_b can be measured by suitable equipment, and then M calculated. Reworking the previous problem to find M , $L_a = 16$ henrys and $L_b = 4$ henrys. Then:

$$\begin{aligned} M &= \frac{16-4}{4} \\ &= \frac{12}{4} \\ &= 3 \text{ henrys} \end{aligned}$$

The coefficient of coupling can then be solved by:

$$\begin{aligned} K &= \frac{M}{\sqrt{L_1 L_2}} \\ &= \frac{3}{\sqrt{2 \times 8}} \\ &= \frac{3}{4} \\ &= 0.75 \end{aligned}$$

Inductive reactances in series add directly, just like resistors.

$$X_{L_t} = X_{L_1} + X_{L_2} + X_{L_3}$$

where,

X_{L_t} is the total inductive reactance in ohms,
 X_{L_1} , X_{L_2} , and X_{L_3} are the individual reactances in ohms.

Of course if there were mutual coupling, the total reactance would be either larger or smaller, depending on how the coils were connected. However, once we know the total inductance, we can calculate the total reactance by the formula $X_L = 2\pi fL$.

Inductors can be connected in parallel, but this is seldom done in actual practice, primarily because the coils may be relatively expensive and paralleling them merely decreases the total inductance. So from a practical standpoint it would

be much better to use a single coil having a smaller value. Connecting coils in parallel has the same effect on total reactance as on total inductance—the total is reduced to a value smaller than the smallest individual reactance or inductance.

ENERGY AND Q

The energy stored in a coil can be determined from this formula:

$$W = \frac{LI^2}{2}$$

where,

W is the energy, in joules (watt-seconds),
 L is the inductance in henrys,
 I is the current in amperes.

Thus, if 3 amperes flow through an 8-henry coil, the energy will be:

$$\begin{aligned} W &= \frac{LI^2}{2} \\ &= \frac{8 \times 3^2}{2} \\ &= \frac{72}{2} \\ &= 36 \text{ joules} \end{aligned}$$

We can also use the basic formula and solve for L or I :

$$W = \frac{LI^2}{2}$$

$$2W = LI^2$$

$$L = \frac{2W}{I^2}$$

$$I = \sqrt{\frac{2W}{L}}$$

The Q of a coil is the ratio of the energy stored to that dissipated; it can be stated as:

$$Q = \frac{X_L}{R}$$

where,

Q is the figure of merit of the coil (no unit),
 X_L is the inductive reactance in ohms,
 R is the effective resistance in ohms.

A coil which has an X_L of 200 ohms and an effective resistance of 40 ohms has a Q of:

$$\begin{aligned} Q &= \frac{X_L}{R} \\ &= \frac{200}{40} \\ &= 5 \end{aligned}$$

The R in the formula includes the ohmic or DC resistance of the coil, as well as any AC resistance, such as skin effect, which may be present in the circuit. We shall see in the next chapter that Q indicates the charge on a capacitor. Hence, the two uses should not be confused.

TIME CONSTANT

Recall that inductance opposes any change of current through it. Therefore, when voltage is applied, the current requires a certain amount of time to reach a maximum. This time depends on the *time constant* of the circuit. This time constant is found by dividing the inductance by the series resistance.

$$TC = \frac{L}{R}$$

where,

TC is the time constant in seconds,
 L is the inductance in henrys,
 R is the resistance in ohms.

A time constant is defined as the time required for the current to reach 63.2% of its maximum value. During the next time constant, the current increases to 63.2% of the difference remaining (36.8%), or to 86.5%. During the third time constant, the current again increases to 63.2% of the remainder (13.5%). So, at the end of the third time constant the

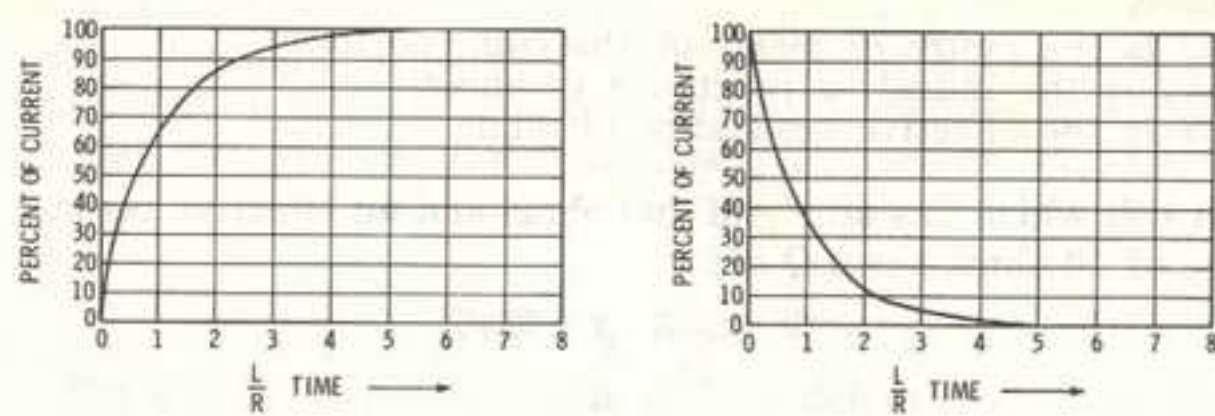

(A) Current increase.

(B) Current decrease.

Figure 7-3. Rate of change of current through an inductance and resistance in series.

current is 95% of maximum. After four and five time constants, the percentages are 98.2 and 99.3, respectively. For practical purposes the current is assumed to reach its maximum value in five time constants. Figure 7-3A shows the rate of current increase from the time voltage is applied, until the maximum value has been reached. The decrease of coil current is at the same nonlinear rate and is shown in Figure 7-3B. After one time constant of discharge, the current has decreased by 63.2%, or to 36.8% of its maximum value. At the end of each of the next four time constants, the current is 13.5%, 5%, 1.8%, and 0.7%, respectively. A long time constant can therefore be obtained by making the inductance large or the resistance small, or both. The time constant varies directly with inductance—the delay of current change being directly proportional to the time constant.

Suppose a 2-henry coil in series with a 1,000-ohm resistor is connected across 200 volts DC. The maximum current will be $200 \div 1,000$, or 0.2 ampere, because at the end of five time constants the current will be limited only by the resistance in the circuit. The time constant will be:

$$TC = \frac{L}{R} = \frac{2}{1,000} = 0.002 \text{ second}$$

- At 1 time constant, $I = 63.2\%$ of 0.2 = 0.1264 ampere
- At 2 time constants, $I = 86.5\%$ of 0.2 = 0.1730 ampere
- At 3 time constants, $I = 95\%$ of 0.2 = 0.19 ampere
- At 4 time constants, $I = 98.2\%$ of 0.2 = 0.1964 ampere
- At 5 time constants, $I = 99.3\%$ of 0.2 = 0.1986 ampere

TRANSFORMERS

Turns and Impedance

In a transformer, the voltage of the secondary can be calculated from the formula:

$$E_s = E_p \times N$$

where,

E_s is the secondary voltage,

E_p is the primary voltage,

N is the turns ratio (no unit).

The turns ratio (N) in this formula is the number of turns on the secondary windings, divided by the number on the primary. In a step-up transformer, N is greater than 1 and the secondary voltage is higher than the primary voltage. In a step-down transformer, N is less than 1 and the secondary voltage is smaller.

A transformer has 200 turns on the primary and 800 on the secondary. If 115 volts is applied to the primary, what is the secondary voltage?

$$N = \frac{800}{200}$$

$$= 4$$

$$E_s = E_p \times N$$

$$E_s = 115 \times 4$$

$$= 460 \text{ volts}$$

In any transformer, the impedance ratio is equal to the square of the turns ratio:

$$Z = N^2$$

where,

Z is the impedance ratio,

N is the turns ratio.

Conversely the turns ratio is the square root of the impedance ratio ($N = \sqrt{Z}$).

A step-down transformer has a 5-to-1 turns ratio. If the impedance of the primary is 600 ohms, what is the secondary impedance?

$$Z = N^2$$

Since:

$$N = 5$$

Then:

$$Z = 5^2 \\ = 25$$

This means the primary impedance is twenty-five times greater than the secondary. Therefore the secondary impedance is 600 ohms divided by 25, or 24 ohms.

Efficiency

Neglecting losses, the power in the primary should be equal to the power in the secondary, or:

$$E_p I_p = E_s I_s$$

where,

E_p and E_s are the primary and secondary voltages,
 I_p and I_s are the primary and secondary currents.
 E_p times I_p gives the primary power,
 E_s times I_s gives the power in the secondary.

A step-up transformer has a turns ratio of 8-to-1. Primary voltage is 100, with a current of 2 amperes. What is the secondary current? Since step-up operation is indicated, the secondary voltage is 100 times 8, or 800 volts. Then:

$$E_p I_p = E_s I_s \\ I_s = \frac{E_p I_p}{E_s} \\ = \frac{100 \times 2}{800} \\ = 0.25 \text{ ampere}$$

Neglecting losses, notice that the current was stepped down by the same ratio the voltage was stepped up. The voltage was increased eight times from primary to secondary. So the current in the secondary is one-eighth that in the primary.

Efficiency of a transformer is calculated from the formula:

$$\% \text{ efficiency} = \frac{P_s}{P_p} \times 100$$

where,

P_s is the secondary power ($E_s \times I_s$),
 P_p is the primary power ($E_p \times I_p$).

Thus, a transformer having 50 watts in the primary and 48 watts in the secondary has an efficiency of:

$$\% \text{ eff.} = \frac{48}{50} \times 100 \\ = 96\%$$

CAPACITANCE

A capacitor is formed by separating two metallic plates by an insulating material called a dielectric. When a voltage is applied across it, a capacitor charges by depositing electrons on one plate (making that plate negative), and by drawing electrons from the other plate (making it positive). The number of electrons which can be stored, with a given applied voltage, is a measure of the capacitance of the unit. When the capacitor is charged, electrostatic lines of force exist between the plates. Hence the charge is assumed to be stored in the dielectric material.

A capacitor tends to oppose any change of voltage across it. Therefore, it takes a certain amount of time to charge to the applied voltage. Once charged, a potential difference (measured in volts) exists across the plates. The charge on the capacitor is a measure of the number of electrons stored—the basic unit of this charge being the coulomb. (One coulomb = 6.24×10^{18} electrons). There is also a certain amount of potential energy stored, which is measured in joules.

The basic unit of capacitance is the farad. One farad is the amount of capacitance which stores one coulomb of electricity when a potential difference of one volt is applied across the plates. A farad is much too large for practical work. So capacitors used in electronic circuits are usually rated in microfarads (μF) or picofarads (pF).

FACTORS AFFECTING CAPACITANCE

The capacitance of a parallel-plate capacitor may be found from this formula:

$$C = \frac{0.2235KA(N-1)}{D}$$

where,

C is the capacitance in pF,
 K is the dielectric constant,

A is the area of one plate in square inches,
 D is the distance between plates in inches,
 N is the number of plates.

We may never use this formula to any great extent, but it does give us a set of important relationships. It tells us how the various factors determine the actual amount of capacitance of a given unit. Capacitance varies directly with the dielectric constant, area of the plates, and the number. Capacitance also varies inversely with distance between plates (thickness of dielectric). The dielectric constant is a measure of the insulating qualities of the dielectric material, compared with air (which is assumed to be 1). Table 8-1 lists the constants for some of the more common materials. The factor

Table 8-1. Approximate Dielectric Constants of Common Materials

Dielectric Material	Approximate Dielectric Constant	Dielectric Material	Approximate Dielectric Constant
Air	1.0	Paraffin coated paper	3.5
Bakelite	5.0	Glass	8.0
Mica	6.0	Wood	5.0
Paper	2.0	Fiber	5.0

$(N-1)$, in the formula, represents the number of capacitor sections—if the capacitor contains five plates there are four separate dielectric sections, hence four capacitors, all connected in parallel. For a single-section capacitor (two plates), the $N-1$ factor can be ignored because it is equal to 1.

In the formula just given, the area and the distance between plates were expressed in square inches and inches, respectively. With the area in square centimeters and the distance in centimeters, the numerical factor 0.0885 would be used instead of 0.2235.

CAPACITIVE REACTANCE

The capacitive reactance (X_c) of a capacitor is the opposition offered by the capacitor to the flow of AC. It can be determined by this formula:

$$X_c = \frac{1}{2\pi fC}$$

where,

X_c is the capacitive reactance in ohms,
 f is the frequency in hertz,
 C is the capacitance in farads,
 2π is equal to 6.28, a constant.

According to this relationship, the reactance varies inversely with frequency and capacitance. If either, or both, are increased, the reactance will decrease, and vice versa.

What is the reactance of a 0.05- μ F capacitor operating at 500 kHz?

$$X_c = \frac{1}{2\pi fC}$$

$$X_c = \frac{1}{6.28 \times 5 \times 10^5 \times 5 \times 10^{-8}}$$

$$X_c = \frac{1}{157 \times 10^{-3}} = \frac{1}{0.157}$$

$$X_c = 6.37 \text{ ohms}$$

We could solve the basic equation for frequency or capacitance:

$$X_c = \frac{1}{2\pi fC}$$

$$2\pi fCX_c = 1$$

$$f = \frac{1}{2\pi CX_c}$$

$$C = \frac{1}{2\pi fX_c}$$

A capacitor has a reactance of 75 ohms at a frequency of 600 kHz. What is the capacitance?

$$C = \frac{1}{2\pi fX_c}$$

$$C = \frac{1}{6.28 \times 6 \times 10^5 \times 75 \times 10^3}$$

$$C = \frac{1}{282.6 \times 10^6} = \frac{1}{0.2826 \times 10^9}$$

$$C = 3.54 \times 10^{-9} = 0.00354 \mu\text{F}$$

Solving for frequency would involve the same type of substitution and calculation. Going back to the original X_c formula we see that reactance varies inversely with frequency and capacitance. And from this we can obtain the following two relationships. With capacitance constant:

$$\frac{X_{c1}}{X_{c2}} = \frac{f_2}{f_1}$$

With frequency constant:

$$\frac{X_{c1}}{X_{c2}} = \frac{C_2}{C_1}$$

Let's see how these would be used.

1. A capacitor has a reactance of 200 ohms at 500 kHz. What is its reactance at 400 kHz?

$$\frac{X_{c1}}{X_{c2}} = \frac{f_2}{f_1}$$

$$\frac{200}{X_{c2}} = \frac{400,000}{500,000}$$

$$\frac{200}{X_{c2}} = \frac{4}{5}$$

$$4X_{c2} = 1000$$

$$X_{c2} = 250 \text{ ohms}$$

In other words, the reactance goes up by the same ratio that the frequency goes down.

2. At a certain frequency a capacitor has a reactance of 100 ohms. If the capacitance is tripled, what is its new reactance?

$$\frac{X_{c1}}{X_{c2}} = \frac{C_2}{C_1}$$

$$\frac{100}{X_{c2}} = \frac{3}{1}$$

In the above step, no matter what the capacitance values are, the ratio on the right will be reduced to 3 over 1:

$$3X_{c2} = 100$$

$$X_{c2} = 33.3 \text{ ohms}$$

SERIES CAPACITORS

When capacitors are connected in series, the voltage rating of the combination is equal to the sum of the voltage ratings of all the capacitors. For example, two 450-volt units in series



Figure 8-1. Schematic representation of capacitors in series.

would have a voltage rating of 900 volts. But the series connection causes the total capacitance to be smaller than the smallest of the group. And as the total capacitance is decreased, the total reactance is increased. For our calculations of actual values we will refer to the three-capacitor series circuit of Figure 8-1.

Total capacitance is calculated in the same way as parallel resistors, and the formula shown below can be applied for any number of capacitors.

$$C_t = \frac{1}{\frac{1}{C_1} + \frac{1}{C_2} + \frac{1}{C_3} + \dots}$$

where,

C_1 , C_2 , and C_3 are the individual capacitances,
 C_t is the total capacitance.

If two capacitors are connected in series, the total can be found by the "product-over-the-sum" method, as shown previously for two resistors in parallel:

$$C_t = \frac{C_1 C_2}{C_1 + C_2}$$

If all series capacitors have the same value, (C), it can be divided by the number of capacitors (N).

$$C_t = \frac{C}{N}$$

Sample Problems

1. Three capacitors, each rated at 8 μF , 450 volts, are connected in series. What is the total capacitance and the voltage rating of the combination?

$$C_t = \frac{C}{N} = \frac{8}{3} \text{ or } 2\frac{2}{3} \mu\text{F}$$

$$\text{Voltage rating} = 450 \times 3 = 1,350 \text{ volts.}$$

2. A 4- μF and an 8- μF capacitor are connected in series. What is the total capacitance?

$$C_t = \frac{C_1 C_2}{C_1 + C_2} = \frac{4 \times 8}{4 + 8} = \frac{32}{12} = 2.66 \mu\text{F}$$

3. Three capacitors, 2, 4, and 8 μF , are connected in series. What is the total capacitance?

$$C_t = \frac{1}{\frac{1}{C_1} + \frac{1}{C_2} + \frac{1}{C_3}}$$

$$C_t = \frac{1}{\frac{1}{2} + \frac{1}{4} + \frac{1}{8}} = \frac{1}{\frac{4 + 2 + 1}{8}}$$

$$C_t = \frac{1}{\frac{7}{8}} = \frac{8}{7} \text{ or } 1.14 \mu\text{F}$$

Capacitive reactances in series are calculated in the same manner as resistances in series—by adding them directly. The formula given here holds for any number in series:

$$X_{ct} = X_{c1} + X_{c2} + X_{c3} + \dots$$

For example, if three capacitors having reactances of 10, 15, and 20 ohms are connected in series, the total reactance is 10 + 15 + 20, or 45 ohms.

When voltage is applied across a group of series-connected capacitors, the circuit becomes a voltage divider. The voltage drop across each capacitor is then inversely proportional to its capacitance. As an example, let's use the circuit of Figure 8-2, where the separate capacitors are 2, 4, and 8 μF . Several methods can be used. Let's examine two of them.

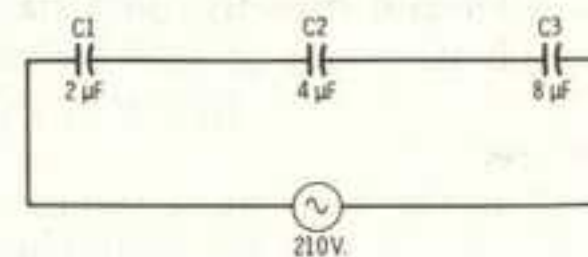

Figure 8-2. Capacitors in series, with an AC voltage applied to the combination.

If we let x equal the voltage across C_3 , then there must be $2x$ volts across C_2 , and $4x$ volts across C_1 . These three, added together, equal the supply voltage of 210 volts:

$$\begin{aligned}x + 2x + 4x &= 210 \\7x &= 210 \\x &= 30 \text{ volts}\end{aligned}$$

So there is 30 volts across C_3 , 60 volts across C_2 , and 120 volts across C_1 , adding up to a total of 210.

Or we can use this formula, which holds for any number of capacitors:

$$E_x = \frac{E_a \times C_t}{C_x}$$

where,

- E_x is the unknown voltage across a capacitor,
- E_a is the applied voltage,
- C_t is the total capacitance of the circuit,
- C_x is the capacitance across which the unknown voltage E_x appears (C_x and C_t should be expressed in the same units).

We can use this formula to solve the same problem, except that we must solve for the voltage across one of the capacitors. Let's solve for the voltage across C_2 , the $4\text{-}\mu\text{F}$ unit:

$$\begin{aligned}E_x &= \frac{E_a \times C_t}{C_x} \\E_x &= \frac{210 \times 1.143}{4} = \frac{240}{4} \\E_x &= 60 \text{ volts}\end{aligned}$$

which is the same answer obtained by the previous method.

PARALLEL CAPACITORS

Capacitors connected in parallel act like a single capacitor having a larger plate area. This means that capacitors in parallel add directly, just like series resistors. Any parallel combination can be solved from this equation:

$$C_t = C_1 + C_2 + C_3 + \dots$$

where,

- C_t is the total capacitance,
- C_1, C_2, C_3 are the individual capacitors.

For example, three capacitors, 500 pF, $.05 \mu\text{F}$, and $1.0 \mu\text{F}$, are connected in parallel. Find the total capacitance. We could convert them all to either μF (or pF) and then add as shown here:

$$500 \text{ pF} + .05 \mu\text{F} + 1.0 \mu\text{F}$$

Converting to μF

$$.0005 \mu\text{F} + .05 \mu\text{F} + 1.0 \mu\text{F} = 1.0505 \mu\text{F}$$

We can handle the addition in a number of other ways, such as placing all values in a column:

$$\begin{array}{r} .0005 \mu\text{F} \\ .05 \mu\text{F} \\ 1.0 \mu\text{F} \\ \hline 1.0505 \mu\text{F} \end{array}$$

Capacitive reactances in parallel are calculated in the same way as resistors in parallel, using any one of the following formulas:

$$X_{ct} = \frac{X_c}{N}$$

where,

- X_{ct} is the total capacitive reactance,
- X_c is the value of each reactance,
- N is the number of equal reactances in parallel.

Or:

$$X_{ct} = \frac{X_{c1} X_{c2}}{X_{c1} + X_{c2}}$$

The above formula is used when two reactances, X_{c1} and X_{c2} , are connected in parallel. For any number of two or more, the reciprocal formula shown next should be used:

$$X_{ct} = \frac{1}{\frac{1}{X_{c1}} + \frac{1}{X_{c2}} + \frac{1}{X_{c3}} + \dots}$$

We have already performed these calculations a number of times, so sample problems will be omitted.

The next type of problem often appears in the FCC examination. We have a number of $8\text{-}\mu\text{F}$ capacitors, each rated at 450 volts. How many would be required to make up a combination rated at $8 \mu\text{F}$ and 1,800 volts?

To obtain the 1,800-volt rating, four capacitors in series would be required, but the total capacitance of this combination is only 2 μF . So, to obtain 8 μF we would need four parallel branches, each containing four capacitors, for a total of 16 capacitors.

CHARGE AND ENERGY

The charge stored in a capacitor can be calculated by:

$$Q = CE$$

where,

Q is the charge in coulombs,
 C is the capacitance in farads,
 E is the applied voltage in volts.

As an example, 250 volts is applied across a 0.05- μF capacitor. The charge is:

$$\begin{aligned} Q &= CE \\ Q &= 5 \times 10^{-8} \times 2.5 \times 10^2 \\ Q &= 12.5 \times 10^{-6} \text{ coulombs} \end{aligned}$$

which could be expressed as 12.5 microcoulombs.

Using the formula $Q = CE$, solve this problem, being careful not to make a snap judgment as to the answer:

A 0.01- μF capacitor is charged to 200 volts, and the charging source is disconnected. An uncharged 0.01- μF capacitor is then connected in parallel with the charged capacitor. What will the voltage be across the combination?

The first capacitor was charged to 2 microcoulombs ($Q = CE$) and the charging source was disconnected. Adding the additional capacitor doubled the capacitance. So, with Q remaining the same the voltage is cut in half, to 100 volts. If the source had remained connected, then of course both capacitors would have charged to the source voltage.

We can rearrange the basic $Q = CE$ formula, if necessary, to produce these results:

$$C = \frac{Q}{E} \qquad E = \frac{Q}{C}$$

The energy stored in a capacitor can be calculated from this formula:

$$W = \frac{Q^2}{2C} = \frac{C^2 E^2}{2C} = \frac{CE^2}{2}$$

where,

W is the energy in joules,
 Q is the charge in coulombs,
 C is the capacitance in farads,
 E is the applied voltage in volts.

A 0.05- μF capacitor has 200 volts connected across it. How much energy is stored?

$$\begin{aligned} W &= \frac{CE^2}{2} \\ W &= \frac{5 \times 10^{-8} \times (2 \times 10^2)^2}{2} = \frac{5 \times 10^{-8} \times 4 \times 10^4}{2} \\ &= \frac{2.0 \times 10^{-3}}{2} = 1 \times 10^{-3} \text{ joule} \end{aligned}$$

To solve for C or E , with the other factors given:

$$W = \frac{CE^2}{2}$$

$$2W = CE^2$$

So:

$$C = \frac{2W}{E^2}$$

And:

$$2W = CE^2$$

$$E^2 = \frac{2W}{C}$$

So:

$$E = \sqrt{\frac{2W}{C}}$$

TIME CONSTANT

When DC is applied across an RC circuit, the capacitor requires a certain amount of time to charge to the supply voltage. This time is proportional to what is called the *time constant*. The time constant is equal to the resistance multiplied by capacitance:

$$TC = R \times C$$

where,

TC is the time constant in seconds,
 R is the resistance in ohms,
 C is the capacitance in farads.

The time constant is not the time required for full charge, but is the time required for the charge on the capacitor to reach approximately 63.2% of the available voltage. At the end of one time constant, a capacitor will have charged to 63.2% of the applied voltage. During the next time constant, the capacitor charges to 63.2% of the remaining voltage (36.8%), or to 86.5%. During the third time constant the additional charge is 63.2% of the remaining voltage (13.5%) or 95%, etc. Table 8-2 shows the percentages of full charge the capacitor has attained at the end of each time constant, while Figure 8-3 shows it graphically. For practical considerations the capacitor is assumed to be fully charged at the end of 5 RC time periods.

Discharge occurs at the same rate. At the end of 1 RC time, the capacitor has discharged 63.2% of its full charge and has 36.8% left. Table 8-2 also lists the remaining percentages of voltage at the end of 1 through 5 RC times of discharge.

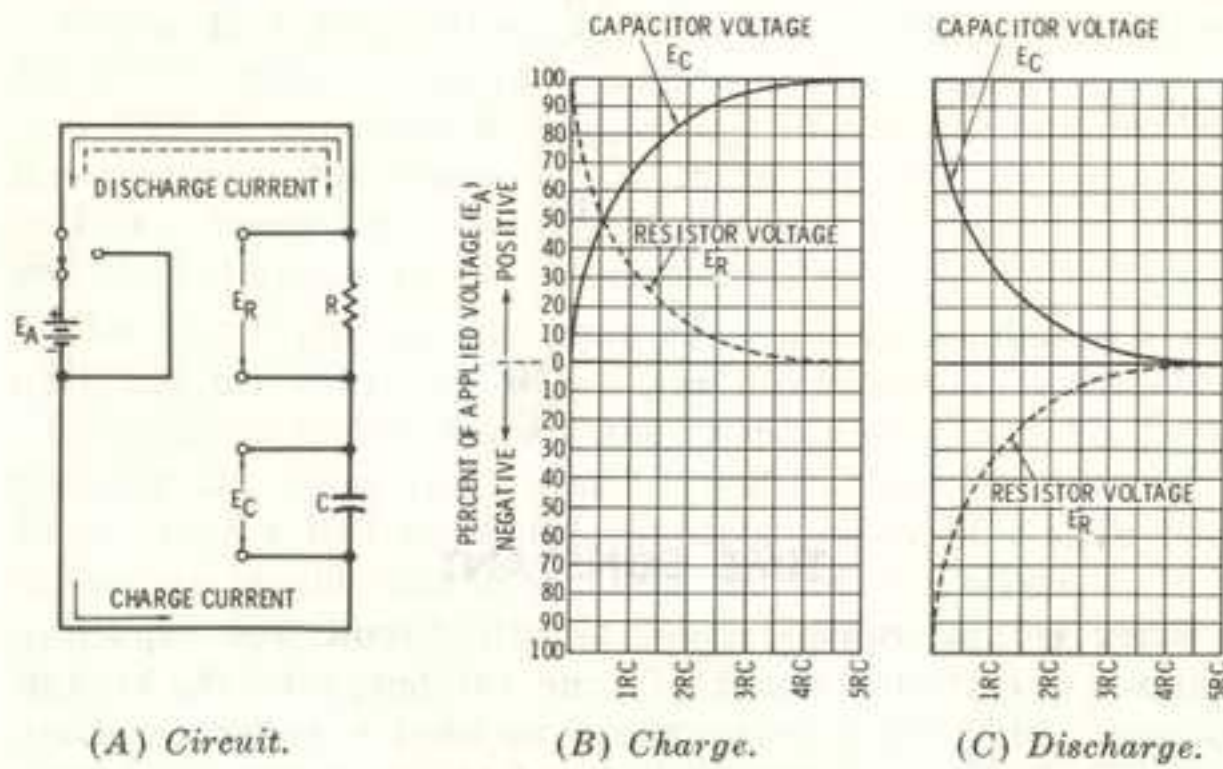

(A) Circuit.

(B) Charge.

(C) Discharge.

Figure 8-3. Charge and discharge curves of an RC combination, showing the voltage distribution across the capacitor and resistor at different RC times. Notice that on discharge, the polarity of voltages across the resistor is opposite that during charge.

Table 8-2. Percentage of Voltage Across a Capacitor in an RC Circuit At the End of Certain RC Time Constants

No. of RC Times	% of Applied Voltage During Charge	% of Applied Voltage During Discharge
1	63.2	36.8
2	86.5	13.5
3	95.0	5.0
4	98.2	1.8
5	99.3	0.7

As R or C , or both, are increased so is the time constant. This causes the capacitor to take a longer time to charge or discharge. When charging, the sum of E_c and E_r , at any instant of time is always equal to the applied voltage. On discharge, at any instant E_c and E_r are equal, but opposite in polarity, to each other. Hence their sum is always zero (See Figure 8-3).

A $.05\text{-}\mu\text{F}$ capacitor is connected in series with a 500,000-ohm resistor. Find the time constant and the voltage across the capacitor for 1 through 5 time constants of charge. The applied voltage is 200.

$$TC = RC = 5 \times 10^{-8} \times 5 \times 10^5 = 2.5 \times 10^{-2} \text{ second.}$$

For charging:

- At 1 time constant, $E_c = 63.2\%$ of 200 = 126.4 volts
- At 2 time constants, $E_c = 86.5\%$ of 200 = 173 volts
- At 3 time constants, $E_c = 95\%$ of 200 = 190 volts
- At 4 time constants, $E_c = 98.2\%$ of 200 = 196.4 volts
- At 5 time constants, $E_c = 99.3\%$ of 200 = 198.6 volts

RESONANCE

Circuits are said to be *resonant* when the capacitive and inductive reactances in the circuit are equal. This principle is used in many electronics applications. As frequency is increased from zero, the inductive reactance in a circuit also increases but the capacitive reactance decreases. At some frequency the reactances will be equal—this point being termed the resonant frequency. As long as this condition occurs at only one frequency, an *LC* circuit becomes discriminatory and its behavior depends on whether the reactive components are connected in series or in parallel.

SERIES RESONANCE

When X_c equals X_L in a series *LC* circuit, the circuit is series-resonant. However, any circuit contains at least a small amount of resistance. So, in discussing resonance we must assume that resistance is also present. We can calculate the resonant frequency by determining that frequency which causes the reactances to be equal. The formula is developed as shown:

$$\text{Since: } X_L = X_c$$

$$\text{Then: } 2\pi fL = \frac{1}{2\pi fc}$$

$$\text{And: } 4\pi^2 f^2 LC = 1$$

$$f^2 = \frac{1}{4\pi^2 LC}$$

$$f = \frac{1}{2\pi\sqrt{LC}}$$

where frequency, inductance, and capacitance are expressed in basic units—hertz, henrys, and farads, respectively.

Suppose that a series circuit, as shown in Figure 9-1 consists of a 20-ohm resistor, a 50- μ H inductor and a 250-pF capacitor. Solve for the resonant frequency.

$$\begin{aligned} f &= \frac{1}{2\pi\sqrt{LC}} \\ &= \frac{1}{6.28\sqrt{5 \times 10^{-5} \times 25 \times 10^{-11}}} \\ &= \frac{1}{6.28\sqrt{125 \times 10^{-16}}} \\ &= \frac{1}{6.28 \times 11.18 \times 10^{-8}} \\ &= \frac{10^8}{70.21} \\ &= \frac{10^8}{.7021 \times 10^2} \\ &= 1.424 \times 10^6 = 1,424 \text{ kilohertz} \end{aligned}$$

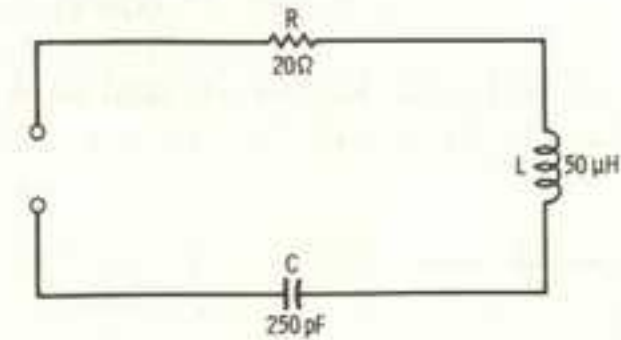

Figure 9-1. A series RLC circuit.

By use of basic algebra we can also solve the resonance equation for either *L* or *C* when frequency is known:

$$\text{Since: } f = \frac{1}{2\pi\sqrt{LC}}$$

$$\text{Then: } 2\pi f\sqrt{LC} = 1$$

$$\text{And: } 4\pi^2 f^2 LC = 1$$

$$\text{Therefore: } L = \frac{1}{4\pi^2 f^2 C}$$

$$\text{Or: } C = \frac{1}{4\pi^2 f^2 L}$$

At series-resonance the reactances effectively cancel each other and the following conditions exist:

1. Circuit impedance is minimum and is equal to the circuit resistance. Effective reactance is zero.

2. Current is maximum since impedance is minimum.
3. The phase angle is 0° , and the power factor is 1.
4. Each of the reactive voltages may be much larger than the applied voltage.

In the circuit of Figure 9-2, solve for Z , I , E_r , E_L , and E_c :

$$Z = \sqrt{R^2 + X^2}$$

$$= \sqrt{10^2 + (500-500)^2} = 10 \text{ ohms, the same as } R$$

$$I = \frac{E_a}{Z}$$

$$= \frac{20}{10} = 2 \text{ amps}$$

$$E_r = I \times R$$

$$= 2 \times 10 = 20 \text{ volts, same as } E_a$$

$$E_L = I \times X_L$$

$$= 2 \times 500 = 1,000 \text{ volts}$$

$$E_c = I \times X_c$$

$$= 2 \times 500 = 1,000 \text{ volts}$$

Previously Q was defined as X_L/R so in the circuit of Figure 9-2 the Q equals 50. In a series-resonant circuit the voltage

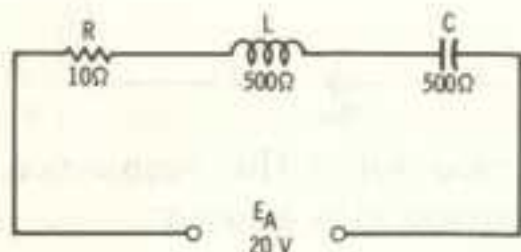

Fig. 9-2. A series-resonant circuit.

across either reactive component can be found from the formula:

$$Q \times E_a = E_L = E_c$$

Therefore in the circuit just discussed, E_L or $E_c = 50 \times 20$, or 1,000 volts.

PARALLEL RESONANCE

Several conditions can be used in defining parallel resonance. These are listed as follows:

1. Inductive reactance equals capacitive reactance.

2. Circuit impedance is maximum, resulting in minimum line current.
3. The circuit will be resistive, having unity power factor.

If a zero-resistance tank circuit could be designed, all these conditions would occur at the same frequency. However, every LC circuit has some resistance, mostly in the inductive branch. Even so, if the resistance is small, all these conditions will occur at approximately the same frequency. Tank circuits are usually designed for high Q (having low resistance). Hence we can use the resonance formula already given for series circuits:

$$f = \frac{1}{2\pi\sqrt{LC}}$$

At parallel resonance, the following conditions occur (Figure 9-3 will be our reference circuit):

1. Circuit impedance between points A and B is *maximum*; therefore the line current is *minimum*.
2. Opposition within the tank is *minimum* because the effective reactance is zero. This means the circulating tank current is *maximum*.
3. The circuit acts resistive, the power factor is approximately 1, and the phase angle is nearly 0° , as long as the resistance is negligible.

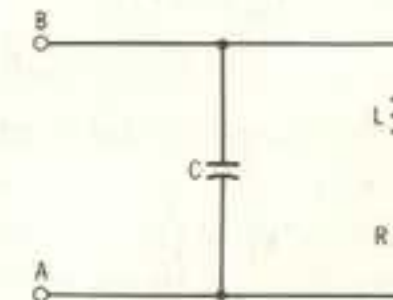

Figure 9-3. A parallel circuit, illustrating the effect at its resonant frequency.

Using Figure 9-3 again as our reference, the impedance presented by the tank at resonance can be considered as:

$$Z = \frac{X_L^2}{R} = \frac{L}{RC}$$

where all electrical characteristics are stated in basic units. We could substitute X_c for X_L , because the basic condition for

resonance is that the reactances be equal. Impedance can also be stated as:

$$Z = X_L \times Q = X_C \times Q$$

Suppose these conditions exist in our reference circuit; $L = 40 \mu\text{H}$, $C = 80 \text{ pF}$, and $R = 10 \text{ ohms}$. Solve for the resonant frequency and the circuit impedance at resonance:

$$\begin{aligned} f &= \frac{1}{2\pi\sqrt{LC}} \\ &= \frac{1}{6.28\sqrt{4 \times 10^{-5} \times 8 \times 10^{-11}}} \\ &= \frac{1}{6.28\sqrt{32 \times 10^{-16}}} \\ &= \frac{1}{6.28 \times 5.66 \times 10^{-8}} \\ &= \frac{1}{.3554 \times 10^{-6}} = 2.81 \times 10^6 = 2.81 \text{ MHz} \\ Z &= \frac{L}{RC} \\ &= \frac{4 \times 10^{-5}}{1 \times 10 \times 8 \times 10^{-11}} = \frac{4 \times 10^{-5}}{8 \times 10^{-10}} \\ &= 0.5 \times 10^5 = 50,000 \text{ ohms} \end{aligned}$$

Checking:

$$\begin{aligned} X_L &= 2\pi fL \\ &= 6.28 \times 2.81 \times 10^6 \times 4 \times 10^{-5} \\ &= 705.9 \text{ ohms} \\ Q &= \frac{X_L}{R} \\ &= \frac{705.9}{10} = 70.59 \\ Z &= X_L \times Q \\ &= 705.9 \times 70.59 \\ &= 49,829 \text{ ohms} \end{aligned}$$

The slight error results from rounding off the resonant frequency; actually it is slightly higher than 2.81 megahertz.

According to the formula, the resonant frequency depends on the product of L times C and not on the individual values. In the example problem just worked, the fact that $L = 40 \mu\text{H}$ and $C = 80 \text{ pF}$, made this circuit resonant at slightly over 2.81 megahertz. If instead $L = 20 \mu\text{H}$ and $C = 160 \text{ pF}$, the resonant frequency would be the same. In the latter example we have halved L and doubled C , leaving the LC product at the same value. In fact many combinations of L and C would produce the same product and hence the same resonant frequency. Connecting a resistance across a parallel- LC circuit loads down that circuit by decreasing the Q . This lowers the impedance of the circuit, but broadens the band of frequencies the circuit can pass. The resistor, however, has no effect on the resonant frequency.

DECIBELS

The decibel (dB) is the basic unit for measuring the difference between two levels of sound. It is a nonlinear function based on logarithms, just as human hearing is nonlinear, or logarithmic, in nature. The human ear cannot determine actual sound levels, but can detect *differences* in levels provided they are not too small.

There is no such thing as zero sound. Hence any absolute measurement is impossible. Therefore we measure the level of a particular sound with respect to some other level as a reference. The decibel, then, expresses numerically the ratio of a particular sound level to a certain reference level.

Let's see how the fact that our hearing is logarithmic affects our sense of volume. If a sound level is increased from 1 to 2 watts (using an electrical quantity), the difference (or change) in the level, as interpreted by our ears, will seem to be the same amount of change as an increase from 2 to 4 watts, or from 5 to 10 watts. The latter ratings are certainly greater changes in power than our first example and will sound louder, but in each case the change in levels will seem identical to our ears. The power was doubled in each of the examples given and each of these changes is represented by the same number of decibels. So each change seemed to be the same, although the difference in power in each example was not.

resonance is that the reactances be equal. Impedance can also be stated as:

$$Z = X_L \times Q = X_C \times Q$$

Suppose these conditions exist in our reference circuit; $L = 40 \mu\text{H}$, $C = 80 \text{ pF}$, and $R = 10 \text{ ohms}$. Solve for the resonant frequency and the circuit impedance at resonance:

$$\begin{aligned} f &= \frac{1}{2\pi\sqrt{LC}} \\ &= \frac{1}{6.28\sqrt{4 \times 10^{-5} \times 8 \times 10^{-11}}} \\ &= \frac{1}{6.28\sqrt{32 \times 10^{-16}}} \\ &= \frac{1}{6.28 \times 5.66 \times 10^{-8}} \\ &= \frac{1}{.3554 \times 10^{-6}} = 2.81 \times 10^6 = 2.81 \text{ MHz} \\ Z &= \frac{L}{RC} \\ &= \frac{4 \times 10^{-5}}{1 \times 10 \times 8 \times 10^{-11}} = \frac{4 \times 10^{-5}}{8 \times 10^{-10}} \\ &= 0.5 \times 10^5 = 50,000 \text{ ohms} \end{aligned}$$

Checking:

$$\begin{aligned} X_L &= 2\pi fL \\ &= 6.28 \times 2.81 \times 10^6 \times 4 \times 10^{-5} \\ &= 705.9 \text{ ohms} \\ Q &= \frac{X_L}{R} \\ &= \frac{705.9}{10} = 70.59 \\ Z &= X_L \times Q \\ &= 705.9 \times 70.59 \\ &= 49,829 \text{ ohms} \end{aligned}$$

The slight error results from rounding off the resonant frequency; actually it is slightly higher than 2.81 megahertz.

According to the formula, the resonant frequency depends on the product of L times C and not on the individual values. In the example problem just worked, the fact that $L = 40 \mu\text{H}$ and $C = 80 \text{ pF}$, made this circuit resonant at slightly over 2.81 megahertz. If instead $L = 20 \mu\text{H}$ and $C = 160 \text{ pF}$, the resonant frequency would be the same. In the latter example we have halved L and doubled C , leaving the LC product at the same value. In fact many combinations of L and C would produce the same product and hence the same resonant frequency. Connecting a resistance across a parallel- LC circuit loads down that circuit by decreasing the Q . This lowers the impedance of the circuit, but broadens the band of frequencies the circuit can pass. The resistor, however, has no effect on the resonant frequency.

DECIBELS

The decibel (dB) is the basic unit for measuring the difference between two levels of sound. It is a nonlinear function based on logarithms, just as human hearing is nonlinear, or logarithmic, in nature. The human ear cannot determine actual sound levels, but can detect *differences* in levels provided they are not too small.

There is no such thing as zero sound. Hence any absolute measurement is impossible. Therefore we measure the level of a particular sound with respect to some other level as a reference. The decibel, then, expresses numerically the ratio of a particular sound level to a certain reference level.

Let's see how the fact that our hearing is logarithmic affects our sense of volume. If a sound level is increased from 1 to 2 watts (using an electrical quantity), the difference (or change) in the level, as interpreted by our ears, will seem to be the same amount of change as an increase from 2 to 4 watts, or from 5 to 10 watts. The latter ratings are certainly greater changes in power than our first example and will sound louder, but in each case the change in levels will seem identical to our ears. The power was doubled in each of the examples given and each of these changes is represented by the same number of decibels. So each change seemed to be the same, although the difference in power in each example was not.

Doubling the power causes the sound to be louder, but definitely not twice as loud, as might be supposed. This is due to the logarithmic characteristic, which can be explained in still another way. A small change of volume may be noticeable at low levels, but not be noticeable at all for higher levels. As an example, a change from 1 watt to 2 watts would be noticed by most people. A change from 19 watts to 20 watts however, would not be noticed at all, even though the actual change in power (1 watt) is the same in both instances. Thus we hear changes with respect to the ratio of the levels involved, rather than hearing any certain degree of change.

As long as the decibel specifies no definite signal level we say that it is a relative unit, and the numerical value of these units depends on the ratio of the two levels—not the numerical difference between them. The average ear can detect signal level changes of about 1 dB for a single tone, and about 3 dB for mixed signals such as voice or music.

The original unit used for the measurement of sound was the *bel*, the number of bels being equal to the log of the ratio of the power of two sound sources. This was too large a unit so it was divided into ten parts, each called a *decibel*. Numerically the number of decibels can be determined by the following formula:

$$\text{dB} = 10 \log \frac{P_1}{P_2}$$

where P_1 and P_2 are the two levels of power, P_1 being the larger.

If the impedances across which the signals are measured are equal, the following relationships for voltage or current also hold true:

$$\text{dB} = 20 \log \frac{E_1}{E_2}$$

$$\text{dB} = 20 \log \frac{I_1}{I_2}$$

The first two are used to a much larger extent than the current formula, although the latter is just as applicable. A couple of problems will illustrate how these formulas are used.

1. The input and output signal voltages of an amplifier are 3 and 48 volts respectively. What is the decibel gain?

$$\text{dB} = 20 \log \frac{E_1}{E_2}$$

$$\text{dB} = 20 \log \frac{48}{3}$$

$$\text{dB} = 20 \log 16$$

$$\text{dB} = 20(1.2041) = 24.082 \text{ dB}$$

The output signal is 24 dB above the input level or, conversely, the input level is 24 dB below the output.

2. A transmission line has an input of 1,200 watts and an output of 1,000 watts. What is the dB loss in the line?

$$\text{dB} = 10 \log \frac{P_1}{P_2}$$

$$\text{dB} = 10 \log \frac{1200}{1000}$$

$$\text{dB} = 10 \log 1.2$$

$$\text{dB} = 10(.0792) = 0.792 \text{ dB}$$

Notice that in both examples the larger number of the ratio was made the numerator of the fraction. This was done to simplify the calculations, because then all the ratios are larger than 1, giving positive logarithms in all cases.

The subject of decibels is useful in a study of amplifiers, since they are quite often used in describing amplifier gain or loss. However, they can be applied to microphones, recorders, transmitters, filters, attenuation networks, transmission lines, or any other signal-handling device.

Zero Level

Actual output signal levels of various types of equipment such as microphones, amplifiers, etc., are often expressed in dBs. The dB level is rated against some power level as a zero reference. Various zero references have been used, with 6 milliwatts probably being the most prevalent. In many usages the *VU* (volume unit) is preferred instead of the decibel. It is exactly the same as the dB except that the *VU* is always referred to a specific zero-reference level of 1 milliwatt as read across 600 ohms. When expressing a certain number of decibels we are not sure what the zero level is unless it is specified.

Solving a problem involving the zero level is the same as already shown except the zero level is one of the figures in the ratio. For example, if zero decibels is assumed to be 6 milliwatts, what db level is 600 milliwatts?

$$\begin{aligned} \text{dB} &= 10 \log \frac{600}{6} \\ \text{dB} &= 10 \log 100 \\ \text{dB} &= 10(2) = +20 \text{ dB} \end{aligned}$$

Using the same reference, what is the dB rating for 3 milliwatts?

$$\begin{aligned} \text{dB} &= 10 \log \frac{3}{6} \\ \text{dB} &= 10 \log 2 \\ \text{dB} &= 10(.301) = -3.01 \text{ dB} \end{aligned}$$

In the latter solution we set the larger power as the numerator of the fraction, but affixed a negative sign to the answer. This was necessary because 3 milliwatts is *below* the zero-dB reference level. If we invert the ratio, as shown next, the answer comes out as a negative number:

$$\begin{aligned} \text{dB} &= 10 \log \frac{3}{6} \\ \text{dB} &= 10 \log .5 \\ \text{dB} &= 10(.6990-1) \\ \text{dB} &= 6.990-10 = -3.01 \text{ dB} \end{aligned}$$

What *VU* level is represented by 6 milliwatts? In this problem zero *VU* is assumed, as always, to be 1 milliwatt. The problem is set up as follows:

$$\begin{aligned} \text{VU} &= 10 \log \frac{P_1}{P_2} \\ \text{VU} &= 10 \log \frac{6}{1} \\ \text{VU} &= 10(.7782) = 7.782 \text{ VU} \end{aligned}$$

Inverse Problems

The same formulas are used for solving inverse dB problems—that is, when the dB level and one signal level are given

and we must find the other level. Such solutions all follow a definite pattern, as shown in the next problem.

An amplifier output-signal voltage is 60 volts and the stage raises the signal level by 15 dB. What is the input signal?

$$\begin{aligned} \text{dB} &= 20 \log \frac{E_1}{E_2} \\ 15 &= 20 \log \frac{60}{E_2} \end{aligned}$$

Dividing both sides by 20:

Then:

$$.75 = \log \frac{60}{E_2}$$

Taking the antilog of both sides:

$$\begin{aligned} 5.62 &= \frac{60}{E_2} \\ 5.62E_2 &= 60 \\ E_2 &= \frac{60}{5.62} = 10.68 \text{ volts} \end{aligned}$$

The steps are as follows:

1. Substitute the known values into the proper dB formula, using 20 as a multiplier for voltage or current, and 10 as a multiplier for power.
2. Divide both sides of the equation by either 10 or 20, whichever is used.
3. Take the antilog of both sides.
4. Solve the equation by the methods described in Chapter 3.

Let's try another problem, using this outline. The numbers of the various lines correspond to the previous step numbers. A transmitter output is increased by 20 dB, the original output being 100 watts. What is the new level?

$$\text{dB} = 10 \log \frac{P_1}{P_2}$$

1. $20 = 10 \log \frac{P_1}{100}$

2. $2.0 = \log \frac{P_1}{100}$
3. $100 = \frac{P_1}{100}$
4. $P_1 = 10,000$ watts

Successive Stages

Decibels are additive (or subtractive) when applied to successive stages. Consider the block diagram of Figure 9-4, where the output of the microphone is -50 dB and the volume control loss is 5 dB, leaving an input to the preamp, of -55 dB. The preamp gain is 35 dB, so its output is at a -20 dB-level, while the amplifier adds 25 dB, making its output $+5$ dB. This



Figure 9-4. Block diagram of an amplifier, showing dB losses and gains.

makes the total dB gain, from microphone to amplifier output, 55 dB ($35 + 25 - 5$). Successive voltage gains, however, are multiplied as shown previously, so are different from dBs in that respect.

What is the combined voltage gain of the two amplifiers of the previous problem?

Since both stages have a total dB gain of 60 , the problem is set up with gain (A_v) being the ratio between the two voltages.

$$\begin{aligned} \text{dB} &= 20 \log A_v \\ 60 &= 20 \log A_v \\ 3 &= \log A_v \end{aligned}$$

Taking the antilog:

$$A_v = 1,000$$

So the total voltage gain is $1,000$, corresponding to a dB gain of 60 .

BOOK REVIEW QUIZ

CHAPTER 1

1. State the rule for converting a number larger than 1 to its scientific notation form.
2. State the rule for converting a number smaller than 1 to its scientific notation form.
3. Express each of the following numbers in scientific notation form.
 - a. 285
 - b. 0.0354
 - c. 8,200,000
 - d. 0.000064
 - e. 35
- In problems 4 through 8, express all answers as numbers between 1 and 10, multiplied by a power of 10.
4. $8.2 \times 10^3 \times 6 \times 10^2 =$
5. $1.2 \times 10^4 \div 2.4 \times 10^3 =$
6. $1942 \times 10^{-2} \times 0.0515 \times 10^2 =$
7. $\sqrt{640,000} =$
8. $(2.6 \times 10^{-3})^2 =$
9. Convert 5 megahertz to kilohertz.
10. Convert 2.5 microfarads to picofarads.

CHAPTER 2

1. $3x^2y + 4xy^2 - 2x^2y + xy^2 =$
2. $(x - y)(x^2 + y^2) =$
3. $\frac{-15x^2y^3}{-5x^2y} =$
4. Factor $9a^2b^2 - 15a^2b^3$
5. $6y + 15 = 2y + 7$. Solve for y .
6. $N = \frac{2S}{A + L}$ Solve for L .
7. $\sqrt{2A^2} = 4$ Solve for A .
8. $P = \frac{E^2}{R}$ Solve for E .

CHAPTER 3

1. What is the effect on the current in a series circuit if the voltage is doubled and the resistance halved? What if the voltage is tripled and the resistance is tripled?
2. A 20-ohm resistor and an 80-ohm resistor are in parallel across a 64-volt source. What current is drawn from the source?
3. What is the total current in the circuit of Figure 10-1? What is the current through R1?

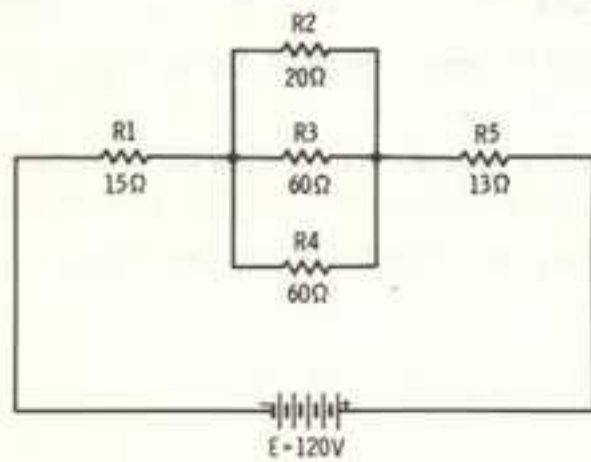

Figure 10-1. Circuit for Question 3.

4. The resistance of a circuit is halved. What is the effect on power if the voltage remains the same?
5. The voltage applied to a circuit is doubled. What effect does this have on the power dissipated?
6. A resistor has 25 volts across it and a current of 20 mA through it. How much power must it dissipate?
7. A heating device is rated at 120 volts and has a resistance of 20 ohms. What is its power dissipation?
8. Two 500-ohm, 10-watt resistors are connected in parallel. What is the total power-dissipation capability of the circuit?

CHAPTER 4

1. What is the resistance of a copper wire that has a length of 30 feet and a diameter of 15 mils?
2. A conductor has a resistance of 250 ohms. If the length is doubled and the diameter halved, what is its new resistance?
3. If the diameter of a conductor is tripled, how is the resistance affected?
4. What is the total resistance of five 2000-ohm resistors connected in parallel?
5. A parallel combination of resistors is made up of a 50-ohm, a 150-ohm, and a 200-ohm resistor. What is the resistance of the combination?
6. Two parallel resistors have a total resistance of 750 ohms. One of the resistors is 1000 ohms. What is the value of the other?

7. Resistances of 4, 8, and 12 ohms are connected in parallel. What is the total resistance?
8. A circuit has a resistance of 250 ohms. What is the conductance?

CHAPTER 5

1. Convert 117 volts rms to peak volts. *Peak = 1.414 × 117 = 164.97*
2. A circuit contains 3 ohms of resistance, 7 ohms of inductive reactance, and 5 ohms of capacitive reactance. What is the circuit impedance? The phase angle?
3. With 24 volts applied to the circuit of Question 2, what will the circuit current be?
4. In a series RL circuit, the impedance is 15 ohms and the inductive reactance is 10 ohms. Find the value of R.
5. A series LCR circuit has an impedance of 12 ohms, a resistance of 6 ohms, and an inductive reactance of 3 ohms. What is the capacitive reactance?
6. A 3-branch parallel circuit has 8 ohms of resistance, 12 ohms of inductive reactance, and 6 ohms of capacitive reactance. What is the impedance of the circuit?
7. What is the phase angle in the circuit of Question 6?
8. If 24 volts is applied to the circuit, what is the current?

CHAPTER 6

1. A broadcast station has a carrier frequency of 650 kilohertz. What is its wavelength in meters?
2. What is the wavelength in feet of a 2200-kHz signal?
3. A signal has a wavelength of 2 feet. What is its frequency?
4. What is the period of a 4-megahertz signal?
5. Each cycle of a certain signal has a duration of 250 microseconds. What is the frequency?
6. A signal has a period of 25 nanoseconds. What is the wavelength in centimeters?
7. The wavelength of certain X rays is 3×10^{-7} millimeters. What is the frequency in terahertz? (See list of prefixes in Chapter 1.)

CHAPTER 7

1. The core permeability of a 1-henry coil is quadrupled. What is the new inductance of the coil?
2. A 200-turn coil has an inductance of 250 millihenrys. What is the inductance if the number of turns is increased to 250?
3. What is the inductive reactance of a 250- μ H coil to a 300-kHz signal?
4. Three coils are connected in series, with no mutual coupling. If their inductances are 1 henry, 500 millihenrys, and 1000 microhenrys, what is the total inductance of the combination?

5. Two coils have a total inductance of 12 henrys when connected series-aiding and 8 henrys when connected series-opposing. What is the mutual inductance between them?
6. The inductive reactance of a coil is 1500 ohms and its effective resistance is 50 ohms. What is its Q?
7. What is the time constant of a circuit containing a 5-henry coil in series with 2000 ohms of resistance?
8. A step-down transformer having a 6-to-1 turns ratio is operated with a primary voltage of 220 volts. What is the secondary voltage?

CHAPTER 8

1. If the distance between the plates of a capacitor is halved, how will this affect the capacitance?
2. A .05- μ F capacitor has a reactance of 60 ohms to an applied signal. What is the frequency of the signal?
3. At 600 kHz a capacitor has a reactance of 150 ohms. What is the capacitance?
4. A 16- μ F capacitor is connected in series with a 4- μ F unit. What is the total capacitance of the combination?
5. Three capacitors, 8, 12, and 16 μ F, are connected in series. Find the total capacitance.
6. If 300 volts is connected across the series combination in the preceding questions, what is the voltage across the 12- μ F capacitor?
7. Three capacitors having reactances of 12, 24, and 36 ohms are connected in parallel. What is their total reactance?
8. Four parallel capacitors of equal capacitance have a total reactance of 80 ohms. What is the reactance of each?

CHAPTER 9

1. What is the resonant frequency of a series circuit consisting of an inductance of 100 μ H, a capacitance of 300 pF, and a resistance of 10 ohms?
2. What effect would increasing the resistance in Question 1 have on the resonant frequency? What effect would it have on the Q?
3. If 100 volts is applied to the circuit described in Question 1, what voltage drops would be developed across R, L, and C?
4. What value of capacitance is needed to resonate with an inductance of 200 μ H at 600 kHz?
5. What is the total effective reactance in the tank circuit of a parallel-resonant circuit?
6. Considering the circuit of Question 4 as a parallel-resonant circuit, find its impedance. The parallel resistance is equal to 10 ohms.
7. State the formula for the dB ratio between two voltage levels.
8. What is the zero reference level for the volume unit (VU)?

APPENDIX

FRACTIONAL INCH, DECIMAL, AND MILLIMETER EQUIVALENTS

Fractional Inch	Decimal Inch	Millimeter Equivalent	Fractional Inch	Decimal Inch	Millimeter Equivalent
1/64	0.0156	0.396	33/64	0.5156	13.096
1/32	0.0313	0.795	17/32	0.5313	13.495
3/64	0.0469	1.191	9/16	0.5469	13.891
1/16	0.0625	1.587	35/64	0.5625	14.287
5/64	0.0781	1.983	37/64	0.5781	14.683
3/32	0.0938	2.382	19/32	0.5938	15.082
7/64	0.1094	2.778	39/64	0.6094	15.478
1/8	0.1250	3.175	5/8	0.6250	15.875
9/64	0.1406	3.571	41/64	0.6406	16.271
5/32	0.1563	3.970	21/32	0.6563	16.670
11/64	0.1719	4.365	43/64	0.6719	17.066
3/16	0.1875	4.762	11/16	0.6875	17.462
13/64	0.2031	5.158	45/64	0.7031	17.858
7/32	0.2188	5.557	23/32	0.7188	18.257
15/64	0.2344	5.963	47/64	0.7344	18.653
1/4	0.2500	6.350	3/4	0.7500	19.050
17/64	0.2656	6.746	49/64	0.7656	19.446
9/32	0.2813	7.145	25/32	0.7813	19.845
19/64	0.2969	7.541	51/64	0.7969	20.241
5/16	0.3125	7.937	13/16	0.8125	20.637
21/64	0.3281	8.333	53/64	0.8281	21.033
11/32	0.3438	8.732	27/32	0.8438	21.432
23/64	0.3594	9.128	55/64	0.8594	21.828
3/8	0.3750	9.525	7/8	0.8750	22.225
25/64	0.3906	9.921	57/64	0.8906	22.621
13/32	0.4063	10.320	29/32	0.9063	23.020
27/64	0.4219	10.716	59/64	0.9219	23.416
7/16	0.4375	11.113	15/16	0.9375	23.812
29/64	0.4531	11.508	61/64	0.9531	24.208
15/32	0.4688	11.907	31/32	0.9688	24.607
31/64	0.4844	12.303	63/64	0.9844	25.003
1/2	0.5000	12.700	1	1.000	25.400

INDEX

A

AC
 average values, 51-52
 circuits, 53-54
 effective values, 52-53
 power, 62-63
 Addition and subtraction
 of algebraic terms, 22
 powers of ten, 9-10
 Algebraic expression, 21
 Algebraic terms
 addition and subtraction, 22
 multiplication and division, 23-28
 Ampere, 13
 Apparent power, 63
 Average values, AC, 51-52

B

Base, 21
 Binomial, 21

C

Capacitance, 82-93
 factors affecting, 82-83
 Capacitive reactance, 83-85
 Capacitors
 parallel, 88-90
 series, 86-88
 Charge and energy, 90-91
 Circuits
 AC, 53-54
 parallel, 60-62
 series, 55-59
 Coefficient, 21
 Combinations, inductive, 73-76
 Combining terms, 22-27
 Conductance, 48-49
 Constants
 dielectric, 83
 resistivity, 43
 time, 77-78, 91-93
 Converting numbers to powers of ten, 8-9
 Coulomb, 13
 Cycle, 14

D

Decibels, 99-101
 Dielectric constants, 83
 Difference, 19
 Division, powers of ten, 11-12

E

Effective values, AC, 52-53
 Efficiency, transformer, 80-81
 Energy and Q, 76-77
 Equations, 28-33
 fractional, 31-33
 literal, 30-31
 with radicals, 33
 Exponent, 21
 Expression, algebraic, 21

F

Factoring, 28
 Factor, power, 63
 Factors affecting capacitance, 82-83
 Farad, 14
 Formulas
 AC
 average value of, 52
 effective value of, 52
 peak and instantaneous values, 59
 capacitance, 82-83
 capacitive reactance, 83-84
 charge on a capacitor, 90-91
 conductance, 48
 decibel, 100
 energy, 42
 stored in a coil, 76
 impedance
 parallel circuit, 60
 series circuit, 55
 ratio of a transformer, 79
 inductance, 70
 inductive reactance, 71
 in series, 75
 mutual inductance, 73-75
 parallel
 capacitors, 88
 resistors, 45-46
 resonance, 97
 period, 69
 power, 39
 power factor, 63
 Q of a coil, 76-77
 resistance
 of wire, 43
 parallel circuits, 35
 series circuit, 34
 series
 capacitors, 86
 resistors, 44-45
 resonance, 94
 time constant, 77, 91-92
 transformer efficiency, 80-81
 voltage, 35
 wavelength, 67
 Fractional equations, 31-33
 Frequency, 66-69

H

Henry, 14
 Horsepower, 14

I

Inductance, 70-81
 mutual, 73-76
 Inductive reactance, 71-72
 Inductor combinations, 73-76
 Inverse problems, 102-104

J

Joule, 14

L

Lambda, 67
 Literal equations, 30-31
 Lagging voltage, 53
 Leading voltage, 53
 Length, units of, 15
 Level, zero, 101-102
 Like terms, 21

M

Measurement, units of, 13-17
 Mho, 13
 Monomial, 21
 Multiplication and division of algebraic
 terms, 23-28
 Multiplication, powers of ten, 10-11
 Mutual inductance, 73

N

Negative numbers, 18-20
 Negative power of ten, 9

O

Ohm, 13
 Ohm's law
 parallel circuits, 35-36
 power, 39-42
 series circuit, 34-35
 series-parallel circuits, 36-38

P

Parallel
 capacitors, 88-90
 circuits, 60-62
 Ohm's law for, 35-36
 resistors, 45
 resonance, 96-99
 Permeability, 70
 Polynomial, 21
 Positive power of ten, 9
 Power
 AC, 62-63
 and energy, 14
 apparent, 63
 factor, 63
 Ohm's law for, 39-42
 true, 63
 Powers of ten, 7
 addition and subtraction, 9-10
 division of, 11-12
 multiplication of, 10-11
 reciprocals of, 12
 squares and square roots of, 12
 Prefixes, 15-17

R

Reactance
 capacitive, 83-85
 inductive, 71-72
 Reactive units, 14-15
 Reciprocals, powers of ten, 12
 Resistivity constants, 43
 Resistors
 parallel, 45
 series, 44-45
 Resonance
 parallel, 96-99
 series, 94-96
 Review quiz, 105-109

S

Series
 capacitors, 86-88
 circuits, 55-59
 Ohm's law for, 34-25
 -parallel circuit, Ohm's law for, 36-38
 resistors, 44-45
 resonance, 94-96
 Squares and square roots, powers of ten, 12
 Successive stages, 104
 Sum, 19

T

Term, 21
 Terminology, 20-21
 Time constant, 77-78, 90-93
 Transformer efficiency, 80-81
 Transformers, 79-81
 Trinomial, 21
 True power, 63
 Turns and impedance, 79-80

U

Units
 of length, 15
 of measurement, 13-17
 Unlike terms, 21

V

Volt, 13

W

Watt, 14
 Watt-hour, 14
 Wavelength, 66

Z

Zero level, 101-102