

بسمه تعالی

طراحی جکهای هیدرولیکی بالابر

و انتخاب پمپ

در طراحی و انتخاب جکهای هیدرولیکی و برای انتخاب و بدست آوردن توان کاری پمپ هیدرولیک، عوامل متعددی درگیر می باشند. در این چند صفحه سعی بر ارائه روش و متد انتخاب و طراحی جک و پمپ داریم و برای رسیدن به این هدف از هندبوکهای مربوط به هیدرولیک استفاده شده است .

طراحی و انتخاب پمپ :

گام اول

پیدا کردن فشار کاری سیستم می باشد که با توجه به مقدار توصیه شده در کتابها برای وسایلی که به عنوان جایجا کننده استفاده می شود حداکثر مقدار 200-250 bar کافی می باشد .

از آنجایی که سیستم مذکور (بالابر) نیروی الکتریکی مورد نیاز خود را در بعضی موارد از چند باطری تامین می نماید و چون محدوده فشار کاری برای سیستم مشخص می باشد لذا پمپ های پره دار دقیق مناسب می باشند.

مقادیر فشار ثبت شده برای این تیپ پمپها حداکثر 300 bar و به طور میانگین 170 bar می باشد. که با مطالعه و مشورت مقدار 150 bar (با کسر شدن افتهای فشاری) مقدار مطلوبی بوده که می توان از آن در طراحی استفاده کرد و با داشتن این مقدار فشار می توان گفت که یک قدم در طراحی پمپ را پیموده ایم.

اما پارامتر دیگری که در انتخاب پمپ دخالت دارد توان آن می باشد . اگر مقدار فشار کاری سیستم (فشاری که افتهای اصطکاکی از آن کم شده باشد) را داشته باشیم ، می توانیم از رابطه زیر توان پمپ را بدست آوریم.

$$power = pressure \times flow$$

$$power = p \times Q$$

که در معادله فوق :

P فشار کاری سیستم بر حسب نیوتن بر متر و

Q دبی حجمی سیستم بر حسب مترمکعب بر ثانیه می باشد.

نحوه بدست آمدن p در بالا تقریباً توضیح داده شد.

گام دوم

پارامتر مجهول بعدی Q می باشد، که برای Q داریم :

$$Q = A * V$$

که در آن :

A سطح مقطع خروجی پمپ و

V سرعت حرکت سیال در داخل لوله ها می باشد .

A همان سطح مقطع لوله های متصل به پمپ می باشد که مقدار آن نیز با توجه به انتخاب لوله ها بدست می آید .

اما برای پیدا کردن سرعت می بایست استانداردهای مربوطه به این بالابر بررسی گردد . زیرا نسبت سرعت سیال در درون لوله ها با نسبت سرعت بالا رفتن بالابر برابر می باشد . و چون سرعت مقوله ای مهم در امنیت دستگاه و همچنین کارایی آن دارد می بایست استانداردی یا حداقل مقادیر توصیه شده ای در این زمینه وجود داشته باشد . همانطوری که مستحضر می باشید اگر سرعت آنقدر کند باشد که زمان زیادی برای رسیدن به ارتفاع مورد نظر لازم باشد ، تقریباً می توان گفت کارایی دستگاه کم است و همینطور بالعکس . یعنی اگر سرعت بیش از اندازه زیاد باشد ، هنگام رسیدن به حداکثر ارتفاع براساس قانون نیوتن می تواند سبب پرت شدن راکب گردد.

با تمام توضیحات فوق اگر سرعت بدست آمده را در سطح مقطع ضرب نماییم به ما مقدار دبی را داده و با ضرب کردن آن در فشار کاری سیستم می توان توان مورد نیاز سیستم را محاسبه کرد .

حال با داشتن توان و فشار می توان با بررسی کاتلوگهای شرکتهای مختلف ، پمپ مورد نیاز را تهیه نمود.

طراحی و انتخاب سیلندر (جک) هیدرولیکی :

امروزه طراحان و مهندسان برای طراحی با استفاده از هندبوکها ، بسیار راحت می توانند طراحی انجام دهند . صرفاً برای این نوع طراحی می بایست مقادیر خواسته شده جداول را محاسبه نمایند و به کمک آنها در جداول به انتخاب طرح مورد نظر خود بپردازند. یکی از این موارد انتخاب سیلندر هیدرولیکی می باشد .

برای انتخاب سیلندر هیدرولیکی می بایست سطح مقطع مورد نیاز آن را بدست آورد و در جداول ، سیلندر مورد نیاز خود را با توجه به طول کورس انتخاب کرد.

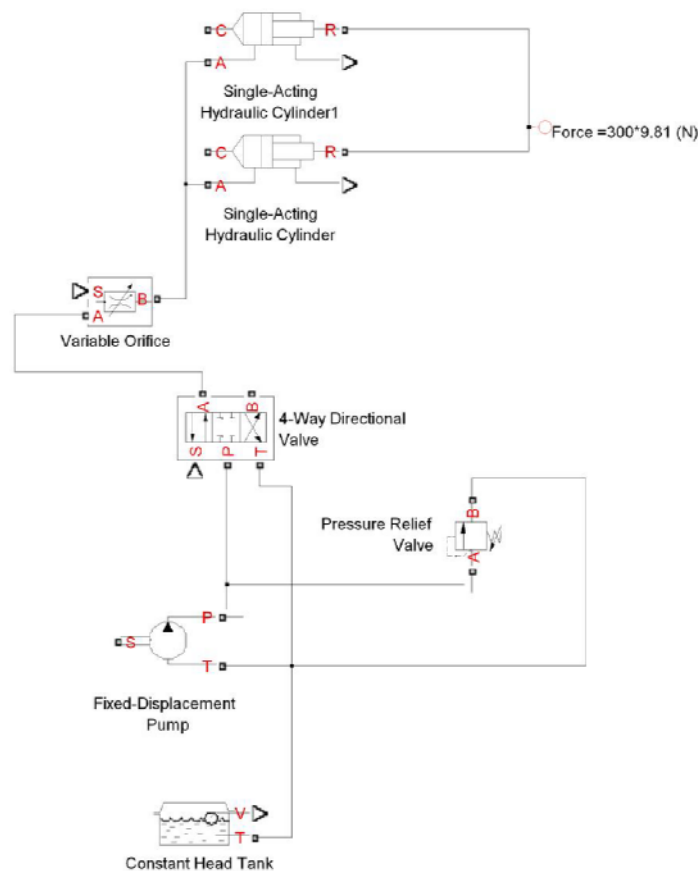

شکل فوق مدار هیدرولیکی ابتدایی یک بالابر می باشد . که به عنوان مثال در این شکل از ۲ سیلندر برای غلبه بر نیروی $300*9.81 N$ (با توجه به فرض مسئله) استفاده شده است .

در تمامی قطعات و وسایل به کار برده شده در این مدار افت فشار وجود دارد . همانطور که در بدست آوردن توان پمپ به افتهای اصطکاکی اشاره شده، پس می توان گفت بدست آوردن آن امری اجتناب ناپذیر می باشد. که در کاتالوگهای شرکتهای مختلف مقادیر افت اصطکاکی برای تمامی وسایل ذکر گردیده است.

سیلندرهای مورد استفاده در بالابرها غالباً یک طرفه بوده و برگشت در آنها به وسیله نیروی وزن انجام می شود.

در این نوع سیلندرها به توصیه کتابها ؛ سطح مقطع سیلندر و دسته پیستون غالباً نسبت ۲ به ۱ دارند. (البته نسبتهای دیگری مثل ۰/۷ نیز وجود دارد) که از این نکته برای بدست آوردن سطح مقطع مورد نیاز در سیلندر استفاده می نماییم. برای بدست آوردن سطح مقطع به ترتیب زیر عمل می کنیم.

$$(P - P_l) \times A = F + (P_l \times A/2)$$

که در آن:

P فشار نامی سیستم

P_l جمع فشارهای از دست رفته توسط اصطکاک

A سطح مقطع و

F نیرویی که بر روی هر سیلندر می باشد.

تمامی موارد فوق معلوم بوده ، پس سطح مقطع محاسبه می گردد . حال به کمک سطح مقطع می توان به جداول رجوع کرده و سیلندر هیدرولیکی مورد نظر را با توجه به طول کورس مورد نیاز تامین کرد .

اصولاً یک طراح اگر از وسیله ای در یک سیستم بیشتر از یکی استفاده نماید؛ می بایست به گونه ای دست به طراحی بزند که قطعات یا وسایلی که بیش از یکبار از آن استفاده شده ،همسان باشند تا در مراحل تولید و تعمیرات از داشتن چند مارک و مدل ، دچار سردرگمی و اشتباه نشود.

در انتخاب سیلندرها و طراحی مدارهای هیدرولیکی می بایست به این نکته توجه کرد ،تا در مرحله اجرا دچار مشکل نشویم.



به عنوان مثال در بالابر زیر در طراحی از ۳ جک همسان استفاده نموده اند. تا برای تهیه و تولید و حتی تعمیرات دچار مشکل تعدد سایز نگردند.

اما نکته ای که در این مثال به عنوان نمونه به آن می پردازیم . خود مکانیزم آکاردئونی است . برای آنکه هر ۳ جک نشان داده در شکل همزمان بار را تحمل کنند می بایست هر ۳ با هم باز شوند در غیر این صورت

ایجاد نابالانسی در هنگام بالا رفتن مشهود می گردد. در ۲ سیلندر پایینی، با توجه به اندازه و طول لوله های وصل شده یکسان، این در سیلندر با هم باز و بسته می شوند؛ اما سیلندر سوم که طول لوله بیشتری دارد به دلیل افت فشار بیشتر و وجود مقاومت بیشتر برای عبور سیال به نسبت ۲ سیلندر پایین، دیرتر باز شده که همین امر عملاً باعث بی استفاده بودن سیلندر مذکور میشود. نکته ای که طراح باید به آن در طراحی مدار هیدرولیکی این سیستم توجه نماید، ایجاد مقاومتی برای حرکت سیال به سمت ۲ سیلندر پایینی می باشد که با محاسبه دقیق این امر امکان پذیر می باشد.

و در انتها چند کاتالوگ در مورد اجزای مورد استفاده در این مدار آورده شده است

منابع:

1- *Hydraulics and Pneumatics*, by: Andrew parr, Publisher: Elsevier Science & Technology Books;

2- *Hydraulic Hand book*, by : R.H.Warring;

3- *Completions Hydraulics Handbook*, Publisher: Schlumberger;

4- *Hydraulics of Pipelines*, by : J. Paul Tullis, Publisher: John Wiley & sons;

5- *Pumps and Hydraulics*, by: Rex Miller, Mark Richard Miller, Harry Stewart, Publisher: John Wiley & sons;

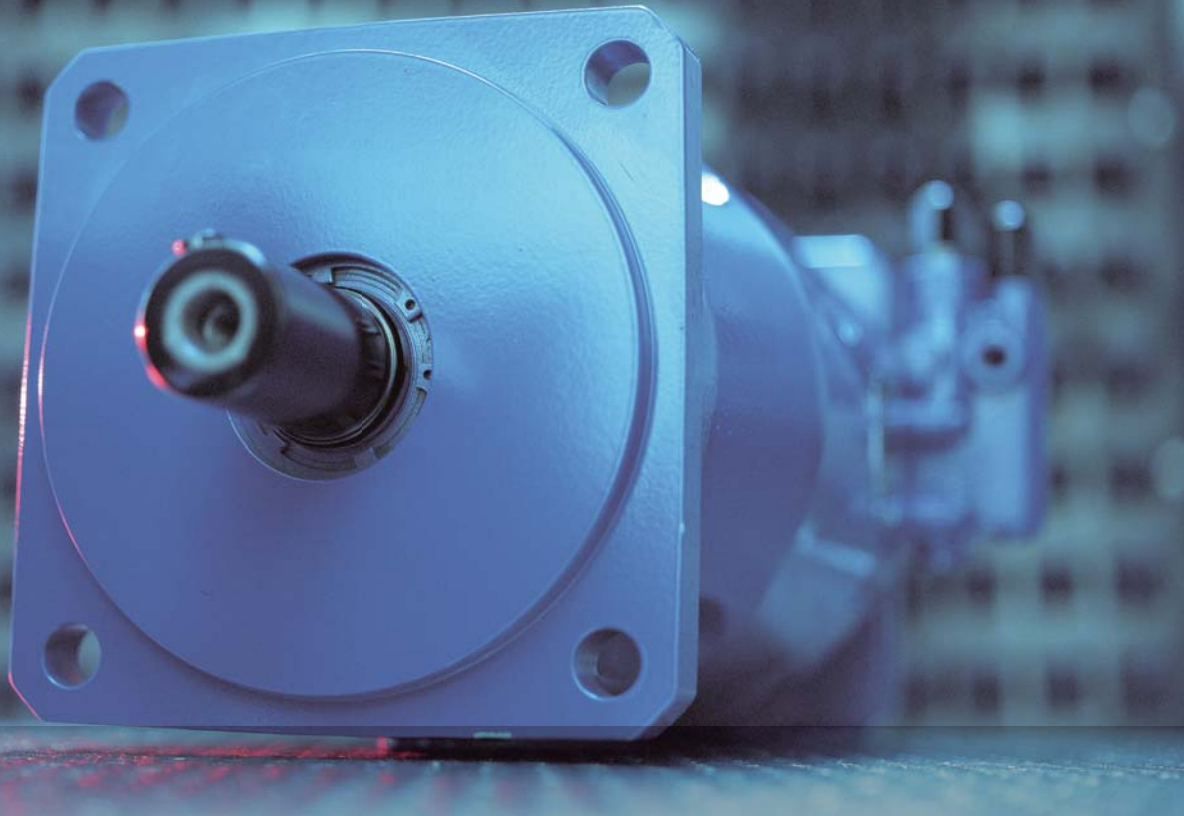

Pumps

Internal gear pumps

Internal gear pumps are suitable for operation at a continuous pressure of up to 315 bar (depending on frame size). Their compact build results in a particularly high power density and minimum space requirement.

Performance profile

- Displacement 1.7 to 250 cm³
- Continuous pressure up to 315 bar
- Pumps can be combined with each other
- Low flow pulsation and low-noise operation due to internal tothing
- Excellent volumetric efficiency due to hydraulic compensation of axial and radial sealing gap

Vane pumps

Our vane pump series are mainly used in the low and medium pressure range.

Performance profile

- Fixed displacement pumps:
- Displacement 18 to 193 cm³
 - Continuous pressure up to 210 bar
 - Dual-flow pumps
 - Low operating noise
 - Maintenance-friendly
- Variable displacement pumps:
- Displacement 10 to 150 cm³
 - Continuous pressure up to 160 bar
 - Multiple pump combinations
 - Pressure controllers, direct or pilot operated
 - Pressure, flow controllers

Radial piston pumps

Radial piston pumps are used for the high pressure range (operating pressures up to 700 bar). They are valve-controlled, self-priming pumps with a fixed displacement.

Performance profile

- Displacement 0.40 to 20 cm³
- Operating pressure up to 700 bar
- Hydrostatic bearing relief for a long service life
- Multiple pump combinations

Fixed displacement pumps

- Sizes 5 to 1000
- Axial tapered piston, bent-axis design
- Open circuit
- Series 6
- Standard fixed displacement pump for any application
- Robust and short taper roller bearing
- Service ports SAE or threaded
- Good suction characteristics
- Long-life bearing possible (sizes 250 to 1000)



Type A2FO

Size			5	10	12	16	23	28	32	45
Nominal pressure	bar		315	400	400	400	400	400	400	400
Peak pressure	bar		350	450	450	450	450	450	450	450
Displacement	V_g	cm ³	4.93	10.3	12	16	22.9	28.1	32	45.6
Speed ¹⁾	n_{max}	min ⁻¹	5600	3150	3150	3150	2500	2500	2500	2240
Flow	at n_{max}	q_{Vmax}	L/min	27.6	32.4	37.8	50	57	70	102
Power ²⁾	P_{max}	kW	14.5 ³⁾	21.6	25	34	38	47	53	68
Torque ²⁾	T_{max}	Nm	24.7 ³⁾	65	76	101	145	178	203	290
Weight (ca.)	m	kg	2,5	6	6	6	9,5	9,5	9,5	13,5

Size			56	63	80	90	107	125	160	180
Nominal pressure	bar		400	400	400	400	400	400	400	400
Peak pressure	bar		450	450	450	450	450	450	450	450
Displacement	V_g	cm ³	56.1	63	80.4	90	106.7	125	160.4	180
Speed ¹⁾	n_{max}	min ⁻¹	2000	2000	1800	1800	1600	1600	1450	1450
Flow	at n_{max}	q_{Vmax}	L/min	112	126	144	162	170	232	261
Power ²⁾	P_{max}	kW	75	84	96	108	114	133	155	174
Torque ²⁾	T_{max}	Nm	356	400	511	572	678	795	1020	1145
Weight (ca.)	m	kg	18	18	23	23	32	32	45	45

Size				200	250	355	500	710	1000
Nominal pressure	bar			400	350	350	350	350	350
Peak pressure	bar			450	400	400	400	400	400
Displacement	V_g	cm ³		200	250	355	500	710	1000
Speed ¹⁾	n_{max}	min ⁻¹		1550	1500	1320	1200	1200	950
Flow	at n_{max}	q_{Vmax}	L/min	310	375	469	600	826	950
Power ⁴⁾	P_{max}	kW		207 ²⁾	219	273	350	497	554
Torque ⁴⁾	T_{max}	Nm		1272 ²⁾	1393	1978	2785	3955	5570
Weight (ca.)	m	kg		66	73	110	155	322	336

Detailed information:
RE 91401

¹⁾ values valid at an absolute pressure of 1 bar in suction port S

²⁾ $\Delta p = 400$ bar

³⁾ $\Delta p = 315$ bar

⁴⁾ $\Delta p = 350$ bar

Fixed displacement pumps

- Sizes 16 to 500
- Axial piston swashplate design
- Open circuit
- Series 1 and 3
- Long bearing life
- Good suction characteristics
- Pump combinations possible
- Optional through-drive for mounting further pumps
- Operation with HF fluids possible with reduced technical data (sizes 71 to 500)



Detailed information:
RE 91455

Type A4FO

Size			16	22	28	40	
Nominal pressure		bar	400	400	400	400	
Peak pressure		bar	450	450	450	450	
Displacement	V_g	cm ³	16	22	28	40	
Speed ¹⁾	n_{max}	min ⁻¹	4000	3600	3000	2750	
Flow	at n_{max}	q_{Vmax}	L/min	64	79	84	110
Power	$\Delta p = 400$ bar	P_{max}	kW	43	53	56	73
Torque	$\Delta p = 400$ bar	T_{max}	Nm	102	140	178	254
Weight (ca.)	m	kg	13.5	13.5	13.5	16.5	

Size			71	125	250	500	
Nominal pressure		bar	350	350	350	350	
Peak pressure		bar	400	400	400	400	
Displacement	V_g	cm ³	71	125	250	500	
Speed ¹⁾	n_{max}	min ⁻¹	2200	1800	1500 ²⁾	1320 ²⁾	
Flow	at n_{max}	q_{Vmax}	L/min	152	225	375	660
Power	$\Delta p = 350$ bar	P_{max}	kW	91	131	219	385
Torque	$\Delta p = 350$ bar	T_{max}	Nm	395	696	1391	2783
Weight (ca.)	m	kg	34	61	120	220	

¹⁾ values valid at an absolute pressure of 1 bar in suction port S

²⁾ higher speeds permitted with high-speed version

Variable displacement pumps

- Sizes 40 to 1000
- Axial piston swashplate design
- Closed circuit
- Series 1 and 3
- Mainly for industrial applications
- Valve block for safeguarding the closed circuit
- Auxiliary pumps for the boost and pilot oil circuit or a further axial piston pump of up to the same size can be connected to the through-drive

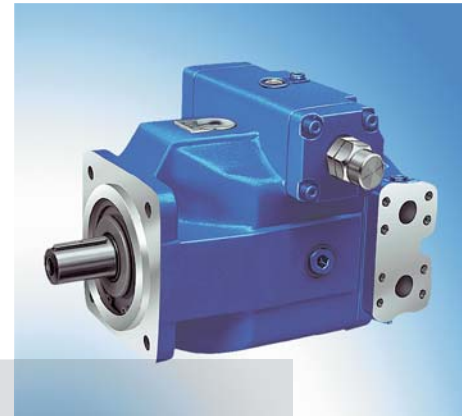

Type A4VSG

Size			40	71	125	180	250	
Nominal pressure		bar	350	350	350	350	350	
Peak pressure		bar	400	400	400	400	400	
Displacement	$V_{g \max}$	cm ³	40	71	125	180	250	
Speed	n_{\max}	min ⁻¹	3700	3200	2600	2400	2200	
Flow	at n_{\max}	$q_{V \max}$	L/min	148	227	325	432	550
Power	$\Delta p = 350 \text{ bar}$	P_{\max}	kW	86	132	190	252	321
Torque	$\Delta p = 350 \text{ bar}$	T_{\max}	Nm	223	395	696	1002	1391
Weight (ca.)	EO+valve block	m	kg	47	60	100	114	214

Size			355	500	750	1000	
Nominal pressure		bar	350	350	350	350	
Peak pressure		bar	400	400	400	400	
Displacement	$V_{g \max}$	cm ³	355	500	750	1000	
Speed	n_{\max}	min ⁻¹	2000	1800	1600	1600	
Flow	at n_{\max}	$q_{V \max}$	L/min	710	900	1200	1600
Power	$\Delta p = 350 \text{ bar}$	P_{\max}	kW	414	525	700	933
Torque	$\Delta p = 350 \text{ bar}$	T_{\max}	Nm	1976	2783	4174	5565
Weight (ca.)	EO+valve block	m	kg	237	350	500	630

Detailed information:
RE 92100

– Pump for semi-closed circuit:
RE 92110

MA
Manual control

EO1/EO2
Hydraulic displacement control (proportional valve)

HM1/2
Hydraulic displacement control, flow-related

DR
Pressure controller

EM
Electromotive control

HS/HS3
Hydraulic displacement control (servo/proportional valve)

HD
Hydraulic control, pilot pressure-related

DP
Pressure controller for parallel operation

HW
Hydraulic displacement control, position-related

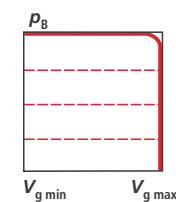
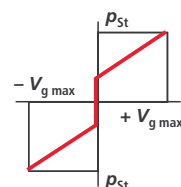
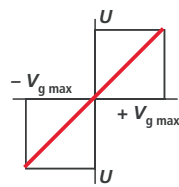
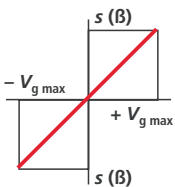

V_g = displacement
 p_{St} = pilot pressure
 p_B = operating pressure
 s = actuator travel
 U = control voltage



Variable displacement pumps (compact units)

- Sizes 250 to 750
- Axial piston swashplate design
- Closed circuit
- Series 3
- Integrated boost pump and valve technology
- Compact build
- Through-drive and pump combination possible in spite of integrated auxiliary pump

Type A4CSG

Detailed information:
RE 92105

Size			250	355	500	750	
Nominal pressure		bar	350	350	350	350	
Peak pressure		bar	400	400	400	400	
Displacement	Variable displ. pump	$V_{g \max}$	cm ³	250	355	500	750
	Integr. auxiliary pump	$V_{g H}$	cm ³	63	80	98	143
Speed	Max. speed	n_{\max}	min ⁻¹	2200	2000	1800	1600
	Min. speed	n_{\min}	min ⁻¹	800	800	800	800
Flow ¹⁾	at n_{\max}	$q_{V \max}$	L/min	550	710	900	1200
Power	$\Delta p = 350$ bar at $n_{0 \max}$	$P_{0 \max}$	kW	321	414	525	700
Torque ²⁾	$\Delta p = 350$ bar at $V_{g \max}$	T_{\max}	Nm	1391	1976	2783	4174
Weight (ca.) ³⁾		m	kg	214	237	350	500

- 1) Variable displacement pump
- 2) Variable displacement pump without auxiliary pump
- 3) Pump with EP control and integrated auxiliary pump

HM1/2/3

Hydraulic displacement control, flow-related

MA

Manual control

EM

Electromotive control

HW

Hydraulic displacement control, position-related

EO1/2

Hydraulic displacement control (proportional valve)

HS/HS3

Hydraulic displacement control (servo-/proportional valve)

HD

Hydraulic control, pilot pressure-related

EP

Electrohydraulic displacement control with proportional solenoid

V_g = displacement
 p_{St} = pilot pressure
 s = actuator travel
 β = angular position of the rotary pin
 U = control voltage
 I = current intensity

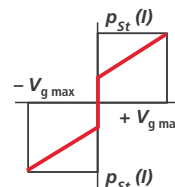
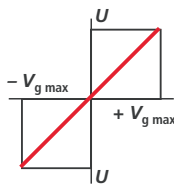
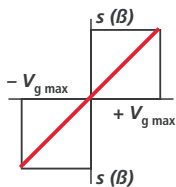

Variable displacement pumps

- Sizes 40 to 1000
- Axial piston swashplate design
- Open circuit
- Series 1 and 3
- Mainly for industrial applications
- Long service life
- Comprehensive controller and actuator product range
- Through-drive option



Type A4VSO

Size			40	71	125	180	250	
Nominal pressure	bar		350	350	350	350	350	
Peak pressure	bar		400	400	400	400	400	
Displacement	$V_{g \max}$	cm ³	40	71	125	180	250	
Speed ¹⁾	n_{\max}	min ⁻¹	2600	2200	1800	1800	1500 ²⁾	
Flow	at n_{\max}	$q_{V \max}$	L/min	104	156	225	324	375
Power	$\Delta p = 350 \text{ bar}$	P_{\max}	kW	61	91	131	189	219
Torque	$\Delta p = 350 \text{ bar}$	T_{\max}	Nm	223	395	696	1002	1391
Weight (ca.)	Press. controller	m	kg	39	53	88	102	184

Size			355	500	750	1000	
Nominal pressure	bar		350	350	350	350	
Peak pressure	bar		400	400	400	400	
Displacement	$V_{g \max}$	cm ³	355	500	750	1000	
Speed ¹⁾	n_{\max}	min ⁻¹	1500 ²⁾	1320 ²⁾	1200	1000	
Flow	at n_{\max}	$q_{V \max}$	L/min	533	660	900	1000
Power	$\Delta p = 350 \text{ bar}$	P_{\max}	kW	311	385	525	583
Torque	$\Delta p = 350 \text{ bar}$	T_{\max}	Nm	1976	2783	4174	5565
Weight (ca.)	Press. controller	m	kg	207	320	460	605

Detailed information:
RE 92050

- 1) values valid at an absolute pressure of 1 bar in suction port S
2) higher speeds permitted with high-speed version

DR Pressure controller
DP

Pressure controller for parallel operation

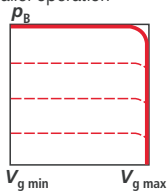

FR Flow controller

Flow controller

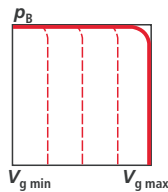

DFR Pressure and flow controller

Pressure and flow controller

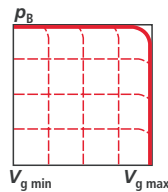

LR2 Power controller
LR3

Remote-controlled power controller,

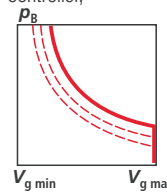

MA Manual control
EM

Electromotive control

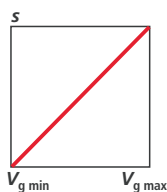

HS/HS3 Hydraulic displacement control (servo-/proportional valve)

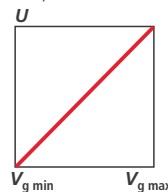

EO1/EO2 Hydraulic displacement control (proportional valve)

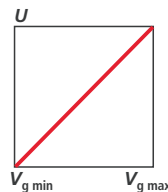

HD Hydraulic control, pilot pressure-related

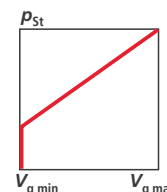

HM1/2 Hydraulic displacement control, flow-related

DFE1 Pressure, flow controller, electronic

- V_g = displacement
- p_B = operating pressure
- p_{St} = pilot pressure
- s = actuator travel
- β = swivel angle
- U = control voltage

Variable displacement pumps

- Sizes 10 to 140
- Axial piston swashplate design
- Open circuit
- Series 3 (sizes 18 to 140)
- Series 5 (size 10)
- Long bearing life
- Comprehensive controller and actuator product range
- Through-drive option for mounting further pumps up to the same size (not with size 10)



Detailed information:
 – Size 10: RE 92713
 – Size 18: RE 92712
 – Sizes 28 to 140: RE 92711

Type A10VSO

Size			10	18	28	45	
Nominal pressure		bar	250	280	280	280	
Peak pressure		bar	315	350	350	350	
Displacement	$V_{g \max}$	cm ³	10.5	18	28	45	
Speed ¹⁾	n_{\max}	min ⁻¹	3600	3300	3000	2600	
Flow	at n_{\max}	$q_{V \max}$	L/min	37.8	59.4	84	117
Power	$\Delta p = 280$ bar	P_{\max}	kW	15.7 ²⁾	27.7	39	55
Torque	$\Delta p = 280$ bar	T_{\max}	Nm	41.7 ²⁾	80	125	200
Weight (ca.)	Press. controller	m	kg	8	12	15	21

Size			71	100	140	
Nominal pressure		bar	280	280	280	
Peak pressure		bar	350	350	350	
Displacement	$V_{g \max}$	cm ³	71	100	140	
Speed ¹⁾	n_{\max}	min ⁻¹	2200	2000	1800	
Flow	at n_{\max}	$q_{V \max}$	L/min	156	200	252
Power	$\Delta p = 280$ bar	P_{\max}	kW	73	93	118
Torque	$\Delta p = 280$ bar	T_{\max}	Nm	316	445	623
Weight (ca.)	Press. controller	m	kg	33	45	60

¹⁾ values valid at an absolute pressure of 1 bar in suction port S

²⁾ $\Delta p = 250$ bar

DR
Pressure controller

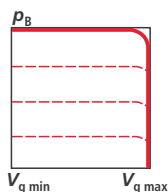

DFR
Pressure and flow controller

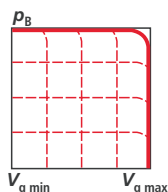

DFLR
Pressure, flow and power controller

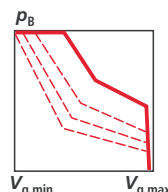

DFE
Pressure, flow controller, electronic

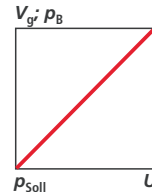

FHD
Displacement controller, pilot pressure-related, with pressure control

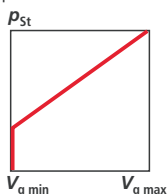

ED
Electrohydraulic closed-loop pressure control

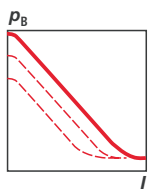

V_g = displacement
 p_{St} = pilot pressure
 p_B = operating pressure
 I = current intensity
 U = control voltage

Variable displacement pumps

- Sizes 55 to 1000
- Axial tapered piston bent-axis design
- Open circuit
- Series 6
- Robust, for versatile use in open-circuit applications
- Long-life bearings possible for prolonged service life (sizes 250 to 1000)
- Visual or electrical swivel angle indicator on request (size 250 to 1000)
- Comprehensive controller and actuator product range

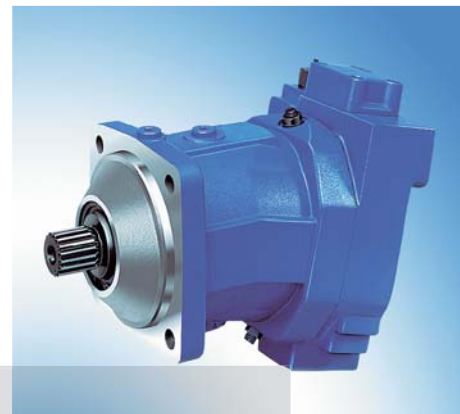

Type A7VO

Size			55	80	107	160	
Nominal pressure		bar	350	350	350	350	
Peak pressure		bar	400	400	400	400	
Displacement	$V_{g \max}$	cm ³	54.8	80	107	160	
Speed ¹⁾	n_{\max}	min ⁻¹	2500	2240	2150	1900	
Flow	at n_{\max}	$q_{V \max}$	L/min	137	179	230	304
Power	$\Delta p = 350 \text{ bar}$	P_{\max}	kW	80	105	134	177
Torque	$\Delta p = 350 \text{ bar}$	T_{\max}	Nm	305	446	596	891
Weight (ca.)	m	kg	25	40	49	71	

Size			250	355	500	1000	
Nominal pressure		bar	350	350	350	350	
Peak pressure		bar	400	400	400	400	
Displacement	$V_{g \max}$	cm ³	250	355	500	1000	
Speed ¹⁾	n_{\max}	min ⁻¹	1500	1320	1200	950	
Flow	at n_{\max}	$q_{V \max}$	L/min	375	469	600	950
Power	$\Delta p = 350 \text{ bar}$	P_{\max}	kW	212	265	340	538
Torque	$\Delta p = 350 \text{ bar}$	T_{\max}	Nm	1391	1976	2783	5565
Weight (ca.)	m	kg	102	173	234	450	

Detailed information
 – Sizes 55 to 160:
 RE 92202
 – Sizes 250 to 1000:
 RE 92203

¹⁾ values valid at an absolute pressure of 1 bar in suction port S

LR
Power controller

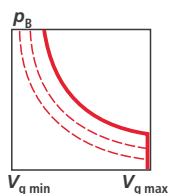

DR
Pressure controller

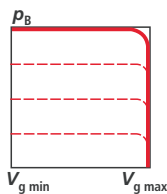

EP
Electrical control with proportional solenoid

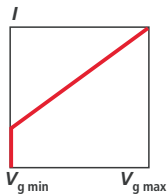

HD
Hydraulic control, pilot pressure-related

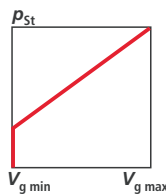

V_g = displacement
 p_B = operating pressure
 p_{St} = pilot pressure
 I = current intensity



Variable displacement pumps

- Size 450
- Axial piston swashplate design
- Variable displacement pump for the closed circuit and preload operation
- Series 3

Detailed information:
RE 92120

Type A4VB

Size			450
Nominal pressure		bar	420
Peak pressure		bar	450
Displacement		V_g cm ³	456
Speed		n_{max} min ⁻¹	1800
Flow	at n_{max}	q_{Vmax} L/min	821
Power	$\Delta p = 420$ bar	P_{max} kW	574
Torque	$\Delta p = 420$ bar	T_{max} Nm	3044
Weight (ca.)		m kg	420

HS/HS3

Hydraulic displacement
control (servo-/proportional
valve)

V_g = displacement
 U = control voltage

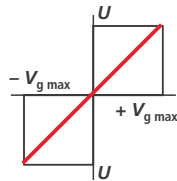

Electronics for axial piston units

Overview of electronic components and systems suitable for axial piston units in stationary applications



Type of component		For controlling		Detailed information:
Sensors				
HM 16	Pressure transducer	A10VS	DFEE	RE 30266
Open-loop control electronics, analogue				
VT 2000	Amplifier for proportional valves	A10VS / A4VS	DRG	RE 29904
VT-VSPA1(K)-1	Amplifier for proportional valves	A10VS / A4VS	DRG	RE 30111
VT 3000	Amplifier for proportional valves	A10VS / A4VS	DRG	RE 29935
VT 5003	Amplifier for proportional valves	A10VS / A4VS	DRG	RE 29945
Closed-loop control electronics, analogue				
VT 5035	Amplifier for flow control	A4VS	EO	RE 29955
VT 11019	Amplifier for flow control	A10VS	FE	RE 29763
VT-SR7	Amplifier for flow control	A4VS	HS	RE 29993
SYDFE1, SYDFEE, SYDFEC	Closed-loop control systems for A10VSO...		DFE	RE 30024, RE 30030, RE 30027
VT 5041	Closed-loop control system for A4VS		DFE	RE 30240
Closed-loop control electronics, digital				
VT 12350	Closed-loop control system for A4VS...HS3			RE 30021
Accessories				
VT 3002	Card holder			RE 29928
VT 12302	Enclosed card holder			RE 30103
VT 12304	Interface converter			RE 30104
VT 19101 to 19110	19" racks			RE 29768
VT-NE30 to VT-NE32	Compact power supply units			RE 29929
VTS 0102	FUW1 frequency/voltage converter			RE 29761
VT 12321	BB-3 hand-held control box			RE 29798
BODIV	PC program for digital amplifier cards			RE 29899

External gear pumps

- Sizes 1 to 56
- Plain bearings for high loads
- Drive shafts according to ISO or SAE
- Combination of several pumps possible
- Line connections: Connecting flanges or pipe thread
- Silence version:
 - Optimized pressure pulsation reduces noise emission and excitation of vibration in the system
 - Significantly longer service life due to reinforced shaft and housing



Detailed information:
 – 1987760100
 – RE 98240
 – RE 10095
 (Silence version)

Type AZP

Frame size B	Size		1	2	3	4	5
Displacement	$V_{g \max}$	cm ³	1	2	3	3.8	4.6
Operating pressure ¹⁾	p	bar	230	230	230	210	160
Power at 1450 min ⁻¹	P_{Antr}	kW	0.62	1.24	1.85	2.14	1.98
Speed range ²⁾	n	min ⁻¹	750 to 6000				
Weight (ca.)	m	kg	0.8	0.86	0.9	0.9	0.9

Frame size F	Size		4	5	8	11	14	16	19	22
Displacement	$V_{g \max}$	cm ³	4	5.5	8	11	14	16	19	22.5
Operating pressure ¹⁾	p	bar	280	280	280	280	280	280	230	210
Power at 1450 min ⁻¹	P_{Antr}	kW	3.01	4.14	6.01	8.27	10.5	12	11.7	12.7
Speed range ²⁾	n	min ⁻¹	500 to 4000							
Weight (ca.)	m	kg	2.8	2.85	2.9	3	3.2	3.4	3.6	3.8

Silence version	Size		4	5	8	11	14	16	19	22	25	28
Displacement	$V_{g \max}$	cm ³	4	5.5	8	11	14	16	19	22.5	25	28
Operating pressure ¹⁾	p	bar	280	280	280	280	280	280	250	225	200	15
Power at 1450 min ⁻¹	P_{Antr}	kW	3.01	4.14	6.01	8.27	10.5	12	14.3	15.1	15.1	15
Speed range ²⁾	n	min ⁻¹	500 to 4000									
Weight (ca.)	m	kg	2.8	2.85	2.9	3	3.2	3.4	3.6	3.8	–	–

Frame size N	Size		20	22	25	28	32	36
Displacement	$V_{g \max}$	cm ³	20	22.5	25	28	32	36
Operating pressure ¹⁾	p	bar	250	250	250	230	200	180
Power at 1450 min ⁻¹	P_{Antr}	kW	13.4	15.1	16.8	17.3	17.2	17.4
Speed range ²⁾	n	min ⁻¹	500 to 3000					
Weight (ca.)	m	kg	5.4	5.5	5.6	5.7	5.9	6

Frame size G	Size		22	28	32	38	45	56
Displacement	$V_{g \max}$	cm ³	22.5	28	32	38	45	56
Operating pressure ¹⁾	p	bar	250	250	250	250	230	200
Power at 1450 min ⁻¹	P_{Antr}	kW	15.1	18.8	21.5	25.5	27.8	30.1
Speed range ²⁾	n	min ⁻¹	500 to 3000					
Weight (ca.)	m	kg	9	9.2	9.4	9.7	9.9	10.4

¹⁾ intermittent

²⁾ depending on size

Internal gear pumps

- Sizes 1.7 to 40
- Low operating noise
- Low flow pulsation
- High efficiency even at low viscosity due to sealing gap compensation
- Suitable for wide speed and viscosity ranges
- Combination of several pumps possible
- Can be combined with axial piston pumps and vane pumps

Type PGF

Frame size 1		Size	1.7	2.2	2.8	3.2	4.1	5.0	
Nominal pressure		bar	180	210	210	210	210	180	
Displacement		$V_{g \max}$ cm ³	1.7	2.2	2.8	3.2	4.1	5.0	
Operating pressure ¹⁾		p_{\max} bar	210	250	250	250	250	210	
Power ²⁾	at 1450 min ⁻¹	P kW	1.2	1.8	2	2.2	2	3.1	
Speed range		n_{\max} min ⁻¹	600 to 4500 ³⁾						
Weight		m kg	0.8	0.9	1.0	1.0	1.1	1.3	
Frame size 2		Size	6	8	11	13	16	19	22
Nominal pressure		bar	210	210	210	210	210	210	180
Displacement		$V_{g \max}$ cm ³	6.5	8.2	11	13.3	16	18.9	22
Operating pressure ¹⁾		p_{\max} bar	250	250	250	250	250	250	210
Power ²⁾	at 1450 min ⁻¹	P kW	4	5.1	6.6	8	9.3	10.9	12.4
Speed range		n_{\max} min ⁻¹	600 to 3600 ³⁾						
Weight		m kg	2.1	2.2	2.4	2.6	2.7	2.9	3.1
Frame size 3		Size	20	22	25	32	40		
Nominal pressure		bar	210	210	210	210	180		
Displacement		$V_{g \max}$ cm ³	20.6	22.2	25.4	32.5	40.5		
Operating pressure ¹⁾		p_{\max} bar	250	250	250	250	210		
Power ²⁾	at 1450 min ⁻¹	P kW	11.7	12.5	14.1	18.1	20.0		
Speed range		n_{\max} min ⁻¹	500 to 3600 ³⁾						
Weight		m kg	3.3	3.7	4.1	4.5	4.9		



Detailed information:
RE 10213

- ¹⁾ intermittent
²⁾ at max., continuous operating pressure
³⁾ depending on size



Internal gear pumps

- Very low operating noise
- Low flow pulsation
- High efficiency even at low speed and viscosity due to sealing gap compensation
- Suitable for wide speed and viscosity ranges
- All frame sizes and sizes can be combined with each other
- Can be combined with vane pumps and axial piston pumps

Detailed information:
RE 10223

Type PGH

Frame size 2	Size	5	6.3	8
Nominal pressure	bar	315	315	315
Displacement	$V_{g \max}$ cm ³	5.2	6.5	8.2
Operating pressure ¹⁾	p_{\max} bar	350	350	350
Speed	n_{\min} min ⁻¹	600	600	600
	n_{\max} min ⁻¹	3000	3000	3000
Weight (ca.)	m kg	4.3	4.8	5

Frame size 3	Size	11	13	16
Nominal pressure	bar	315	315	315
Displacement	$V_{g \max}$ cm ³	11	13	16
Operating pressure ¹⁾	p_{\max} bar	350	350	350
Speed	n_{\min} min ⁻¹	600	600	600
	n_{\max} min ⁻¹	3000	3000	3000
Weight (ca.)	m kg	5.9	6.2	6.4

Frame size 4	Size	20	25	32	40	50	63	80	100
Nominal pressure	bar	250	250	250	250	250	210	210	160
Displacement	$V_{g \max}$ cm ³	20.1	25.3	32.7	40.1	50.7	65.5	80.3	101.4
Operating pressure ¹⁾	p_{\max} bar	315	315	315	315	315	250	250	210
Speed	n_{\min} min ⁻¹	500	500	500	500	500	400	400	400
	n_{\max} min ⁻¹	3000	3000	3000	2600	2600	2600	2200	2200
Weight (ca.)	m kg	13.5	14	14.5	15	16	17	18.5	20

Frame size 5	Size	63	80	100	125	160	200	250
Nominal pressure	bar	250	250	250	250	210	160	125
Displacement	$V_{g \max}$ cm ³	64.7	81.4	100.2	125.3	162.8	200.4	250.5
Operating pressure ¹⁾	p_{\max} bar	315	315	315	315	250	210	160
Speed	n_{\min} min ⁻¹	400	400	400	400	300	300	300
	n_{\max} min ⁻¹	2600	2200	2200	2200	1800	1800	1800
Weight (ca.)	m kg	39	40.5	42.5	45	49	52.5	57.5

¹⁾ intermittent

Vane pumps, fixed displacement

- Sizes 18 to 193
- Low operating noise
- Low flow pulsation
- Suitable for wide speed and viscosity ranges
- Combination of several pumps possible
- Can be combined with axial piston pumps and internal gear pumps

Types PVV, PVQ

Frame size 1	Size	18	27	36	40	46
Nominal pressure ¹⁾	p_{\max} bar	210	210	210	160	140
Displacement	$V_{g \max}$ cm ³	18	27	36	40	46
Power ²⁾ at 1450 min ⁻¹	P_{hyd} kW	11	16	21	18	18
Speed range	n min ⁻¹	on inquiry ³⁾				
Weight	m kg	12	12	12	12	12
Frame size 2	Size	40	45	55	60	68
Nominal pressure ¹⁾	p_{\max} bar	210	210	210	210	210
Displacement	$V_{g \max}$ cm ³	40	45	55	60	68
Power ²⁾ at 1450 min ⁻¹	P_{hyd} kW	22	26	32	34	37
Speed range	n min ⁻¹	on inquiry ³⁾				
Weight	m kg	14.8	14.8	14.8	14.8	14.8
Frame size 4	Size	69	82	98	113	122
Nominal pressure ¹⁾	p_{\max} bar	210	210	210	210	210
Displacement	$V_{g \max}$ cm ³	69	82	98	113	122
Power ²⁾ at 1450 min ⁻¹	P_{hyd} kW	38	45	55	60	65
Speed range	n min ⁻¹	on inquiry ³⁾				
Weight	m kg	23	23	23	23	23
Frame size 5	Size	139	154	162	183	193
Nominal pressure ¹⁾	p_{\max} bar	175	175	175	175	175
Displacement	$V_{g \max}$ cm ³	139	154	162	183	193
Power ²⁾ at 1450 min ⁻¹	P_{hyd} kW	69	75	80	90	95
Speed range	n min ⁻¹	on inquiry ³⁾				
Weight	m kg	34	34	34	34	34



Detailed information:
RE 10335

- ¹⁾ intermittent
²⁾ at max., continuous operating pressure; hydraulic fluid temperature $\vartheta = 50\text{ °C}$
³⁾ depending on size

Vane pumps, pilot operated

- Sizes 14 to 150
- Variable displacement
- Low operating noise
- Pressure and flow can be controlled
- Controller actuator can optionally be locked
- Available as completely assembled, compact "MPU" drive unit (pump and electric motor)
- Low hysteresis
- Very short control times
- Pump combination possible with standard pumps
- Mounting and connection dimensions to VDMA 24 560/1 and ISO 3019/2



Detailed information:
RE 10515

Type PV7

Frame size			10	10	16	16	25	25
Nominal pressure		bar	160	100	160	80	160	80
Displacement (size)		$V_{g \max}$ cm ³	14	20	20	30	30	45
Power	at 1450 min ⁻¹	<i>P</i> kW	6.3	5.8	10	7.1	13.7	10.5
Speed range		<i>n</i> min ⁻¹	900 to 1800					
Weight		<i>m</i> kg	12.5	12.5	17	17	21	21
Frame size		FS	40	40	63	63	100	100
Nominal pressure		bar	160	80	160	80	160	80
Displacement (size)		$V_{g \max}$ cm ³	45	71	71	94	118	150
Power	at 1450 min ⁻¹	<i>P</i> kW	20.5	17	34	22	54	35
Speed range		<i>n</i> min ⁻¹	900 to 1800					
Weight		<i>m</i> kg	30	30	37	37	56	56

Vane pumps, direct operated

- Sizes 10 to 25
- Very short control times
- Low operating noise
- Lower zero stroke power
- Mounting and connection dimensions to VDMA 24 560/1 and ISO 3019/2
- Good efficiency
- Pump combination possible



Detailed information:
RE 10522

Type PV7...A

Frame size			06	06	20	20
Nominal pressure		bar	100	70	100	100
Displacement (size)		$V_{g \max}$ cm ³	10	14	20	25
Power	at 1450 min ⁻¹	<i>P</i> kW	2.5	2.7	5	6
Speed range		<i>n</i> min ⁻¹	1000 to 1800			
Weight		<i>m</i> kg	6.3	6.3	11.4	11.4

Radial piston pumps, fixed displacement

- Sizes 1.6 to 20.0
- Radial piston pump with 3, 5 or 10 pistons
- Self-aspirating, valve-controlled
- Very low noise
- Long bearing life due to hydro-dynamically lubricated plain bearings
- Several pressure ports with various cylinder combinations possible
- Optional combination with fixed and variable displacement vane, gear and axial piston pumps
- 14 sizes, favourable gradation for optimum matching to the application at hand

Type R4

Size			1.6	2.0	2.5	3.15	4.0	6.3	8.0	
Displacement	$V_{g \max}$	cm ³	1.51	2.14	2.59	3.57	4.32	7.14	8.63	
Operating pressure	p_{\max}	bar	700	700	700	700	700	700	700	
Power	at 1450 min ⁻¹	P	kW	2.9	4.1	4.9	6.8	8.1	13.6	16.1
Speed range	n	min ⁻¹	1000 to 2000							
Weight	m	kg	6.8	6.8	6.8	8.6	8.6	12.7	12.7	

Size	Size	3.15	5.0	6.3	8.0	10.0	16.0	20.0		
Displacement	$V_{g \max}$	cm ³	3.39	4.82	5.83	8.03	9.71	16.07	19.43	
Operating pressure	p_{\max}	bar	500	500	500	500	500	500	500	
Power	at 1450 min ⁻¹	P	kW	4.7	6.7	7.9	10.9	12.9	21.2	25.3
Speed range	n	min ⁻¹	1000 to 2000							
Weight	m	kg	6.8	6.8	6.8	8.6	8.6	12.7	12.7	



Detailed information:
RE 11263

Radial piston pumps, fixed displacement

- Sizes 0.4 to 2.0
- Radial piston pump with 3 pistons
- Very compact build, hence installation-friendly dimensions
- 5 sizes

Type R4-Mini

Size			0.4	0.63	1.0	1.6	2.0	
Displacement	$V_{g \max}$	cm ³	0.4	0.63	1.0	1.6	2.0	
Operating pressure	p_{\max}	bar	700	700	450	250	175	
Power	at 1450 min ⁻¹	P	kW	0.66	1.15	1.14	1.06	0.86
Speed range ¹⁾	n	min ⁻¹	1000 to 3400					
Weight	m	kg	2.6	2.6	2.6	2.6	2.6	



Detailed information:
RE 11260

¹⁾ Depending on size



Combination pumps

- Fixed displacement pump + fixed displacement pump
- Variable displacement pump + fixed displacement pump
- Fixed displacement pump + fixed displacement pump

Numerous optional combinations

Detailed information:
See data sheet of front pump

• = included in product range
– = not available

Multiple combinations on inquiry

		Rear pump						
		PV7	PGH/PGF	R4	R4-Mini	AZP	A10	PVV/PVQ
Front pump	PV7	•	•	•	•	•	•	•
	PGH/PGF	-	•	•	•	•	•	•
	R4	-	-	-	-	•	-	-
	AZP	-	-	-	-	•	-	-
	A10	-	•	-	-	•	•	•



Cylinders

Rexroth cylinders are characterized by high quality and innovative concepts such as precisely guided piston rods in conjunction with advanced sealing technology, self-adjusting end position cushioning and safety bleeding.

Proximity switches and integrated position measuring systems in conjunction with built-on control blocks and high-response valves allow the realization of complete hydraulic axes.

Performance profile

- Standard, industry-specific and project-related cylinders
- Operating pressure up to 4000 bar
- Installation dimensions to ISO, DIN, CETOP, etc.
- Piston \varnothing 25 up to 1500 mm
- Stroke length up to 44000 mm
- Seal systems
- Integrated position measuring systems
- Integrated proximity switches



Tie rod design

- Mounting of head and cap according to the tie rod principle
- Service-friendly modular system
- Small installation dimensions
- Various mounting types
- Interchangeability thanks to standardization
- Industry-specific and project-related cylinders on inquiry

Detailed information:

- CDT3...F: RE 17039
- H160CA: 1987761512
- CD70: RE 17016
- C80H: 1987761514
- CDW160: RE 17014
- VBH: RE 17047
- CD210: RE 17017

Series		CDT3...F ¹⁾	CD70 ¹⁾
Nominal pressure	bar	160 ²⁾	70
Piston Ø	mm	25 to 200	25 to 200
Piston rod Ø	mm	12 to 140	12 to 140
Mounting types		14	16
Max. stroke length	mm	3000	3000
Max. stroke speed	m/s	0,5	0,5

Series		C80H	CDW160 ³⁾
Nominal pressure	bar	80	160
Piston Ø	mm	32 to 160	40 to 200
Piston rod Ø	mm	18 to 110	28 to 140
Mounting types		6	5
Max. stroke length	mm	1500	1700
Max. stroke speed	m/s	1	1

Series		VBH ⁴⁾	CD210 ⁵⁾
Nominal pressure	bar	200	210
Piston Ø	mm	25 to 125	14 to 200
Piston rod Ø	mm	16 to 70	16 to 140
Mounting types		4	16
Max. stroke length	mm	160	3000
Max. stroke speed	m/s	0,5	0,5

¹⁾ installation dimensions to DIN 24 554 and ISO 6020/2

²⁾ operating pressures up to 210 bar possible

³⁾ with integrated position transducer

⁴⁾ according to CNOMO 05.07.65 to 05.07.71

⁵⁾ installation dimensions to N.F.P.A and JIC

Mill type design

- Mill type design for applications even under extreme operating conditions
- Service-friendly modular system
- Various mounting types
- Interchangeability thanks to standardization
- Industry-specific and project-related cylinders on inquiry



Series		CDL1 ¹⁾	CDM1 ²⁾	CDH1 ¹⁾	CDH2 ³⁾	CDH3 ¹⁾
Nominal pressure	bar	160	160	250	250	350
Piston Ø	mm	25 to 200	25 to 200	40 to 320	40 to 320	40 to 320
Piston rod Ø	mm	14 to 110	14 to 140	22 to 220	22 to 220	28 to 220
Mounting types		7	9	6	6	6
Max. stroke length	mm	3000	3000	6000	6000	6000
Max. stroke speed	m/s	0.5	0.5	0.5	0.5	0.5

Series		C160TH/BH ⁴⁾	A60/A120H	C160SV/SVP/SVU ⁵⁾
Nominal pressure	bar	160	80/130	160
Piston Ø	mm	32 to 160	40 to 80	40 to 80
Piston rod Ø	mm	16 to 110	22 to 56	22 to 45
Mounting types		7	12	4
Max. stroke length	mm	4500	3000	1500
Max. stroke speed	m/s	1	1	1

Detailed information:

- CDL1: RE 17325
- CDM1: RE 17328
- H160M: 1987761513
- CDH1: RE 17331
- CDH2: RE 17334
- CDH3: RE 17337
- H250E: 1987761515
- C160TH/BH: 1987761503
- A60/A120H: 7472999315
- C160SV/SVP/SVU: BEY 015/2

- inst. dimensions to Rexroth
- installation dimensions to ISO 6020/1 and CETOP RP 58 H
- installation dimensions to DIN 24 333, ISO 6022 and CETOP RP 73 H
- installation dimensions to ISO 6020/1
- with integrated position transducer



On/off valves

Directional valves

For applications in hydraulic systems we offer direct and pilot operated directional valves with pressure-tight solenoids, with hydraulic, pneumatic and mechanical actuation.

Performance profile

- Size 6 and size 10 direct operated:
Max. operating pressure 350 bar
Max. flow 120 L/min
- Sizes 10 to 32 pilot operated:
Max. operating pressure 350 bar
Max. flow 1100 L/min
- Porting patterns internationally standardized
- Numerous spool symbols and types of operation

Pressure, flow control and isolator valves

Apart from pressure, flow control and isolator valves, this product segment also includes accessories such as subplates.

Performance profile

- Sizes 6 to 32 and valves for in-line mounting:
Max. operating pressure 630 bar
- Pressure control valves:
Pressure relief valves
Pressure reducing valves
Pressure sequencing and
Pressure cut-off valves
- Flow control valves:
Throttle valves
Flow control valves
- Isolator valves:
Check valves
Pilot operated check valves

2-way cartridge valves (logic elements)

2-way cartridge valves are elements designed for compact modular structures. The power part is mounted in the control block in a cavity standardized in accordance with DIN ISO 7368 and closed with a cover.

Performance profile

- Sizes 16 to 160
- Max. operating pressure 420 bar
- Directional function
- Pressure function



Check valves

- Sizes 6 to 30
- Leak-free isolation in one direction
- For threaded connection
- 4 different opening pressures

Detailed information:
RE 20375

Type S

Size			6	8	10	20	25	30
Operating pressure	p_{\max}	bar	315	315	315	315	315	315
Opening pressure			without spring; 0.5; 1.5; 3; 5					
Flow	$q_{V \max}$	L/min	18	36	60	250	350	450



Check valve cartridge units

- Sizes 6 to 30
- Leak-free isolation in one direction
- Plug screw with pipe thread or metric ISO thread
- Installation in manifolds:
 - As right-angled cartridge valve (version "KE")
 - As straight cartridge valve (version "KD")
- 5 different opening pressures

Detailed information:
RE 20380

Type M-SR

Size			6	8	10	15	20	25	30	
Operating pressure	p_{\max}	bar	315	315	315	315	315	315	315	
Opening pressure			without spring; 0.2; 0.5; 1.5; 3; 5							
Flow	"KE"	$q_{V \max}$	L/min	–	35	50	120	200	300	400
	"KD"	$q_{V \max}$	L/min	15	30	50	100	200	300	400

Check valves of sandwich plate design

- Sizes 6 and 10
- Porting pattern to DIN 24 340 form A, ISO 4401 and CETOP-RP 121 H
- 8 check functions
- 3 different opening pressures
- Optionally with
 - Metal seal: Type Z1S...-3X/V ($v_{\text{hydraulic fluid}} > 4 \text{ m/s}$)
 - Soft seal: Type Z1S...1-2X/VW4 ($v_{\text{hydraulic fluid}} < 4 \text{ m/s}$)

Type Z1S

Size			6	10
Operating pressure	p_{max}	bar	315	315
Opening pressure		bar	0.5; 3; 5	0.5; 3; 5
Flow	$q_{V \text{ max}}$	L/min	40	100



Detailed information:
 – Size 6: RE 21533
 – Size 10: RE 21536

Pilot operated check valves of sandwich plate design

- Sizes 6 to 22
- Porting pattern to DIN 24 340 form A, ISO 4401 and CETOP-RP 121 H
- For the leak-free isolation of one or two actuator ports, even over longer times at rest
- At least 3 different opening pressures

Type Z2S

Size			6	10	16	22
Series			6X	3X	5X	5X
Operating pressure	p_{max}	bar	315	315	315	315
Opening pressure		bar	1.5; 3; 7	1.5; 3; 6; 10	3; 5; 7.5; 10	3; 5; 7.5; 10
Flow	$q_{V \text{ max}}$	L/min	60	120	300	450



Detailed information:
 – Size 6: RE 21548
 – Size 10: RE 21553
 – Size 16: RE 21558
 – Size 22: RE 21564

Pilot operated check valves of sandwich plate design (210 bar version)

- Sizes 6 and 10
- Porting pattern to DIN 24 340 form A, ISO 4401 and CETOP-RP 121 H
- For the leak-free isolation of two actuator ports

Type Z2SRK

Size			6	10
Operating pressure	p_{max}	bar	210	210
Opening pressure		bar	1.5	1.5
Flow	$q_{V \text{ max}}$	L/min	40	80



Detailed information:
 – Size 6: RE 21543
 – Size 10: RE 21549

Pilot operated check valves

- Sizes 6 to 32
- With optional leak-oil port
- With optional pre-decompression (sizes 10 to 32 only)
- For subplate mounting ("P"):
 - Size 6: Porting pattern DIN 24 340 form A, ISO 4401 and CETOP–RP 121 H, subplates to RE 45052
 - Sizes 10 to 32: Porting pattern DIN 24 340 form D, ISO 5781 and CETOP–RP 121 H, subplates to RE 45062
- For threaded connection ("G") (sizes 10 to 32 only)
- 4 different opening pressures



Detailed information:

- Size 6: RE 21460
- Sizes 10 to 32: RE 21468
- Sizes 52 to 150: on inquiry

Types SV and SL

Size	6	10	16
Series	6X	4X	4X
Operating pressure	p_{max} bar	315	315
Pilot control	p_{St} bar	5 to 315	5 to 315
Opening pressure	bar	1.5; 3; 7; 10	1.5; 3; 6; 10
Flow	"G" $q_{V max}$ L/min	–	150
	"P" $q_{V max}$ L/min	60	150
			350
			–
Size	20	25	32
Series	4X	4X	4X
Operating pressure	p_{max} bar	315	315
Pilot pressure	p_{St} bar	5 to 315	5 to 315
Opening pressure	bar	2.5; 5; 7.5; 10	2.5; 5; 8; 10
Flow	"G" $q_{V max}$ L/min	350	150
	"P" $q_{V max}$ L/min	350	150
			350
			–
Size	52 to 150		
Series	1X		
Operating pressure	p_{max} bar	315	
Pilot pressure	p_{St} bar	0.6 to 315	
Opening pressure	bar	1.3; 3 ¹⁾ ; 4.5 ¹⁾	
Flow	$q_{V max}$ L/min	700 to 6400	

¹⁾ not for sizes 125 and 150

Shut-off valves of sandwich plate design

- Sizes 6 and 10
- Spool and seat valve version
- Porting pattern to ISO 4401



Detailed information:
1987761012

Size	6	10
Operating pressure	p_{max} bar	250
Flow	$q_{V max}$ L/min	50
		100

Pre-fill valves

- Pilot operated check valve
 - For flanged connection
 - For tank installation

Type SF

Size	125 to 400		
Operating pressure	p_{\max}	bar	350



Detailed information:
RE 20482

Pre-fill valves

- Pilot operated check valve
 - For threaded connection (size 32)
 - For flanged connection (from size 40 on)
- For mounting directly onto the working cylinder
- With or without decompression
- Integrated high pressure port

Type SFA

Size	32 to 80		
Operating pressure	p_{\max}	bar	350



Detailed information:
RE 20485



Pre-fill valves

- Pilot operated check valve of sandwich plate design
 - For flanged connection
 - For in-line installation
- Solenoid operated unloading through built-on directional valve

Detailed information:
RE 20478

Types ZSF and ZSFW

Size	32 to 160
Operating pressure p_{\max} bar	350



Pre-fill valves

- Pilot operated check valve
 - For block installation
 - For integration into cylinder

Detailed information:
RE 20745

¹⁾ sizes 63 and 80
on inquiry

Type SFE

Size	25 to 80 ¹⁾
Operating pressure p_{\max} bar	350

Directional poppet valve, direct operated

- Sizes 6 and 10
- Porting pattern to DIN 24 340 form A, ISO 4401 and CETOP-RP 121 H
- Leak-free isolation of closed port
- Solenoids with detachable coil
- Pressure-tight chamber needs not to be opened for changing the coil (type SED)
- Reliable switching when under pressure over longer periods of standstill

Type SED

Size			6	10
Operating pressure	p_{\max}	bar	350	350
Flow	$q_{V \max}$	L/min	25	40

Type SEW

Size			6	10
Operating pressure	p_{\max}	bar	420/630	420/630
Flow	$q_{V \max}$	L/min	25	40



Detailed information:

Size 6

- Type SED: RE 22 049
- Type SEW: RE 22 058

Size 10

- Type SED: RE 22 045
- Type SEW: RE 22 075

Directional poppet valves, direct operated with mechanical or fluidic actuation

- Sizes 6 and 10
- Lever operation (type SMM)
- Hydraulic operation (type SH)
- Pneumatic operation (type SP)

Types SMM; SH and SP

Size			6	10
Operating pressure	p_{\max}	bar	420/630	420/630
Flow	$q_{V \max}$	L/min	25	40

Detailed information:
on inquiry



Directional spool valves, direct operated, with fluidic actuation

- Sizes 6 to 32
- Porting pattern to DIN 24 340 form A, ISO 4401 and CETOP-RP 121 H
- Optional stroke adjustment (types H-WH, WH; size 10)
- Position monitoring by inductive position switch
- Hydraulic operation (types WH and WHD)
- Pneumatic operation (types WN and WP)

Detailed information:
– Size 6
Types WH, WP: RE 22 282

– Size 10
Types WHD, WP, WN:
RE 22 331

– Sizes 10 to 32
Types H-WH, WH: RE 24 751

Types WH, WHD, WN and WP

Size			6	10	10	16
Type			WH, WP	WHD, WP, WN	H-WH, WH	H-WH, WH
Operating pressure	p_{\max}	bar	315	315	350/280	350/280
Flow	$q_{V \max}$	L/min	60	120	160	300
Size			22	25	32	
Type				H-WH, WH	H-WH, WH	H-WH, WH
Operating pressure	p_{\max}	bar		350/280	350/280	350/280
Flow	$q_{V \max}$	L/min		450	650	1100

Directional spool valves, direct operated, with mechanical or manual actuation

- Sizes 4 to 22
- Porting pattern to DIN 24 340 form A, ISO 4401 and CETOP-RP 121 H
- As cartridge valve (RE 23 140, version "K")
- Position monitoring by
 - inductive position switch or
 - mechanical position switch
- Operation by means of
 - lever (type WMM)
 - roller (type WMR, WMU)
 - rotary knob (type WMD)



Detailed information:
– Size 6: RE 22280
RE 22284
– Size 10: RE 22312
RE 22331
– Sizes 16 and 22:
RE 22371
– Size 32: RE 23778

Types WMM, WMR, WMU and WMD

Size			6	10	
Type			WMM, WMR, WMU, WMD		
Operating pressure	p_{\max}	bar	315	315	
Flow	$q_{V \max}$	L/min	60	120	
Size			16	22	32
Type			H-WMM	H-WMM	H-WMM
Operating pressure	p_{\max}	bar	350	350	350
Flow	$q_{V \max}$	L/min	300	450	1100

Directional spool valves, direct operated, with solenoid actuation

- Sizes 4 to 10
- Wet-pin AC or DC solenoids
- Solenoids with detachable coil
- For subplate mounting ("P"): Porting pattern to DIN 24 340 form A, ISO 4401 and CETOP-RP 121 H
- Electrical connection as individual connection or central connection
- Optional inductive position monitoring (RE 24830)
- Smooth switching characteristics ³⁾



Type WE

Size				4			
Version				"P"			
Operating pressure	p_{\max}	bar	210				
Flow	$q_{V \max}$	L/min	30				
Size				6			
Version				1)	2)	3)	4)
Operating pressure	p_{\max}	bar	315	350	350	315	
Flow	$q_{V \max}$	L/min	60	80	60	60	
Size				10			
Version				3)	5)	6)	
Operating pressure	p_{\max}	bar		315	315	315	
Flow	$q_{V \max}$	L/min		100	120	120	

Detailed information:

- Size 4:
RE 23161 ("P")
 - Size 6:
RE 23163 ¹⁾
RE 23178 ²⁾
RE 23183 ³⁾
RE 23178-00 ⁴⁾
 - Size 10:
RE 23183 ³⁾
RE 23327 ⁵⁾
RE 23351 ⁶⁾
- ¹⁾ standard valve, size 6 (DC solenoid only)
²⁾ heavy duty valve
³⁾ smoothly switching valve
⁴⁾ reduced electrical power consumption
⁵⁾ standard valve, size 10
⁶⁾ 5-chamber version (DC solenoid only)

Directional spool valves, pilot operated, with electrohydraulic actuation

- Sizes 10 to 102
- Wet-pin AC or DC solenoids
- Spring and/or pressure return of the main spool to the initial position
- Spring centering (sizes 10 and 22)
- Spring or pressure centering (sizes 16, 25 and 32)
- Optional manual override
- Porting pattern to DIN 24 340 form A, ISO 4401 and CETOP-RP 121 H
- Electrical connection as individual connection or central connection
- Optional switching time adjustment
- Stroke limitation of the main spool, optional (RE 24830)
- Stroke limitation and/or end position (sizes 16, 22, 25 and 32), optional (RE 24830)
- Position monitoring by means of inductive position switch (RE 24830)
- Preload valve in the P-channel of the main valve for sizes 16, 22, 25 and 32



Detailed information:

- Sizes 10 to 32:
RE 24751
- Sizes 52 to 102:
on inquiry
- Accessories:
RE 24830

Type WEH

Size			10	10		
Type			4WEH	H-4WEH		
Operating pressure	p_{\max}	bar	280	350		
Flow	$q_{V \max}$	L/min	160	160		
Size			16	16		
Type			4WEH	H-4WEH		
Operating pressure	p_{\max}	bar	280	350		
Flow	$q_{V \max}$	L/min	300	300		
Size			22	22		
Type			4WEH	H-4WEH		
Operating pressure	p_{\max}	bar	280	350		
Flow	$q_{V \max}$	L/min	450	450		
Size			25	32	32	
Type			H-4WEH	4WEH	H-4WEH	
Operating pressure	p_{\max}	bar	350	280	350	
Flow	$q_{V \max}$	L/min	650	1100	1100	
Size			52	62	82	102
Type			H-4WEH	H-4WEH	H-4WEH	H-4WEH
Operating pressure	p_{\max}	bar	350	350	350	350
Flow	$q_{V \max}$	L/min	2000	3000	4500	7000

Directional poppet valves, direct operated (high performance)

- Size 1
- Direct operated directional seat valve with solenoid actuation
- Leak-free isolation of closed port
- Reliable switching even after longer periods of time at rest
- Wet-pin DC solenoids
- Solenoid coil can be rotated
- With concealed manual override (optional)
- Leak-free on both sides (version 2/2)

Types KSDER and KSDEU

Version			2/2	3/2	2/2	3/2
Type			KSDER	KSDER	KSDEU	KSDEU
Operating pressure	p_{\max}	bar	350	350	500	500
Flow	$q_{V \max}$	L/min	20	12	12	6



Detailed information:
 Type KSDER
 – 2/2: RE 18136-02
 – 3/2: RE 18136-03
 Type KSDEU
 – 2/2: RE 18136-10
 – 3/2: RE 18136-11

Directional poppet valves, direct operated

- Size M20 x 1.5
- Direct operated directional poppet valve with solenoid actuation
- Leak-free isolation of closed port
- Reliable switching even after longer periods of time at rest
- Wet-pin DC solenoids
- Solenoid coil can be rotated
- With concealed manual override
- Leak-free on both sides

Type M20 x 1.5

Version			2/2
Operating pressure	p_{\max}	bar	160/270
Flow	$q_{V \max}$	L/min	30



Detailed information:
 RE 18136-18

Directional spool valves, direct operated (high performance)

- Size 1
- Direct operated directional spool valve with solenoid actuation
- Fluid can flow through the valve in both directions
- Positive overlap prevents switching shocks
- Wet-pin DC solenoids
- Solenoid coil can be rotated
- With concealed manual override (optional)



Detailed information:
 – 2/2: RE 18136-06
 – 3/2: RE 18136-04
 – 4/2: RE 18136-05

Type KKDER

Version			2/2	3/2	4/2
Operating pressure	p_{\max}	bar	350	350	350
Flow	$q_{V \max}$	L/min	40	60	50



Pressure relief valves, direct operated

- Sizes 6 to 30
- For subplate mounting ("P")
- For threaded connection ("G")
- As cartridge valve ("K")
- Valves in accordance with Pressure Equipment Directive 97/23/EC
- 3 optional pressure adjustment elements:
 - Threaded pin with hexagon socket and protective cap
 - Rotary knob / hand wheel
 - Lockable rotary knob

Type DBD

Size			6	8	10	15
Version			"P, G, K"	"G"	"P, G, K"	"G"
Operating pressure	p_{\max}	bar	400	400	630	400
Flow	$q_{V \max}$	L/min	50	120	120	250
Size			20	25	30	
Version			"P, G, K"	"G"	"P, G, K"	
Operating pressure	p_{\max}	bar	400	315	315	
Flow	$q_{V \max}$	L/min	250	330	330	



Detailed information:
RE 25402

Pressure relief valves, direct operated, (standard performance)

- Size 0
- Direct operated pressure relief valve with mechanical actuation
- High power density
- 4 different pressure stages
- Versatile use for simple pressure limitation function

Type KBD

Size			0
Operating pressure	p_{\max}	bar	350
Flow	$q_{V \max}$	L/min	40



Detailed information:
RE 18105-01



Detailed information:
1987761105

Pilot pressure control valves

- Size 6
- For mounting onto valve cover
- Pressure relief function with up to 2 pressure stages and various directional valve controls
- Pilot control also via proportional valves
- Realization of cuttin-in and cutting-off functions

Size			6
Operating pressure	p_{\max}	bar	315

Pressure relief valves, pilot operated

- Sizes 6 to 30
- For subplate mounting ("P"): Porting pattern to DIN 24 340 form E, ISO 6264 and CETOP-RP 121 H
- For block installation ("C")
- For threaded connection ("G")
- As cartridge valve ("K")
- Solenoid operated unloading via built-on directional spool valve or directional poppet valve
- Switching shock damping, optional (type DBW. only)
- Valves in accordance with Pressure Equipment Directive 97/23/EC
- 4 pressure adjustment elements, optional:
 - Rotary knob
 - Sleeve with hexagon and protective cap
 - Lockable rotary knob with scale
 - Rotary knob with scale



Detailed information:
 – Sizes 6 and 10:
Series 4X ("K"
only) RE 25731 ³⁾
 – Sizes 10 to 30:
Series 5X: RE 25802 ¹⁾
 – Sizes 10, 15, 20:
Series 4X: RE 25818 ²⁾
 – Size 20
Series 1X ("K"
only):RE 25818 ⁴⁾

Types DB, DBW

Size			6³⁾	10³⁾	20⁴⁾			
Operating pressure	p_{\max}	bar	315	315	350			
Flow	"K"	$q_{V \max}$	L/min	60	100	300		
Size			10²⁾	15²⁾	20²⁾			
Operating pressure	p_{\max}	bar	350	350	350			
Flow	"P"	$q_{V \max}$	L/min	200	–	400		
	"G"	$q_{V \max}$	L/min	150	300	300		
Size			10¹⁾	15¹⁾	20¹⁾	25¹⁾	30¹⁾	
Operating pressure	p_{\max}	bar	350	350	350	350	350	
Flow	"P"	$q_{V \max}$	L/min	250	–	500	–	650
	"G"	$q_{V \max}$	L/min	250	500	500	500	650
	"C"	$q_{V \max}$	L/min	215	–	–	–	650

Pressure relief valves of sandwich plate design, pilot operated

- Sizes 6 and 10
- Porting pattern to DIN 24 340 form A, ISO 4401 and CETOP-RP 121 H
- 4 pressure stages: 50, 100, 200, 315 bar
- 5 pressure relief functions:
 - A – T, P – T, B – T, A – T and B – T, A – B and B – A
- 4 adjustment elements:
 - Rotary knob
 - Sleeve with hexagon and protective cap
 - Lockable rotary knob with scale
 - Rotary knob with scale



Types ZDB and Z2DB

Size	6	10	
Operating pressure p_{\max}	bar	315	315
Flow $q_{V \max}$	L/min	60	100

Detailed information:

- Size 6: RE 25751
- Size 10: RE 25761

Pressure relief valves of sandwich plate design, pilot operated (210 bar series)

- Sizes 6 and 10
- Porting pattern to DIN 24 340 form A, ISO 4401 and CETOP-RP 121 H
- 5 pressure relief functions:
 - A – T, P – T, B – T, A – T and B – T, A – B and B – A
- 3 pressure stages: 50, 100, 210 bar



Types ZDBK and Z2DBK

Size	6	10	
Operating pressure p_{\max}	bar	210	210
Flow $q_{V \max}$	L/min	40	80

Detailed information:

- Size 6: RE 25754
- Size 10: RE 25764

Pressure relief valves, direct operated



Detailed information:
1987760711

¹⁾ horizontal and vertical versions

- Sizes 6 and 10
- For subplate mounting ("P")
- For threaded connection ("G")
- As cartridge valve ("K")
- Valves in accordance with Pressure Equipment Directive 97/23/EG
- Adjustment elements, optional:
 - Grub screw with slot and protective cap
 - Grub screw with hexagon socket
 - Rotary knob / hand wheel
 - Lockable rotary knob

Size			6	6	10	10
Version			"K, G"	"P" ¹⁾	"K, G"	"P"
Operating pressure	p_{\max}	bar	350	315	350	300
Flow	$q_{V \max}$	L/min	60	60	120	120

Pressure relief valves of sandwich plate design, direct operated



Detailed information:
1987761012

- Sizes 6 and 10
- Porting pattern to ISO 4401
- 3 pressure stages: 80, 160, 315 bar
- 5 pressure relief functions:
 - A – T, P – T, B – T, A – T and B – T, A – B and B – A
- Adjustment elements:
 - Grub screw with hexagon socket
 - Rotary knob with scale
 - Lockable rotary knob with scale

Size			6	10
Operating pressure	p_{\max}	bar	315	315
Flow	$q_{V \max}$	L/min	60	90/120

Pump safety block, pilot operated

- Sizes 16 to 32
- For direct mounting to the SAE pressure port of the pump
- Zero-pressure start-up and circulation of the pump
- Solenoid operated unloading via built-on directional spool valve or directional poppet valve
- Electrical monitoring of the set pressure
- Proportional pressure limitation and unloading using external or integral control electronics
- Valves in accordance with Pressure Equipment Directive 97/23/EC

Types DBA, DBAW and DBAE

Size			16	25	32
Operating pressure	p_{\max}	bar	350	350	350
Flow	$q_{V \max}$	L/min	300	400	400



Detailed information:
RE 25890

Pump safety block, pilot operated

- Sizes 32 and 40
- For direct mounting to the SAE pressure port of the pump
- Zero-pressure start-up and circulation of the pump
- With integrated check valve
- Solenoid operated unloading via built-on directional spool valve or directional poppet valve
- Switching shock damping, optional (type DBAW only)
- Valves in accordance with Pressure Equipment Directive 97/23/EC
- 4 pressure adjustment elements, optional:
 - Rotary knob
 - Sleeve with hexagon and protective cap
 - Lockable rotary knob with scale
 - Rotary knob with scale

Types DBA, DBAW

Size			32	40	
Operating pressure	p_{\max}	bar	420	420	
Flow	– without check valve	$q_{V \max}$	L/min	600	650
	– with check valve	$q_{V \max}$	L/min	350	450



Detailed information:
RE 25880

Pressure reducing valves, pilot operated

- Sizes 10 to 30
- For subplate mounting ("P"): Porting pattern to DIN 24 340 form D, ISO 5781 and CETOP-RP 121 H
- For block installation ("C")
- For threaded connection ("G")
- As cartridge valve ("K")
- 4 pressure stages
- 4 pressure adjustment elements, optional:
 - Rotary knob
 - Sleeve with hexagon and protective cap
 - Lockable rotary knob with scale
 - Rotary knob with scale
- Check valve, optional (with version "P" only)



Detailed information:
 – Size 10, series 3X ("K" only): RE 26850 ¹⁾
 – Size 10; 15; 20, series 4X: RE 26893 ²⁾
 – Size 10 to 30, series 5X: RE 26892 ³⁾

Type DR

Size			10 ¹⁾	10 ²⁾	15 ²⁾	20 ²⁾		
Secondary pressure, adjustable	p_{\max}	bar	350	315	350	315		
Flow	"P"	$q_{V \max}$	L/min	150	80	–	160	
	"G"	$q_{V \max}$	L/min	150	80	160	160	
	"K"	$q_{V \max}$	L/min	100	100	–	160	
Size			10 ³⁾	15 ³⁾	20 ³⁾	25 ³⁾	30 ³⁾	
Secondary pressure, adjustable	p_{\max}	bar	350	350	350	350	350	
Flow	"P"	$q_{V \max}$	L/min	150	–	300	–	400
	"G"	$q_{V \max}$	L/min	150	300	300	400	400
	"C"	$q_{V \max}$	L/min	–	–	–	–	400

Pressure reducing valves, direct operated

- Sizes 6 and 10
- Porting pattern
 - Size 6 to DIN 24 340 form A, ISO 4401 and CETOP-RP 121 H
 - Size 10 to DIN 24 340 form D, ISO 5781 and CETOP-RP 121 H
- 5 pressure stages
- 4 pressure adjustment elements, optional:
 - Rotary knob
 - Sleeve with hexagon and protective cap
 - Lockable rotary knob with scale
 - Rotary knob with scale
- Check valve, optional



Detailed information:
 – Size 6: RE 26564
 – Size 10: RE 26580

Type DR.DP

Size			6	10
Series			5X	4X
Secondary pressure, adjustable	p_{\max}	bar	315	210
Flow	$q_{V \max}$	L/min	60	80

Pressure reducing valves of sandwich plate design, direct operated

- Sizes 6 and 10
- Porting pattern to DIN 24 340 form A, ISO 4401 and CETOP-RP 121 H
- Pressure reduction in channel A, B or P
- 4 pressure stages: 25, 75, 150, 210 bar
- 4 adjustment elements:
 - Rotary knob
 - Sleeve with hexagon and protective cap
 - Lockable rotary knob with scale
 - Rotary knob with scale
- Check valve, optional



Type ZDR.D

Size			6	10
Series			4X	5X
Operating pressure	p_{\max}	bar	210	210
Flow	$q_{V \max}$	L/min	50	80

Detailed information:
 – Size 6: RE 26570
 – Size 10: RE 26585

Pressure reducing valves of sandwich plate design, pilot operated

- Size 10
- Porting pattern to DIN 24 340 form A, ISO 4401 and CETOP-RP 121 H
- Pressure reduction in channel A, B or P
- 4 pressure stages: 50, 100, 200, 315 bar
- 4 adjustment elements:
 - Rotary knob
 - Sleeve with hexagon and protective cap
 - Lockable rotary knob with scale
 - Rotary knob with scale
- Check valve, optional



Type ZDR10V

Size			10
Operating pressure	p_{\max}	bar	315
Flow	$q_{V \max}$	L/min	100

Detailed information:
 RE 26861



Pressure reducing valves of sandwich plate design, pilot operated (210 bar series)

- Sizes 6 and 10
- Porting pattern to DIN 24 340 form A, ISO 4401 and CETOP-RP 121 H
- Pressure reduction in channel A, B or P
(with size 6, P channel only)
- 3 pressure stages: 50, 100, 210 bar
- Pressure gauge connection

Type ZDRK.V

Detailed information:
 – Size 6: RE 26572
 – Size 10: RE 26864

Size	6	10	
Operating pressure p_{\max}	bar	210	210
Flow $q_{V\max}$	L/min	40	80

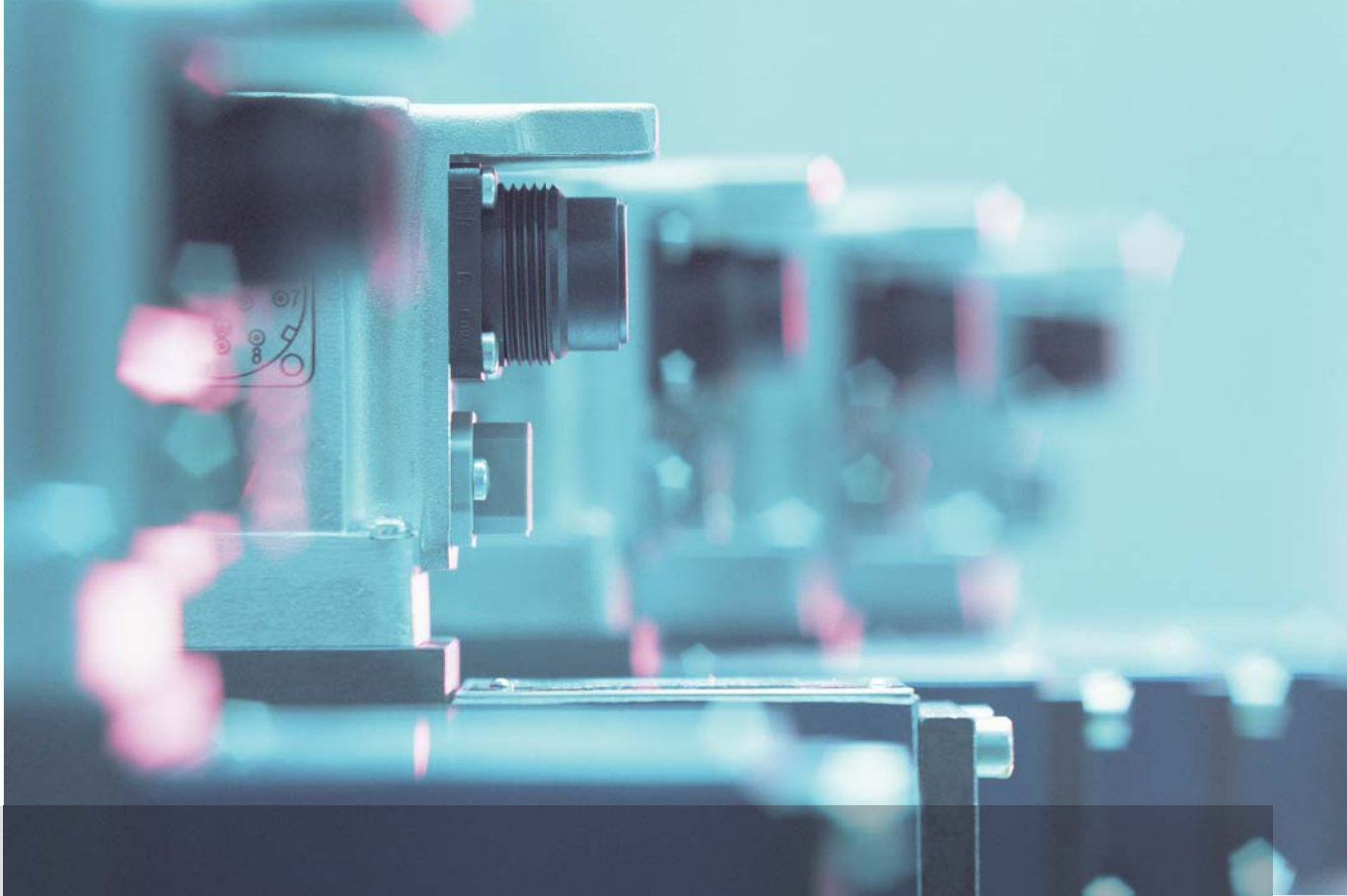

Proportional, high-response and servo-valves

Proportional valves

Many controls would hardly be conceivable without proportional valves with integral electronics (OBE). They reduce the cabling effort and simplify handling while offering exact reproducibility and low manufacturing tolerances.

Performance profile

- Pressure and flow control and directional valve variants in sizes 6 to 52
- Maximum flow 2800 L/min
- Maximum operating pressure 350 bar
- Proportional solenoid with electrical closed-loop position control for high accuracies (> 1 %)
- Rugged electronics for stationary and mobile applications

High-response valves

High-response valves are compact and robust. They are convincing in their high dynamics and control accuracy. The core product of size 6 and size 10 can be combined with main stages of up to size 160 with a nominal flow of up to 18000 litres.

Performance profile

- Maximum flow 50000 L/min
- Maximum operating pressure 420 bar
- Sizes 6 to 160
- Highly dynamic valves with zero overlap for use in closed control loops
- Direct and pilot operated
- For subplate mounting and block installation

Servo-valves

Servo-valves are hydraulically pilot operated 2- or 3-stage directional valves with porting pattern to DIN 24340 form A. They are mainly used for closed loop-controls of position, force or pressure and velocity.

They are characterized by:

- Compact build
- Low electrical power consumption
- High dynamics and
- Excellent quasi-steady-state values

Performance profile

- Maximum flow 1600 L/min
- Maximum operating pressure 315 bar
- Sizes 6 to 32



Detailed information:
RE 29055

Proportional directional valves, direct operated, without electrical position feedback

- Sizes 6 and 10
- Porting pattern to DIN 24 340, form A
- Control of the direction and magnitude of a flow
- Proportional solenoid operation
- Spring-centered control spool
- Different spool overlaps possible
- Integral control electronics for type 4WRAE

Types 4WRAE, 4WRA

Size				6	10
Operating pressure		p_{\max}	bar	315	315
Nominal flow	($\Delta p = 10$ bar)	$q_{V, \text{nom}}$	L/min	7, 15, 26	30, 60
Maximum hysteresis			%	5	5
Step response	0 to 90 %	$T_u + T_g$	ms	< 40	< 140
Operating voltage		U	V	24	24
Comm. value signal	Type 4WRAE	U	V	± 10	± 10
		I	mA	4 to 20	4 to 20
Control electronics	Type 4WRA	analogue		VT-VSPA / VT-MSPA-2	VT-VSPA
		digital		VT-VSPD-1	VT-VRPD2-1



Detailed information:
RE 29055-02-M

Proportional directional valves, direct operated, without electrical position feedback, with bus interface

- Sizes 6 and 10
- Porting pattern to DIN 24 340, form A
- Version for CAN bus with CANopen protocol (DS 408)
- Separate plugs for power supply and bus connection
- Command value feedforward analogue or via bus
- Zero point correction and overlap compensation can be parameterized via bus

Type 4WRAF

Size				6	10
Operating pressure		p_{\max}	bar	315	315
Nominal flow	($\Delta p = 10$ bar)	$q_{V, \text{nom}}$	L/min	7, 15, 26	30, 60
Maximum hysteresis			%	5	5
Step response	0 to 90 %	$T_u + T_g$	ms	< 40	< 140
Operating voltage		U	V	24	24

Proportional directional valves, direct operated, with electrical position feedback

- Sizes 6 and 10
- Porting pattern to DIN 24 340, form A
- Control of the direction and magnitude of a flow
- Proportional solenoid operation
- Spring-centered control spool
- Different spool overlaps possible
- Position sensing of the control spool via inductive position transducer
- Integral control electronics for type 4WREE

Types 4WRE, 4WREE

Size			6	10
Operating pressure	p_{\max}	bar	315	315
Nominal flow ($\Delta p = 10$ bar)	$q_{V \text{ nom}}$	L/min	8, 16, 32	25; 50; 75
Maximum hysteresis		%	0.1	0.1
Step response 0 to 90 %	$T_u + T_g$	ms	20	40
Operating voltage	U	V	24	24
	I	mA	< 2	< 2
Comm. value signal	U	V	± 10	± 10
	I	mA	4 to 20	4 to 20
Control electronics	Type 4WRE	analogue	VT-RPA2 / VT-MRAP2	VT-VSPA
		digital	VT-VRPD2	VT-VRPD2

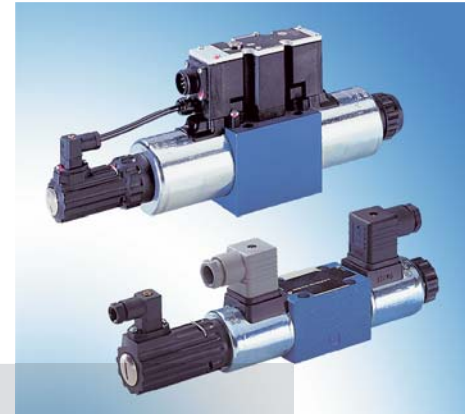

Detailed information:
RE 29061

Proportional directional valves, direct operated, with electrical position feedback and bus interface

- Sizes 6 and 10
- Porting pattern to DIN 24 340, form A
- Version for CAN bus with CANopen protocol (DS 408)
- Separate plugs for power supply and bus connection
- Command value feedforward analogue or via bus
- Zero point correction and overlap compensation can be parameterized via bus

Type 4WREF

Size			6	10
Operating pressure	p_{\max}	bar	315	315
Nominal flow ($\Delta p = 10$ bar)	$q_{V \text{ nom}}$	L/min	8, 16, 32	25, 50, 75
Maximum hysteresis		%	0.1	0.1
Step response 0 to 90 %	$T_u + T_g$	ms	20	40
Operating voltage	U	V	24	24
	I	mA	< 2	< 2
Comm. value signal	U	V	± 10	± 10
	I	mA	4 to 20	4 to 20



Detailed information:
RE 29015-Z
CANopen protocol

Proportional directional valves, direct operated, with integral control electronics, electrical position feedback and spool position monitoring

- Sizes 6 and 10
- Porting pattern to DIN 24 340, form A, ISO 4401 and CETOP-RP 121 H
- Control of the direction and magnitude of a flow
- Proportional solenoid operation
- Spring-centered control spool
- Different spool overlaps possible
- Deadband compensation firmly set in the factory

Detailed information:
RE 29064

Type 4WREEM

Size			6	10	
Operating pressure	p_{\max}	bar	315	315	
Nominal flow	($\Delta p = 10$ bar)	$q_{V\text{ nom}}$	L/min	8, 16, 32	25, 50, 75
Maximum hysteresis		%	≤ 0.1	≤ 0.1	
Step response	0 to 90 %	$T_u + T_g$	ms	20	40
Operating voltage	U	V	24	24	
Comm. value signal	U	V	± 10	± 10	

Proportional directional valves, direct operated with integral control electronics, el. position feedback and closed-loop control of pressures

- Sizes 6 and 10
- Porting pattern to DIN 24 340, form A, ISO 4401 and CETOP-RP 121 H
- Closed loop control in A and B, and, if applicable, area-related differential pressure
- Integral digital control electronics
- 1 to 4 integrated pressure sensors or one external pressure sensor
- Version for CAN bus with protocol CANopen (DS-408) or Profibus DP (on inquiry)
- All parameters (ramps, controllers,...) can be adjusted via the field bus interface
- Extended diagnosis functions via field bus

Detailed information:
RE 29050

Type 4WREQ

Size			6	10	
Operating pressure	p_{\max}	bar	315	315	
Nominal flow	($\Delta p = 10$ bar)	$q_{V\text{ nom}}$	L/min	8, 16, 32	25, 50, 75
Maximum hysteresis		%	0.1	0.1	
Step response	0 to 90 %	$T_u + T_g$	ms	20	40
Operating voltage	U	V	24	24	
	I	mA	< 2	< 2	
Comm. value signal	Min. comm. value	V	± 10	± 10	
	Flow comm. value	mA	4 to 20	4 to 20	
	Press. comm. value	V	0 to 10	0 to 10	

Proportional directional valves, pilot operated, without electrical position feedback

- Sizes 10 to 52
- Porting pattern to DIN 24 340, form A
- Control of the direction and magnitude of a flow
- Pilot control via a 3-way pressure reducing valve
- Spring-centering and anti-rotation protection of the main spool
- Different spool overlaps possible
- Optionally with integral electronics

Types 4WRH, 4WRZ, 4WRZE

Size			10	16	25	32	52	
Operating pressure	p_{\max}	bar	315	250	250	250	250	
Nominal flow	($\Delta p = 10$ bar)	$q_{V \text{ nom}}$	L/min	25, 50, 85	100, 150	220, 325	360, 520	1000
Maximum hysteresis		%	6	6	6	6	6	
Step response	0 to 90 %	$T_u + T_g$	ms	40	70	90	170	450
Operating voltage	U	V	24	24	24	24	24	
Control electronics	Type 4WRZ	analogue				VT-VSPA2		
		digital				VT-VSPD-1		
		modular design				VT 11118, VT 11011		

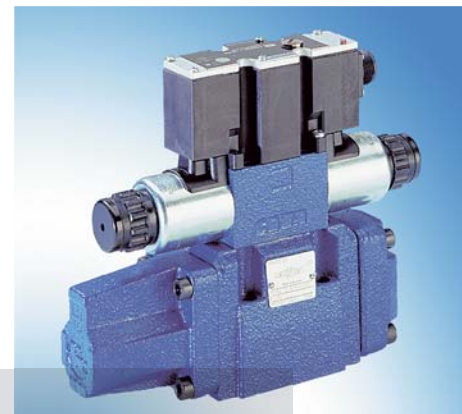

Detailed information:
RE 29115

Proportional directional valves, pilot operated, without electrical position feedback and bus interface

- Sizes 10 to 52
- Porting pattern to DIN 24 340, form A
- Version for CAN bus with CANopen protocol (DS 408)
- Separate plugs for power supply and bus connection
- Command value feedforward analogue or via bus
- Zero point correction and overlap compensation can be parameterized via bus

Type 4WRZF

Size			10	16	25	32	52	
Operating pressure	p_{\max}	bar	315	250	250	250	250	
Nominal flow	($\Delta p = 10$ bar)	$q_{V \text{ nom}}$	L/min	25, 50, 85	100, 150	220, 325	360, 520	1000
Maximum hysteresis		%	6	6	6	6	6	
Step response	0 to 90 %	$T_u + T_g$	ms	40	70	90	170	450
Operating voltage	U	V	24	24	24	24	24	

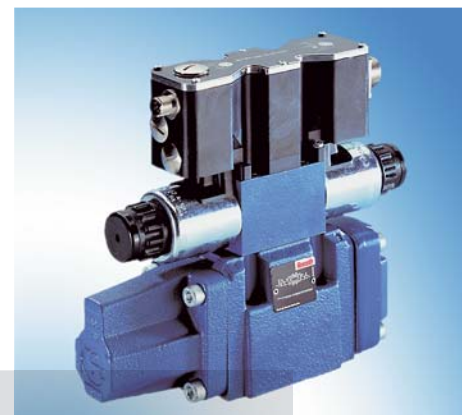

Detailed information:
RE 29015-Z
CANopen protocol

Proportional directional valves, pilot operated, with OBE and spool position monitoring

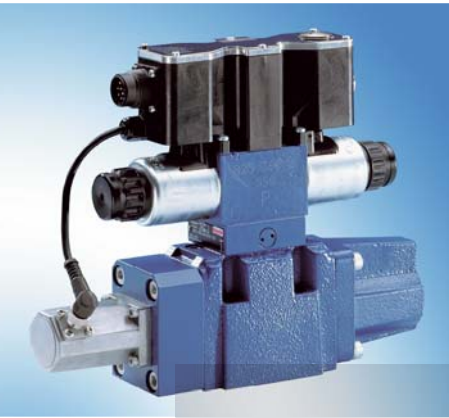

Detailed information:
RE 29117

- Sizes 10 to 32
- Porting pattern to DIN 24 340, form A, ISO 4401 and CETOP-RP 121 H
- Control of the direction and magnitude of a flow
- Pilot control via 3-way pressure reducing valve
- Spring centering and anti-rotation feature of the main spool
- With test certificate issued by TÜV Nord
- Clear spool position monitoring
- Deadband compensation firmly set in the factory

Type 4WRZEM

Size			10	16	25	32	
Operating pressure	p_{\max}	bar	315	350	350	350	
Nominal flow	($\Delta p = 10$ bar)	$q_{V \text{ nom}}$	L/min	25, 50, 85	100, 150	220, 325	350, 520
Maximum hysteresis			%	6	6	6	6
Step response	0 to 90 %	$T_u + T_g$	ms	40	70	90	170
Operating voltage	U	V		24	24	24	24

Proportional directional valves, pilot operated, with electrical position feedback

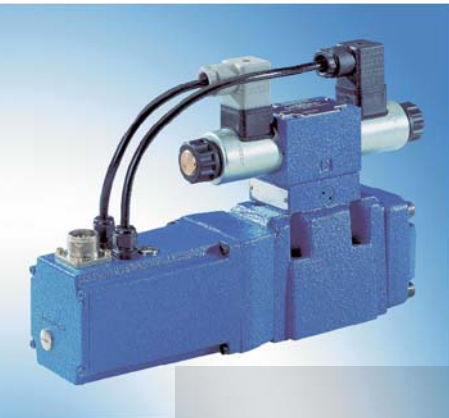

Detailed information:
RE 29075

- Sizes 10 to 35
- Porting pattern to DIN 24 340, form A
- Control of the direction and magnitude of a flow
- Pilot control via 3-way proportional directional valve without position feedback
- Spring-centering of the main spool
- Position sensing of the main spool via inductive position transducer
- Superimposed solenoid/direction cut-off using an ISA adapter for an independent shutdown function

Type 4WRKE

Size			10	16	25	27	32	35	
Operating pressure	p_{\max}	bar	315	350	350	210	350	350	
Nominal flow	($\Delta p = 10$ bar)	$q_{V \text{ nom}}$	L/min	25, 50, 100	125, 200	220, 350	500	400, 600	1000
Maximum hysteresis			%	1	1	1	1	1	1
Step response	0 to 90 %	$T_u + T_g$	ms	20	30	50	50	80	120
Supply voltage	U	V		24	24	24	24	24	24
Comm. value signal	U	V		± 10	± 10	± 10	± 10	± 10	± 10
	I	mA					4 to 20		

2/2 proportional directional valves, direct operated (high performance)

- Size 1
- Direct operated proportional valve for controlling the magnitude of a flow
- Proportional solenoid with central thread and detachable coil
- Solenoid coil can be rotated
- Flow in both directions
- With concealed override, optional

Type KKDSR

Size			1	1
Version			N	P
Operating pressure		p_{\max} bar	350	350
Nominal flow	1 → 2	$q_{V \text{ nom}}$ L/min	38	32
	2 → 1	$q_{V \text{ nom}}$ L/min	34	45
Maximum hysteresis			5	5
Step response	0 to 100 %	$T_u + T_g$ ms	< 65	< 65
	100 to 0 %	$T_u + T_g$ ms	< 65	< 65
Operating voltage	U	V	24	24
Comm. value signal	U	V	0 to + 10	0 to + 10
Control electronics	Modular amp.		VT-MSPA1	VT-MSPA1
	Plug-in amplifier		VT-SSPA1	VT-SSPA1



Detailed information:
RE 18139-06



Proportional pressure relief valves, direct operated

- Size 6
- Porting pattern to DIN 24 340, form A and ISO 4401
- Valve for limiting a system pressure
- Proportional solenoid operation
- For subplate mounting

Detailed information:
RE 29164

Type DBEP

Size			6
Operating pressure	p_{\max}	bar	100
Flow	$q_{V \max}$	L/min	8
Maximum hysteresis		%	≤ 3
Operating voltage	U	V	24
Comm. value signal	U	V	0 to + 10
Control electronics	analogue		VT-VSPA1-1 and VT 3000
	digital		VT-VSPD-1



Proportional pressure relief valves, direct operated

- Size 6
- Porting pattern to DIN 24 340, form A, ISO 4401 and CETOP-RP 121 H
- Valve for limiting a system pressure
- Proportional solenoid operation
- For subplate mounting
- Integral control electronics for type DBETE
- Linearized pressure/command value characteristic curve
- Also available as screw-in cartridge valve

Detailed information:
RE 29162

Types DBET and DBETE

Size			6
Operating pressure	p_{\max}	bar	350
Flow	$q_{V \max}$	L/min	50/80
Maximum hysteresis		%	< 4 of maximum set pressure
Step response	0 to 100 % 100 to 0 %	$T_u + T_g$	ms 70 (depending on system)
Operating voltage	U	V	24
Comm. value signal	U	V	0 to 10
	I	mA	4 to 20
Control electronics	type DBET	analogue	VT-VSPA1-2-1X
		modular design	VT-MSPA1-1-1X

Proportional pressure relief valves, pilot operated

- Size 6
- Porting pattern to DIN 24 340, form A
- Valve for limiting a system pressure
- Proportional solenoid operation
- For subplate mounting, types DBE and DBEE
- Sandwich plate version, types ZDBE and ZDBEE
- Integral control electronics for types DBEE and ZDBEE
- Linearized pressure/command value characteristic curve



Types (Z)DBE and (Z)DBEE

Size		6		
Operating pressure	p_{max}	bar	315	
Flow	$q_{V max}$	L/min	30	
Maximum hysteresis		%	± 1,5	
Step response	10 to 90 %	T_u+T_g	ms	80 (depending on system)
	90 to 10 %	T_u+T_g	ms	50 (depending on system)
Operating voltage	U	V	24	
Comm. value signal	U	V	0 to 10	
Control electronics	Type (Z)DBE	analogue	VT-VSPA	
		digital	VT-VSPD-1	
		modular design	VT 11131	

Detailed information:
RE 29158

Proportional pressure relief valves, pilot operated

- Sizes 10 to 32
- Porting pattern to DIN 24 340, form E
- Valve for limiting a system pressure
- Proportional solenoid operation
- For subplate mounting
- Maximum pressure relief function with types DBEM and DBEME
- Integral control electronics for types DBEE and DBEME
- Linearized pressure/command value characteristic curve (sizes 10 and 25)

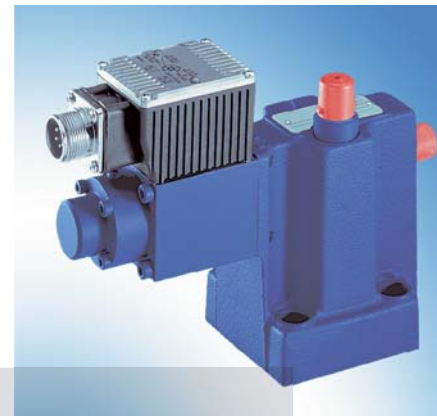

Types DBE(M) and DBE(M)E

Size		10			25			32				
Operating pressure	p_{max}	bar	350			350			350			
Flow	$q_{V max}$	L/min	200			400			600			
Maximum hysteresis		%	± 1.5			± 1.5			± 1.5			
Step response	0 to 100 %	T_u+T_g	ms	150 (depending on system)								
	100 to 0 %											
Operating voltage	U	V	24			24			24			
Comm. value signal	U	V	0 to 10			0 to 10			0 to 10			
Control electronics	Type DBE	analogue	VT-VSPA1-1			VT-VSPA1-1			VT-VSPA1-1			
		digital	VT-VSPD-1			VT-VSPD-1			VT-VSPD-1			
		modular design	VT 11131			VT 11131			VT 11030			

Detailed information:
– Sizes 10 and 25:
RE 29160
– Size 32: RE 29142



Detailed information:
1987761317 Chapter 1,
pages 15 and 25

Proportional pressure relief valves, direct operated, with closed-loop position control

- Size 6
- With or without OBE
- Proportional solenoid operation
- Series: Standard characteristic curve with OBE
- Electronics: Printed circuit board or integrated electronics
- Cone seat valve with compression spring

Type PV1-DBV

Size		6		
Pressure stages		bar	50, 80, 180, 250, 315	
Flow		$q_{V \max}$	L/min	1
Maximum hysteresis		%	< 1 (with OBE < 0,2)	
Actuating time	0 to 100 %	Standard char.	ms	45
		Linear char.	ms	45
		Char. curve with OBE	ms	35
Command value signal	standard	U	V	0 to 10
	with OBE	I	mA	4 to 20



Detailed information:
RE 18139-05

Proportional pressure relief valves, direct operated, falling characteristic curve (standard performance)

- Direct operated valves for limiting a system pressure
- Proportional solenoid operation
- Proportional solenoid with central thread and detachable coil
- Screw-in cartridge valve
- Fine-balancing of command value/pressure characteristic curve externally on the control electronics
- Valves can be adjusted to maximum pressure by means of an adjustment spindle
- In the event of a power failure, the max. set pressure is obtained

Type KBPS.8

Size		Pilot valve		
Operating pressure		p_{\max}	bar	420
Flow		$q_{V \max}$	L/min	2
Maximum hysteresis		%	4	
Step response	0 to 100 %	$T_u + T_g$	ms	< 70
	100 to 0 %	$T_u + T_g$	ms	< 70
Operating voltage		U	V	24
Comm. value signal		U	V	0 to + 10
Control electronics		Plug-in amplifier	VT-SSPA1	

Proportional pressure relief valves, pilot operated

- Size 6
- Proportional solenoid operation
- Series: With closed-loop position control and OBE
- Pilot control supplied internally from "P"
- Electronics for series with closed-loop position control electronics: Integral electronics

Type PV2-DBV

Size				6
Pressure stages			bar	80, 180, 315
Flow			$q_{V \max}$ L/min	40
Maximum hysteresis			%	< 1
Actuating time	0 to 100 %	without position control	ms	70
Comm. value signal			U V	0 to 10



Detailed information:
1987761317 Chapter 2

Proportional pressure relief valves, pilot operated

- Size 10
- Porting pattern to ISO 5781-AG-06-2-A
- Proportional solenoid operation
- Series: With closed-loop position control or with closed-loop position control and OBE

Type PV1-DBV

Size				10
Pressure stages			bar	180, 315
Flow			$q_{V \max}$ L/min	120 to 300
Maximum hysteresis			%	1
Actuating time	0 to 100 %		ms	80
Comm. value signal	standard with OBE		U V	0 to 10
			I mA	4 to 20



Detailed information:
1987761317 Chapter 3



Detailed information:
RE 29184

Proportional pressure reducing valves, direct operated

- Size 6
- Porting pattern to DIN 24 340, form A, ISO 4401 and CETOP-RP 121 H
- Valve for reducing a system pressure
- Proportional solenoid operation
- For subplate mounting
- With or without OBE

Types 3DREP, 3DREPE

Size			6
Operating pressure	p_{\max}	bar	100
Flow	$q_{V \max}$	L/min	15
Maximum hysteresis		%	5
Operating voltage	U	V	24
Comm. value signal	U	V	± 10
	I	mA	4 to 20
Control electronics	Type 3DREP	analogue	VT-VSPA2-5.
		digital	VT-VSPD1
		modular design	VT 11118



Detailed information:
on inquiry

Proportional pressure reducing valves, direct operated

- Size 6
- Porting pattern to DIN 24 340, form A
- Version for CAN bus with CANopen protocol (DS 408)
- Separate plugs for power supply and bus connection
- Command value feedforward analogue or via bus
- Zero point correction and overlap compensation can be parameterized via bus

Type 3DREPF

Size			6	
Operating pressure	p_{\max}	bar	315	
Nominal flow	($\Delta p = 10$ bar)	$q_{V \text{ nom}}$	L/min	7, 15, 26
Maximum hysteresis		%	5	
Step response	0 to 90 %	$T_u + T_g$	ms	< 40
Operating voltage	U	V	24	
Comm. value signal	U	V	± 10	
	I	mA	4 to 20	

Proportional pressure reducing valves, pilot operated

- Sizes 6 and 10
- Porting pattern to DIN 24 340, form A
- Valve for reducing a system pressure
- Proportional solenoid operation
- For subplate mounting, type DRE 6
- Sandwich plate version, types ZDRE 6 and 10
- Linearized pressure/command value characteristic curve
- Integral control electronics for type ZDREE 10

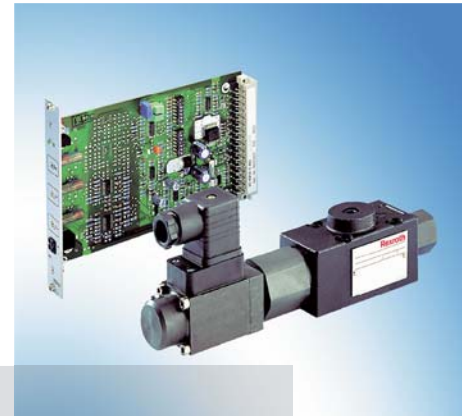

Type (Z)DRE (E)

Size			6	10 ¹⁾
Operating pressure	p_{max}	bar	210	315
Flow	$q_{V max}$	L/min	30	80
Maximum hysteresis		%	± 2	± 1,5
Operating voltage	U	V	24	22 to 33
Comm. value signal	U	V	–	0 to 10
Control electronics	analogue		VT-VSPA1(K)-1	VT-VSPA1(K)-1
	digital		VT-VSPD-1	VT-VSPD-1
	modular design		VT 11132	VT 11131

Detailed information:
 – Size 6: RE 29175
 – Size 10: RE 29179

¹⁾ available only in sandwich plate design

Proportional pressure reducing valves, pilot operated

- Sizes 10 to 32
- Porting pattern to DIN 24 340, form D
- Valve for reducing a system pressure
- Proportional solenoid operation
- For subplate mounting
- Linearized pressure/command value characteristic curve
- Maximum pressure relief function with types DREM and DREME
- Optional check valve between port A and B
- OBE for types DREE and DREME



Types DRE(M) and DRE(M)E

Size			10	25	32
Operating pressure	p_{max}	bar	315	315	315
Flow	$q_{V max}$	L/min	200	300	300
Maximum hysteresis		%	± 2,5	± 2,5	± 2,5
Operating voltage	U	V	24	24	24
Comm. value signal	Type DRE(M)E	U V	0 to 10	0 to 10	0 to 10
Control electronics	Type DRE(M)	analogue	VT-VSPA1(K)	VT-VSPA1(K)	VT-VSPA1(K)
		digital	VT-VSPD-1	VT-VSPD-1	VT-VSPD-1
		modular design	VT 11724	VT 11724	VT 11030

Detailed information:
 – Sizes 10 and 25:
 RE 29176
 – Size 32: RE 29178



Proportional pressure reducing valves, pilot operated

- Sizes 10 and 16
- Porting pattern to DIN 24 340, form A, ISO 4401 and CETOP-RP 121 H
- Valve for reducing a system pressure
- Proportional solenoid operation
- For subplate mounting
- OBE for types 3DREE and 3DREME

Detailed information:
RE 29186

Types 3DRE(M) and 3DRE(M)E

Size				10	16
Operating pressure		p_{\max}	bar	315	315
Flow	$\Delta p = 10$ bar	$q_{V \text{ nom}}$	L/min	125	300
Maximum hysteresis			%	± 2	± 2
Operating voltage		U	V	24	24
Comm. value signal	Type 3DRE(M)E	U	V	0 to 10	0 to 10
Control electronics	Type 3DRE(M)	analogue		VT-VSPA1(K) and VT 11131	
		digital		VT-VSPD-1	VT-VSPD-1

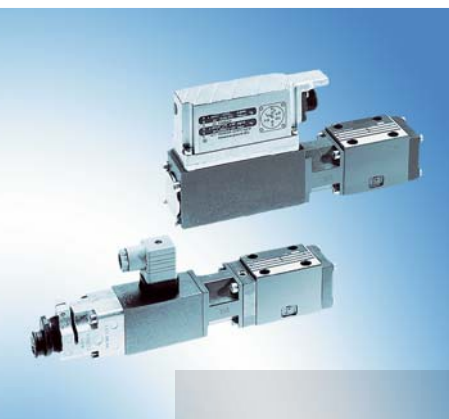

Proportional 3-way pressure reducing valves, pilot operated

- Size 6
- Proportional solenoid operation
- Series: With closed-loop position control or with closed-loop position control and OBE

Detailed information:
1987761317 Chapter 2

Control electronics analog
VT-VRPA1-527-10

Type PV2-DRV-3W

Size				6
Pressure stages			bar	75, 175, 310
Flow		$q_{V \text{ max}}$	L/min	40
Maximum hysteresis			%	< 1
Actuating time	0 to 100 %		ms	50
Comm. value signal	Standard with OBE	U	V	0 to 10
		I	mA	4 to 20

Proportional pressure reducing valves, pilot operated

- Size 10
- Porting pattern to ISO 5781-AG-06-2-A
- Proportional solenoid operation
- Series: With closed-loop position control or with closed-loop position control and OBE
- Electronics for series with closed-loop position control: Printed circuit board or integrated electronics

Type PV2-DRV-2W

Size			10
Pressure stages		bar	180, 315
Flow		$q_{V \max}$ L/min	120 to 300
Maximum hysteresis		%	1
Actuating time	0 to 100 %	ms	80
Comm. value signal	Standard with OBE	U V	0 to 10
		I mA	4 to 20



Detailed information:
1987761317 Chapter 3

Proportional throttle valves, pilot operated

- Sizes 25 to 63
- Installation dimensions to DIN ISO 7365
- 2-way version as cartridge valve
- Proportional solenoid operation
- Can be used for pressure-compensated closed-loop flow control in conjunction with a pressure compensator
- Excellent dynamics and hysteresis, leak-free isolation
- Orifice spool position is electrically closed-loop controlled
- Integral control electronics for type FESE (OBE)
- Flow characteristics optionally linear or progressive
- Flow in both directions possible



Detailed information:
RE 29209

Type FES(E)

Size				25	32	40	50	63
Operating pressure		p_{\max}	bar	315	315	315	315	315
Flow	$\Delta p = 10 \text{ bar}$	$q_{V \max}$	L/min	360	480	680	1400	1800
Maximum response sensitivity			%	0.10	0.10	0.10	0.10	0.10
Maximum range of inversion			%	0.15	0.15	0.15	0.15	0.15
Step response	0 to 100 %	$T_u + T_g$	ms	50	80	100	200	400
	100 to 0 %	$T_u + T_g$	ms	70	120	160	250	500
Operating voltage		U	V	24	24	24	24	24
Comm. value signal	With OBE	U	V	0 to 10	0 to 10	0 to 10	0 to 10	0 to 10
		I	mA	4 to 20	4 to 20	4 to 20	4 to 20	4 to 20
Control electronics		analogue		VT-VRPA1-50, VT-VRPA1-51, VT-VRPA1-52				
		digital		VT-VRPD-1				
		modular design		VT 11037				

Proportional flow control valves, direct operated, 2-way version

- Sizes 6 to 16
- Porting pattern:
 - Size 6: to DIN 24 340, form A, ISO 4401 and CETOP-RP 121 H
 - Sizes 10 and 16: to DIN 24 340, form G
- Proportional solenoid operation
- Valve with pressure compensator for pressure-compensated controlling of a flow
- Metering orifice closed-loop position controlled using an inductive position transducer
- Flow control in both directions through rectifier sandwich plate
- Operating voltage of proportional solenoids 24 V



Type 2FRE

Size			6	10	16
Operating pressure		p_{max} bar	210	315	315
Flow	$\Delta p = 8$ bar	$q_{V max}$ L/min	60	100	160
Maximum hysteresis		%	± 1	± 1	± 1
Step response	0 to 100 %	$T_u + T_g$ ms	60	90	130
	100 to 0 %	$T_u + T_g$ ms	70	100	90
Control electronics	analogue		VT 5010	VT5004	VT5004
	digital		VT-VRPD-1	VT-VRPD-1	–
	modular design		VT 11033	VT 11034	VT 11034

Detailed information:

- Size 6: RE 29188
- Sizes 10 and 16: RE 29190



Detailed information:
 – Type 4WRPH: RE 29028
 – Type 4WRPEH: RE 29035

Variant with OBE-D2 on
 inquiry

High-response valves, direct operated, with electrical position feedback

- Sizes 6 and 10
- Porting pattern to DIN 24 340, form A, ISO 4401 and CETOP-RP 121 H
- Control of the direction and magnitude of a flow
- Use for closed-loop control of position, velocity and pressure
- Actuation through control solenoid
- Position sensing of the control spool via an inductive position transducer
- Series with/without integrated electronics
- Characteristic curves with and without inflection

Types 4WRPH and 4WRPEH

Size		6		10	
Operating pressure	p_{\max} bar	315		315	
Nominal flow	($\Delta p = 70$ bar) $q_{V \text{ nom}}$ L/min	2 to 40		50 to 100	
Maximum hysteresis	%	< 0.2		< 0.2	
Frequency	at -90 ° phase response f Hz	120		60	
Operating voltage	U_{nom} V	24		24	
Comm. value signal	U V	± 10		± 10	
	I mA	4 ... 12 ... 20		4 to 20	
Control electronics	Circuit board	PL6		PL10	



Detailed information:
 – Type 5WRP: RE 29043
 – Type 5WRPE: RE 29045

High-response valves, direct operated, with electrical position feedback

- Size 10
- Porting pattern to DIN 24 340, form A, ISO 4401 and CETOP-RP 121 H
- Control of flow P – A / A – T
- Application for closed-loop velocity and pressure control
- Actuation through control solenoid
- Position sensing of the control spool via an inductive position transducer
- Series with/without integrated electronics
- Linear characteristic curve

Types 5WRP and 5WRPE

Size		10	
Operating pressure	p_{\max} bar	210	
Nominal flow	($\Delta p = 11$ bar) $q_{V \text{ nom}}$ L/min	70/70	
Maximum hysteresis	%	< 0.3	
Frequency	at -90 ° phase response f Hz	70	
Operating voltage	U_{nom} V	24	
Comm. value signal	U V	± 10	
Control electronics	Circuit board	RE 30041	

High-response valves, direct operated, with electrical position feedback

- Size 6
- Porting pattern to DIN 24 340, form A, ISO 4401 and CETOP-RP 121 H
- Control of the direction and magnitude of a flow
- Use for highly dynamic closed-loop controls
- Actuation through double-stroke control solenoid
- Position sensing of the control spool via an inductive position transducer
- Series with integrated electronics
- Characteristic curves with and without inflection



Type 4WRREH

Size				6
Operating pressure		p_{\max}	bar	315
Nominal flow	$\Delta p = 70$ bar	$q_{V \text{ nom}}$	L/min	8 to 40
Maximum hysteresis			%	< 0.2
Frequency	at -90 ° phase response	f	Hz	250
Operating voltage		U_{nom}	V	24
Comm. value signal		U	V	± 10

Detailed information:
RE 29041

High-response valves for block installation, pilot operated, with electrical position feedback

- Sizes 25 to 50
- Main stage/oil flow P – A / A – T
- Application for closed-loop velocity and pressure controls
- Actuation through pilot control valve types 4WRP(E), 4WRR(E)
- Standard characteristic curve
- Pressure gain 1%



Type 3/2V

Size				25	32	50
Operating pressure		p_{\max}	bar	315	315	315
Nominal flow	$\Delta p = 5$ bar	$q_{V \text{ nom}}$	L/min	65 to 190	380	300 to 750
Maximum hysteresis			%	0.1	0.1	0.1
Frequency ¹⁾	-90 ° phase response	f	Hz	50	45	35

Detailed information:
1987761323 Chapter 12

Control electronics VT-VRR1

¹⁾ at 100 bar

High-response valves, pilot operated, with electrical position feedback



- Sizes 10 to 35
- Porting pattern to DIN 24 340, form A, ISO 4401 and CETOP-RP 121 H
- Control of the direction and magnitude of a flow
- Use for closed-loop control of force, position, velocity and pressure
- RV-PL pilot control valve
- Pilot control valve and main stage are closed-loop position-controlled
- Modular system with different valve symbols
- Series with/without integrated electronics
- Characteristic curves with and without inflection

Types 4WRL and 4WRLE

Detailed information:
 – Type 4WRL: RE 29086
 – Type 4WRLE: RE 29088

Variant with OBE-D2 on
 inquiry

¹⁾ at 100 bar
²⁾ mounting cavity Ø50

Size			10	16	25	35 ²⁾
Operating pressure		p_{\max} bar	350	350	350	350
Nominal flow	($\Delta p = 10$ bar)	$q_{V \text{ nom}}$ L/min	55, 80	120, 200	370	1000
Maximum hysteresis ¹⁾		%	0.1	0.1	0.1	0.1
Frequency	at -90 ° phase response	f Hz	45	45	50	20
Operating voltage		U_{nom} V	24	24	24	24
Comm. value signal	standard with OBE	U V	± 10	± 10	± 10	± 10
		I mA	4 to 20	4 to 20	4 to 20	4 to 20
Control electronics		Circuit board	VT-VRRA1-527-2X			

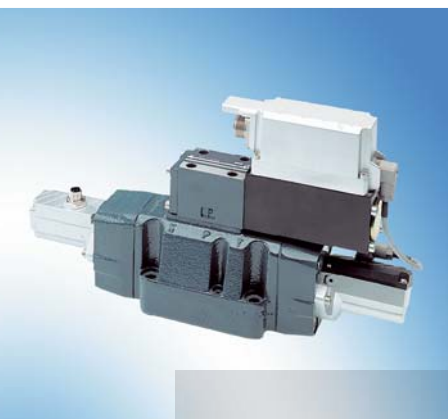

Proportional high-response valve with spool position monitoring

- Sizes 10 to 25
- Concept and design in accordance with the Machinery Directive
- Clear monitoring of all spool positions

Type 4WRLEM

Detailed information:
 1987761104

Size			10	16	25
Operating pressure	Port P, A, B	p_{\max} bar	315	350	350
	Port T	p_{\max} bar	250	250	250
Nominal flow	($\Delta p = 5$ bar)	$q_{V \text{ nom}}$ L/min	50, 80	180	350
Maximum hysteresis		%	< 0.3	< 0.3	< 0.3
Step response	0 to 100 %	$T_u + T_g$ ms	40	80	80
Operating voltage		U V	24	24	24

High-response valves, pilot operated, with electrical position feedback

- Sizes 10 to 25
- Porting pattern to DIN 24 340, form A, ISO 4401 and CETOP-RP 121 H
- Control of the direction and magnitude of a flow
- Use for closed-loop controls with high dynamics
- RV-HRV pilot control valve
- Modular system with different valve symbols
- Series with integrated electronics
- Characteristic curves with and without inflection

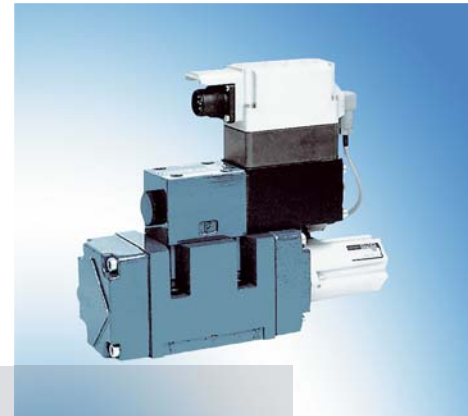

Detailed information:
RE 29077

Type 4WRVE

Size			10	16	25	
Operating pressure	p_{\max}	bar	350	350	350	
Nominal flow	($\Delta p = 10$ bar)	$q_{V \text{ nom}}$	L/min	55, 80	120, 200	370
Maximum hysteresis		%	0.1	0.1	0.1	
Frequency	at -90 ° phase response	f	Hz	100	100	55
Operating voltage	U_{nom}	V	24	24	24	
Comm. value signal	U	V	± 10	± 10	± 10	

High-response directional valves, pilot operated, with electrical position feedback

- Sizes 10 to 25
- Porting pattern to DIN 24 340, form A
- Control of the direction and magnitude of a flow
- Suitable for closed-loop controlling of force, position, velocity and pressure
- Pilot control via a 3-way high-response valve with position feedback
- Self-centering of the main stage
- Position sensing of the main spool via an inductive position transducer
- Integral control electronics

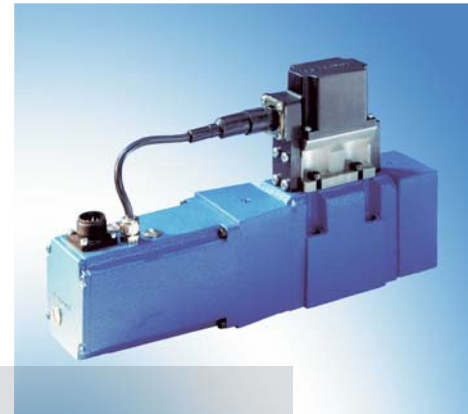

Detailed information:
RE 29070

Type 4WRGE

Size			10	16	25	
Operating pressure	p_{\max}	bar	315	350	350	
Nominal flow	($\Delta p = 10$ bar)	$q_{V \text{ nom}}$	L/min	50, 100	125, 200	250, 350
Maximum hysteresis		%	0.1	0.1	0.1	
Frequency	at -90 ° phase response	Hz	100	65	60	
Operating voltage	U	V	24	24	24	
	I	mA	3	3	3	
Comm. value signal	U	V	± 10	± 10	± 10	
	I	mA	± 10	± 10	± 10	

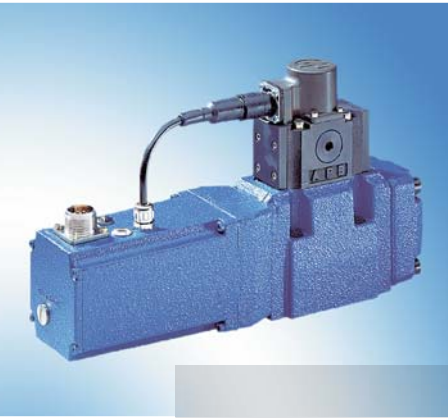

High-response directional valves, pilot operated, with electrical position feedback

- Sizes 10 to 32
- Porting pattern to DIN 24 340, form A
- Control of the direction and magnitude of a flow
- Suitable for closed-loop controlling of force, position, velocity and pressure
- Pilot control via a 2-stage servo-valve (size 6)
- Position sensing of the control spool via an inductive position transducer
- Integral control electronics

Detailed information:
RE 29093

Type 4WRDE

Size				10	16	25	27	32
Operating pressure		p_{\max}	bar	315	350	350	350	350
Nominal flow	($\Delta p = 10$ bar)	$q_{V \text{ nom}}$	L/min	50, 100	125, 200	220, 350, 500	500	600
Maximum hysteresis			%	0.2	0.2	0.2	0.2	0.2
Frequency	at -90 ° phase response		Hz	150	140	130	130	90
Operating voltage		U	V	24	24	24	24	24
Comm. value signal		U	V	± 10	± 10	± 10	± 10	± 10



Proportional cartridge valves, pilot operated, with electrical position feedback

- Sizes 32 to 50
- Installation dimensions to DIN ISO 7368 (type 2WRC(E))
- Suitable for closed-loop controlling of position, velocity and pressure
- Controlling via proportional valve
- Excellent switching times
- Robust build
- Position sensing of the control spool via an inductive position transducer
- Integral control electronics for type .WRC(E) (sizes 32 to 50)

Detailed information:
RE 29137

Types 2WRC(E) and 3WRC(E)

Size				32	40	50
Operating pressure	2-way	p_{\max}	bar	420	420	420
	3-way	p_{\max}	bar	315	315	315
Nominal flow ($\Delta p = 5$ bar)	2-way	$q_{V \text{ nom}}$	L/min	650	1000	1600
	3-way	$q_{V \text{ nom}}$	L/min	290	460	720
Maximum hysteresis			%	< 0.2	< 0.2	< 0.2
Repeatability			%	0.2	0.2	0.2
Comm. value signal	Type 2WRC(E)	U	V	0 to 10	0 to 10	0 to 10
	Type 3WRC(E)	U	V	± 10	± 10	± 10
Control electronics	Type .WRC			VT-SR31	VT-SR32	VT-SR33

Proportional cartridge valves, pilot operated, with electrical position feedback

- Sizes 32 to 160
- Installation dimensions to DIN ISO 7368 (type 2WRCE)
- Suitable for closed-loop controlling of position, velocity and pressure
- Controlling via servo-valve
- Very short switching times, low hysteresis
- Position sensing of the control spool via an inductive position transducer
- Integral control electronics for type .WRCE (sizes 32 to 100)



Types 2WRC(E) and 3WRC(E)

Size			32	40	50	63	
Operating pressure	2-way	p_{max}	bar	420	420	420	420
	3-way	p_{max}	bar	315	315	315	315
Nominal flow ($\Delta p = 5$ bar)	2-way	$q_{V\ nom}$	L/min	650	1000	1600	2800
	3-way	$q_{V\ nom}$	L/min	290	460	720	1250
Maximum hysteresis		%	< 0.2	< 0.2	< 0.2	< 0.2	
Repeatability		%	0.2	0.2	0.2	0.2	
Control electronics	Type .WRC		VT-SR31	VT-SR32	VT-SR33	VT-SR34	

Size			80	100	125	160	
Operating pressure	2-way	p_{max}	bar	420	420	420	420
	3-way	p_{max}	bar	315	315	315	315
Nominal flow ($\Delta p = 5$ bar)	2-way	$q_{V\ nom}$	L/min	4350	7200	11500	18000
	3-way	$q_{V\ nom}$	L/min	2000	3000	4500	7500
Maximum hysteresis		%	< 0.2	< 0.2	< 0.2	< 0.2	
Repeatability		%	0.2	0.2	0.2	0.2	
Control electronics	Type .WRC		VT-SR35	VT-SR36	VT-SR37	VT-SR38	

Detailed information:

- Sizes 32 to 50, series 2X:
RE 29136
- Sizes 63 to 160, series 1X:
RE 29135

2-stage directional servo-valves, mechanical and electrical feedback

- Sizes 6; 10 and 16
- Porting pattern to DIN 24 340, form A
- Control of the direction and magnitude of a flow
- Suitable for closed-loop controlling of force, position, velocity and pressure
- 1st stage nozzle/flapper plate amplifier
- Dry torque motor
- Wear-free connection of the spool with feedback element
- Position sensing of the main spool via an inductive position transducer for valves with electrical feedback (size 10)
- Integral control electronics for type 4WSE2E.

Detailed information:

- Size 6: RE 29564
- Size 10: RE 29583
- Size 16: RE 29591

- 1) 210 bar
- 2) depending on coil or feedback

Type 4WS.2E.

Size				6	10	16
Operating pressure		p_{\max}	bar	315	315	315
Nominal flow	($\Delta p = 70$ bar)	$q_{V \text{ nom}}$	L/min	2, 5, 10, 15, 20	20, 30, 45, 60, 75, 90	100, 150, 200
Maximum hysteresis			%	1.5 ¹⁾	1.5	1.5
Corner frequency	-90 ° (± 25 %; 315 bar)		Hz	250	180	75
Operating voltage	Type 4WS2E.	U	V	± 15	± 15	± 15
Comm. value signal	Type 4WSE2E.	U	V	± 10	± 10	± 10
		I	mA	± 10	± 10	± 10
Control electronics ²⁾	Type 4WS2E.	analogue		VT-SR2	VT-SR2	VT-SR2
		modular design		VT 11021	VT 11021	

3-stage directional servo-valves, electrical feedback

- Sizes 16 to 32
- Porting pattern to DIN 24 340, form A
- Control of the direction and magnitude of a flow
- Suitable for closed-loop controlling of force, position, velocity and pressure
- High response sensitivity, very low hysteresis and zero point drift
- Position sensing of the main spool via an inductive position transducer
- Integral control electronics

Type 4WSE3EE

Detailed information:
RE 29595

Size				16	25	32
Operating pressure		p_{\max}	bar	315	315	315
Nominal flow	($\Delta p = 70$ bar)	$q_{V \text{ nom}}$	L/min	100, 150, 200, 300	300, 400, 500	500, 700, 1000
Maximum hysteresis			%	0.2	0.2	0.2
Corner frequency	-90 ° (± 25 %; 315 bar)		Hz	250	180	75
Operating voltage		U	V	± 15	± 15	± 15
Comm. value signal		U	V	± 10	± 10	± 10
		I	mA	± 10	± 10	± 10